



**DODGE**

# **POWER WAGON**

**2007 POWER WAGON**



**2007 OWNER'S MANUAL**

# TABLE OF CONTENTS

## SECTION

## PAGE

1	INTRODUCTION .....	3	1
2	THINGS TO KNOW BEFORE STARTING YOUR VEHICLE .....	9	2
3	UNDERSTANDING THE FEATURES OF YOUR VEHICLE .....	73	3
4	UNDERSTANDING YOUR INSTRUMENT PANEL .....	167	4
5	STARTING AND OPERATING .....	241	5
6	WHAT TO DO IN EMERGENCIES .....	365	6
7	MAINTAINING YOUR VEHICLE .....	381	7
8	MAINTENANCE SCHEDULES .....	445	8
9	IF YOU NEED CONSUMER ASSISTANCE .....	465	9
10	INDEX .....	473	10



---

# INTRODUCTION

## CONTENTS

---

■ Introduction . . . . .	4	■ Van Conversions/Campers . . . . .	6
■ How To Use This Manual . . . . .	4	■ Vehicle Identification Number . . . . .	6
■ Warnings And Cautions . . . . .	6	■ Vehicle Modifications / Alterations . . . . .	7

## INTRODUCTION

This manual has been prepared with the assistance of service and engineering specialists to acquaint you with the operation and maintenance of your new vehicle. It is supplemented by a Warranty Information Booklet and various customer oriented documents. You are urged to read these publications carefully. Following the instructions and recommendations in this manual will help assure safe and enjoyable operation of your vehicle.

**NOTE:** After you read the manual, it should be stored in the vehicle for convenient reference and remain with the vehicle when sold, so that the new owner will be aware of all safety warnings.

When it comes to service, remember that your dealer knows your vehicle best, has the factory-trained technicians and genuine Mopar® parts, and is interested in your satisfaction.

## WARNING!











**Engine exhaust, some of its constituents, and certain vehicle components contain or emit chemicals known to the State of California to cause cancer and birth defects or other reproductive harm. In addition, certain fluids contained in vehicles and certain products of component wear contain or emit chemicals known to the State of California to cause cancer and birth defects or other reproductive harm.**

## HOW TO USE THIS MANUAL

Consult the table of contents to determine which section contains the information you desire.

The detailed index, at the rear of this manual, contains a complete listing of all subjects.

Consult the following table for a description of the symbols that may be used on your vehicle or throughout this owner's manual:

										<b>AWD!</b> ALL WHEEL DRIVE
FUEL	REAR WINDOW INTERMITTENT WIPER	WINDSHIELD WASHER	FAILURE OF ANTI-LOCK BRAKING SYSTEM	LOW BEAM	KEY ACTIVATE (POWER OUTLET)	UPPER AND LOWER AIR OUTLET	HEATED SEAT HIGH	WINDOW LIFT	TIRE PRESSURE MONITOR	ELECTRONIC THROTTLE CONTROL
FUEL FILL SIDE	REAR WINDOW WASHER	WINDSHIELD WASHER FLUID LEVEL	SEAT BELT	FRONT FOG LIGHT	HOOD RELEASE	LOWER AIR OUTLET	RECIRCULATION	CONVERTIBLE 4 WINDOW DOWN	VOICE RECOGNITION BUTTON	TRANS OIL TEMP
ENGINE OIL	REAR WINDOW DEFROST	WINDSHIELD, ELECTRICALLY HEATED	AIRBAG	EXTERIOR BULB FAILURE	LIFTGATE RELEASE AND LIFTGATE OPEN	DEFROST AND LOWER AIR OUTLET	VENTILATING FAN	POWER STEERING FLUID	UCONNECT™ BUTTON	
BATTERY CHARGING	HEATED MIRROR	WINDSHIELD DEFROST	SIDE AIRBAG	DOME LIGHT	SLIDING DOOR	TRUNK / DECK RELEASE	AIR CONDITIONING	SEE OWNER'S MANUAL ISO	TRACTION CONTROL	
ENGINE COOLANT TEMPERATURE	CHILD SEAT TETHER ANCHOR	WINDSHIELD WIPER AND WASHER	HAZARD	PARK LIGHTS	SLIDING DOOR	CONVERTIBLE TOP UP	EMERGENCY RELEASE HANDLE	INSTRUMENT PANEL ILLUMINATION	WARNING	
MALFUNCTION INDICATOR LIGHT	LOWER ANCHORS AND TETHER FOR CHILDREN (LATCH)	<b>SRS AIRBAG</b> SUPPLEMENTAL RESTRAINT SYSTEM	WINDOW LOCK	LIGHTER	DOOR AJAR	CONVERTIBLE TOP DOWN	PASSENGER AIRBAG OFF	MASTER LIGHTING SWITCH	<b>ESP BAS</b> ELECTRONIC STABILITY PROGRAM / BRAKE ASSIST SYSTEM	8160dc08

### **WARNINGS AND CAUTIONS**

This manual contains **WARNINGS** against operating procedures which could result in an accident or bodily injury. It also contains **CAUTIONS** against procedures which could result in damage to your vehicle. If you do not read this entire manual you may miss important information. Observe all Warnings and Cautions.

### **VAN CONVERSIONS/CAMPERS**

The Manufacturer's Warranty does not apply to body modifications or special equipment installed by van conversion/camper manufacturers/ body builders. See the Warranty information book, Section 2.1.C. Such equipment includes video monitors, VCRs, heaters, stoves, refrigerators, etc. For warranty coverage and service on these items, contact the applicable manufacturer.

Operating instructions for the special equipment installed by the conversion/camper manufacturer should also be supplied with your vehicle. If these instructions are missing, please contact your selling dealer for assistance in obtaining replacement documents from the applicable manufacturer.

### **VEHICLE IDENTIFICATION NUMBER**

The vehicle identification number (VIN) is found on the left front corner of the instrument panel, visible through the windshield. This number also appears on the Automobile Information Disclosure Label affixed to a window on your vehicle, the vehicle registration and title.

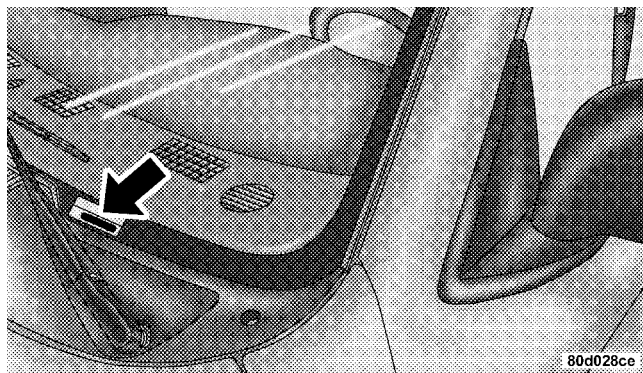

### Vehicle Identification Number

**NOTE:** It is illegal to remove the VIN.

## VEHICLE MODIFICATIONS / ALTERATIONS

### WARNING!

Any modifications or alterations to this vehicle could seriously affect its roadworthiness and safety and may lead to an accident resulting in serious injury or death.





# THINGS TO KNOW BEFORE STARTING YOUR VEHICLE

## CONTENTS

---

■ Power Wagon: Things To Know Before Starting Your Vehicle . . . . .	12
□ Features . . . . .	12
□ Instrument Panel And Controls . . . . .	12
□ Operation . . . . .	12
□ Emergencies . . . . .	12
■ A Word About Your Keys . . . . .	12
□ Ignition Key Removal . . . . .	13
□ Locking Doors With The Key . . . . .	15
■ Steering Wheel Lock — If Equipped . . . . .	15
□ If You Wish To Manually Lock The Steering Wheel . . . . .	15
□ To Release The Steering Wheel Lock . . . . .	15
□ Automatic Transmission Ignition Interlock System . . . . .	16
■ Sentry Key — If Equipped . . . . .	16
□ Replacement Keys . . . . .	17
□ Customer Key Programming . . . . .	17
□ General Information . . . . .	18

## 10 THINGS TO KNOW BEFORE STARTING YOUR VEHICLE

- Security Alarm System — If Equipped . . . . .18
  - Rearming Of The System . . . . .19
  - To Set The Alarm . . . . .19
  - To Disarm The System . . . . .19
- Illuminated Entry System — If Equipped . . . . .20
- Remote Keyless Entry — If Equipped . . . . .20
  - To Unlock The Doors . . . . .21
  - To Lock The Doors . . . . .21
  - Using The Panic Alarm . . . . .22
  - General Information . . . . .23
  - Transmitter Battery Service . . . . .23
- Remote Starting System — Gas Engine Only . . . .24
- Door Locks . . . . .26
  - Manual Door Locks . . . . .26
  - Power Door Locks — If Equipped . . . . .26
  - Child Protection Door Lock . . . . .29
- Windows . . . . .31
  - Power Windows—If Equipped . . . . .31
  - Wind Buffeting . . . . .32
- Occupant Restraints . . . . .33
  - Lap/Shoulder Belts . . . . .34
  - Adjustable Upper Shoulder Belt Anchorage . . . .41
  - Automatic Locking Restraint (ALR) Mode – If Equipped . . . . .42
  - Center Lap Belts . . . . .42
  - Seat Belt Pretensioners . . . . .43

**THINGS TO KNOW BEFORE STARTING YOUR VEHICLE 11**

- Enhanced Driver Seat Belt Reminder System (BeltAlert) . . . . .43
- Seat Belts And Pregnant Women . . . . .45
- Seat Belt Extender . . . . .45
- Driver And Right Front Passenger Supplemental Restraint System (SRS)—Airbag . . . . .45

- Event Data Recorder (EDR) . . . . .56
- Child Restraint . . . . .58
- Engine Break-In Recommendations . . . . .70

## **POWER WAGON: THINGS TO KNOW BEFORE STARTING YOUR VEHICLE**

Your Power Wagon is a specialty vehicle, equipped with several features not available on other production trucks. It is very important that you read the following sections of the owner's manual before operation.

### **Features**

(See page 78 for more information.)

### **Instrument Panel and Controls**

(See page 171 for more information.)

### **Operation**

(See page 264 for more information.)

### **Emergencies**

(See page 366 for more information.)

## **A WORD ABOUT YOUR KEYS**

The dealer that sold you your new vehicle has the key code numbers for your vehicle locks. These numbers can be used to order duplicate keys from your dealer. Ask your dealer for these numbers and keep them in a safe place.

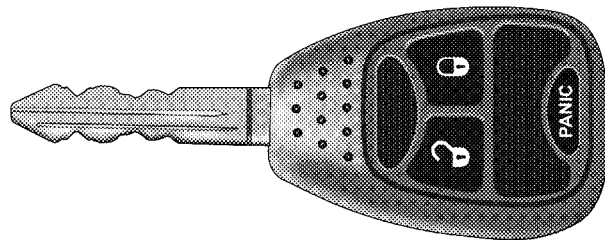

8163e6a8

**Ignition Key**

## Ignition Key Removal

### Automatic Transmission

Place the shift lever in PARK. Turn the ignition switch to the LOCK position, and remove the key.

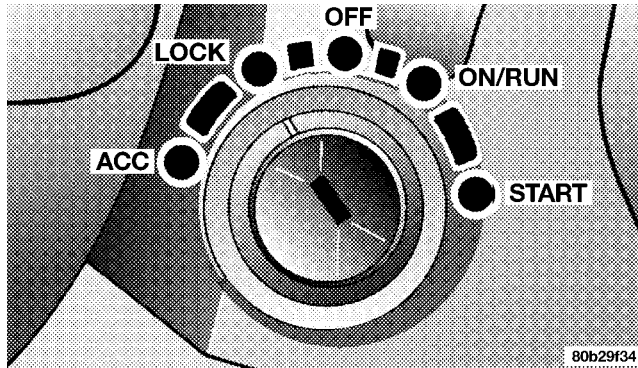

Ignition Switch Positions

**NOTE:** If you try to remove the key before you place the lever in PARK, the key may become trapped temporarily in the ignition cylinder. If this occurs, rotate the key to the right slightly, then remove the key as described. If a malfunction occurs, the system will trap the key in the ignition cylinder to warn you that this safety feature is inoperable. The engine can be started and stopped but the key cannot be removed until you obtain service.

**NOTE:** The power window switches, radio, power sunroof (if equipped), and power outlets will remain active for 10 minutes after the ignition switch is turned off. Opening either front door will cancel this feature.

**WARNING!**

**Never leave children alone in a vehicle. Leaving children in a vehicle unattended is dangerous for a number of reasons. A child or others could be seriously or fatally injured. Don't leave the keys in the ignition. A child could operate power windows, other controls, or move the vehicle.**

**CAUTION!**

**An unlocked car is an invitation to thieves. Always remove key from the ignition and lock all doors when leaving the vehicle unattended.**

**Manual Transmission—If Equipped**

When the steering wheel is in the LOCK position, the steering and ignition systems are locked to provide antitheft protection for your vehicle. It may be difficult to turn the key from the LOCK position when starting your vehicle. Move the steering wheel left and right while turning the key until it turns easily. To remove the key, depress and hold the release button located between the ignition switch and the instrument panel. Turn the ignition key to LOCK and remove the key.

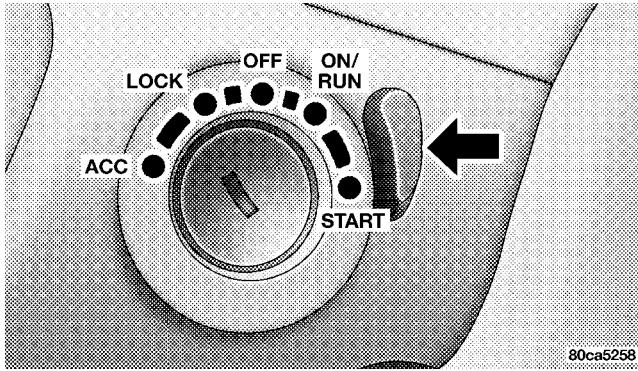

**Ignition Switch Positions**

### **Locking Doors With The Key**

You can insert the key with either side up. To lock the door, turn the key rearward, to unlock the door, turn the key forward. See Section 7 of this manual for door lock lubrication.

### **STEERING WHEEL LOCK — IF EQUIPPED**

Your vehicle may be equipped with a passive steering wheel lock. This lock prevents steering the vehicle without the ignition key. If the steering wheel is moved no more than 1/2 turn in either direction and the key is not in the ignition switch, the steering wheel will lock.

#### **If You Wish To Manually Lock The Steering Wheel:**

With the engine running, turn the steering wheel upside down, turn off the engine and remove the key. Turn the steering wheel slightly in either direction until the lock engages.

#### **To Release The Steering Wheel Lock:**

Insert the key in the ignition switch and start the engine. If the key is difficult to turn, move the wheel slightly to the right or left to disengage the lock.



**NOTE:** If you turned the wheel to the right to engage the lock, you must turn the wheel slightly to the right to disengage it. If you turned the wheel to the left to engage the lock, turn the wheel slightly to the left to disengage it.

### **Automatic Transmission Ignition Interlock System**

This system prevents the key from being removed unless the shift lever is in PARK. It also prevents shifting out of PARK unless the key is in the ON positions, and the brake pedal is depressed.

### **SENTRY KEY — IF EQUIPPED**

The Sentry Key Immobilizer System prevents unauthorized vehicle operation by disabling the engine. The system does not need to be armed or activated. Operation is automatic, regardless of whether the vehicle is locked or unlocked.

The system uses ignition keys, which have an embedded electronic chip (transponder), to prevent unauthorized

vehicle operation. Therefore, only keys that are programmed to the vehicle can be used to start and operate the vehicle. The system will shut the engine off in two (2) seconds if someone uses an invalid key to start the engine.

**NOTE:** A key, which has not been programmed, is also considered an invalid key even if it is cut to fit the ignition lock cylinder for that vehicle.

During normal operation, after turning on the ignition switch, the Vehicle Security Alarm Indicator Light will turn on for three (3) seconds for a bulb check. If the light remains on after the bulb check, it indicates that there is a problem with the electronics. In addition, if the light begins to flash after the bulb check, it indicates that someone used an invalid key to start the engine. Either of these conditions will result in the engine being shut off after two (2) seconds.

If the Vehicle Security Alarm Indicator Light turns on during normal vehicle operation (vehicle running for longer than 10 seconds), it indicates that there is a fault in the electronics. Should this occur, have the vehicle serviced as soon as possible.

### Replacement Keys

**NOTE:** Only keys that have been programmed to the vehicle electronics can be used to start the vehicle. Once a Sentry Key has been programmed to a vehicle, it cannot be programmed to any other vehicle.

At the time of purchase, the original owner is provided with a four digit PIN. This number is required for dealer replacement of keys. Duplication of keys may be performed at an authorized dealer or by using the Customer Key Programming procedure. This procedure consists of programming a blank key to the vehicle electronics. A blank key is one which has never been programmed and needs to be cut.

**NOTE:** When having the Sentry Key System serviced, bring all vehicle keys to the dealer.

### Customer Key Programming

You can program new keys to the system if you have two valid keys by doing the following:

1. Cut the additional Sentry Key Transponder blank(s) to match the ignition switch lock cylinder key code.
2. Insert the first valid key into the ignition switch and turn the ignition switch ON for at least 3 seconds but no longer than 15 seconds. Turn the ignition switch OFF and remove the first key.
3. Insert the second valid key and turn the ignition switch ON within 15 seconds. After ten seconds a chime will sound and the Vehicle Theft Alarm Indicator Light will begin to flash. Turn the ignition switch OFF and remove the second key.

4. Insert a blank Sentry Key into the ignition switch and turn the ignition switch ON within 60 seconds. After 10 seconds a single chime will sound and the Vehicle Theft Alarm Indicator Light will stop flashing, turn on again for 3 seconds, and then turn off.

The new Sentry Key has been programmed. **The Keyless Entry Transmitter will also be programmed during this procedure.** Repeat this procedure to program up to a total of 8 keys. If you do not have a programmed sentry key, contact your dealer for details.

**NOTE:** If a programmed key is lost, see your dealer to have all remaining keys erased from the systems memory. This will prevent the lost key from starting your vehicle. The remaining keys must then be reprogrammed. All vehicle keys must be taken to the dealer at the time of service to be reprogrammed.

### General Information

The Sentry Key system complies with FCC rules part 15 and with RSS-210 of Industry Canada. Operation is subject to the following conditions:

- This device may not cause harmful interference.
- This device must accept any interference that may be received, including interference that may cause undesired operation.

### SECURITY ALARM SYSTEM — IF EQUIPPED

This system monitors the vehicle doors and ignition for unauthorized operation. When the alarm is activated, the system provides both audible and visual signals. For the first 3 minutes the horn will sound and the headlights and security telltale will flash repeatedly. For an additional 15 minutes only the headlights and security telltale will flash. The engine will run only if a valid Sentry Key is used to start the vehicle. Use of the Sentry Key will disable the alarm.

**Rearming of the System:**

The security system will rearm itself after the 15 additional minutes of headlights and security telltale flashing, if the system has not been disabled. If the condition which initiated the alarm is still present, the system will ignore that condition and monitor the remaining doors and ignition.

**To Set the Alarm:**

The alarm will set when you use the power door locks, or use the Keyless Entry transmitter to lock the doors. After all the doors are locked and closed the SECURITY light in the instrument cluster will flash rapidly to signal that the system is arming. The security light in the instrument panel cluster will flash rapidly for about 16 seconds to indicate that the alarm is being set. After the alarm is set, the security light will flash at a slower rate to indicate that the system is armed.

**NOTE:** If the SECURITY light stays on continuously during vehicle operation, have the system checked by your dealer.

**To Disarm the System:**

Use the Keyless Entry transmitter to unlock the door. If something has triggered the system in your absence, the horn will sound three times when you unlock the doors and the security lamp will flash for 30 seconds. Check the vehicle for tampering.

The Security system will also disarm, if the vehicle is started with a programmed Sentry Key. If an unprogrammed Sentry Key is used to start a vehicle, the engine will run for 2 seconds and then the security alarm will be initiated. To exit alarming mode, press the transmitter Unlock button, or start the vehicle with a programmed Sentry Key.

## 20 THINGS TO KNOW BEFORE STARTING YOUR VEHICLE

The Security Alarm System is designed to protect your vehicle; however, you can create conditions where the system will arm unexpectedly. If you remain in the vehicle and lock the doors with the transmitter, the alarm will sound when you pull the door handle to exit. The door will be locked but the Security Alarm will not arm.

### ILLUMINATED ENTRY SYSTEM — IF EQUIPPED

The courtesy lights will turn on when you use the keyless entry transmitter or open the doors. This feature is only available if you have Remote Keyless Entry.

The lights will fade to off after about 30 seconds or they will immediately fade to off once the ignition switch is turned on.

#### NOTE:

- The front courtesy overhead console, door courtesy lights do not turn on if the dimmer control is in the interior lights ON position (extreme top position).

- The illuminated entry system will not operate if the dimmer control is in the “defeat” position (extreme downward position).

### REMOTE KEYLESS ENTRY — IF EQUIPPED

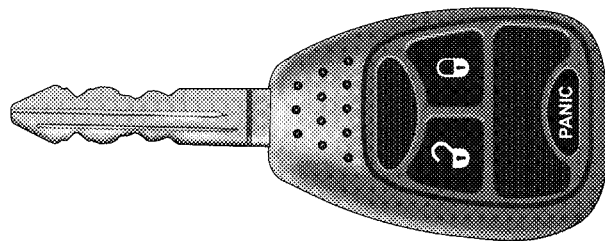

8163e6a8

#### Three Button Transmitter

This system allows you to lock or unlock the doors from distances up to about 23 feet (7 meters) using a hand held

radio transmitter. The transmitter need not be pointed at the vehicle to activate the system.

**To unlock the doors:**

Press and release the UNLOCK button on the key fob once to unlock only the driver's door or twice to unlock all the doors. When the UNLOCK button is pressed, the illuminated entry will initiate, the parking lights will flash on twice and if installed, the cargo lamp will turn on for 30 seconds.

The system can be programmed to unlock all the doors or drivers door only upon the first UNLOCK button press by using the following procedure:

1. Perform this operation while standing outside the vehicle.
2. Press and hold the LOCK button on your key fob.

3. Continue to hold the LOCK button at least 4 seconds, but no longer than 10 seconds, then press and hold the UNLOCK button while still holding the LOCK button.

4. Release both buttons at the same time.

5. This will allow you to unlock all doors on the first press of the UNLOCK button.

**To lock the doors:**

Press and release the LOCK button on the transmitter to lock all doors. If the ignition is OFF, when the doors are locked, the parking lights will flash on once and the horn will chirp once.

The horn chirp feature will be shipped from the assembly plants activated. If desired this feature can be disabled by using the following procedure:

1. Perform this operation while standing outside the vehicle.

## 22 THINGS TO KNOW BEFORE STARTING YOUR VEHICLE

2. Press and hold the LOCK button on a programmed (i.e. functional) key fob.
3. Continue to hold the LOCK button, wait at least 4 seconds, but no longer than 10 seconds, then press and hold the PANIC button. Release both buttons at the same time.
4. To reactivate this feature, repeat the above steps.

Vehicles will be shipped from the assembly plants with the park lamp flash feature activated. If desired, this feature can be disabled by using the following procedure:

1. Perform this operation while standing outside the vehicle.
2. Press and hold the UNLOCK button on a programmed (i.e. functional) key fob.

3. Continue to hold the UNLOCK button, wait at least 4 seconds, but no longer than 10 seconds, then press and hold the LOCK button. Release both buttons at the same time.

4. To reactivate this feature, repeat the above steps.

### **Using the Panic Alarm**

To activate the Panic mode while the ignition is OFF press and release the PANIC button on the transmitter once. When the Panic mode is activated, the interior lights will illuminate, the headlamps and parking lights will flash, and the horn will sound.

To cancel the Panic mode press and release the PANIC button on the transmitter a second time. Panic mode will automatically cancel after 3 minutes or if the vehicle is started and exceeds 15 mph. During the Panic Mode, the door locks and remote keyless entry systems will function normally. Panic mode will not disarm the security system on vehicles so equipped.

### General Information

This device complies with part 15 of FCC rules and with RS-210 of Industry Canada. Operation is subject to the following conditions:

1. This device may not cause harmful interference.
2. This device must accept any interference that may be received including interference that may cause undesired operation.

**NOTE:** Changes or modifications not expressly approved by the party responsible for compliance could void the user's authority to operate the equipment.

If your Keyless Entry Transmitter fails to operate from a normal distance, check for these two conditions.

1. Weak batteries in transmitter. The expected life of the batteries is from one to two years.

2. Closeness to a radio transmitter such as a radio station tower, airport transmitter, and some mobile or CB radios.

### Transmitter Battery Service

2

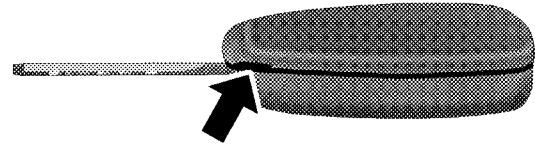

81182c72

### Transmitter Battery Replacement

The recommended replacement battery is a 3V lithium 2016 cell. This transmitter requires two batteries.



**NOTE:** Do not touch the battery terminals that are on the back housing or the printed circuit board.

1. With transmitter buttons facing down, use a flat blade or dime to pry the two halves of the transmitter apart. Make sure not to damage the rubber gasket during removal.
2. Remove and replace the batteries. Be careful not to disturb the metal terminal near the batteries. Install the batteries with the positive terminal up, reference the note "+ SIDE UP" on the inside of the bottom half of the transmitter case. Avoid touching the new batteries with your fingers. Skin oils may cause battery deterioration. If you touch a battery, clean it with rubbing alcohol.
3. To reassemble the transmitter case snap the two halves together. Make sure there is an even gap between the two halves. Test transmitter operation.

## **REMOTE STARTING SYSTEM — GAS ENGINE ONLY**

Your vehicle may be equipped with a remote starting system, which will allow the vehicle to be started from distances up to approximately 300 feet away from the vehicle using the remote keyless entry key fob which is part of your ignition key.

In order to remote start your vehicle, the hood, and all the doors must be closed.

To remote start your vehicle, press the REMOTE START button on the key fob twice within three seconds. To indicate that the vehicle is about to start, the parking lights will flash and the horn will sound briefly.

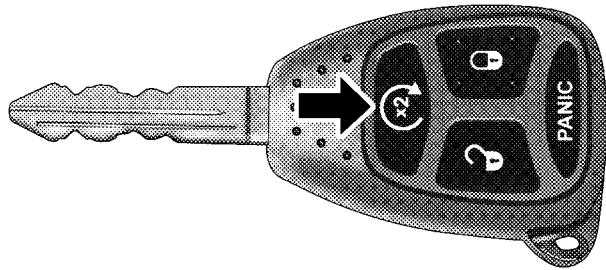

81931ecc

### Remote Start Transmitter

Once the vehicle has started, the engine will run for 15 minutes. To cancel remote start, press the REMOTE START button once.

To enter the vehicle while the engine is running during a remote start, you must first unlock the vehicle using the UNLOCK button on the key fob. After the vehicle is

unlocked, you have 60 seconds to enter the vehicle, insert the key in the Ignition and move it to the RUN position, otherwise the engine will cancel remote start and automatically turn off.

Remote start will also cancel if any of the following occur:

- If the engine stalls or RPM exceeds 2500
- Any engine warning lamps come on
- The hood is opened
- The hazard switch is pressed
- The transmission is moved out of park
- The brake pedal is pressed.

The vehicle can be started remotely up to a maximum of two times. The vehicle is also allowed a maximum of one failed start, where the remote start sequence was initiated but cancelled before the engine begins to crank. After

either of these conditions, or if the Vehicle Theft Alarm is alarming, or if the PANIC button was pressed, the vehicle must be reset by inserting a valid key into the ignition and moving it to the RUN position, then back to LOCK.

The parking lamps will remain illuminated to indicate that the vehicle has remote started and the engine is running. The lamps will turn off when the ignition is turned to RUN or the remote start is cancelled.

## DOOR LOCKS

### Manual Door Locks

Front and Rear doors may be locked, by moving the lock plunger up or down.

All doors may be opened with the inside door handle without lifting the lock plunger. Doors locked before closing will remain locked when closed.

The ignition key will unlock all the locks on your vehicle.

## WARNING!

- **For personal security and safety in the event of an accident, lock the vehicle doors when you drive as well as when you park and leave the vehicle.**
- **Never leave children alone in a vehicle. Leaving children in a vehicle unattended is dangerous for a number of reasons. A child or others could be seriously or fatally injured. Don't leave the keys in the ignition. A child could operate power windows, other controls, or move the vehicle.**

### Power Door Locks — If Equipped

A power door lock switch is on each front door trim panel. Use this switch to lock or unlock the doors.

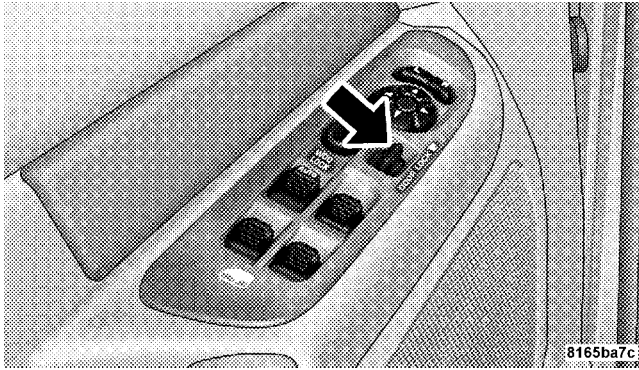

### Power Door Lock Switch Location

If you press the power door lock switch while the key is in the ignition, and any front door is open, the power locks will not operate. This prevents you from accidentally locking your keys in the vehicle. Removing the key or closing the door will allow the locks to operate. A

chime will sound if the key is in the ignition switch and a door is open, as a reminder to remove the key.

### Automatic Door Locks – If Equipped

If this feature is enabled, your door locks will lock automatically when the vehicle's speed exceeds 15 mph.

### Automatic Door Lock Programming

This feature is enabled when your vehicle is shipped from the assembly plant and can be disabled by using the following procedure:

1. Enter your vehicle and close all doors.
2. Fasten your seat belt (Fastening the seat belt will cancel any chiming that may confuse you during this programming procedure).
3. Place the key into the ignition.

4. Within 15 seconds cycle the key from the LOCK position to the ON/RUN position a minimum of four times; ending in the LOCK position (**do not start the engine**).
5. Within 30 seconds, press the driver's door lock switch in the LOCK direction.
6. A single chime will be heard to indicate the feature has been disabled.
7. To reactivate this feature, repeat the above steps.
8. If a chime is not heard, program mode was canceled before the feature could be disabled. If necessary, repeat the above procedure.

#### **Auto Unlock On Exit — If Equipped**

This feature unlocks all of the doors of the vehicle when any door is opened. This will occur only after the vehicle has been shifted into the Park position after the vehicle has been driven (shifted out of Park and all doors closed).

This feature will not operate if there is any manual operation of the power door locks (Lock or Unlock).

**Auto Unlock On Exit Programming — If Equipped**  
Customer Programming sequence to enable or disable the Auto Unlock Feature:

1. Enter your vehicle and close all doors.
2. Fasten your seat belt (fastening the seat belt will cancel any chimes that may be confusing during this programming procedure).
3. Insert the key into the ignition.
4. Within 15 seconds, cycle the key from the LOCK position to the ON/RUN position a minimum of four times ending in the LOCK position (**do not start the engine**).
5. Within 30 seconds, press the driver's door lock switch in the UNLOCK direction.

6. A single chime will sound to indicate the feature has been changed.
7. Repeat the above steps to alternate the availability of this feature.
8. If a chime is not heard, program mode was canceled before the feature could be changed. If necessary repeat the above procedure.

### **Child Protection Door Lock**

To provide a safer environment for children riding in the rear seat, the rear doors of your vehicle have the child-protection door lock system.

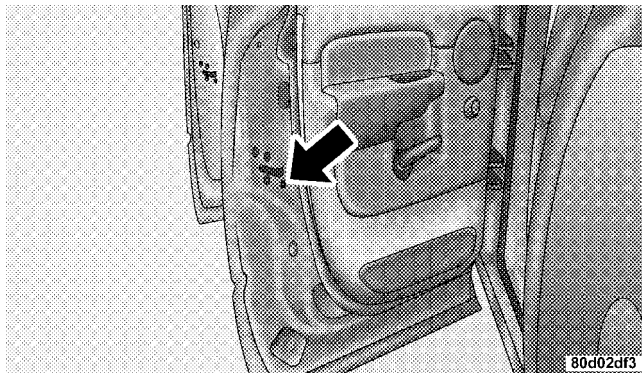

2

### **Child Protection Door Lock Location**

To use the system, open each rear door, insert the tip of the ignition key or a similar object into the lock control lever, slide the lever UP to engage the locks and DOWN to disengage the child-protection locks. When the system

## 30 THINGS TO KNOW BEFORE STARTING YOUR VEHICLE

on a door is engaged, that door can only be opened by using the outside door handle even if the inside door lock is in the unlocked position.

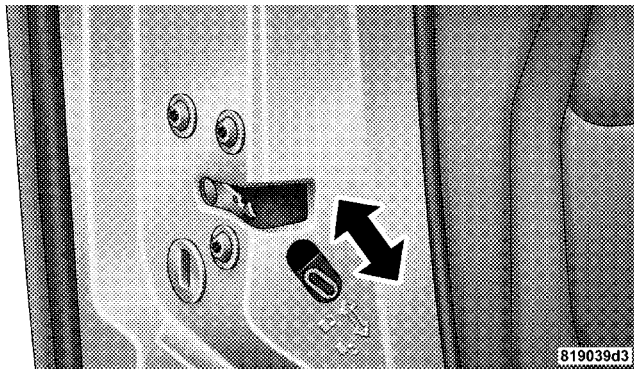

**Child Lock Control**

### **WARNING!**

**Avoid trapping anyone in a vehicle in a collision. Remember that the rear doors can only be opened from the outside when the child protection locks are engaged.**

**NOTE:** After setting the child protection door lock system, always test the door from the inside to make certain it is in the desired position.

**NOTE:** For emergency exit with the system engaged, move the door lock switch to the UNLOCK position, roll down the window and open the door with the outside door handle.

## WINDOWS

### Power Windows—If Equipped

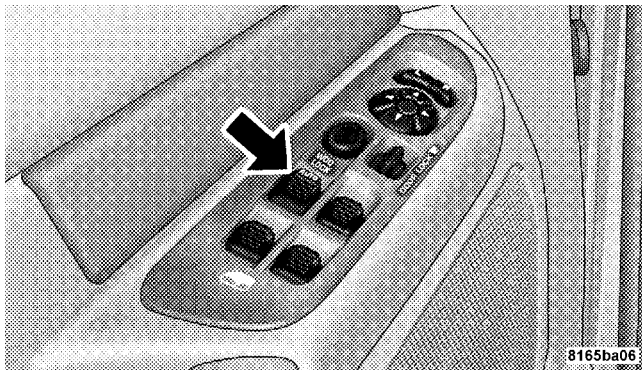

#### Power Window Switches

The control on the left front door panel has up-down switches that give you fingertip control of all power windows. There is a single opening and closing switch on the front passenger door for passenger window control

and on the rear doors of Quad Cab and Mega Cab models. The windows will operate when the ignition switch is turned to the ON or ACC (Accessory) position and for ten minutes after the ignition is turned off or the driver's door is opened.

**NOTE:** The Power Accessory Delay feature will allow the power windows to operate for ten minutes after the ignition is turned off.

### WARNING!

**Never leave children alone in a vehicle. Leaving children in a vehicle unattended is dangerous for a number of reasons. A child or others could be seriously or fatally injured. Don't leave the keys in the ignition. A child could operate power windows, other controls, or move the vehicle.**



### **Auto Down (Driver's Side Only)**

The driver's window switch has an Auto Down feature. Press the window switch past the detent, release, and the window will go down automatically.

### **Window Lockout Switch (4 Door Models Only)**

The window lockout switch on the driver's door allows you to disable the window control on the other doors. To disable the window controls on the other doors, press the window lock button. To enable the window controls, press the window control button again.

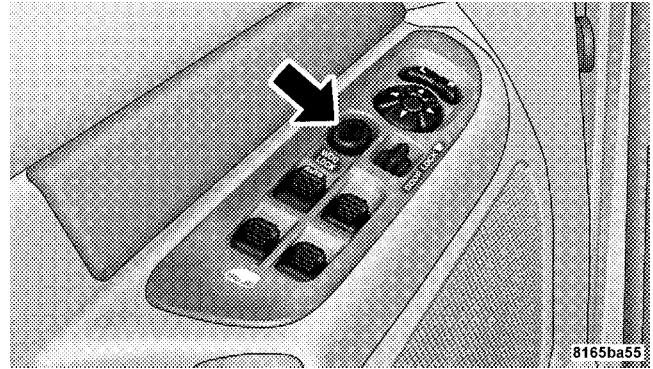

**Window Lockout Switch**

### **Wind Buffeting**

Wind buffeting can be described as the perception of pressure on the ears or a helicopter type sound in the ears. Your vehicle may exhibit wind buffeting with the windows down or partially open positions. This is a normal occurrence and can be minimized. If the buffeting

occurs with the rear windows open, open the front and rear windows together to minimize the buffeting.

### **OCCUPANT RESTRAINTS**

Some of the most important safety features in your vehicle are the restraint systems. These include the front and rear seat belts for the driver and all passengers, front airbags for both the driver and front passenger and, if so equipped, window bags for the driver and passengers seated next to a window. If you will be carrying children too small for adult-size belts, your seat belts also can be used to hold infant and child restraint systems.

Please pay close attention to the information in this section. It tells you how to use your restraint system properly to keep you and your passengers as safe as possible.

### **WARNING!**

**In a collision, you and your passengers can suffer much greater injuries if you are not properly buckled up. You can strike the interior of your vehicle or other passengers, or you can be thrown out of the vehicle. Always be sure you and others in your vehicle are buckled up properly.**

Buckle up even though you are an excellent driver, even on short trips. Someone on the road may be a poor driver and cause a collision that includes you. This can happen far away from home or on your own street.

Research has shown that seat belts save lives, and that they can reduce the seriousness of injuries in a collision. Some of the worst injuries happen when people are thrown from the vehicle. Seat belts reduce the possibility

of ejection and the risk of injury caused by striking the inside of the vehicle. **Everyone** in a motor vehicle should be belted at all times.

### **Lap/Shoulder Belts**

All seating positions except the Quad Cab front center seating position have combination lap/shoulder belts. The belt webbing retractor is designed to lock during very sudden stops or collisions. This feature allows the shoulder part of the belt to move freely with you under normal conditions. But in a collision, the belt will lock and reduce the risk of your striking the inside of the vehicle or being thrown out.

### **WARNING!**

**It is extremely dangerous to ride in a cargo area, inside or outside of a vehicle. In a collision, people riding in these areas are more likely to be seriously injured or killed.**

**Do not allow people to ride in any area of your vehicle that is not equipped with seats and seat belts.**

**Be sure everyone in your vehicle is in a seat and using a seat belt properly.**

**WARNING!**

- **Wearing a seat belt incorrectly is dangerous.** Seat belts are designed to go around the large bones of your body. These are the strongest parts of your body and can take the forces of a collision the best. Wearing your belt in the wrong place could make your injuries in a collision much worse. You might suffer internal injuries, or you could even slide out of part of the belt. Follow these instructions to wear your seat belt safely and to keep your passengers safe, too.
- **Two people should never be belted into a single seat belt.** People belted together can crash into one another in an accident, hurting one another badly. Never use a lap/shoulder belt or a lap belt for more than one person, no matter what their size.

**Lap/Shoulder Belt Operating Instructions**

1. Enter the vehicle and close the door. Sit back and adjust the seat.

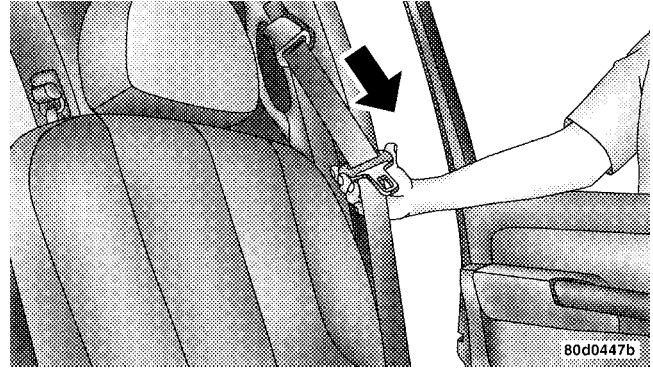
**Latch Plate**

2. The seat belt latch plate is above the back of the front seat, next to your arm in the rear seat. Grasp the latch

plate and pull out the belt. Slide the latch plate up the webbing as far as necessary to allow the belt to go around your lap.

3. When the belt is long enough to fit, insert the latch plate into the buckle until you hear a “click.”

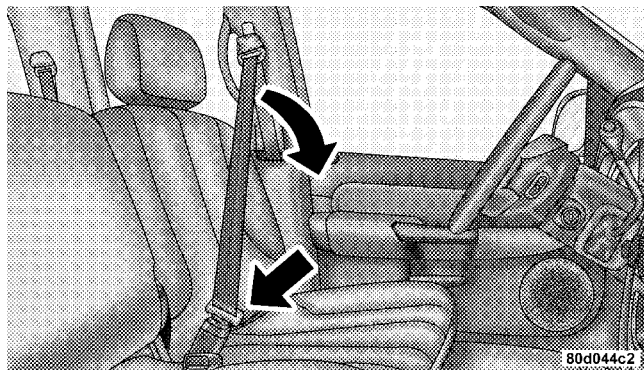

## WARNING!

- A belt buckled into the wrong buckle will not protect you properly. The lap portion could ride too high on your body, possibly causing internal injuries. Always buckle your belt into the buckle nearest you.
- A belt that is too loose will not protect you as well. In a sudden stop you could move too far forward, increasing the possibility of injury. Wear your seat belt snugly.
- A belt that is worn under your arm is very dangerous. Your body could strike the inside surfaces of the vehicle in a collision, increasing head and neck injury. And a belt worn under the arm can cause internal injuries. Ribs aren't as strong as shoulder bones. Wear the belt over your shoulder so that your strongest bones will take the force in a collision.
- A shoulder belt placed behind will not protect you from injury during a collision. You are more likely to hit your head in a collision if you do not wear your shoulder belt. The lap and shoulder belt are meant to be used together.

4. Position the lap belt across your thighs, below your abdomen. To remove slack in the lap belt portion, pull up on the shoulder belt. To loosen the lap belt if it is too tight, tilt the latch plate and pull on the lap belt. A snug belt reduces the risk of sliding under the belt in a collision.

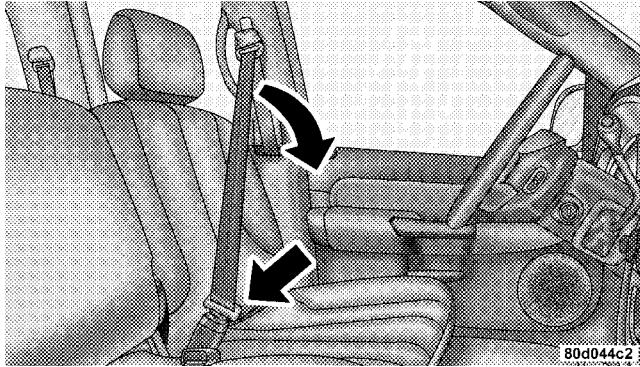

**Removing Slack From Belt**

### **WARNING!**

- A lap belt worn too high can increase the risk of internal injury in a collision. The belt forces won't be at the strong hip and pelvic bones, but across your abdomen. Always wear the lap belt as low as possible and keep it snug.
- A twisted belt can't do its job as well. In a collision it could even cut into you. Be sure the belt is straight. If you can't straighten a belt in your vehicle, take it to your dealer and have it fixed.

5. Position the shoulder belt on your chest so that it is comfortable and not resting on your neck. The retractor will withdraw any slack in the belt.

6. To release the belt, push the red button on the buckle. The belt will automatically retract to its stowed position. If necessary, slide the latch plate down the webbing to allow the belt to retract fully.

### **WARNING!**

**A frayed or torn belt could rip apart in a collision and leave you with no protection. Inspect the belt system periodically, checking for cuts, frays, or loose parts. Damaged parts must be replaced immediately. Do not disassemble or modify the system. Seat belt assemblies must be replaced after a collision if they have been damaged (bent retractor, torn webbing, etc.) or if the airbag deployed.**

### **Standard Cab Front Center Three Point Belt**

1. The front center seat belt on the Standard Cab may be disconnected to open up utilization of the storage areas behind the front seats. The black latch plate can be detached from the black keyed seat belt buckle located on the inboard side of the passenger seat. Insert the vehicle ignition key into the center white slot on the black buckle. The black buckle latch plate can be removed when the key is pressed into the buckle. Allow the retractor to take up the surplus webbing, and the buckles will hang vertically from the cab back exit bezel, thus freeing up all the area behind the front seats.

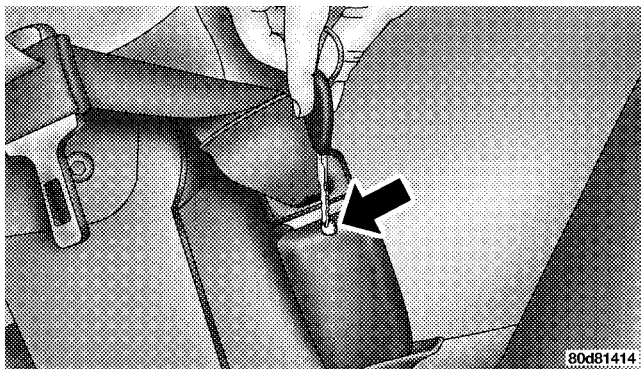

#### Detaching Buckle with Key

2. To reattach the seat belt to the front center seat, pull the black buckle latch plate forward from the cab back panel and insert it into the black keyed buckle until there is an audible click. Refer to the previous section for the proper seat belt usage.

#### WARNING!

- If the black latch and black buckle are not properly connected when the seat belt is used by an occupant, the seat belt will not be able to provide proper restraint and will increase the risk of injury in a collision.
- When reattaching the black latch and black buckle, ensure the seat belt webbing is not twisted. If the webbing is twisted, follow the preceding procedure to detach the black latch and black buckle, untwist the webbing, and reattach the black latch and black buckle.



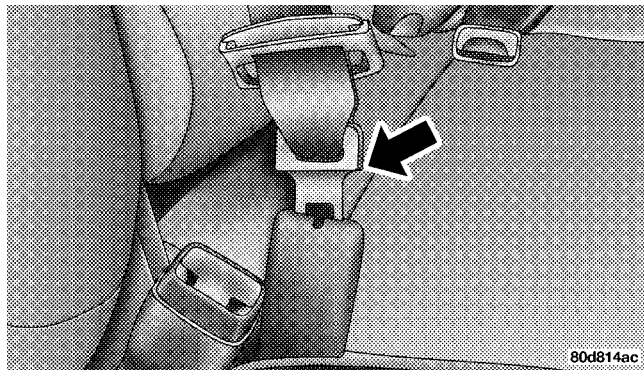

**Inserting Latch Plate**

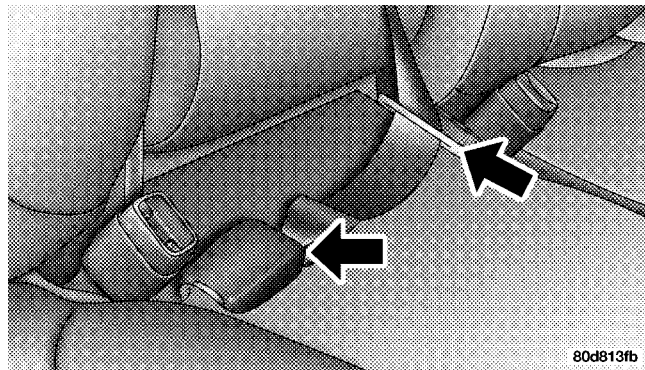

**In Use Position**

**WARNING!**

If the black latch and buckle are not connected when the seat belt is used by an occupant, the seat belt will not restrain you properly.

**Adjustable Upper Shoulder Belt Anchorage**

In the front row outboard seats, the shoulder belt can be adjusted upward or downward to help position the belt away from your neck. Press the button located on the upper belt guide, and then move it up or down to the position that serves you best.

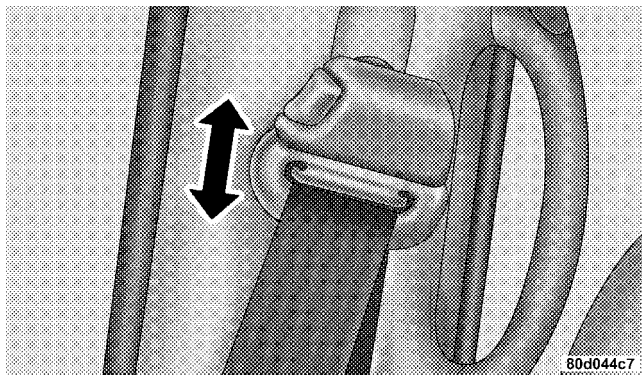

2

**Adjusting Upper Shoulder Belt**

As a guide, if you are shorter than average, you will prefer a lower position, and if you are taller than average, you'll prefer a higher position. When you release the anchorage, try to move it up or down to make sure that it is locked in position.

### **Automatic Locking Restraint (ALR) Mode – If Equipped**

In this mode, the shoulder belt is automatically pre-locked. The belt will still retract to remove any slack in the shoulder belt. The automatic locking mode is available on all passenger seating positions with a combination lap/shoulder belt.

### **When To Use The Automatic Locking Mode**

Anytime a child safety seat is installed in a passenger seating position. Children 12 years old and under should be properly restrained in the rear seat whenever possible.

### **How To Use The Automatic Locking Mode**

1. Buckle the combination lap/shoulder belt.
2. Grasp the shoulder portion and pull downward until the entire belt is extracted.

3. Allow the belt to retract. As the belt retracts, you will hear a clicking sound. This indicates the safety belt is now in the automatic locking mode.

### **How To Disengage The Automatic Locking Mode**

Disconnect the combination lap/shoulder belt and allow it to retract completely to disengage the automatic locking mode and activate the vehicle sensitive (emergency) locking mode.

### **Center Lap Belts**

The center seating position for the Quad Cab front seat has a lap belt only. To fasten the lap belt, slide the latch plate into the buckle until you hear a "click." To lengthen the lap belt, tilt the latch plate and pull. To remove slack, pull the loose end of the webbing. Wear the lap belt snug against the hips. Sit back and erect in the seat, then adjust the belt as tightly as is comfortable.

**WARNING!**

- **A lap belt worn too loose or too high is dangerous.**
- **A belt worn too loose can allow you to slip down and under the belt in a collision.**
- **A belt that is too loose or too high will apply crash forces to the abdomen, not to the stronger hip bones. In either case, the risk of internal injuries is greater. Wear a lap belt low and snug.**

**Seat Belt Pretensioners**

The seat belts for both front seating positions are equipped with pretensioning devices that are designed to remove slack from the seat belt system in the event of a collision. These devices improve the performance of the seat belt by assuring that the belt is tight about the occupant early in a collision. Pretensioners work for all size occupants, including those in child restraints.

**NOTE:** These devices are not a substitute for proper seat belt placement by the occupant. The seat belt still must be worn snugly and positioned properly.

The pretensioners are triggered by the airbag control module. Like the airbags, the pretensioners are single use items. After a collision that is severe enough to deploy the airbags and pretensioners, both must be replaced.

**Enhanced Driver Seat Belt Reminder System (BeltAlert)**

If the driver's seat belt has not been buckled within 60 seconds of starting the vehicle and if the vehicle speed is greater than 5 mph (8 km/h), the Enhanced Warning System (BeltAlert) will alert the driver to buckle their seat belt. The driver should also instruct all other occupants to buckle their seat belts. Once the warning is triggered, the Enhanced Warning System (BeltAlert) will continue to chime and flash the Seat Belt Warning Light for 96 seconds or until the driver's seat belt is buckled. The

Enhanced Warning System (BeltAlert) will be reactivated if the driver's seat belt is unbuckled for more than 10 seconds and the vehicle speed is greater than 5 mph (8 km/h).

The Enhanced Warning System (BeltAlert) can be enabled or disabled by your authorized dealer or by following these steps:

**NOTE:** The following steps must occur within the first 60 seconds of the ignition switch being turned to the ON or START position. DaimlerChrysler does not recommend deactivating the Enhanced Warning System (BeltAlert).

1. With all doors closed and the ignition switch in any position except On or Start, buckle the driver's seat belt.
2. Turn the ignition switch to the ON position and wait for the Seat Belt Warning Light to turn off.

3. Within 60 seconds of starting the vehicle, unbuckle and then re-buckle the driver's seat belt at least three times within 10 seconds, ending with the seat belt buckled.

4. Turn off the engine. A single chime will sound to signify that you have successfully completed the programming.

The Enhanced Warning System (BeltAlert) can be reactivated by repeating this procedure.

**NOTE:** Although the Enhanced Warning System (BeltAlert) has been deactivated, the Seat Belt Warning Light will continue to illuminate while the driver's seat belt remains unbuckled.

### Seat Belts and Pregnant Women

We recommend that pregnant women use seat belts throughout their pregnancies. Keeping the mother safe is the best way to keep the baby safe.

Pregnant women should wear the lap part of the belt across the thighs and as snug against the hips as possible. Keep the belt low so that it does not come across the abdomen. That way the strong bones of the hips will take the force if there is a collision.

### Seat Belt Extender

If a seat belt is too short, even when fully extended, your dealer can provide you with a seat belt extender. This extender should be used only if the existing belt is not long enough. When it is not required, remove the extender and store it.

### WARNING!

**Using a seat belt extender when not needed can increase the risk of injury in a collision. Only use the seat belt extender when the lap belt is not long enough when it is worn low and snug, and in the recommended seating positions. Remove and store the extender when not needed.**

### Driver And Right Front Passenger Supplemental Restraint System (SRS)—Airbag

This vehicle has front airbags for both the driver and front passenger as a supplement to the seat belt restraint systems. The driver's front airbag is mounted in the center of the steering wheel. The passenger's front airbag is mounted in the instrument panel, above the glove compartment. The words SRS AIRBAG are embossed on the airbag covers.

These airbags are certified to the new Federal regulations that allow less forceful deployments.

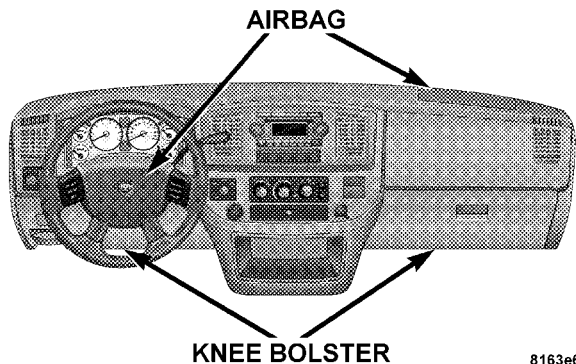

This vehicle may also be equipped with window bags to protect the driver and passengers in the first and second row sitting next to a window. If the vehicle is equipped with window bags, they are located above the side windows. Their covers are also labeled SRS AIRBAG.

## WARNING!

- Do not put anything on or around the airbag covers or attempt to manually open them. You may damage the airbags and you could be injured because the airbags are not there to protect you. These protective covers for the airbag cushions are designed to open only when the airbags are inflating.
- Do not mount any aftermarket equipment such as trailer brake controllers, snowplow controllers, auxiliary light switches, radios, etc. on or behind the knee bolster. Knee bolsters are designed to work with the air bag and seat belt to protect you. Mounting any additional equipment on or behind the knee bolster can cause injury during a crash.
- If your vehicle is equipped with window bags, do not stack luggage or other cargo up high enough to block the location of the window bag. The area where the window bag is located should remain free from any obstructions.
- If your vehicle is equipped with window bags, do not have any accessory items installed which will alter the roof, including adding a sunroof to your vehicle. Do not add roof racks that require permanent attachments (bolts or screws) for installation on the vehicle roof. Do not drill into the roof of the vehicle for any reason.

**NOTE:** Do not use a clothing bar mounted to the coat hooks in this vehicle. A clothing bar will impede the proper performance of the window bags.

Airbags inflate in moderate to high speed impacts. Along with the seatbelts, front airbags work with the instrument panel knee bolsters to provide improved protection for the driver and front passenger. Window bags also work with seat belts to improve occupant protection.

The seat belts are designed to protect you in many types of collisions. The front airbags deploy in moderate to severe frontal collisions. If your vehicle is so equipped, the window bag on the crash side of the vehicle is triggered in moderate to severe side collisions. In certain types of collisions, both the front and side airbags may be triggered. But even in collisions where the airbags work, you need the seat belts to keep you in the right position for the airbags to protect you properly.

Here are some simple steps you can follow to minimize the risk of harm from a deploying airbag.

- Children 12 years and under should ride buckled up in a rear seat, if available.
- Infants in rear facing child restraints must **NEVER** ride in the front seat of a vehicle with a passenger front airbag **unless the airbag is turned off** (Standard Cab Vehicles Only). An airbag deployment can cause severe injury or death to infants in that position. See the Passenger Airbag On/Off Switch section.
- If your vehicle does not have a rear seat, see the Passenger Airbag On/Off Switch section.
- Children that are not big enough to properly wear the vehicle seat belt (see section on Child Restraints) should be secured in the rear seat in child restraints or belt-positioning booster seats. Older children who do not use child restraints or belt-positioning booster



seats should ride properly buckled up in the rear seat. Never allow children to slide the shoulder belt behind them or under their arm.

- All occupants should use their seat belts properly.
- The driver and front passenger seats should be moved back as far as practical to allow the airbag room to inflate.

**WARNING!**

- **Relying on the airbags alone could lead to more severe injuries in a collision. The airbags work with your seat belt to restrain you properly. In some collisions the airbags won't deploy at all. Always wear your seat belts even though you have airbags.**
- **Being too close to the steering wheel or instrument panel during airbag deployment could cause serious injury. Airbags need room to inflate. Sit back, comfortably extending your arms to reach the steering wheel or instrument panel.**
- **If the vehicle has window airbags, they also need room to inflate. Do not lean against the door or window. Sit upright in the center of the seat.**

## Airbag System Components

The airbag system consists of the following:

- Airbag Control Module
- AIRBAG Readiness Light
- Driver Airbag
- Passenger Airbag
- Steering Wheel and Column
- Instrument Panel
- Crash Sensor
- Interconnecting Wiring
- Knee Impact Bolsters
- Passenger Side Frontal Airbag ON/OFF Switch (Standard Cab Vehicles Only)

**The Window Airbag System, on vehicles equipped, consists of the following:**

- AIRBAG Readiness Light (shared with the front airbag system)
- Window Bags Above the Side Windows.
- Airbag Control Module (shared with the front airbag system)
- Side impact sensors
- Interconnecting Wiring

## How The Airbag System Works

- The airbag control module determines if a frontal collision is severe enough to require the airbags to inflate.
- The airbag control module will not detect roll over, or rear collisions.

- The airbag control module also monitors the readiness of the electronic parts of the system whenever the ignition switch is in the START or RUN positions. These include all of the items listed above except the knee bolsters, the instrument panel, and the steering wheel and column. If the key is in the "Off" position, in the ACC position or not in the ignition, the airbags are not on and will not inflate
- The airbag control module also turns on the AIR BAG light in the instrument panel for 6 to 8 seconds when the ignition is first turned on, then turns the light off.
  - If it detects a malfunction in any part of the system, it turns on the light either momentarily or continuously. The instrument cluster will flash the seat belt indicator if it detects a fault with the airbag indicator.

**WARNING!**

**Ignoring the AIR BAG light in your instrument panel could mean you won't have the airbags to protect you in a collision. If the light does not come on, stays on after you start the vehicle, or if it comes on as you drive, have the airbag system checked right away.**

- When the airbag control module detects a collision requiring the airbags, it signals the inflator units. A large quantity of nontoxic gas is generated to inflate the airbags. The airbag covers separate and fold out of the way as the airbags inflate to their full size. The airbags fully inflate in milliseconds. This is less time than it takes you to blink your eyes. The airbags then quickly deflate while helping to restrain the driver and front passenger. The driver's front airbag deflates through vents towards the instrument panel. The

passenger's front airbag is deflated through vent holes in the sides of the airbag. In this way the airbags do not interfere with your control of the vehicle.

- The knee impact bolsters help protect the knees and position you for the best interaction with the front airbag.

### Passenger Airbag On/Off Switch – (Standard Cab Vehicles Only)

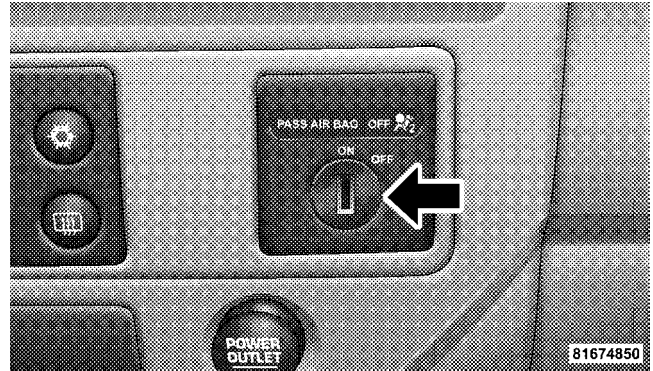

2

The passenger front airbag is to be turned off only if the passenger:

- is an infant (less than 1 year old) who must ride in the front seat because there is no rear seat, because the rear seat is too small for a rear-facing infant restraint or

because the infant has a medical condition which makes it necessary for the driver to be able to see the infant,

- is a child, age 1 to 12 who must ride in the front seat because there is no rear seat, because there is no rear seat position available, or because the child has a medical condition which makes it necessary for the driver to be able to see the child,
- has a medical condition which makes passenger airbag inflation (deployment) a greater risk for the passenger than the risk of hitting the dashboard (instrument panel) or windshield in a crash.

### **WARNING!**

**Whenever an airbag is turned off, even a lap/shoulder belted passenger may hit their head, neck, or chest on the dashboard (instrument panel) or windshield in a crash. This may result in serious injury or death.**

#### **To Shut Off the Passenger Airbag (Standard Cab Vehicles Only)**

Place the ignition key in the Passenger Airbag On/Off Switch, push the key in and turn clockwise, and remove the key from the switch. This will shut off the passenger side airbag. The "Off" light near the switch will illuminate when the ignition switch is turned to the ON position.

### To Turn On the Passenger Airbag (Standard Cab Vehicles Only)

Place the ignition key in the Passenger Airbag On/Off Switch, push the key in and turn counterclockwise, and remove the key from the switch. This will turn on the passenger airbag. The “Off” light near the switch will be off when the ignition switch is turned to the ON position.

### If A Deployment Occurs

The airbag system is designed to deploy when the air bag control module detects a moderate-to-severe frontal collision, and then immediately to deflate.

**NOTE:** A frontal collision that is not severe enough to need airbag protection will not activate the system. This does not mean something is wrong with the airbag system.

If you do have a collision which deploys the airbags, any or all of the following may occur:

- The nylon airbag material may sometimes cause abrasions and/or skin reddening to the driver and front passenger as the airbags deploy and unfold. The abrasions are similar to friction rope burns or those you might get sliding along a carpet or gymnasium floor. They are not caused by contact with chemicals. They are not permanent and normally heal quickly. However, if you haven't healed significantly within a few days, or if you have any blistering, see your doctor immediately.
- As the airbags deflate you may see some smoke-like particles. The particles are a normal by-product of the process that generates the nontoxic gas used for airbag inflation. These airborne particles may irritate the skin, eyes, nose, or throat. If you have skin or eye irritation, rinse the area with cool water. For nose or throat

irritation, move to fresh air. If the irritation continues, see your doctor. If these particles settle on your clothing, follow the garment manufacturer's instructions for cleaning.

- It is not advisable to drive your vehicle after the airbags have deployed. If you are involved in another collision, the airbags will not be in place to protect you.

### **WARNING!**

**Deployed airbags can't protect you in another collision. Have the airbags replaced by an authorized dealer as soon as possible.**

### **Window Airbags Supplemental Restraint System (SRS)—If Equipped**

The window airbag control module determines if a side collision is severe enough to require the side airbags to inflate. The window airbag control module will not detect roll over, front or rear collisions.

The airbag control module monitors the readiness of the electronic parts of the system whenever the ignition switch is in the "START" or "RUN" positions. These include all of the items listed above. The airbag control module also turns on the AIRBAG light in the instrument panel for 6 to 8 seconds when the ignition is first turned on as a diagnostic or system check, then turns the light off. If it detects a malfunction in any part of the system, it turns on the light either momentarily or continuously.

The side (window) impact SRS Airbags are designed to activate only in certain side collisions. When the airbag control module detects a collision requiring the window

bags to inflate, it signals the inflators on the crash side of the vehicle. A quantity of nontoxic gas is generated to inflate the window bag. The inflating window bag pushes the side pillar molding out of the way and covers the window. The airbag inflates in about 30 milliseconds (about one-quarter of the time it takes to blink your eyes) with enough force to injure you if you are not belted and seated properly, or if items are positioned in the area where the window bag inflates. This especially applies to children. The window bag is only about 3 ½ inches (8.9 cm) thick when it is inflated.

### **Enhanced Accident Response System**

If the airbags deploy after an impact and the electrical system remains functional, vehicles equipped with power door locks will unlock automatically. In addition, approximately 10 seconds after the vehicle has stopped moving, the interior lights will light until the ignition switch is turned off.

## **Maintaining Your Airbag Systems**

### **WARNING!**

- **Modifications to any part of the airbag system could cause it to fail when you need it. You could be injured because the airbags are not there to protect you. Do not modify the components or wiring, including adding any kind of badges or stickers to the steering wheel hub trim cover or the upper right side of the instrument panel. Do not modify the front bumper, vehicle body structure, or frame.**
- **You need proper knee impact protection in a collision. Do not mount or locate any aftermarket equipment on or behind the knee bolster.**
- **It is dangerous to try to repair any part of the airbag system yourself. Be sure to tell anyone who works on your vehicle that it has airbags.**



### Airbag Light



You will want to have the airbags ready to inflate for your protection in an impact. While the airbag system is designed to be maintenance free, if any of the following occurs, have an authorized dealer service the system promptly:

- The airbag light does not come on or flickers during the 6 to 8 seconds when the ignition switch is first turned on.
- The light remains on or flickers after the 6 to 8 second interval.
- The light flickers or comes on and remains on while driving.

**NOTE:** If the speedometer, tachometer or any engine related gauges are not working, the airbag control module may also be disabled. The airbags may not be ready

to inflate for your protection. Promptly check fuse numbers 52 and 53 in the fuse and relay center. See your dealer if the fuse is good.

### Event Data Recorder (EDR)

In the event of an airbag deployment, your vehicle is designed to record up to 2-seconds of specific vehicle data parameters (see list below) in an event data recorder prior to the moment of airbag deployment. Please note that such data are ONLY recorded if an airbag deploys, and are otherwise unavailable. In conjunction with other data gathered during a complete accident investigation, the electronic data may be used by DaimlerChrysler Corporation and others to learn more about the possible causes of crashes and associated injuries in order to assess and improve vehicle performance. In addition to

crash investigations initiated by DaimlerChrysler Corporation, such investigations may be requested by customers, insurance carriers, government officials, and professional crash researchers, such as those associated with universities, and with hospital and insurance organizations.

In the event that an investigation is undertaken by DaimlerChrysler Corporation (regardless of initiative), the company or its designated representative will first obtain permission of the appropriate custodial entity for the vehicle (usually the vehicle owner or lessee) before accessing the electronic data stored, unless ordered to download data by a court with legal jurisdiction (i.e., pursuant to a warrant). A copy of the data will be provided to the custodial entity upon request. General data that does not identify particular vehicles or crashes may be released for incorporation in aggregate crash databases, such as those maintained by the US government and various states. Data of a potentially sensitive

nature, such as would identify a particular driver, vehicle, or crash, will be treated confidentially. Confidential data will not be disclosed by DaimlerChrysler Corporation to any third party except when:

1. Used for research purposes, such as to match data with a particular crash record in an aggregate database, provided confidentiality of personal data is thereafter preserved
2. Used in defense of litigation involving a DaimlerChrysler Corporation product
3. Requested by police under a legal warrant
4. Otherwise required by law

Data Parameters that May Be Recorded:

- Diagnostic trouble code(s) and warning lamp status for electronically-controlled safety systems, including the airbag system

- Airbag disable lamp status (if equipped)
- "Time" of airbag deployment (in terms of ignition cycles and vehicle mileage)
- Airbag deployment level (if applicable)
- Seatbelt status
- Brake status (service and parking brakes)
- Accelerator status (including vehicle speed)
- Engine control status (including engine speed)
- Cruise control status

### **Child Restraint**

Everyone in your vehicle needs to be buckled up all the time — babies and children, too. Every state in the United States and all Canadian provinces require that small children ride in proper restraint systems. This is the law, and you can be prosecuted for ignoring it.

Children 12 years and under should ride properly buckled up in a rear seat, if available. According to crash statistics, children are safer when properly restrained in the rear seats rather than in the front.

### **WARNING!**

**In a collision, an unrestrained child, even a tiny baby, can become a missile inside the vehicle. The force required to hold even an infant on your lap can become so great that you could not hold the child, no matter how strong you are. The child and others could be badly injured. Any child riding in your vehicle should be in a proper restraint for the child's size.**

## Infants and Small Children

There are different sizes and types of restraints for children from newborn size to the child almost large enough for an adult safety belt. Use the restraint that is correct for your child:

- Safety experts recommend that children ride rearward-facing in the vehicle until they are at least one year old and weigh at least 20 lbs (9 kg). Two types of child restraints can be used rearward-facing: infant carriers and "convertible" child seats. Both types of child restraints are held in the vehicle by the lap/shoulder belt.
- The infant carrier is only used rearward-facing in the vehicle. It is recommended for children who weigh up to about 20 lbs (9 kg). "Convertible" child seats can be used either rearward-facing or forward-facing in the vehicle. Convertible child seats often have a higher weight limit in the rearward-facing direction than infant carriers do, so they can be used rearward-facing by children who weigh more than 20 lbs (9 kg) but are less than one year old.
- Rearward-facing child seats must **NEVER** be used in the front seat of a vehicle with a front passenger airbag unless the airbag is turned off. An airbag deployment could cause severe injury or death to infants in this position.
- Children who weigh more than 20 lbs (9 kg) and who are older than one year can ride forward-facing in the vehicle. Forward-facing child seats and convertible child seats used in the forward-facing direction are for children who weigh 20 to 40 lbs (9 to 18 kg) and who are older than one year. These child seats are also held in the vehicle by the lap/shoulder belt.
- The belt-positioning booster seat is for children weighing more than 40 lbs (18 kg), but who are still too small to fit the vehicle's seat belts properly. If the child

cannot sit with knees bent over the vehicle's seat cushion while the child's back is against the seat back, they should use a belt-positioning-booster seat. The child and booster seat are held in the vehicle by the lap/shoulder belt. (Some booster seats are equipped with a front shield and are held in the vehicle by the lap portion.) For further information refer to [www.seatcheck.org](http://www.seatcheck.org).

**WARNING!**

- **Improper installation can lead to failure of an infant or child restraint. It could come loose in a collision. The child could be badly injured or killed. Follow the manufacturer's directions exactly when installing an infant or child restraint.**
- **A rearward facing child restraint should only be used in a rear seat, or in the front seat if the passenger's front airbag is Off. If the airbag is left On, a rearward facing child restraint in the front seat may be struck by a deploying passenger airbag which may cause severe or fatal injury to the infant.**

**Here are some tips for getting the most out of your child restraint:**

- Before buying any restraint system, make sure that it has a label certifying that it meets all applicable Safety Standards. We also recommend that you make sure that you can install the child restraint in the vehicle where you will use it before you buy it.
  - The restraint must be appropriate for your child's weight and height. Check the label on the restraint for weight and height limits.
  - Carefully follow the instructions that come with the restraint. If you install the restraint improperly, it may not work when you need it.
  - The passenger seat belts are equipped with Automatic Locking Retractors (ALR), which are designed to keep the lap portion tight around the child restraint so that it is not necessary to use a locking clip.
- Pull the belt from the retractor until there is enough to allow you to pass through the child restraint and slide the latch plate into the buckle. Then pull on the belt until it is all removed from the retractor. Allow the belt to return to the retractor, pulling on the excess webbing to tighten the lap portion about the child restraint. Refer to the "Automatic Locking Retractors (ALR) Mode" earlier in this section.
- In the rear seat, you may have trouble tightening the lap/shoulder belt on the child restraint because the buckle or latch plate is too close to the belt path opening on the restraint. Disconnect the latch plate from the buckle and twist the short buckle-end belt several times to shorten it. Insert the latch plate into the buckle with the release button facing out.
  - If the belt still can't be tightened, or if pulling and pushing on the restraint loosens the belt, disconnect the latch plate from the buckle, turn the latch plate

around, and insert the latch plate into the buckle again. If you still can't make the child restraint secure, try a different seating position.

- Buckle the child into the seat according to the child restraint manufacturer's directions.
- When your child restraint is not in use, secure it in the vehicle with the seat belt or remove it from the vehicle. Do not leave it loose in the vehicle. In a sudden stop or collision, it could strike the occupants or seat backs and cause serious personal injury.

### **WARNING!**

**Improper installation can lead to failure of an infant or child restraint. It could come loose in a collision. The child could be badly injured or killed. Follow the manufacturer's directions exactly when installing an infant or child restraint.**

#### **Lower Anchors and Tether for CHILDREN (LATCH)**

Each vehicle is equipped with the child restraint anchorage system called LATCH, which stands for Lower Anchors and Tether for CHILDREN. LATCH child restraint anchorage systems are installed in the Standard Cab passenger seat position and the Quad Cab rear seat outboard positions. LATCH equipped seating positions feature both lower anchor bars, located at the back of the seat cushion, and tether strap anchorages, located behind the seatback (refer to Child Restraint Tether Anchor later in this section).

Identification dots are located above the standard cab front seat lower anchorages as a guide for locating lower anchors.

**NOTE:** For children riding in the front seat of a Standard Cab model refer to the “Passenger Airbag On/Off Switch” located in this section.

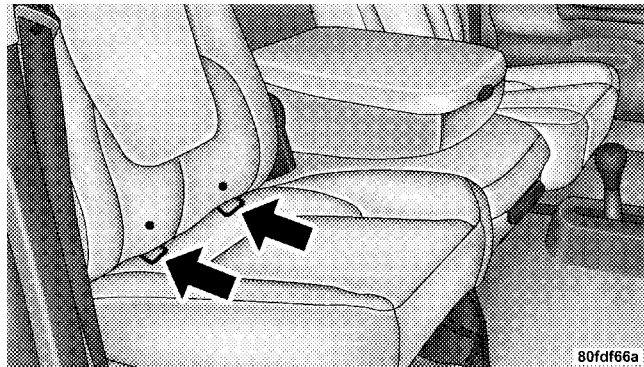

Standard Cab Passenger Seat

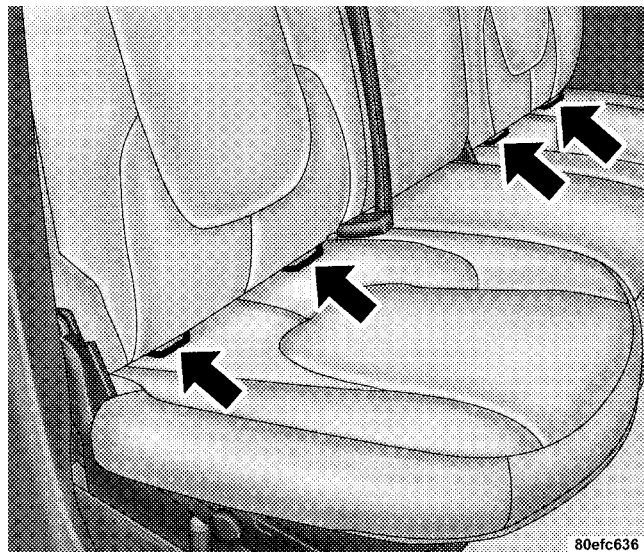

Quad Cab Rear Outboard Seats



Child restraint systems having attachments designed to connect to the lower anchorages are now available. Child restraints having tether straps and hooks for connection to the seatback tether anchorage have been available for some time. In fact, many child restraint manufacturers will provide add-on tether strap kits for some of their older products.

Because the lower anchorages are to be introduced to passenger carrying vehicles over a period of years, child restraint systems having attachments for those anchorages will continue to have features for installation in vehicles using the lap or lap/shoulder belt. They will also have tether straps, and you are urged to take advantage of all of the available attachments provided with your child restraint in any vehicle.

**NOTE:** When using the LATCH attaching system to install a child restraint, please ensure that all seat belts not being used for occupant restraints are stowed and out

of reach of children. It is recommended that before installing the child restraint, buckle the seat belt so the seat belt is tucked behind the child restraint and out of reach. If the buckled seat belt interferes with the child restraint installation, instead of tucking the seat belt behind the child restraint, route the seat belt through the child restraint belt path and then buckle it. This should stow the seat belt out of the reach of an inquisitive child. Remind all children in the vehicle that the seat belts are not toys and should not be played with, and never leave your child unattended in the vehicle.

**NOTE:** If your child restraint seat is not LATCH compatible, install the restraint using the vehicle seat belt.

## Installing the Child Restraint System

### WARNING!

**Do not install child restraint systems equipped with LATCH attachments in the center position of a Quad Cab model rear seat. The LATCH anchorages in this seat are designed for the two outboard seating positions only. A child may be placed in the rear center seating position of a Quad Cab model using the seat belt and child tether anchorage. Failure to follow this may result in serious or fatal injury.**

We urge that you carefully follow the directions of the manufacturer when installing your child restraint. Many, but not all, restraint systems will be equipped with separate straps on each side, with each having a hook or connector and a means for adjusting the tension in the strap. Forward-facing toddler restraints and some

rearward-facing infant restraints will also be equipped with a tether strap, a hook and means for adjusting the tension in the strap.

In general, you will first loosen the adjusters on the lower straps and tether straps so that you can more easily attach the hook or connector to the lower anchorages and tether anchorages. Then tighten all three straps as you push the child restraint rearward and downward into the seat.

Not all child restraint systems will be installed as we have described here. Again, carefully follow the instructions that come with the child restraint system.

**WARNING!**

**Improper installation of a child restraint to the LATCH anchorages can lead to failure of an infant or child restraint. The child could be badly injured or killed. Follow the manufacturer's directions exactly when installing an infant or child restraint.**

**Child Restraint Tether Anchor**

Child restraints having tether straps and hooks for connection to tether anchors have been available for some time. In fact, many child restraint manufacturers will provide add-on tether strap kits for their older products. Regular Cab models of Ram Pickups have two tether anchorages, one each behind the front center and right seats. Quad Cab models have three anchorages, one behind each of the rear seats.

**WARNING!**

**An incorrectly anchored tether strap could lead to seat failure and injury to the child. In a collision, the seat could come loose and allow the child to crash into the inside of the vehicle or other passengers, or even be thrown from the vehicle. Use only the anchor positions directly behind the child seat to secure a child restraint top tether strap. Follow the instructions below. See your dealer for help if necessary.**

**Tether Anchorage Points at the Right and Center Front Seat (Regular Cab - All Seats)**

1. Place the child restraint on the seat and adjust the tether strap so that it will reach over the seat back under the head restraint to the tether anchor directly behind the seat.

2. Lift the cover (if so equipped), and attach the hook to the square opening in the sheet metal.
3. Install the child restraint and remove the slack in the tether strap according to the manufacturer's instructions.

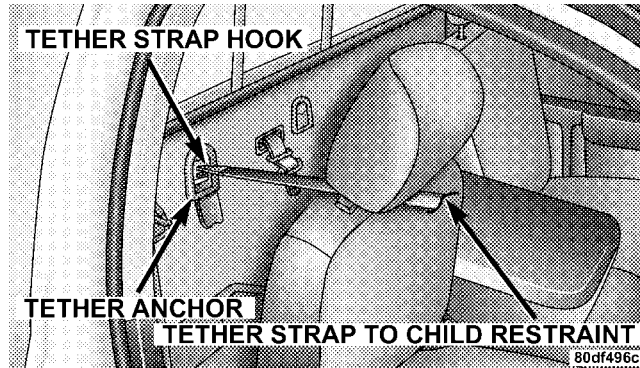

**Regular Cab Tether Strap Mounting**

### **Multiple Child Restraint Installation Sequence - (Quad Cab Rear Seats)**

1. Obtain tether straps by raising the head restraints and reaching between the rear glass and rear seat. The tether strap may be retained with an elastic band. Accessibility to the tether strap is greatly improved by raising the seat cushion to the “up” position. Remove the elastic before use.
2. Place a child restraint on each outboard rear seat and adjust the tether strap so that it will reach under the head restraint to the tether anchor directly behind the seat and then to the anchor directly behind the center rear seat.
3. Pass each tether strap hook under the head restraint and through the loop of webbing behind the child seat.
4. Route each tether strap to the anchor behind the center seat, and attach the hooks to the metal ring.

5. Place a child restraint on the center rear seat and adjust the tether strap so that it will reach under the head restraint to the tether anchor directly behind the seat and to the anchor directly behind the right seat.

6. Install each child restraint and remove the slack in the tether strap according to the child restraint manufacturer's instructions.

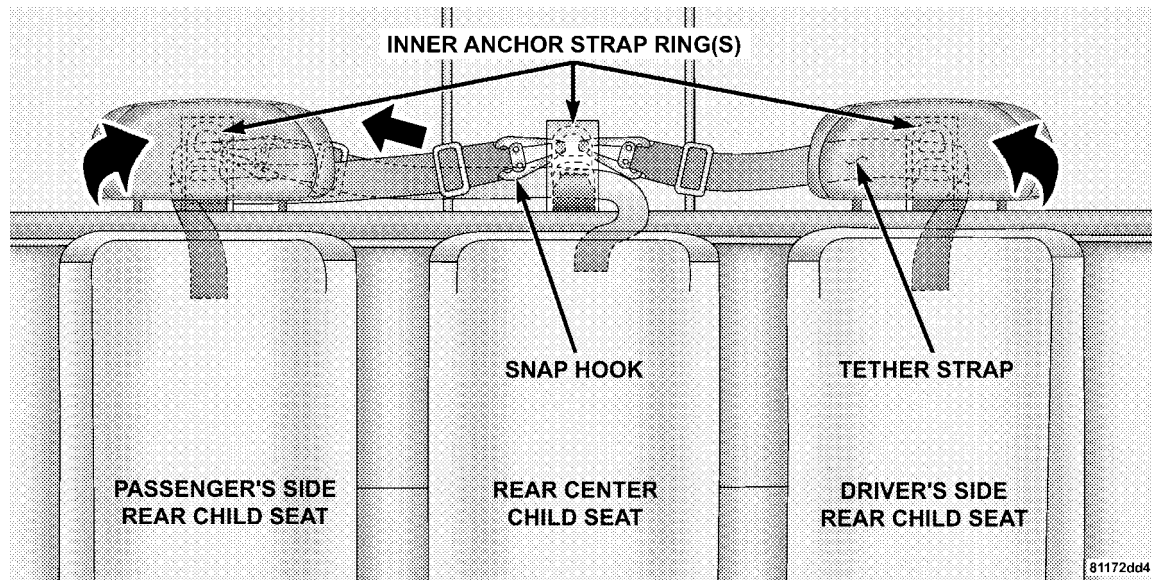

81172dd4

Multiple Child Restraint Quad Cab

### **Children Too Large for Booster Seats**

Children who are large enough to wear the shoulder belt comfortably, and whose legs are long enough to bend over the front of the seat when their back is against the seat back should use the lap/shoulder belt in a rear seat.

- Make sure that the child is upright in the seat.
- The lap portion should be low on the hips and as snug as possible.
- Check belt fit periodically. A child's squirming or slouching can move the belt out of position.

If the shoulder belt contacts the face or neck, move the child closer to the center of the vehicle. Never allow a child to put the shoulder belt under an arm or behind their back.

### **ENGINE BREAK-IN RECOMMENDATIONS**

A long break-in period is not required for the engine in your new vehicle. Drive moderately during the first 300 miles (500 km). After the initial 60 miles (100 km), speeds up to 50 or 55 mph (80 or 90 km/h) are desirable. While cruising, brief full-throttle acceleration, within the limits of local traffic laws, contributes to a good break-in.

Avoid wide open throttle acceleration in low gear.

The engine oil installed in the engine at the factory is a high quality, energy conserving type lubricant. Oil changes should be consistent with the anticipated climatic conditions under which vehicle operation will occur. The recommended viscosity and quality grades are discussed in Section 7 under Maintenance Procedures, Engine Oil.

**NON-DETERGENT OR STRAIGHT MINERAL OILS  
MUST NEVER BE USED.**

A new engine may consume some oil during its first few thousand miles of operation. This is a normal part of the break-in and is not an indication of difficulty.

**CAUTION!**

- **During the first 500 miles (805 km) your new vehicle is driven, do not tow a trailer. Doing so may damage your axles, driveline and vehicle.**
- **Limit your speed to 50 mph (80 km/h) during the first 500 miles (805 km) of towing.**





# UNDERSTANDING THE FEATURES OF YOUR VEHICLE

## CONTENTS

---

■ Power Wagon Features . . . . .	.78	□ Skid Plates And Underbody Protection . . . . .	.80
□ Locking Front And Rear Differentials . . . . .	.78	□ Wheel Flares . . . . .	.80
□ 4.56:1 Gears . . . . .	.78	□ Wheels . . . . .	.81
□ Electronically Disconnecting Stabilizer/ Sway Bar . . . . .	.79	□ Standard Package Features . . . . .	.81
□ Increased Ride Height . . . . .	.79	□ Mopar Options . . . . .	.82
□ 12,000 Lb. Winch . . . . .	.79	■ Mirrors . . . . .	.83
□ High-Pressure Monotube Shocks/New Front And Rear Springs . . . . .	.80	□ Inside Mirror . . . . .	.83
□ Off-Road Tires . . . . .	.80	□ Automatic Dimming Mirror – If Equipped . . . . .	.84
		□ Outside Mirrors . . . . .	.84

## 74 UNDERSTANDING THE FEATURES OF YOUR VEHICLE

- Exterior Mirrors Folding Feature . . . . .85
- Electronic Power Mirrors –If Equipped . . . . .85
- Electric Rear Window Defroster And Heated Sideview Mirrors – If Equipped . . . . .86
- Trailer Towing Mirrors – If Equipped . . . . .86
- Hands-Free Communication (UConnect™) — If Equipped . . . . .87
  - Operations . . . . .89
  - Phone Call Features . . . . .96
  - UConnect™ System Features . . . . .98
  - Advanced Phone Connectivity . . . . .103
  - Things You Should Know About Your UConnect™ System . . . . .104
- Seats . . . . .110
  - 40-20-40 Front Seat . . . . .111
  - Reclining Seats . . . . .112
  - Adjustable Head Restraints . . . . .112
  - Manual Rotary Lumbar Support Adjustment — If Equipped . . . . .113
  - Power Seats — If Equipped . . . . .114
  - Heated Seats — If Equipped . . . . .115
- To Open And Close The Hood . . . . .117
- Lights . . . . .118
  - Interior Lights . . . . .119
  - Battery Saver . . . . .120
  - Headlamp Delay . . . . .120
  - Headlights, Parking Lights, Panel Lights . . . . .120

<input type="checkbox"/> Daytime Running Lights (Canada Only And Fleet Vehicles) . . . . .	121
<input type="checkbox"/> Lights-On Reminder . . . . .	122
<input type="checkbox"/> Fog Lights — If Equipped . . . . .	122
<input type="checkbox"/> Cargo Light — If Equipped . . . . .	122
<input type="checkbox"/> Multifunction Control Lever . . . . .	123
<b>■</b> Windshield Wipers And Washers . . . . .	125
<input type="checkbox"/> Windshield Wipers . . . . .	125
<input type="checkbox"/> Windshield Washers . . . . .	126
<b>■</b> Tilt Steering Column . . . . .	127
<b>■</b> Electronic Speed Control — If Equipped . . . . .	128
<input type="checkbox"/> To Activate . . . . .	128
<input type="checkbox"/> To Set At A Desired Speed . . . . .	128

**UNDERSTANDING THE FEATURES OF YOUR VEHICLE 75**

<input type="checkbox"/> To Deactivate . . . . .	128
<input type="checkbox"/> To Resume Speed . . . . .	129
<input type="checkbox"/> To Vary The Speed Setting . . . . .	129
<input type="checkbox"/> To Accelerate For Passing . . . . .	130
<b>■</b> Overhead Console— If Equipped . . . . .	131
<input type="checkbox"/> Courtesy/Reading Lights . . . . .	132
<b>■</b> Overhead Console With Compass/Temperature Mini-Trip Computer — If Equipped . . . . .	132
<input type="checkbox"/> US/M Button . . . . .	133
<input type="checkbox"/> Reset Button . . . . .	133
<input type="checkbox"/> Global Reset . . . . .	134
<input type="checkbox"/> Step Button . . . . .	134
<input type="checkbox"/> Average Fuel Economy (AVG ECO) . . . . .	134

## 76 UNDERSTANDING THE FEATURES OF YOUR VEHICLE

- Distance To Empty (DTE) . . . . . 134
- Trip Odometer (ODO) . . . . . 135
- Elapsed Time (ET) . . . . . 135
- C/T Button . . . . . 136
- Automatic Compass Calibration . . . . . 136
- Manual Compass Calibration . . . . . 137
- Recalibrating The Compass . . . . . 137
- Outside Temperature . . . . . 138
- Garage Door Opener — If Equipped . . . . . 139
  - Programming HomeLink . . . . . 141
  - Canadian Programming/Gate Programming . . 143
  - Using HomeLink . . . . . 144
  - Erasing HomeLink Buttons . . . . . 144
  - Reprogramming a Single HomeLink Button . . . 144
  - Security . . . . . 145
- Power Sunroof — If Equipped . . . . . 145
  - Open Sunroof - Express Mode . . . . . 146
  - Comfort Stop . . . . . 146
  - Closing Sunroof - Express . . . . . 147
  - Pinch Protect Feature . . . . . 147
  - Pinch Protect Override . . . . . 147
  - Venting Sunroof - Express . . . . . 147
  - Sunshade Operation . . . . . 147
  - Wind Buffeting . . . . . 148
  - Sunroof Maintenance . . . . . 148
  - Sunroof Fully Closed . . . . . 148

<ul style="list-style-type: none"> <li>■ Electrical Power Outlets . . . . .148</li> <li>■ Cigar Lighter And Ash Receiver . . . . .150</li> <li>■ Cupholders . . . . .151                     <ul style="list-style-type: none"> <li>□ Front Instrument Panel Cupholders . . . . .151</li> <li>□ Rear Cupholder — Quad Cab — If Equipped .151</li> </ul> </li> <li>■ Storage . . . . .152                     <ul style="list-style-type: none"> <li>□ Center Storage Compartment — If Equipped . .152</li> <li>□ Storage And Seats — If Equipped . . . . .153</li> </ul> </li> <li>■ Rear Window Features . . . . .154                     <ul style="list-style-type: none"> <li>□ Electric Rear Window Defroster And Heated Side View Mirrors — If Equipped . . . . .154</li> <li>□ Power Sliding Rear Window—If Equipped . . .154</li> <li>□ Sliding Rear Window—If Equipped . . . . .155</li> </ul> </li> </ul>	<ul style="list-style-type: none"> <li>■ Fold Flat Load Floor — If Equipped . . . . .155</li> <li>■ Pickup Box . . . . .159</li> <li>■ Slide-In Campers . . . . .160</li> <li>■ Easy-Off Tailgate . . . . .160</li> <li>■ Safety Tips . . . . .162                     <ul style="list-style-type: none"> <li>□ Transporting Passengers . . . . .162</li> <li>□ Lock Your Vehicle . . . . .162</li> <li>□ Exhaust Gas . . . . .163</li> <li>□ Safety Checks You Should Make Inside The Vehicle . . . . .163</li> <li>□ Safety Checks You Should Make Outside The Vehicle . . . . .164</li> </ul> </li> </ul>
---	--

## POWER WAGON FEATURES

### Locking Front and Rear Differentials

Most 4WD trucks are equipped with open differentials front and rear. This design is used because it allows each wheel to turn independently helping to eliminate binding when cornering. A disadvantage of using an open differential is when one or more wheels lose traction; all of the power is directed to those wheels resulting in a loss of momentum. The Power Wagon is equipped with electronically locking front and rear differentials. These differentials, when engaged, mechanically lock together the axle shafts forcing the wheels to spin at an equal rate. This allows the vehicle to maintain its momentum and thus prevents it from becoming stuck. The locking front and rear differentials should only be engaged during low-speed, extreme off-road situations where one wheel is likely to not be in contact with the ground. It is not

recommended to drive the vehicle with the differentials locked on pavement due to the reduced ability to turn and speed limitations.

### 4.56:1 Gears

This is the highest axle ratio available in a full-size pickup. The high gearing helps to compensate for the increased rolling mass and increase diameter of the off-road tires. As well, there are many advantages to a higher axle ratio in off-road applications. When driving downhill the high gearing enables the driver to use the engine to slow the vehicle down in a more controlled manner. When driving up a steep grade, the ratio helps by keeping the truck in its power band helping to maintain upward momentum.

**Electronically Disconnecting Stabilizer/Sway Bar**

Stabilizer bars are used to help distribute load force from one side of the vehicle to the other. This helps to reduce body roll and create a smoother ride during on-road driving. However, this becomes a disadvantage when the vehicle is driven off-road when a higher level of suspension articulation is needed. By disconnecting the stabilizer bars, each wheel can now reach its maximum range of movement. This enables the vehicle to maintain a greater tire contact patch, and thus more traction, when traversing severe off-road terrain.

**Increased Ride Height**

Due to the use of taller springs, the Power Wagon has an increased ride height of approximately 1.9 inches in the front and 1.5 inch in the rear. It allows the truck to traverse larger obstructions and provides a better seating position from which to view the trail. A major advantage to increasing ride height is the positive effect it has on

approach/departure and break over angles. More ride height allows for more aggressive angles, further improving off-road capability.

**12,000 lb. Winch**

The Power Wagon is the "only pickup truck" to offer an electric vehicle recovery winch from the factory. The winch provides the vehicle with an additional level of capability and versatility. This winch uses the electrical power from the vehicle charging system to power a motor that winds wire rope onto the winch drum via planetary gear reduction. By nature, a winch is capable of generating very high forces and should be used with care. Do not operate the winch without reading and understanding the complete winch section of owner's manual, including all warnings and cautions.



### **High-Pressure Monotube Shocks/New Front and Rear Springs**

The new variable-rate shocks and revised springs help to create a suitable on-road ride without compromising off-road competency. The shocks are designed to provide improved stability, durability, and suspension articulation.

### **Off-Road Tires**

These tires are specifically designed for extreme off-road use, while also maintaining quite on-road operation. The tires utilize long-life compounds for increased durability, and a deep-groove tread for extra traction. The LT285/70R17D used provides a large contact patch for better traction, two full-width steel belts for improved strength, as well as a reinforced sidewall to help protect against bruising and shredding.

### **Skid Plates And Underbody Protection**

Steel skid plates protect the major driveline components of the truck including the fuel tank, transfer case and steering damper. In addition the Power Wagon is equipped with boxed cross members and fore/aft rails. This additional protection allows the vehicle to be utilized in severe off-road situations that would be considered impassable by a normal truck.

### **Wheel Flares**

Not just for looks, the wheel flares on the Power Wagon were designed to help cover its new larger off-road tires. The larger flares also help to reduce the amount of debris that can be flung up by the more aggressive tread pattern on the tires.

## Wheels

Stylish forged aluminum 17" wheels give the Power Wagon a powerful stance. Forging a wheel from aluminum produces a stronger, lighter weight wheel than machining or casting the wheel out of the same material.

### Standard package features:

- Fuel Tank Skid Plate - protects the fuel tank from impingement damage.
- Transfer Case Skid Plate and Tubing - protects the transfer case and exhaust catalyst from impingement damage.
- Heavy Duty Cross Members - protects the under carriage and supports the under body protection skid plates.
- Fore/Aft rails - which connect the cross member for additional support and prevent the truck from getting hung up on large rocks between the cross members.
- Steering Dampener Skid Plate - protects the steering dampener from impingement damage.
- Electronically Locking Front And Rear Axle Differentials With 4:56 Gears - improves mobility and articulation by locking the differentials.
- Electronically Disconnecting Stabilizer Bar - improves mobility and articulation by disconnecting the Stabilizer Bar.
- 160 Amp Alternator - supplies increased electrical power for the winch and other off-road accessories.
- Heavy Duty Battery - supplies increased electrical power for the winch and other off-road accessories.
- Heavy Duty Cooling Fan - provides enhanced engine and transmission cooling under vigorous off-road conditions.

- Off-Road Tuned Suspension And Shocks - improves mobility, ground clearance and ride comfort.
- Heavy Duty Thermally Protected and Sealed Electric Winch With Roller Fairlead - Useful for work and vehicle recovery.
- 17 Inch Forged Aluminum Wheels With 33 Inch Tires - improves traction and differential ground clearance.

**Mopar Options:**

- Rock Rails - protects the door sills from impingement damage and provides a vehicle jacking point.
- Winch accessory kit - Contents include:
  - Snatch Block/Pulley

- Clevis
- Tree strap
- Tow Strap
- Gloves
- “Power Wagon embossed” storage bag
- Bed Liner - protects the bed from impingement damage

**NOTE:** These Mopar options have been specially designed and tested for the Power Wagon to meet the vigorous off-road conditions.

## MIRRORS

### Inside Mirror

The mirror should be adjusted to center on the view through the rear window.

Annoying headlight glare can be reduced by moving the small control under the mirror to the night position (toward rear of vehicle). The mirror should be adjusted while set in the day position (toward windshield).

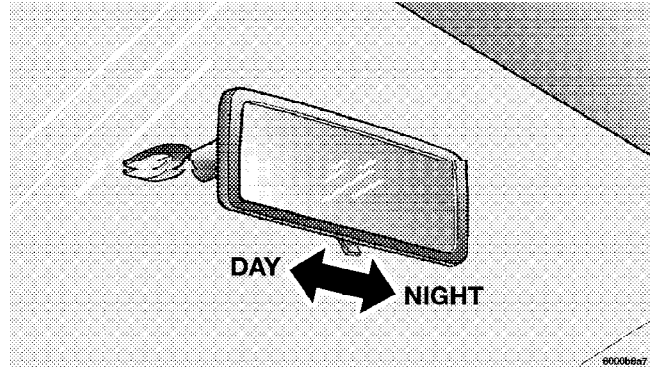

**Adjusting Rear View Mirror**

### Automatic Dimming Mirror – If Equipped

This mirror automatically adjusts for annoying headlight glare from vehicles behind you. You can turn the feature on or off by pressing the button at the base of the mirror. A light in the button will indicate when the dimming feature is activated.

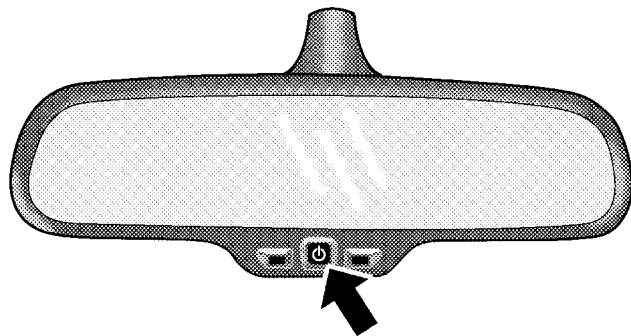

Automatic Dimming Mirror

817892c4

### CAUTION!

**To avoid damage to the mirror during cleaning, never spray any cleaning solution directly onto the mirror. Apply the solution onto a clean cloth and wipe the mirror clean.**

### Outside Mirrors

To receive maximum benefit, adjust the outside mirror(s) to center on the adjacent lane of traffic with a slight overlap of the view obtained on the inside mirror.

**WARNING!**

Vehicles and other objects seen in a right side convex mirror will look smaller and farther away than they really are. Relying too much on your right side convex mirror could cause you to collide with another vehicle or other object. Use your inside mirror when judging the size or distance of a vehicle seen in the right side convex mirror. Some vehicles will not have a convex right side mirror.

**Exterior Mirrors Folding Feature**

All 6 x 9 inch exterior mirrors are hinged and may be moved either forward or rearward to resist damage. The hinges have three detent positions; full forward, full rearward, and normal.

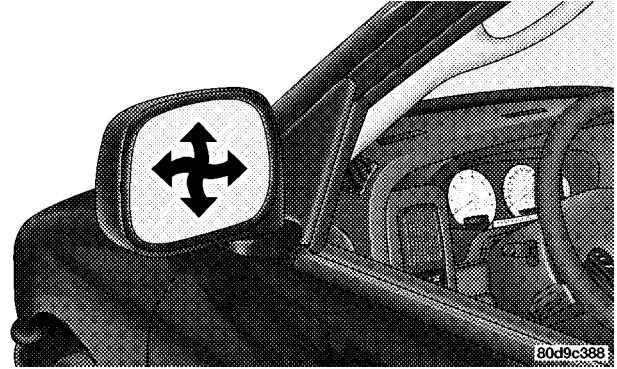
**Electronic Power Mirrors –If Equipped****Power Mirror Movement**

The controls for the power mirrors are located on the driver's door trim panel.

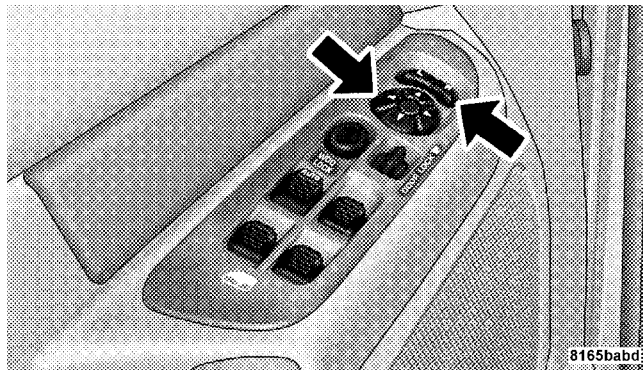

### Power Mirror Switches

Set the top switch to the left or right for the left or right mirror, and set it to the center off position to prevent accidentally moving a mirror when you are finished adjusting the mirror. To adjust a mirror, select left or right

with the top switch, and press one of the four arrows for the direction you want the mirror to move.

### Electric Rear Window Defroster and Heated Sideview Mirrors – If Equipped

 The Electric Rear Window Defroster and Heated side view mirrors are activated by pressing the heated grid button, located on the Climate Control panel, with the ignition On. Turning Off the rear window defroster or the ignition will deactivate the Electric Rear Window Defroster and Heated side view mirrors feature. These features also turn off after activation, when 15 minutes have elapsed. To reactivate, simply press the button again.

### Trailer Towing Mirrors – If Equipped

These mirrors are designed with an adjustable mirror head to provide a greater vision range when towing

extra-wide loads. To change position inboard or outboard, the mirror head should be rotated (flipped Out or In). A small blindspot mirror is integrated onto the main mirror surface.

**NOTE:** Fold the 7 x 10 inch trailer towing mirrors rearward prior to entering an automated car wash.

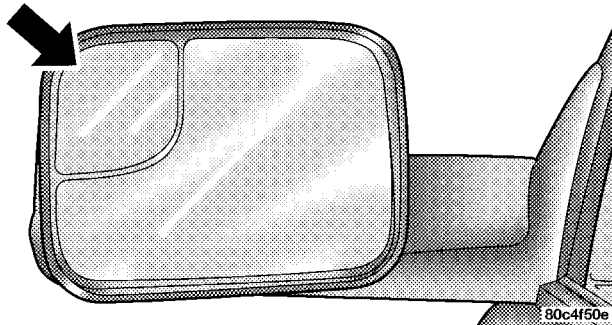

**Blindspot Mirror**

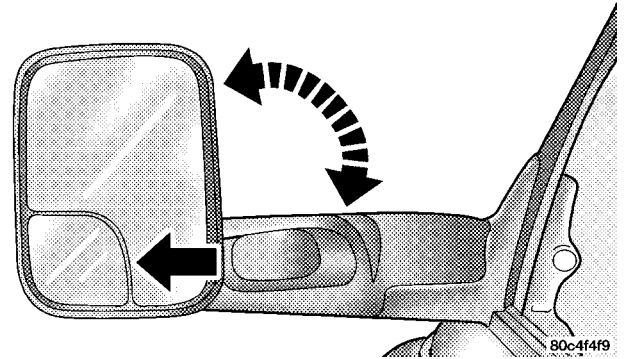

**Trailer Towing Position**

### **HANDS-FREE COMMUNICATION (UConnect™) — IF EQUIPPED**

UConnect™ is a voice-activated, hands-free, in-vehicle communications system. UConnect™ allows you to dial a phone number with your cellular phone using simple voice commands (e.g., "Call" ... "Mike" ... "Work" or "Dial"



... “248-555-1212”). Your cellular phone’s audio is transmitted through your vehicle’s audio system; the system will automatically mute your radio when using the UConnect™ system.

**NOTE:** The UConnect™ system use requires a cellular phone equipped with the Bluetooth “Hands-Free Profile,” version 0.96 or higher. See [www.chrysler.com/uconnect](http://www.chrysler.com/uconnect) for supported phones.

UConnect™ allows you to transfer calls between the system and your cellular phone as you enter or exit your vehicle, and enables you to mute the system’s microphone for private conversation.

The UConnect™ phonebook enables you to store up to 32 names and four numbers per name. Each language has a separate 32-name phonebook accessible only in that language. This system is driven through your Bluetooth™ Hands-Free profile cellular phone. UConnect™ features Bluetooth™ technology - the global standard

that enables different electronic devices to connect to each other without wires or a docking station, so UConnect works no matter where you stow your cellular phone (be it your purse, pocket, or briefcase), as long as your phone is turned on and has been paired to the vehicle’s UConnect™ system. The UConnect™ system allows up to seven cellular phones to be linked to system. Only one linked (or paired) cellular phone can be used with the system at a time. The system is available in English, Spanish, or French languages (as equipped).

The rearview mirror contains the microphone for the system and the control buttons that will enable you to access the system.



8105b20d

### UConnect™ Switches

The UConnect™ system can be used with any Hands-Free Profile certified Bluetooth™ cellular phone. See [www.chrysler.com/uconnect](http://www.chrysler.com/uconnect) for supported phones. If your cellular phone supports a different profile (e.g.,

Headset Profile), you may not be able to use any UConnect™ features. Refer to your cellular service provider or the phone manufacturer for details.

The UConnect™ system is fully integrated with the vehicle's audio system. The volume of the UConnect™ system can be adjusted either from the radio volume control knob, or from the steering wheel radio control (right switch), if so equipped.

The radio display will be used for visual prompts from the UConnect™ system such as "CELL" or caller ID on certain radios.

### Operations

Voice commands can be used to operate the UConnect™ system and to navigate through the UConnect™ menu structure. Voice commands are required after most UConnect™ system prompts. You will be prompted for a specific command and then guided through the available options.

- Prior to giving a voice command, one must wait for the voice on beep, which follows the "Ready" prompt or another prompt.
- For certain operations, compound commands can be used. For example, instead of saying "Setup" and then "Phone Pairing," the following compound command can be said: "Setup Phone Pairing."
- For each feature explanation in this section, only the combined form of the voice command is given. You can also break the commands into parts and say each part of the command, when you are asked for it. For example, you can use the combined form voice command "Phonebook New Entry," or you can break the combined form command into two voice commands: "Phonebook" and "New Entry." Please remember, the UConnect™ system works best when you talk in a normal conversational tone, as if speaking to someone sitting eight feet away from you.

### **Voice Command Tree**

Refer to "Voice Tree" at the end of this section.

### **Help Command**

If you need assistance at any prompt, or if you want to know your options are at any prompt, say "Help" following the voice on beep. The UConnect™ system will play all the options at any prompt if you ask for help.

To activate the UConnect™ system from idle, simply press the 'Phone' button and follow audible prompts for directions. All UConnect™ system sessions begin with a press of the 'Phone' button on the mirror.

### **Cancel Command**

At any prompt, after the voice on beep, you can say "Cancel" and you will be returned to the main menu. However, in a few instances the system will take you back to the previous menu.

**Pair (Link) UConnect™ System to a Cellular Phone**

To begin using your UConnect™ system, you must pair your compatible Bluetooth™ enabled cellular phone.

**NOTE:** The UConnect™ system use requires a cellular phone equipped with the Bluetooth "Hands-Free Profile," version 0.96 or higher. See [www.chrysler.com/uconnect](http://www.chrysler.com/uconnect) for supported phones.

To complete the pairing process, you will need to reference your cellular phone owner's manual. One of the following vehicle specific websites may also provide detailed instructions for pairing with the brand of phone that you have:

**NOTE:**

- [www.chrysler.com/uconnect](http://www.chrysler.com/uconnect)
- [www.dodge.com/uconnect](http://www.dodge.com/uconnect)
- [www.jeep.com/uconnect](http://www.jeep.com/uconnect)

The following are general phone to UConnect™ System pairing instructions:

- Press the 'Phone' button to begin.
- After the "Ready" prompt and the following beep, say "Setup Phone Pairing" and follow the audible prompts.
- When prompted, after the voice on beep, say "Pair a Phone" and follow the audible prompts.
- You will be asked to say a four-digit pin number, which you will later need to enter into your cellular. You can enter any four-digit pin number. You will not need to remember this pin number after the initial pairing process.
- For identification purposes, you will be prompted to give the UConnect™ system a name for your cellular phone. Each cellular phone that is paired should be given a unique phone name.

- You will then be asked to give your cellular phone a priority level between 1 and 7, 1 being the highest priority. You can pair up to seven cellular phones to your UConnect™ system. However, at any given time, only one cellular phone can be in use, connected to your UConnect™ System. The priority allows the UConnect™ system to know which cellular phone to use if multiple cellular phones are in the vehicle at the same time. For example, if priority 3 and priority 5 phones are present in the vehicle, the UConnect™ system will use the priority 3 cellular phone when you make a call. You can select to use a lower priority cellular phone at any time (refer to "Advanced Phone Connectivity").

### **Call/Dial by Saying a Number**

- Press the 'Phone' button to begin.
- After the "Ready" prompt and the following beep, say "Dial."

- System will prompt you to say the number you want call.
- For example, you can say "234-567-8901."
- The UConnect™ system will confirm the phone number and then dial. The number will appear in the display of certain radios.

### **Call/Dial by Saying a Name**

- Press the "Phone" button to begin.
- After the "Ready" prompt and the following beep, say "Dial" or Call."
- System will prompt you to say the name of the person you want call.
- After the "Ready" prompt and the following beep, say the name of the person you want to call. For example,

you can say "John Doe," where John Doe is a previously stored name entry in the UConnect™ phonebook. Refer to "Add Names to Your UConnect™ Phonebook," to learn how to store a name in the phonebook.

- The UConnect™ system will confirm the name and then dial the corresponding phone number, which may appear in the display of certain radios.

### **Add Names to Your UConnect™ Phonebook**

**NOTE:** Adding names to phonebook is recommended when vehicle is not in motion.

- Press the "Phone" button to begin.
- After the "Ready" prompt and the following beep, say "Phonebook New Entry."

- When prompted, say the name of the new entry. Use of long names helps the voice recognition and is recommended. For example, say "Robert Smith" or "Robert" instead of "Bob."
- When prompted, enter the number designation (e.g., "Home," "Work," "Mobile," or "Pager"). This will allow you to store multiple numbers for each phonebook entry, if desired.
- When prompted, recite the phone number for the phonebook entry that you are adding.

After you are finished adding an entry into the phonebook, you will be given the opportunity to add more phone numbers to the current entry or to return to the main menu.

The UConnect™ system will allow you to enter up to 32 names in the phonebook with each name having up to

four associated phone numbers and designations. Each language has a separate 32-name phonebook accessible only in that language.

### **Edit Entries in the UConnect™ Phonebook**

**NOTE:** Editing phonebook entries is recommended when vehicle is not in motion.

- Press the 'Phone' button to begin.
- After the "Ready" prompt and the following beep, say "Phonebook Edit."
- You will then be asked for the name of the phonebook entry that you wish to edit.
- Next, choose the number designation (home, work, mobile, or pager) that you wish to edit.
- When prompted, recite the new phone number for the phonebook entry that you are editing.

After you are finished editing an entry in the phonebook, you will be given the opportunities to edit another entry in the phonebook, call the number you just edited, or return to the main menu.

"Phonebook Edit" can be used to add another phone number to a name entry that already exists in the phonebook. For example, the entry John Doe may have a mobile and a home number, but you can add John Doe's work number later using the "Phonebook Edit" feature.

### **Delete Entries in the UConnect™ Phonebook**

**NOTE:** Editing phonebook entries is recommended when vehicle is not in motion.

- Press the 'Phone' button to begin.
- After the "Ready" prompt and the following beep, say "Phonebook Delete."

- After you enter the Phonebook Delete menu, you will then be asked for the name of the entry that you wish to delete. You can either say the name of a phonebook entry that you wish to delete or you can say "List Names" to hear a list of the entries in the phonebook from which you choose. To select one of the entries from the list, press the "Voice Recognition" button while the UConnect™ system is playing the desired entry and say "Delete."
- After you enter the name, the UConnect™ system will ask you which designation you wish to delete, home, work, mobile, or pager. Say the designation you wish to delete.
- Note that only the phonebook entry in the current language is deleted.

After confirmation, the phonebook entries will be deleted. Note that only the phonebook in the current language is deleted.

### **Delete All Entries in the UConnect™ Phonebook**

- Press the 'Phone' button to begin.
- After the "Ready" prompt and the following beep, say "Phonebook Erase All."
- The UConnect™ system will ask you to verify that you wish to delete all the entries from the phonebook.
- After confirmation, the phonebook entries will be deleted.

### **List All Names in the UConnect™ Phonebook**

- Press the 'Phone' button to begin.
- After the "Ready" prompt and the following beep, say "Phonebook List Names."
- The UConnect™ system will play the names of all the phonebook entries.



- To call one of the names in the list, press the "Voice Recognition" button during the playing of the desired name, and then say "Call." NOTE: the user can also exercise "Edit" or "Delete" operations at this point.
- The UConnect™ system will then prompt you as to number designation you wish to call.
- The selected number will be dialed.

### **Phone Call Features**

The following features can be accessed through the UConnect™ system if the feature(s) are available on your cellular service plan. For example, if your cellular service plan provides three-way calling, this feature can be accessed through the UConnect™ system. Check with your cellular service provider for the features that you have.

### **Answer or Reject an Incoming Call - No Call Currently in Progress**

When you receive a call on your cellular phone, the UConnect™ system will interrupt the vehicle audio system, if on, and will ask if you would like to answer the call. To reject the call, press and hold the 'Phone' button until you hear a single beep indicating that the incoming call was rejected.

### **Answer or Reject an Incoming Call - Call Currently in Progress**

If a call is currently in progress and you have another incoming call, you will hear the same network tones for call waiting that you normally hear when using your cell phone. Press the 'Phone' button to place the current call on hold and answer the incoming call. NOTE: The UConnect™ system compatible phones in market today do not support rejecting an incoming call when another call is in progress. Therefore, the user can only either answer an incoming call or ignore it.

### **Making a Second Call while Current Call in Progress**

To make a second call while you are currently in a call, press the 'Voice Recognition' button and say "Dial" or "Call" followed by the phone number or phonebook entry you wish to call. The first call will be on hold while the second call is in progress. To go back to the first call, refer to "Toggling Between Calls." To combine two calls, refer to "Conference Call."

### **Place/Retrieve a Call from Hold**

To put a call on hold, press the 'Phone' button until you hear a single beep. This indicates that the call is on hold. To bring the call back from hold, press and hold the 'Phone' button until you hear a single beep.

### **Toggling Between Calls**

If two calls are in progress (one active and one on hold), press the 'Phone' button until you hear a single beep

indicating that the active and hold status of the two calls have switched. Only one call can be placed on hold at one time.

### **Conference Call**

When two calls are in progress (one active and one on hold), press and hold the 'Phone' button until you hear a double beep indicating that the two calls have been joined into one conference call.

### **Three-Way Calling**

To initiate three-way calling, press the 'Voice Recognition' button while a call is in progress and make a second phone call as described under "Making a Second Call while Current Call in Progress." After the second call has established, press and hold the 'Phone' button until you hear a double beep indicating that the two calls have been joined into one conference call.

**Call Termination**

To end a call in progress, momentarily press the 'Phone' button. Only the active call(s) will be terminated and if there is a call on hold, it will become the new active call.

**Redial**

- Press the 'Phone' button to begin.
- After the "Ready" prompt and the following beep, say "Redial."
- The UConnect™ system will call the last number that was dialed on your cellular phone. Note: this may not be the last number dialed from the UConnect™ system.

**Call Continuation**

Call continuation is progression of a phone call on UConnect™ system after the vehicle ignition key has been switched to off. Call continuation functionality available on the vehicle can be any one of three types:

- After ignition key is switched off, a call can continue on the UConnect™ system either until the call ends or until the vehicle battery condition dictates cessation of the call on the UConnect™ system and transfer of the call to the mobile phone.
- After ignition key is switched to off, a call can continue on the UConnect™ system for certain duration, after which the call is automatically transferred from the UConnect™ system to the mobile phone.
- An active call is automatically transferred to the mobile phone after ignition key is switched to off.

**UConnect™ System Features****Language Selection**

To change the language that the UConnect™ system is using,

- Press the 'Phone' button to begin.

- After the "Ready" prompt and the following beep, say the name of the language you wish to switch to (English, Espanol, or Francais, if so equipped).
- Continue to follow the system prompts to complete language selection.

After selecting one of the languages, all prompts and voice commands will be in that language.

**NOTE:** After every UConnect™ language change operation, only the language specific 32-name phonebook is usable. The paired phone name is not language specific and usable across all languages.

### Emergency Assistance

If you are in an emergency and the mobile phone is reachable:

- Pick up the phone and manually dial the emergency number for your area.

If the phone is not reachable and the UConnect™ system is operational, you may reach the emergency number as follows:

- Press the 'Phone' button to begin.
- After the "Ready" prompt and the following beep, say "Emergency" and the UConnect™ system will instruct the paired cellular phone to call the emergency number. This feature is only supported in the USA.

**NOTE:** The emergency number dialed is based on the Country where the vehicle is purchased (911 for USA and Canada and 060 for Mexico). The number dialed may not be applicable with the available cellular service and area.

The UConnect™ system does slightly lower your chances of successfully making a phone call as to that for the cell phone directly.

Your phone must be turned on and paired to the UConnect™ system to allow use of this vehicle feature in

emergency situations when the cell phone has network coverage and stays paired to the UConnect™ system.

### **Towing Assistance**

If you need towing assistance,

- Press the 'Phone' button to begin.
- After the "Ready" prompt and the following beep, say "Towing Assistance."

**NOTE:** The Towing Assistance number dialed is based on the Country where the vehicle is purchased (1-800-528-2069 for USA, 1-877-213-4525 for Canada, 55-14-3454 for Mexico city and 1-800-712-3040 for outside Mexico city in Mexico).

Please refer to the 24-Hour "Towing Assistance" coverage details in the Warranty information booklet and on the 24-Hour Towing Assistance Card.

### **Paging**

To learn how to page, refer to "Working with Automated Systems." Paging works properly except for pagers of certain companies which time-out a little too soon to work properly with the UConnect™ system.

### **Voice Mail Calling**

To learn how to access your voice mail, refer to "Working with Automated Systems."

### **Working with Automated Systems**

This method is designed to be used in instances where one generally has to press numbers on the cellular phone keypad while navigating through an automated telephone system.

You can use your UConnect™ system to access a voice-mail system or an automated service, such as, paging service or automated customer service. Some services require immediate response selection, in some instances, that may be too quick for use of UConnect™ system.

When calling a number with your UConnect™ system that normally requires you to enter in a touch-tone sequence on your cellular phone keypad, you can push the 'Voice Recognition' button and say the sequence you wish to enter followed by the word "Send." For example, if required to enter your pin number followed with a pound 3 7 4 6 #, you can press the 'Voice Recognition' button and say "3 7 4 6 # Send." Saying a number, or sequence of numbers, followed by "Send" is also to be used to navigate through an automated customer service center menu structure and to leave a number on a pager.

### **Barge In - Overriding Prompts**

The 'Voice Recognition' button can be used when you wish to skip part of a prompt and issue your voice recognition command immediately. For example, if a prompt is playing "Would you like to pair a phone, clear a...," you could press the 'Voice Recognition' button and say "Pair a Phone" to select that option without having to listen to the rest of the voice prompt.

### **Turning Confirmation Prompts On/Off**

Turning confirmation prompts off will stop the system from confirming your choices (e.g., the UConnect™ system will not repeat a phone number before you dial it).

- Press the 'Phone' button to begin.
- After the "Ready" prompt and the following beep, say "Setup Confirmations." The UConnect™ system will play the current confirmation prompt status and you will be given the choice to change it.

### **Phone and Network Status Indicators**

If available on the radio and/or on a premium display such as the instrument panel cluster, and supported by your cell phone, the UConnect™ system will provide notification to inform you of your phone and network status when you are attempting to make a phone call using UConnect™. The status is given for roaming network signal strength, phone battery strength, etc.

### Dialing Using the Cellular Phone Keypad

You can dial a phone number with your cellular phone keypad and still use the UConnect™ system (while dialing via the cell phone keypad, the user must exercise caution and take precautionary safety measures). By dialing a number with your paired Bluetooth™ cellular phone, the audio will be played through your vehicle's audio system. The UConnect™ system will work the same as if you dial the number using voice recognition.

**NOTE:** Certain brands of mobile phones do not send the dial ring to the UConnect™ system to play it on the vehicle audio system, so you will not hear it. Under this situation, after successfully dialing a number, the user may feel that the call did not go through even though the call is in progress. Once your call is answered, you will hear the audio.

### Mute/Un-mute (Mute off)

When you mute the UConnect™ system, you will still be able to hear the conversation coming from the other party, but the other party will not be able to hear you. In order to mute the UConnect™ system:

- Press the 'Voice Recognition' button.
- After the "Ready" prompt and the following beep, say "Mute."

In order to un-mute the UConnect™ system:

- Press the 'Voice Recognition' button.
- After the "Ready" prompt and the following beep, say "Mute-off."

### **Information Service**

When using AT&T Wireless Service, dialing to phone number "#121," you can access voice activated automated system to receive news, weather, stocks, traffic, etc. related information.

### **Advanced Phone Connectivity**

#### **Transfer Call to and from Cellular Phone**

The UConnect™ system allows on going calls to be transferred from your cellular phone to the UConnect™ system without terminating the call. To transfer an ongoing call from your UConnect™ paired cellular phone to the UConnect™ system or vice-versa, press the 'Voice Recognition' button and say "Transfer Call."

#### **Connect or Disconnect Link Between the UConnect™ System and Cellular Phone**

Your cellular phone can be paired with many different electronic devices, but can only be actively "connected" with one electronic device at a time.

If you would like to connect or disconnect the Bluetooth™ connection between a UConnect™ paired cellular phone and the UConnect™ system, then follow the instruction described in your cellular phone user's manual.

#### **List Paired Cellular Phone Names**

- Press the 'Phone' button to begin.
- After the "Ready" prompt and the following beep, say "Setup Phone pairing".
- When prompted, say "List Phones."
- The UConnect™ system will play the phone names of all paired cellular phones in order from the highest to the lowest priority. To "select" or "delete" a paired phone being announced, press the 'Voice recognition' button and say "Select" or "Delete." Also, see the next two sections for an alternate way to "select" or "delete" a paired phone.



### Select another Cellular Phone

This feature allows you to select and start using another phone with the UConnect™ system. The phone must have been previously paired to the UConnect™ system that you want to use it with.

- Press the 'Phone' button to begin.
- After the "Ready" prompt and the following beep, say "Setup Select Phone" and follow the prompts.
- You can also press the 'Voice Recognition' button anytime while the list is being played, and then choose the phone that you wish to select.
- The selected phone will be used for the next phone call. If the selected phone is not available, the UConnect™ system will return to using the highest priority phone present in or near (approximately within 30 feet) the vehicle.

### Delete UConnect™ Paired Cellular Phones

- Press the 'Phone' button to begin.
- After the "Ready" prompt and the following beep, say "Setup Phone Pairing."
- At the next prompt, say "Delete" and follow the prompts.
- You can also press the 'Voice Recognition' button anytime while the list is being played and then choose the phone you wish to delete.

### Things You Should Know About Your UConnect™ System

#### Voice Recognition (VR)

- Always wait for the beep before speaking.

- Speak normally, without pausing, just as you would speak to a person sitting approximately eight (8) feet away from you.
- Make sure that no one other than you is speaking during a voice recognition period.
- Performance is maximized under:
  - low-to-medium blower setting,
  - low-to-medium vehicle speed,
  - low road noise,
  - smooth road surface,
  - fully closed windows,
  - dry weather condition.
- Even though the system is designed for users speaking in North American English, French, and Spanish accents, the system may not always work for some.
- When navigating through an automated system, such as voice mail, or when sending a page at the end of speaking the digit string, make sure to say "send."
- Storing names in phonebook when vehicle is not in motion is recommended.
- It is not recommended to store similar sounding names in the UConnect™ phonebook.
- UConnect™ phonebook nametag recognition rate is optimized for the voice of the person who stored the name in the phonebook.
- You can say "O" (letter "O") for "0" (zero). "800" must be spoken "eight-zero-zero."
- Even though international dialing for most number combinations is supported, some shortcut dialing number combinations may not be supported.

### **Far End Audio Performance**

- Audio quality is maximized under:
  - low-to-medium blower setting,
  - low-to-medium vehicle speed,
  - low road noise,
  - smooth road surface,
  - fully closed windows, and
  - dry weather condition.
- Operation from driver seat.
- Performance, such as audio clarity, echo, and loudness to a large degree rely on the phone and network, and not the UConnect™ system.
- Echo at far end can sometime be reduced by lowering the in-vehicle audio volume.

### **Bluetooth Communication Link**

Occasionally, Cellular phones have been found to lose connection to the UConnect™ system. When this happens, the connection can generally be re-established by switching the phone off/on. Your cell phone is recommended to remain in Bluetooth "on" mode.

### **Power-Up**

After switching the ignition key from OFF to either ON or ACC position, or after a reset, you must wait at least five (5) seconds prior to using the system.

**Voice Command Tree**

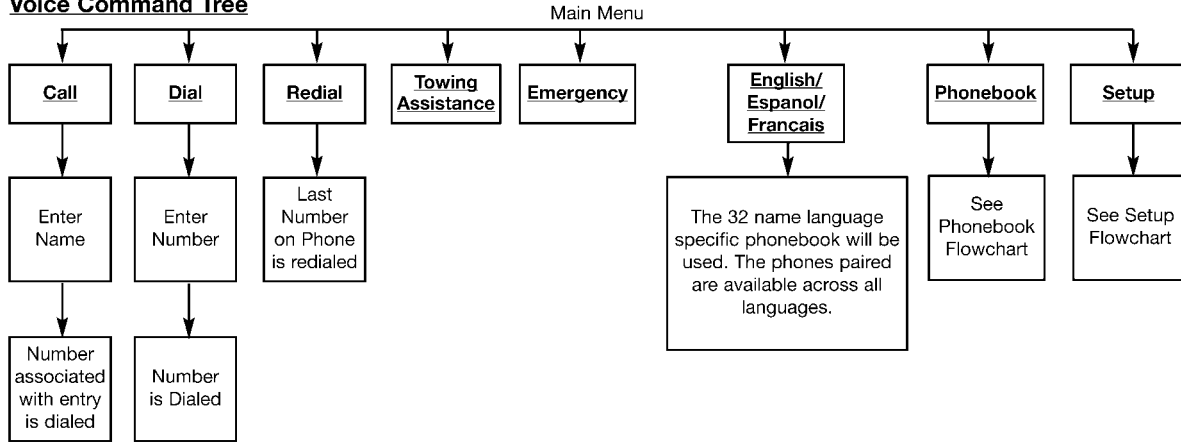

**Note:** Available Voice commands are shown in bold face and are underlined.

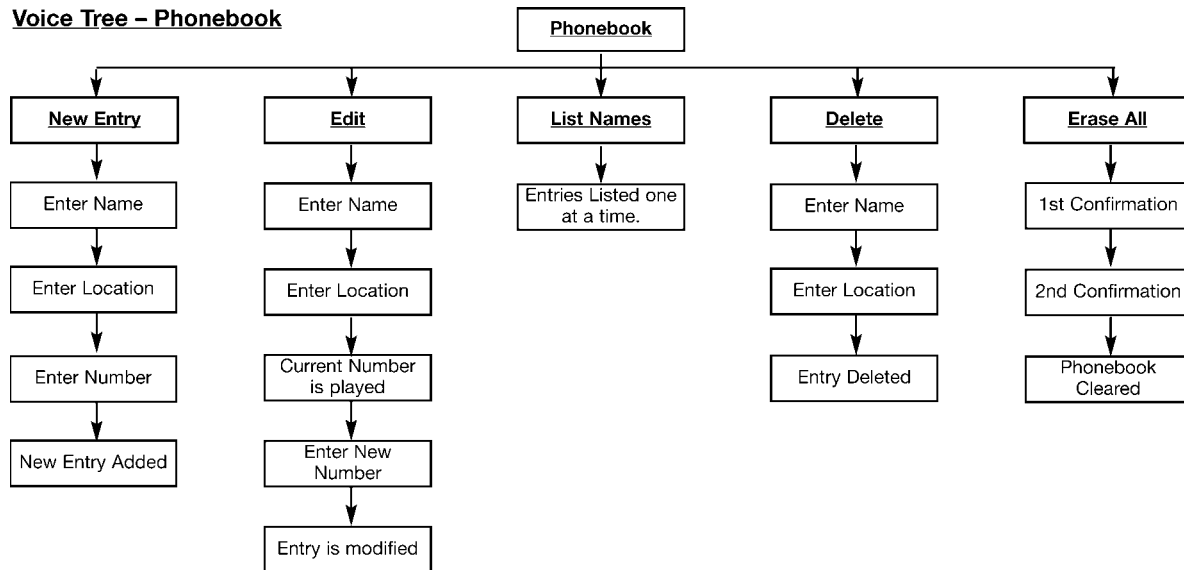
**Voice Tree – Phonebook**

**Note:** Available Voice commands are shown in bold face and are underlined.

**Voice Tree – Setup**

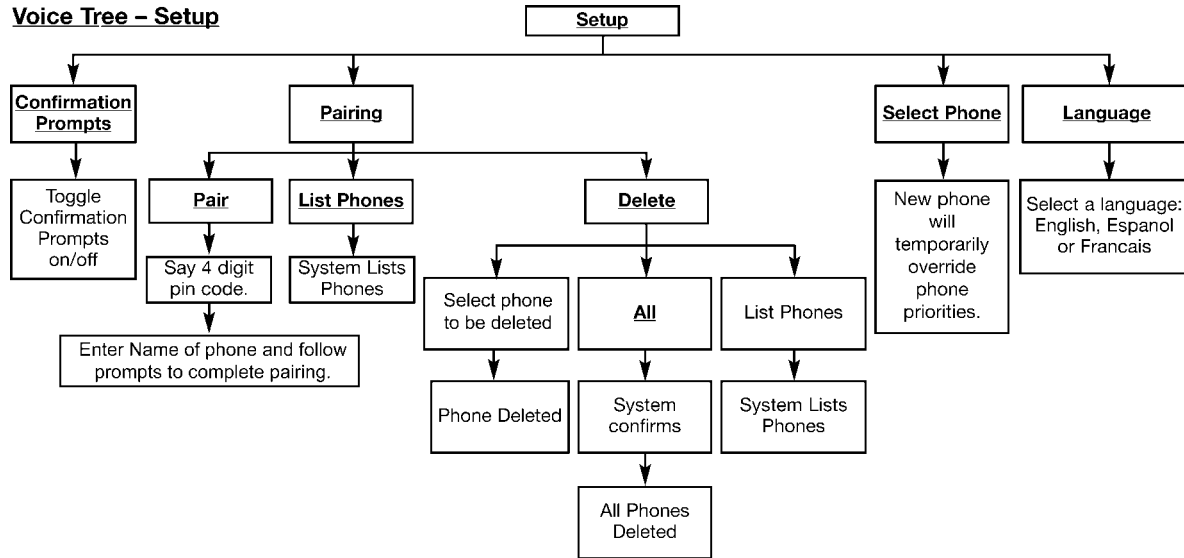

**Note:** Available Voice commands are shown in bold face and are underlined.

	North American English
Primary	Alternate(s)
Zero	Oh
Add location	Add new
All	All of them
Confirmation prompts	Confirmations prompts
Delete a name	Delete
Language	Select language
List names	List all
List paired phones	List phones
Pager	Beeper
Phone pairing	Pairing
Phonebook	Phone book
Return to main menu	Return. Main menu
Select phone	select
Set up	Phone settings phone set up

## SEATS

The seating options available in this truck are the result of extensive customer research and evaluations.

### WARNING!

**It is extremely dangerous to ride in a cargo area, inside or outside of a vehicle. In a collision, people riding in these areas are more likely to be seriously injured or killed.**

**Do not allow people to ride in any area of your vehicle that is not equipped with seats and seat belts.**

**Be sure everyone in your vehicle is in a seat and using a seat belt properly.**

### 40-20-40 Front Seat

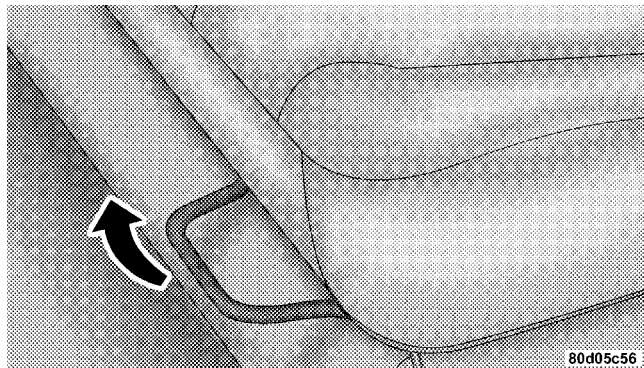

As the name implies, the seat is divided into 3 segments. The outboard seat portions are each 40% of the total width of the seat. The back of the center portion (20%) easily folds down to provide an armrest/center storage compartment (if equipped).

Each outboard seat is independently adjustable forward or backward and is equipped with a back recliner. The manual seat adjustment handle is found at the front edge of each seat cushion. Pull up on the handle and slide the seat to get the most comfortable position.

#### **WARNING!**

**Adjusting a seat while the vehicle is moving is dangerous. The sudden movement of the seat could cause you to lose control. The seat belt might not be properly adjusted and you could be injured. Adjust any seat only while the vehicle is parked.**



### Reclining Seats

The recliner handle is on the outside of the seat cushion. Pull up on the handle to release the seat back and adjust for comfort.

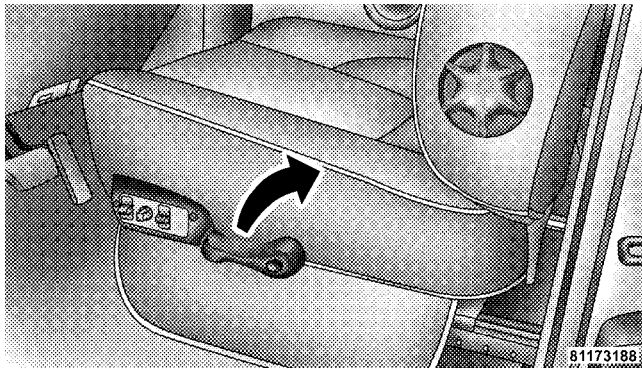

### WARNING!

**You can be seriously, even fatally injured riding in a seat with the seatback reclined. Do not ride with the seatback reclined so that the shoulder belt is no longer resting against your chest. If you ride in this position, the shoulder harness will no longer be restraining you. In a collision you could slide under the seat belt and receive serious or fatal injuries. Recline in a seat only when the vehicle is parked.**

### Adjustable Head Restraints

Head restraints can reduce the risk of whiplash injury in the event of impact from the rear. Pull up or push down on the restraints so that the upper edge is as high as practical, at least to the level of the ears.

To lower the head restraint, push in the button and then push down on the head restraint.

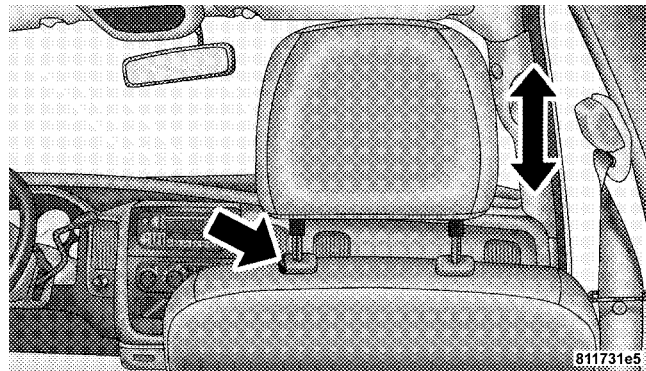

### Manual Rotary Lumbar Support Adjustment — If Equipped

Rotating the lumbar control knob on the left side of the driver's seatback and on the right side of the passenger's seatback increases or decreases the lumbar support.

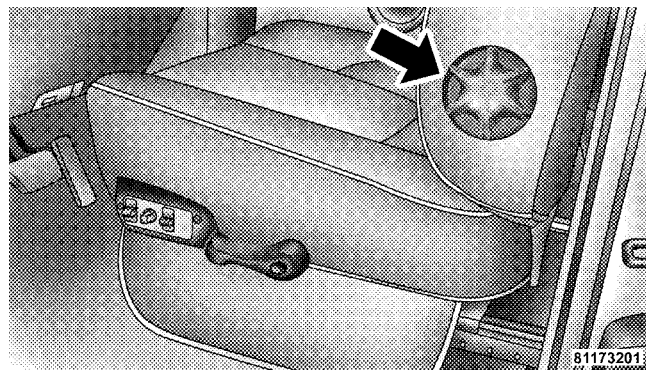

3

Manual Lumbar Adjustment

## Power Seats — If Equipped

### CAUTION!

Don't put anything under a power seat. It may cause damage to the seat controls.

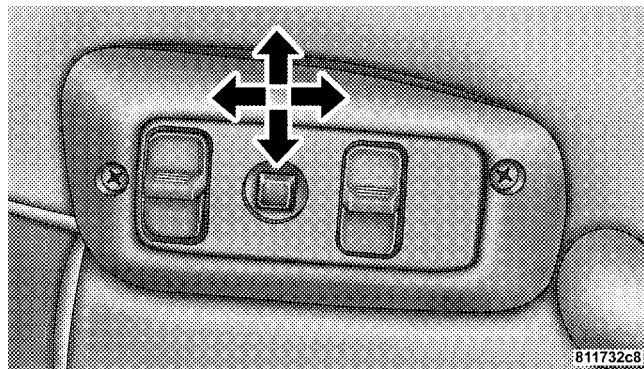
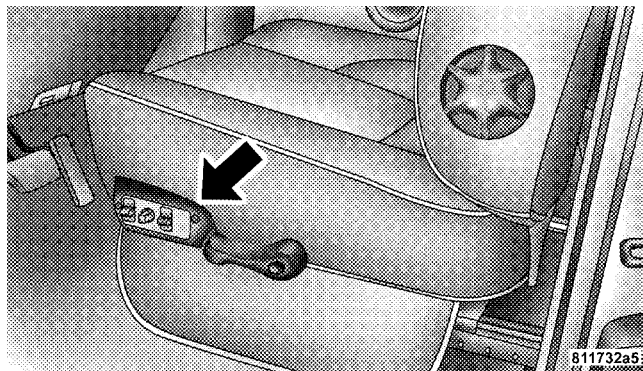

Up, Down, Forward, and Rearward

The power seat controls are on the outboard side of the front seat cushions. Three switches control the seat movement. The four-way switch in the center can be moved forward or backwards to get the most comfortable position. The same switch can be moved up and down to

control seat height. Change the seat angle by using the two toggle switches, tilting it up or down.

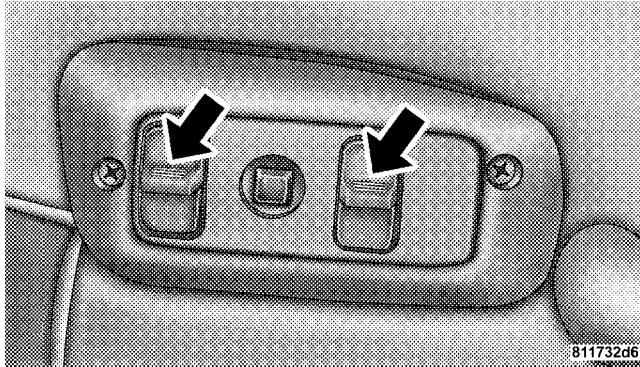

Tilt Adjustment

### Heated Seats — If Equipped

The heated seat switches are located in the instrument panel under the climate controls.

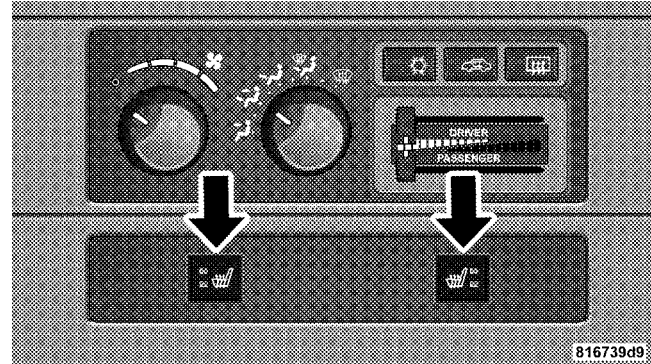

Heated Seat Switches

Each heated seat switch has two settings (HI and LOW). Press the switch once to obtain High heat level, then press the switch again to obtain Low heat level. Pressing

the switch a third time will turn the heated seats OFF. If you do not purposefully turn the switch OFF, the seat heating level will automatically change to the next lower level, or OFF. The High heat level operates for 30 minutes (approximate), the Low heat level operates for 30 minutes (approximate). The seat heat will also turn OFF when the ignition is turned OFF. Both of the indicators ON identifies High heat level. The lower indicator On only, identifies Low heat level. Flashing indicator lights on the switch indicate that the Heated Seat System needs servicing.

**WARNING!**

**Persons who are unable to feel pain to the skin because of advanced age, chronic illness, diabetes, spinal cord injury, medication, alcohol use, exhaustion or other physical condition must exercise care when using the seat heater. It may cause burns even at low temperatures, especially if used for long periods of time.**

**Do not place anything on the seat that insulates against heat, such as a blanket or cushion. This may cause the seat heater to overheat.**

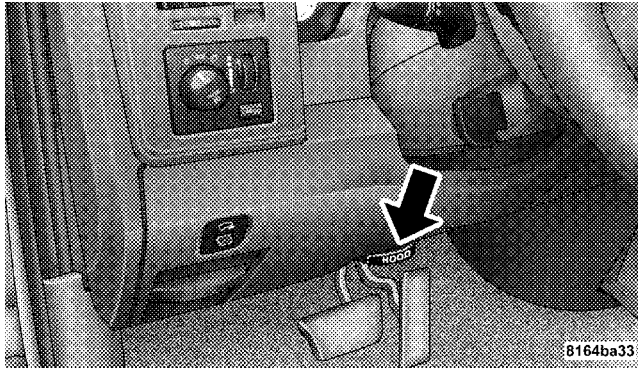
**TO OPEN AND CLOSE THE HOOD****Hood Release Lever**

To open the hood, two latches must be released. First pull the hood release lever located below the steering wheel at the base of the instrument panel. Once the hood is

released you must reach into the opening beneath the center of the grille and push up the latch to release the safety catch before raising the hood.

To prevent possible damage, do not slam the hood to close it. Use a firm downward push at the front center of the hood to ensure that both latches engage.

3

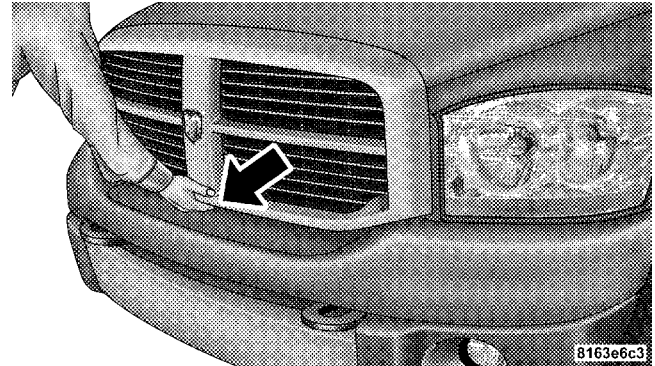
**Secondary Latch**

**WARNING!**

If the hood is not fully latched, it could fly up when the vehicle is moving and block your forward vision. Be sure all hood latches are latched fully before driving.

**LIGHTS**

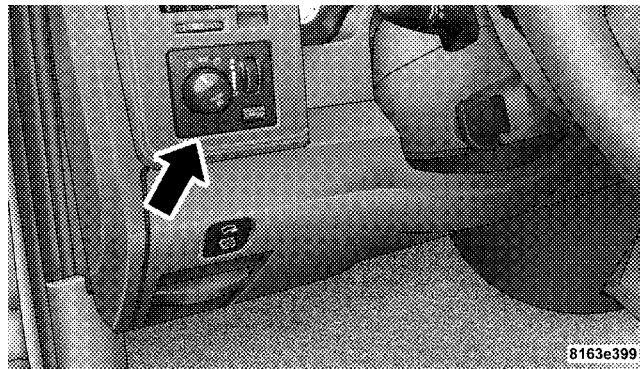

**Headlight Switch Location**

## Interior Lights

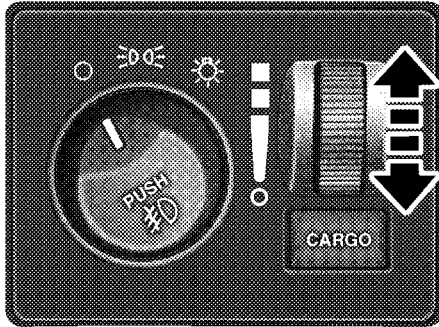

81482f6a

### Dimmer Control

Courtesy and dome lights are turned on when the front doors are opened, when the dimmer control (rotating wheel on the right side of the switch) is rotated to the upward detent position, or if equipped, when the UNLOCK button is pressed on the key fob. When a door is

open and the interior lights are on, rotating the dimmer control all the way down to the OFF detent will cause all the interior lights to go out. This is also known as the "Party" mode because it allows the doors to stay open for extended periods of time without discharging the vehicle's battery.

3

The brightness of the instrument panel lighting can be regulated by rotating the dimmer control up (brighter) or down (dimmer). When the headlights are ON you can supplement the brightness of the odometer, trip odometer, radio and overhead console by rotating the control up until you hear a click. This feature is termed the "Parade" mode and is useful when headlights are required during the day.

Club Cab/Quad Cab models may have an optional switched dome lamp that may be operated by pressing the lens.



### Battery Saver

To protect the life of your vehicle's battery, Load Shedding is provided for both the interior and exterior lights.

If the ignition is off and any door is left ajar for 10 minutes or the dimmer control is rotated upwards for 10 minutes, the interior lights will automatically turn off.

If the headlamps remain on while the ignition is cycled off, the exterior lights will automatically turn off after 8 minutes. If the headlamps are turned on and left on for 8 minutes while the ignition is off, the exterior lights will automatically turn off.

**NOTE:** Battery Saver mode is cancelled if the ignition is ON.

### Headlamp Delay

To aid in your exit, your vehicle is equipped with a headlamp delay that will leave the headlamps on for 90 seconds. This delay is initiated when the ignition is turned OFF while the headlamp switch is on, and then the headlamp switch is cycled off. Headlamp delay can be cancelled by either turning the headlamp switch ON then OFF or by turning the ignition ON.

### Headlights, Parking Lights, Panel Lights



When the headlight switch is rotated to the first position, the parking lights, taillights, side marker lights, license plate light and instrument panel lights are all turned on. The headlights will turn ON when the switch is rotated to the second position.

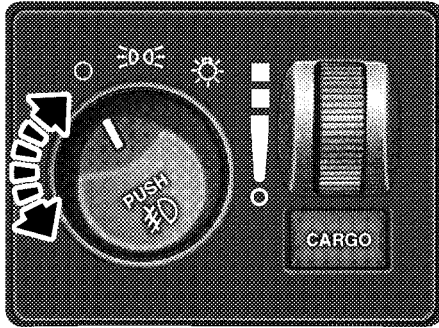

### Light Switch Rotation

Your vehicle is equipped with plastic headlight lenses that are lighter and less susceptible to stone breakage than glass headlights.

Plastic is not as scratch resistant as glass and therefore different lens cleaning procedures must be followed.

81482f22

To minimize the possibility of scratching the lenses and reducing light output, avoid wiping with a dry cloth. To remove road dirt, wash with a mild soap solution followed by rinsing.

Do not use abrasive cleaning components, solvents, steel wool or other abrasive materials to clean the lenses.

### Daytime Running Lights (Canada Only and Fleet Vehicles)

The headlights on your vehicle will illuminate when the engine is started and the transmission is in any gear except park. This provides a constant "Lights ON" condition until the ignition is turned OFF. The lights illuminate at less than 50% of normal intensity. If the parking brake is applied the Daytime Running Lights will turn off.

### Lights-on Reminder

If the headlights, parking lights, or cargo lights are left on, after the ignition is turned off, a chime will sound when the driver's door is opened.

### Fog Lights — If Equipped

 The foglights are turned ON by placing the headlight rotary control in the parking light or headlight position and pushing in the headlight rotary control. The fog lights will operate only when the parking lights are ON or when the vehicle headlights are ON low beam. An indicator light located in the instrument cluster will illuminate when the fog lights are on. The fog lights will turn off when the switch is pushed a second time, when the headlight switch is rotated to the OFF position, or the high beam is selected.

### Cargo Light — If Equipped

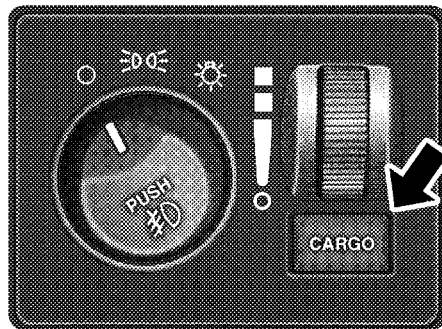

814830fd

### Cargo Light Switch

The cargo lights are turned on by pressing on the CARGO button. The interior lights will also turn on when the cargo lights are on. The cargo lights will also turn on for 30 seconds when a key fob Unlock is pressed, as part of the illuminated entry feature.

### Multifunction Control Lever

The multifunction control lever is located on the left side of the steering column.

### Turn Signals

Move the lever up or down to signal a right-hand or left-hand turn.

The arrow on either side of the instrument cluster flashes to indicate the direction of the turn, and proper operation of the front and rear turn signal lights. If a defective bulb or wiring circuit is detected for the turn signal system, the arrow indicators will flash at a faster rate. If an indicator fails to light when the lever is moved, it would suggest that the switch or indicator lamp is defective.

You can signal a lane change by moving the lever partially up or down.

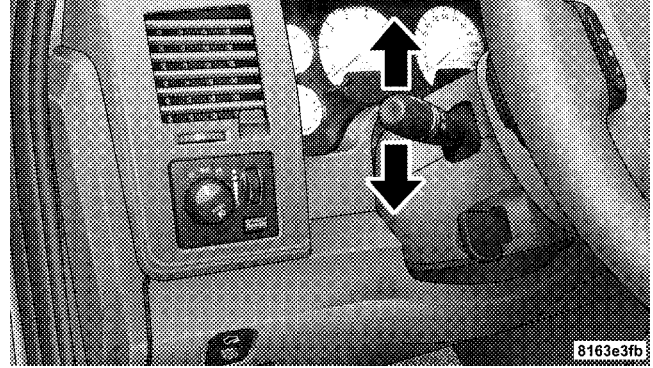

**Turn Signal Lever**

### Turn Signal Auto-Mode

Tap the multi-function control lever once and the turn signal (left or right) will flash 3 times, and automatically turn off.

### **Passing Light**

You can signal another vehicle with your headlights by partially pulling the multifunction lever toward the steering wheel. This will cause the high beam headlights to turn on until the lever is released.

### **High Beam / Low Beam Select Switch**

Pull the multifunction control lever fully toward the steering wheel to switch the headlights from HIGH or LOW beam.

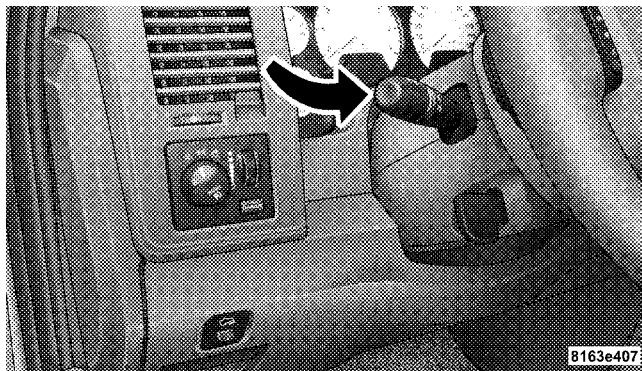

**High Beam / Low Beam**

## WINDSHIELD WIPERS AND WASHERS

### Windshield Wipers

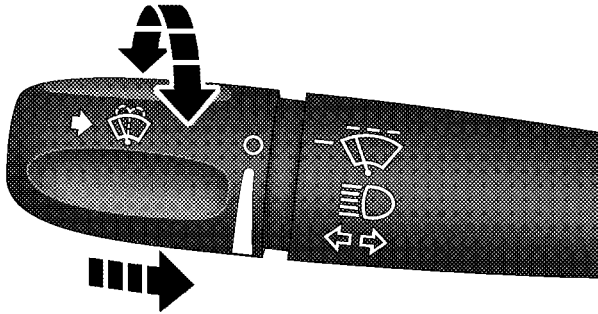

815be820

### Windshield Wiper / Washer Switch

The wipers and washers are operated by a switch in the multifunction control lever. Turn the end of the handle to select the desired wiper speed.

### Intermittent Wiper System

The intermittent feature of this system was designed for use when weather conditions make a single wiping cycle, with a variable pause between cycles, desirable. For maximum delay between cycles, rotate the control knob into the upper end of the delay range.

The delay interval decreases as you rotate the knob until it enters the LOW continual speed position. The delay can be regulated from a maximum of about 15 seconds between cycles, to a cycle every 2 seconds. The delay intervals will double in duration when the vehicle speed is 10 mph (16 km) or less.

**WARNING!**

**Sudden loss of visibility through the windshield could lead to an accident. You might not see other vehicles or other obstacles. To avoid sudden icing of the windshield during freezing weather, warm the windshield with defroster before and during windshield washer use.**

**Windshield Washers**

To use the washer, push in on the washer knob on the end of the multifunction control lever and hold while spray is

desired. If the washer knob is depressed while in the delay range, the wiper will operate for several seconds after the washer knob is released. It will then resume the intermittent interval previously selected. If the washer knob is pushed, for a period greater than 1 second, while in the OFF position, the wiper will wipe approximately three wipes, after the wash knob is released.

To prevent freeze-up of your windshield washer system in cold weather, select a solution or mixture that meets or exceeds the temperature range of your climate. This rating information can be found on most washer fluid containers.

## TILT STEERING COLUMN

To tilt the column, pull rearward on the lever below the turn signal control and move the wheel up or down, as desired. Push the lever forward to lock the column firmly in place.

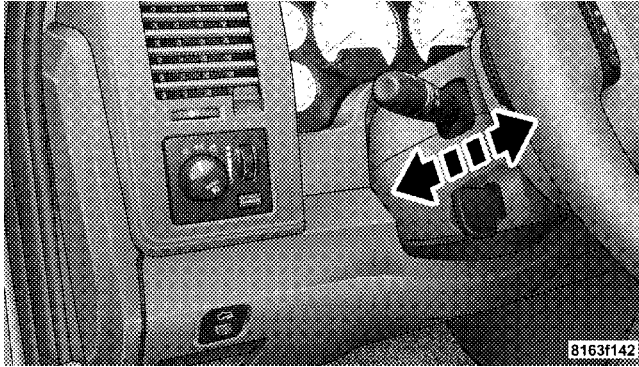

Tilt Steering Control Lever

## WARNING!

Tilting the steering column while the vehicle is moving is dangerous. Without a stable steering column, you could lose control of the vehicle and have an accident. Adjust the column only while the vehicle is stopped. Be sure it is locked before driving.



**ELECTRONIC SPEED CONTROL — IF EQUIPPED**

When engaged, this device takes over accelerator operation at speeds greater than (refer to the table below for the speed for your specific engine). The controls are mounted on the steering wheel.

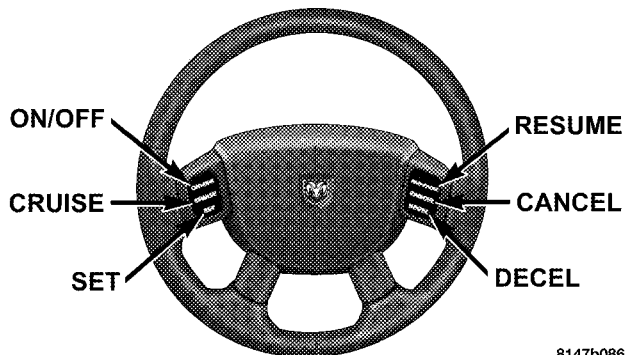

8147b086

**To Activate**

Push the ON/OFF button to the ON position. In the instrument cluster, the word “CRUISE” illuminates when the system is on.

**To Set At A Desired Speed**

When the vehicle has reached the desired speed, press and release the SET button. Release the accelerator and the vehicle will operate at the selected speed.

**To Deactivate**

A soft tap on the brake pedal, normal braking, clutch pressure while slowing the vehicle, or pressing the CANCEL button will deactivate speed control without erasing the memory. Pushing the ON/OFF button to the OFF position or turning off the ignition erases the memory.

**WARNING!**

**Leaving the Speed Control ON when not in use is dangerous. You could accidentally set the system to cause it to go faster than you want. You could lose control and have an accident. Always leave the system OFF when you aren't using it.**

**To Resume Speed**

To resume a previously set speed, push and release the RESUME button. Resume can be used at any speed above (refer to the table below for the speed for your specific engine).

**To Vary The Speed Setting**

When the speed control is on, speed can be increased by pressing and holding the ACCEL button. When the button is released, a new set speed will be established.

Tapping the ACCEL button once will result in a speed increase (refer to the table below for the speed for your specific engine). Each time the button is tapped, speed increases so that tapping the button three times will increase speed by three increments.

Tapping the DECEL button once will result in a speed decrease (refer to the table below for the speed for your specific engine). Each time the button is tapped, speed will decrease. For example, tapping the button 3 times will decrease the speed by 3 times the speed listed in the table below (refer to the table below for the speed for your specific engine).

To decrease speed while the speed control is on, press and hold the DECEL button. Release the button when the desired speed is reached, and the new speed will be set.

Functions	5.7L Engine
Engage Speed	25 mph (40 km/h)
Minimum RESUME Speed	20 mph (32 km/h)
ACCEL Increase	1 mph (2 km/h)
DECEL Decrease	1 mph (2 km/h)
Dropout Speed	20 mph (32 km/h)

### To Accelerate For Passing

Depress the accelerator as you would normally. When the pedal is released, the vehicle will return to the set speed.

**NOTE:** When driving uphill, at elevations above 2,000 feet (610 meters), or when the vehicle is heavily loaded (especially when towing) the vehicle may slow below the SET speed. If the vehicle speed drops below (refer to the table below for the speed for your specific engine), the speed control will automatically disengage. If this happens, you can push down on the accelerator pedal to maintain the desired speed.

Vehicles equipped with a 5-speed-manual transmission should be operated in 4th gear or lower under the above conditions.

Vehicles equipped with a Automatic transmission may exhibit several downshifts under the above conditions. To reduce the frequency of the downshifts and to improve vehicle performance, it is advisable to lock out overdrive by pressing the “TOW/HAUL” button located at the end of the gear shifter.

**WARNING!**

Speed Control can be dangerous where the system can't maintain a constant speed. Your vehicle could go too fast for the conditions, and you could lose control. An accident could be the result. Don't use Speed Control in heavy traffic or on roads that are winding, icy, snow-covered, or slippery.

**OVERHEAD CONSOLE— IF EQUIPPED**

The two optional overhead consoles may consist of the following features:

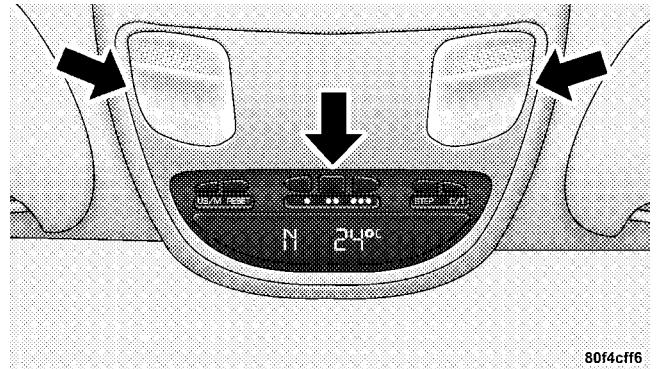

3

**Overhead Console Features**

- Courtesy/Reading Lights
- Compass/Temperature Mini-Trip Computer (CMTC)  
— If Equipped
- Universal Garage Door Opener — If Equipped

### Courtesy/Reading Lights

In the middle of the console are two courtesy/reading lights.

Both lights illuminate as courtesy lights when a door is opened, when the dimmer control is rotated to the courtesy light position (fully upward position), or when the UNLOCK button is pressed on the Remote Keyless Entry transmitter, if so equipped. These lights are also operated individually as reading lights by pressing the recessed area of the corresponding lens.

**NOTE:** The courtesy/reading lights will remain on until the switch is pressed a second time, so be sure they have been turned off before leaving the vehicle. If the interior lights are left on after the vehicle is turned off, they will extinguish after 15 minutes.

### OVERHEAD CONSOLE WITH COMPASS/TEMPERATURE MINI-TRIP COMPUTER — IF EQUIPPED

This optional overhead console consists of the following:

- Courtesy Lights
- Compass/Temperature Mini-Trip Computer (CMTC)

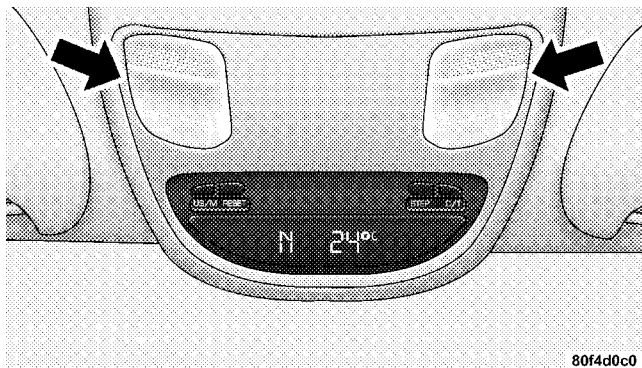

80f4d0c0

This overhead console allows you to choose between a compass/temperature display and one of four trip conditions being monitored.

### US/M Button

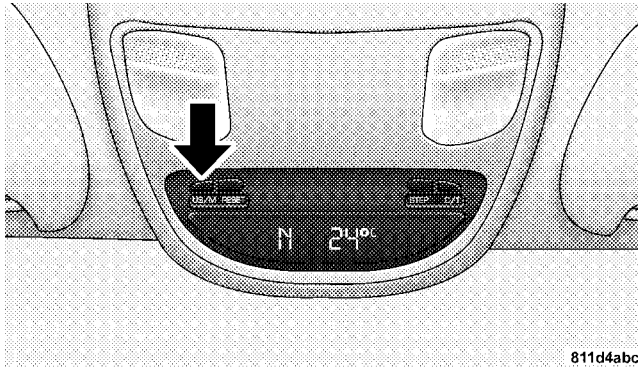

Use this button to change the display from U.S. to metric measurement units.

### RESET Button

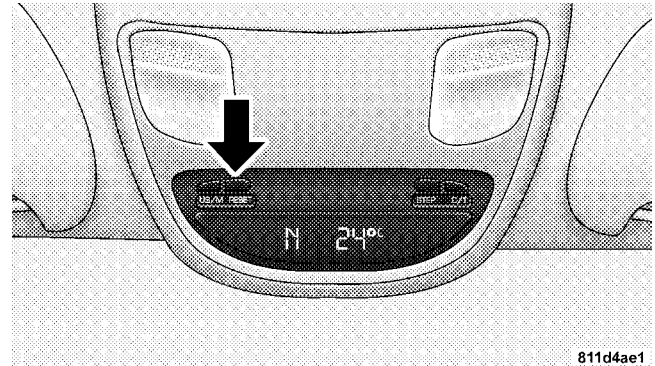

Use this button to reset the following displays:

- Average Fuel Economy (AVG ECO)
- Trip Odometer (ODO)
- Elapsed time (ET)

### Global Reset

If the RESET button is pressed twice within 2 seconds while in any of the 3 resettable displays (AVG ECO, ODO, ET), the Global Reset will reset all 3 displays.

### Step Button

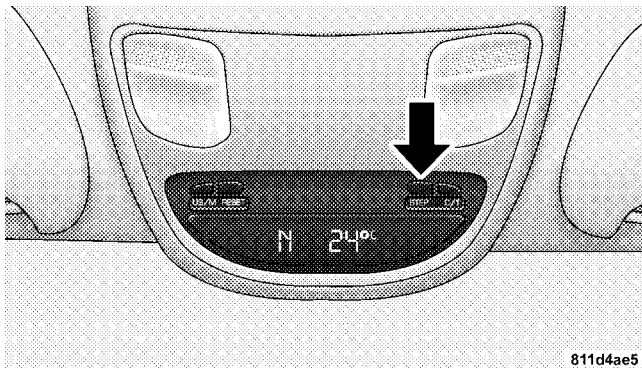

Use this button to choose or cycle through the four trip conditions.

### Average Fuel Economy (AVG ECO)

Shows the average fuel economy since the last reset. Average fuel economy is a running average of the amount of fuel used and the distance the vehicle has traveled.

When the fuel economy is reset, the display will momentarily blank. Then, the history information will be erased, and the averaging will continue from where it was before the reset.

### Distance To Empty (DTE)

Shows the estimated distance that can be traveled with the fuel remaining in the tank. This estimated distance is determined by weighted average of the instantaneous and average fuel economy, according to the current fuel tank level. This is not resettable

**NOTE:** Significant changes in driving style or vehicle loading will greatly affect the actual drivable distance of the vehicle, regardless of the DTE displayed value.

When the DTE value is less than 30 miles estimated driving distance, the DTE display will change to an alternating test display of “LO” and “FUEL”. This display will continue until the vehicle runs out of fuel. Adding a significant amount of fuel to the vehicle will turn off the “LO FUEL” text and a new DTE value will be displayed, based on the current values in the DTE calculation and the current fuel tank level.

**NOTE:** It is possible for DTE to display “LO FUEL” before the low fuel warning light turns on in the instrument cluster. This could occur because low fuel warning is set to a specified fuel tank volume and DTE is an estimated distance calculation based on fuel economy and remaining fuel tank volume.

***Ram fuel tank volumes are as follows:***

- 34 gallons - short box models
- 35 gallons - long box models

### **Trip Odometer (ODO)**

This display shows the distance traveled since the last reset. Resetting of this screen will cause the trip odometer to change to Zero.

### **Elapsed Time (ET)**

This display shows the accumulated ignition ON time since the last reset. Resetting the Elapsed Time will cause the display to change to Zero.



### C/T Button

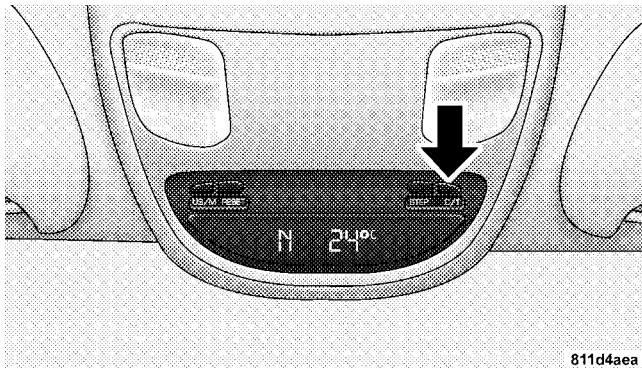

Use this button to select a readout of the outside temperature and one of eight compass headings that indicate the direction in which the vehicle is facing.

### WARNING!

Even if the display still reads a few degrees above 32°F ( 0°C), the road surface may be icy, particularly in woods or on bridges. Drive carefully under such conditions to prevent an accident and possible personal injury or property damage.

### Automatic Compass Calibration

This compass is self-calibrating which eliminates the need to manually set the compass. When the vehicle is new, the compass may appear erratic and the CAL symbol will be displayed.

After completing up to three 360° turns, with the vehicle traveling less than 5 mph (8 km/h), in an area free from large metal or metallic objects, the CAL symbol will turn off and the compass will function normally.

## Manual Compass Calibration

**NOTE:** To ensure proper compass calibration, make sure the compass variance is properly set before manually calibrating the compass.

If the compass appears erratic and the CAL symbol does not appear, you must manually put the compass into the “Calibration” mode.

### Recalibrating The Compass

Turn on the ignition and set the display to “Compass/Temperature.” Press and hold the RESET button to change the display between VAR (compass variance) and CAL (compass calibration) modes. When the CAL symbol is displayed complete one 360° turn in an area free from large metal objects or power lines. The CAL symbol will turn off and the compass will function normally.

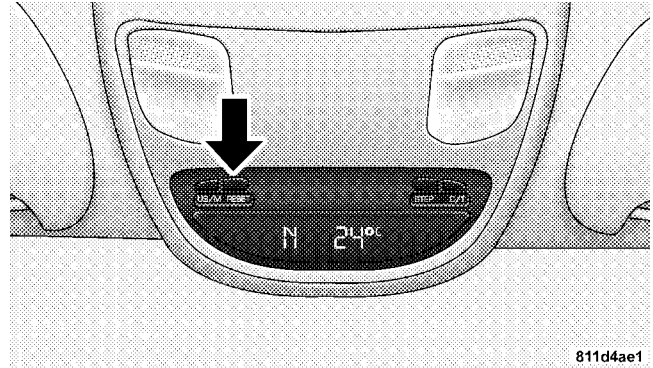

**Compass Variance** is the difference between magnetic north and geographic north. In some areas of the country, the difference between magnetic and geographic north is great enough to cause the compass to give false readings. If this occurs, the compass variance must be set according to the Compass Variance Map.

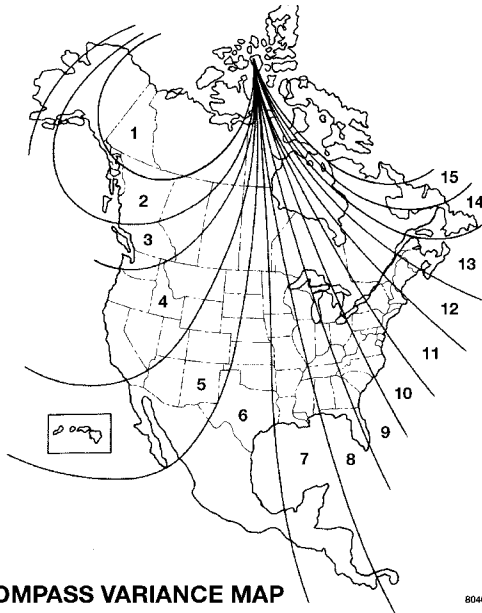

**NOTE:** The default for the compass variance is zone 8.

To set the variance: Turn the ignition ON and set the display to “Compass/Temperature.” Press and hold the RESET button approximately five seconds. The last variance zone number will be displayed. Press the STEP button to select the new variance zone and press the RESET button to resume normal operation.

### Outside Temperature

Because the ambient temperature sensor is located underhood, engine temperature can influence the displayed temperature, therefore, temperature readings are slowly updated when the vehicle speed is below 20 mph (30 km/h) or during stop and go driving.

### **GARAGE DOOR OPENER — IF EQUIPPED**

The HomeLink® Universal Transceiver replaces up to three remote controls (hand held transmitters) that operate devices such as garage door openers, motorized gates, or home lighting. It triggers these devices at the push of a button. The Universal Transceiver operates off your vehicle's battery and charging system; no batteries are needed.

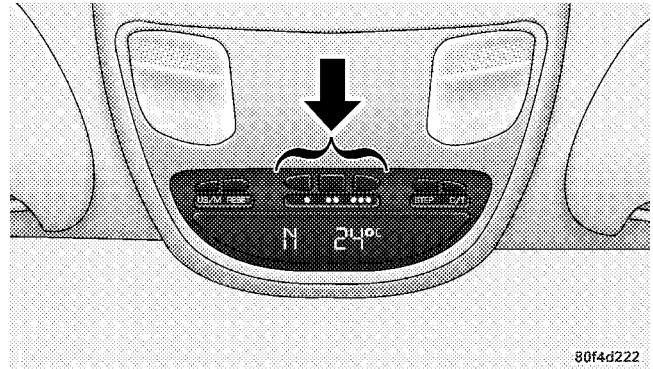

3

### **HomeLink® Programming Buttons**

For additional information on HomeLink®, call 1-800-355-3515, or on the internet at [www.homelink.com](http://www.homelink.com).

**WARNING!**

A moving garage door can cause injury to people and pets in the path of the door. People or pets could be seriously or fatally injured. Only use this transceiver with a garage door opener that has a “stop and reverse” feature as required by federal safety standards. This includes most garage door opener models manufactured after 1982. Do not use a garage door opener without these safety features it could cause injury or death. Call toll-free 1-800-355-3515 or, on the Internet at [www.homelink.com](http://www.homelink.com) for safety information or assistance.

**WARNING!**

Vehicle exhaust contains carbon monoxide, a dangerous gas. Do not run the vehicle’s exhaust while training the transceiver. Exhaust gas can cause serious injury or death.

**WARNING!**

Your motorized door or gate will open and close while you are training the Universal Transceiver. Do not train the transceiver if people or pets are in the path of the door or gate. A moving door or gate can cause serious injury or death to people and pets or damage to objects.

## Programming HomeLink

**NOTE:** When programming a garage door opener, it is advised to park outside the garage. It is also recommended that a new battery be placed in the hand-held transmitter of the device being programmed to HomeLink for quicker training and accurate transmission of the radio-frequency signal.

1. Press and hold the two outer HomeLink buttons, and release only when the indicator light begins to flash (after 20 seconds). **Do not** hold the buttons for longer than 30 seconds and **do not** repeat step one to program a second and/or third hand-held transmitter to the remaining two HomeLink buttons.

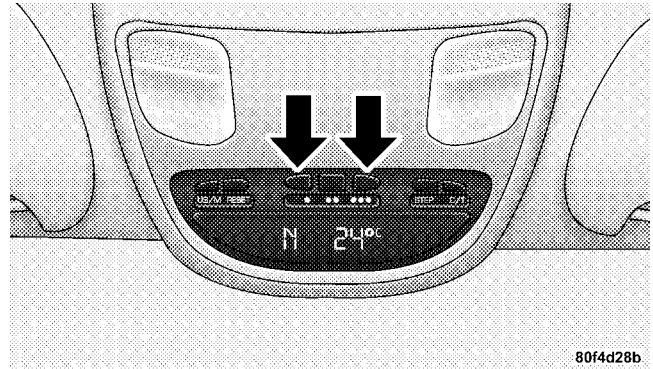

**Outer HomeLink buttons**

2. Position the end of your hand-held transmitter 1-3 inches (3-8 cm) away from the HomeLink buttons while keeping the indicator light in view.

3. Simultaneously press and hold both the HomeLink button that you want to train and the hand-held transmitter buttons. **Do not release the buttons until step 4 has been completed.**

**NOTE:** Some gate operators and garage door openers may require you to replace this Programming Step 3 with procedures noted in the "Gate Operator/Canadian Programming" section.

4. The HomeLink indicator light will flash slowly and then rapidly after HomeLink successfully receives the frequency signal from the hand-held transmitter. Release both buttons after the indicator light changes from the slow to the rapid flash.

5. Press and hold the just trained HomeLink button and observe the indicator light. If the indicator light **stays on constantly, programming is complete** and your device should activate when the HomeLink button is pressed and released.

**NOTE:** To program the remaining two HomeLink buttons, begin with "Programming" **step two. Do not repeat step one.**

If the indicator light blinks **rapidly for two seconds and then turns to a constant light, continue with "Programming" steps 6-8** to complete the programming of a rolling code equipped device (most commonly a garage door opener).

6. At the garage door opener receiver (motor-head unit) in the garage, locate the "learn" or "smart" button. This can usually be found where the hanging antenna wire is attached to the motor-head unit.

7. Firmly press and release the "learn" or "smart" button. (The name and color of the button may vary by manufacturer.)

**NOTE:** There are 30 seconds in which to initiate step eight.

8. Return to the vehicle and firmly **press, hold for two seconds and release** the programmed HomeLink button. Repeat the "**press/hold/release**" sequence a second time, and, depending on the brand of the garage door opener (or other rolling code equipped device), repeat this sequence a third time to complete the programming.

HomeLink should now activate your rolling code equipped device.

**NOTE:** To program the remaining two HomeLink buttons, begin with "Programming" **step two. Do not repeat step one.** For questions or comments, please contact HomeLink at [www.homelink.com](http://www.homelink.com) or 1-800-355-3515.

### **Canadian Programming/Gate Programming**

Canadian radio-frequency laws require transmitter signals to "time-out" (or quit) after several seconds of transmission which may not be long enough for HomeLink to pick up the signal during programming.

Similar to this Canadian law, some U.S. gate operators are designed to "time-out" in the same manner.

If you live in Canada or you are having difficulties programming a gate operator by using the "Programming" procedures (regardless of where you live), **replace "Programming HomeLink" step 3** with the following:

**NOTE:** If programming a garage door opener or gate operator, it is advised to unplug the device during the "cycling" process to prevent possible overheating.

3. Continue to press and hold the HomeLink button while you **press and release every two seconds** ("cycle") your hand-held transmitter until the frequency signal has successfully been accepted by HomeLink. (The indicator light will flash slowly and then rapidly.) Proceed with "Programming" step four to complete.



### Using HomeLink

To operate, simply press and release the programmed HomeLink button. Activation will now occur for the trained device (i.e. garage door opener, gate operator, security system, entry door lock, home/office lighting, etc.). For convenience, the hand-held transmitter of the device may also be used at any time. In the event that there are still programming difficulties or questions, contact HomeLink at: **www.homelink.com or 1-800-355-3515**.

### Erasing HomeLink Buttons

To erase programming from the three buttons (individual buttons cannot be erased but can be "reprogrammed" - note below), follow the step noted:

- Press and hold the two outer HomeLink buttons until the indicator light begins to flash-after 20 seconds. Release both buttons. Do not hold for longer that 30

seconds. HomeLink is now in the train (or learning) mode and can be programmed at any time beginning with "Programming" - step 2.

### Reprogramming a Single HomeLink Button

To program a device to HomeLink using a HomeLink button previously trained, follow these steps:

1. Press and hold the desired HomeLink button. **DO NOT** release the button.
2. The indicator light will begin to flash after 20 seconds. Without releasing the HomeLink button, proceed with "Programming" step 2

For questions or comments, contact HomeLink at: **www.homelink.com or 1-800-355-3515**.

**Security**

If you sell your vehicle, be sure to erase the frequencies.

To erase all of the previously trained frequencies, hold down both outside buttons until the green light begins to flash.

This device complies with part 15 of FCC rules and with RSS-210 of Industry Canada. Operation is subject to the following conditions:

- This device may not cause harmful interference.
- This device must accept any interference that may be received including interference that may cause undesired operation.

**NOTE:** Changes or modifications not expressly approved by the party responsible for compliance could void the user's authority to operate the equipment.

HomeLink® is a trademark owned by Johnson Controls, Inc.

**POWER SUNROOF — IF EQUIPPED**

The power sunroof switch is located between the sun visors on the overhead console.

**NOTE:** The Power Accessory Delay feature will allow the power sunroof to operate for ten minutes after the ignition is turned off.

**WARNING!**

- **Never leave children alone in a vehicle. Leaving children in a vehicle unattended is dangerous for a number of reasons. A child or others could be seriously or fatally injured. Don't leave the keys in the ignition. A child could operate power windows, other controls, or move the vehicle.**
- **In an accident, there is a greater risk of being thrown from a vehicle with an open sunroof. You could also be seriously injured or killed. Always fasten your seat belt properly and make sure all passengers are properly secured too.**
- **Do not allow small children to operate the sunroof. Never allow fingers or other body parts, or any object to project through the sunroof opening. Injury may result.**

**Open Sunroof - Express Mode**

Momentarily pressing the switch rearward will activate the Express Open Feature, causing the sunroof to open automatically. During the Express Open operation, any movement of the switch will stop the sunroof and it will remain in a partial open position. Again, momentarily pressing the switch rearward will activate the Express Open Feature.

**Comfort Stop**

The sunroof is equipped with an intermediate "Comfort Stop" position. This is the first stop that express open reaches. This is designed to reduce wind buffeting at vehicle speeds between 20 - 40 mph (32 - 64 km/h). Pressing the switch momentarily rearward again will open the sunroof to its full open position however wind buffeting can occur at full open.

**Closing Sunroof - Express**

Press the switch forward and release, and the sunroof will close automatically from any position. The sunroof will close fully and stop automatically. This is called Express Close. During Express Close operation, any movement of the switch will stop the sunroof.

**Pinch Protect Feature**

This feature will detect an obstruction in the opening of the sunroof during Express Close operation. If an obstruction in the path of the sunroof is detected, the sunroof will automatically retract. Remove the obstruction if this occurs. Next, press the switch forward and release to Express Close.

**Pinch Protect Override**

If a known obstruction (ice, debris, etc.) prevents closing, press the switch forward and hold for two seconds after the reversal occurs. This allows the sunroof to move towards the closed position.

**NOTE:** Pinch protection is disabled while the switch is pressed.

**Venting Sunroof - Express**

Press and release the "V" button, and the sunroof will open to the vent position. This is called Express Vent, and will occur regardless of sunroof position. During Express Vent operation, any movement of the switch will stop the sunroof.

**Sunshade Operation**

The sunshade can be opened manually. However, the sunshade will open automatically as the sunroof opens.

**NOTE:** The sunshade cannot be closed if the sunroof is open.

**Wind Buffeting**

Wind buffeting can be described as the perception of pressure on the ears or a helicopter type sound in the ears. Your vehicle may exhibit wind buffeting with the windows down, or the sunroof (if equipped) in certain open or partially open positions. This is a normal occurrence and can be minimized. If the buffeting occurs with the rear windows open, open the front and rear windows together to minimize the buffeting. If the buffeting occurs with the sunroof open, adjust the sunroof opening to minimize the buffeting or open any window.

**Sunroof Maintenance**

Use only a non-abrasive cleaner and a soft cloth to clean the glass panel.

**Sunroof Fully Closed**

Press the switch forward and release to ensure that the sunroof is fully closed.

**ELECTRICAL POWER OUTLETS**

The auxiliary electrical outlet can provide power for in cab accessories designed for use with the standard “cigar lighter” plug. The outlet is located in the instrument panel below and to the right of the Climate Control Panel. A cap is attached to the outlet base indicating “Power Outlet” 12V-20A.

There is an additional Power Outlet in the center console of a 40/20/40 seat (if equipped).

The outlet(s) has/have a fused direct feed from the battery so it/they receive power whether the ignition is ON or OFF.

All accessories connected to this/these outlet(s) should be removed or turned OFF when the vehicle is not in use to protect the battery against discharge.

**NOTE:** If desired, all of the power outlets can be converted by your authorized dealer to provide power with the ignition switch in the ON position only.

### **CAUTION!**

#### **Electrical Outlet Use With Engine Off**

- Many accessories that can be plugged in draw power from the vehicle's battery, even when not in use (i.e. cellular phones, etc.). Eventually, if plugged in long enough, the vehicle's battery will discharge sufficiently to degrade battery life and/or prevent engine starting.
- Accessories that draw higher power (i.e. coolers, vacuum cleaners, lights, etc.), will discharge the battery even more quickly. Only use these intermittently and with greater caution.
- After the use of high power draw accessories, or long periods of the vehicle not being started (with accessories still plugged in), the vehicle must be driven a sufficient length of time to allow the generator to recharge the vehicle's battery.

### CIGAR LIGHTER AND ASH RECEIVER

The removable ash receiver is located in the instrument panel cup holder tray.

The cigar lighter is located on the instrument panel, above and to the left of the ash receiver.

As a child safety precaution, the lighter only operates with the ignition switch ON. It heats when pushed in and pops out automatically when ready for use. **To preserve the heating element, do not hold the lighter in the heating position.**

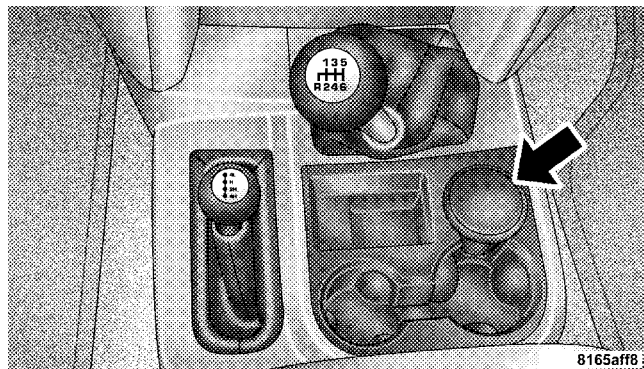

## CUPHOLDERS

### Front Instrument Panel Cupholders

To secure the cup, place the cup to be held into one of the cup wells and then push the cupholder arm toward the cup until it is held stable.

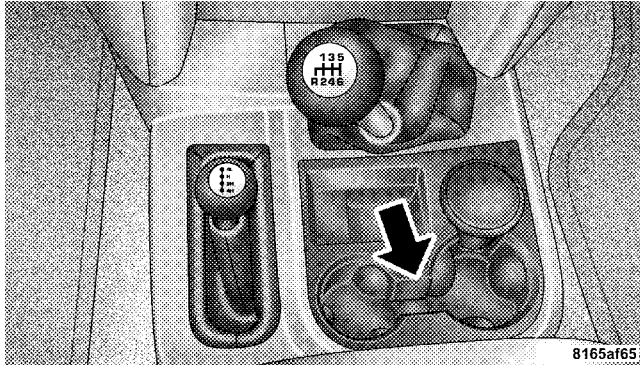

### Rear Cupholder — Quad Cab — If Equipped

Quad Cab vehicles may be equipped with a rear cupholder that consists of two cupwells for rear passenger convenience.



## STORAGE

### Center Storage Compartment — If Equipped

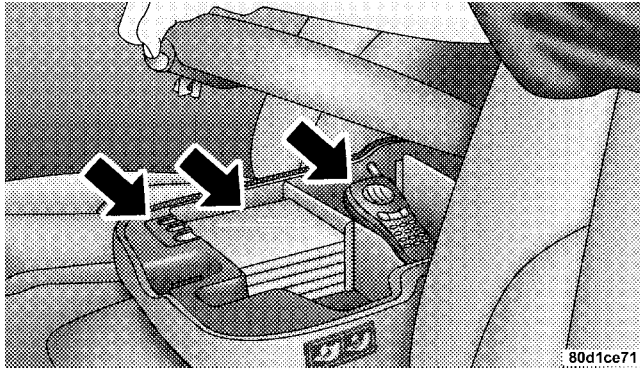

The center portion of the seat folds down to provide an armrest with unique storage compartments under the lid. Push the button on the front of the armrest to raise the cover. Inside there is a power outlet (if equipped), removable coin holder (if equipped), and two dividers to

configure the storage area into compartments. For example, compartments can be configured to hold a lap-top computer, a cellular telephone, CD's and miscellaneous items. The top of the cover provides a generous firm surface to serve as a desktop for your “mobile office.”

### WARNING!

- **This armrest is not a seat. Anyone seated on the armrest could be seriously injured during vehicle operation, or an accident. Only use the center seating position when the armrest is fully upright.**
- **In an accident, the latch may open if the total weight of the items stored exceeds about 10 lbs (4.5 kg). These items could be thrown about endangering occupants of the vehicle. Items stored should not exceed a total of 10 lbs (4.5 kg).**

**Storage and Seats — If Equipped**

Located in the center of the front 40/20/40 seat cushion there is a storage compartment.

Standard cab models also have storage behind the seat.

The Quad Cab models provide additional storage under the rear seat. Lift the seat to access the storage compartment.

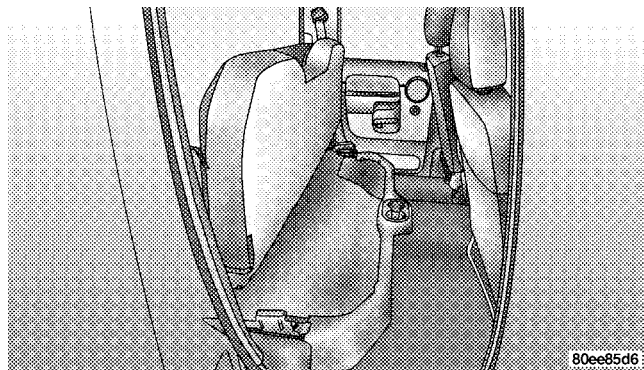

Quad Cab Storage

## REAR WINDOW FEATURES

### Electric Rear Window Defroster and Heated Side view Mirrors — If Equipped

 The Electric Rear Window Defroster and Heated side view mirrors are activated by pressing the heated grid button, located on the Climate Control panel, with the ignition On. Turning Off the ignition will deactivate the Electric Rear Window Defroster and Heated side view mirrors feature. These features also turn off after activation, when 15 minutes have elapsed. To reactivate, simply press the button again.

### Power Sliding Rear Window—If Equipped

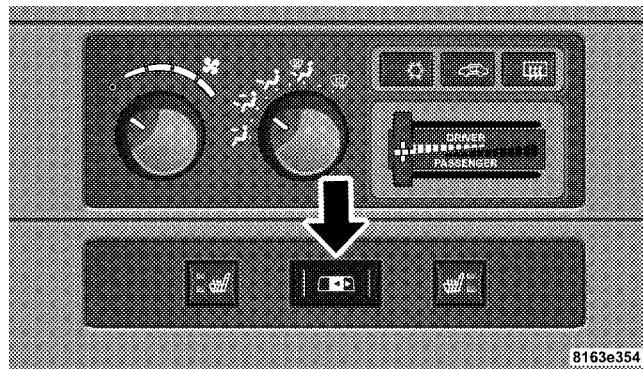

### Power Sliding Rear Window Switch

The power sliding rear window switch is located on the instrument panel below the climate controls. Press the right side of the switch to open the glass and the left side of the switch to close the glass.

**Sliding Rear Window—If Equipped**

A locking device in the center of the window helps to prevent entry from the rear of the vehicle. Squeeze the lock to release the window.

**FOLD FLAT LOAD FLOOR — IF EQUIPPED**

Quad Cab models with a 60/40 rear seat, may be equipped with a folding load floor.

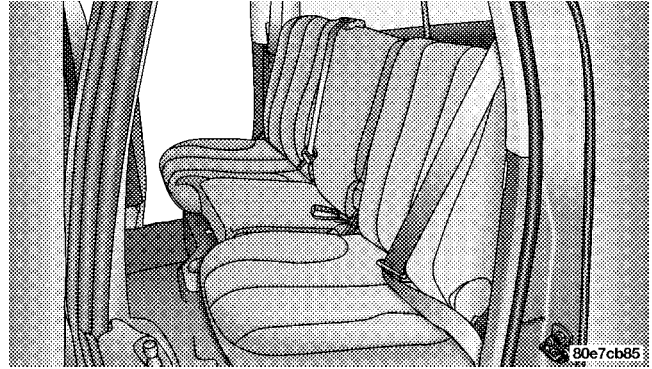

Quad Cab Rear 60/40 Seat

**WARNING!**

Do not operate the vehicle with loose items stored on the load floor. While driving or in an accident you may experience, abrupt stopping, rapid acceleration, or sharp turns. Loose objects stored on the load floor may move around with force and strike occupants, resulting in serious or fatal injury.

*Unfolding the Load Floor*

1. Lift the 60/40 seat cushion(s) to the upward position.

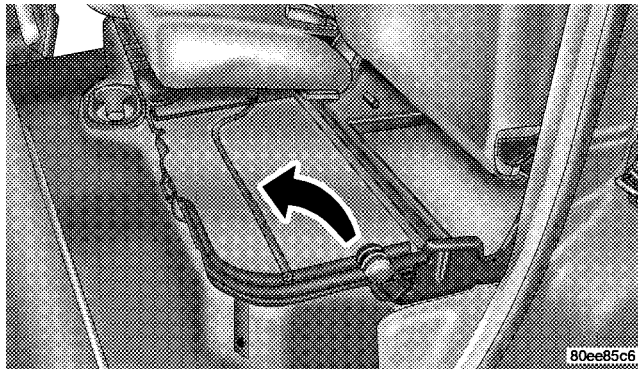

**Unfolding The Load Floor**

2. Grasp the knob on the load floor and lift the knob until the load floor unfolds into position.

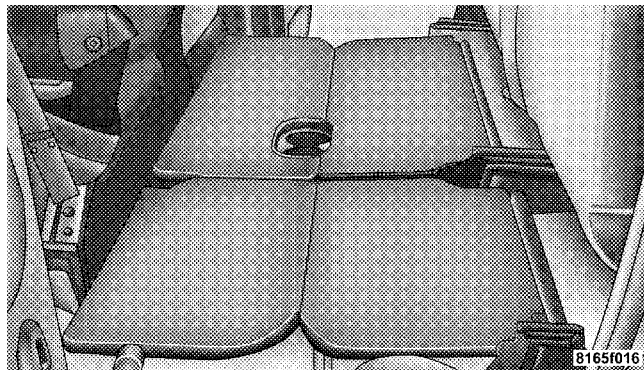

**Load Floor In Open Position**

3. Reverse the procedure to store the load floor.

### ***Positioning the Load Floor for Storage Access Under the Seat***

1. Lift the 60/40 seat cushion(s) to the upward position.
2. Unsnap the securing snap located at either side of the load floor.
3. Lift the load floor up to access storage under the load floor.

**WARNING!**

**Do not drive with the load floor in the up position. When stopping fast or in an accident, the load floor could move to the down position causing serious injury.**

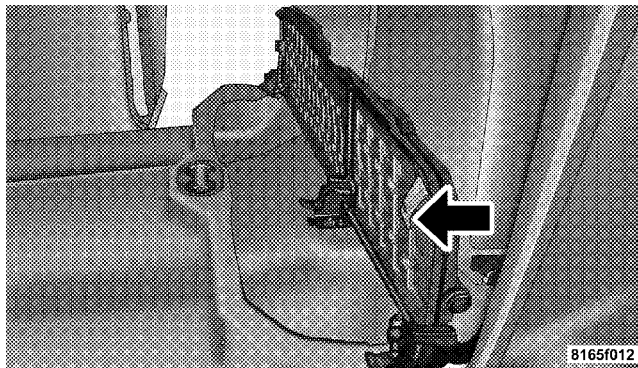

**Load Floor Securing Straps**

4. Reverse the procedure to put the load floor back in the secured down position before you operate the vehicle.

## PICKUP BOX

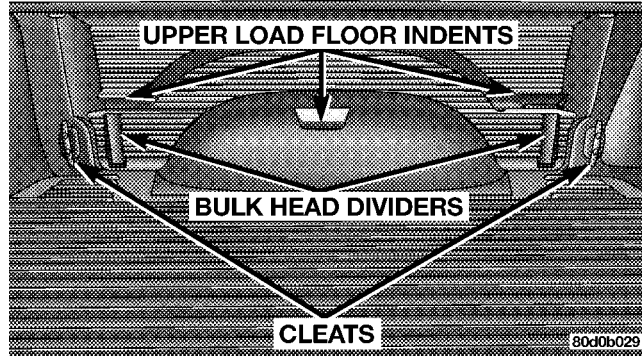

### Pickup Box Features

The pickup box on your new Ram has many features designed for utility and convenience.

**NOTE:** If you are installing a toolbox to the front of the pickup box, you must use Mopar® toolbox brackets available from your dealer.

You can carry wide building materials (sheets of plywood, etc.) by building a raised load floor. Place lumber across the box in the indentations provided above the wheel housings and in the bulkhead dividers to form the floor.

### WARNING!

The pickup box is intended for load carrying purposes only, not for passengers, who should sit in seats and use seat belts.



**WARNING!**

- **Care should always be exercised when operating a vehicle with unrestrained cargo. Vehicle speeds may need to be reduced. Severe turns or rough roads may cause shifting or bouncing of the cargo that may result in vehicle damage. If wide building materials are to be frequently carried, the installation of a support is recommended. This will restrain the cargo and transfer the load to the pickup box floor.**
- **If you wish to carry more than 600 lbs (272 kg) of material suspended above the wheelhouse, supports must be installed to transfer the weight of the load to the pickup box floor or vehicle damage may result. The use of proper supports will permit loading up to the rated payload.**
- **Unrestrained cargo may be thrown forward in an accident causing serious or fatal injury.**

There are stampings in the sheet metal on the inner side bulkheads of the box in front of and behind both wheel housings. Place wooden boards across the box from side to side to create separate load compartments in the pickup box.

There are four tie-down cleats bolted to the lower sides of the pickup box that can sustain loads up to 1000 lbs (450 kg) total.

**SLIDE-IN CAMPERS**

**DO NOT** use slide-in campers on Power Wagon models.

**EASY-OFF TAILGATE**

The tailgate can be removed quickly. Tailgate removal is sometimes required for pickup box loading. To remove the tailgate unlatch the tailgate and remove the support cables by releasing the lock tang from the pivot, then rotate and pull away from the box. Once the cables are free, move to the right side of the tailgate hinge bracket.

Raise the right side of the tailgate until the right side pivot clears the hanger bracket. Slide the entire tailgate to the right to free the left side pivot. Remove the tailgate from the vehicle entirely. Do not carry the tailgate loose in the truck pickup box.

**NOTE:** Dual rear wheel pickup models require properly spaced rear clearance lights. If such a vehicle is operated without a tailgate, suitable lights must be installed.

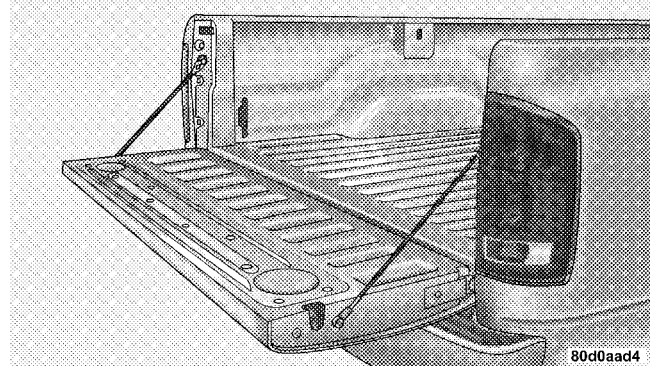

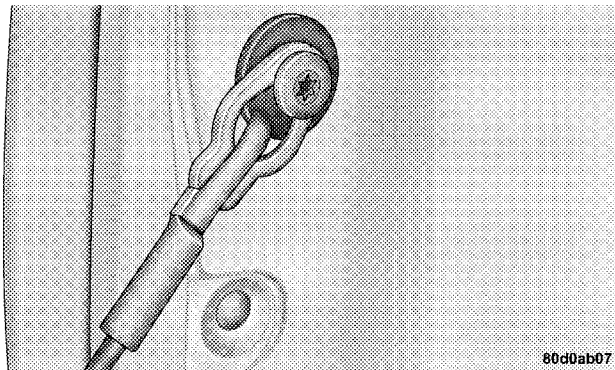

## SAFETY TIPS

### Transporting Passengers

This vehicle is designed to carry passengers in the cab only. For safety reasons, **NEVER TRANSPORT PASSENGERS IN THE CARGO AREA.**

## WARNING!

**It is extremely dangerous to ride in a cargo area, inside or outside of a vehicle. In a collision, people riding in these areas are more likely to be seriously injured or killed.**

**Do not allow people to ride in any area of your vehicle that is not equipped with seats and seat belts.**

**Be sure everyone in your vehicle is in a seat and using a seat belt properly.**

### Lock Your Vehicle

Always remove the keys from the ignition and lock all doors when leaving the vehicle unattended, even in your own driveway or garage. Try to park your vehicle in a well-lighted area and never invite theft by leaving articles of value exposed.

## Exhaust Gas

### WARNING!

**Exhaust gases contain carbon monoxide, a potentially toxic gas that by itself is colorless and odorless. To avoid inhaling these gases, the following precautions should be observed:**

- Do not run the engine in a closed garage or in confined areas any longer than needed to move your vehicle in or out of the area.
- If it is necessary to sit in a parked vehicle with the engine running for more than a short period, adjust your climate control system to force outside air into the vehicle. Set the blower at high speed and the controls in any position except OFF or MAX A/C.

- The best protection against carbon monoxide entry into the vehicle body is a properly maintained engine exhaust system.

Be aware of changes in the sound of the exhaust system; exhaust fumes detected inside the vehicle; or damage to the underside or rear of the vehicle. Have a competent mechanic inspect the complete exhaust system and adjacent body areas for broken, damaged, deteriorated or mispositioned parts. Open seams or loose connections could permit exhaust fumes to seep into the passenger compartment. In addition, inspect the exhaust system each time the vehicle is raised for lubrication or oil change. Replace or adjust as required.

### **Safety Checks You Should Make Inside The Vehicle**

#### **Heater Defroster Ducts**

Inspect the heater defroster ducts for proper operation. Check for proper air flow through all defroster ducts. If

there are any question regarding the operation of your heater defroster ducts, have the system checked by an authorized dealer

### **Seat Belts**

Inspect the belt system periodically, checking for cuts, frays and loose parts. Damaged parts must be replaced immediately. Do not disassemble or modify the system.

Seat belt assemblies must be replaced after an accident if they have been damaged (bent retractor, torn webbing, etc.) or if the front airbags have deployed. If there is any question regarding belt or retractor condition, replace the belt.

### **Airbag Light**

The light should come on and remain on for 6 to 8 seconds as a bulb check when the ignition switch is first turned ON. If the light is not lit during starting, see your authorized dealer. If the light stays on, flickers or comes

on while driving, have the system checked by an authorized dealer. If there is a problem with the airbag light the seatbelt light will flash.

### **Safety Checks You Should Make Outside The Vehicle**

#### **Tires**

Examine tires for tread wear or uneven wear patterns. Check for stones, nails, glass or other objects lodged in the tread.

Inspect for tread cuts or sidewall cracks. Check wheel nuts for tightness and tires for proper pressure.

#### **Lights**

Check the operation of all exterior lights. Check turn signal and high beam indicator lights on the instrument panel.

#### **Door Latches**

Check for positive closing, latching and locking.

**Fluid Leaks**

Check area under vehicle after overnight parking for fuel, water, oil, or other fluid leaks. Also, if fuel fumes are detected the cause should be located and corrected.



# UNDERSTANDING YOUR INSTRUMENT PANEL

## CONTENTS

---

■ Instruments And Controls . . . . .	171	□ AM Reception . . . . .	182
■ Instrument Cluster . . . . .	172	□ FM Reception . . . . .	183
■ Instrument Cluster Description . . . . .	173	■ Sales Code REF — AM/FM/CD (Single Disc) Radio With Optional Satellite Radio And Hands Free Phone Capability . . . . .	183
■ Electronic Digital Clock . . . . .	181	□ Operating Instructions - Radio Mode . . . . .	183
□ Clock Setting Procedure . . . . .	181	□ Operation Instructions - CD Mode . . . . .	187
■ Radio General Information . . . . .	182	□ Operation Instructions - Auxiliary Mode . . . . .	189
□ Radio Broadcast Signals . . . . .	182	□ Operating Instructions - Hands Free Phone — If Equipped . . . . .	190
□ Two Types Of Signals . . . . .	182		
□ Electrical Disturbances . . . . .	182		



- Operating Instructions - Satellite Radio — If Equipped . . . . .191
- Sales Code RAQ – AM/FM/CD (6-Disc) Radio With Optional Satellite Radio, Hands Free Phone, And Vehicle Entertainment Systems (VES) Capabilities . . . . .191
  - Operating Instructions - Radio Mode . . . . .191
  - Operation Instructions - (CD Mode For CD Audio Play) . . . . .196
  - Load/Eject Button (CD Mode For CD Audio Play) . . . . .198
  - Notes On Playing MP3 Files . . . . .200
  - Operation Instructions - (CD Mode For MP3 Audio Play) . . . . .202
  - Load/Eject Button (CD Mode For MP3 Play) . . .202
- Sales Code RAK – AM/FM/Cassette/CD (6-Disc) Radio With Optional Satellite Radio, Hands Free Phone, Video, MP3, And WMA Capabilities . . . . .204
  - Operating Instructions - Radio Mode . . . . .205
  - Operating Instructions — Tape Player . . . . .209
  - Seek Button . . . . .209
  - Fast Forward (FF) . . . . .210
  - Rewind (RW) . . . . .210
  - Tape Eject . . . . .210
  - Scan Button . . . . .210
  - Changing Tape Direction . . . . .210
  - Metal Tape Selection . . . . .210
  - Pinch Roller Release . . . . .210
  - Noise Reduction . . . . .211

□ Operation Instructions - (CD Mode For CD Audio Play) . . . . .	211	□ System Activation . . . . .	220
□ Load/Eject Button (CD Mode For CD Audio Play) . . . . .	212	□ Electronic Serial Number/Sirius Identification Number (ESN/SID) . . . . .	220
□ Notes On Playing MP3 Files . . . . .	214	□ Selecting Satellite Mode In REF, RAQ, And RAK Radios . . . . .	221
□ Operation Instructions - (CD Mode For MP3 And WMA Audio Play) . . . . .	216	□ Selecting a Channel . . . . .	222
□ Load/Eject Button (CD Mode For MP3 And WMA Play) . . . . .	216	□ Storing And Selecting Pre-Set Channels . . . . .	222
■ Sales Code REC — AM/FM/CD (6-Disc) Radio With Navigation System . . . . .	219	□ Using The PTY (Program Type) Button (If Equipped) . . . . .	222
□ Operating Instructions — Satellite Radio (If Equipped) . . . . .	219	□ PTY Button "Scan" . . . . .	222
□ Clock Setting Procedure . . . . .	219	□ PTY Button "Seek" . . . . .	223
■ Satellite Radio — If Equipped . . . . .	220	□ Satellite Antenna . . . . .	223
		□ Reception Quality . . . . .	223
		■ Remote Sound System Controls — If Equipped . . . . .	224

## 170 UNDERSTANDING YOUR INSTRUMENT PANEL

- Radio Operation . . . . .224
- Tape Player . . . . .225
- CD Player . . . . .225
- Cassette Tape And Player Maintenance . . . . .225
- Compact Disc Maintenance . . . . .226
- Radio Operation And Cellular Phones . . . . .227
- Climate Controls . . . . .227
- Heater Only — Fleet Vehicles . . . . .228
- Air Conditioning And Heating — If Equipped .230
- Air Conditioning With Dual Zone Temperature Control — If Equipped . . . . .233
- Operating Tips . . . . .237
- Operating Tips Chart . . . . .240

**INSTRUMENTS AND CONTROLS**

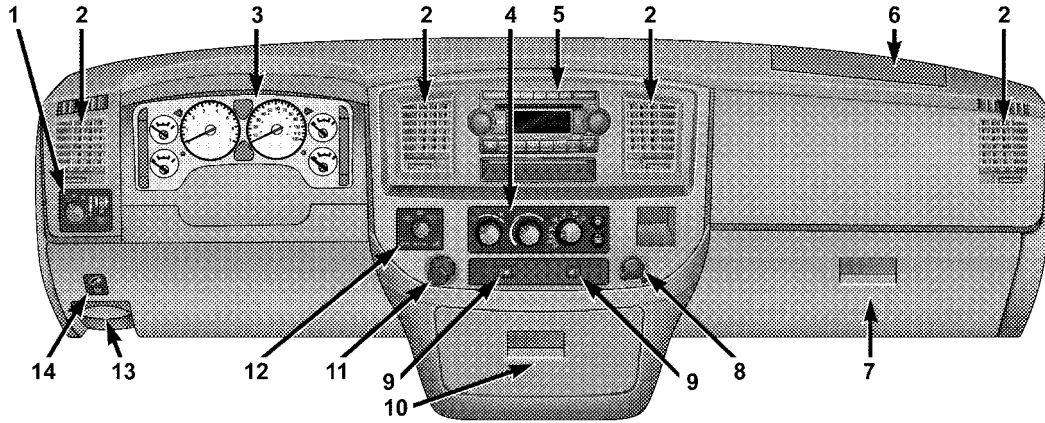

4

- 1. Headlight Switch
- 2. Air Outlets
- 3. Instrument Cluster
- 4. Climate Controls
- 5. Radio
- 6. Passenger Airbag

- 7. Glove Box
- 8. Power Outlet
- 9. Heated Seat Switch
- 10. Cup Holders
- 11. Cigar Lighter

- 12. Electronic Axle Locker and Disconnecting Stabilizer/Sway Bar Switch
  - 13. Parking Brake Release Lever
  - 14. Adjustable Pedal Control Switch\*
- \*If Equipped

## 172 UNDERSTANDING YOUR INSTRUMENT PANEL

### INSTRUMENT CLUSTER

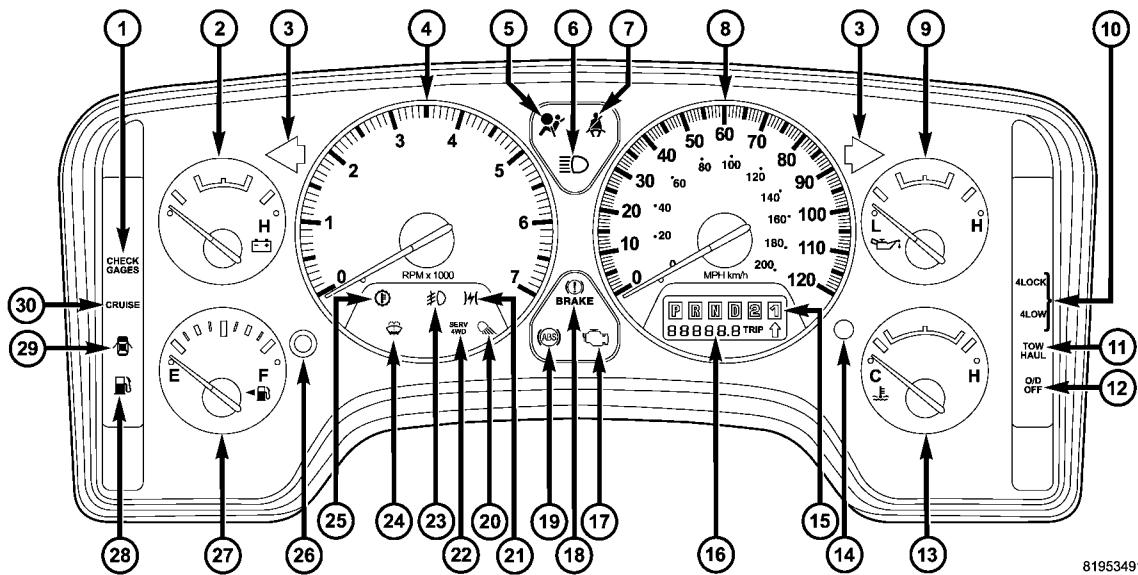

81953491

## INSTRUMENT CLUSTER DESCRIPTION

### 1. *Check Gages*



This light illuminates when the Voltmeter, Engine Oil Pressure or Engine Coolant Temperature gages indicate a reading either too high or too low. Examine the gages carefully, and follow the instructions above for each indicated problem.

**NOTE:** When the ignition switch is turned to OFF, the Fuel Gage, Voltmeter, Oil Pressure and Engine Coolant Temperature gages may not show accurate readings. When the engine is not running, turn the ignition switch to ON to obtain accurate readings.

### 2. *Voltage Gauge*



When the engine is running, the gauge indicates the electrical system voltage. The pointer should stay within the normal range if the battery is charged. If

the pointer moves to either extreme left or right and remains there during normal driving, the electrical system should be serviced.

**NOTE:** If the gauge pointer moves to either extreme of the gauge, the “Check Gages” indicator will illuminate and a single chime will sound. The “Check Gages” indicator may also illuminate prior to the voltage gauge moving out of normal range. In either case, see you local authorized Dealer for system service.

### 3. *Turn Signal Indicators*

Lights in instrument cluster flash when outside turn signals are operating.

### 4. *Tachometer*

The tachometer indicates engine speed in revolutions per minute.

**CAUTION!**

**Do not operate the engine with the tachometer pointer at high rpm for extended periods. Engine damage may occur.**

**5. Airbag Indicator Light**

The indicator lights and remains lit for 6 to 8 seconds when the ignition is first turned on. If the light stays on, flickers or comes on while driving, have the airbag system checked by an authorized dealer.

**6. High Beam Indicator**

This indicator shows that headlights are on high beam.

**7. Seat Belt Reminder Light**

When the ignition switch is first turned ON, this light will turn on for 5 to 8 seconds as a bulb check. During the bulb check, if the driver's seat belt is

unbuckled, a chime will sound. After the bulb check or when driving, if the driver seat belt remains unbuckled, the Seat Belt Warning Light will flash or remain on continuously. Refer to "Enhanced Driver Seat Belt Reminder System (BeltAlert™)" in the Occupant Restraints section for more information. (See page 43 for more information.)

**8. Speedometer**

The speedometer shows the vehicle speed in miles per hour and/or kilometers per hour.

**9. Oil Pressure Gauge**

The pointer should always indicate some oil pressure when the engine is running. A continuous high or low reading, under normal driving conditions, may indicate a lubrication system malfunction. Immediate service should be obtained. (See page 389 for more information.)

**NOTE:** If the gauge pointer moves to either extreme of the gauge, the “Check Gages” indicator will illuminate and a single chime will sound.

### **10. Transfer Case Position**

(See page 258 for more information.)

### **11. TOW HAUL**

The TOW HAUL button is located at the end of the gear shift lever. This light will illuminate when the TOW HAUL OD/OFF button is pushed once. (See page 254 for more information.)

### **12. OD/OFF**

the OD/OFF button is located at the end of the gear shift lever. This light will illuminate when the TOW HAUL OD/OFF button is pushed twice. (See page 254 for more information.)

### **13. Temperature Gauge**



The temperature gauge indicates engine coolant temperature. Any reading within the normal range indicates that the cooling system is operating satisfactorily. The gauge needle will likely indicate a higher temperature when driving in hot weather, up mountain grades, in heavy traffic, or when towing a trailer. If the needle rises to the “245°F” mark, stop the vehicle, shift into N (Neutral), and increase the engine idle speed for 2 to 3 minutes. If the temperature reading does not return to normal, shut your engine OFF and allow it to cool. Seek authorized service immediately. See Cooling System information in the section on “Maintaining Your Vehicle.”



**CAUTION!**

**Do not leave your vehicle unattended with the engine running as you would not be able to react to the temperature indicator if the engine overheats.**

**NOTE:** Engine idle speed will automatically increase to 1000 rpm at elevated coolant temperatures to improve engine cooling.

**NOTE:** If the gauge pointer moves to either extreme of the gauge, the “Check Gages” indicator will illuminate and a single chime will sound.

**14. Security**

The light will flash rapidly for approximately 16 seconds when the vehicle theft alarm is arming. The light will flash at a slower rate after the alarm is set. The security light will also come on for about two seconds when the ignition is first turned ON.

**15. Transmission Range Indicator (Automatic Transmissions Only)**

When the gear selector lever is moved, this indicator shows the automatic transmission gear range selected.

**16. Odometer/Trip Odometer**

The odometer shows the total distance the vehicle has been driven.

If the odometer reading is changed during repair or replacement, be sure to keep a record of the reading before and after the service so that the correct mileage can be determined.

The trip odometer shows individual trip mileage. To toggle between the odometer and the trip odometer, press the Odometer/Trip Odometer Button. To reset the Trip Odometer, press and hold the button while in trip mode, until the Trip Odometer resets.

**NOTE:** The odometer/trip odometer Vacuum Fluorescent Display will also may display GASCAP, which indicates that your gas cap is possibly loose or damaged.

The Vacuum Fluorescent Display will also display NO-FUSE, which indicates that the IOD fuse is removed from the Integrated Power Module. (See page 430 for more information.)

**NOTE:** There is also an engine hour function. This indicates the total number of hours the engine has been running. To display the engine hours perform the following: Place the ignition in RUN, but do not start the engine. With the odometer value displayed, hold the trip button down for a period of 6 seconds. The odometer will change to trip value first, then it will display the engine hour value. The engine hours will be displayed for a period of 30 seconds until the ignition is turned off or the engine is started.

### 17. Check Gages Light



This light is part of an onboard diagnostic system which monitors the emissions and engine control system. If the vehicle is ready for emissions testing the light will come on when the ignition is first turned on and remain on, as a bulb check, until the engine is started. If the vehicle is not ready for emissions testing the light will come on when the ignition is first turned on and remain on for 15 seconds, then blink for 5 seconds, and remain on until the vehicle is started. If the bulb does not come on during starting, have the condition investigated promptly.

If this light comes on and remains on while driving, it suggests a potential engine control problem and the need for system service.

Although your vehicle will usually be drivable and not need towing, see your dealer for service as soon as possible.

**CAUTION!**

**Prolonged driving with the MIL on could cause damage to the engine control system. It also could affect fuel economy and driveability.**

**If the MIL is flashing, severe catalytic converter damage and power loss will soon occur. Immediate service is required.**

**18. Brake System Warning Light**

This light illuminates when the ignition key is turned to the ON position and remains on for a few seconds. If the light stays on longer, it may be an indication that the parking brake has not been released. This light will illuminate if the brake fluid is low, especially when braking or accelerating hard. This light will illuminate if the ABS indicator light has a malfunction. This light will flash if the engine is running and the parking brake is on.

If the light remains on when the parking brake is released, it indicates a possible brake hydraulic system malfunction. In this case, the light will remain on until the cause is corrected.

If brake failure is indicated, immediate repair is necessary and continued operation of the vehicle in this condition is dangerous.

Acceleration which causes the rear wheels to slip for a period of time may result in the red brake light illuminating and a brake switch code being set on ABS equipped vehicles. Depressing the brake pedal should extinguish the red brake light.

**19. ABS Warning Light**

 This light monitors the Anti-Lock Brake System which is described elsewhere in this manual. This light will come on when the ignition key is turned to the ON position and may stay on for five seconds. If the ABS light remains on or comes on during driving, it indicates

that the anti-lock portion of the brake system is not functioning and that service is required. See your authorized dealer immediately. The ABS light could also illuminate during loss of traction and remain illuminated until the brake pedal is pressed.

### 20. *Cargo Light*

The Cargo Lamp light will illuminate when the Cargo Lamp is activated by pressing the Cargo Light Button on the headlight switch.

### 21. *Electronic Throttle Control (ETC)*



This light informs you of a problem with the Electronic Throttle Control system. If a problem is detected the light will come on while the engine is running. If the light remains lit with the engine running your vehicle will usually be drivable, however, see your dealer for service as soon as possible. If the light is flashing when the engine is running, immediate service is required and you may experience

reduced performance, an elevated/rough idle or engine stall and your vehicle may require towing. The light will come on when the ignition is first turned on and remain on for 15 seconds as a bulb check. If the light does not come on during starting, have the system checked by an authorized dealer.

### 22. *SERV 4WD Indicator*

The 4WD indicator will be illuminated whenever the 4WD mode is engaged for either the manual or electric shift 4WD systems. The SERV 4WD indicator monitors the electric shift 4WD system. If the SERV 4WD light stays on or comes on during driving, it means that the 4WD system is not functioning properly and that service is required.

### 23. *Front Fog Light Indicator — If Equipped*

 This light shows when the front fog lights are ON.

**24. Low Washer Fluid Light**

This light comes on when the washer fluid level falls below approximately 1/4 full. The light will remain on until fluid is added and ignition switch is cycled.

**25. Transmission Oil Temperature Warning Light (Automatic Transmissions Only)**

This light indicates that there is excessive transmission fluid temperature that might occur with severe usage such as trailer towing. It may also occur when operating the vehicle in a high torque converter slip condition, such as 4-wheel-drive operation (e.g. snow plowing, off- road operation). If this light comes on, stop the vehicle and run the engine at idle or faster, with the transmission in NEUTRAL until the light goes off.

**26. Odometer/Trip Odometer Button**

Press this button to toggle between the odometer and the trip odometer display. Holding the button in resets the trip odometer reading when in trip mode.

**27. Fuel Gauge**

Shows level of fuel in tank when ignition switch is in the ON position.

**28. Low Fuel Warning Light**

When the fuel level drops to 1/16 tank, the fuel symbol will light and a single chime will sound.

**NOTE:** If your vehicle is equipped with an overhead console module (CMTC), it is possible for DTE to display “LO FUEL” before the low fuel warning light turns on in the instrument cluster. This could occur because the low fuel warning is set to a specified fuel tank volume and DTE is an estimated distance calculation based on vehicle fuel economy and remaining fuel tank volume.

**Ram fuel tank volumes are as follows:**

- 34 gallons - short box models
- 35 gallons - long box models

**29. Door Ajar****DOOR  
AJAR**

The Door Ajar light will illuminate when any door is opened. When the ignition is ON the Door Ajar light will stay illuminated until the open door is closed. When the ignition is OFF the Door Ajar light will stay illuminated until the open door is closed or the battery saver feature automatically turns the light off.

**30. CRUISE Light**

This indicator lights when the electronic speed control system is turned on.

**ELECTRONIC DIGITAL CLOCK**

The clock and radio each use the display panel built into the radio. A digital readout shows the frequency and/or time in hours and minutes (depending on your radio model) whenever the ignition switch is in the “ON” or “ACC” position.

When the ignition switch is in the “OFF” position, or when the radio frequency is being displayed, time keeping is accurately maintained.

On the RAQ radio the time button alternates the location of the time and frequency on the display. On the REF only one of the two, time or frequency is displayed at a time.

**Clock Setting Procedure**

1. Press and hold the time button until the hours blink.
2. Adjust the hours by turning the right side Tune / Audio control.

3. After the hours are adjusted, press the right side Tune / Audio control to set the minutes.
4. Adjust the minutes using the right side Tune / Audio control.
5. To exit, press any button/knob or wait approximately 5 seconds.

## **RADIO GENERAL INFORMATION**

### **Radio Broadcast Signals**

Your new radio will provide excellent reception under most operating conditions. Like any system, however, car radios have performance limitations, due to mobile operation and natural phenomena, which might lead you to believe your sound system is malfunctioning. To help you understand and save you concern about these “apparent” malfunctions, you must understand a point or two about the transmission and reception of radio signals.

### **Two Types of Signals**

There are two basic types of radio signals... AM or Amplitude Modulation, in which the transmitted sound causes the amplitude, or height, of the radio waves to vary... and FM or Frequency Modulation, in which the frequency of the wave is varied to carry the sound.

### **Electrical Disturbances**

Radio waves may pick up electrical disturbances during transmission. They mainly affect the wave amplitude, and thus remain a part of the AM reception. They interfere very little with the frequency variations that carry the FM signal.

### **AM Reception**

AM sound is based on wave amplitude, so AM reception can be disrupted by such things as lightning, power lines and neon signs.

## FM Reception

Because FM transmission is based on frequency variations, interference that consists of amplitude variations can be filtered out, leaving the reception relatively clear, which is the major feature of FM radio.

**NOTE:** The radio, steering wheel radio controls (if equipped), and 6 disc CD/DVD changer (if equipped) will remain active for up to 10 minutes after the ignition switch has been turned off. Opening a vehicle front door will cancel this feature.

## SALES CODE REF — AM/FM/CD (SINGLE DISC) RADIO WITH OPTIONAL SATELLITE RADIO AND HANDS FREE PHONE CAPABILITY

**NOTE:** The radio sales code is located on the lower right side of your radio faceplate.

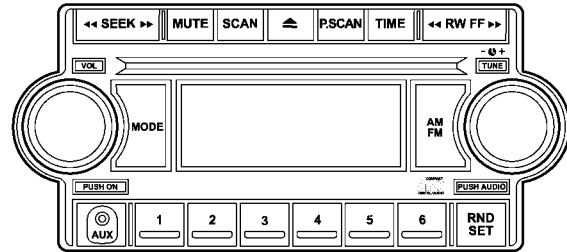

815eb156

### REF Radio

### Operating Instructions - Radio Mode

**NOTE:** The ignition switch must be in the ON or ACC position to operate the radio.



**Power Switch/Volume Control (Rotary)**

Press the ON/VOL control to turn the radio ON. Press the ON/VOL a second time to turn OFF the radio.

**Electronic Volume Control**

The electronic volume control turns continuously (360 degrees) in either direction without stopping. Turning the volume control to the right increases the volume and to the left decreases it.

When the audio system is turned on, the sound will be set at the same volume level as last played.

For your convenience, the volume can be turned down, but not up, when the audio system is off and the ignition is ON.

**Mode Button (Radio Mode)**

Press the mode button repeatedly to select between the CD player and Satellite Radio (if equipped).

**SEEK Button (Radio Mode)**

Press and release the SEEK button to search for the next listenable station in either AM/FM or Satellite (if equipped) mode. Press the right side of the button to seek up and the left side to seek down. The radio will remain tuned to the new station until you make another selection. Holding the button will bypass stations without stopping until you release it.

**MUTE Button (Radio Mode)**

Press the MUTE button to cancel the sound from the speakers. "MUTE" will display. Press the MUTE button a second time and the sound from the speakers will return. Rotating the volume control, turning the radio ON/OFF, or turning ON/OFF the ignition, will cancel the MUTE feature.

**NOTE:** In Hands Free Phone (if equipped) mode, the MUTE button mutes the microphone.

**SCAN Button (Radio Mode)**

Pressing the SCAN button causes the tuner to search for the next listenable station in either, AM, FM, or Satellite (if equipped) frequencies, pausing for 5 seconds at each listenable station before continuing to the next. To stop the search, press SCAN a second time.

**PSCAN Button (Radio Mode)**

Pressing the PSCAN button causes the tuner to scan through preset stations in either, AM, FM, or Satellite (if equipped) frequencies, pausing for 5 seconds at each preset station before continuing to the next. To stop the search, press PSCAN a second time.

**Time Button**

Press the time button and the time of day will display for 5 seconds.

**Clock Setting Procedure**

1. Press and hold the time button until the hours blink.

2. Adjust the hours by turning the right side Tune/Audio control.

3. After the hours are adjusted, press the right side Tune/Audio control to set the minutes. The minutes will begin to blink.

4. Adjust the minutes using the right side Tune/Audio control.

5. To exit, press any button/knob or wait 5 seconds.

**RW/FF (Radio Mode)**

Pressing the rewind/fast forward button causes the tuner to search for the next frequency in the direction of the arrows. This feature operates in either AM, FM or Satellite (if equipped) frequencies.

**TUNE Control (Radio Mode)**

Turn the right side rotary control clockwise to increase or counter-clockwise to decrease the frequency.

**AM/FM Button (Radio Mode)**

Press the button to select AM or FM Modes.

**Setting the Tone, Balance, and Fade**

Press the rotary TUNE control and BASS will display. Turn the TUNE control to the right or left to increase or decrease the Bass tones.

Press the rotary TUNE control a second time and MID will display. Turn the TUNE control to the right or left to increase or decrease the Mid Range tones.

Press the rotary TUNE control a third time and TREB will display. Turn the TUNE control to the right or left to increase or decrease the Treble tones.

Press the rotary TUNE control a fourth time and BAL will display. Turn the TUNE control to the right or left to adjust the sound level from the right or left side speakers.

Press the rotary TUNE control a fifth time and FADE will display. Turn the TUNE control to the left or right to adjust the sound level between the front and rear speakers.

Press the tune control again or wait 5 seconds to exit setting tone, balance, and fade.

**RND/SET Button (Radio Mode) To SET The Push-Button Memory**

When you are receiving a station that you wish to commit to push-button memory, press the SET button. The symbol SET 1 will now show in the display window. Select the button (1-6) you wish to lock onto this station and press and release that button. If a button is not selected within 5 seconds after pressing the SET button, the station will continue to play but will not be stored into push-button memory.

You may add a second station to each push-button by repeating the above procedure with this exception: Press

the SET button twice and SET 2 will show in the display window. Each button can be set for SET 1 and SET 2 in both AM and FM. This allows a total of 12 AM, 12 FM, and 12 Satellite (if equipped) stations to be stored into push-button memory. The stations stored in SET 2 memory can be selected by pressing the push-button twice.

Every time a preset button is used, a corresponding button number will display.

### **Preset Buttons 1 - 6 (Radio Mode)**

These buttons tune the Radio to the stations that you commit to push-button memory {12 AM, 12 FM, and 12 Satellite (if equipped) stations}.

### **Operation Instructions - CD Mode**

**NOTE:** The ignition switch must be in the ON or ACC position to operate the radio.

#### **Inserting The Compact Disc (Single CD Player)**

Gently insert one CD into the CD player with the CD label facing up. The CD will automatically be pulled into the CD Player and the CD icon will illuminate on the radio display.

If the volume control is ON, the unit will switch to CD mode and begin to play. The display will show the track number and play time in minutes and seconds. Play will begin at the start of track one.

**NOTE:**

- On some vehicles, you may insert or eject a disc with the radio or ignition switch OFF.

- If you insert a disc with the ignition ON and the radio OFF, the CD will automatically be pulled into the CD Player.
- This radio does not play discs with MP3 tracks.

**SEEK Button (CD Mode)**

Press the right side of the SEEK button for the next track on the CD. Press the left side of the button to return to the beginning of the current track, or return to the beginning of the previous track if the CD is within the first 10 seconds of the current selection.

**MUTE Button (CD Mode)**

Press the MUTE button to cancel the sound from the speakers. "MUTE" will display. Press the MUTE button a second time and the sound from the speakers will return. Rotating the volume control or turning OFF the ignition will also return the sound from the speakers.

**SCAN Button (CD Mode)**

Press this button to play the first 10 seconds of each track. To stop the scan function, press the button a second time.

**EJECT Button (CD Mode)**

Press this button and the disc will unload and move to the entrance for easy removal. The unit will switch to the last selected mode.

If you do not remove the disc within 15 seconds, it will be reloaded. The radio mode will continue to appear.

**TIME Button (CD Mode)**

Press this button to change the display from elapsed CD playing time to time of day. The time of day will display for 5 seconds.

**RW/FF (CD Mode)**

Press and hold the FF (Fast Forward) and the CD player will begin to fast forward until FF is released. The RW (Reverse) button works in a similar manner.

**RND/SET Button (Random Play Button) (CD Mode)**

Press this button while the CD is playing to activate Random Play. This feature plays the selections on the compact disc in random order to provide an interesting change of pace.

Press the SEEK button to move to the next randomly selected track.

Press and hold the FF button to fast forward through the tracks. Release the FF button to stop the fast forward feature. If the RW button is pressed, the current track will reverse to the beginning of the track and begin playing.

Press the RND button a second time to stop Random Play.

**Operation Instructions - Auxiliary Mode**

The auxiliary (AUX) jack is an audio input jack, which allows the user to plug in a portable device such as an MP3 player, cassette player, or microphone and utilize the vehicle's audio system to amplify the source and play through the vehicle speakers.

The auxiliary mode becomes active when an electrical device is plugged into the AUX jack using a standard 3.5 mm stereo audio cable and the user presses and releases the MODE button until AUX appears on the display.

**NOTE:** The radio will return to the last stored mode if the ignition switch is turned from the OFF/LOCK position to the ACC position, the radio is turned on, and the radio was previously in the AUX mode.

**SEEK Button (Auxiliary Mode)**

No function.

**MUTE Button (Auxiliary Mode)**

Press the MUTE button to cancel the sound from the speakers. "MUTE" will display. Press the MUTE button a second time and the sound from the speakers will return. Rotating the volume control or turning OFF the ignition will also return the sound from the speakers.

**SCAN Button (Auxiliary Mode)**

No function.

**EJECT Button (Auxiliary Mode)**

No function.



**PSCAN Button (Auxiliary Mode)**

No function.

**TIME Button (Auxiliary Mode)**

Press this button to change the display from elapsed playing time to time of day. The time of day will display for 5 seconds.

**RW/FF (Auxiliary Mode)**

No function.

**RND/SET Button (Auxiliary Mode)**

No function.

**Mode Button (Auxiliary Mode)**

Press the mode button repeatedly to select between the CD player and Satellite Radio (if equipped).

**Operating Instructions - Hands Free Phone — If Equipped**

Refer to the "HANDS FREE PHONE (UConnect™)" section of the Owner's Manual.

## Operating Instructions - Satellite Radio — If Equipped

Refer to the “Satellite Radio” section of the Owner’s Manual.

### SALES CODE RAQ – AM/FM/CD (6-DISC) RADIO WITH OPTIONAL SATELLITE RADIO, HANDS FREE PHONE, AND VEHICLE ENTERTAINMENT SYSTEMS (VES) CAPABILITIES

**NOTE:** The radio sales code is located on the lower right side of your radio faceplate.

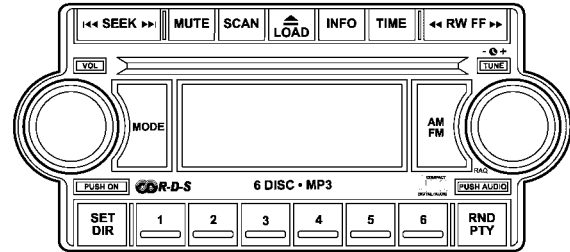

4

81365bb1

## RAQ Radio

### Operating Instructions - Radio Mode

**NOTE:** The ignition switch must be in the ON or ACC position to operate the radio.



**Power Switch/Volume Control (Rotary)**

Press the ON/VOL control to turn the radio ON. Press the ON/VOL a second time to turn OFF the radio.

**Electronic Volume Control**

The electronic volume control turns continuously (360 degrees) in either direction without stopping. Turning the volume control to the right increases the volume and to the left decreases it.

When the audio system is turned on, the sound will be set at the same volume level as last played.

For your convenience, the volume can be turned down, but not up, when the audio system is off and the ignition is ON.

**Mode Button (Radio Mode)**

Press the mode button repeatedly to select between the CD player, Satellite Radio, or Vehicle Entertainment System (VES) (if equipped).

**SEEK Button (Radio Mode)**

Press and release the SEEK button to search for the next listenable station in either AM/FM or Satellite (if equipped) mode. Press the right side of the button to seek up and the left side to seek down. The radio will remain tuned to the new station until you make another selection. Holding the button will bypass stations without stopping until you release it.

**MUTE Button (Radio Mode)**

Press the MUTE button to cancel the sound from the speakers. "MUTE" will be displayed. Press the MUTE button a second time and the sound from the speakers will return. Rotating the volume control, turning the radio ON/OFF, or turning OFF the ignition will also return the sound from the speakers

**NOTE:** In Hands Free Phone (if equipped) mode, the MUTE button mutes the microphone.

**SCAN Button (Radio Mode)**

Pressing the SCAN button causes the tuner to search for the next listenable station, in either AM, FM or Satellite (if equipped) frequencies, pausing for 5 seconds at each listenable station before continuing to the next. To stop the search, press SCAN a second time.

**MSG or INFO Button (Radio Mode)**

Press the MSG or INFO button for an RBDS station (one with call letters displayed). The radio will return a Radio Text message broadcast from an FM station (FM mode only).

**Time Button**

Press the time button and the time of day will be displayed for 5 seconds.

**Clock Setting Procedure**

1. Press and hold the time button until the hours blink.

2. Adjust the hours by turning the right side Tune / Audio control.

3. After the hours are adjusted, press the right side Tune / Audio control to set the minutes. The minutes will begin to blink.

4. Adjust the minutes using the right side Tune / Audio control.

5. To exit, press any button/knob or wait 5 seconds.

**RW/FF (Radio Mode)**

Pressing the rewind/fast forward button causes the tuner to search for the next frequency in the direction of the arrows. This feature operates in either AM, FM or Satellite (if equipped) frequencies.

**TUNE Control (Radio Mode)**

Turn the right side rotary control clockwise to increase or counter-clockwise to decrease the frequency.

**AM/FM Button (Radio Mode)**

Press the button to select AM or FM Modes.

**Setting the Tone, Balance, and Fade**

Press the rotary TUNE control and BASS will display. Turn the TUNE control to the right or left to increase or decrease the Bass tones.

Press the rotary TUNE control a second time and MID will display. Turn the TUNE control to the right or left to increase or decrease the Mid Range tones.

Press the rotary TUNE control a third time and TREBLE will display. Turn the TUNE control to the right or left to increase or decrease the Treble tones.

Press the rotary TUNE control a fourth time and BALANCE will display. Turn the TUNE control to the right or left to adjust the sound level from the right or left side speakers.

Press the rotary TUNE control a fifth time and FADE will display. Turn the TUNE control to the left or right to adjust the sound level between the front and rear speakers.

Press the rotary TUNE control again to exit setting tone, balance and fade.

**RND/PTY Button (Radio Mode)**

Pressing this button once will turn on the PTY mode for 5 seconds. If no action is taken during the 5 second time out the PTY icon will turn off. Pressing the PTY button or turning the TUNE rotary knob within 5 seconds will allow the program format type to be selected. Many radio stations do not currently broadcast PTY information.

Toggle the PTY button to select the following format types:

Program Type	16 Digit-Character Display
No program type or undefined	None
Adult Hits	Adult_Hits
Alert Alert	Alert Alert
Classical	Classical
Classic Rock	Classic_Rock
College	College
Country	Country
Emergency Test	Emergency Test
Foreign Language	Foreign_Language
Information	Information
Jazz	Jazz
News	News

Nostalgia	Nostalgia
Oldies	Oldies
Personality	Personality
Public	Public
Rhythm and Blues	Rhythm_and_Blues
Religious Music	Religious_Music
Religious Talk	Religious_Talk
Rock	Rock
Soft	Soft
Soft Rock	Soft_Rock
Soft Rhythm and Blues	Soft_R_&_B
Sports	Sports
Talk	Talk
Top 40	Top_40
Weather	Weather

By pressing the SEEK button when the PTY icon is displayed, the radio will be tuned to the next frequency

station with the same selected PTY name. The PTY function only operates when in the FM mode.

If a preset button is activated while in the PTY (Program Type) mode, the PTY mode will be exited and the radio will tune to the preset station.

### **SET/DIR Button (Radio Mode) — To Set the Push-Button Memory**

When you are receiving a station that you wish to commit to push-button memory, press the SET/DIR button. The symbol SET 1 will now show in the display window. Select the button (1-6) you wish to lock onto this station and press and release that button. If a button is not selected within 5 seconds after pressing the SET/DIR button, the station will continue to play but will not be stored into push-button memory.

You may add a second station to each push-button by repeating the above procedure with this exception: Press the SET/DIR button twice and SET 2 will show in the

display window. Each button can be set for SET 1 and SET 2 in both AM and FM. This allows a total of 12 AM, 12 FM and 12 Satellite (if equipped) stations to be stored into push-button memory. The stations stored in SET 2 memory can be selected by pressing the push-button twice.

Every time a preset button is used a corresponding button number will be displayed.

### **Buttons 1 - 6 (Radio Mode)**

These buttons tune the Radio to the stations that you commit to push-button memory {12AM, 12 FM, and 12 Satellite (if equipped) stations}.

### **Operation Instructions - (CD MODE for CD Audio Play)**

**NOTE:** The ignition switch must be in the ON or ACC position to operate the radio.

**NOTE:** Note: This Radio is capable of playing compact discs (CD), recordable compact discs (CD-R), rewritable compact discs (CD-RW) compact discs with MP3 tracks and multisession compact discs with CD and MP3 tracks.

### **Inserting Compact Disc(s)**

Gently insert one CD into the CD player with the CD label facing up. The CD will automatically be pulled into the CD Player and the CD icon will illuminate on the radio display.

### **CAUTION!**

**This CD player will accept 4 3/4 inch (12 cm) discs only. The use of other sized discs may damage the CD player mechanism.**

You may eject a disc with the radio OFF.

If you insert a disc with the ignition ON and the radio ON, the unit will switch from radio to CD mode and begin to play when you insert the disc. The display will show the disc number, the track number, and index time in minutes and seconds. Play will begin at the start of track 1.

### **SEEK Button (CD MODE for CD Audio Play)**

Press the right side of the SEEK button for the next selection on the CD. Press the left side of the button to return to the beginning of the current selection, or return to the beginning of the previous selection if the CD is within the first 10 seconds of the current selection.

### **MUTE Button (CD MODE for CD Audio Play)**

Press the MUTE button to cancel the sound from the speakers. "MUTE" will be displayed. Press the MUTE button a second time and the sound from the speakers

will return. Rotating the volume control, turning the radio ON/OFF, or turning OFF the ignition will also return the sound from the speakers.

#### **SCAN Button (CD MODE for CD Audio Play)**

Press the Scan button to scan through each track on the CD currently playing.

#### **LOAD/EJECT Button (CD Mode for CD Audio Play)**

##### **LOAD/ EJECT - Load**



Press the LOAD/ EJECT button and the push-button with the corresponding number where the CD is being loaded. The radio will display PLEASE WAIT and prompt when to INSERT DISC. After the radio displays "LOAD DISC" insert the CD into the player.

Radio display will show "LOADING DISC" when the disc is loading, and "READING DISC" when the radio is reading the disc.

##### **LOAD / EJT - Eject**



Press the LOAD/ EJT button and the push-button with the corresponding number where the CD was loaded and the disc will unload and move to the entrance for easy removal.

Radio display will show "EJECTING DISC" when the disc is being ejected and prompt the user to remove the disc.

Press and hold the LOAD/ EJT button for 5 seconds and all CDs will be ejected from the radio.

If you have ejected a disc and have not removed it within 15 seconds, it will be reloaded. If the CD is not removed, the radio will continue to play the non-removed CD. If the CD is removed and there are other CD's in the radio, the radio will play the next CD after a 2 minute timeout. If the CD is removed and there are no other CD's in the

radio, the radio will remain in CD mode and display "INSERT DISC" for 10 seconds. If no discs are inserted within 10 seconds "NO DISCS LOADED" will be displayed.

On some vehicles a disc can be ejected with the radio and ignition OFF.

**TIME Button (CD MODE for CD Audio Play)**

Press this button to change the display from a large CD playing time display to a small CD playing time display.

**RW/FF (CD MODE for CD Audio Play)**

Press and hold FF (Fast Forward) and the CD player will begin to fast forward until FF is released or RW or another CD button is pressed. The RW (Reverse) button works in a similar manner.

**TUNE Control (CD MODE for CD Audio Play)**

Pressing the TUNE control allows the setting of the Tone, Fade, and Balance. See Radio Mode.

**AM/FM Button (CD MODE for CD Audio Play)**

Switches the Radio to the Radio mode.

**RND/PTY Button (Random Play Button) (CD MODE for CD Audio Play)**

Press this button while the CD is playing to activate Random Play. This feature plays the selections on the compact disc in random order to provide an interesting change of pace.

Press the SEEK button to move to the next randomly selected track.

Press and hold the FF button to fast forward through the tracks. Release the FF button to stop the fast forward feature.

Press the RND button a second time to stop Random Play.

**Buttons 1 - 6 (CD MODE for CD Audio Play)**

Selects disc positions 1 - 6 for Play/Load/Eject.



### Notes On Playing MP3 Files

The radio can play MP3 files, however, acceptable MP3 file recording media and formats are limited. When writing MP3 files, pay attention to the following restrictions.

### Supported Media (Disc Types)

The MP3 file recording media supported by the radio are CD-ROM, CD-R and CD-RW.

### Supported Medium Formats (File Systems)

The medium formats supported by the radio are ISO 9660 Level 1 and Level 2 and includes the Joliet extension. When reading discs recorded using formats other than ISO 9660 Level 1 and Level 2, the radio may fail to read files properly and may be unable to play the file normally. UDF and Apple HFS formats are not supported.

The radio uses the following limits for file systems:

- Maximum number of directory levels: 15

- Maximum number of files: 255
- Maximum number of folders: 100
- Maximum number of characters in file/folder names:
  - Level 1: 12 (including a separator "." and a 3-character extension)
  - Level 2: 31 (including a separator "." and a 3-character extension)

Multisession disc formats are supported by the radio. Multisession discs may contain combinations of normal CD audio tracks and computer files (including MP3 files). Discs created with an option such as "keep disc open after writing" are most likely multisession discs. The use of multisession for CD audio or MP3 playback may result in longer disc loading times.

### Supported MP3 File Formats

The radio will recognize only files with the \*.mp3 extension as MP3 files. Non-MP3 files named with the \*.mp3 extension may cause playback problems. The radio is designed to recognize the file as an invalid MP3 and will not play the file.

When using the MP3 encoder to compress audio data to an MP3 file, the bit rate and sampling frequencies in the following table are supported. In addition, variable bit rates (VBR) are also supported. The majority of MP3 files use a 44.1 kHz sampling rate and a 192, 160, 128, 96 or VBR bit rates.

MPEG Specification	Sampling Frequency (kHz)	Bit rate (kbps)
MPEG-1 Audio Layer 3	48, 44.1, 32	320, 256, 224, 192, 160, 128, 112, 96, 80, 64, 56, 48, 40, 32
MPEG-2 Audio Layer 3	24, 22.05, 16	160, 128, 144, 112, 96, 80, 64, 56, 48, 40, 32, 24, 16, 8

ID3 Tag information for artist, song title and album title are supported for version 1 ID3 tags. ID3 version 2 is not supported by the radios.

Playlist files are not supported. MP3 Pro files are not supported.

### Playback of MP3 Files

When a medium containing MP3 data is loaded, the radio checks all files on the medium. If the medium contains a lot of folders or files, the radio will take more time to start playing the MP3 files.

Loading times for playback of MP3 files may be affected by the following:

- Media - CD-RW media may take longer to load than CD-R media
- Medium formats - Multisession discs may take longer to load than non-multisession discs
- Number of files and folders - Loading times will increase with more files and folders

To increase the speed of disc loading, it is recommended to use CD-R media and single-session discs. To create a single-session disc, enable the Disc at Once option before writing to the disc.

### Operation Instructions - (CD Mode for MP3 Audio Play)

#### SEEK Button (CD Mode for MP3 Play)

Pressing the right side of the SEEK button plays the next MP3 File. Pressing the left side of the SEEK button plays the beginning of the MP3 file. Pressing the button within the first ten seconds plays the previous file.

#### LOAD/EJECT Button (CD Mode for MP3 Play)

##### LOAD/ EJECT - Load



**LOAD**

Press the LOAD/ EJECT button and the push-button with the corresponding number where the CD is being loaded. The radio will display PLEASE WAIT and prompt when to INSERT DISC. After the radio displays "LOAD DISC" insert the CD into the player.

Radio display will show "LOADING DISC" when the disc is loading.

**LOAD / EJECT - Eject**

Press the LOAD/ EJECT button and the push-button with the corresponding number where the CD was loaded and the disc will unload and move to the entrance for easy removal.

Radio display will show "EJECTING DISC" when the disc is being ejected and prompt the user to remove the disc.

If you have ejected a disc and have not removed it within 15 seconds, it will be reloaded. If the CD is not removed, the radio will continue to play the non-removed CD. If the CD is removed and there are other CD's in the radio, the radio will play the next CD after a 2 minute timeout. If the CD is removed and there are no other CD's in the radio, the radio will remain in CD mode and display "INSERT DISC" for 2 minutes. After 2 minutes the radio will go to the previous tuner mode.

**MSG or INFO Button (CD Mode for MP3 Play)**

Press and MSG or INFO button while playing MP3 disc. The radio scrolls through the following TAG information: Song Title, Artist, File Name, and Folder Name (if available).

Press the MSG or INFO button once more to return to "elapsed time" priority mode.

Press and hold the MSG or INFO button while in the message display priority mode or elapsed time display priority mode will display the song title for each file.

**RW/FF (CD Mode for MP3 Play)**

Press the FF side of the button to move forward through the MP3 selection.

**TUNE Control (CD Mode for MP3 Play)**

Pressing the TUNE Control allows the adjustment of Tone, Balance, and Fade.

**AM/FM Button (CD Mode for MP3 Play)**

Switches back to Radio mode.

**RND/ PTY Button (CD Mode for MP3 Play)**

Pressing this button plays files randomly.

**SET/DIR Button (CD Mode for MP3 Play)**

Press the SET/DIR Button to display folders, when playing an MP3 discs that have a file/folder structure. Turn the TUNE control to display available folders or move through available folders. Press the TUNE control to select a folder.

**Buttons 1 - 6 (CD Mode for MP3 Play)**

Selects disc positions 1 - 6 for Play/Load/Eject.

**Operating Instructions - Hands Free Phone (If Equipped)**

Refer to Hands Free Phone in Section 3 of the Owner's Manual.

**Operating Instructions - Satellite Radio Mode (If Equipped)**

Refer to the Satellite Radio section of the Owner's Manual.

**Operating Instructions - Video Entertainment System (VES®) (If Equipped)**

Refer to separate Video Entertainment System (VES®) Guide.

**SALES CODE RAK – AM/FM/CASSETTE/CD (6-DISC) RADIO WITH OPTIONAL SATELLITE RADIO, HANDS FREE PHONE, VIDEO, MP3, and WMA CAPABILITIES**

**NOTE:** The radio sales code is located on the lower right side of your radio faceplate.

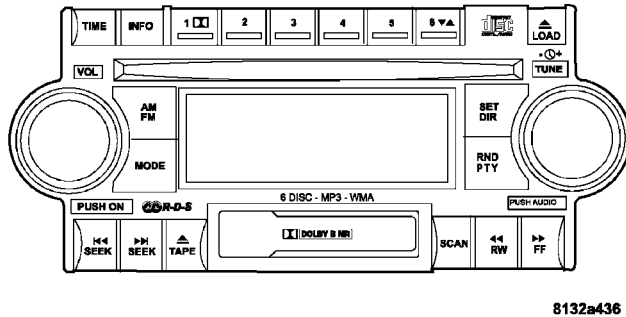

8132a436

### RAK Radio

#### Operating Instructions - Radio Mode

**NOTE:** The ignition switch must be in the ON or ACC position to operate the radio.

#### Power Switch/Volume Control (Rotary)

Press the ON/VOL control to turn the radio ON. Press the ON/VOL a second time to turn OFF the radio.

#### Electronic Volume Control

The electronic volume control turns continuously (360 degrees) in either direction without stopping. Turning the volume control to the right increases the volume and to the left decreases it.

When the audio system is turned on, the sound will be set at the same volume level as last played.

#### Mode Button (Radio Mode)

Press the mode button repeatedly to select between the CD player, Cassette, Satellite, or Vehicle Entertainment System (VES) (if equipped).

#### SEEK Button (Radio Mode)

Press and release the SEEK button to search for the next station in either AM/FM or Satellite (if equipped) mode.

Press the right side of the button to seek up and the left side to seek down. The radio will remain tuned to the new station until you make another selection. Holding the button and will bypass stations without stopping until you release it.

### **SCAN Button (Radio Mode)**

Pressing the SCAN button causes the tuner to search for the next station, in either AM, FM or Satellite (if equipped) frequencies, pausing for 5 seconds (satellite scan 8 seconds) at each listenable station before continuing to the next. To stop the search, press SCAN a second time.

### **Time Button**

Press the time button and the time of day will display for 5 seconds.

### **Clock Setting Procedure**

1. Press and hold the time button until the hours blink.
2. Adjust the hours by turning the right side Tune/Audio control.
3. After the hours are adjusted, press the right side Tune/Audio control to set the minutes. The minutes will begin to blink.
4. Adjust the minutes using the right side Tune/Audio control.
5. To exit, press any button/knob or wait 5 seconds.

### **INFO Button (Radio Mode)**

Press the INFO button for an RBDS station (one with call letters displayed). The radio will return a Radio Text message broadcast (if available) from an FM station (FM mode only).

**RW/FF (Radio Mode)**

Pressing the rewind/fast forward button causes the tuner to search for the next frequency in the direction of the arrows. This feature operates in either AM, FM or Satellite (if equipped) frequencies.

**TUNE Control (Radio Mode)**

Turn the right side rotary control to increase or decrease the frequency.

**AM/FM Button (Radio Mode)**

Press the button to select AM or FM Modes.

**Setting the Tone, Balance, and Fade**

Press the rotary TUNE control and BASS will display. Turn the TUNE control to the right or left to increase or decrease the Bass tones.

Press the rotary TUNE control a second time and MID will display. Turn the TUNE control to the right or left to increase or decrease the Mid Range tones.

Press the rotary TUNE control a third time and TREBLE will display. Turn the TUNE control to the right or left to increase or decrease the Treble tones.

Press the rotary TUNE control a fourth time and BAL will display. Turn the TUNE control to the right or left to adjust the sound level from the right or left side speakers.

Press the rotary TUNE control a fifth time and FADE will display. Turn the TUNE control to the right or left to adjust the sound level between the front and rear speakers.

Press the rotary TUNE control again to exit setting tone, balance, and fade.

**RND/PTY Button (Radio Mode)**

Pressing this button once will turn on the PTY mode for 5 seconds. If no action is taken during the 5-second time out, the PTY icon will turn off. Turning the tune knob



within 5 seconds will allow the program format type to be selected. Many radio stations do not currently broadcast PTY information.

Turn the tune knob to select the following format types:

<b>Program Type</b>	<b>16 Digit-Character Display</b>
No program type or undefined	None
News	News
Information	Information
Sports	Sports
Talk	Talk
Rock	Rock
Classic Rock	Classic_Rock
Adult Hits	Adult_Hits
Soft Rock	Soft_Rock
Top 40	Top_40

Country	Country
Oldies	Oldies
Soft	Soft
Nostalgia	Nostalgia
Jazz	Jazz
Classical	Classical
Rhythm and Blues	Rhythm_and_Blues
Soft Rhythm and Blues	Soft_R_&_B
Foreign Language	Foreign_Language
Religious Music	Religious_Music
Religious Talk	Religious_Talk
Personality	Personality
Public	Public
College	College
Unassigned	
Weather	Weather

By pressing the SEEK button when the PTY icon is displayed, the radio will be tuned to the next frequency station with the same selected PTY name. The PTY function only operates when in the FM mode.

If a preset button is activated while in the PTY (Program Type) mode, the PTY mode will be exited and the radio will tune to the preset station.

**NOTE:** If you have selected a PTY with the tune knob, simply pressing the tune button in will go directly to a “PTY seek”.

### **Buttons 1 - 6 (Radio Mode)**

These buttons tune the Radio to the stations that you commit to push-button memory {12 AM, 12 FM, and 12 Satellite (if equipped) stations}.

### **Operating Instructions — Tape Player**

Insert the cassette with the exposed tape side toward the left and the mechanical action of the player will gently pull the cassette into the play position.

**NOTE:** When subjected to extremely cold temperatures, the tape mechanism may require a few minutes to warm up for proper operation. Sometimes poor playback may be experienced due to a defective cassette tape. Clean and demagnetize the tape heads at least twice a year.

### **Seek Button**

Press the SEEK button up for the next selection on the tape and down to return to the beginning of the current selection.

Press the SEEK button up or down to move the track number to skip forward or backward 1 to 6 selections. Press the SEEK button once to move 1 selection, twice to move 2 selections, etc.

**Fast Forward (FF)**

Press the FF button up momentarily to advance the tape in the direction that it is playing. The tape will advance until the button is pressed again or the end of the tape is reached. At the end of the tape, the tape will play in the opposite direction.

**Rewind (RW)**

Press the RW button momentarily to reverse the tape direction. The tape will reverse until the button is pressed again or until the end of the tape is reached. At the end of the tape, the tape will play in the opposite direction.

**Tape Eject**

Press this button and the cassette will disengage and eject from the radio.

**Scan Button**

Press this button to play 10 seconds of each selection. Press the scan button a second time to cancel the feature.

**Changing Tape Direction**

If you wish to change the direction of tape travel (side being played), press Preset 6. The lighted arrow in the display window will show the new direction.

**Metal Tape Selection**

If a standard metal tape is inserted into the player, the player will automatically select the correct equalization.

**Pinch Roller Release**

If ignition power or the radio ON/OFF switch is turned off, the pinch roller will automatically retract to protect the tape from any damage. When power is restored to the tape player, the pinch roller will automatically reengage and the tape will resume play.

### Noise Reduction

The Dolby Noise Reduction System\* is on whenever the tape player is on, but may be switched off.

To turn off the Dolby Noise reduction System: Press Preset 1 after you insert the tape. The NR light in the display will go off when the Dolby System is off.

\* "Dolby" noise reduction is manufactured under license from Dolby Laboratories Licensing Corporation. Dolby and the double-D symbol are trademarks of Dolby Laboratories Licensing Corporation.

### Operation Instructions - (CD MODE for CD Audio Play)

**NOTE:** The ignition switch must be in the ON or ACC position to operate the radio.

**NOTE:** Note: This Radio is capable of playing compact discs (CD), recordable compact discs (CD-R), rewritable

compact discs (CD-RW) compact discs with MP3 tracks and multisection compact discs with CD and MP3 tracks and WMA.

### Inserting Compact Disc(s)

#### CAUTION!

**This CD player will accept 4 3/4 inch (12 cm) discs only. The use of other sized discs may damage the CD player mechanism.**

You may eject a disc with the radio OFF.

If you insert a disc with the ignition ON and the radio ON, the unit will switch from radio to CD mode and begin to play when you insert the disc. The display will show the disc number, the track number, and index time in minutes and seconds. Play will begin at the start of track 1.

**SEEK Button (CD MODE for CD Audio Play)**

Press the right side of the SEEK button for the next selection on the CD. Press the left side of the button to return to the beginning of the current selection, or return to the beginning of the previous selection if the CD is within the first 5 seconds of the current selection.

**SCAN Button (CD MODE for CD Audio Play)**

Press the Scan button to scan through each track on the CD currently playing.

**LOAD/EJECT Button (CD Mode for CD Audio Play)****LOAD/EJECT - Load**

Press the LOAD/EJT button and the push-button with the corresponding number where the CD is being loaded. The radio will display PLEASE WAIT and prompt when to INSERT DISC. After the radio displays "INSERT DISC," insert the CD into the player.

Radio display will show "LOADING DISC" when the disc is loading and "READING DISC" when the radio is reading the disc.

**LOAD/EJT - Eject**

Press the LOAD/EJT button and the push-button with the corresponding number where the CD was loaded and the disc will unload and move to the entrance for easy removal. Radio display will show "EJECTING DISC" when the disc is being ejected and prompt the user to remove the disc.

Press and hold the LOAD/EJT button for 5 seconds and all CDs will be ejected from the radio.

If you have ejected a disc and have not removed it within 15 seconds, it will be reloaded. If the CD is not removed, the radio will continue to play the non-removed CD. If the CD is removed and there are other CD's in the radio, the radio will play the next CD after a 2-minute timeout. If the CD is removed and there are no other CD's in the

radio, the radio will remain in CD mode and display "INSERT DISC" for 2 minutes. After 2 minutes, the radio will go to the previous tuner mode.

The disc can be ejected with the radio and ignition OFF.

#### **TIME Button (CD MODE for CD Audio Play)**

Press this button to change the display from a large CD playing time display to a small CD playing time display.

#### **RW/FF (CD MODE for CD Audio Play)**

Press and hold FF (Fast Forward) and the CD player will begin to fast forward until FF is released or RW or another CD button is pressed. The RW (Reverse) button works in a similar manner.

#### **TUNE Control (CD MODE for CD Audio Play)**

Pressing the TUNE control allows the setting of the Tone, Fade, and Balance. See Radio Mode.

#### **AM/FM Button (CD MODE for CD Audio Play)**

Switches the Radio to the Radio mode.

#### **RND/PTY Button (Random Play Button) (CD MODE for CD Audio Play)**

Press this button while the CD is playing to activate Random Play. This feature plays the selections on the compact disc in random order to provide an interesting change of pace.

**NOTE:** MP3 and WMA Random Play are for file folders only.

Press the SEEK button to move to the next randomly selected track.

Press and hold the FF button to fast forward through the tracks. Release the FF button to stop the fast forward feature. If the RW button is pressed, the current track will reverse to the beginning of the track and begin playing.

Press the RND button a second time to stop Random Play.

**Buttons 1 - 6 (CD MODE for CD Audio Play)**

Selects disc positions 1 - 6 for Play/Load/Eject.

**Notes On Playing MP3 Files**

The radio can play MP3 files; however, acceptable MP3 file recording media and formats are limited. When writing MP3 files, pay attention to the following restrictions.

**Supported Media (Disc Types)**

The MP3 file recording media supported by the radio are CD-ROM, CD-R, and CD-RW.

**Supported Medium Formats (File Systems)**

The medium formats supported by the radio are ISO 9660 Level 1 and Level 2 and includes the Joliet extension. When reading discs recorded using formats other than ISO 9660 Level 1 and Level 2, the radio may fail to read files properly and may be unable to play the file normally. UDF and Apple HFS formats are not supported.

The radio uses the following limits for file systems:

- Maximum number of directory levels: 15
- Maximum number of files: 255
- Maximum number of folders: 100
- Maximum number of characters in file/folder names:
  - Level 1: 12 (including a separator "." and a 3-character extension)
  - Level 2: 31 (including a separator "." and a 3-character extension)

Multisession disc formats are supported by the radio. Multisession discs may contain combinations of normal CD audio tracks and computer files (including MP3 files). Discs created with an option such as "keep disc open after writing" are most likely multisession discs. The use of multisession for CD audio or MP3 playback may result in longer disc loading times.

### Supported MP3 File Formats

The radio will recognize only files with the \*.mp3 extension as MP3 files. Non-MP3 files named with the \*.mp3 extension may cause playback problems. The radio is designed to recognize the file as an invalid MP3 and will not play the file.

When using the MP3 encoder to compress audio data to an MP3 file, the bit rate and sampling frequencies in the following table are supported. In addition, variable bit rates (VBR) are also supported. The majority of MP3 files use a 44.1 kHz sampling rate and a 192, 160, 128, 96 or VBR bit rates.

MPEG Specification	Sampling Frequency (kHz)	Bit rate (kbps)
MPEG-1 Audio Layer 3	48, 44.1, 32	320, 256, 224, 192, 160, 128, 112, 96, 80, 64, 56, 48, 40, 32
MPEG-2 Audio Layer 3	24, 22.05, 16	160, 128, 144, 112, 96, 80, 64, 56, 48, 40, 32, 24, 16, 8

ID3 Tag information for artist, song title, and album title are supported for version 1 ID3 tags. ID3 version 2 is not supported by the radios.

Playlist files are not supported. MP3 Pro files are not supported.



### Playback of MP3 and WMA Files

When a medium containing MP3 data is loaded, the radio checks all files on the medium. If the medium contains a lot of folders or files, the radio will take more time to start playing the MP3 files.

Loading times for playback of MP3 and WMA files may be affected by the following:

- Media - CD-RW media may take longer to load than CD-R media
- Medium formats - Multisession discs may take longer to load than non-multisession discs
- Number of files and folders - Loading times will increase with more files and folders

To increase the speed of disc loading, it is recommended to use CD-R media and single-session discs. To create a single-session disc, enable the Disc at Once option before writing to the disc.

### Operation Instructions - (CD Mode for MP3 and WMA Audio Play)

#### SEEK Button (CD Mode for MP3 and WMA Play)

Pressing the right side of the SEEK button plays the next file. Pressing the left side of the SEEK button plays the beginning of the file. Pressing the button within the first ten seconds plays the previous file.

#### LOAD/EJECT Button (CD Mode for MP3 and WMA Play)

##### LOAD/EJT - Load



Press the LOAD/EJT button and the push-button with the corresponding number where the CD is being loaded. The radio will display PLEASE WAIT and prompt when to INSERT DISC. After the radio displays "INSERT DISC," insert the CD into the player.

The radio display will show "LOADING DISC" when the disc is loading.

### **LOAD/EJT - Eject**



Press the LOAD/EJT button and the push-button with the corresponding number where the CD was loaded and the disc will unload and move to the entrance for easy removal.

Radio display will show "EJECTING DISC" when the disc is being ejected and prompt the user to remove the disc.

If you have ejected a disc and have not removed it within 15 seconds, it will be reloaded. If the CD is not removed, the radio will continue to play the non-removed CD. If the CD is removed and there are other CD's in the radio, the radio will play the next CD after a 2-minute timeout. If the CD is removed and there are no other CD's in the radio, the radio will remain in CD mode and display "INSERT DISC" for 2 minutes. After 2 minutes, the radio will go to the previous tuner mode.

### **INFO Button (CD Mode for MP3 Play)**

Press and INFO button while playing MP3 or WMA disc. The radio scrolls through the following TAG information: Song Title, Artist, File Name, and Folder Name (if available).

Press the INFO button once more to return to "elapsed time" priority mode.

Press and hold the INFO button while in the message display priority mode or elapsed time display priority mode will display the song title for each file.

### **RW/FF (CD Mode for MP3 and WMA Play)**

Press the FF side of the button to move forward through the file or MP3 and WMA selection.

### **TUNE Control (CD Mode for MP3 Play)**

Pressing the TUNE Control allows the adjustment of Tone, Balance, and Fade.

**AM/FM Button (CD Mode for MP3 Play)**

Switches back to Radio mode.

**RND/PTY Button (CD Mode for MP3 Play)**

Pressing this button plays files randomly.

**SET/DIR Button (CD Mode for MP3 Play)**

Press the SET/DIR Button to display folders, when playing an MP3 discs that have a file/folder structure. Turn the TUNE control to display available folders or move through available folders. Press the TUNE control to select a folder.

**Buttons 1 - 6 (CD Mode for MP3 Play)**

Selects disc positions 1 - 6 for Play/Load/Eject.

**Operating Instructions - Hands Free Phone (If Equipped)**

Refer to “Hands-Free Phone” in Section 3 of the Owner’s Manual.

**Operating Instructions - Satellite Radio Mode (If Equipped)**

Refer to the “Satellite Radio” section of the Owner’s Manual.

**Operating Instructions - Video Entertainment System (VES) (If Equipped)**

Refer to separate “Video Entertainment System (VES) Guide.”

## SALES CODE REC — AM/FM/CD (6-DISC) RADIO WITH NAVIGATION SYSTEM

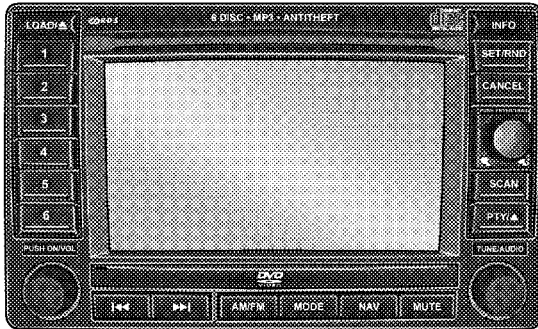

8125e256

### REC Radio

Satellite Navigation Radio with CD Player with MP3 Capability (REC) - combines a Global-Positioning System-based navigation system with an integrated color screen to provide maps, turn identification, selection

menus and instructions for selecting a variety of destinations and routes, AM/FM stereo radio and six-disc CD changer with MP3 capability.

Mapping information for navigation is supplied on a DVD that is loaded into the unit. One map DVD covers all of North America. Refer to your “Navigation User’s Manual” for detailed operating instructions.

### Operating Instructions — Satellite Radio (If Equipped)

Refer to your “Navigation User’s Manual” for detailed operating instructions.

### Clock Setting Procedure

Refer to “Setting the Clock” under “System Settings” in your Navigation User’s Manual for details about setting the clock.

### **SATELLITE RADIO — IF EQUIPPED**

Satellite radio uses direct satellite to receiver broadcasting technology to provide clear digital sound, coast to coast. The subscription service provider is Sirius™ Satellite Radio. This service offers over 100 channels of music, sports, news, entertainment, and programming for children, directly from its satellites and broadcasting studios.

#### **System Activation**

**NOTE:** Your vehicle's radio must be on and in satellite mode when the activation process takes place.

To activate your Sirius Satellite Radio service, call the toll-free number 888-539-7474, or visit the Sirius web site at [www.sirius.com](http://www.sirius.com). Please have the following information available when activating your system:

1. The Electronic Serial Number/Sirius Identification Number (ESN/SID).
2. Credit card information.

3. Your Vehicle Identification Number.

#### **Electronic Serial Number/Sirius Identification Number (ESN/SID)**

The Electronic Serial Number/Sirius Identification Number is needed to activate your Sirius Satellite Radio system. To access the ESN/SID, refer to the following steps:

#### **ESN/SID Access With REF Radios**

With the ignition switch in the ACCESSORY position and the radio OFF, press the CD Eject and Time buttons simultaneously for 3 seconds. The first four digits of the twelve-digit ESN/SID number will display. Press the SEEK UP button to display the next four digits. Continue to press the SEEK UP button until all twelve ESN/SID digits display. The SEEK DOWN will page down until the first four digits display. The radio will exit the

ESN/SID mode when any other button is pushed, the ignition is turned OFF, or 5 minutes has passed since any button was pushed.

### **ESN/SID Access With RAQ and RAK Radios**

With the ignition switch in the ACCESSORY position and the radio OFF, press the CD Eject and TIME buttons simultaneously for 3 seconds. All twelve ESN/SID numbers will display. The radio will exit the ESN/SID mode when any other button is pushed, the ignition is turned OFF, or 5 minutes has passed since any button was pushed.

### **ESN/SID Access With REC Navigation Radios**

Please refer to your Navigation User's Manual.

With the ignition in the ACCESSORY position and the radio off, press the CD Eject and Set buttons simultaneously until the 12 digits of the ESN/SID appear on the screen.

## **Selecting Satellite Mode in REF, RAQ, and RAK Radios**

### **Selecting Satellite Mode — REF Radio**

Press the MODE button repeatedly until the word "SAT" appears in the display.

A CD may remain in the radio while in the Satellite radio mode.

### **Selecting Satellite Mode — RAQ and RAK Radio**

Press the MODE button repeatedly until the word "SAT" appears in the display.

These radios will also display the current station name and program type. For more information, such as song title and artist press the MSG or INFO button.

A CD or tape may remain in the radio while in the Satellite radio mode.

### Selecting a Channel

Press and release the SEEK or TUNE knob to search for the next channel. Press the top of the button to search up and the bottom of the button to search down. Holding the TUNE button causes the radio to bypass channels until the button is released.

Press and release the SCAN button (if equipped) to automatically change channels every 7 seconds. The radio will pause on each channel for 7 seconds before moving on to the next channel. The word "SCAN" will appear in the display between each channel change. Press the SCAN button a second time to stop the search.

**NOTE:** Channels that may contain objectionable content can be blocked. Contact Sirius Customer Care at 888-539-7474 to discuss options for channel blocking or unblocking. Please have your ESN/SID information available.

### Storing and Selecting Pre-Set Channels

In addition to the 12 AM and 12 FM pre-set stations, you may also commit 12 satellite stations to push button memory. These satellite channel pre-set stations will not erase any AM or FM pre-set memory stations. Follow the memory pre-set procedures that apply to your radio.

### Using the PTY (Program Type) Button (if equipped)

Follow the PTY button instructions that apply to your radio.

### PTY Button "SCAN"

When the desired program type is obtained, press the "SCAN" button within five seconds. The radio will play 7 seconds of the selected channel before moving to the next channel of the selected program type. Press the "SCAN" button a second time to stop the search.

**NOTE:** Pressing the "SEEK" or "SCAN" button, while performing a music type scan, will change the channel by

one and stop the search. Pressing a pre-set memory button during a music type scan, will call up the memory channel and stop the search.

### **PTY Button "SEEK"**

When the desired program is obtained, press the "SEEK" button within five seconds. The channel will change to the next channel that matches the program type selected.

### **Satellite Antenna**

To ensure optimum reception, do not place items on the roof around the rooftop antenna location. Metal objects placed within the line of sight of the antenna will cause decreased performance. Larger luggage items should be placed as far forward as possible. Do not place items directly on or above the antenna.

### **Reception Quality**

Satellite reception may be interrupted due to one of the following reasons.

- The vehicle is parked in an underground parking structure or under a physical obstacle.
- Dense tree coverage may interrupt reception in the form of short audio mutes.
- Driving under wide bridges or along tall buildings can cause intermittent reception.
- Placing objects over or too close to the antenna can cause signal blockage.



## REMOTE SOUND SYSTEM CONTROLS — IF EQUIPPED

The remote sound system controls are located on the rear surface of the steering wheel. Reach behind the wheel to access the switches.

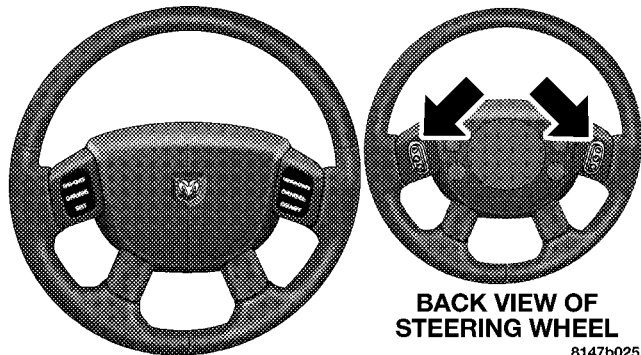

Remote Sound System Controls

The right hand control is a rocker type switch with a button in the center. Pressing the top of the switch will increase the volume and pressing the bottom of the switch will decrease the volume. The center button of the right hand control will allow you to change the mode.

The left hand control is a rocker type switch with a push button in the center. The function of the left hand control is different depending on which mode you are in.

The following describes the left hand control operation in each mode.

### Radio Operation

Pressing the top of the left side switch will SEEK up for the next listenable station and pressing the bottom of the switch will SEEK down for the next listenable station.

The button located in the center of the left hand control will tune to the next pre-set station that you have programmed in the radio pre-set push-buttons.

### **Tape Player**

Pressing the top of the switch once will go to the next selection on the cassette. Pressing the bottom of the switch once will go to the beginning of the current selection or to the beginning of the previous selection if it is within the first 5 seconds of the current selection.

If you press the switch up or down twice it plays the second selection, three times, it will play the third, etc.

The button in the center of the left hand switch has no function in this mode.

### **CD Player**

Pressing the top of the switch once will go to the next track on the CD. Pressing the bottom of the switch once will go to the beginning of the current track or to the beginning of the previous track if it is within one second after the current track begins to play.

If you press the switch up or down twice it plays the second track, three times, it will play the third, etc.

The button in the center of the left hand switch has no function in this mode.

### **CASSETTE TAPE AND PLAYER MAINTENANCE**

To keep the cassette tapes and player in good condition, take the following precautions:

1. Do not use cassette tapes longer than C-90; otherwise, sound quality and tape durability will be greatly diminished.
2. Keep the cassette tape in its case to protect from slackness and dust when it is not in use.
3. Keep the cassette tape away from direct sunlight, heat and magnetic fields such as the radio speakers.
4. Before inserting a tape, make sure that the label is adhering flatly to the cassette.

5. A loose tape should be corrected before use. To rewind a loose tape, insert the eraser end of a pencil into the tape drive gear and twist the pencil in the required directions.

Maintain your cassette tape player. The head and capstan shaft in the cassette player can pick up dirt or tape deposits each time a cassette is played. The result of deposits on the capstan shaft may cause the tape to wrap around and become lodged in the tape transport. The other adverse condition is low or “muddy” sound from one or both channels, as if the treble tone control were turned all the way down. To prevent this, you should periodically clean the head with a commercially available WET cleaning cassette.

As preventive maintenance, clean the head about every 30 hours of use. If you wait until the head becomes very dirty (noticeably poor sound), it may not be possible to remove all deposits with a simple WET cleaning cassette.

### **COMPACT DISC MAINTENANCE**

To keep the compact discs in good condition, take the following precautions:

1. Handle the disc by its edge; avoid touching the surface.
2. If the disc is stained, clean the surface with a soft cloth, wiping from center to edge.
3. Do not apply paper or tape to the disc; avoid scratching the disc.
4. Do not use solvents such as benzene, thinner, cleaners, or antistatic sprays.
5. Store the disc in its case after playing.
6. Do not expose the disc to direct sunlight.
7. Do not store the disc where temperatures may become too high.

**NOTE:** If you experience difficulty in playing a particular disc, it may be damaged, oversized, or have theft protection encoding. Try a known good disc before considering disc player service.

### **RADIO OPERATION AND CELLULAR PHONES**

Under certain conditions, the operation of a cellular phone in your vehicle can cause erratic or noisy performance from your radio. This condition may be lessened or eliminated by relocating the cellular phone antenna. This condition is not harmful to the radio. If your radio performance does not satisfactorily “clear” by the repositioning of the antenna, it is recommended that the radio volume be turned down or off during cellular phone operation.

### **CLIMATE CONTROLS**

The controls for the heating and ventilation system in this vehicle consist of a series of rotary knobs. These comfort controls can be set to obtain desired interior conditions.

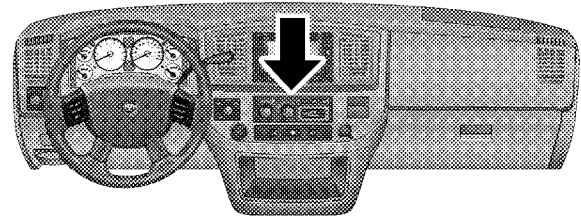

8164639b

**Climate Control Location**

## Heater Only — Fleet Vehicles

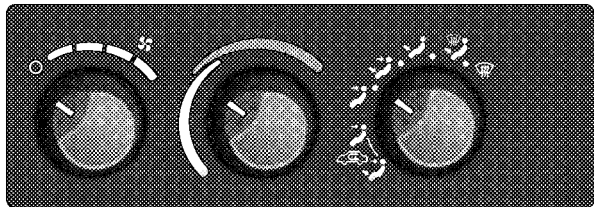

Manual Heating Controls

81646397

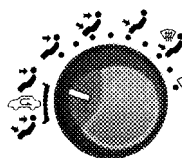

816463c5

The mode control (at the right of the control panel) can be set in any of the following positions:

**NOTE:** To improve your selection choices, the system allows you to operate at intermediate positions between the major modes. These intermediate positions are identified by the small dots.

### Panel

 Outside air flows through the outlets located in the instrument panel.

### Recirculation Modes (Panel or Bi-Level)

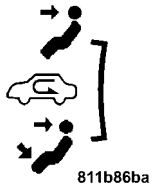

Select the recirculation modes when the outside air contains smoke or odors. This feature allows for recirculation of interior air only. Air flows through the panel outlets in this mode. Air flows through the panel only or

through both the panel and floor vents depending on the selected mode (panel vs bi-level).

#### Bi-Level

Outside air flows through the outlets located in the instrument panel and at the floor.

#### Mix

Outside air flows in equal proportions through the floor and defroster outlets.

### Defrost



Outside air is primarily directed to the windshield through the defroster outlets located at the base of the windshield, and the demister outlets located at the edge of each side of the instrument panel.

### Blower Control



816463cd

The rotary knob on the left of the control panel is the blower control. Turn the knob clockwise to one of the four positions to obtain the blower speed you desire. To turn the blower off, turn the knob to the far left position.

### Temperature Control

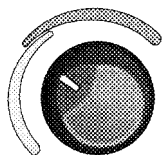

816463c9

right (red region) of the rotation.

The rotary knob at the center of the control panel controls the temperature of the interior air. You can choose your degree of comfort by rotating the knob. The coldest temperature setting is to the extreme left (blue region) and the warmest setting is to the extreme

### Air Conditioning and Heating — If Equipped

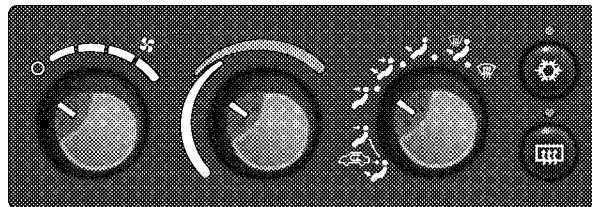

81646393

#### Air Conditioning And Heating

##### Air Conditioning Operation



To turn on the Air Conditioning, set the fan control at any speed and press the snowflake button located at the right of the control panel. Conditioned air will be directed through the

outlets selected by the mode control. A light in the snowflake button shows that the air conditioning is on. Press the button a second time to turn the air conditioning off.

Slight changes in engine speed or power may be noticed when the air conditioning compressor is on. This is a normal occurrence as the compressor will cycle on and off to maintain comfort and increase fuel economy.



816463c5

The mode control (at the right of the control panel) can be set in any of the following positions:

**NOTE:** To improve your selection choices, the system allows you to operate at intermediate positions between the major modes. These intermediate positions are identified by the small dots.

### Recirculation Modes (Panel or Bi-Level)

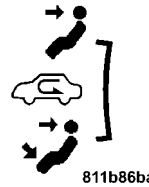

811b86ba

Select the recirculation modes when the outside air contains smoke, odors, high humidity, or if rapid cooling is desired. This feature allows for recirculation of interior air only. Air flows through the panel only or through both the panel and floor vents depending on the selected mode (panel vs bi-level).

**NOTE:** Selecting a “Recirculation Mode” mode does not necessarily consume more fuel than normal A/C mode.

#### Panel

 Outside air flows through the outlets located in the instrument panel.



**Bi-Level**

 Outside air flows through the outlets located in the instrument panel and at the floor.

**Floor**

 Outside air flows primarily through the floor outlets located under the instrument panel.

**Mix**

 Outside air flows in equal proportions through the floor and defroster outlets, and the air conditioning may be on.

**Defrost**

 Outside air is primarily directed to the windshield through the defroster outlets located at the base of the windshield, and the demister outlets located at the edge of each side of the instrument panel, and the air conditioning may be on.

**Blower Control**

The rotary knob on the left of the control panel is the blower control. Turn the knob clockwise to one of the four positions to obtain the blower speed you desire. To turn the blower off, turn the knob to the far left position.

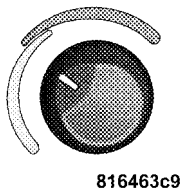
**Temperature Control**

The rotary knob at the center of the control panel controls the temperature of the interior air. You can choose your degree of comfort by rotating the knob. The coldest temperature setting is to the extreme left (blue region) and the warmest setting is to the extreme right (red region) of the rotation.

### Circulation

The cab is designed with features to promote outside air circulation. There are grilles in the cab back panel. These are air exhausters that provide the means for regular exchange of cab air.

Side window demisters direct air flow specifically to the window glass to help prevent interior fogging of the glass. They are located in the extreme outside upper edges of the instrument panel. The demisters also provide extra air ducts for circulation. They are in operation whenever the Floor, Mix or Defrost modes are in use. To remove frost from the side windows, it is best to use the full defrost mode.

**NOTE:** When you turn off the engine you may hear a hissing sound from under the hood for a short period of time. This is a normal condition that occurs if the air conditioning system has been on. It is not an indication of a problem with the air conditioning system.

### Air Conditioning with Dual Zone Temperature Control — If Equipped

With the Dual Zone Temperature Control System, each front seat occupant can independently control the temperature of air coming from the outlets on their side of the vehicle.

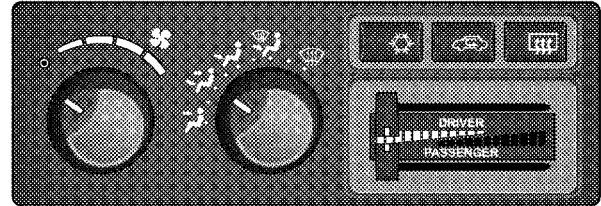

Dual Zone Control Head

8164638f

### Air Conditioning and Heating Operation

To turn on the Air Conditioning, set the fan control at any speed and press the snowflake button located on the control panel. Conditioned air will be directed through the outlets selected by the mode control. A light in the snowflake button shows that the air conditioning is on. Press the button a second time to turn the air conditioning off.

### A/C Pushbutton

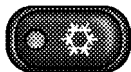

80d0bd96

With the fan control in the ON position, pushing the A/C button turns on the air conditioning compressor. An indicator light on the button shows that the Air Conditioning compressor is on. Conditioned air is now directed through the mode outlets selected.

Pushing the button a second time turns the compressor OFF.

### Recirculation Pushbutton



811b86fe

Pushing the Recirculation button allows interior air to recirculate continuously in any position except defrost and defrost/floor mode for rapid cool down of the interior. See “Fast Cooldown” later in this section.

### Mode Control



816463c5

The mode control allows you to choose from several patterns of air distribution.

**NOTE:** To improve your selection choices, the system allows you to operate at intermediate positions between

the major modes. These intermediate positions are identified by the small dots and give an even blend of both modes.

### Panel

 Outside air flows through the outlets located in the instrument panel. These outlets can be adjusted to direct the airflow.

### Bi-Level

 Air flows through the outlets located in the instrument panel and those located on the floor.

**NOTE:** There is a difference in temperature between the upper and lower outlets for added comfort. The warmer air goes to the floor outlets. This feature gives improved comfort during sunny but cool conditions.

### Heat

 Outside air flows primarily through the floor outlets located under the instrument panel.

### Mix

 Outside air flows in equal proportions through the floor and defroster outlets.

### Defrost

 Outside air is primarily directed to the windshield through the defroster outlets located at the base of the windshield and side window demist outlets.

**NOTE:** The air conditioning compressor operates in both Mix and Defrost or a blend of these modes, even if the A/C button has not been pressed. This dehumidifies the air to help dry the windshield.

### Blower Control



816463cd

The rotary knob on the left of the control panel is the blower control. Turn the knob clockwise to one of the four positions to obtain the blower speed you desire. To turn the blower off, turn the knob to the far left position.

### Dual Zone Temperature Control

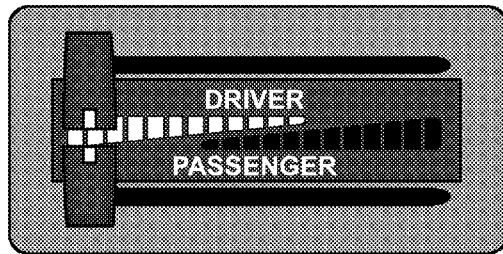

816463c0

### Dual Zone Temperature Control

Use this control to regulate the temperature of the air inside the passenger compartment. This is accomplished by having separate temperature control slides for both

the driver and front passenger. The blue area of the scale indicates cooler temperatures while the red area indicates warmer temperatures.

### **Circulation**

The cab is designed with features to promote outside air circulation. There are grilles in the cab back panel. These are air exhausters that provide the means for regular exchange of cab air.

Side window demisters direct air flow specifically to the window glass to help prevent interior fogging of the glass. They are located in the extreme outside upper edges of the instrument panel. The demisters also provide extra air ducts for circulation. They are in operation whenever the Floor, Mix or Defrost modes are in use.

**NOTE:** When you turn off the engine you may hear a hissing sound from under the hood for a short period of time. This is a normal condition that occurs if the air

conditioning system has been on. It is not an indication of a problem with the air conditioning system.

### **Operating Tips**

#### **Fast Cooldown**

For a fast cooldown, turn the blower fan rotary knob to the extreme right position, turn the mode control to the panel fresh position, press the snowflake button to turn on the air conditioning, and drive with the windows open for the first few minutes. Once the hot air has been expelled, close the windows and press the Recirculation push-button. When a comfortable condition has been reached, choose a mode position and adjust the temperature control slide and blower speed as necessary to maintain comfort. For high humidity conditions it may be necessary to remain in the Recirculation mode to maintain comfort.

### **Window Fogging**

Windows will fog on the inside when the humidity inside the vehicle is high. This often occurs in mild or cool temperatures when it's rainy or humid. In most cases turning on the Air-conditioning (pressing the snowflake button) will clear the fog. Adjust the temperature control, air direction and blower speed to maintain comfort.

As the temperature gets colder it may be necessary to direct air onto the windshield by using MIX Mode position on the control. Adjust the temperature control and blower speed to maintain comfort. Higher blower speeds will reduce fogging. Interior fogging on the windshield can be quickly removed by selecting the defrost mode.

Regular cleaning of the inside of the windows with a non-filming cleaning solution (vinegar and water works very well) will help prevent contaminants (cigarette

smoke, perfumes, etc.) from sticking to the windows. Contaminates increase the rate of window fogging.

### **Summer Operation**

Air conditioned vehicles must be protected with a high quality antifreeze coolant during summer to provide proper corrosion protection and to raise the boiling point of the coolant for protection against overheating. A 50 % concentration is recommended. Refer to Recommended Fluids and Genuine Parts for the proper coolant type.

When using the air conditioner in extremely heavy traffic in hot weather especially when towing a trailer, additional engine cooling may be required. If this situation is encountered, operate the transmission in a lower gear to increase engine RPM, coolant flow and fan speed. When stopped in heavy traffic, it may be necessary to shift into NEUTRAL and depress the accelerator slightly for fast idle operation to increase coolant flow and fan speed.

**NOTE:** On models equipped with Diesel engines, the idle speed will automatically increase to 1000 rpm at elevated coolant temperatures to improve engine cooling.























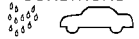





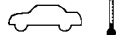

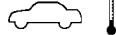

Your air conditioning system is also equipped with an automatic recirculation system. When the system senses a heavy load or high heat conditions, it may use partial Recirculation A/C mode to provide additional comfort.

### **Winter Operation**

When operating the system during the winter months, make sure the air intake, located directly in front of the windshield, is free of ice, slush, snow, or other obstructions.



## Operating Tips Chart

WEATHER	CONTROL SETTINGS
<p>HOT WEATHER AND VEHICLE INTERIOR IS VERY HOT</p> 	<p>Start the vehicle, open the windows and turn the blower control knob to the high position (full clockwise). Set Mode control knob at or between  and . Set temperature control to full cold and press the  button on. After the hot air has been expelled, close the windows and turn the mode control knob to the  setting (counterclockwise) at either  or , or press the  button (if so equipped). Once comfortable, choose a mode position and adjust temperature control and blower speed as necessary for comfort.</p>
<p>WARM WEATHER</p> 	<p>If sunny, set the Mode control at or near  and press the  button on. If cloudy or dark, set the Mode control at or near . No  is necessary.</p>
<p>COOL OR COLD HUMID CONDITIONS</p> 	<p>If sunny, set the Mode control at or between  and , then press the  button on. If cloudy or dark set the Mode control at or near . No  is necessary.</p>
<p>COLD DRY CONDITIONS</p> 	<p>In cloudy or dark weather set the Mode control at or near . If sunny, set the Mode control at or between  and , and for snowy or very cold weather requiring extra heat to the windshield, use .</p>
<p>EXTREME COLD CONDITIONS (DIESEL)</p> 	<p>Using re-circulated air can aid initial warm-up in extreme cold conditions. <b>NOTICE: Running in  /MAX for long periods of time will result in window fogging. When this occurs, use  until windows clear. This will deactivate  /MAX. SINGLE ZONE VEHICLES:</b> Set the mode control at  +  /MAX, close the panel vents and set the temperature control to full hot. Turn blower control knob to low and gradually increase as air and engine temperature increase. <b>DUAL ZONE VEHICLES:</b> Set the mode control at , set both temperature controls to full hot and press the  /MAX button. Turn blower control knob to low and gradually increase as air and engine temperature increase.</p>
<p>WINDOW FOGGING</p>	<p>In most cases turning on the Air-Conditioning (press the  button) will clear the fog, then adjust temperature control, air direction and blower speed to maintain comfort. As it gets colder it may be necessary to direct air onto the windshield. If so, set the Mode control at  or  and adjust temperature control and blower speed to maintain comfort. Higher blower speeds will reduce fogging.</p>

# STARTING AND OPERATING

## CONTENTS

---

■ Starting Procedures – Gas Engines . . . . .	245	■ Manual Transmission . . . . .	255
□ Manual Transmission . . . . .	245	□ Manual Transmission — 6 Speed (G56) . . . . .	256
□ Automatic Transmission . . . . .	245	□ Recommended Vehicle Shift Speeds . . . . .	257
□ Normal Starting . . . . .	246	□ Downshifting – All Manual Transmissions . . . . .	257
□ If Engine Fails To Start . . . . .	246	■ Four-Wheel- Drive Operation . . . . .	258
□ After Starting . . . . .	248	□ Manually Shifted Transfer Case Operating Information/Precautions . . . . .	258
■ Engine Block Heater — If Equipped . . . . .	249	□ Shifting Procedure - Manually Shifted Transfer Case . . . . .	261
■ Automatic Transmission . . . . .	249	□ Transfer Case Reminder Light . . . . .	262
□ Automatic Transmission With Overdrive . . . . .	250		

- Limited-Slip Differential — If Equipped . . . . .262
- Driving On Slippery Surfaces . . . . .263
- Axle Locker System . . . . .264
- Stabilizer/Sway Bar System . . . . .267
- Power Wagon – Safe Off-Road Driving . . . . .268
  - Off-Road Driving Tips And Vehicle Characteristics . . . . .268
  - Driving In Snow, Mud And Sand . . . . .273
  - Crossing Obstacles (Rocks And Other High Points) . . . . .275
  - Hill Climbing . . . . .278
  - Driving Through Water . . . . .281
  - Airing Down For Off-Road Driving . . . . .283
  - Vehicle Recovery . . . . .284
  - After Driving Off-Road . . . . .288
- Winch Usage – If Equipped . . . . .289
  - Things To Know Before Using Your Winch . . .289
  - Understanding The Features Of Your Winch . .291
  - Winch Accessories . . . . .293
  - Operating Your Winch . . . . .294
  - Rigging Techniques . . . . .305
- Parking Brake . . . . .308
- Brake System . . . . .309
  - Brake Noise . . . . .310
  - Four-Wheel Anti-Lock Brake System (ABS)—If Equipped . . . . .310
- Power Steering . . . . .312

- Multi Displacement System (MDS) - 5.7L Engine Only . . . . .313
- Tire Safety Information . . . . .313
  - Tire Markings . . . . .313
  - Tire Identification Number (TIN) . . . . .317
  - Tire Loading And Tire Pressure . . . . .318
- Tires — General Information . . . . .322
  - Tire Pressure . . . . .322
  - Tire Inflation Pressures . . . . .323
  - Radial-Ply Tires . . . . .326
  - Compact Spare Tire — If Equipped . . . . .327
  - Limited Use Spare — If Equipped . . . . .328
  - Tire Spinning . . . . .328
  - Tread Wear Indicators . . . . .329
  - Life Of Tire . . . . .330
  - Replacement Tires . . . . .330
  - Alignment And Balance . . . . .331
- Supplemental Tire Pressure Information – If Equipped . . . . .332
- Tire Chains . . . . .332
- Snow Tires . . . . .333
- Tire Rotation Recommendations . . . . .334
- Fuel Requirements . . . . .335
  - Reformulated Gasoline . . . . .335
  - Gasoline/Oxygenate Blends . . . . .336
  - MMT In Gasoline . . . . .336

- Sulfur In Gasoline . . . . . 337
- Materials Added To Fuel . . . . . 337
- Fuel System Cautions . . . . . 338
- Carbon Monoxide Warnings . . . . . 339
- Adding Fuel . . . . . 339
  - Adding Fuel (Gas Engines) . . . . . 339
- Vehicle Loading . . . . . 341
  - Certification Label . . . . . 341
- Trailer Towing . . . . . 345
  - Common Towing Definitions . . . . . 345
  - Trailer Hitch Classification . . . . . 349
  - Trailer Towing Weights (Maximum Trailer Weight Ratings) . . . . . 350
  - Trailer And Tongue Weight . . . . . 350
  - Towing Requirements . . . . . 351
  - Towing Tips . . . . . 356
  - Trailer Towing Mirrors — If Equipped . . . . . 358
- Snowplow . . . . . 359
  - Dodge Power Wagon Models . . . . . 359
- Recreational Towing — 4-Wheel Drive Vehicles (Behind Motorhome, Etc.) . . . . . 360
  - Recreational Towing Procedure — Manual Shift Transfer Case — If Equipped . . . . . 361
  - Returning To Normal Operation — Manual Shift Transfer Case . . . . . 362
- Equipment Identification Plate . . . . . 363

## STARTING PROCEDURES – GAS ENGINES

The starter should not be operated for more than 15-second intervals. Waiting a few seconds between such intervals will protect the starter from overheating.

### WARNING!

**Be sure to turn off the engine if you want to rest or sleep in your car. Accidents can be caused by inadvertently moving the gear selection lever or by pressing the accelerator pedal. This may cause excessive heat in the exhaust system, resulting in overheating and vehicle fire which may cause serious or fatal injuries.**

### WARNING!

**Do not leave children or animals inside parked vehicles in hot weather. Interior heat build up may cause serious injury or death.**

## Manual Transmission

Apply the parking brake, place the gearshift control lever in NEUTRAL and depress the clutch pedal to the floor before starting the vehicle. This vehicle is equipped with a clutch interlocking ignition system. It will not start unless the clutch is fully depressed.

## Automatic Transmission

Start the engine with the selector lever in NEUTRAL or PARK position. Apply the brake before shifting to any driving range.

### Normal Starting

Normal starting of either a warm or cold engine is obtained without pumping or depressing the accelerator pedal. Turn the key to the **START** position and release when the engine starts. If the engine fails to start within 10 seconds, turn the key to the **OFF** position, wait 5 seconds, then repeat the starting procedure.

**NOTE:** This vehicle is equipped with a transmission shift interlocking system. The brake pedal must be depressed to shift out of Park (P).

### Tip Start Feature — Automatic Transmission Only

**Do not** press the accelerator. Turn the ignition key briefly to **START** position, and release it. The starter motor will continue to run, but will automatically disengage itself when the engine is running.

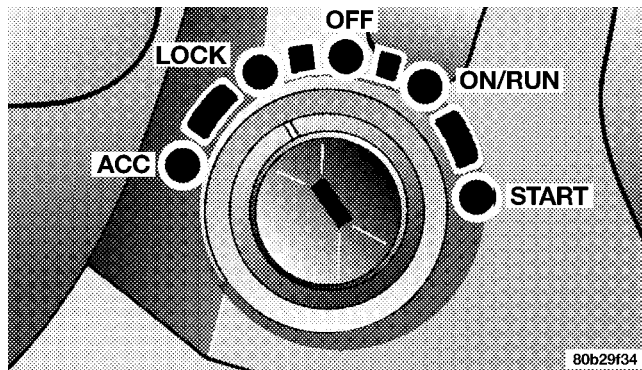

Ignition Key Positions

### If Engine Fails To Start

If the engine fails to start after you have followed the normal starting procedure, it may be flooded. Push the accelerator pedal all the way to the floor and hold it there while cranking the engine. This should clear any excess fuel in case the engine is flooded.

**CAUTION!**

To prevent damage to the starter, do not crank the engine for more than 15 seconds at a time. Wait 10 to 15 seconds before trying again.

**WARNING!**

Never pour fuel or other flammable liquids into the throttle body air inlet opening in an attempt to start the vehicle. This could result in a flash fire causing serious personal injury.

**WARNING!**

Do not attempt to push or tow your vehicle to get it started. Vehicles equipped with an automatic transmission cannot be started this way. Unburned fuel could enter the catalytic converter and once the engine has started, ignite and damage the converter and vehicle. If the vehicle has a discharged battery, booster cables may be used to obtain a start from a booster battery or the battery in another vehicle. This type of start can be dangerous if done improperly. See section 6 of this manual for the proper jump starting procedures and follow them carefully.

If the engine has been flooded, it may start to run, but not have enough power to continue running when the key is



released. If this occurs, continue cranking with the accelerator pedal pushed all the way to the floor. Release the accelerator pedal and the key once the engine is running smoothly.

If the engine shows no sign of starting after two 15 second periods of cranking with the accelerator pedal held to the floor, the normal starting procedure should be repeated.

#### **After Starting**

The idle speed is automatically controlled and will decrease as the engine warms up.

#### **WARNING!**

**Be sure to turn off the engine if you want to rest or sleep in your car. Accidents can be caused by inadvertently moving the gear selection lever or by pressing the accelerator pedal. This may cause excessive heat in the exhaust system, resulting in overheating and vehicle fire which may cause serious or fatal injuries.**

#### **WARNING!**

**Do not leave children or animals inside parked vehicles in hot weather. Interior heat build up may cause serious injury or death.**

**ENGINE BLOCK HEATER — IF EQUIPPED**

The engine block heater warms engine coolant and permits quicker starts in cold weather. Connect the cord to a standard 110-115 volt AC electrical outlet with a grounded, three-wire extension cord.

The engine block heater cord is routed under the hood on the driver side of the vehicle. It has a removable cap that is located on the driver side of the Integrated Power Module.

**WARNING!**

**Remember to disconnect the cord before driving. Damage to the 110-115 volt electrical cord could cause electrocution.**

**AUTOMATIC TRANSMISSION****CAUTION!**

**Damage to the transmission may occur if the following precautions are not observed:**

- **Shift into PARK only after the vehicle has come to a complete stop.**
- **Shift into or out of REVERSE only after the vehicle has come to a complete stop and the engine is at idle speed.**
- **Do not shift from REVERSE, PARK, or NEUTRAL into any forward gear when the engine is above idle speed.**
- **Before shifting into any gear, make sure your foot is firmly on the brake pedal.**

**WARNING!**

**It is dangerous to shift the selector lever out of “P” or “N” if the engine speed is higher than idle speed. If your foot is not firmly on the brake pedal, the vehicle could accelerate quickly forward or in reverse. You could lose control of the vehicle and hit someone or something. Only shift into gear when the engine is idling normally and when your right foot is firmly on the brake pedal.**

**Automatic Transmission with Overdrive**

The gear shift selector display, located in the instrument panel cluster, indicates the transmission gear range (the selector is illuminated for night driving). The selector lever is mounted on the right side of the steering column. You must depress the brake pedal, to pull the selector lever out of park (P) position (Brake Interlock System). To drive, move the selector lever from Park or Neutral to the

desired drive position. Pull the selector lever toward you when shifting into Reverse, Second, First or Park, or when shifting out of Park.

**Gear Ranges**

DO NOT race the engine when shifting from Park or Neutral position into another gear range.

**“P” Park**

This gear position supplements the parking brake by locking the transmission. The engine can be started in this range. Never use Park while the vehicle is in motion. Apply the parking brake when leaving the vehicle in this range. Always apply parking brake first, then place the selector in Park position. On 4-wheel-drive vehicles be sure that the transfer case is in a drive position!

**WARNING!**

Never use Park position on an automatic transmission as a substitute for the parking brake. Always apply parking brake fully when parked to guard against vehicle movement and possible injury or damage.

**WARNING!**

Your vehicle could move and injure you and others if it is not completely in P (Park). Check by trying to move the gearshift lever back and forth without first pulling it toward you after you have set it in P. Make sure it is in Park before leaving the vehicle.

**WARNING!**

It is dangerous to shift the selector lever out of “P” or “N” if the engine speed is higher than idle speed. If your foot is not firmly on the brake pedal, the vehicle could accelerate quickly forward or in reverse. You could lose control of the vehicle and hit someone or something. Only shift into gear when the engine is idling normally and when your right foot is firmly on the brake pedal.

**“R” Reverse**

Use this range only after the vehicle has come to a complete stop.

**“N” Neutral**

Shift to Neutral when the vehicle is standing for prolonged periods with the engine running. The engine may be started in this range. Set the parking brake if you must leave the vehicle.

**NOTE:** Towing the vehicle, coasting, or driving, with the transmission in neutral (N) position, can cause severe damage to the transmission.

**“D” Drive**

This position provides all forward gears, including 3rd gear direct and 4th and 5th (if equipped) gear overdrive (see Overdrive Operation). Use this range for most city and highway driving.

**“2” Second**

Use this position for driving slowly in heavy city traffic or on mountain roads where more precise speed control

is desirable. Use it also when climbing long grades, and for engine braking when descending moderately steep grades.

**NOTE:** Do not exceed maximum engine speed.

**“1” First**

Use this position for driving up very steep hills and for engine braking at low speeds (20 mph [32 km/h] or less) when going downhill.

**NOTE:** Do not exceed maximum engine speed.

**Overdrive Operation**

The overdrive automatic transmission contains an electronically controlled fourth and fifth (if equipped) speed (Overdrive). The transmission will automatically shift from Drive to Overdrive if the following conditions are present:

- the transmission selector is in Drive;

- the engine coolant has reached normal operating temperature;
- vehicle speed is above approximately 30 mph (48 km/h);
- the “TOW HAUL O/D OFF” switch has not been activated;
- transmission has reached normal operating temperature.

**NOTE:** If the vehicle is started in extremely cold temperatures, the transmission may not shift into Overdrive and will automatically select the most desirable gear for operation at this temperature. Normal operation will resume when the transmission fluid temperature has risen to a suitable level. Refer also to the Note under torque converter clutch, later in this section.

If the transmission temperature gets extremely hot, the transmission will automatically select the most desirable gear for operation at this temperature. If the transmission temperature becomes hot enough the TRANS TEMP light may illuminate and the transmission may downshift out of Overdrive until the transmission cools down. After cooldown, the transmission will resume normal operation.

The transmission will downshift from Overdrive to Drive if the accelerator pedal is fully depressed at vehicle speeds above approximately 35 mph (56 km/h).

## When To Use “TOW HAUL” and “O/D OFF” Modes

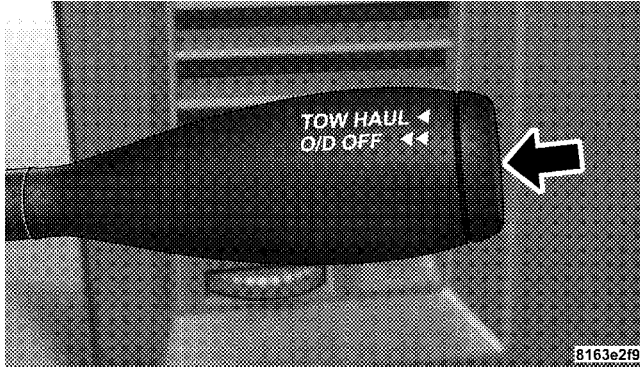

**Tow Haul O/D Off Switch**

When driving in hilly areas, towing a trailer, carrying a heavy load, etc., and frequent transmission shifting occurs, press the “TOW HAUL O/D OFF” button once to select TOW HAUL. This will improve performance and

reduce the potential for transmission overheating or failure due to excessive shifting. When operating in “TOW HAUL” mode, 5th gear (if equipped) is disabled and 2-3 and 3-4 shift patterns are modified. Shifts into Overdrive (4th gear) are allowed during steady cruise (for improved fuel economy) and automatic closed-throttle downshifts to 3rd gear are performed (for improved braking) when driving conditions warrant. Pressing the “TOW HAUL O/D OFF” button a second time to select O/D OFF will disable 4th and 5th gear completely, which should eliminate any excessive transmission shifting.

The “TOW HAUL” or “O/D OFF” light will illuminate in the instrument cluster to indicate when the switch has been activated. Pressing the switch a third time restores normal operation. If the “TOW HAUL” or “O/D OFF” modes are desired, the button must be pressed each time the engine is started.

### Torque Converter Clutch

A feature, designed to improve fuel economy, has been included in the automatic transmission on your vehicle. A clutch within the torque converter engages automatically at calibrated speeds. This may result in a slightly different feeling or response during normal operation in the upper gears. When the vehicle speed drops or during acceleration when the transmission downshifts to second gear, the clutch automatically disengages.

**NOTE:** The torque converter clutch will not engage until the transmission fluid and engine coolant are warm [usually after 1-3 miles (1.6 - 4.8 km) of driving]. Because the engine speed is higher when the torque converter clutch is not engaged, it may seem as if the transmission is not shifting into Overdrive when cold. This is normal. Pressing the “TOW HAUL O/D OFF” button, when the transmission is sufficiently warm, will demonstrate that the transmission is able to shift into and out of overdrive.

**NOTE:** If the vehicle has not been driven in several days, the first few seconds of operation after shifting the transmission into gear may seem sluggish. This is due to the fluid partially draining from the torque converter into the transmission. This condition is normal and will not cause damage to the transmission. The torque converter will refill within five seconds of shifting from Park into any other gear position.

### MANUAL TRANSMISSION

5

#### **WARNING!**

**You or others could be injured if you leave the vehicle unattended without having the parking brake fully applied. The parking brake should always be applied when the driver is not in the vehicle, especially on an incline.**



Truck models with manual transmission are equipped with a clutch interlocking ignition system. The clutch pedal must be fully depressed to start the vehicle.

Fully depress the clutch pedal before shifting gears. As you release the clutch pedal, lightly depress the accelerator pedal.

To shift into Reverse, come to a complete stop. Depress the clutch and pause briefly to allow the gear train to stop. Move the shift lever from the Neutral position straight across and back into Reverse.

Never drive with your foot resting on the clutch pedal, or attempt to hold the vehicle on a hill with the clutch pedal partially engaged, as this will cause abnormal wear on the clutch.

### **Manual Transmission — 6 Speed (G56)**

The Power Wagon may be equipped with the G56 manual transmission. This transmission has a “creeper” 1st gear which should be used to start from a standing position when carrying a payload or towing a trailer. Damage to the clutch can result from starting in 2nd or 3rd gear with a loaded vehicle. An unloaded vehicle may be launched in 2nd gear. Use each gear in numerical order – do not skip a gear.

For most city driving you may find it easier to use only 1st through 5th gear ranges. For steady highway driving with light accelerations, 6th gear is recommended. To shift into 5th gear, move the shift lever to the right beyond the spring pressure point and push it forward. When shifting from 5th to 4th gear, pull the lever down toward you in one motion. Do not pull the lever sharply left as you may shift accidentally into 2nd gear and damage the transmission.

To shift into Reverse, come to a complete stop. Depress the clutch and pause briefly to allow the gear train to stop. Reverse has a “crash-through” lockout feature. Move the shift lever from the Neutral position straight across, in one swift motion, and down into Reverse.

### Recommended Vehicle Shift Speeds

To utilize your manual transmission efficiently for both fuel economy and performance, it should be upshifted as listed in recommended shift speed chart. Shift at the vehicle speeds listed for acceleration. Earlier upshifts during cruise conditions (steady speeds) will result in increased fuel economy, and may be used as indicated.

**6 Speed Manual Transmission Shift Speeds in mph  
(km/h)**

En- gine	Axle	Mode	1 to 2	2 to 3	3 to 4	4 to 5	5 to 6
5.7L	ALL	Accel & Cruise	15 (24)	25 (40)	40 (65)	45 (72)	50 (81)

### Downshifting – All Manual Transmissions

Moving from a high gear down to a lower gear is recommended to preserve brakes when driving down steep hills. In addition, downshifting at the right time provides better acceleration when you desire to resume speed. For acceleration at speeds less than 20 mph (30 km/h), 2nd gear is recommended.

#### CAUTION!

**When descending a hill, be very careful to downshift one gear at a time to prevent overspeeding the engine which can cause valve damage.**

To prevent clutch and transmission damage, your vehicle should be downshifted at speeds no greater than those listed in the Maximum Recommended Downshifting Speed chart.

**Maximum Recommended Downshifting Speeds**

Gear Selection	1st	2nd	3rd	4th	5th
Maximum Speed	16 mph (25 km/h)	30 mph (48 km/h)	50 mph (80 km/h)	76 mph (122 km/h)	105 mph (168 km/h)

**CAUTION!**

**Failure to follow the recommended downshifting speeds may cause the engine to over speed and / or damage the clutch disc even if the clutch pedal is depressed.**

**FOUR-WHEEL- DRIVE OPERATION****Manually Shifted Transfer Case Operating Information/Precautions**

The transfer case provides 4 mode positions - 2 (rear)-wheel-drive high range, 4-wheel-drive high range, neutral, and 4-wheel-drive low range.

This transfer case is intended to be driven in the 2-wheel-drive position (2H) for normal street and highway conditions such as dry hard surfaced roads.

When additional traction is required the transfer case 4H and 4L positions can be used to lock the front and rear driveshafts together and force the front and rear wheels to rotate at the same speed. This is accomplished by simply moving the shift lever to the desired positions. The 4H and 4L positions are intended for loose, slippery

road surfaces only. Driving in the 4H and 4L positions on dry hard surfaced roads may cause increased tire wear and damage to the driveline components.

The 4-wheel drive high (4LOCK) and 4-wheel drive low (4LOW) lights, located in the instrument cluster, alert the driver that the vehicle is either in 4-wheel drive high or 4-wheel drive low and that the front and rear driveshafts are locked together. There are no lights for the 2H or N (Neutral) positions.

When operating your vehicle in 4L, the engine speed is approximately three times that of the 2H or 4H positions at a given road speed. Take care not to overspeed the engine and do not exceed 25 mph (40 km/h).

Proper operation of 4-wheel-drive vehicles depends on tires of equal size, type and circumference on each wheel. Any difference will adversely affect shifting and can cause damage to the transfer case.

**NOTE:** Do not attempt to make a shift while only the front or rear wheels are spinning. The transfer case is not equipped with a synchronizer and therefore the front and rear driveshaft speeds must be equal for the shift to take place. Shifting while only the front or rear wheels are spinning can cause damage to the transfer case.

Because 4-wheel drive provides improved traction, there is a tendency to exceed safe turning and stopping speeds. Do not go faster than road conditions permit.

**NOTE:** Delayed shifts out of four-wheel drive may be experienced due to uneven tire wear, low or uneven tire pressures, excessive vehicle loading, or cold temperatures.

**WARNING!**

**You or others could be injured if you leave the vehicle unattended with the transfer case in the Neutral (N) position without first fully engaging the parking brake. The transfer case Neutral (N) position disengages both the front and rear driveshafts from the powertrain and will allow the vehicle to move regardless of the transmission position. The parking brake should always be applied when the driver is not in the vehicle.**

For additional information on the appropriate use of each transfer case mode position see the information below:

**2H**

Rear Wheel Drive High Range - Normal street and highway driving. Dry hard surfaced roads.

**4H**

4-Wheel-Drive High Range - Locks the front and rear driveshafts together. Forces the front and rear wheels to rotate at the same speed. Additional traction for loose, slippery road surfaces only.

**N**

Neutral - Disengages both the front and rear driveshafts from the powertrain. To be used for flat towing behind another vehicle. See Recreational Towing for more information.

**4L**

4-Wheel-Drive Low Range - Low speed 4-wheel-drive. Locks the front and rear driveshafts together. Forces the front and rear wheels to rotate at the same speed. Additional traction and maximum pulling power for loose, slippery road surfaces only. Do not exceed 25 mph (40 km/h).

## Shifting Procedure - Manually Shifted Transfer Case

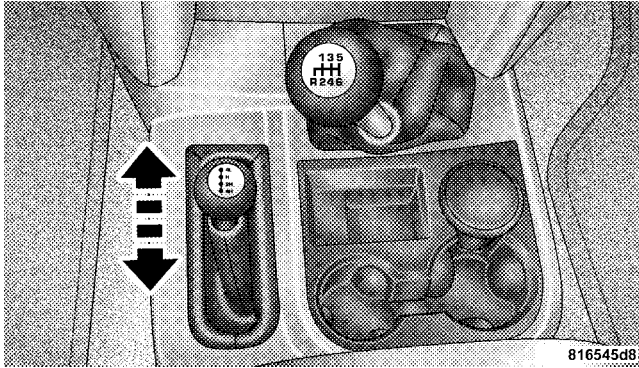

Manual Transfer Case Shifter

### 2H ⇔ 4H

Shifting between 2H and 4H can be made with the vehicle stopped or in motion. If the vehicle is in motion, shifts can be made up to 55 mph (88 km/h). With the

vehicle in motion, the transfer case will engage / disengage faster if you momentarily release the accelerator pedal after completing the shift. Apply a constant force when shifting the transfer case lever.

### 2H or 4H ⇔ 4L

With the vehicle rolling at 2 to 3 mph (3 to 5 km/h), shift an automatic transmission to N (Neutral) or depress the clutch on a manual transmission. While the vehicle is coasting at 2 to 3 mph (3 to 5 km/h), shift the transfer case lever firmly to the desired position. Do not pause in transfer case N (Neutral).

**NOTE:** Pausing in transfer case N (Neutral) in vehicles equipped with an automatic transmission may require shutting the engine OFF to avoid gear clash while completing the shift. If difficulty occurs, shift automatic transmission to N (Neutral), hold foot on brake, and turn engine OFF. Make shift to the desired mode.

**NOTE:** Shifting into or out of 4L is possible with the vehicle completely stopped, however difficulty may occur due to the mating clutch teeth not being properly aligned. Several attempts may be required for clutch teeth alignment and shift completion to occur. The preferred method is with the vehicle rolling 2 to 3 mph (3 to 5 km/h). Avoid attempting to engage or disengage 4L with the vehicle moving faster than 2 to 3 mph (3 to 5 km/h).

**NOTE:** Do not attempt to shift to or from 4L while the transmission is in gear or clutch is engaged.

### **Transfer Case Reminder Light**

The four-wheel-drive operating light (4LOCK), located in the instrument cluster, is used to alert the driver that the front axle is fully engaged and all four wheels are driving.

### **LIMITED-SLIP DIFFERENTIAL — IF EQUIPPED**

The limited-slip differential provides additional traction on snow, ice, mud, sand and gravel, particularly when there is a difference between the traction characteristics of the surface under the right and left rear wheels. During normal driving and cornering, the limited-slip unit performs similarly to a conventional differential. On slippery surfaces, however, the differential delivers more of the driving effort to the rear wheel having the better traction.

The limited-slip differential is especially helpful during slippery driving conditions. With both rear wheels on a slippery surface, a slight application of the accelerator will supply maximum traction. When starting with only one rear wheel on an excessively slippery surface, slight momentary application of the parking brake may be necessary to gain maximum traction.

**WARNING!**

**On vehicles equipped with a limited-slip differential, never run the engine with one rear wheel off the ground, since the vehicle may drive through the rear wheel remaining on the ground. You could lose control of the vehicle.**

Care should be taken to avoid sudden accelerations when both rear wheels are on a slippery surface. This could cause both rear wheels to spin, and allow the vehicle to slide sideways on the crowned surface of a road or in a turn.

**DRIVING ON SLIPPERY SURFACES**

When driving on wet or slushy roads, it is possible for a wedge of water to build up between the tire and road surface. This is known as hydroplaning and may cause partial or complete loss of vehicle control and stopping ability. To reduce this possibility, the following precautions should be observed:

1. Slow down during rainstorms or when roads are slushy.
2. Slow down if road has standing water or puddles.
3. Replace tires when tread wear indicators first become visible.
4. Keep tires properly inflated.
5. Maintain sufficient distance between your vehicle and the car in front to avoid a collision in a sudden stop.



### Axle Locker System

Dodge Power Wagons are equipped with electronically locking front and rear axles. Locking the axles provides greater traction in severe low traction conditions or in rock climbing environments where one wheel is likely to not be in contact with the ground.

#### CAUTION!

**Do not lock the front or rear axle on hard surfaced roads. The ability to steer the vehicle is reduced and damage to the drivetrain may occur when the axles are locked on hard surfaced roads.**

#### CAUTION!

**Do not try to lock the rear axle if the vehicle is stuck and the tires are spinning. You can damage drivetrain components. Lock the rear axle before attempting situations or navigating terrain, which could possibly cause the vehicle to become stuck.**

The locking axles are controlled by the axle locker switch located on the center console.

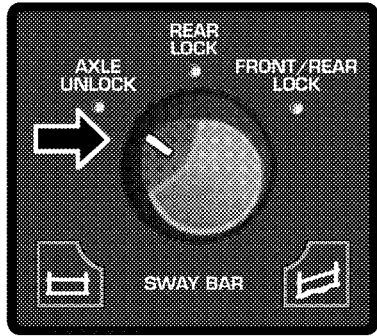

81628883

### Rotary Locking Axle Switch

The switch has three positions, AXLE UNLOCK, REAR LOCK, and FRONT/REAR. Under normal driving conditions the switch should be left in the AXLE UNLOCK position. In the AXLE UNLOCK position, the front and

rear axles are unlocked. In the REAR LOCK position, the rear axle is locked. In the FRONT/REAR position, the front and rear axles are locked.

**NOTE:** Even when the axles are in the AXLE UNLOCK position, the limited slip differential in the rear axle still provides torque biasing capability for moderate low traction environments.

During the command to lock the axle, the indicator light will flash until the axle is locked. After the lock command has been successfully executed, the light will remain on solid.

5

To lock the rear axle, place the vehicle in 4LO by following the procedure in Four Wheel Drive Operation, located in this section of the manual. Move the axle locker switch position to REAR LOCK while traveling **less than 3 MPH (5 KM/H)**. The RR indicator light will remain on when the rear axle is locked.

**NOTE:** Left to right wheel speed difference may be necessary to allow the axle to fully lock. If the indicator light is flashing after placing the switch in the REAR LOCK or FRONT/REAR position, drive the vehicle in a turn or on loose gravel to expedite the locking action.

### WARNING!

**Do not use the locked axle position for normal driving. A locked front axle is intended for off-road driving only. Locking the front axle during on-road driving will reduce the steering ability. This could cause an accident and you may be seriously injured.**

To lock the front axle move the axle locker switch to FRONT/REAR while traveling **less than 3 MPH (5 KM/H)**. The indicator light will be solid when the front axle is locked.

**NOTE:** The rear axle must be locked before the front axle will lock.

To unlock the front axle move the axle locker switch to REAR LOCK. The FRONT/REAR indicator light will go out when the axle is unlocked.

**NOTE:** The axle lockers could be torque locked due to side to side loads on the axle. Driving slowly while turning the steering wheel from a left hand turn to a right hand turn or driving in reverse for a short distance may be required to release the torque lock and unlock the axles.

To unlock the rear axle move the axle locker switch to AXLE UNLOCK. The REAR LOCK indicator light will go out when the rear axle is unlocked.

## Stabilizer/Sway Bar System

Power Wagon vehicles are equipped with an electronic disconnecting stabilizer/sway bar. This system allows greater front suspension travel in off-road situations.

This system is controlled by the electronic control sway bar switch located on the instrument panel.

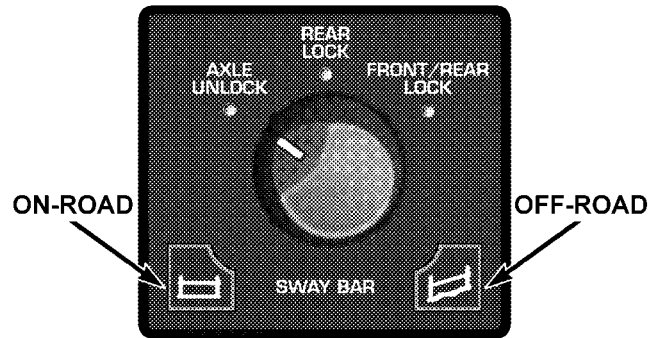

Electronic Control Sway Bar Switch

81628953

The switch has two positions, on-road and off-road. The system is normally in on-road mode, indicated by a solid green light. The stabilizer/sway bar should remain in on-road mode during normal driving conditions.

### WARNING!

Do not disconnect the stabilizer bar and drive on hard surfaced roads or at speeds above 18 MPH, you may lose control of the vehicle, which could result in serious injury. The front stabilizer bar enhances vehicle stability and is necessary for maintaining control of the vehicle. The system monitors vehicle speed and will attempt to reconnect the stabilizer bar at speeds over 18 MPH. This is indicated by a flashing off road light and solid on road light. Once vehicle speed is reduced below 14 MPH the system will once again attempt to return to off road mode.

To disconnect the stabilizer/sway bar, shift to either 4HI or 4LO as shown in Four Wheel Drive Operation and press the top of the stabilizer/sway bar button to obtain the off-road position. The amber indicator light will flash until the stabilizer/sway bar has been fully disconnected.

**NOTE:** The stabilizer/sway bar may be torque locked due to left and right suspension height differences. This condition is due to driving surface differences or vehicle loading. In order for the stabilizer/sway bar to disconnect/reconnect, the right and left halves of the bar must be aligned. This alignment may require that the vehicle be driven onto level ground or rocked from side to side.

To return to on-road mode press the bottom of the stabilizer/sway bar button.

### **WARNING!**

**If stabilizer/sway bar will not return to on-road mode, vehicle stability is greatly reduced. Do not attempt to drive vehicle over 18 mph (29 km/h). Driving faster than 18 mph (29 km/h) may cause loss of control of the vehicle, which could result in serious injury. Contact your local service center for assistance.**

## **POWER WAGON – SAFE OFF-ROAD DRIVING**

### **Off-Road Driving Tips and Vehicle Characteristics**

The Power Wagon has excellent on and off-road capabilities. These off-road capabilities will allow you to explore those wilderness trails where few travel, providing a source of exciting and satisfying recreation. Before you venture out you should contact your local governmental agency to determine what are the designated off-road

vehicle (ORV) trails or recreation areas. You should always tread lightly and only use established roads, trails or ORV recreational areas. The National Forest Service, Bureau of Land Management or local Department of Natural Resources are a wealth of information and usually have maps with marked trails.

### **Ramp Travel Index (RTI)**

The ramp travel index is the distance, in inches, that you can drive your vehicle with one wheel on a 20-degree ramp without lifting any other wheel off the ground. This distance up the ramp divided by the wheelbase of the vehicle and multiplied by 1000 is the RTI. The Power Wagon has an RTI of 655, which means you can articulate one front wheel 32 inches in the air while the other three wheels remain in contact with the ground.

### **High Mobility Characteristics**

The Power Wagon has high off-road mobility characteristics with an approach angle  $A= 35$  degrees, a break-over angle  $B= 25.5$  degrees, a running ground clearance  $C= 14.5$  inches, a departure angle  $D= 26.5$  degrees, an axle to ground clearance  $E= 8.4$  inches front/ $E= 8.25$  rear and has a ramp travel index (with the smart bar in off-road mode) of 655. Also the Power Wagon has a grade-ability of a 60% (31 degree) slope.

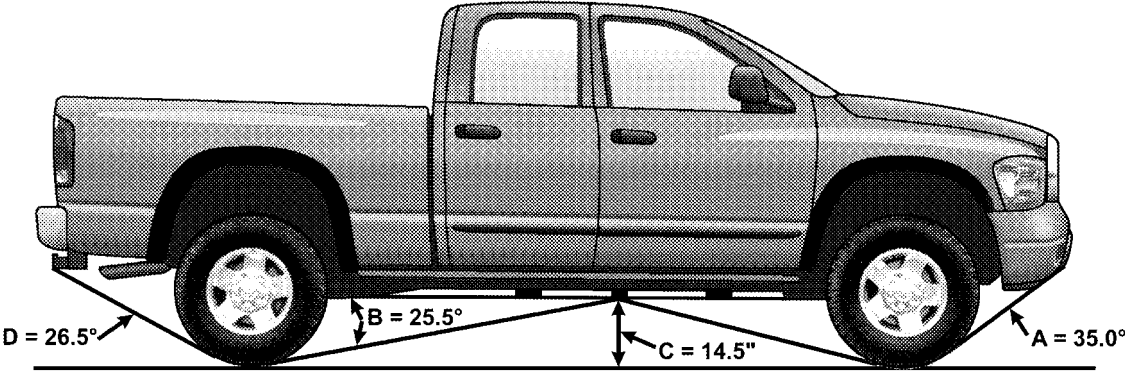

Angles A, B, C, and D

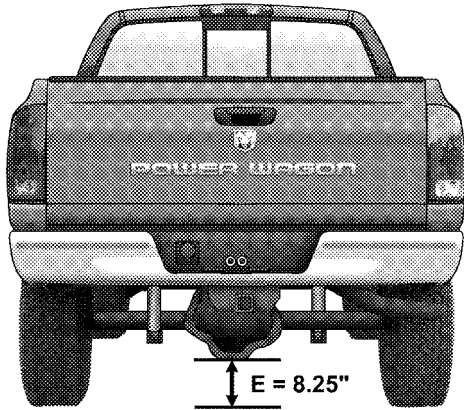

8153a5bc

Front and Rear (Shown) Differential Height E

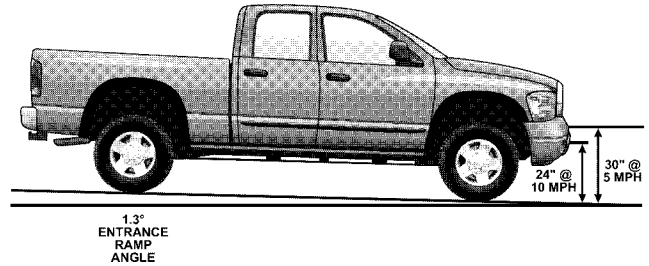

8168270d

5

### Water Fording

#### Water Fording Characteristics

Water fording characteristic is the vehicle's ability to cross a body of still water, where the powertrain and drivetrain are safe from water ingestion. The Power Wagon has high water fording characteristics with the ability to cross a pool of water, without stopping, 24 inches deep at a maximum speed of 10 mph and a pool of



water 30 inches deep at a maximum speed of 5 mph, both with an entrance ramp angle of 1.3 degrees.

**CAUTION!**

**The door sill height is 25 inches. Water may intrude into the interior of the vehicle at greater depths.**

**Simultaneous Brake And Throttle Operation**

Many off-road driving conditions require the simultaneous use of the brake and throttle (two footed driving). When climbing rocks, logs, or other stepped objects, using light brake pressure with light throttle will keep the vehicle from jerking or lurching. This technique is also used when you need to stop and restart a vehicle on a steep incline.

**The Basics Of Off-Road Driving**

You will encounter many types of terrain driving off-road. You should be familiar with the terrain and area before proceeding. There are many types of surface conditions: hard packed dirt, gravel, rocks, grass, sand, mud, snow and ice. Every surface has a different effect on your vehicle's steering, handling and traction. Controlling your vehicle is one of the keys to successful off-road driving, so always keep a firm grip on the steering wheel and maintain a good driving posture. Avoid sudden accelerations, turns or braking. In most cases there are no road signs, posted speed limits or signal lights. Therefore you will need to use your own good judgment on what is safe and what isn't. When on a trail you should always be looking ahead for surface obstacles and changes in terrain. The key is to plan your future driving route while remembering what you are currently driving over.

**CAUTION!**

Never park your vehicle over dry grass or other combustible materials. The heat from your vehicle exhaust system could cause a fire.

**WARNING!**

Always wear your seat belt and firmly tie down cargo. Unsecured cargo can become projectiles in an off-road situation.

**When To Use Low Range**

When driving off-road, shift into 4L (Low range) for additional traction or to improve handling and control on slippery or difficult terrain. Due to the lower gearing, low range will allow the engine to operate in a higher power range. This will allow you to idle over obstacles and

down hills, with improved control and less effort. Also, use 4L (Low range) in rain, ice, snow, mud, sand, to get heavy loads rolling, improve traction, or whenever 4H (High range) traction will not do the job.

**Driving in Snow, Mud and Sand**

There is a drastic reduction in traction when driving in snow, mud or sand. The vehicle will be less responsive to steering, acceleration and braking inputs. Therefore you should accelerate slowly, leave greater stopping distances and avoid abrupt vehicle maneuvers. You want to keep a slow constant steady pace. The key is to maintain the vehicle's momentum.

- **Snow** – In heavy snow or for additional control and traction at slower speeds, shift the transmission to a low gear and shift the transfer case to 4L (Low) if necessary. Don't shift to a lower gear than necessary to maintain headway. Over-revving the engine can spin the wheels and traction will be lost. If you start to slow

to a stop, try turning your steering wheel no more than a ¼ turn quickly back and forth, while still applying throttle. This will allow the tires to get a fresh "bite" and help maintain your momentum.

**CAUTION!**

**On icy or slippery roads, do not downshift at high engine rpm's or vehicle speeds because engine braking may cause skidding and loss of control.**

- **Mud** – Deep mud creates a great deal of suction around the tires and is very difficult to get through. You should use 4L (low range) with a gear low enough to maintain your momentum without shifting. If you start to slow to a stop, try turning your steering wheel no more than a ¼ turn quickly back and forth for additional traction. Mud holes pose an increased threat of vehicle damage and getting stuck. They are

normally full of debris from previous vehicles getting stuck. As a good practice before entering any mud hole, get out and determine how deep it is, if there are any hidden obstacles and if the vehicle can be safely recovered if stuck.

- **Sand** – Soft sand is very difficult to travel through with full tire pressure. When crossing soft sandy spots in a trail maintain your vehicle's momentum and do not stop. The key to driving in soft sand is to use the appropriate tire pressure, accelerating slowly, avoiding abrupt maneuvers and maintaining the vehicle's momentum. If you are going to be driving on large soft sandy areas or dunes, reduce your tire pressure to a minimum of 15 psi (103 kPa) to allow for a greater tire surface area. Reduced tire pressure will drastically improve your traction and handling, while driving on the soft sand, but you must return the tires to normal

air pressure before driving on pavement or other hard surfaces. Be sure you have a way to air the tires back up prior to reducing the pressure.

### **CAUTION!**

**Reduced tire pressures may cause tire unseating and total loss of air pressure. To reduce the risk of tire unseating, while at a reduced tire pressure, reduce your speed and avoid sharp turns or abrupt maneuvers.**

### **Crossing Obstacles (Rocks And Other High Points)**

While driving off road, you will encounter many types of terrain. These varying types of terrain bring different types of obstacles. Before proceeding review the path ahead to determine the correct approach and your ability to safely recover the vehicle if something goes wrong.

Keeping a firm grip on the steering wheel, bring the vehicle to a complete stop and then inch the vehicle forward until it makes contact with the object. Apply the throttle lightly while holding a light brake pressure and ease the vehicle up and over the object.

### **WARNING!**

**Crossing obstacles can cause abrupt steering system loading which could cause you to loose control of your vehicle.**

### **Using A Spotter**

There are many times where it is hard to see the obstacle or determine the correct path. Determining the correct path can be extremely difficult when you are confronting many obstacles. In these cases have someone guide you over, through, or around the obstacle. Have the person

stand a safe distance in front of you where they can see the obstacle, watch your tires and undercarriage, and guide you through.

### **Crossing Large Rocks**

When approaching large rocks, choose a path which ensures you drive over the largest of them with your tires. This will lift your undercarriage over the obstacle. The tread of the tire is tougher and thicker than the side wall and is designed to take the abuse. Always look ahead and make every effort to cross the large rocks with your tires.

#### **CAUTION!**

**Never attempt to straddle a rock that is large enough to strike your axles or undercarriage.**

#### **CAUTION!**

**Never attempt to drive over a rock which is large enough to contact the door sills.**

### **Crossing A Ravine, Gully, Ditch, Washout Or Rut**

When crossing a ravine, gully, ditch, washout or a large rut, the angled approach is the key to maintaining your vehicle's mobility. Approach these obstacles at a 45-degree angle and let each tire go through the obstacle independently. You need to use caution when crossing large obstacles with steep sides. Do not attempt to cross any large obstacle with steep sides at an angle great enough to put the vehicle at risk of a roll over. If you get caught in a rut, dig a small trench to the right or left at a 45-degree angle ahead of the front tires. Use the removed dirt to fill the rut ahead of the turnout you just created. You should now be able to drive out following the trench you just created at a 45-degree angle.

**WARNING!**

There is an increased risk of roll over when crossing an obstacle, at any angle, with steep sides.

**Crossing Logs**

To cross a log, approach it at a slight angle (approximately 10 to 15 degrees). This allows one front tire to be on top of the log while the other just starts to climb the log. While climbing the log, modulate your brake and accelerator to avoid spinning the log out from under your tires. Then ease the vehicle off the log using your brakes.

**CAUTION!**

Do not attempted to cross a log with a greater diameter than the running ground clearance or the vehicle will become high centered.

**Getting High Centered**

If you get hung up or high centered on an object, get out of the vehicle and try to determine what the vehicle is hung up on, where it is contacting the underbody and what is the best direction to recover the vehicle. Depending on what you are in contact with, jack the vehicle up and place a few rocks under the tires so the weight is off of the high point when you let the vehicle down. You can also try rocking the vehicle or winching the vehicle off the object.

**CAUTION!**

**Winching or rocking the vehicle off hard objects increases the risk of underbody damage.**

**Hill Climbing**

Hill climbing requires good judgment and a good understanding of your abilities and your vehicle's limitations. Hills can cause serious problems. Some are just too steep to climb and should not be attempted. You should always feel confident with the vehicle and your abilities. You should always climb hills straight up and down. Never attempt to climb a hill on an angle.

- **Before Climbing A Steep Hill** – As you approach a hill consider its grade or steepness. Determine if it is too steep. Look to see what the traction is on the hill side trail. Is the trail straight up and down? What is on top and the other side? Are there ruts, rocks, branches

or other obstacles on the path? Can you safely recover the vehicle if something goes wrong? If everything looks good and you feel confident, then change transmission into a lower gear, shift the transfer case into 4L (Low) and proceed with caution. You should use first gear and 4L (Low) for very steep hills.

- **Driving Up Hill** – Once you have determined your ability to proceed and have shifted into the appropriate gear, line your vehicle up for the straightest possible run. Accelerate with an easy constant throttle and apply more power as you start up the hill. Do not race forward into a steep grade, the abrupt change of grade could cause you to lose control. If the front end begins to bounce, ease off the throttle slightly to bring all four tires back on the ground. As you approach the crest of the hill ease off the throttle and slowly proceed over the top. If the wheels start to slip as you approach the crest of a hill, ease off the accelerator and maintain headway by turning the steering wheel no more than

a ¼ turn quickly back and forth. This will provide a fresh "bite" into the surface and will usually provide enough traction to complete the climb. If you do not make it to the top, place the vehicle in reverse and back straight down the grade using engine resistance along with the vehicle brakes.

**WARNING!**

Never attempt to climb a hill at an angle or turn around on a steep grade. Driving across an incline increases the risk of a roll over, which may result in severe injury.

- **Driving Down Hill** – Before driving down a steep hill you need to determine if it is too steep for a safe descent. What is the surface traction? Is the grade too steep to maintain a slow controlled descent? Are there obstacles? Is it a straight descent? Is there plenty of

distance at the base of the hill to regain control if the vehicle descends too fast? If you feel confident in your ability to proceed then make sure you are in 4L (Low) with the transmission in 1st gear (manually select 1st gear on automatic transmissions) and proceed with caution. Allow engine braking to control the descent and apply your brakes if necessary, but do not allow the tires to lock.

**WARNING!**

Do not descend a steep grade in neutral. Use vehicle brakes in conjunction with engine braking. Descending a grade too fast could cause you to lose control and be seriously injured.

- **Driving Across An Incline** – If at all possible avoid driving across an incline. If it is necessary, know your vehicle's abilities. Driving across an incline places



more weight on the down hill wheels, which increases the possibilities of a down hill slide or roll over. Make sure the surface has good traction with firm and stable soils. If possible transverse the incline at an angle heading slightly up or down.

**WARNING!**

**Driving across an incline increases the risk of a roll over, which may result in severe injury.**

- **If You Stall Or Begin To Lose Headway** – If you stall or begin to lose headway while climbing a steep hill, allow your vehicle to come to a stop and immediately apply the brake. Restart the engine and shift to R (Reverse). Back slowly down the hill allowing the compression braking of the engine and transmission to

help regulate your speed. If the brakes are required to control vehicle speed, apply them lightly and avoid locking or skidding the tires.

**WARNING!**

**If the engine stalls or you lose headway or cannot make it to the top of a steep hill or grade, never attempt to turn around. To do so may result in tipping and rolling the vehicle, which may result in severe injury. Always back carefully straight down a hill in R (Reverse) gear. Never back down a hill in N (Neutral) or with the clutch pedal depressed using only the vehicle brakes. Never drive diagonally across a hill, always drive straight up or down.**

### Driving Through Water

Extreme care should be taken crossing any type of water. Water crossings should be avoided if possible and only be attempted when necessary, in a safe responsible manner. You should only drive through areas which are designated and approved. You should tread lightly and avoid damage to the environment. You should know your vehicles abilities and be able to recover it if something goes wrong. You should never stop or shut a vehicle off when crossing deep water unless you ingested water into the engine air intake. If the engine stalls do not attempt to restart it. Determine if it has ingested water first. The key to any crossing is low and slow. You want to use 1st gear in 4L (low) and proceed very slowly with a constant slow speed (3-5 mph maximum) and light throttle. Keep the vehicle moving; do not try to accelerate through the crossing. After crossing any water higher than the bottom of the axle differentials, you should inspect all of the vehicle fluids for signs of water ingestion.

### CAUTION!

**Water ingestion into the axles, transmission, transfer case, engine or vehicle interior can occur if you drive too fast or through too deep of water. Water can cause permanent damage to engine, driveline or other vehicle components and your brakes will be less effective once wet and/or muddy**

- **Before You Cross Any Type Of Water** – As you approach any type of water you need to determine if you can cross it safely and responsibly. If necessary, get out and walk through the water or probe it with a stick. You need to be sure of its depth, approach angle, current and bottom condition. Be careful of murky or muddy waters, check for hidden obstacles. Make sure you will not be intruding on any wildlife and you can recover the vehicle if necessary. The key to a safe

crossing is the water depth, current and bottom conditions. On soft bottoms the vehicle will sink in, effectively increasing the water level on the vehicle. Be sure to consider this when determining the depth and the ability to safely cross.

- **Crossing Puddles, Pools, Flooded Areas Or Other Standing Water** – Puddles, pools, flooded or other standing water areas normally contain murky or muddy waters. These water types normally contain hidden obstacles and make it difficult to determine an accurate water depth, approach angle, and bottom condition. Murky or muddy water holes are where you want to hook up tow straps prior to entering. This makes for a faster, cleaner and easier vehicle recovery. If you are able to determine you can safely cross, than proceed using the low and slow method.

### CAUTION!

**Muddy waters can reduce the cooling system effectiveness by depositing debris onto the radiator.**

- **Crossing Ditches, Streams, Shallow Rivers Or Other Flowing Water** – Flowing water can be extremely dangerous. Never attempt to cross a fast running stream or river even in shallow water. Fast moving water can easily push your vehicle downstream sweeping it out of control. Even in very shallow water, a high current can still wash the dirt out from around your tires putting you and your vehicle in jeopardy. There is still a high risk of personal injury and vehicle damage with slower water currents in depths greater than the vehicle's running ground clearance. You should never attempt to cross flowing water which is deeper than the vehicle's running ground clearance. Even the slowest current can push the heaviest vehicle

downstream out of control if the water is deep enough to push on the large surface area of the vehicle's body. Before you proceed determine the speed of the current, the water's depth, approach angle, bottom condition and if there are any obstacles, then cross at an angle heading slightly upstream using the low and slow technique.

### **WARNING!**

**Never drive through fast moving deep water. It can push your vehicle downstream, sweeping it out of control. This could put you and your passengers at risk of injury or drowning.**

### **Airing Down For Off-Road Driving**

Running lower tire pressure off-road can improve your ride comfort and vehicle traction. Reducing the tire air pressure allows the tire to bulge slightly, improving its surface area for better flotation and ability to mold or form to the ground contour. Different terrain, tires, and vehicles require different tire pressure. Hard surfaces like rock and heavier vehicles require higher pressures than softer surfaces such as sand and lighter vehicles. You will need to experiment to determine what is right for your situation. It is easier and faster to let air out than it is to replace it so, start high and lower it as required. Remember you must return the tires to normal air pressure before driving on road or at highway conditions. Be sure you have a way to return the tires to their normal on road air pressure.

**CAUTION!**

**Reduced tire pressure increases the risk of tire damage and may cause tire unseating with total loss of air pressure. To reduce the risk of tire unseating, while at a reduced tire pressure, drive at slower speeds and avoid sharp turns or abrupt maneuvers.**

**Vehicle Recovery**

If you drive off-road, you may encounter a situation where you will need to recover your vehicle. Vehicle recovery should always be given consideration before attempting a questionable obstacle. You should never go off-road driving without the ability to recover your vehicle from a situation. Having another vehicle with you usually works best for most situations. The first thing to do is assess the situation. Why are you stuck? Are you hung up on something? Would it be easier to go forward or to go backward? Can you still move the

vehicle? Is there an anchor point to winch to? Are you alone or do you have another vehicle to help? Is there high risk of vehicle damage during the recovery process? Answering these questions will help you determine the best method of recovery. If you can still move the vehicle slightly and the only issue is slick ground, then rock cycling your vehicle would be the first choice. If you have ample room, an additional vehicle and there is low risk of vehicle impingement on the surroundings, then using a tow strap to the vehicle tow hooks would be fast and easy. If the vehicle is severely hung up or in a situation where great care needs to be taken during the recovery, then nothing can do the job better than a winch. If you are severely hung up on something you should jack the vehicle up and stack something under the wheels to allow the vehicle to roll off the object without causing further damage. This should be tried before attempting any recovery method.

**CAUTION!**

**Pulling the vehicle off an obstacle, without first clearing the object, may result in additional under-body damage.**

- **Rock Cycling Your Vehicle** – Rock cycling your vehicle is one of the easiest, fastest and most commonly used methods. This simply involves shifting your vehicle from drive to reverse, while applying throttle after each shift. During this process, for additional traction, try turning your steering wheel quickly back and forth no more than a ¼ turn. If you are stuck in mud, sand, or snow try spinning your tires during this process to clean the debris from the tread and improve the traction. You want to create a rocking motion with the vehicle. This helps build vehicle momentum, which hopefully gets you out. Remember to ease off and on the accelerator before and after the shift. If after

a few rock cycles your vehicle is not free, stop and try another method of recovery. Continuous rock cycling will only cause unnecessary damage to your vehicle and the environment.

**CAUTION!**

**Damage can occur when spinning your tires at an excessive high speed. Do not spin your tires faster than an indicated 35 mph**

- **Using The Tow Hooks With A Tow Strap** – Tow straps are a quick and easy way to recover your vehicle from minor situations if you have a secondary vehicle which is not stuck. The tow hooks on your vehicle are designed to take the abusive force generated during vehicle recovery. Do not use the bumper or any other vehicle component as an attachment point. Using tow straps requires coordination between

the two drivers. Good communication and line of sight are required for a safe recovery. First connect the tow strap to the correct attachment points on both vehicles. There should be a least 20 to 30 feet between the vehicles to allow for a safe recovery. If necessary join two tow straps together using a 1 ½ inch hard wood dowel. This will keep the straps from becoming knotted and is safer than using a clevis pin if the strap breaks. Next have the tow vehicle backup, leaving 2 to 3 feet worth of slack in the strap. Then the tow vehicle, using light throttle, should accelerate tightening the strap providing the pulling force needed to free the vehicle. The vehicle being recovered should assist in the recovery, at the time of the snap, by slowly spinning the tires in the same direction as the pulling vehicle. After the vehicle becomes free, the driver of the previously stuck vehicle should signal they are free and should hit their brakes stopping both vehicles. The driver of the pulling vehicle should let off the

throttle without using the brakes, once signaled by the other driver. This sequence is important to avoid having the recovered vehicle hit the pulling vehicle.

### **WARNING!**

**Never use tow straps with end hooks or link two straps with a clevis pin. These heavy metal objects could become projectiles if a strap breaks, which could cause severe injury. Never leave more than 2 or 3 feet of slack in the strap. More slack than this greatly increases the risk of injury and vehicle damage. Always keep everyone at least 30 feet away from a strapping or winching situation.**

- **Winching (see the section on “Winch Operation” for additional information on the Power Wagon’s winch)**
  - Winching is most commonly used in the following situations: there is no support vehicle available, a high

controlled force is required to recover the vehicle, there is a high risk of environmental or vehicle damage, or where nothing else seemed to work. A winch can deliver a high pulling force with a great deal of control. It allows you to walk the vehicle out of the situation in a slow controlled manor. This control works well for avoiding further vehicle damage. Once you decide it is time to use the winch look for a good anchor point. It needs to be strong enough to hold more than the vehicle's weight and provide a direction of pull as straight as possible. Use block and tackle if necessary to improve the angle of pull or increase the winch's pulling force. If the anchor point is a tree use a strap around its base and hook the cable to the strap. If it is another vehicle, then place that vehicle in park and block the front tires. If you cannot find an anchor point within reach try using your spare tire by burying it. Once you have determined an anchor point hook up the cable, ensuring there are a least five wraps of cable

left on the drum, and place a floor mat or something else over the strung out cable. Placing something over the strung out cable helps keep the cable on the ground if it breaks. Next, place the vehicle in 1st gear and apply a very light throttle as you power the winch in. Be careful not to allow slack in the cable as you recover the vehicle. Do not try to guide the cable into the drum. If it starts to bunch up on one end, let it. You can re-spool the cable afterwards. Never use a winch cable as a tow strap and always stand back while winching.



**WARNING!**

**Winch cables are under high tension when in use and can become a projectile if they fail. Never stand over or straddle the winch cable. Never jerk or overload the winch cable. Never stand in front of the vehicle while winching. Failure to follow these instructions can result in serious or fatal injury.**

**After Driving Off-Road**

Off-road operation puts more stress on your vehicle than does most on-road driving. After driving off-road, it is always a good idea to check for damage.

- Completely inspect the underbody of your vehicle. Check tires, body structure, steering, suspension, and exhaust system for damage.
- Check threaded fasteners for looseness, particularly on the chassis, drivetrain components, steering, and suspension. Retighten them, if required, and torque to the values specified in the Service Manual.
- Check for accumulations of plants or brush. These things could be a fire hazard, or they might hide damage to fuel lines, brake hoses, axle pinion seals, and propeller shafts.
- After extended operation in mud, sand, water, or similar dirty conditions, have brake drums and rotors, brake linings, and axle yokes inspected and cleaned as soon as possible.
- If you experience unusual vibration after driving in mud, slush or similar conditions, check the wheels for packed material. Packed foreign material can cause a wheel imbalance and cleaning the wheels will correct the situation.

**WARNING!**

**Abrasive material in any part of the brakes may cause excessive wear or unpredictable braking. You might not have full braking power when you need it to prevent an accident. If you have been operating your vehicle in dirty conditions, get your brakes checked and cleaned as necessary. Failure to do so may result in serious injury.**

**WINCH USAGE – IF EQUIPPED****Things To Know Before Using Your Winch****General Winch Information**

Your vehicle is equipped with an electric vehicle recovery winch. This winch uses the electrical power from the vehicle charging system to power a motor that winds wire rope into the winch drum via planetary gear reduction. By nature, a winch is capable of generating very

high forces and should be used with care. Do not operate the winch without reading and understanding the complete winch owner's manual.

**Tensioning the Wire Rope**

The winch rope must be properly tensioned before use. Follow the instructions below to tension the rope:

1. Un-spool the wire rope leaving 5 wraps of rope on the winch drum.
2. Attach the hook to a suitable anchor point.

**CAUTION!**

**Be certain the anchor will withstand the load required to tension the wire rope.**

3. Apply at least 500 lbs. of tension to the rope while winding the rope in. Always use care to ensure the rope does not pile up on one side of the drum and is neatly wound onto the drum.

### **CAUTION!**

**Wire rope must spool on the winch drum in the direction indicated on the drum rotation decal on the winch.**

#### **Low Voltage Interrupt**

Your winch is equipped with a device that will interrupt winch function if the vehicle charging system voltage

drops to a low level. The winch will not power-in or out for 30 seconds if this device is tripped. If the interrupt is tripped, the vehicle should be operated at high idle for a few minutes to allow the vehicle charging system to recover before continuing to winch.

#### **Winch Motor Thermal Protection**

Your winch is equipped with a thermal protection device in the motor. If the winch is operated for an excessive duration, the device may interrupt motor function to protect the winch motor. During this time the winch will power-out but will not power-in. Allow the winch motor to cool for a few minutes before continuing to winch. The winch will resume normal function once the motor cools.

## UNDERSTANDING THE FEATURES OF YOUR WINCH

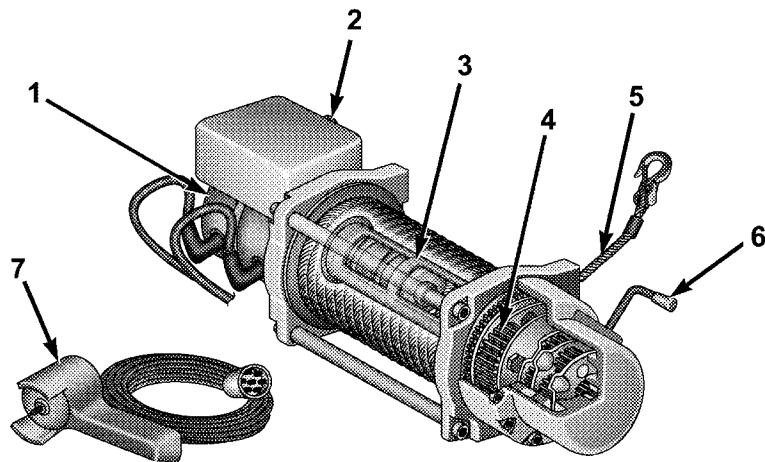

Winch Components

814a6beb

1. **Motor:** The winch motor is powered by the vehicle charging system and features a thermal protection switch that automatically stops motor function in the power-in direction if the motor gets too hot.
2. **Remote Socket:** The remote socket allows the remote control to be attached to the control pack to allow the winch to function.
3. **Winch Drum w/ Integral Brake:** The winch drum allows the wire rope to be stored on the winch and transmits force to the wire rope. The winch is equipped with an integral brake that will stop rotation of the winch drum if the winch motor is stopped.
4. **3 Stage Planetary Gear Set:** Provides balance between speed and pulling power.
5. **Wire Rope:** The wire rope allows the winch to be connected to an anchor to provide a pulling force.

6. **Clutch Lever:** The clutch lever allows the winch drum to be disconnected from the winch motor to allow the wire rope to be pulled from the winch by hand.
7. **Remote Control:** The remote control provides the interface between the winch operator and the winch. The remote control provides the ability to power the winch in, out, and stop the winch. To operate the winch, the toggle switch is pressed down to power the winch in and up to power the winch out. The winch will stop if the switch is left in the neutral (center) position.

**CAUTION!**

**If not installed, the hook strap must be placed on the hook.**

**Fairlead:** The fairlead acts as a guide for the wire rope and minimizes damage to the rope.

## WINCH ACCESSORIES

The following accessories are necessary to attach the winch to anchors, change direction of pull, and for safe winching.

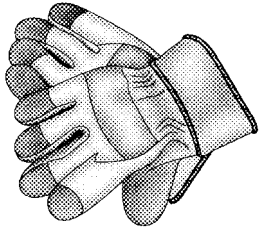

8149d0ee

**Gloves:** Wire rope, through use, will develop "barbs" which can slice skin. It is extremely important to wear protective gloves while operating the winch or handling the wire rope. Avoid loose fitting clothes or anything that could become entangled in the wire rope and other moving parts.

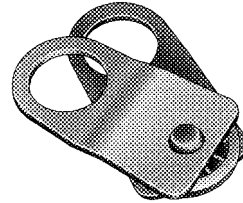

8149d0ea

**Snatch/Block Pulley:** Used properly, the multi-purpose snatch block allows you to (1) increase our winch's pulling power; and (2) change your pulling direction without damaging the wire rope. Proper use of the snatch block is covered in "Before You Pull."

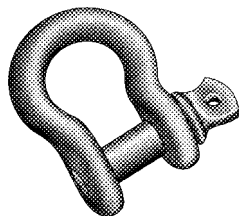

8149d0e6

**Clevis/D-Shackles:** The D-Shackle is a safe means of connecting the looped ends of cables, straps and snatch blocks. The shackle's pin is threaded to allow easy removal.

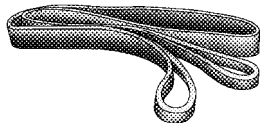

8149d0fd

**Tree Trunk Protector:** Typically made of tough, high-quality nylon, it provides the operator an attachment point for the winch rope to a wide variety of anchor points and objects, as well as protect living trees.

## OPERATING YOUR WINCH

### WARNING!

- Always use supplied hook strap to hold hook when spooling wire rope in or out.
- Never use as a hoist.
- Never use to move persons.
- Never exceed winch or wire rope rated capacity.
- Always wear heavy leather gloves when handling the wire rope.
- Never touch wire rope or hook while in tension or under load.
- Never engage or disengage clutch if winch is under load, wire rope is in tension, or wire rope drum is moving.
- Always stand clear of wire rope and load and keep others away during winching.
- Always keep hands and clothing clear of the wire rope, hook and fairlead opening during operation and when spooling.
- Never wrap wire rope back onto itself. Always use a choker chain, wire choker rope or tree trunk protector on the anchor.
- Never attach a recovery strap to the winch hook to increase the length of a pull.
- Never attempt to tow a vehicle with the recovery strap attached directly to the winch hook.
- Never use "bungee" straps that develop tremendous and potentially dangerous amounts of force when stretched.
- Always disconnect the remote control when not in use.
- Never winch when there are less than 5 wraps of wire rope around the winch drum.
- Always pass remote control through a window to avoid pinching lead in door, then using remote inside a vehicle.
- Never leave the remote control plugged into the winch while free spooling, rigging or sitting idle.

Failure to observe any of these warnings regarding proper winch usage may result in severe injury.

### General Information

Practice using your winch before you get stuck. Some key points to remember when using your winch are:

1. Always take your time to assess the situation and plan your pull carefully.
2. Always take your time when using a winch.
3. Use the right equipment for the situation.
4. Always wear leather gloves and do not allow the wire rope to slip through your hands when handling the rope.
5. Only the operator should handle the wire rope and remote control.
6. Think safety at all times.

### Vehicle Recovery Using the Winch:

#### CAUTION!

- **Always Know Your Winch:** Take time to fully read and understand the included **Installation and Operations Guide, and Basic Guide to Winching Techniques**, in order to understand your winch and the winching operation.
- **Always inspect winch installation and wire rope condition before operating winch.** Frayed, kinked or damaged wire rope must be replaced immediately. Loose or damaged winch installation must be corrected immediately.
- **Always be sure any element which can interfere with safe winching operations is removed prior to initiating winching.**
- **Always keep remote control lead clear of the drum, wire rope and rigging.**
- **Inspect for cracks, pinches, frayed wires, or loose connections. Replace if damaged.**



**CAUTION!**

Be careful not to pull the Winch Cable Collar through the rollers. Watch and listen to Winch for proper snugness.

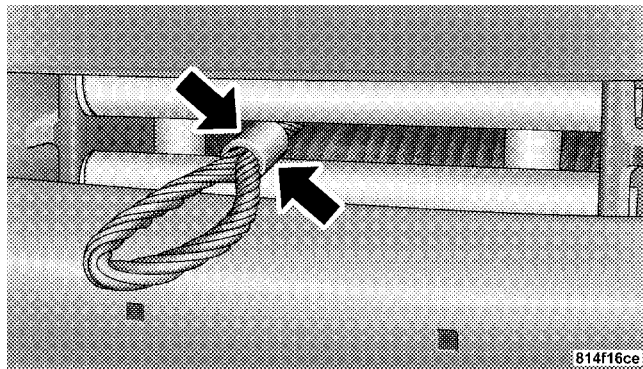

1. Inspect the winch, winch mount, and wire rope for damage. Do not use the winch if the mount is loose or rope shows excessive wear or damage.
2. Put on gloves.
3. Disengage clutch to allow free spooling of the winch drum, rotate the clutch lever on the winch to disengage. Freespooling conserves battery power.

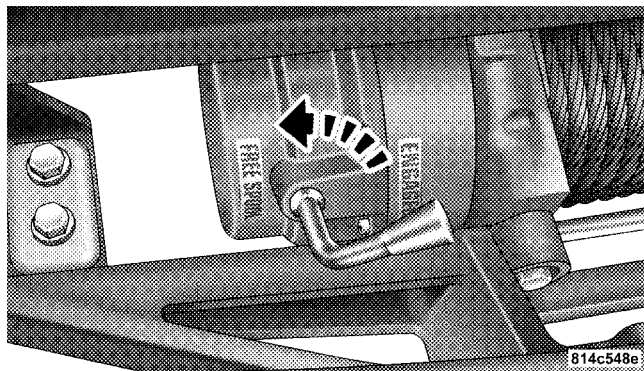
**Free Spool**

4. Free the winch hook and attach hook strap. Free the winch hook from its anchor point. Attach hook strap to the hook (if not attached).

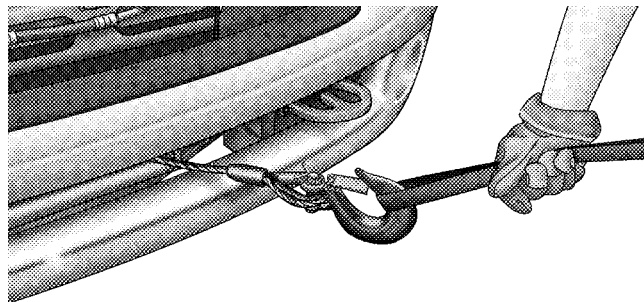

814a0dd4

**Hook Strap**

5. Pull wire to anchor point. Pull out enough wire rope to reach your anchor point. Be sure to keep a certain amount of tension on the wire as it can become twisted and

over-wrap when slackened, leading to wire rope damage. To prevent losing the end, hold the hook strap while you work.

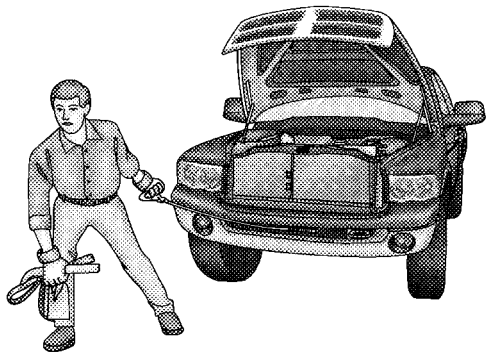

814a0dd8

6. Secure to the anchor point. Once you've established your anchor point, secure the tree-trunk protector or choker-chain around the object.

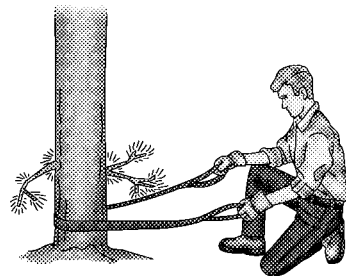

8149d10f

### Tree Trunk Protector

## CAUTION!

**Always be certain the anchor you select will withstand the load.**

**NOTE: How to choose an anchor point:** A secure anchor is critical to winching operations. An anchor must be strong enough to hold while winching. Natural anchors include trees, stumps and rocks. Hook the cable as low as possible. If no natural anchors are available when recovering another vehicle, your vehicle becomes the anchor point. In this case, be sure to put the transmission in neutral, apply the hand brake and block its wheels to prevent your vehicle from moving. Ideally, you'll want an anchor point that will enable you to pull straight in the direction the vehicle will move. This allows the wire rope to wind tightly and evenly onto the spooling drum. An anchor point as far away as possible will provide the winch with its greatest pulling power.

7. Attach the Clevis/D-shackle and Tree Trunk Protector. Attach the shackle to the two ends of the strap or chain and through the hook loop, being careful not to over tighten (tighten and back-off 1/2 turn).

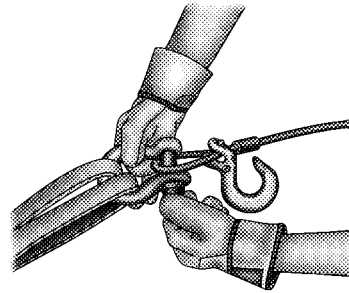

#### Clevis/D-Shackles

8. Lock the clutch. Lock the winch drum by rotating the clutch lever on the winch to engage.

**NOTE:** Always ensure the clutch is fully engaged or disengaged.

8149d116

9. Connect the remote control to the winch control box, located behind the front bumper. Be careful not to let the remote control cord dangle in front of the winch. If you choose to control the winch from inside your vehicle, always pass the remote through a window to avoid pinching the cord in the door. Always disconnect the remote control when not in use.

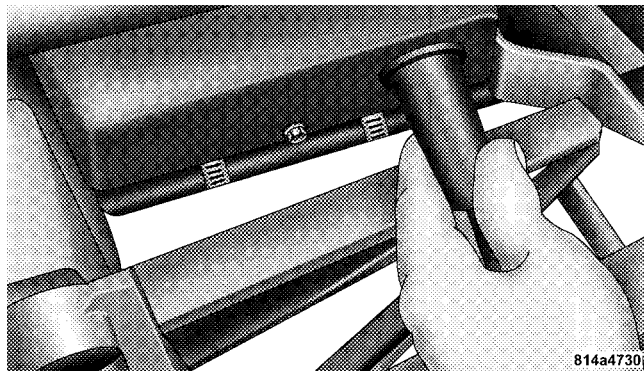

10. Put wire rope under tension. Using the remote control switch, slowly wind the wire rope until no slack remains. Once the wire rope is under tension, stand well clear and never step over it.

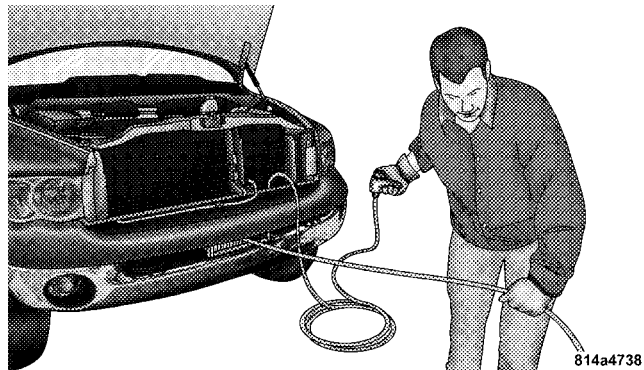

11. Check your anchor. Make sure all connections are secured and free of debris before continuing with the winching procedure.

12. Check wire rope. The wire rope should be neatly wound around the spooling drum. Improper winding can cause damage to the wire rope.

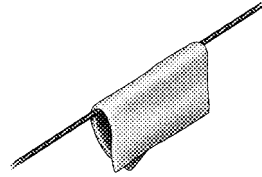
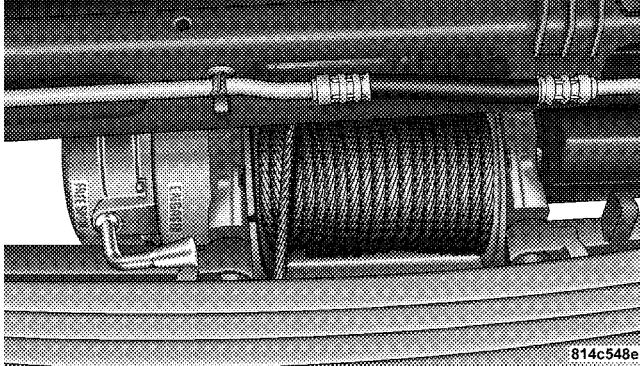

8149d108

13. In certain situations you may decide to throw a heavy blanket or similar object over the wire rope. A heavy blanket can absorb energy should the wire rope break. Place it on the wire rope midway between the winch and the anchor point. Do this before the wire rope is put under tension. Do not approach or move the blanket once tension is applied. Do not allow it to get pulled into the fairlead. If necessary to move or remove the blanket, slack the tension on the wire rope first.

14. **Establish "no people" zones:** Make your intentions clear. Be sure that everyone in the immediate vicinity surrounding the winching operation is completely aware of your intentions before you pull. **Declare where the spectators should not stand - never behind or in front of**

the vehicle and never near the wire rope or snatch block. Your situation may have other "no people" zones.

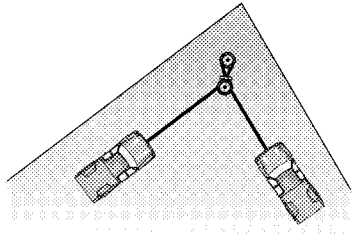
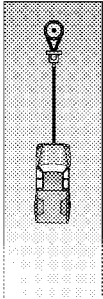

814a0ddc

### No People Zones

15. Begin winching. With the winching vehicles engine on and light tension already on the wire rope, begin winching slowly and steadily. Be sure that the wire rope is winding evenly and tightly around the spooling drum.

For additional assistance, the winched vehicle can be slowly driven while being pulled by the winch. Continue pulling until the vehicle is on stable ground. If you are able to drive the vehicle, the winching operation is complete.

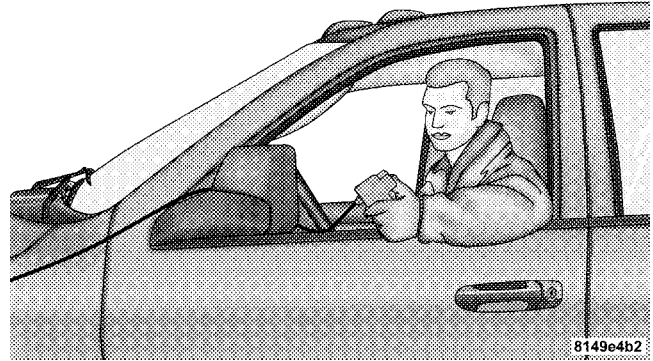

8149e4b2

### Using The Remote Control

**NOTE:** Avoid overheating the winch motor. For extended winching, stop at reasonable intervals to allow the winch motor to cool down.

**NOTE: What to look for under load:** The wire rope must always spool onto the drum as indicated by the drum rotation decal on the winch. As you power-in, make sure the wire rope winds evenly and tightly on the drum. This prevents the outer wire wraps from drawing into the inner wraps, binding and damaging the wire rope. Avoid shock loads by using the control switch intermittently to take up wire rope slack. Shock loads can momentarily far exceed the winch and wire rope ratings. During side pulls the wire rope tends to stack up at one

end of the drum. This stack can become large enough to cause serious damage to the winch. So, line up pulls as straight ahead as possible and stop winching if the wire rope comes close to the tie rods or mounting plate. To fix an uneven stack, spool out that section of the rope and reposition it to the opposite end of the drum, which will free up space for continued winching.

16. Secure vehicle. Once recovery of the vehicle is complete, be sure to secure the vehicle's brakes and put the transmission in "park" (automatic) or "low" gear for "manual" transmissions. Release tension in the wire rope.
17. Disconnect wire rope. Disconnect from the anchor.



18. Rewind wire rope. The person handling the wire rope should walk the rope in and not let it slide through the hand, control the winch at all times.

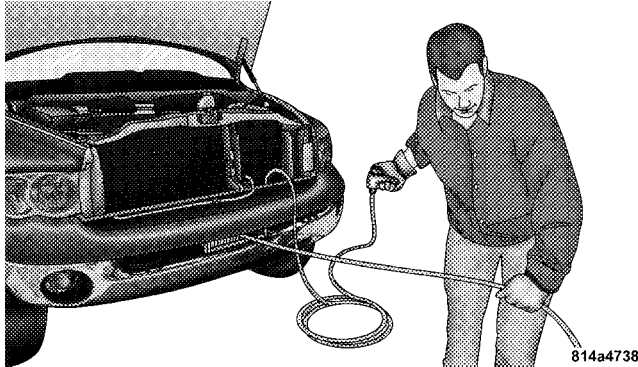

### WARNING!

To prevent serious injury, **NEVER** put your fingers inside the hook area as you are powering-in.

**NOTE: How to spool under no load:** Arrange the remote control lead so it cannot be caught in the winch. Arrange the wire rope so it will not kink or tangle when spooled. Be sure any wire rope already on the spooling drum is wound tightly and evenly layered. Tighten and straighten the layer if necessary. Keep the wire rope under light tension and spool the wire rope back and onto the winch drum in even layers. Stop frequently to tighten and straighten the layers as necessary. Repeat this process until the winch hook is the same distance as the full length of the remote control from the winch. Pinch the hook between your thumb and forefinger and attach the hook strap. Hold the hook strap between the thumb and forefinger to keep tension on the wire rope. Walk the

wire rope towards the fairlead, carefully spooling in the remaining wire rope. By pulsing the remote control switch.

19. Store the hook on the most outboard loop of the tow hook.

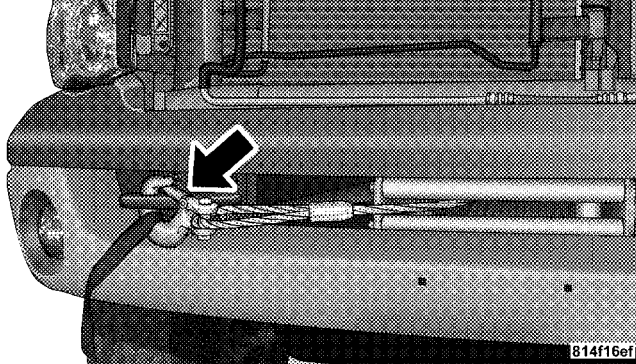

20. Disconnect remote control. Disconnect the remote control cord from the control box and store in a clean and dry place. Winching operations are now complete. Put the cap on the solenoid plug-in.

**NOTE:** Always store the remote control in a protected, clean, dry area.

## RIGGING TECHNIQUES

Various winching situations will require application of other winching techniques. These could range from too little distance to achieve maximum pull using straight line rigging, simply increasing pulling power, or maintaining a straight-line pulling situation. You will have to assess what technique is correct for your situation. Think "safety" at all times.

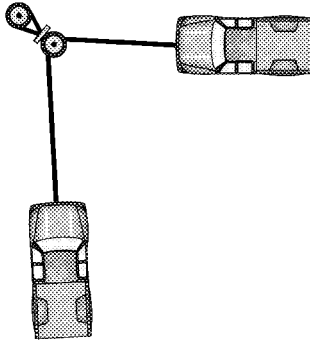
**How to change the pulling direction:****Change Pulling Directions**

All winching operations should have a straight line from the winch to the object being pulled. This minimizes the wire rope collecting on one side of the drum affecting pulling efficiency and damaging wire rope. A snatch block, secured to a point directly in front of the vehicle will enable you to change your pulling direction while still allowing the wire rope to be at 90° to wind properly onto the spooling drum.

814a0e01

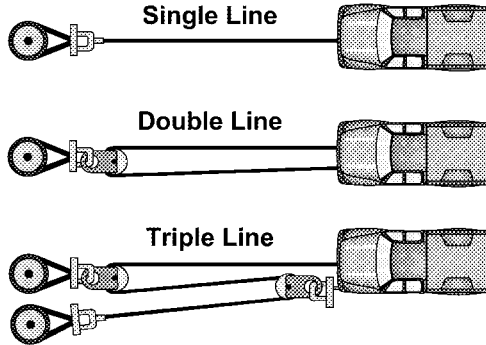
**Increasing pulling power:**

814a0e05

**Increase Pulling Power**

In some cases, you may find yourself needing more pulling power. The use of snatch blocks increases mechanical advantage and that increases your pulling power:

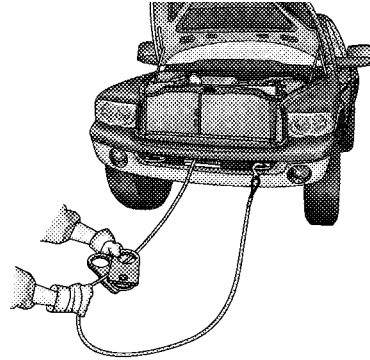
**Double Line:**

814a4734

Because pulling power decreases with the number of layers of wire rope on the winch drum, you can use a snatch block to double line out more wire rope. This decreases the number of layers of wire rope on the drum, and increases pulling power. Start by feeding out enough wire rope to free the winch hook. Attach the hook to your

vehicle's frame/tow hook and run the wire rope through a snatch block. Disengage the clutch and, using the snatch block, pull out enough wire to reach your anchor point. Do not attach hook to mounting kit. Secure to the anchor point with a tree trunk protector or choker chain. Attach the clevis/shackle. Attach the shackle to the two ends of the strap/chain, being careful not to over tighten (tighten and back-off 1/2 turn).

### PARKING BRAKE

The foot operated parking brake is positioned below the lower left corner of the instrument panel. To release the parking brake, pull the parking brake release handle.

**NOTE:** The instrument cluster red brake warning light will come on and flash to indicate that the parking brake is applied. You must be sure that the parking brake is fully applied before leaving the vehicle.

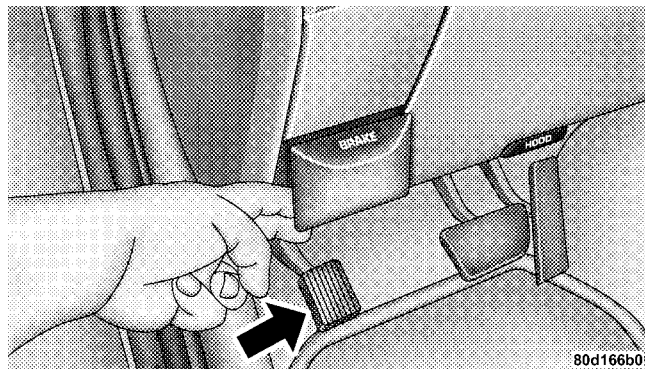

**Parking Brake Release**

Be sure the parking brake is firmly set when parked and the gear shift lever is in the PARK position. When parking on a hill you should apply the parking brake before placing the gear shift lever in PARK, otherwise the load on the transmission locking mechanism may make it difficult to move the selector out of PARK.

**WARNING!**

- **Always fully apply the parking brake when leaving your vehicle, or it may roll and cause damage or injury. Also be certain to leave an automatic transmission in Park, a manual transmission in Reverse or First gear. Failure to do so may allow the vehicle to roll and cause damage or injury.**
- **Never leave children alone in a vehicle. Leaving children in a vehicle unattended is dangerous for a number of reasons. A child or others could be seriously or fatally injured. Don't leave the keys in the ignition. A child could operate power windows, other controls, or move the vehicle.**
- **Be sure the parking brake is fully disengaged before driving, failure to do so can lead to brake problems due to excessive heating of the rear brakes.**

When parking on a hill, turn the front wheels toward the curb on a downhill grade and away from the curb on an uphill grade.

The parking brake should always be applied whenever the driver is not in the vehicle.

**BRAKE SYSTEM**

If power assist is lost for any reason (for example, repeated brake applications with the engine off), the brakes will still function. However, you will experience a substantial increase in braking effort to stop the vehicle.

If either the front or rear hydraulic systems lose normal capability, the remaining system will still function with some loss of overall braking effectiveness. This will be evident by increased pedal travel during application, greater pedal force required to slow or stop, and activation of the BRAKE warning lamp and the ABS lamp (if equipped) during brake use.

**Brake Noise**

During normal operation of the brake system certain noises may be present from time to time. Occasional "groan" or "squeal" noises may occur during normal operation of the brake system which may not be indicative of a problem. These noises may be heard at any time the brakes are applied but may be more noticeable during the first few brake applications in the morning. Moisture, hot or cold temperature, dust, and or other debris may also contribute to the noise condition. Repeated or continuous noises during braking may be an indication that the brake linings are worn and in need of replacement.

**Four-Wheel Anti-Lock Brake System (ABS)— If Equipped**

This Anti-lock Brake System is designed to aid the driver in maintaining vehicle control under adverse braking conditions. The system operates with a separate computer to modulate hydraulic pressure to prevent wheel lockup and help avoid skidding on slippery surfaces.

The system's pump motor runs during an ABS stop to provide regulated hydraulic pressure. The pump motor makes a low humming noise during operation. This is normal.

When you are in a severe braking condition involving use of the Anti-lock Brake System, you will experience some pedal drop as the vehicle comes to a complete stop. This is the result of the system reverting to the base brake system and is normal.

Engagement of the Anti-lock Brake System may be accompanied by a pulsing sensation. You may also hear a clicking noise. These occurrences are normal, and indicate that the system is functioning.

**ABS Warning Light**

The Anti-lock Brake System includes an amber warning light. When the light is illuminated, the Anti-lock Brake System is not functioning. The system reverts to standard non-anti-lock brakes.

**WARNING!**

Pumping of the anti-lock brakes will diminish their effectiveness and may lead to an accident. Pumping makes the stopping distance longer. Just press firmly on your brake pedal when you need to slow down or stop.

**WARNING!**

- Anti-lock system (ABS) cannot prevent the natural laws of physics from acting on the vehicle, nor can it increase braking or steering efficiency beyond that afforded by the condition of the vehicle brakes and tires or the traction afforded.
- The ABS cannot prevent accidents, including those resulting from excessive speed in turns, following another vehicle too closely, or hydroplaning. Only a safe, attentive, and skillful driver can prevent accidents.
- The capabilities of an ABS equipped vehicle must never be exploited in a reckless or dangerous manner which could jeopardize the user's safety or the safety of others.



## POWER STEERING

The standard power steering system will give you good vehicle response and increased ease of maneuverability in tight spaces. The system will provide mechanical steering capability if power assist is lost.

If for some reason, the power assist is interrupted, it will still be possible to steer your vehicle. Under these conditions you will observe a substantial increase in steering effort, especially at very low vehicle speeds and during parking maneuvers.

**NOTE:** Increased noise levels at the end of the steering wheel travel are considered normal and does not indicate that there is a problem with the power steering system.

Upon initial start-up in cold weather, the power steering pump may make noise for a short period of time. This is due to the cold, thick fluid in the steering system. This noise should be considered normal, and does not in any way damage the steering system.

### WARNING!

**Continued operation with reduced power steering assist could pose a safety risk to yourself and others. Service should be obtained as soon as possible.**

### CAUTION!

**Prolong operation of the steering system at the end of the steering wheel travel will increase the steering fluid temperature and should be avoided when possible. Damage to the power steering pump may occur.**

## MULTI DISPLACEMENT SYSTEM (MDS) - 5.7L Engine Only

This feature offers improved fuel economy by shutting off four of the engine's eight cylinders during light load and cruise conditions. The system is automatic with no driver inputs or additional driving skills required.

**NOTE:** The MDS system may take some time to return to full functionality after a battery disconnect.

## TIRE SAFETY INFORMATION

### Tire Markings

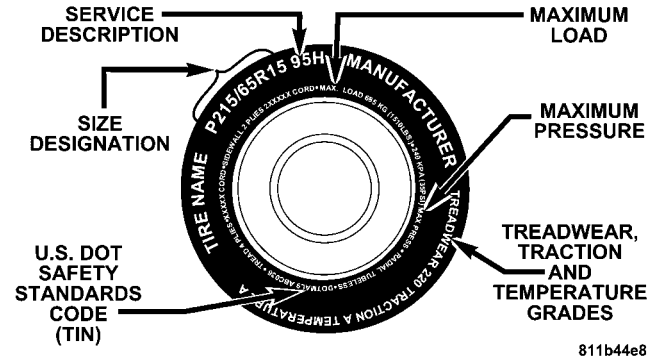

### NOTE:

- P (Passenger)-Metric tire sizing is based on U.S. design standards. P-Metric tires have the letter “P” molded into the sidewall preceding the size designation. Example: P215/65R15 95H.

- European Metric tire sizing is based on European design standards. Tires designed to this standard have the tire size molded into the sidewall beginning with the section width. The letter "P" is absent from this tire size designation. Example: 215/65R15 96H
- LT (Light Truck)-Metric tire sizing is based on U.S. design standards. The size designation for LT-Metric tires is the same as for P-Metric tires except for the letters "LT" that are molded into the sidewall preceding the size designation. Example: LT235/85R16.
- Temporary Spare tires are high-pressure compact spares designed for temporary emergency use only. Tires designed to this standard have the letter "T" molded into the sidewall preceding the size designation. Example: T145/80D18 103M.
- High Flotation tire sizing is based on U.S. design standards and it begins with the tire diameter molded into the sidewall. Example: 31x10.5 R15 LT.

## Tire Sizing Chart

<b>EXAMPLE:</b>	
<b>Size Designation:</b>	
	<b>P</b> = Passenger car tire size based on U.S. design standards
	"... <b>blank</b> ..." = Passenger car tire based on European design standards
	<b>LT</b> = Light Truck tire based on U.S. design standards
	<b>T</b> = Temporary Spare tire
	<b>31</b> = Overall Diameter in Inches (in)
	<b>215</b> = Section Width in Millimeters (mm)
	<b>65</b> = Aspect Ratio in Percent (%) —Ratio of section height to section width of tire.
	<b>10.5</b> = Section Width in Inches (in)
	<b>R</b> = Construction Code —"R" means Radial Construction. —"D" means Diagonal or Bias Construction.
	<b>15</b> = Rim Diameter in Inches (in)

**EXAMPLE:****Service Description:****95** = Load Index

—A numerical code associated with the maximum load a tire can carry.

**H** = Speed Symbol

—A symbol indicating the range of speeds at which a tire can carry a load corresponding to its load index under certain operating conditions.

—The maximum speed corresponding to the Speed Symbol should only be achieved under specified operating conditions. (i.e. tire pressure, vehicle loading, road conditions, and posted speed limits).

**Load Identification:****"...blank..."** = Absence of any text on sidewall of the tire indicates a Standard Load (SL) Tire**Extra Load (XL)** = Extra Load (or Reinforced) Tire**Light Load** = Light Load Tire**C,D,E** = Load range associated with the maximum load a tire can carry at a specified pressure**Maximum Load** — Maximum Load indicates the maximum load this tire is designed to carry.**Maximum Pressure** — Maximum Pressure indicates the maximum permissible cold tire inflation pressure for this tire.

**Tire Identification Number (TIN)**

The TIN may be found on one or both sides of the tire; however, the date code may only be on one side. Tires with white sidewalls will have the full TIN including date code located on the white sidewall side of the tire.

Look for the TIN on the outboard side of black sidewall tires as mounted on the vehicle. If the TIN is not found on the outboard side then you will find it on the inboard side of the tire.

**EXAMPLE:****DOT MA L9 ABCD 0301****DOT** = Department of Transportation

—This symbol certifies that the tire is in compliance with the U.S. Department of Transportation tire safety standards, and is approved for highway use.

**MA** = Code representing the tire manufacturing location. (2 digits)**L9** = Code representing the tire size. (2 digits)**ABCD** = Code used by tire manufacturer. (1 to 4 digits)**03** = Number representing the week in which the tire was manufactured. (2 digits)

—03 means the 3rd week.

**01** = Number representing the year in which the tire was manufactured. (2 digits)

—01 means the year 2001.

—Prior to July 2000, tire manufacturers were only required to have 1 number to represent the year in which the tire was manufactured. Example: 031 could represent the 3rd week of 1981 or 1991.

## Tire Loading and Tire Pressure

### Tire Placard Location

**NOTE:** The proper cold tire inflation pressure is listed on either the face of the driver's door or the driver's side "B" pillar.

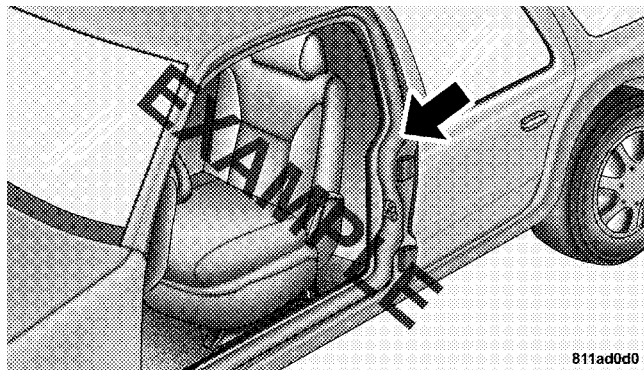

811ad0d0

Tire Placard Location

## Tire and Loading Information Placard

**TIRE AND LOADING INFORMATION**

SEATING CAPACITY - TOTAL 5 FRONT 2 REAR 3

THE COMBINED WEIGHT OF OCCUPANTS AND CARGO SHOULD NEVER EXCEED XXX KG OR XXX LBS.

TIRE	FRONT	REAR	SPARE
ORIGINAL TIRE SIZE	P195/70R14	P195/70R14	T125/70D15
COLD TIRE INFLATION PRESSURE	200kPa, 29PSI	200kPa, 29PSI	420kPa, 60PSI

SEE OWNER'S MANUAL FOR ADDITIONAL INFORMATION

4N109268

811b5a9a

### Tire and Loading Information

This placard tells you important information about the:

- 1) number of people that can be carried in the vehicle
- 2) the total weight your vehicle can carry

- 3) the tire size designed for your vehicle
- 4) the cold tire inflation pressures for the front, rear and spare tires.

### **Loading**

The vehicle maximum load on the tire must not exceed the load carrying capacity of the tire on your vehicle. You will not exceed the tire's load carrying capacity if you adhere to the loading conditions, tire size, and cold tire inflation pressures specified on the "Tire and Loading Information" placard and in the "Vehicle Loading" section of this manual.

**NOTE:** Under a maximum loaded vehicle condition, gross axle weight ratings (GAWR's) for the front and rear axles must not be exceeded. For further information on GAWR's, vehicle loading, and trailer towing, refer to the "Vehicle Loading" section of this manual.

To determine the maximum loading conditions of your vehicle, locate the statement "The combined weight of

occupants and cargo should never exceed XXX kg or XXX lbs." on the Tire and Loading Information placard. The combined weight of occupants, cargo/luggage and trailer tongue weight (if applicable) should never exceed the weight referenced here.

### ***Steps for Determining Correct Load Limit***

1. Locate the statement "The combined weight of occupants and cargo should never exceed XXX pounds" on your vehicle's placard.
2. Determine the combined weight of the driver and passengers that will be riding in your vehicle.
3. Subtract the combined weight of the driver and passengers from XXX kilograms or XXX pounds.
4. The resulting figure equals the available amount of cargo and luggage load capacity. For example, if "XXX" amount equals 1400 lbs. and there will be five 150 lb.



passengers in your vehicle, the amount of available cargo and luggage load capacity is 650 lbs. (since  $5 \times 150 = 750$ , and  $1400 - 750 = 650$  lbs.)

5. Determine the combined weight of luggage and cargo being loaded on the vehicle. That weight may not safely exceed the available cargo and luggage load capacity calculated in Step 4.

6. If your vehicle will be towing a trailer, load from your trailer will be transferred to your vehicle. Consult this manual to determine how this reduces the available cargo and luggage load capacity of your vehicle.

**NOTE:** The following table shows examples on how to calculate total load, cargo/luggage, and towing capacities of your vehicle with varying seating configurations and number and size of occupants. This table is for illustration purposes only and may not be accurate for the seating and load carry capacity of your vehicle.

**NOTE:** For the following example, the combined weight of occupants and cargo should never exceed 865 lbs. (392 Kg).

Occupants			Combined weight of occupants and cargo from Tire Placard	MINUS	Combined Occupant's weight	=	AVAILABLE Cargo/Luggage and Trailer Tongue Weight
TOTAL	FRONT	REAR					
<u>EXAMPLE 1</u>			↓ 865 lbs	minus	Occupant 1: 200 lbs Occupant 2: 130 lbs Occupant 3: 160 lbs Occupant 4: 100 lbs Occupant 5: 80 lbs TOTAL WEIGHT: 670 lbs	=	↓ 195 lbs
5	2	3					
<u>EXAMPLE 2</u>			865 lbs	minus	Occupant 1: 210 lbs Occupant 2: 180 lbs Occupant 3: 150 lbs TOTAL WEIGHT: 540 lbs	=	325 lbs
3	2	1					
<u>EXAMPLE 3</u>			865 lbs	minus	Occupant 1: 200 lbs Occupant 2: 200 lbs TOTAL WEIGHT: 400 lbs	=	465 lbs
2	2	0					

EXAMPLE

**WARNING!**

**Overloading of your tires is dangerous. Overloading can cause tire failure, affect vehicle handling, and increase your stopping distance. Use tires of the recommended load capacity for your vehicle. Never overload them.**

**TIRES — GENERAL INFORMATION****Tire Pressure**

Proper tire inflation pressure is essential to the safe and satisfactory operation of your vehicle. Three primary areas are affected by improper tire pressure:

### 1. Safety—

#### WARNING!

- Improperly inflated tires are dangerous and can cause accidents.
- Under inflation increases tire flexing and can result in tire failure.
- Over inflation reduces a tire's ability to cushion shock. Objects on the road and chuckholes can cause damage that result in tire failure.
- Unequal tire pressures can cause steering problems. You could lose control of your vehicle.
- Over inflated or under inflated tires can affect vehicle handling and can fail suddenly, resulting in loss of vehicle control.
- Unequal tire pressures from one side of the vehicle to the other can cause the vehicle to drift to the right or left.
- Always drive with each tire inflated to the recommended cold tire inflation pressure.

### 2. Economy—

Improper inflation pressures can cause uneven wear patterns to develop across the tire tread. These abnormal wear patterns will reduce tread life resulting in a need for earlier tire replacement. Under inflation, also increases tire rolling resistance and results in higher fuel consumption.

### 3. Ride Comfort and Vehicle Stability—

Proper tire inflation contributes to a comfortable ride. Over inflation produces a jarring and uncomfortable ride.

#### Tire Inflation Pressures

The proper cold tire inflation pressure is listed either on the face of the driver's door or on the driver's side "B" pillar.

Some vehicles may have Supplemental Tire Pressure Information for vehicle loads that are less than the

maximum loaded vehicle condition. These pressure conditions will be found in the “Supplemental Tire Pressure Information” section of this manual.

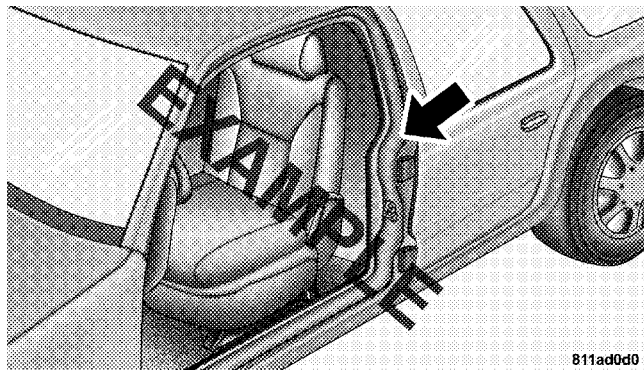

#### Tire Placard Location

The pressure should be checked and adjusted as well as inspecting for signs of tire wear or visible damage at least once a month. Use a good quality pocket-type gauge to

check tire pressure. Do not make a visual judgement when determining proper inflation. Radial tires may look properly inflated even when they are under inflated.

#### CAUTION!

**After inspecting or adjusting the tire pressure, always reinstall the valve stem cap (if equipped). This will prevent moisture and dirt from entering the valve stem, which could damage the valve stem.**

Inflation pressures specified on the placard are always “cold tire inflation pressure.” Cold tire inflation pressure is defined as the tire pressure after the vehicle has not been driven for at least 3 hours, or driven less than 1 mile (1 km) after a 3 hour period. The cold tire inflation pressure must not exceed the maximum inflation pressure molded into the tire sidewall.

Check tire pressures more often if subject to a wide range of outdoor temperatures, as tire pressures vary with temperature changes.

Tire pressures change by approximately 1 psi (7 kPa) per 12° F (7° C) of air temperature change. Keep this in mind when checking tire pressure inside a garage, especially in the winter.

Example: If garage temperature = 68° F (20° C) and the outside temperature = 32° F (0° C) then the cold tire inflation pressure should be increased by 3 psi (21 kPa), which equals 1 psi (7 kPa) for every 12° F (7° C) for this outside temperature condition.

Tire pressure may increase from 2 to 6 psi (13 to 40 kPa) during operation. DO NOT reduce this normal pressure build up or your tire pressure will be too low.

### **Tire Pressures for High Speed Operation**

The manufacturer advocates driving at safe speeds within posted speed limits. Where speed limits or conditions are such that the vehicle can be driven at high speeds, maintaining correct tire inflation pressure is very important. Increased tire pressure and reduced vehicle loading may be required for high-speed vehicle operation. Refer to original equipment or an authorized tire dealer for recommended safe operating speeds, loading and cold tire inflation pressures.

**WARNING!**

High speed driving with your vehicle under maximum load is dangerous. The added strain on your tires could cause them to fail. You could have a serious accident. Don't drive a vehicle loaded to the maximum capacity at continuous speeds above 75 mph (120 km/h).

**Radial-Ply Tires****WARNING!**

Combining radial ply tires with other types of tires on your vehicle will cause your vehicle to handle poorly. The instability could cause an accident. Always use radial ply tires in sets of four (or 6, in case of trucks with dual rear wheels). Never combine them with other types of tires.

Cuts and punctures in radial tires are repairable only in the tread area because of sidewall flexing. Consult your authorized tire dealer for radial tire repairs.

### **Compact Spare Tire — If Equipped**

The compact spare is for temporary emergency use with radial tires. It is engineered to be used on your style vehicle only. Since this tire has limited tread life, the original tire should be repaired (or replaced) and reinstalled at the first opportunity.

#### **WARNING!**

**Temporary use spare tires are for emergency use only. With these tires, do not drive more than 50 mph (80 km/h). Temporary-use spare tires have limited tread life. When the tread is worn to the tread wear indicators, the temporary use spare tire needs to be replaced. Be sure to follow the warnings, which apply to your spare. Failure to do so could result in spare tire failure and loss of vehicle control.**

Do not install a wheel cover or attempt to mount a conventional tire on the compact spare wheel, since the wheel is designed specifically for the compact spare.

Do not install more than one compact spare tire/wheel on the vehicle at any given time.

#### **CAUTION!**

**Because of the reduced ground clearance, do not take your vehicle through an automatic car wash with the compact spare installed. Damage to the vehicle may result.**



**Limited Use Spare — If Equipped**

The limited use spare tire is for temporary emergency use on your vehicle. This tire is identified by a limited use spare tire warning label located on the limited use spare tire and wheel assembly. This tire may look like the original equipped tire on the front or rear axle of your vehicle, but it is not. Installation of this limited use spare tire affects vehicle handling. Since it is not the same tire, replace (or repair) the original tire and reinstall on the vehicle at the first opportunity.

**WARNING!**

**The limited use spare tires are for emergency use only. Installation of this limited use spare tire affects vehicle handling. With this tire, do not drive more than 60 mph (100 km/h). Keep inflated to the cold tire inflation pressure listed on either your tire placard or limited use spare tire and wheel assembly. Replace (or repair) the original tire at the first opportunity and reinstall it on your vehicle. Failure to do so could result in loss of vehicle control.**

**Tire Spinning**

When stuck in mud, sand, snow, or ice conditions, do not spin your vehicle's wheels above 35 mph (55 km/h).

Refer to the paragraph on "Freeing A Stuck Vehicle" in Section 6 of this manual.

**WARNING!**

Fast spinning tires can be dangerous. Forces generated by excessive wheel speeds may cause tire damage or failure. A tire could explode and injure someone. Do not spin your vehicle's wheels faster than 30 mph (48 km/h) for more than 30 seconds continuously when you are stuck, and don't let anyone near a spinning wheel, no matter what the speed.

**Tread Wear Indicators**

Tread wear indicators are in the original equipment tires to help you in determining when your tires should be replaced.

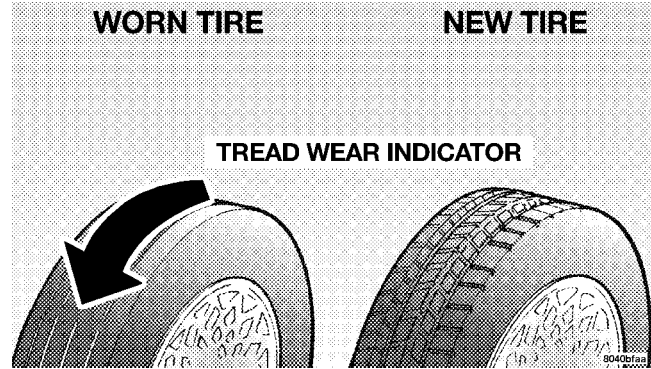

These indicators are molded into the bottom of the tread grooves. They will appear as bands when the tread depth becomes 1/16 inch (2 mm). When the tread is worn to the tread wear indicators, the tire should be replaced.

Many states have laws requiring tire replacement at this point.

### Life of Tire

The service life of a tire is dependent upon varying factors including but not limited to:

- Driving style
- Tire pressure
- Distance driven

#### **WARNING!**

**Tires and spare tire should be replaced after six years, regardless of the remaining tread. Failure to follow this warning can result in sudden tire failure. You could lose control and have an accident resulting in serious injury or death.**

Keep dismantled tires in a cool, dry place with as little exposure to light as possible. Protect tires from contact with oil, grease, and gasoline.

### Replacement Tires

The tires on your new vehicle provide a balance of many characteristics. They should be inspected regularly for wear and correct cold tire inflation pressure. The manufacturer strongly recommends that you use tires equivalent to the originals in size, quality and performance when replacement is needed (refer to the paragraph on “Tread Wear Indicators”). Refer to the “Tire and Loading Information” placard for the size designation of your tire. The service description and load identification will be found on the original equipment tire. Failure to use equivalent replacement tires may adversely affect the safety, handling, and ride of your vehicle. We recommend that you contact your original equipment or an authorized tire dealer with any questions you may have on tire specifications or capability.

**WARNING!**

- Do not use a tire, wheel size or rating other than that specified for your vehicle. Some combinations of unapproved tires and wheels may change suspension dimensions and performance characteristics, resulting in changes to steering, handling, and braking of your vehicle. This can cause unpredictable handling and stress to steering and suspension components. You could lose control and have an accident resulting in serious injury or death. Use only the tire and wheel sizes with load ratings approved for your vehicle.
- Never use a tire with a smaller load index or capacity, other than what was originally equipped on your vehicle. Using a tire with a smaller load index could result in tire overloading and failure. You could lose control and have an accident.
- Failure to equip your vehicle with tires having adequate speed capability can result in sudden tire failure and loss of vehicle control.

**CAUTION!**

Replacing original tires with tires of a different size may result in false speedometer and odometer readings.

**Alignment And Balance**

Poor suspension alignment may result in:

- Fast tire wear.
- Uneven tire wear, such as feathering and one-sided wear.
- Vehicle pull to right or left.

Tires may also cause the vehicle to pull to the left or right. Alignment will not correct this condition. See your dealer for proper diagnosis.

Improper alignment will not cause vehicle vibration. Vibration may be a result of tire and wheel out-of-balance. Proper balancing will reduce vibration and avoid tire cupping and spotty wear.

### **SUPPLEMENTAL TIRE PRESSURE INFORMATION – IF EQUIPPED**

A light load vehicle condition is defined as two passengers {150 lbs (68 kg) each} plus 200 lbs (91kg) of cargo. Cold tire inflation pressures for a lightly loaded vehicle will be found on the face of the driver's door.

### **TIRE CHAINS**

Use "Class U" chains on Power Wagon models, or other traction aids that meet SAE Type "U" specifications.

**NOTE:** Chains must be the proper size for the vehicle, as recommended by the chain manufacturer.

### **CAUTION!**

To avoid damage to your vehicle, tires or chains, observe the following precautions:

- Because of limited chain clearance between tires and other suspension components, it is important that only chains in good condition are used. Broken chains can cause serious vehicle damage. Stop the vehicle immediately if noise occurs that could suggest chain breakage. Remove the damaged parts of the chain before further use.
- Install chains as tightly as possible and then retighten after driving about 1/2 mile (0.8 km).
- Do not exceed 45 mph (72 km/h).
- Drive cautiously and avoid severe turns and large bumps, especially with a loaded vehicle.
- Do not install tire chains on front wheels of 4x2 vehicles.
- Do not drive for a prolonged period on dry pavement.
- Observe the tire chain manufacturer's instructions on method of installation, operating speed, and conditions for usage. Always use the lower suggested operating speed of the chain manufacturer if different than the speed recommended by the manufacturer.

These cautions apply to all chain traction devices, including link and cable (radial) chains.

**NOTE:** On 4x4 Power Wagon models, class “U” snow chains are permitted on the rear wheels only of vehicles equipped with LT285/70R17D.

### **CAUTION!**

**Do not use tire chains on the 4X4 front wheels of Ram Trucks equipped with LT285/70R17D. There may not be adequate clearance for the chains and you are risking structural or body damage to your vehicle.**

### **SNOW TIRES**

Snow tires should be of the same size and type construction as the front tires. Consult the manufacturer of the snow tire to determine any maximum vehicle speed requirement associated with the tire. These tires should always be operated at the vehicle maximum capacity inflation pressures under any load condition.

While studded tires improve performance on ice, skid and traction capability on wet or dry surfaces may be poorer than that of non-studded tires. Some states prohibit studded tires; therefore, local laws should be checked before using these tire types.

### TIRE ROTATION RECOMMENDATIONS

Tires on the front and rear axles of vehicles operate at different loads and perform different steering, driving, and braking functions. For these reasons, they wear at unequal rates, and develop irregular wear patterns. These effects can be reduced by timely rotation of tires. The benefits of rotation are especially worthwhile with aggressive tread designs such as those on On/Off Road type tires. Rotation will increase tread life, help to maintain mud, snow, and wet traction levels, and contribute to a smooth, quiet ride.

Follow the recommended tire rotation frequency for your type of driving found in the “Maintenance Schedules” Section of this manual. More frequent rotation is permissible if desired. The reasons for any rapid or unusual wear should be corrected prior to rotation being performed.

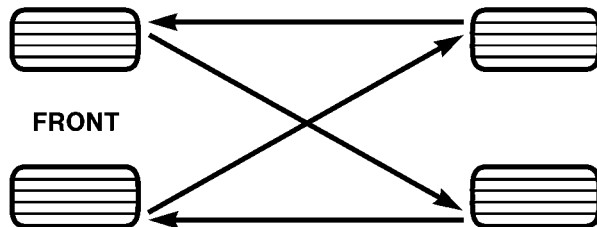

8031e864

**NOTE:** On Canadian vehicles only, if your Ram truck is equipped with All-Season type tires on the front and ON/OFF Road type tires mounted on the rear, do not use a front to back rotation pattern. Instead, rotate your tires side to side at the recommended intervals.

## FUEL REQUIREMENTS



### 5.7L Engines

The 5.7L engine is designed to meet all emissions regulations and provide satisfactory fuel economy and performance when using high quality unleaded gasoline having an octane range of 87 to 89. The manufacturer recommends the use of 89 octane for optimum performance. The routine use of premium gasoline is not recommended. The use of premium gasoline will provide no benefit over high quality regular and mid-grade gasolines, and in some circumstances may result in poorer performance.

Light spark knock at low engine speeds is not harmful to your engine. However, continued heavy spark knock at high speeds can cause damage and immediate service is required.

Poor quality gasoline can cause problems such as hard starting, stalling and hesitations. If you experience these symptoms, try another brand of “regular” gasoline before considering service for the vehicle.

Over 40 auto manufacturers world-wide have issued and endorsed consistent gasoline specifications (the Worldwide Fuel Charter, WWFC) to define fuel properties necessary to deliver enhanced emissions, performance and durability for your vehicle. We recommend the use of gasolines that meet the WWFC specifications if they are available.

### Reformulated Gasoline

Many areas of the country require the use of cleaner burning gasoline referred to as “Reformulated Gasoline.” Reformulated gasolines contain oxygenates, and are specifically blended to reduce vehicle emissions and improve air quality.



We strongly support the use of reformulated gasolines. Properly blended reformulated gasolines will provide excellent performance and durability for the engine and fuel system components.

### **Gasoline/Oxygenate Blends**

Some fuel suppliers blend unleaded gasoline with oxygenates such as 10% ethanol, MTBE and ETBE. Oxygenates are required in some areas of the country during the winter months to reduce carbon monoxide emissions. Fuels blended with these oxygenates may be used in your vehicle.

### **CAUTION!**

**DO NOT use gasolines containing METHANOL. Gasoline containing methanol may damage critical fuel system components.**

### **MMT In Gasoline**

MMT is a manganese-containing metallic additive that is blended into some gasoline to increase octane. Gasolines blended with MMT provide no performance advantage beyond gasolines of the same octane number without MMT. Gasolines blended with MMT reduce spark plug life and reduce emission system performance. We recommend that gasolines free of MMT be used in your vehicle. The MMT content of gasoline may not be indicated on the gasoline pump; therefore, you should ask your gasoline retailer whether or not his/her gasoline contains MMT.

It is even more important to look for gasolines without MMT in Canada because MMT can be used at levels higher than allowed in the United States. MMT is prohibited in Federal and California reformulated gasolines.

### Sulfur In Gasoline

If you live in the northeast United States, your vehicle may have been designed to meet California low emission standards with Cleaner-Burning California reformulated gasoline with low sulfur. If such fuels are not available in states adopting California emission standards, your vehicles will operate satisfactorily on fuels meeting federal specifications, but emission control system performance may be adversely affected. Gasoline sold outside of California is permitted to have higher sulfur levels which may affect the performance of the vehicle's catalytic converter. This may cause the Check Engine or Service Engine Soon light to illuminate. We recommend that you try a different brand of unleaded gasoline having lower sulfur to determine if the problem is fuel related prior to returning your vehicle to an authorized dealer for service.

### CAUTION!

**If the Check Engine or Service Engine Soon light is flashing, immediate service is required; see onboard diagnostics system section.**

### Materials Added To Fuel

All gasolines sold in the United States are required to contain effective detergent additives. Use of additional detergents or other additives is not needed under normal conditions and would result in unnecessary cost. Therefore, you should not have to add anything to the fuel.

## Fuel System Cautions

<b>CAUTION!</b>
<b>Follow these guidelines to maintain your vehicle's performance:</b>

- The use of leaded gas is prohibited by Federal law. Using leaded gasoline can impair engine performance, damage the emission control system.
- An out-of-tune engine, or certain fuel or ignition malfunctions, can cause the catalytic converter to overheat. If you notice a pungent burning odor or some light smoke, your engine may be out of tune or malfunctioning and may require immediate service. Contact your dealer for service assistance.

- When pulling a heavy load or driving a fully loaded vehicle when the humidity is low and the temperature is high, use a premium unleaded fuel to help prevent spark knock. If spark knock persists, lighten the load, or engine piston damage may result.
- The use of fuel additives which are now being sold as octane enhancers is not recommended. Many of these products contain high concentrations of methanol. Fuel system damage or vehicle performance problems resulting from the use of such fuels or additives is not the responsibility of the manufacturer.

**NOTE:** Intentional tampering with emissions control systems can result in civil penalties being assessed against you.

## Carbon Monoxide Warnings

### WARNING!

**Carbon monoxide (CO) in exhaust gases is deadly. Follow the precautions below to prevent carbon monoxide poisoning:**

- Do not inhale exhaust gases. They contain carbon monoxide, a colorless and odorless gas which can kill. Never run the engine in a closed area, such as a garage, and never sit in a parked vehicle with the engine running for an extended period. If the vehicle is stopped in an open area with the engine running for more than a short period, adjust the ventilation system to force fresh, outside air into the vehicle.

- Guard against carbon monoxide with proper maintenance. Have the exhaust system inspected every time the vehicle is raised. Have any abnormal conditions repaired promptly. Until repaired, drive with all side windows fully open.
- Keep the liftgate closed when driving your vehicle to prevent carbon monoxide and other poisonous exhaust gases from entering the vehicle.

## ADDING FUEL

### Adding Fuel (Gas Engines)

The fuel tank filler tube has a restricting door about 2 inches (50 mm) inside the opening. If using a portable fuel container, it should have a flexible nozzle long enough to force open the restricting door.

**CAUTION!**

Damage to the fuel system or emission control system could result from using an improper fuel tank filler tube cap (gas cap). A poorly fitting cap could let impurities into the fuel system. Also a poorly fitted after-market cap can cause the MIL (Malfunction Indicator Light) to illuminate, due to fuel vapors escaping from the system.

**CAUTION!**

A poorly fitting gas cap may cause the Malfunction Indicator Light to turn on.

**CAUTION!**

To avoid fuel spillage and overfilling, do not “top off” the fuel tank after filling.

**NOTE:** When the fuel nozzle “clicks” or shuts off, the fuel tank is full.

**WARNING!**

- Never have any smoking materials lit in or near the vehicle when the gas cap is removed or the tank filled.
- Never add fuel to the vehicle when the engine is running. This is in violation of most state and federal fire regulations and will cause the Malfunction Indicator Light to turn on.

**NOTE:** Tighten the gas cap 1/4 turn until you hear one click. This is an indication that the cap is properly tightened.

If the gas cap is not tightened properly, the Malfunction Indicator Light will come on. Be sure the gas cap is tightened every time the vehicle is refueled.

### **WARNING!**

**A fire may result if gasoline is pumped into a portable container that is inside of a vehicle. You could be burned. Always place gas containers on the ground while filling.**

#### **Loose Fuel Filler Cap Message**

If the vehicle's diagnostic system determines that the fuel filler cap is loose, improperly installed, or damaged, a GASCAP message will be displayed in the instrument

cluster. Tighten the gas cap until a "clicking" sound is heard. This is an indication that the gas cap is properly tightened. Press the odometer reset button to turn the message off. If the problem persists, the message will appear the next time the vehicle is started. This might indicate a damaged cap. If the problem is detected twice in a row, the system will turn on the Malfunction Indicator Light (MIL). Resolving the problem will turn the MIL light off.

#### **VEHICLE LOADING**

##### **Certification Label**

As required by National Highway Traffic Safety Administration Regulations, your vehicle has a certification label affixed to the driver's side door or pillar.

This label contains the month and year of manufacture, Gross Vehicle Weight Rating (GVWR), Gross Axle Weight Rating (GAWR) front and rear, and Vehicle Identification Number (VIN). A Month-Day-Hour (MDH) number is

included on this label and indicates the Month, Day and Hour of manufacture. The bar code that appears on the bottom of the label is your Vehicle Identification Number (VIN).

### **Gross Vehicle Weight Rating (GVWR)**

The GVWR is the total permissible weight of your vehicle including driver, passengers, vehicle, options and cargo. The label also specifies maximum capacities of front and rear axle systems (GAWR). Total load must be limited so GVWR and front and rear GAWR are not exceeded.

### **Payload**

The payload of a vehicle is defined as the allowable load weight a truck can carry, including the weight of the driver, all passengers, options and cargo.

### **Gross Axle Weight Rating (GAWR)**

The GAWR is the maximum permissible load on the front and rear axles. The load must be distributed in the cargo area so that the GAWR of each axle is not exceeded.

Each axle GAWR is determined by the components in the system with the lowest load carrying capacity (axle, springs, tires or wheels). Heavier axles or suspension components sometimes specified by purchasers for increased durability does not necessarily increase the vehicle's GVWR.

### **Tire Size**

The tire size on the Label represents the actual tire size on your vehicle. Replacement tires must be equal to the load capacity of this tire size.

### **Rim Size**

This is the rim size that is appropriate for the tire size listed.

### **Inflation Pressure**

This is the cold tire inflation pressure for your vehicle for all loading conditions up to full GAWR.

### **Curb Weight**

The curb weight of a vehicle is defined as the total weight of the vehicle with all fluids, including vehicle fuel, at full capacity conditions, and with no occupants or cargo loaded into the vehicle. The front and rear curb weight values are determined by weighing your vehicle on a commercial scale before any occupants or cargo are added.

### **Loading**

The actual total weight and the weight of the front and rear of your vehicle at the ground can best be determined by weighing it when it is loaded and ready for operation.

The entire vehicle should first be weighed on a commercial scale to insure that the GVWR has not been exceeded. The weight on the front and rear of the vehicle should then be determined separately to be sure that the load is properly distributed over front and rear axle. Weighing the vehicle may show that the GAWR of either the front

or rear axles has been exceeded but the total load is within the specified GVWR. If so, weight must be shifted from front to rear or rear to front as appropriate until the specified weight limitations are met. Store the heavier items down low and be sure that the weight is distributed equally. Stow all loose items securely before driving.

Improper weight distributions can have an adverse effect on the way your vehicle steers and handles and the way the brakes operate.

### **CAUTION!**

**Do not load your vehicle any heavier than the GVWR or the maximum front and rear GAWR. If you do, parts on your vehicle can break, or it can change the way your vehicle handles. This could cause you to lose control. Also overloading can shorten the life of your vehicle.**



An EXAMPLE of a loaded vehicle is shown in the following chart. Note that neither GVWR nor GAWR capabilities are exceeded. Overloading can cause potential safety hazards and shorten service life.

**NOTE:** The weights shown in this chart are not necessarily the weights for your vehicle. Also, the amount of load added to both the front and rear axles can be computed after the vehicle has been weighed both in its "curb weight" condition, and in its "loaded and ready for operation" condition.

### Gross Vehicle Weight Rating (GVWR) 6500 LBS.

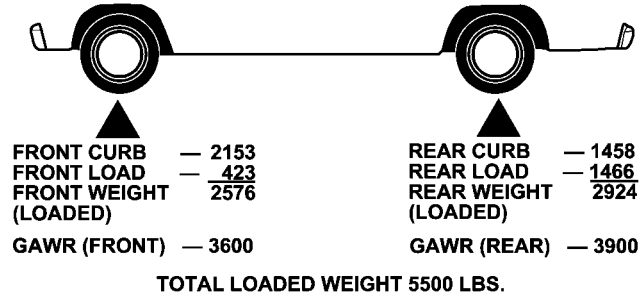

## TRAILER TOWING

In this section you will find safety tips and information on limits to the type of towing you can reasonably do with your vehicle. Before towing a trailer carefully review this information to tow your load as efficiently and safely as possible.

To maintain warranty coverage, follow the requirements and recommendations in this manual concerning vehicles used for trailer towing.

### Common Towing Definitions

The following trailer towing related definitions will assist you in understanding the following information:

### Gross Vehicle Weight Rating (GVWR)

The GVWR is the total allowable weight of your vehicle. This includes driver, passengers, cargo and tongue weight. The total load must be limited so that you do not exceed the GVWR.

### Gross Trailer Weight (GTW)

The gross trailer weight (GTW) is the weight of the trailer plus the weight of all cargo, consumables and equipment (permanent or temporary) loaded in or on the trailer in its "loaded and ready for operation" condition. The recommended way to measure GTW is to put your fully loaded trailer on a vehicle scale. The entire weight of the trailer must be supported by the scale.

**Gross Combination Weight Rating (GCWR)**

The gross combination weight rating (GCWR) is the total permissible weight of your vehicle and trailer when weighed in combination. (Note that GCWR ratings include a 68 kg (150 lbs) allowance for the presence of a driver).

**Gross Axle Weight Rating (GAWR)**

The GAWR is the maximum capacity of the front and rear axles. Distribute the load over the front and rear axles evenly. Make sure that you do not exceed either front or rear GAWR.

**WARNING!**

**It is important that you do not exceed the maximum front or rear GAWR. A dangerous driving condition can result if either rating is exceeded. You could lose control of the vehicle and have an accident.**

**Tongue Weight (TW)**

The downward force exerted on the hitch ball by the trailer. In most cases it should not be less than 10% or more than 15% of the trailer load. You must consider this as part of the load on your vehicle.

**Frontal Area**

The maximum height and maximum width of the front of a trailer.

**Trailer Sway Control**

The trailer sway control is a telescoping link that can be installed between the hitch receiver and the trailer tongue that typically provides adjustable friction associated with the telescoping motion to dampen any unwanted trailer swaying motions while traveling.

**Weight-Carrying Hitch**

A weight-carrying hitch supports the trailer tongue weight, just as if it were luggage located at a hitch ball or some other connecting point of the vehicle. These kind of hitches are the most popular on the market today and they're commonly used to tow small- and medium-sized trailers.

**Weight-Distributing Hitch**

A weight-distributing system works by applying leverage through spring (load) bars. They are typically used for heavier loads, to distribute trailer tongue weight to the tow vehicle's front axle and the trailer axle(s). When used in accordance with the manufacturers' directions, it provides for a more level ride, offering more consistent steering and brake control thereby enhancing towing safety. The addition of a friction / hydraulic sway control also dampens sway caused by traffic and crosswinds and contributes positively to tow vehicle and trailer stability. Trailer sway control and a weight distributing (load equalizing) hitch are recommended for heavier Tongue Weights (TW) and may be required depending on Vehicle and Trailer configuration / loading to comply with gross axle weight rating (GAWR) requirements.

**WARNING!**

An improperly adjusted Weight Distributing Hitch system may reduce handling, stability, braking performance, and could result in an accident.

Weight Distributing Systems may not be compatible with Surge Brake Couplers. Consult with your hitch and trailer manufacturer or a reputable Recreational Vehicle dealer for additional information.

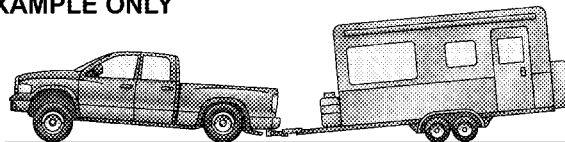
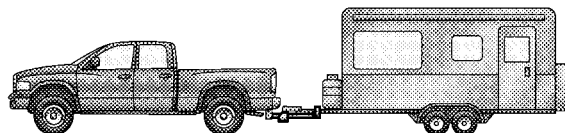
**EXAMPLE ONLY****FIG. 1 WITHOUT WEIGHT DISTRIBUTION (INCORRECT)****FIG. 2. WITH WEIGHT DISTRIBUTION (CORRECT)**

8181F965

**Weight Distributing Hitch System**

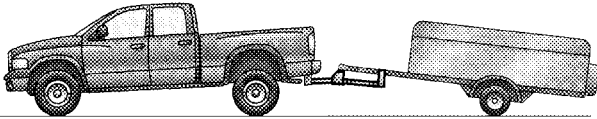
**EXAMPLE ONLY****FIG. 3 IMPROPER ADJUSTMENT (INCORRECT)**

818196F

**Improper Adjustment of Weight Distributing System****Fifth-Wheel Hitch**

A special high platform with a coupling that mounts over the rear axle of the tow vehicle in the truck bed. Connects a vehicle and fifth-wheel trailer with a coupling king pin.

**Gooseneck Hitch**

The gooseneck hitch employs a pivoted coupling arm which attaches to a ball mounted in the bed of a pickup truck. The coupling arm connects to the hitch mounted over the rear axle in the truck bed.

**Trailer Hitch Classification**

The rear bumper is intended to tow trailers up to 2,000 lbs (907 kg) without added equipment or alterations to the standard equipment. Your vehicle may be factory equipped for safe towing of trailers weighing over 2,000 lbs (907 kg) with the optional Trailer Tow Prep Package. See your dealer for package content.

The following chart provides the industry standard for the maximum trailer weight a given trailer hitch class can tow and should be used to assist you in selecting the correct trailer hitch for your intended towing condition. Refer to “Trailer Towing Weights (Maximum Trailer

Weight Ratings)” for the website address that contains the necessary information for your specific drivetrain.

Trailer Hitch Classification	
Class	Max. GTW (Gross Trailer Wt.)
Class I - Light Duty	2,000 lbs (907 kg)
Class II - Medium Duty	3,500 lbs (1587 kg)
Class III - Heavy Duty	5,000 lbs (2268 kg)
Class IV - Extra Heavy Duty	10,000 lbs (4540 kg)
Fifth Wheel/ Gooseneck	Greater than 10,000 lbs (4540 kg)

All trailer hitches should be professionally installed on your vehicle.

### Trailer Towing Weights (Maximum Trailer Weight Ratings)

**NOTE:** For additional trailer towing information (maximum trailer weight ratings) refer to the following website addresses:

- [http:// www.dodge.com/towing](http://www.dodge.com/towing).
- [http:// www.dodge.ca](http://www.dodge.ca) (Canada).

### Trailer and Tongue Weight

Always load a trailer with 60% to 65% of the weight in the front of the trailer. This places 10% to 15% of the Gross Trailer Weight (GTW) on the tow hitch of your vehicle. Loads balanced over the wheels or heavier in the rear can cause the trailer to sway **severely** side to side which will cause loss of control of vehicle and trailer. Failure to load trailers heavier in front is the cause of many trailer accidents.

Never exceed the maximum tongue weight stamped on your bumper or trailer hitch.

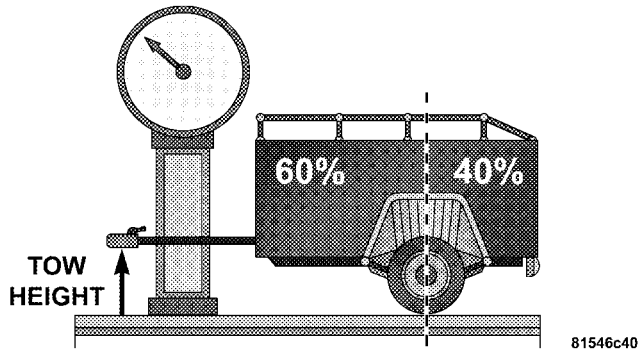

Consider the following items when computing the weight on the rear axle of the vehicle:

- The tongue weight of the trailer.

- The weight of any other type of cargo or equipment put in or on your vehicle.
- The weight of the driver and all passengers.

**NOTE:** Remember that everything put into or on the trailer adds to the load on your vehicle. Also, additional factory-installed options, or dealer-installed options, must be considered as part of the total load on your vehicle. Refer to the Tire and Loading Information placard in the Tire Safety Information Section of this manual.

### Towing Requirements

To promote proper break-in of your new vehicle drivetrain components the following guidelines are recommended:



**CAUTION!**

- **Avoid towing a trailer for the first 500 miles (805 km) of vehicle operation. Doing so may damage your axles, driveline and vehicle.**
- **During the first 500 miles (805 km) of trailer towing, limit your speed to 50 mph (80 km/h).**

Perform the maintenance listed in Section 8 of this manual. When towing a trailer, never exceed the GAWR, or GCWR, ratings.

**WARNING!**

**Improper towing can lead to an injury accident. Follow these guidelines to make your trailer towing as safe as possible:**

**Make certain that the load is secured in the trailer and will not shift during travel. When trailering cargo that is not fully secured, dynamic load shifts can occur that may be difficult for the driver to control. You could lose control of your vehicle and have an accident.**

- **When hauling cargo or towing a trailer, do not overload your vehicle or trailer. Overloading can cause a loss of control, poor performance or damage to brakes, axle, engine, transmission, steering, suspension, chassis structure or tires.**

- Safety chains must always be used between your vehicle and trailer. Always connect the chains to the frame or hook retainers of the vehicle hitch. Cross the chains under the trailer tongue and allow enough slack for turning corners.
- Vehicles with trailers should not be parked on a grade. When parking, apply the parking brake on the tow vehicle. Put the tow vehicle automatic transmission in P for Park. With a manual transmission, shift the transmission into reverse. And with four-wheel-drive vehicles, make sure the transfer case is not in neutral. Always, block or "chock" the trailer wheels.
- GCWR must not be exceeded.
- **Total weight must be distributed between the tow vehicle and the trailer such that the following four ratings are not exceeded:**
  1. GVWR

2. GTW

3. GAWR

4. Tongue weight rating for the trailer hitch utilized (This requirement may limit the ability to always achieve the 10% to 15% range of tongue weight as a percentage of total trailer weight).

### Towing Requirements — Tires

- Do not attempt to tow a trailer while using a compact spare tire.
- Proper tire inflation pressures are essential to the safe and satisfactory operation of your vehicle. Refer to the Tires–General Information section of this manual on Tire Pressures for proper tire inflation procedures.
- Also, check the trailer tires for proper tire inflation pressures before trailer usage.

- Check for signs of tire wear or visible tire damage before towing a trailer. Refer to the Tires–General Information section of this manual on Tread Wear Indicators for the proper inspection procedure.
- When replacing tires refer to the Tires–General Information section of this manual on Replacement Tires for proper tire replacement procedures. Replacing tires with a higher load carrying capacity will not increase the vehicle’s GVWR and GAWR limits.

#### **Towing Requirements — Trailer Brakes**

- Do **not** interconnect the hydraulic brake system or vacuum system of your vehicle with that of the trailer. This could cause inadequate braking and possible personal injury.
- An electronically actuated trailer brake controller is required when towing a trailer with electronically

actuated brakes. When towing a trailer equipped with a hydraulic surge actuated brake system, an electronic brake controller is not required.

- Trailer brakes are recommended for trailers over 1,000 lbs (454 kg) and required for trailers in excess of 2,000 lbs (907 kg).

#### **CAUTION!**

**If the trailer weighs more than 1,000 lbs (454 kg) loaded, it should have its own brakes and they should be of adequate capacity. Failure to do this could lead to accelerated brake lining wear, higher brake pedal effort, and longer stopping distances.**

**WARNING!**

Do not connect trailer brakes to your vehicle's hydraulic brake lines. It can overload your brake system and cause it to fail. You might not have brakes when you need them and could have an accident.

Towing any trailer will increase your stopping distance. When towing you should allow for additional space between your vehicle and the vehicle in front of you. Failure to do so could result in an accident.

**Towing Requirements — Trailer Lights & Wiring**

Whenever you pull a trailer, regardless of the trailer size, stop lights and turn signals on the trailer are required for motoring safety.

The Trailer Tow Package may include a 4 and 7 pin wiring harness. Use a factory approved trailer harness and connector.

**NOTE:** Do not cut or splice wiring into the vehicles wiring harness.

The electrical connections are all complete to the vehicle but you must mate the harness to a trailer connector. Refer to the following illustrations.

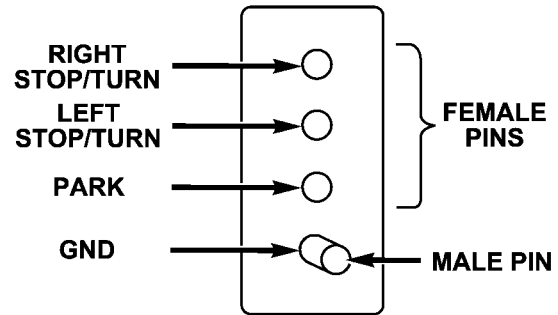

4 - Pin Connector

813262be

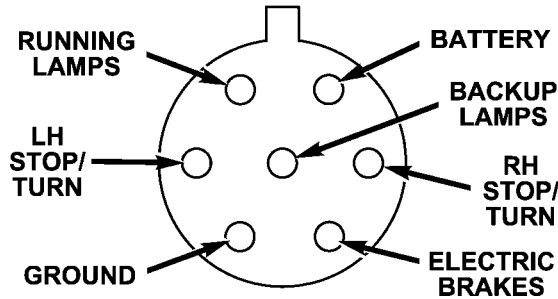

812634c6

7- Pin Connector

### Towing Tips

Before setting out on a trip, practice turning, stopping and backing the trailer in an area away from heavy traffic.

If using a manual transmission vehicle for trailer towing, all starts must be in FIRST gear to avoid excessive clutch slippage.

### Towing Tips — Automatic Transmission

The “D” range can be selected when towing. However, if frequent shifting occurs while in this range, the “TOW HAUL” or “OD/OFF” range should be selected.

**NOTE:** Using the “TOW HAUL” or “OD/OFF” range while operating the vehicle under heavy operating conditions will improve performance and extend transmission life by reducing excessive shifting and heat build up. This action will also provide better engine braking.

The automatic transmission fluid and filter should be changed if you REGULARLY tow a trailer for more than 45 minutes of continuous operation. See Schedule “B” in section 8 of this manual for transmission fluid change intervals.

**NOTE:** Check the automatic transmission fluid level before towing.

### **Towing Tips — Tow/Haul (If Equipped)**

To reduce potential for automatic transmission overheating, turn the “TOW HAUL OD/OFF” feature ON when driving in hilly areas or shift the transmission to Drive position 2 on more severe grades.

### **Towing Tips — Electronic Speed Control (If Equipped)**

- Don't use in hilly terrain or with heavy loads.
- When using the speed control, if you experience speed drops greater than 10 mph (16 km/h), disengage until you can get back to cruising speed.
- Use speed control in flat terrain and with light loads to maximize fuel efficiency.

### **Towing Tips — Cooling System**

To reduce potential for engine and transmission overheating, take the following actions:

#### **– City Driving**

When stopped for short periods of time, put transmission in neutral and increase engine idle speed.

#### **– Highway Driving**

Reduce speed.

#### **– Air Conditioning**

Turn off temporarily.

- refer to Cooling System Operating information in the Maintenance section of this manual for more information.

**Trailer Towing Mirrors — If Equipped**

These mirrors are designed with an adjustable mirror head to provide a greater vision range when towing extra-wide loads. To change position inboard or outboard, the mirror head should be rotated (flipped Out or In). A small blindspot mirror is integrated onto the main mirror surface.

**NOTE:** Fold the 7 x 10 inch trailer towing mirrors rearward prior to entering an automated car wash.

**CAUTION!**

Do not attempt to fold the 7 x 10 inch trailer towing mirrors forward. The 7 x 10 inch trailer towing mirrors are not designed to be folded forward and doing so will damage the mirrors and/or vehicle.

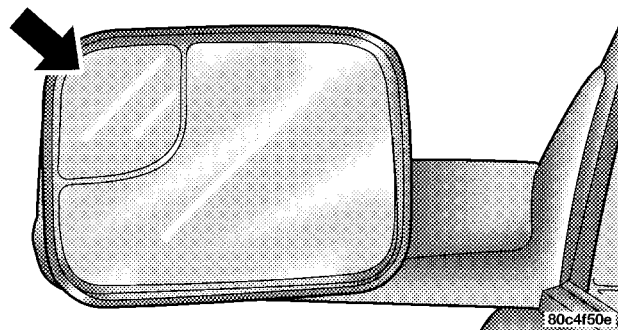
**Blindspot Mirror**

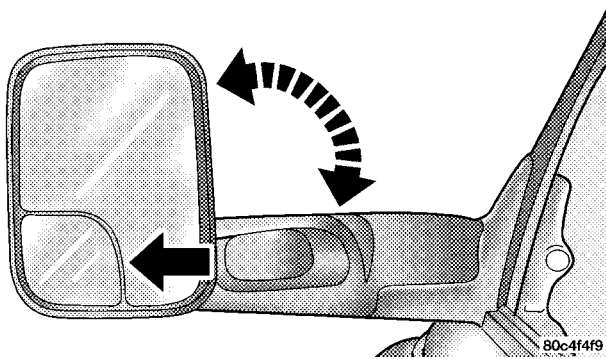

Trailer Towing Position

## SNOWPLOW

### Dodge Power Wagon Models

**NOTE:** Do not use Dodge Power Wagon Models for snowplow applications.

### WARNING!

Snowplows and other aftermarket equipment should not be added to the front end of your vehicle. The airbag crash sensors may be affected by the change in the front end structure. The airbags could deploy unexpectedly or could fail to deploy during a collision resulting in serious injury or death.



**CAUTION!**

Using this vehicle for snowplow applications can cause damage to the vehicle.

**WARNING!**

Attaching a snowplow to this vehicle could adversely affect performance of the airbag system in an accident. Do not expect that the airbag will perform as described earlier in this manual

**RECREATIONAL TOWING — 4-WHEEL DRIVE VEHICLES (BEHIND MOTORHOME, ETC.)**

**CAUTION!**

Internal damage to the transfer case will occur if a front or rear wheel lift is used when recreational towing.

**NOTE:** The transfer case must be shifted into Neutral (N) for recreational towing. Automatic transmissions must be placed in P (Park) position for recreational towing. Manual transmissions must be left in gear (not in neutral) for recreational towing. Refer below for the proper transfer case Neutral shifting procedure for your vehicle.

### Recreational Towing Procedure — Manual Shift Transfer Case — If Equipped

Use the following procedure to prepare your vehicle for recreational towing:

#### CAUTION!

**It is necessary to follow these steps to be certain that the transfer case is fully in N (NEUTRAL) before recreational towing to prevent damage to internal parts.**

1. Bring the vehicle to a complete stop.
2. Shut OFF the engine.
3. Depress the brake pedal.
4. Shift automatic transmission to N (NEUTRAL), or depress the clutch on manual transmissions.
5. Shift transfer case lever into N (NEUTRAL).
6. Start the engine.
7. Shift automatic transmission into Reverse (R).
8. Release brake pedal for five seconds and ensure that there is no vehicle movement.
9. Repeat steps 7 and 8 with the transmission in Drive (D).
10. Shut OFF the engine and place the ignition key to the unlocked OFF position.
11. Shift automatic transmission into P (PARK).
12. Apply the parking brake.
13. Attach vehicle to tow vehicle with tow bar.
14. Release the parking brake.

**CAUTION!**

**Damage to the automatic transmission may occur if the transmission is shifted into P (PARK) with the transfer case in N (NEUTRAL) and the engine RUNNING. With the transfer case in N (NEUTRAL) ensure that the engine is OFF prior to shifting the transmission into P (PARK)**

**Returning to Normal Operation — Manual Shift Transfer Case**

Use the following procedure to prepare your vehicle for normal usage:

1. Bring the vehicle to a complete stop.
2. Shut OFF the engine.
3. Depress the brake pedal.

4. Shift automatic transmission to N (NEUTRAL), or depress the clutch on manual transmissions.
5. Shift transfer case lever to desired position.
6. Shift automatic transmission into P (Park).

**WARNING!**

**You or others could be injured if you leave the vehicle unattended with the transfer case in the N (NEUTRAL) position without first fully engaging the parking brake. The transfer case N (NEUTRAL) position disengages both the front and rear drive-shafts from the powertrain and will allow the vehicle to move regardless of the transmission position. The parking brake should always be applied when the driver is not in the vehicle.**

**CAUTION!**

- **Do not use a bumper mounted clamp-on tow bar on your vehicle. The bumper face bar will be damaged.**
- **Do not disconnect the rear driveshaft because fluid will leak from the transfer case and damage the internal parts.**

**EQUIPMENT IDENTIFICATION PLATE**

The equipment Identification Plate is located on the hood inner surface.

The following information about your vehicle is displayed on this plate: Model, Wheelbase, Vehicle Identification Number, Truck Order Number, and code numbers with descriptions of all production and special equipment on the truck as shipped from the factory.

**NOTE:** Always refer to the Equipment Identification Plate When Ordering Parts.



---

# WHAT TO DO IN EMERGENCIES

## CONTENTS

---

■ Hazard Warning Flasher . . . . .	366	■ Jump-Starting . . . . .	375
■ Jacking And Tire Changing . . . . .	367	■ Freeing A Stuck Vehicle . . . . .	378
□ All Models . . . . .	367	■ Emergency Tow Hooks — If Equipped . . . . .	379
■ Jacking Instructions . . . . .	368	■ Towing A Disabled Vehicle . . . . .	380
□ Removing The Spare Tire . . . . .	368	□ 4-Wheel-Drive Vehicles . . . . .	380
□ Tire Changing Procedure . . . . .	369	■ Winch Usage . . . . .	380
■ Hoisting . . . . .	375		

### HAZARD WARNING FLASHER

The Hazard Warning switch is mounted on the top of the steering column as shown in the illustration.

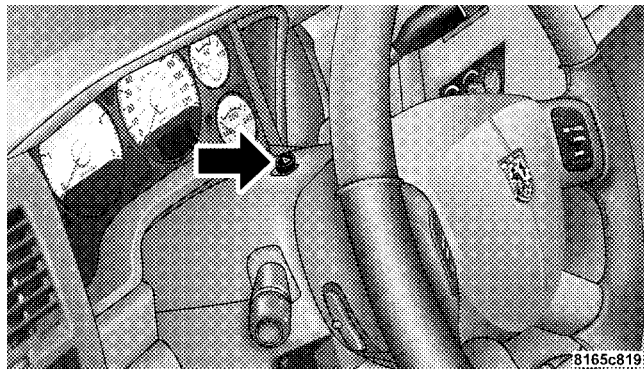

#### Hazard Light Warning Switch

To engage the Hazard Warning lights, depress the button on the top of the steering column. When the Hazard Warning switch is activated, all directional turn signals

will flash off and on to warn oncoming traffic of an emergency. Push the button a second time to turn off the flashers.

This is an emergency warning system and should not be used when the vehicle is in motion. Use it when your vehicle is disabled and is creating a safety hazard for other motorists.

When you must leave the vehicle to seek assistance, the Hazard Warning lights will continue to operate even though the ignition switch is OFF.

**NOTE:** With extended use, the Hazard Warning lights may discharge your battery.

## JACKING AND TIRE CHANGING

### WARNING!

- **Being under a jacked-up vehicle is dangerous. The vehicle could slip off the jack and fall on you. You could be crushed. Never put any part of your body under a vehicle that is on a jack. Never start or run the engine while the vehicle is on a jack. If you need to get under a raised vehicle, take it to a service center where it can be raised on a lift.**
- **The jack is designed to use as a tool for changing tires only. The jack should not be used to lift the vehicle for service purposes. The vehicle should be jacked on a firm level surface only. Avoid ice or slippery areas.**

### All Models

The jack and jack tools are stored under the front passenger seat. Lift the flap on the side of the seat for access.

Remove the jack and tools by removing the wing bolt and sliding the assembly from under the seat.

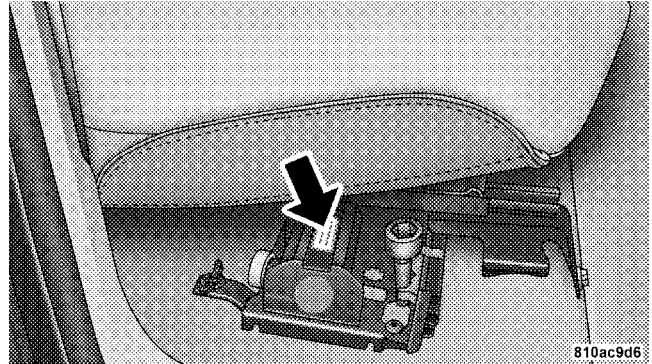



**WARNING!**

After using the jack and tools, always reinstall them in the original carrier and location. While driving you may experience, abrupt stopping, rapid acceleration, or sharp turns. A loose jack, tools, bracket or other objects in the vehicle may move around with force, resulting in serious injury.

**JACKING INSTRUCTIONS****Removing The Spare Tire**

Remove the spare tire before attempting to jack the truck. Attach the wheel wrench to the jack extension tube. Insert the tube through the access hole between the lower tailgate and the top of the bumper and into the winch mechanism tube. Rotate the wheel wrench handle counterclockwise until the spare tire is on the ground with enough cable slack to allow you to pull it out from under

the vehicle. When the spare is clear, tilt the retainer at the end of the cable and pull it through the center of the wheel.

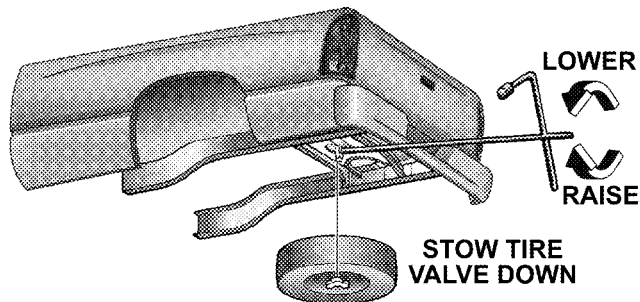

810ae782

It is recommended that you stow the flat or spare to avoid tangling the loose cable.

**NOTE:** The winch mechanism is designed for use with the jack extension tube only. Use of an air wrench or other power tools is not recommended and can damage the winch.

### Tire Changing Procedure

#### **WARNING!**

**Getting under a jacked-up vehicle is dangerous. The vehicle could slip off the jack and fall on you. You could be crushed. Never get any part of your body under a vehicle that is on a jack. Never start or run the engine while the vehicle is on a jack. If you need to get under a raised vehicle, take it to a service center where it can be raised on a lift.**

Do not raise this vehicle using a bumper jack. The jack is designed as a tool for changing tires on this vehicle only.

It is not recommended that the jack be used for service purposes or to lift more than one wheel at a time.

#### **Preparations**

Park the vehicle on a firm level surface, avoiding ice or slippery areas. Set the parking brake and place the gear selector in PARK (automatic transmission) or REVERSE (manual transmission). On four-wheel drive vehicles, shift the transfer case to the “4L” position.

#### **WARNING!**

**Do not attempt to change a tire on the side of the vehicle close to moving traffic. Pull far enough off the road to avoid the danger of being hit when operating the jack or changing the wheel.**

- Turn on the Hazard Warning Flasher.

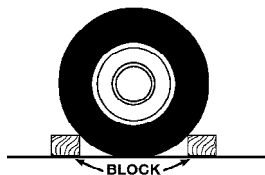

- Block both the front and rear of the wheel diagonally opposite the jacking position. For example, if the right front wheel is being changed, block the left rear wheel.
- Passengers should not remain in the vehicle when the vehicle is being jacked.

### Instructions

#### **WARNING!**

Carefully follow these tire changing warnings to help prevent personal injury or damage to your vehicle:

- Always park on a firm, level surface as far from the edge of the roadway as possible before raising the vehicle.
- Block the wheel diagonally opposite the wheel to be raised.
- Apply the parking brake firmly before jacking.
- Never start the engine with the vehicle on a jack.
- Do not let anyone sit in the vehicle when it is on a jack.
- Do not get under the vehicle when it is on a jack.
- Only use the jack in the positions indicated.
- If working on or near a roadway, be extremely careful of motor traffic.

1. Remove the spare wheel, jack, and tools from storage.
2. Using the wheel wrench, loosen, but do not remove, the wheel nuts by turning them counterclockwise one turn while the wheel is still on the ground.
3. For Power Wagon, when changing the front wheel, assemble the jack drive tube to the jack and connect the drive tube to the extension tube. Place the jack under the axle as close to the tire as possible with the drive tubes extending to the front. Connect the jack tube extension and wheel wrench.

When changing a rear wheel, assemble the jack drive tube to the jack and connect the drive tube to the extension tube. Place the jack under the axle between the spring and the shock absorber with the drive tubes extending to the rear. Connect the jack tube extension and wheel wrench.

**Before raising the wheel off the ground, make sure that the jack will not damage surrounding truck parts and adjust the jack position as required.**

**NOTE:** If the jack will not lower by turning the dial (thumb wheel) by hand, it may be necessary to use the jack drive tube in order to lower the jack.

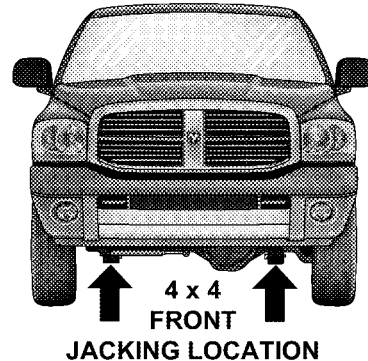

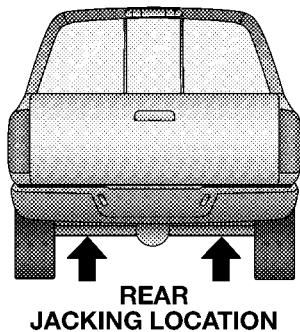

80ef9fa5

4. By rotating the wheel wrench clockwise, raise the vehicle until the wheel just clears the surface.

**WARNING!**

Raising the vehicle higher than necessary can make the vehicle unstable and cause an accident. It could slip off the jack and hurt someone near it. Raise the vehicle only enough to remove the tire.

5. Remove the wheel nuts and pull the wheel off. Install the spare wheel and wheel nuts with the cone shaped end of the nuts toward the wheel on the rear wheel models.
6. Using the wheel wrench, finish tightening the nuts using a crisscross pattern. Correct nut tightness is 135 ft. lbs. (183 N·m) torque. If in doubt about the correct tightness, have them checked with a torque wrench by your dealer or at a service station.

**WARNING!**

**A loose tire or jack thrown forward in a collision or hard stop could injure someone in the vehicle. Always stow the jack parts and the extra tire and wheel in the places provided.**

7. Remove wheel blocks. Do not install chrome or aluminum wheel center caps on the spare wheel. This may result in cap damage.
8. Lower the jack to its fully closed position. If the jack will not lower by turning the dial (thumb wheel) by hand, it may be necessary to use the jack drive tube in order to lower the jack. Stow the replaced tire, jack, and tools as previously described.
9. Adjust the tire pressure when possible.

**NOTE:** Do not oil wheel studs. For chrome wheels, do not substitute with chrome plated wheel nuts.

**Hub Caps**

The hub caps must be removed before raising the vehicle off the ground.

For 2500/3500 single rear wheel (SRW) models, use the blade on the end of the lug wrench to pry the hub cap off. Insert the blade end into the pryoff notch and carefully pop off the hub cap with a back and forth motion.

**CAUTION!**

**Use a back and forth motion to remove the hub cap. Do not use a twisting motion when removing the hub cap, damage to the hub cap finish may occur.**

### Wheel Nuts

All wheel nuts should be tightened occasionally to eliminate the possibility of wheel studs being sheared or the bolt holes in the wheels becoming elongated. This is especially important during the first few hundred miles of operation to allow the wheel nuts to become properly set. All nuts should first be firmly seated against the wheel. The nuts should then be tightened to recommended torque. Tighten the nuts to final torque in increments. Progress around the bolt circle, tightening the nut opposite to the nut just previously tightened until final torque is achieved. Recommended torques are shown in the following chart.

Disc Wheels	Type Nut	Stud Size	Torque Ft. Lbs.	Torque Newton Meters
	Cone	9/16-18	120-150	160-200
	Flanged	9/16-18	130-160	190-220

### To Stow The Flat Or Spare

Turn the wheel so that the valve stem is down. Slide the wheel retainer through the center of the wheel and position it properly across the wheel opening.

For convenience in checking the spare tire inflation, stow with the valve stem toward the rear of the vehicle.

Attach the wheel wrench to the extension tube. Rotate the winch mechanism until the wheel is drawn into place against the underside of the vehicle. Continue to rotate until you feel the winch mechanism slip or click 3 or 4 times. It cannot be overtightened. Push against the tire several times to be sure it is firmly in place.

## HOISTING

A conventional floor jack may be used at the jacking locations, refer to the graphics that show jacking locations. However, a floor jack or frame hoist must never be used on any other parts or the underbody.

### CAUTION!

**Never use a floor jack directly under the differential housing of a loaded truck or damage to your vehicle may result.**

## JUMP-STARTING

You should not try to start your vehicle by pushing or towing. Vehicles equipped with an automatic transmission cannot be started this way and pushing or towing a vehicle equipped with a manual transmission may overheat and damage the catalytic converter. Also, there is a greater risk of an accident when a vehicle is being pushed or towed. If the vehicle has a discharged battery, booster cables may be used to obtain a start from a booster battery or the battery in another vehicle. This type of start can be dangerous if done improperly, so follow this procedure carefully.



**WARNING!**

**Battery fluid is a corrosive acid solution; do not allow battery fluid to contact eyes, skin or clothing. Don't lean over battery when attaching clamps or allow the clamps to touch each other. If acid splashes in eyes or on skin, flush contaminated area immediately with large quantities of water.**

**A battery generates hydrogen gas which is flammable and explosive. Keep flame or spark away from the vent holes.**

**Do not use a booster battery or any other booster source that has a greater than 12 volt system, i.e. Do not use a 24 volt power source.**

1. Remove all metal jewelry such as watch bands or bracelets which might make an unintended electrical contact.

2. Park the booster vehicle within cable reach but without letting the vehicles touch. Set the parking brake on both vehicles, place the automatic transmission in Park or the manual transmission in Neutral, and turn the ignition OFF.

3. Turn off the heater, radio, and all unnecessary electrical loads.

4. Connect one end of a jumper cable to the positive terminal of the booster battery. Connect the other end of the same cable to the positive terminal of the discharged battery.

**WARNING!**

**Do not permit vehicles to touch each other as this could establish a ground connection and personal injury could result.**

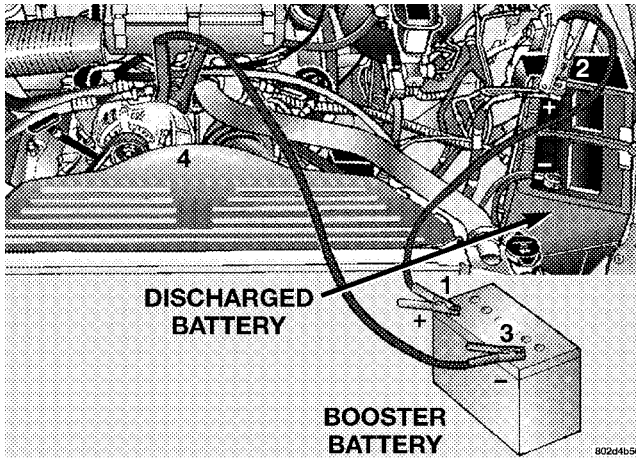

5. Connect the other cable, first to the negative terminal of the booster battery and then to the engine of the vehicle with the discharged battery. Make sure you have a good contact on the engine.

### WARNING!

- Do not connect the cable to the negative post of the discharge battery. The resulting electrical spark could cause the battery to explode.
- During cold weather when temperatures are below freezing point, electrolyte in a discharged battery may freeze. Do not attempt jump starting because the battery could rupture or explode. The battery temperature must be brought up above freezing point before attempting jump start.

6. Start the engine in the vehicle which has the booster battery, let the engine idle a few minutes, then start the engine in the vehicle with the discharged battery.
7. When removing the jumper cables, reverse the above sequence exactly. Be careful of the moving belts and fan.

**WARNING!**

**Any procedure other than above could result in:**

1. **Personal injury caused by electrolyte squirting out the battery vent;**
2. **Personal injury or property damage due to battery explosion;**
3. **Damage to charging system of booster vehicle or of immobilized vehicle.**

**FREEING A STUCK VEHICLE**

If vehicle becomes stuck in snow, sand, or mud, it can often be moved by a rocking motion. Move the gear selector rhythmically between DRIVE and REVERSE (automatic transmissions) and between 1st and REVERSE (manual transmissions), while applying slight pressure to the accelerator.

In general, the least amount of accelerator pedal pressure to maintain the rocking motion without spinning the wheels or racing the engine is most effective. Racing the engine or spinning the wheels, due to the frustration of not freeing the vehicle, may lead to transmission overheating and failure. Allow the engine to idle with the transmission selector in NEUTRAL for at least one minute after every five rocking-motion cycles. This will minimize overheating and reduce the risk of transmission failure during prolonged efforts to free a stuck vehicle.

**EMERGENCY TOW HOOKS — IF EQUIPPED**

Your vehicle may be equipped with emergency tow hooks.

**NOTE:** For off-road recovery, it is recommended to use both of the front tow hooks to minimize the risk of damage to the vehicle.

**WARNING!**

**Chains are not recommended for freeing a stuck vehicle. Chains may break, causing serious injury or death.**

**WARNING!**

**Stand clear of vehicles when pulling with tow hooks. Tow straps and chains may break, causing serious injury.**

**CAUTION!**

**Tow hooks are for emergency use only, to rescue a vehicle stranded off road. Do not use tow hooks for tow truck hookup or highway towing. You could damage your vehicle.**

**TOWING A DISABLED VEHICLE**

Proper towing or lifting equipment is required to prevent damage to your vehicle. Use only tow bars and other equipment designed for the purpose, following equipment manufacturer's instructions. Use of safety chains is mandatory. Attach a tow bar or other towing device to the main structural members of the vehicle—not to bumpers or associated brackets. State and local laws applying to vehicles under tow must be observed.

**4-Wheel-Drive Vehicles****CAUTION!**

**To avoid damage to the transfer case while towing, always use the following method.**

The manufacturer recommends towing with all wheels off the ground. Acceptable methods are to tow vehicle on a flatbed or with one end of vehicle raised and the opposite end on a towing dolly.

**WINCH USAGE**

(See page 289 for more information.)

---

# MAINTAINING YOUR VEHICLE

## CONTENTS

---

■ Engine Compartment— 5.7L . . . . .	384	□ Engine Oil Filter . . . . .	392
■ Onboard Diagnostic System (OBD II) . . . . .	385	□ Drive Belts — Check Condition And Tension . .	393
□ Loose Fuel Filler Cap Message . . . . .	385	□ Spark Plugs . . . . .	393
■ Emissions Inspection And Maintenance Programs . . . . .	386	□ Spark Plug Wires — If Equipped . . . . .	393
■ Replacement Parts . . . . .	387	□ Engine Air Cleaner Filter . . . . .	393
■ Dealer Service . . . . .	388	□ Engine Fuel Filter . . . . .	394
■ Maintenance Procedures . . . . .	388	□ Catalytic Converter . . . . .	394
□ Engine Oil . . . . .	389	□ Emission-Related Components . . . . .	396
		□ Maintenance Free Battery . . . . .	396

- Air Conditioner Maintenance . . . . . 397
- Power Steering — Fluid Check . . . . . 398
- Front Suspension Ball Joints . . . . . 399
- Steering Linkage — Inspection . . . . . 400
- Front Prop Shaft Lubrication . . . . . 400
- Body Lubrication . . . . . 401
- Windshield Wiper Blades . . . . . 401
- Windshield Washers . . . . . 401
- Exhaust System . . . . . 402
- Cooling System . . . . . 403
- Hoses And Vacuum/Vapor Harnesses . . . . . 408
- Brake System . . . . . 409
- Clutch Hydraulic System . . . . . 410
- Clutch Linkage . . . . . 410
- Rear Axle And 4X4 Front Driving Axle Fluid Level . . . . . 411
- Transfer Case . . . . . 412
- Front Drive Shaft . . . . . 412
- Manual Transmission . . . . . 412
- Automatic Transmission . . . . . 412
- Front Wheel Bearings . . . . . 415
- Selection Of Lubricating Grease . . . . . 416
- Noise Control System Required Maintenance & Warranty . . . . . 416
- Appearance Care And Protection From Corrosion . . . . . 420
- Fuses (Integrated Power Module) . . . . . 425

■ Vehicle Storage . . . . .	430	□ Cab Top Clearance Lights — If Equipped . . . .	438
■ Replacement Light Bulbs . . . . .	430	□ Fog Lights . . . . .	440
■ Bulb Replacement . . . . .	431	■ Fluids And Capacities . . . . .	441
□ Headlight (Halogen)/Front Park And Turn Lights . . . . .	431	■ Fluids, Lubricants And Genuine Parts . . . . .	442
□ Tail, Stop, Turn And Backup Lights . . . . .	434	□ Engine . . . . .	442
□ Center High-Mounted Stoplight With Cargo Light . . . . .	437	□ Chassis . . . . .	443



## ENGINE COMPARTMENT— 5.7L

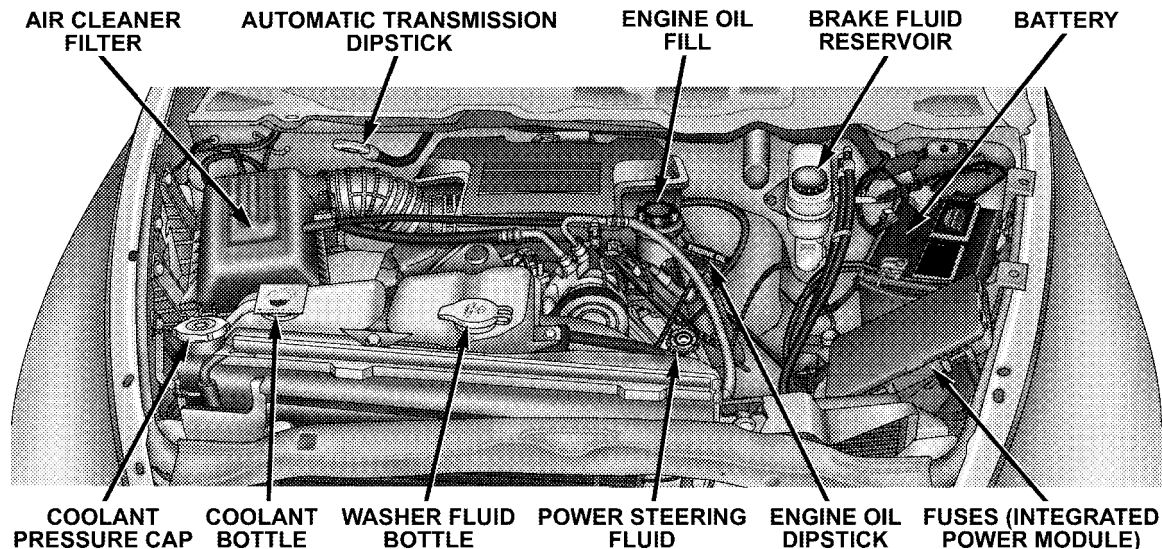

## ONBOARD DIAGNOSTIC SYSTEM (OBD II)

Vehicles equipped with California emissions controls have a sophisticated onboard diagnostic system called OBDII. This system monitors the performance of the emissions, engine, and automatic transmission control systems. When these systems are operating properly, your vehicle will provide excellent performance and fuel economy, as well as engine emissions well within current government regulations.

If any of these systems require service, the OBD II system will turn on the “Malfunction Indicator Light.” It will also store diagnostic codes and other information to assist your service technician in making repairs. Although your vehicle will usually be driveable and not need towing, see your dealer for service as soon as possible.

### CAUTION!

**Prolonged driving with the “Malfunction Indicator Light” on could cause further damage to the emission control system. It could also affect fuel economy and driveability. The vehicle must be serviced before any emissions tests can be performed.**

**If the “Malfunction Indicator Light” is flashing, severe catalytic converter damage and power loss will soon occur. Immediate service is required.**

## Loose Fuel Filler Cap Message

If the vehicle's diagnostic system determines that the fuel filler cap is loose, improperly installed, or damaged, a GASCAP message will be displayed in the instrument cluster. Tighten the gas cap until a “clicking” sound is heard. This is an indication that the gas cap is properly tightened. Press the odometer reset button to turn the

message off. If the problem persists, the message will appear the next time the vehicle is started. This might indicate a damaged cap. If the problem is detected twice in a row, the system will turn on the Malfunction Indicator Light (MIL). Resolving the problem will turn the MIL light off.

## EMISSIONS INSPECTION AND MAINTENANCE PROGRAMS

In some localities, it may be a legal requirement to pass an inspection of your vehicle's emissions control system. Failure to pass could prevent vehicle registration.



For states which have an I/M (Inspection and Maintenance) requirement, this check verifies the following: the MIL (Malfunction Indicator Lamp) is functioning and is not on when the engine is running, and that the OBD (On Board Diagnostic) system is ready for testing.

Normally, the OBD system will be ready. The OBD system may **not** be ready if your vehicle was recently serviced, if you recently had a dead battery, or a battery replacement. If the OBD system should be determined not ready for the I/M test, your vehicle may fail the test.

Your vehicle has a simple ignition key actuated test which you can use prior to going to the test station. To check if your vehicle's OBD system is ready, you must do the following:

1. Insert your ignition key into the ignition switch.
2. Turn the ignition to the ON position, but do not crank or start the engine.
3. If you crank or start the engine, you will have to start this test over.
4. As soon as you turn your key to the ON position, you will see your MIL symbol come on as part of a normal bulb check.

5. Approximately 15 seconds later, one of two things will happen:

a. The MIL light will blink for approximately 5 seconds and then remain on until the first engine crank or the key is turned off. This means that your vehicle's OBD system is **not ready** and you should **not** proceed to the I/M station.

b. The MIL light will remain fully illuminated until the first engine crank or the key is turned off. This means that your vehicle's OBD system is **ready** and you can proceed to the I/M station.

If your OBD system is **not ready**, you should see your dealer or repair facility. If your vehicle was recently serviced or had a battery failure or replacement, you may need to do nothing more than drive your vehicle as you normally would in order for your OBD system to update. A recheck with the above test routine may then indicate that the system is now ready.

Regardless of whether your vehicle's OBD system is ready or not ready, if the MIL symbol is illuminated during normal vehicle operation, you should have your vehicle serviced before going to the I/M station. The I/M station can fail your vehicle because the MIL symbol is on with the engine running.

### REPLACEMENT PARTS

Use of genuine Mopar® parts for normal/scheduled maintenance and repairs is highly recommended to insure the designed performance. Damage or failures caused by the use of non-Mopar parts for maintenance and repairs will not be covered by the manufacturer's warranty.

### DEALER SERVICE

Your dealer has the qualified service personnel, special tools and equipment to perform all service operations in an expert manner. Service manuals are available which include detailed service information for your vehicle. Refer to these manuals before attempting any procedure yourself.

**NOTE:** Intentional tampering with emissions control systems can result in civil penalties being assessed against you.

### WARNING!

**You can be badly injured working on or around a motor vehicle. Do only that service work for which you have the knowledge and the proper equipment. If you have any doubt about your ability to perform a service job, take your vehicle to a competent mechanic.**

### MAINTENANCE PROCEDURES

The pages that follow contain the **required** maintenance services determined by the engineers who designed your vehicle.

Besides the maintenance items for which there are fixed maintenance intervals, there are other items that should operate satisfactorily without periodic maintenance. However, if a malfunction of these items does occur, it

could adversely affect the engine or vehicle performance. These items should be inspected if a malfunction is observed or suspected.

## Engine Oil

### Checking Oil Level

To assure proper lubrication of your vehicle's engine, the engine oil must be maintained at the correct level. The best time to check the engine oil level is about 5 minutes after a fully warmed up engine is shut off or before starting the engine after it has sat overnight.

Checking the oil while the vehicle is on level ground will improve the accuracy of the oil level readings. Maintain the oil level between the ADD and SAFE markings on the dipstick. Adding one quart of oil when the reading is at the ADD mark will result in a SAFE reading on these engines.

### CAUTION!

Overfilling or underfilling the crankcase will cause oil aeration or loss of oil pressure. This could damage your engine.

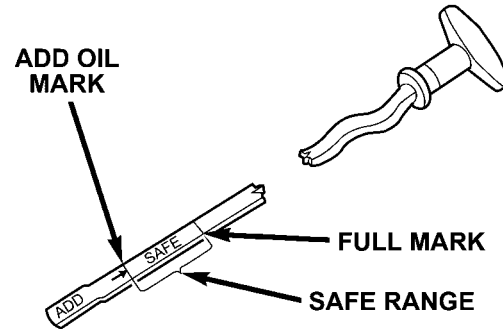

80bd0aae

### Change Engine Oil

Road conditions as well as your kind of driving affect the interval at which your oil should be changed. Check the following to determine if any apply to you:

- Day or night temperatures are below 32°F (0°C).
- Stop and go driving.
- Extensive engine idling.
- Driving in dusty conditions
- Short trips of less than 10 miles (16.2 km)
- More than 50% of your driving is at sustained high speeds during hot weather, above 32°C (90°F)
- Trailer towing
- Heavy Loading
- Taxi, Police or delivery service (commercial service)

- Off-road or desert operation
- **If equipped for and operating with E-85 (ethanol) fuel.**

**NOTE:** If ANY of these apply to you then change your engine oil every 3,000 miles (5 000 km) or 3 months, whichever comes first and follow schedule "B" of the "Maintenance Schedules" section of this manual.

If none of these apply to you, then change your engine oil at every interval shown on schedule "A" of the "Maintenance Schedules" section of this manual.

**NOTE:** Under no circumstances should oil change intervals exceed 6,000 miles (10 000 km) or 6 months whichever comes first.

### Dusty Conditions

Driving through dust-laden air increases the problems of keeping abrasive materials out of the engine. Under these conditions, special attention should be given to the

engine air cleaner, the crankcase inlet air cleaner and the crankcase ventilation system. Make sure that these units are clean at all times. This will tend to reduce to a minimum the amount of abrasive material that may enter the engine.

### Engine Oil Selection

For best performance and maximum protection under all types of operating conditions, the manufacture only recommends engine oils that are API certified and meet the requirements of DaimlerChrysler Material Standard MS-6395. Use Mopar or an equivalent oil meeting the specification MS-6395.

### American Petroleum Institute (API) Engine Oil Identification Symbol

There is a symbol to aid you in selecting the proper engine oil.



This symbol means that the oil has been certified by the American Petroleum Institute (API). The manufacture only recommends API Certified engine oils.

### Engine Oil Viscosity (SAE Grade)

For trucks with a 5.7L engine operating under a gross combined weight rating of 14,000 lbs. or greater, SAE 5W-30 engine oil is recommended for all operating temperatures. For all other trucks with a 5.7L engine, operating under a gross weight rating less than 14,000 lbs. SAE 5W-20 engine oil is recommended for all operating temperatures. This engine oil improves low temperature starting and vehicle fuel economy. Your engine oil filler cap also shows the recommended engine oil viscosity for your vehicle



For information on engine oil filler cap location, see the Engine Compartment illustration in this section.

Lubricants which do not have both, the engine oil certification mark and the correct SAE viscosity grade number should not be used.

### **Synthetic Engine Oils**

You may use synthetic engine oils provided the recommended oil quality requirements are met, and the recommended maintenance intervals for oil and filter changes are followed.

### **Materials Added to Engine Oil**

The manufacture strongly recommends against the addition of any additives (other than leak detection dyes) to the engine oil. Engine oil is an engineered product and it's performance may be impaired by supplemental additives.

### **Disposing of Used Engine Oil And Oil Filters**

Care should be taken in disposing of used engine oil and oil filters from your vehicle. Used oil and oil filters, indiscriminately discarded, can present a problem to the environment. Contact your dealer, service station, or governmental agency for advice on how and where used oil and oil filters can be safely discarded in your area.

### **Engine Oil Filter**

The engine oil filter should be replaced at every engine oil change.

### **Engine Oil Filter Selection**

The manufacturer's engines have a full-flow type oil filter. Use a filter of this type for replacement. The quality of replacement filters varies considerably. Only high quality filters should be used to assure most efficient service. Mopar Engine Oil Filters are a high quality oil filter and are recommended.

### **Drive Belts — Check Condition and Tension**

Belt tension is controlled by means of an automatic tensioner. No belt tension adjustments are required. However, belt and belt tensioner condition should be inspected at the specified intervals and replaced if required. See your authorized dealer for service.

At the mileage indicated in the maintenance schedule, all belts and tensioner should be checked for condition. Improper belt tension can cause belt slippage and failure.

Belts should be inspected for evidence of cuts, cracks, glazing or frayed cords and replaced if there is indication of damage which could result in belt failure. Low generator belt tension can cause battery failure.

Also check belt routing to make sure there is no interference between the belts and other engine components.

### **Spark Plugs**

Spark plugs must fire properly to assure engine performance and emission control. New plugs should be installed at the specified mileage. The entire set should be replaced if there is any malfunction due to a faulty spark plug, malfunctioning spark plugs can damage the catalytic converter. For proper type of replacement spark plugs, refer to the “Vehicle Emission Control Information” label in the engine compartment.

### **Spark Plug Wires — IF Equipped**

The spark plug wires should be kept clean and properly connected. Terminals should be fully seated. Cracked, damaged, or faulty wires should be replaced.

### **Engine Air Cleaner Filter**

Under normal driving conditions, replace the air filter at the intervals shown on Schedule “A”. If, however, you

drive the vehicle frequently under dusty or severe conditions, the filter element should be inspected periodically and replaced if necessary at the intervals shown on Schedule "B".

### **WARNING!**

**The air induction system (air cleaner, hoses, etc) can provide a measure of protection in the case of engine backfire. Do not remove the air induction system (air cleaner, hoses, etc) unless such removal is necessary for repair or maintenance. Make sure that no one is near the engine compartment before starting the vehicle with the air induction system (air cleaner, hoses, etc) removed. Failure to do so can result in serious personal injury.**

### **Engine Fuel Filter**

A plugged fuel filter can cause stalling, limit the speed at which a vehicle can be driven or cause hard starting. Should an excessive amount of dirt accumulate in the fuel tank, frequent filter replacement may be necessary.

### **Catalytic Converter**

The catalytic converter requires the use of unleaded fuel only. Leaded gasoline will destroy the effectiveness of the catalyst as an emission control device.

Under normal operating conditions, the catalytic converter will not require maintenance. However, it is important to keep the engine properly tuned to assure proper catalyst operation and prevent possible catalyst damage.

**CAUTION!**

Damage to the catalytic converter can result if your vehicle is not kept in proper operating condition. In the event of engine malfunction, particularly involving engine misfire or other apparent loss of performance, have your vehicle serviced promptly. Continued operation of your vehicle with a severe malfunction could cause the converter to overheat, resulting in possible damage to the converter and the vehicle.

**NOTE:** Intentional tampering with emissions control systems can result in civil penalties being assessed against you.

**WARNING!**

A hot exhaust system can start a fire if you park over materials that can burn. Such materials might be grass or leaves coming into contact with your exhaust system. Do not park or operate your vehicle in areas where your exhaust system can contact anything that can burn.

In unusual situations involving grossly malfunctioning engine operation, a scorching odor may indicate severe and abnormal catalyst overheating. If this occurs, the vehicle should be stopped, the engine shut off and the vehicle allowed to cool. Thereafter, service, including a tune-up to manufacturer's specifications, should be obtained immediately.

To minimize the possibility of catalyst damage:

- Do not shut off the engine or interrupt the ignition when the transmission is in gear and the vehicle is in motion.
- Do not try to start engine by pushing or towing the vehicle.
- Do not idle the engine with any spark plug wires disconnected or removed, such as when diagnostic testing, or for prolonged periods during very rough idling or malfunctioning operating conditions.

## Emission-Related Components

### Positive Crankcase (PCV) Valve

Proper operation of the crankcase ventilation system requires that the PCV valve be free of sticking or plugging from deposits. Deposits can accumulate in the PCV valve and passages with increasing mileage. Have the PCV valve, hoses, and passages checked for proper operation at the intervals specified. If the valve is plugged or sticking, replace with a new valve— **do not attempt to clean the old PCV valve!** Check the ventilation hoses for indications of damage, weepage or plugging with deposits. Replace if necessary.

### Maintenance Free Battery

The top of the maintenance free battery is permanently sealed. You will never have to add water, nor is periodic maintenance required.

**WARNING!**

Battery fluid is a corrosive acid solution and can burn or even blind you. Don't allow battery fluid to contact your eyes, skin or clothing. Don't lean over a battery when attaching clamps. If acid splashes in eyes or on skin, flush the area immediately with large amounts of water.

Battery gas is flammable and explosive. Keep flame or sparks away from the battery. Don't use a booster battery or any other booster source with an output greater than 12 volts. Don't allow cable clamps to touch each other.

Battery posts, terminals and related accessories contain lead and lead compounds. Wash hands after handling.

**CAUTION!**

It is essential when replacing the cables on the battery that the positive cable is attached to the positive post and the negative cable is attached to the negative post. Battery posts are marked (+) positive and negative (-) and identified on the battery case. Also, if a "fast charger" is used while battery is in vehicle, disconnect both vehicle battery cables before connecting the charger to battery. Do not use a "fast charger" to provide starting voltage.

**Air Conditioner Maintenance**

For best possible performance, your air conditioner should be checked and serviced by an Authorized Dealer at the start of each warm season. This service should include cleaning of the condenser fins and a performance test. Drive belt tension should also be checked at this time.

**WARNING!**

- **Use only refrigerants and compressor lubricants approved by the manufacturer for your air conditioning system. Some unapproved refrigerants are flammable and can explode, injuring you. Other unapproved refrigerants or lubricants can cause the system to fail, requiring costly repairs.**
- **The air conditioning system contains refrigerant under high pressure. To avoid risk of personal injury or damage to the system, adding refrigerant or any repair requiring lines to be disconnected should be done by an experienced repairman.**

**Refrigerant Recovery and Recycling**

R-134a Air Conditioning Refrigerant is a hydrofluorocarbon (HFC) that is endorsed by the Environmental Protection Agency and is an ozone-saving product. However, the manufacturer recommends that air conditioning service be performed by dealers or other service facilities using recovery and recycling equipment.

**NOTE:** Use only manufacturer approved A/C System Sealers, Stop Leak Products, Seal Conditioners, Compressor Oil, or Refrigerants.

**Power Steering — Fluid Check**

Checking the power steering fluid level at a defined service interval is not required. The fluid should only be checked if a leak is suspected, abnormal noises are apparent, and/or the system is not functioning as anticipated. Coordinate inspection efforts through a certified DaimlerChrysler Dealership."

**WARNING!**

**Fluid level should be checked on a level surface and with the engine off to prevent injury from moving parts and to insure accurate fluid level reading. Do not overfill. Use only manufacturers recommended power steering fluid.**

If necessary, add fluid to restore to the proper indicated level. With a clean cloth, wipe any spilled fluid from all surfaces. Refer to Fluids, Lubricants, and Genuine Parts for correct fluid type.

**Front Suspension Ball Joints**

**NOTE:** When anticipating any severe offroad or hill climbing maneuvers, the power steering fluid level may be increased to the FULL HOT level (with a cold system). In this way, the power steering system will continue to

provide assist as the inclination angle of the vehicle increases, i.e. when the vehicle is not on level ground.

**NOTE:** When anticipating any severe offroad/dusty or wet conditions, ensure that the outer tie rod ends are properly greased before and soon after the vehicle is taken through such conditions. The greasing will help purge contaminants and water from under the seal. Regular greasing will prolong the life of the ball joints.

The ball joints and seals should be inspected whenever the vehicle is serviced for other reasons.

The ball joints originally supplied with the vehicle are permanently lubricated at the factory and do not require service. However, if the seals on the ball joints are damaged, the joints should be replaced. Serviceable replacement ball joints are available.



Front suspension ball joints should be replaced only by a qualified service technician using tools specially designed for this purpose. Damage to the joints and/or suspension components may result if improper replacement procedures are used.

If seals are damaged the ball joints should be replaced to prevent leakage or contamination of the grease.

### Steering Linkage — Inspection

Whenever the vehicle is hoisted, all steering linkage joints should be inspected for evidence of damage. If seals are damaged, parts should be replaced to prevent leakage or contamination of the grease. Lubricate the steering linkage regularly according to the “Maintenance Schedule” in this manual.

### Front Prop Shaft Lubrication

Lubricate the front driveshaft grease fitting at each oil change listed in the appropriate Maintenance Schedule for your vehicle (Schedule “A” and “B”). Use Mopar® type MS-6560 (lithium based grease), or equivalent.

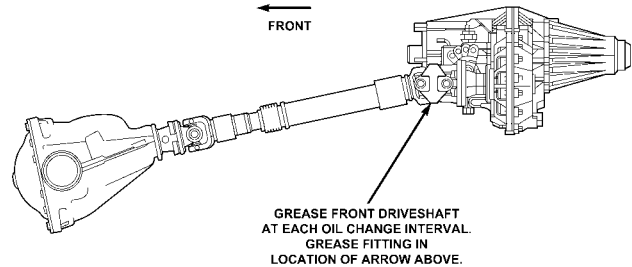

**Front Driveshaft Grease Fitting**

## Body Lubrication

Locks and all body pivot points, including such items as seat tracks, doors, tailgate and hood hinges, should be lubricated periodically to assure quiet, easy operation and to protect against rust and wear. Prior to the application of any lubricant, the parts concerned should be wiped clean to remove dust and grit; after lubricating excess oil and grease should be removed. Particular attention should also be given to hood latching components to insure proper function. When performing other underhood services, the hood latch, release mechanism and safety catch should be cleaned and lubricated.

The external lock cylinders should be lubricated twice a year, preferably in the fall and spring. Apply a small amount of a high quality lubricant such as Mopar® Lock Cylinder Lubricant directly into the lock cylinder.

## Windshield Wiper Blades

The rubber edges of the wiper blades and the windshield should be cleaned periodically with a sponge or soft cloth and a mild nonabrasive cleaner. This will remove accumulations of salt or road film.

Operation of the wipers on dry glass for long periods may cause deterioration of the wiper blades. Always use washer fluid when using the wipers to remove salt or dirt from a dry windshield.

Avoid using the wiper blades to remove frost or ice from the windshield. Keep the blade rubber out of contact with petroleum products such as engine oil, gasoline, etc.

## Windshield Washers

The fluid reservoir is located under the hood and should be checked for fluid level at regular intervals. Fill the reservoir with windshield washer solvent only (not radiator antifreeze).

To prevent freeze-up of your windshield washer system in cold weather, select a solution or mixture that meets or exceeds the temperature range of your climate. This rating information can be found on most washer fluid containers.

### WARNING!

**Commercially available windshield washer solvents are flammable. They could ignite and burn you. Care must be exercised when filling or working around the washer solution.**

After the engine has warmed, operate the defroster for a few minutes to reduce the possibility of smearing or freezing the fluid on the cold windshield. Mopar All Weather Windshield Washer Solution, used with water as

directed on the container, aids cleaning action, reduces the freezing point to avoid line clogging, and is not harmful to paint or trim.

### Exhaust System

The best protection against carbon monoxide entry into the vehicle body is a properly maintained engine exhaust system.

Whenever a change is noticed in the sound of the exhaust system, when exhaust fumes can be detected inside the vehicle, or when the underside or rear of the vehicle is damaged, have a competent mechanic inspect the complete exhaust system and adjacent body areas for broken, damaged, deteriorated, or mispositioned parts. Open seams or loose connections could permit exhaust fumes to seep into the passenger compartment. In addition, inspect the exhaust system each time the vehicle is raised for lubrication or oil change. Replace as required.

**WARNING!**

Exhaust gases can injure or kill. They contain carbon monoxide (CO) which is colorless and odorless. Breathing it can make you unconscious and can eventually poison you. To avoid breathing CO, follow the preceding safety tips.

### Exhaust System Rubber Isolator and Loop-Type Hanger — If Equipped

Inspect surfaces whenever the vehicle is hoisted for rubber to metal separation or deep cracks. **SLIGHT CRACKING DUE TO WEATHERING DOES NOT ADVERSELY AFFECT PERFORMANCE.** If, however, excessively deep localized cracks are present, or any part of the exhaust system abnormally contacts the underbody hardware, the isolator and/or hanger should be replaced.

## Cooling System

**WARNING!**

You or others can be badly burned by hot coolant or steam from your radiator. If you see or hear steam coming from under the hood, don't open the hood until the radiator has had time to cool. Never try to open a cooling system pressure cap when the radiator is hot.

### Engine Coolant Checks

Check the engine coolant (antifreeze) protection every 12 months (before the onset of freezing weather, where applicable). If coolant is dirty or rusty in appearance, the system should be drained, flushed and refilled with fresh coolant. Check the front of the A/C condenser for any

accumulation of bugs, leaves, etc. If dirty, clean by gently spraying water from a garden hose vertically down the face of the condenser.

Check the coolant recovery bottle tubing for brittle rubber, cracking, tears, cuts and tightness of the connection at the bottle and radiator. Inspect the entire system for leaks.

With the engine at normal operating temperature (but not running), check the cooling system pressure cap for proper vacuum sealing by draining a small amount of coolant from the radiator drain cock. If the cap is sealing properly, the engine coolant (antifreeze) will begin to drain from the coolant recovery bottle. **DO NOT REMOVE THE COOLANT PRESSURE CAP WHEN THE COOLING SYSTEM IS HOT.**

### **Cooling System — Drain, Flush and Refill**

At the intervals shown on the Maintenance Schedules, the system should be drained, flushed and refilled.

If the solution is dirty or contains a considerable amount of sediment, clean and flush with a reliable cooling system cleaner. Follow with a thorough rinsing to remove all deposits and chemicals. Properly dispose of old antifreeze solution.

### **Selection Of Coolant**

Use only the manufacturers recommended coolant, refer to Fluids, Lubricants and Genuine Parts for correct coolant type.

**CAUTION!**

**Mixing of coolants other than specified HOAT engine coolants, may result in engine damage and may decrease corrosion protection. If a non-HOAT coolant is introduced into the cooling system in an emergency, it should be replaced with the specified coolant as soon as possible.**

**Do not use plain water alone or alcohol base engine coolant (antifreeze) products. Do not use additional rust inhibitors or antirust products, as they may not be compatible with the radiator engine coolant and may plug the radiator.**

**This vehicle has not been designed for use with Propylene Glycol based coolants. Use of Propylene Glycol based coolants is not recommended.**

**Adding Coolant**

Your vehicle has been built with an improved engine coolant that allows extended maintenance intervals. This coolant can be used up to 5 Years or 100,000 miles before replacement. To prevent reducing this extended maintenance period, it is important that you use the same coolant throughout the life of your vehicle. Please review these recommendations for using Hybrid Organic Additive Technology (HOAT) coolant.

When adding coolant, a minimum solution of 50% recommended Mopar Antifreeze/ Coolant 5 Year/100,000 Mile Formula HOAT (Hybrid Organic Additive Technology), or equivalent, in water should be used. Use higher concentrations (not to exceed 70%) if temperatures below  $-34^{\circ}\text{F}$  ( $-37^{\circ}\text{C}$ ) are anticipated.

Use only high purity water such as distilled or deionized water when mixing the water/engine coolant solution.

The use of lower quality water will reduce the amount of corrosion protection in the engine cooling system.

Please note that it is the owner's responsibility to maintain the proper level of protection against freezing according to the temperatures occurring in the area where the vehicle is operated.

**NOTE:** Mixing coolant types will decrease the life of the engine coolant and will require more frequent coolant changes.

### Cooling System Pressure Cap

The cap must be fully tightened to prevent loss of coolant, and to insure that coolant will return to the radiator from the coolant recovery bottle.

The cap should be inspected and cleaned if there is any accumulation of foreign material on the sealing surfaces.

### WARNING!

- **The warning words "DO NOT OPEN HOT" on the cooling system pressure cap are a safety precaution. Never add coolant when the engine is overheated. Do not loosen or remove the cap to cool an overheated engine. Heat causes pressure to build up in the cooling system. To prevent scalding or injury, do not remove the pressure cap while the system is hot or under pressure.**
- **Do not use a pressure cap other than the one specified for your vehicle. Personal injury or engine damage may result.**

### Disposal of Used Engine Coolant

Used ethylene glycol based engine coolant is a regulated substance requiring proper disposal. Check with your local authorities to determine the disposal rules for your community. To prevent ingestion by animals or children

do not store ethylene glycol based engine coolant in open containers or allow it to remain in puddles on the ground. If ingested by a child, contact a physician immediately. Clean up any ground spills immediately.

### **Coolant Level**

The coolant bottle provides a quick visual method for determining that the coolant level is adequate. With the engine cold, the level of the coolant in the coolant recovery bottle should be between the ranges indicated on the bottle.

The radiator normally remains completely full, so there is no need to remove the radiator cap unless checking for coolant freeze point or replacing coolant. Advise your service attendant of this. As long as the engine operating temperature is satisfactory, the coolant bottle need only be checked once a month.

When additional coolant is needed to maintain the proper level, it should be added to the coolant bottle. Do not overfill.

### **Points To Remember**

**NOTE:** When the vehicle is stopped after a few miles (a few kilometers) of operation, you may observe vapor coming from the front of the engine compartment. This is normally a result of moisture from rain, snow, or high humidity accumulating on the radiator and being vaporized when the thermostat opens, allowing hot coolant to enter the radiator.

If an examination of your engine compartment shows no evidence of radiator or hose leaks, the vehicle may be safely driven. The vapor will soon dissipate.

- Do not overfill the coolant recovery bottle.



- Check coolant freeze point in the radiator and in the coolant recovery bottle. If antifreeze needs to be added, contents of coolant recovery bottle must also be protected against freezing.
- If frequent coolant additions are required, or if the level in the coolant recovery bottle does not drop when the engine cools, the cooling system should be pressure tested for leaks.
- Maintain coolant concentration at 50% HOAT engine coolant (minimum) and distilled water for proper corrosion protection of your engine which contains aluminum components.
- Make sure that the radiator and coolant recovery bottle overflow hoses are not kinked or obstructed.
- Keep the front of the radiator clean. If your vehicle is equipped with air conditioning, keep the front of the condenser clean, also.

- Do not change the thermostat for summer or winter operation. If replacement is ever necessary, install **ONLY** the correct type thermostat. Other designs may result in unsatisfactory coolant performance, poor gas mileage, and increased emissions.

### **Hoses And Vacuum/Vapor Harnesses**

Inspect surfaces of hoses and nylon tubing for evidence of heat and mechanical damage. Hard or soft spots, brittle rubber, cracking, tears, cuts, abrasions, and excessive swelling indicate deterioration of the rubber.

Pay particular attention to those hoses nearest to high heat sources such as the exhaust manifold. Inspect hose routing to be sure hoses do not come in contact with any heat source or moving component which may cause heat damage or mechanical wear.

Insure nylon tubing in these areas has not melted or collapsed.

Inspect all hose connections such as clamps and couplings to make sure they are secure and no leaks are present.

Components should be replaced immediately if there is any evidence of wear or damage that could cause failure.

## **Brake System**

### **Power Disc Brakes (front and rear)**

Disc brakes do not require adjustment; however, several hard stops during the break-in period are recommended to seat the linings and wear off any foreign material.

### **Brake Master Cylinder**

The fluid level of the master cylinder should be checked when performing under the hood service, or immediately if the brake system warning lamp indicates system failure.

The brake master cylinder has a translucent plastic reservoir. On the outboard side of the reservoir, there is a

“MAX” dot and an “MIN” dot. The fluid level must be kept within these two dots. Do not add fluid above the MAX mark, because leakage may occur at the cap.

With disc brakes the fluid level can be expected to fall as the brake linings wear. However, an unexpected drop in fluid level may be caused by a leak and a system check should be conducted.

Refer to Fluids, Lubricants and Genuine Parts for the correct Fluid type.

### **WARNING!**

**Use of a brake fluid that may have a lower initial boiling point, or is unidentified as to specification, may result in sudden brake failure during hard prolonged braking. You could have an accident.**

**WARNING!**

**Overfilling the brake fluid reservoir can result in spilling brake fluid on hot engine parts and the brake fluid catching fire.**

Use only brake fluid that has been in a tightly closed container to avoid contamination from foreign matter or moisture.

**CAUTION!**

**Do not allow a petroleum-base fluid to contaminate the brake fluid. Seal damage may result.**

**Brake Hoses**

Inspection should be performed whenever the brake system is serviced or at intervals specified. Inspect hydraulic brake hoses for surface cracking, scuffing or worn spots. If there is any evidence of cracking, scuffing, or worn spots, the hose should be replaced immediately! Eventual deterioration of the hose can take place with possible burst failure.

**Clutch Hydraulic System**

The clutch hydraulic system is a sealed maintenance-free system. In the event of leakage or other malfunction, the system must be replaced.

**Clutch Linkage**

If the clutch pedal linkage begins to squeak or grunt, the clutch pedal pivot bushings should be lubricated. Refer to Fluids, Lubricants and Genuine Parts for the correct lubricant type.

**Rear Axle And 4x4 Front Driving Axle Fluid Level**

Refer to Fluids, Lubricants and Genuine Parts for the correct Fluid type. For normal service, periodic fluid level checks are not required. When the vehicle is serviced for other reasons the exterior surfaces of the axle assembly should be inspected. If gear oil leakage is suspected inspect the fluid level.

This inspection should be made with the vehicle in a level position. The fluid level should be even with the bottom of the fill hole for the Manufacturer's C205F HD Front Axles. The fluid level should be 5/8" (16 mm) below on 9 1/4" Manufacturer's Rear Axles.

For all 2500 Model axles, the fluid level should be 1/4" ± 1/4" (6.4 mm ± 6.4 mm) below the fill hole on the 9.25" Front and 3/4" ± 1/4" (19 mm ± 6.4 mm) on 10.5" Rear axles.

**Drain and Refill**

Vehicles operated in normal service do not have regularly scheduled oil changes. If fluid has become contaminated with water or to provide the correct viscosity grade, drain and refill.

**Lubricant Selection**

Refer to Fluids, Lubricants and Genuine Parts for correct fluid type.

**NOTE:** The presence of water in the gear lubricant will result in corrosion and possible failure of differential components. Operation of the vehicle in water, as may be encountered in some off-highway types of service, will require draining and refilling the axle to avoid damage.

**Limited-Slip Differentials**

Power Wagon Axles **DO NOT REQUIRE** any limited slip oil additive (friction modifiers).

## **Transfer Case**

### **Fluid Level Check**

This fluid level can be checked by removing the filler plug. The fluid level should be to the bottom edge of the filler plug hole with the vehicle in a level position.

### **Lubricant Selection**

Refer to Fluids, Lubricants and Genuine Parts for correct fluid type.

## **Front Drive Shaft**

The front drive shaft contains a grease fitting which should be serviced at every oil change (see maintenance schedule A/B).

## **Manual Transmission**

### **Fluid Level Check**

This fluid level can be checked by removing the filler plug. If the level of the lubricant is more than 1/4" (6.4 mm) below the bottom of the filler hole while the vehicle

is on level ground, enough lubricant should be added to bring the level to the bottom of the filler hole.

## **Lubricant Selection G56 (6 – Speed Manual Transmission — If Equipped)**

This transmission does not require periodic changing. If it becomes necessary to add or change the fluid in this transmission, refer to Fluids, Lubricants and Genuine Parts for correct fluid type.

## **Automatic Transmission**

### **Fluid Level Check**

The fluid level should be checked when the engine is fully warmed up and the fluid in the transmission is at normal operating temperature. Operation of the transmission with an improper fluid level will greatly reduce the life of the transmission and of the fluid. Check the fluid level whenever the vehicle is serviced.

### Fluid Level Check – 545RFE

Check the fluid level while the transmission is at normal operating temperature 82°C (180°F). This occurs after at least 15 miles (25 km) of driving. At normal operating temperature the fluid cannot be held comfortably between the fingertips.

To check the automatic transmission fluid level properly, the following procedure must be used:

1. Operate the engine at idle speed and normal operating temperature.
2. The vehicle must be on level ground.
3. Fully apply the parking brake and press the brake pedal.
4. Place the gear selector momentarily in each gear position ending with the lever in P (Park).

5. Remove the dipstick, wipe it clean and reinsert it until seated.

6. Remove the dipstick again and note the fluid level on both sides. The fluid level should be between the “HOT” (upper) reference holes on the dipstick at normal operating temperature. Verify that solid coating of oil is seen on both sides of the dipstick. If the fluid is low, add as required into the dipstick tube. **Do not overfill.** After adding any quantity of oil through the oil fill tube, wait a minimum of two (2) minutes for the oil to fully drain into the transmission before rechecking the fluid level.

**NOTE:** If it is necessary to check the transmission **below** the operating temperature, the fluid level should be between the two “COLD” (lower) holes on the dipstick with the fluid at approximately 70°F (21°C) (room temperature). If the fluid level is correctly established at room temperature, it should be between the “HOT”

(upper) reference holes when the transmission reaches 180°F (82°C). Remember it is best to check the level at the normal operating temperature.

**CAUTION!**

**Be aware that if the fluid temperature is below 50°F (10°C) it may not register on the dipstick. Do not add fluid until the temperature is elevated enough to produce an accurate reading.**

7. Check for leaks. Release parking brake.

To prevent dirt and water from entering the transmission after checking or replenishing fluid, make certain that the dipstick cap is properly reseated. It is normal for the dipstick cap to spring back slightly from its fully seated position, as long as its seal remains engaged in the dipstick tube.

### **Selection Of Lubricant**

Refer to Fluids, Lubricants and Genuine Parts for correct fluid type. It is important that the transmission fluid be maintained at the prescribed level using the recommended fluid.

**CAUTION!**

**Using a transmission fluid other than the manufacturers recommended fluid may cause deterioration in transmission shift quality and/or torque converter shudder. Using a transmission fluid other than the manufacturers recommended fluid will result in more frequent fluid and filter changes. Refer to Fluids, Lubricants and Genuine Parts for correct fluid type.**

**Automatic Transmission Fluid and Filter Change**

To obtain best performance and long life for automatic transmissions, the manufacturer recommends that they be given regular maintenance service by an Authorized Dodge Dealer or Service Center.

It is important that proper lubricant is used in the transmission. Refer to Fluids, Lubricants and Genuine Parts for correct fluid type.

The fluid and filter(s) should be changed as specified in the Maintenance Schedule (Section 8).

**NOTE:** If the transmission is disassembled for any reason, the fluid and filter(s) should be changed.

**Special Additives**

The manufacturer strongly recommends against the addition of any additives to the transmission. Exception to this policy is the use of special dyes to aid in detecting

fluid leaks. The use of transmission sealers should be avoided, since they may adversely affect seals.

**Front Wheel Bearings**

Front wheel bearings for all Dodge Ram Trucks are sealed-for-life. They do not require greasing or seal replacement. In some instances, these bearings will “purge” excess grease and the bearing will look slightly wet. This is normal. Periodic inspection for excess play is recommended.

**Rear Wheel Bearings — Manufacturer’s Axles**

These bearings are normally considered permanently lubricated. Cleaning and repacking is required only when axle shafts are removed or in case of extreme water or dust contamination.



### Selection of Lubricating Grease

The National Lubricating Grease Institute (NLGI) has developed a symbol (Certification Mark) to aid the vehicle owner in the proper selection of grease for the lubrication of wheel bearings and chassis components. This symbol (an example is shown below) is located on the grease container and identifies the application and quality of the grease.



There are two groups identified, those for wheel bearings (Letter "G") and those for chassis (Letter "L") lubrication. Performance categories within these groups result in dual letter designations for each group. The letter designations shown in the example are the highest

quality level available and when combined as shown can be used for both wheel bearing and chassis lubrication. Use only those greases that have the NLGI symbol on the container along with the proper quality level for your application.

### Noise Control System Required Maintenance & Warranty

All vehicles built over 10,000 lbs (4 535 kg) Gross Vehicle Weight Rating and manufactured for sale and use in the United States are required to comply with the Federal Government's Exterior Noise Regulations. These vehicles

can be identified by the Noise Emission Control Label located in the operator's compartment.

**Vehicle Noise Emission Control Information**  
**Date of Vehicle Manufacture**

This vehicle conforms to U.S. EPA regulations for noise emission applicable to medium and heavy duty trucks.

The following acts or the causing thereof by any person are prohibited by the Noise Control Act of 1972: (A) the removal or rendering inoperative, other than for purposes of maintenance, repair, or replacement, of any noise control device or element of design (listed in the Owner's Manual) incorporated into this vehicle in compliance with the Noise Control Act (B) the use of this vehicle after such device or element of design has been removed or rendered inoperative.

80244b72

55216044

### Required Maintenance for Noise Control Systems

The following maintenance services must be performed every 6 months or 6,000 miles (9 600 km), whichever comes first, to assure proper operation of the noise control systems. In addition, inspection and service should be performed anytime a malfunction is observed or suspected. Proper maintenance of the entire vehicle will help the effectiveness of the noise control systems.

### Air Cleaner Assembly

Inspect air cleaner housing for proper assembly and fit. Make certain that the air cleaner is properly positioned and the cover is tight. Check all hoses leading to the cleaner for tightness. The gasket between the air cleaner housing and throttle body must be intact and in good condition. The engine air cleaner filter must also be clean and serviced according to the instructions outlined in the appropriate maintenance schedule.

**Tampering with Noise Control System Prohibited**

Federal law prohibits the following acts or the causing thereof: (1) the removal or rendering inoperative by any person, other than for purposes of maintenance, repair, or replacement, of any device or element of design incorporated into any new vehicle for the purpose of noise control prior to its sale or delivery to the ultimate purchaser or while it is in use, or (2) the use of the vehicle after such device or element of design has been removed or rendered inoperative by any person.

Among those acts presumed to constitute tampering are the acts listed below.

***AIR CLEANER***

- Removal of the air cleaner.
- Inverting the air cleaner lid.
- Removal of the air ducting.

***EXHAUST SYSTEM***

- Removal or rendering inoperative exhaust system components including the muffler or tailpipe.

***ENGINE COOLING SYSTEM***

- Removal or rendering inoperative the fan clutch.
- Removal of the fan shroud.

**Noise Emission Warranty**

The manufacturer warrants that this vehicle as manufactured by the manufacturer, was designed, built and equipped to conform at the time it left the manufacturers control with all applicable U.S. EPA Noise Control Regulations.

This warranty covers this vehicle as designed, built and equipped by the manufacturer, and is not limited to any particular part, component or system of the vehicle manufactured by the manufacturer. Defects in design,

assembly or in any part, component or system of the vehicle as manufactured by the manufacturer, which, at the time it left the manufacturers control, caused noise

emissions to exceed Federal standards, are covered by this warranty for the life of the vehicle.

Noise Systems Maintenance Chart and Service Log Insert Month, Day, Year under column mileage closest to the mileage at which service was performed.

MILES	6,000	12,000	18,000	24,000	30,000	36,000	42,000	48,000
KILOMETERS	9 600	19 000	29 000	36 000	48 000	58 000	67 000	77 000
Exhaust system-inspect								
Air cleaner assembly-inspect								
ODOMETER READING								
PERFORMED BY								
PERFORMED AT								

Noise Systems Maintenance Chart and Service Log Insert Month, Day, Year under column mileage closest to the mileage at which service was performed.

MILES	54,000	60,000	66,000	72,000	78,000	84,000	90,000	96,000
KILOMETERS	87 000	96 000	106 000	116 000	126 000	135 000	145 000	154 000
Exhaust system-inspect								
Air cleaner assembly-inspect								
ODOMETER READING								
PERFORMED BY								
PERFORMED AT								

### Appearance Care and Protection from Corrosion

#### Protection of Body and Paint from Corrosion

Vehicle body care requirements vary according to geographic locations and usage. Chemicals that make roads passable in snow and ice, and those that are sprayed on trees and road surfaces during other seasons, are highly

corrosive to the metal in your vehicle. Outside parking, which exposes your vehicle to airborne contaminants, road surfaces on which the vehicle is operated, extreme hot or cold weather and other extreme conditions will have an adverse effect on paint, metal trim, and underbody protection.

The following maintenance recommendations will enable you to obtain maximum benefit from the corrosion resistance built into your vehicle.

### **What Causes Corrosion?**

Corrosion is the result of deterioration or removal of paint and protective coatings from your vehicle.

The most common causes are:

- Road salt, dirt and moisture accumulation.
- Stone and gravel impact.
- Insects, tree sap and tar.
- Salt in the air near seacoast localities.
- Atmospheric fallout/industrial pollutants.

### **Washing**

- Wash your vehicle regularly. Always wash your vehicle in the shade using Mopar® Car Wash or a mild car wash soap, and rinse the panels completely with clear water.
- If insects, tar or other similar deposits have accumulated on your vehicle, use Mopar® Super Kleen Bug and Tar Remover to remove.
- Use Mopar® Cleaner Wax to remove road film, stains and to protect your paint finish. Take care never to scratch the paint.
- Avoid using abrasive compounds and power buffing that may diminish the gloss or thin out the paint finish.

**CAUTION!**

**Do not use abrasive or strong cleaning materials such as steel wool or scouring powder, which will scratch metal and painted surfaces.**

**Special Care**

- If you drive on salted or dusty roads or if you drive near the ocean, hose off the undercarriage at least once a month.
- It is important that the drain holes in the lower edges of the doors, rocker panels and trunk be kept clear and open.
- If you detect any stone chips or scratches in the paint, touch them up immediately. The cost of such repairs is considered the responsibility of the owner.

- If your vehicle is damaged due to an accident or similar cause which destroys the paint and protective coating, have your vehicle repaired as soon as possible. The cost of such repairs is considered the responsibility of the owner.
- If you carry special cargo such as chemicals, fertilizers, de-icer salt, etc., be sure that such materials are well packaged and sealed.
- If a lot of driving is done on gravel roads, consider mud or stone shields behind each wheel.
- Use Mopar® touch up paint on scratches as soon as possible. Your dealer has touch up paint to match the color of your vehicle.

**Wheel and Wheel Trim Care**

All wheels and wheel trim, especially aluminum and chrome plated wheels should be cleaned regularly with a mild soap and water to prevent corrosion. To remove

heavy soil, use Mopar® Wheel Cleaner or select a non-abrasive, non-acidic cleaner. Do not use scouring pads, steel wool, a bristle brush or metal polishes. Only Mopar® cleaners are recommended. Do not use oven cleaner. Avoid automatic car washes that use acidic solutions or harsh brushes that may damage the wheels' protective finish.

### **YES Essentials® Fabric Cleaning Procedure – If equipped**

YES Essentials® seats may be cleaned in the following manner:

- Remove as much of the stain as possible by blotting with a clean, dry towel.
- Blot any remaining stain with a clean, damp towel.
- For tough stains, apply Mopar® Total Clean or a mild soap solution to a clean, damp cloth and remove stain. Use a fresh, damp towel to remove soap residue.

- For grease stains, apply Mopar® Multi-purpose cleaner to a clean, damp cloth and remove stain. Use a fresh, damp towel to remove soap residue.
- Do not use any solvents or protectants on Yes Essentials products.

### **Interior Care**

Use Mopar® Total Clean to clean fabric upholstery and carpeting.

Use Mopar® Total Clean to clean vinyl upholstery.

Mopar® Total Clean is specifically recommended for leather upholstery.

Your leather upholstery can be best preserved by regular cleaning with a damp soft cloth. Small particles of dirt can act as an abrasive and damage the leather upholstery and should be removed promptly with a damp cloth. Stubborn soils can be removed easily with a soft cloth and Mopar® Total Clean. Care should be taken to avoid



soaking your leather upholstery with any liquid. Please do not use polishes, oils, cleaning fluids, solvents, detergents, or ammonia based cleaners to clean your leather upholstery. Application of a leather conditioner is not required to maintain the original condition.

### **WARNING!**

**Do not use volatile solvents for cleaning purposes. Many are potentially flammable, and if used in closed areas they may cause respiratory harm.**

### **Glass Surfaces**

All glass surfaces should be cleaned on a regular basis with Mopar® Glass Cleaner or any commercial household-type glass cleaner. Never use an abrasive type cleaner. Use caution when cleaning the inside rear window equipped with electric defrosters or the right rear quarter window equipped with the radio antenna. Do

not use scrapers or other sharp instruments which may scratch the elements. When cleaning the rear view mirror, spray cleaner on the towel or rag that you are using. Do not spray cleaner directly on the mirror.

### **Cleaning Plastic Instrument Cluster Lenses**

The lenses in front of the instruments in this vehicle are molded in clear plastic. When cleaning the lenses, care must be taken to avoid scratching the plastic.

1. Clean with a wet soft rag. A mild soap solution may be used, but do not use high alcohol content or abrasive cleaners. If soap is used, wipe clean with a clean damp rag.
2. Dry with a soft tissue.

### **Seat Belt Maintenance**

Do not bleach, dye or clean the belts with chemical solvents or abrasive cleaners. This will weaken the fabric. Sun damage can also weaken the fabric.

If the belts need cleaning, use a mild soap solution or lukewarm water. Do not remove the belts from the car to wash them.

Replace the belts if they appear frayed or worn or if the buckles do not work properly.

Dry with a soft tissue.

### **FUSES (INTEGRATED POWER MODULE)**

An integrated Power Module is located in the engine compartment near the battery. This center contains cartridge fuses and mini fuses. A description of each fuse and component may be stamped on the inside cover otherwise the cavity number of each fuse is stamped on the inside cover that corresponds to the following chart.

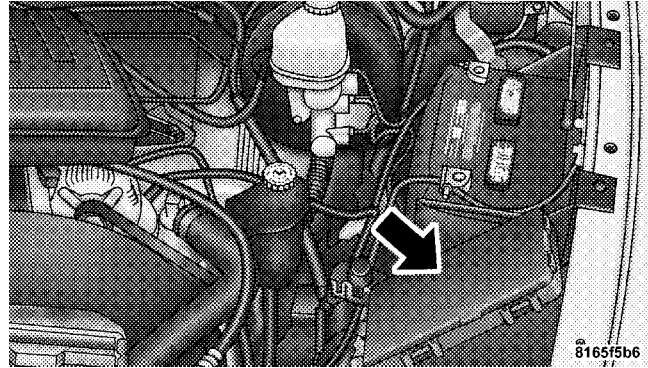

**Integrated Power Module Location**

Cavity	Cartridge Fuse	Mini Fuse	Description
1		20 Amp Yellow	Power Outlet Console
2		20 Amp Yellow	Cabin Compartment Node (CCN) Door Locks/Brake Transmission Shift Interlock (BTSI)
3		20 Amp Yellow	Spare
4		15 Amp Blue	Spare
5		20 Amp Yellow	Power Sunroof
6		10 Amp Red	VIST Fan/Wastegate

Cavity	Cartridge Fuse	Mini Fuse	Description
7		15 Amp Blue	Reverse Lockout Solenoid Battery (SRT-10 Only)
8		10 Amp Red	Heated Mirrors
9	30 Amp Pink		Off Road Module Power
10		5 Amp Orange	Trx-Off Rd Pkg Sen (Gas Engine Only)

Cavity	Cartridge Fuse	Mini Fuse	Description
11		20 Amp Yellow	Ignition Off Draw (IOD)-Cabin Compartment Node (CCN)/Radio/Under Hood Lamp/Wireless Control Module (WCM)/Satellite Digital Audio Receiver (SDARS)/Hands Free Module (HFM)
12	30 Amp Pink		Electric Brake
13		25 Amp Natural	Power-Battery RWAL/ABS Module Feed
14		15 Amp Blue	Park Lamps Left

Cavity	Cartridge Fuse	Mini Fuse	Description
15		20 Amp Yellow	Trailer Park Lamps
16		15 Amp Blue	Park Lamps Right
17		15 Amp Blue	Spare
18	40 Amp Green		ABS Pump
19	30 Amp Pink		Trailer Tow
20		10 Amp Red	Occupant Restraints Controller (ORC) 2
21		10 Amp Red	Occupant Restraints Controller (ORC) Pre-set Carrier
22		2 Amp Gray	IGN Switch Feed

Cavity	Cartridge Fuse	Mini Fuse	Description
23		10 Amp Red	Engine Control Module (ECM)/Wireless Control Module (WCM)/HVC
24	20 Amp Blue		Subwoofer Amplifier (SRT-10 Only)
25		10 Amp Red	Power Mirror
26		20 Amp Yellow	Brake Switch/Center High Mount Stop Lamp (CHMSL)
27	40 Amp Green		Power Seats
28		10 Amp Red	Power Run/Start-NCC/Wireless Control Module (WCM)/ABS/RWAL

Cavity	Cartridge Fuse	Mini Fuse	Description
29		10 Amp Red	Switches/EC Mirror/Smart Bar
30		15 Amp Blue	Spare
31		10 Amp Red	PCM/Transfer Case Brake
32		10 Amp Red	HVAC/Ajustable Pedals/Heated Seats Switch LED/Exhaust Brake
33		10 Amp Red	Power-IGN Run Misc
34		10 Amp Red	Spare
35		15 Amp Blue	Cabin Compartment Node (CCN) Illumination

Cavity	Cartridge Fuse	Mini Fuse	Description
36		25 Amp Natural	Audio_Amplifier
37		15 Amp Blue	Spare
38		20 Amp Yellow	Power Outlet IP
39		10 Amp Red	Sunroof/Seatbelt Tensioner
40		20 Amp Yellow	Cigar Lighter
41		25 Amp Natural	Spare
42	30 Amp Pink		Diesel PCM (Diesel Only)

### CAUTION!

- When installing the Integrated Power Module cover, it is important to ensure the cover is properly positioned and fully latched. Failure to do so may allow water to get into the Integrated Power Module, and possibly result in a electrical system failure.
- When replacing a blown fuse, it is important to use only a fuse having the correct amperage rating. The use of a fuse with a rating other than indicated may result in a dangerous electrical system overload. If a properly rated fuse continues to blow, it indicates a problem in the circuit that must be corrected.

## VEHICLE STORAGE

If you are storing your vehicle for more than 21 days, we recommend that you take the following steps to minimize the drain on your vehicle's battery:

- Disconnect the Ignition-Off Draw fuse (I.O.D.) fuse located in the Integrated Power Module, located in the engine compartment. The I.O.D. cavity includes a snap-in retainer that allows the fuse to be disconnected, without removing it from the fuse block.
- The electronic shift transfer case should be placed in the 4HI mode and kept in this position to minimize the battery drain.
- As an alternative to the above steps you may, disconnect the negative cables from both batteries.
- Anytime you store your vehicle, or keep it out of service (i.e. vacation) for two weeks or more, run the air conditioning system at idle for about five minutes

in the fresh air and high blower setting. This will insure adequate system lubrication to minimize the possibility of compressor damage when the system is started again.

**NOTE:** When reinstalling the IOD fuse push firmly until fully seated, the gages in the Instrument Cluster will do a full sweep, when the ignition key is cycled to RUN. This is a normal condition.

## REPLACEMENT LIGHT BULBS

<b>LIGHT BULBS — Inside</b>	<b>Bulb No.</b>
Overhead Console Lights . . . . .	TS 212-2
Dome Light. . . . .	7679

All of the inside bulbs are brass or glass wedge base. Aluminum base bulbs are not approved.

**LIGHT BULBS — Outside**

	<b>Bulb No.</b>
Back-Up . . . . .	3057
Center High Mounted Stop Lamp . . . . .	912
Fog Lamp . . . . .	9006LL
Headlamp (Halogen) . . . . .	H13
Side Marker, Park & Turn Signal . . . . .	3157NAK
Rear License Plate Lamp . . . . .	168
Rear Cargo Light . . . . .	912
Tail & Stop . . . . .	3057

**BULB REPLACEMENT**

**Headlight (Halogen)/Front Park and Turn Lights**

**CAUTION!**

This is a halogen bulb. Avoid touching the glass with your fingers. Reduced bulb life will result.

1. Open the hood
2. Remove the two (2) bolts from the front of the headlight housing.

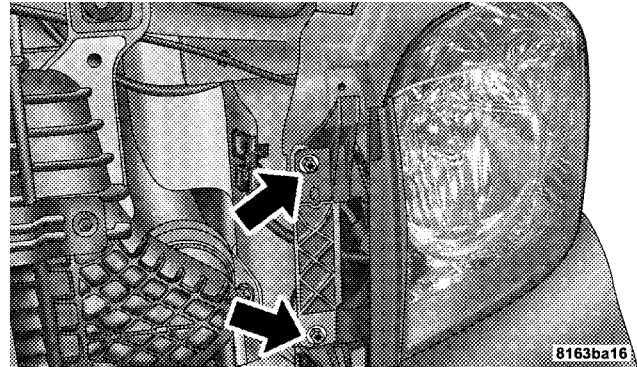

**Front Headlight Housing Bolts**



3. Remove the plug from the inner fender well and remove the nut through the access hole.

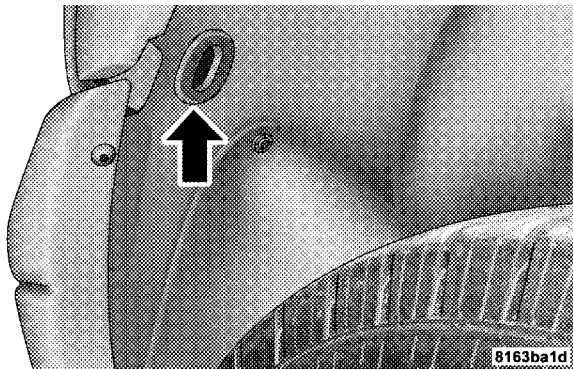

**Inner Fender Plug**

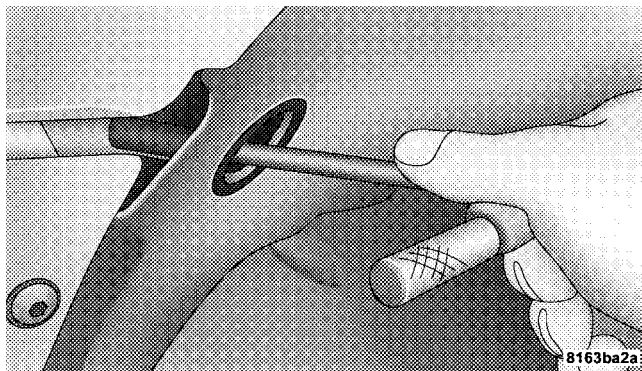

**Rear Headlight Housing Nut Access**

4. Pull the housing out from the fender to allow room to disconnect the electrical connectors.

**NOTE:** For easier removal, pull the headlight assembly straight forward, applying the greatest amount of force to the outer edge of the headlight assembly.

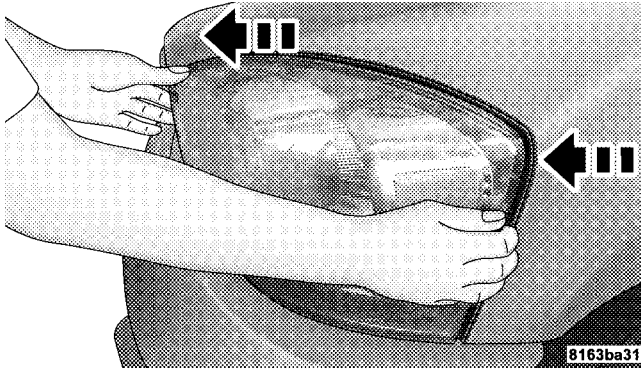
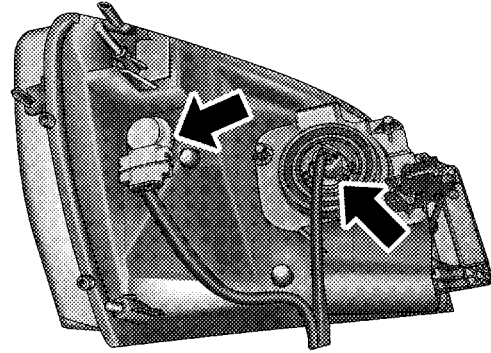
**Headlight Removal****Bulb Removal**

5. Unlock and pull connector straight from the base of the headlight halogen bulb.
6. Twist connector on the side marker/turn signal/park light bulb  $\frac{1}{4}$  turn and remove connector and bulb from housing.

7. Remove housing from vehicle with headlight halogen bulb in housing.
8. Twist the headlight halogen bulb  $\frac{1}{4}$  turn and remove headlight bulb from the housing.
9. Replace headlight or side marker/turn signal/park light bulb. Do not touch the headlight halogen bulb.
10. Reverse procedure for installation of bulbs and housing.

### Tail, Stop, Turn and Backup Lights

1. Remove the two (2) screws that pass through the bed sheetmetal.

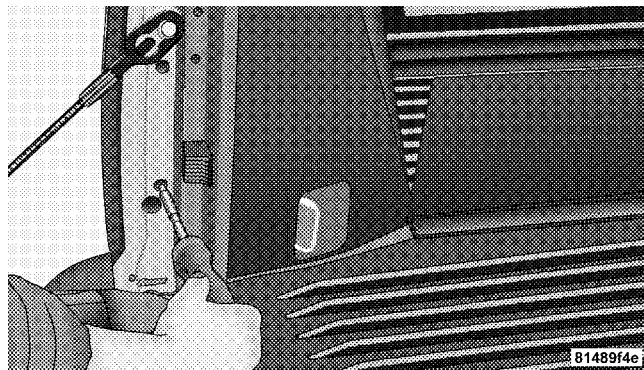

Removing the Two (2) Screws

2. Pull the housing straight out from the body, with a quick motion, to separate the housing from the body. If not pulled straight, locators may be damaged.

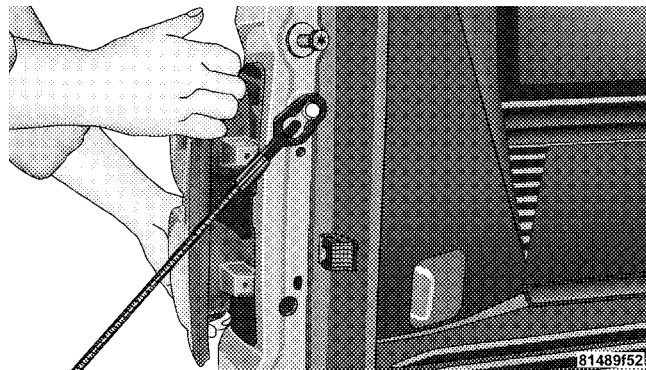

**Pulling Housing From Body**

3. Rotate the bulb socket counterclockwise to remove from the housing.

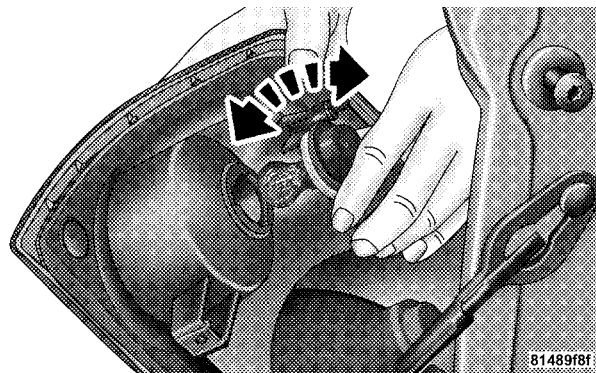

**Rotating Bulb Socket From Housing**

4. Pull bulb straight out of socket.

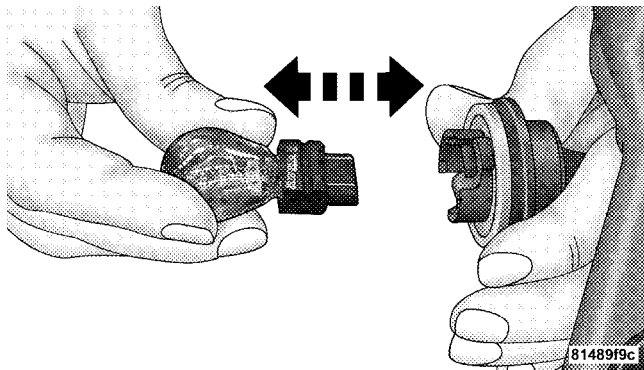

**Pulling Bulb From Socket**

5. Reverse Procedure to install bulb and housing. Place the two raised blocks passed the body.

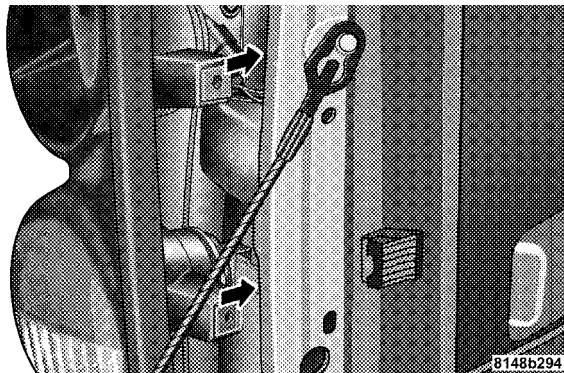

**Sliding Raised Blocks Past Body**

### Center High-Mounted Stoplight With Cargo Light

1. Remove the two (2) screws holding the housing/lens to the body as shown.

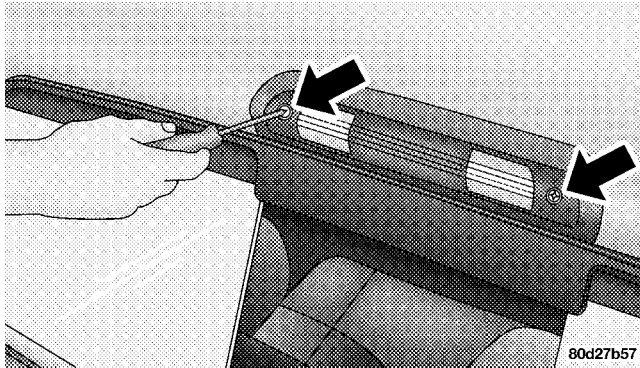

2. Separate the connector holding the housing and wiring harness to the body.

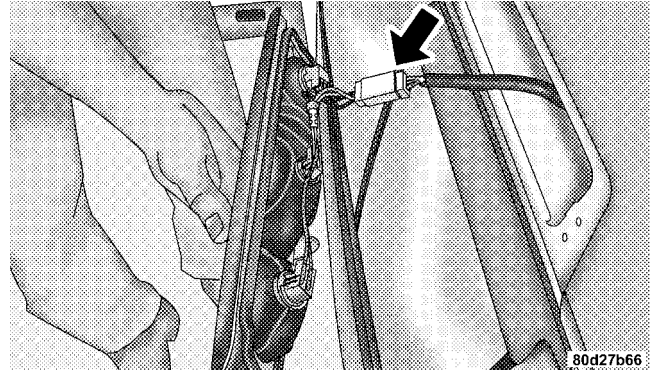

3. Turn desired bulb socket  $\frac{1}{4}$  turn and remove socket and bulb from housing.

4. Pull desired bulb straight from the socket.

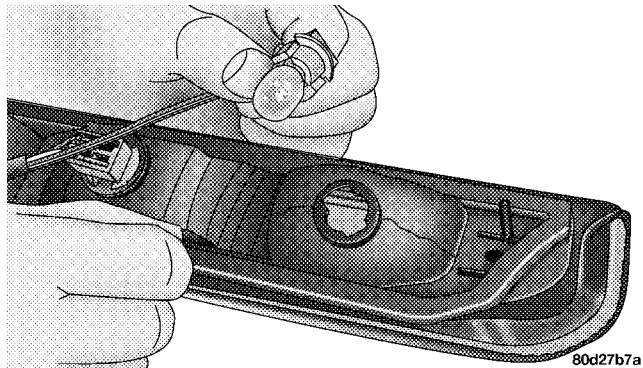

- Outside Bulbs: Cargo Lamps
- Inside Bulb: Center High Mount Stop Lamp

5. Reverse procedure for installation of bulbs and housing.

### Cab Top Clearance Lights — If Equipped

1. Remove the two screws from the top of the light.

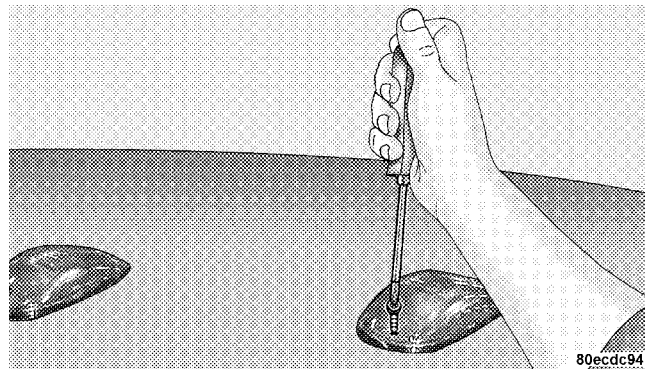

2. Rotate the socket  $\frac{1}{4}$  turn and pull it from the light assembly.

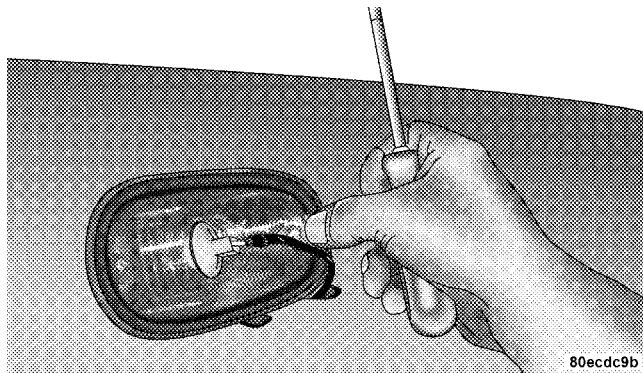

3. Pull the bulb straight from its socket and replace.

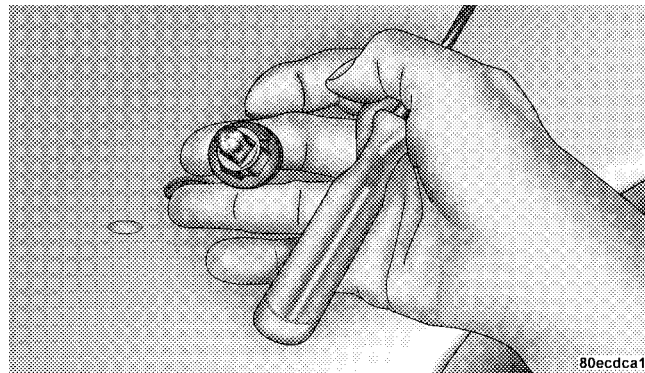



## Fog Lights

1. Reach under the vehicle, unlock and twist connector counterclockwise  $\frac{1}{4}$  turn and remove connector and bulb from housing.

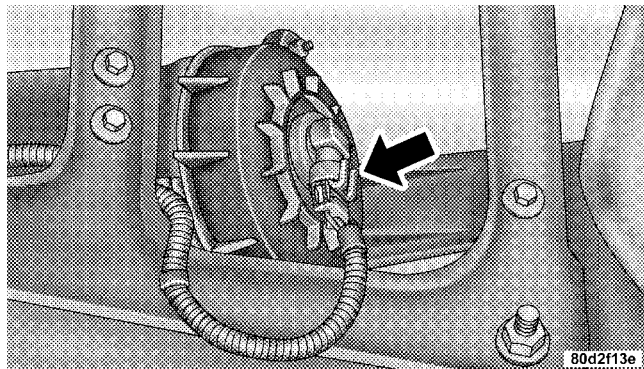

2. Pull bulb straight from the connector.

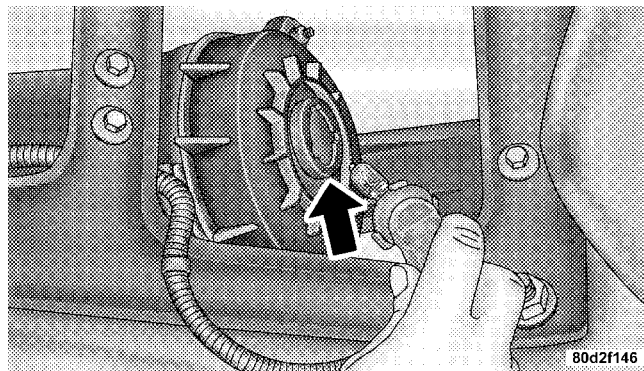

3. Reverse procedure for installation of bulbs and housing.

## FLUIDS AND CAPACITIES

	U.S.	Metric
<b>Fuel</b>		
5.7L, 89 Octane		
2500 Shortbed Models	34 gal.	128L
2500 Longbed Models	35 gal.	132L
<b>Engine Oil (with filter)</b>		
5.7L Engine V-8 (SAE 5W-20, API Certified). For trucks operating under a gross combined weight rating <b>less</b> than 14,000 lbs.	7.0 qts.	6.6L
5.7L Engine V-8 (SAE 5W-30, API Certified). For trucks operating under a gross combined weight rating <b>greater</b> than 14,000 lbs.	7.0 qts.	6.6L
<b>Cooling System</b>		
5.7L (Mopar® Antifreeze/Coolant 5 Year/100,000 Mile Formula)	18.7 qts.	17.7L

## FLUIDS, LUBRICANTS AND GENUINE PARTS

### Engine

Component	Fluids, Lubricants and Genuine Parts
Engine Coolant	Mopar® Antifreeze/Coolant 5 Year/100,000 Mile Formula HOAT (Hybrid Organic Additive Technology) P/N 5011764AB or equivalent.
Engine Oil (For trucks operating under a gross combined weight rating <b>less</b> than 14,000 lbs.)	Use SAE 5W-20, API Certified, meeting material standard MS-6395.
5.7L Engine Oil (For trucks operating under a gross combined weight rating <b>greater</b> than 14,000 lbs.)	Use SAE 5W-30, API Certified, meeting material standard MS-6395.
Engine Oil Filter	Mopar® Engine Oil Filter, P/N 5281090 or equivalent.
Spark Plugs	Refer to the Vehicle Emission Control Information label in the engine compartment.
Fuel Selection (5.7L)	89 Octane Mid-Grade, (R+M)/2 Method Preferred (87 Octane Acceptable)

## Chassis

Component	Fluids, Lubricants and Genuine Parts.
Automatic Transmission	Mopar® ATF+4, Automatic Transmission Fluid
Transfer Case	Mopar® ATF+4, Automatic Transmission Fluid
Manual Transmission Fluid (G-56)	Mopar® ATF+4, Automatic Transmission Fluid
Front Driveshaft Grease Fitting.	Use Mopar® type MS-6560 (lithium based grease), or equivalent.
Clutch Linkage	Multipurpose Grease, NLGI Grade 2 E.P.
Front and Rear Axle	Synthetic, GL-5 SAE, 75W-90. Limited-Slip 10.5 inch Rear Axle <b>DOES NOT REQUIRE</b> a limited slip additive.
Brake Master Cylinder	Mopar® DOT 3 and SAE J1703 should be used. If DOT 3 brake fluid is not available, then DOT 4 is acceptable. Use only recommended brake fluids.
Power Steering Reservoir	Mopar® ATF+4, Automatic Transmission Fluid



---

# MAINTENANCE SCHEDULES

## CONTENTS

---

<ul style="list-style-type: none"> <li>■ Emission Control System Maintenance . . . . . 446</li> <li>■ Maintenance Schedules . . . . . 446</li> </ul>	<ul style="list-style-type: none"> <li>□ Schedule “B” . . . . . 449</li> <li>□ Schedule “A” . . . . . 460</li> </ul>
--	--

### EMISSION CONTROL SYSTEM MAINTENANCE

The “Scheduled” maintenance services, listed in **bold type** in this section (Section 8) must be done at the times or mileages specified to assure the continued proper functioning of the emission control system. These, and all other maintenance services included in this manual, should be done to provide best vehicle performance and reliability. More frequent maintenance may be needed for vehicles in severe operating conditions such as dusty areas and very short trip driving.

Inspection and service also should be done any time a malfunction is suspected.

**NOTE:** Maintenance, replacement, or repair of the emission control devices and systems on your vehicle may be performed by any automotive repair establishment or individual using any automotive part which has been certified pursuant to U.S. EPA or, in the State of California, California Air Resources Board regulations.

### MAINTENANCE SCHEDULES

There are two maintenance schedules that show the **required** service for your vehicle.

First is Schedule “**B**”. It is for vehicles that are operated under the conditions that are listed below and at the beginning of the schedule.

- Day or night temperatures are below 32° F (0° C).
- Stop and go driving.
- Extensive engine idling.
- Driving in dusty conditions.
- Short trips of less than 10 miles (16 km).
- More than 50% of your driving is at sustained high speeds during hot weather, above 90° F C (32°).
- Trailer towing.
- Snowplowing.

- Heavy Loading.
- Taxi, police, or delivery service (commercial service).
- Off-road or desert operation.
- **If equipped for and operating with E-85 (ethanol) fuel.**

**NOTE:** If **ANY** of these apply to you then change your engine oil every 3,000 miles (5 000 km) or 3 months, whichever comes first and follow schedule "B" of the "Maintenance Schedules" section of this manual.

**NOTE:** If **ANY** of these apply to you then flush and replace your engine coolant every 102,000 miles (170 000 km) or 60 months, whichever comes first and follow schedule "B" of the "Maintenance Schedules" section of this manual.

**NOTE:** Most vehicles are operated under the conditions listed for Schedule "B".

Second is Schedule "A". It is for vehicles that are not operated under any of the conditions listed under Schedule "B".

Use the schedule that best describes your driving conditions. Where time and mileage are listed, follow the interval that occurs first.

**NOTE:** Under no circumstances should oil change intervals exceed 6000 miles (10 000 km) or 6 months whichever comes first.

### CAUTION!

**Failure to perform the required maintenance items may result in damage to the vehicle.**



### ***At Each Stop for Fuel***

- Check the engine oil level about 5 minutes after a fully warmed engine is shut off. Checking the oil level while the vehicle is on level ground will improve the accuracy of the oil level reading. Add oil only when the level is at or below the ADD or MIN mark.
- Check the windshield washer solvent and add if required.

### ***Once a Month***

- Check tire pressure and look for unusual wear or damage.
- Inspect the battery and clean and tighten the terminals as required.
- Check the fluid levels of coolant bottle, brake master cylinder, and transmission and add as needed.

- Check all lights and all other electrical items for correct operation.

### ***At Each Oil Change***

- Change the engine oil filter.
- Lubricate the front driveshaft grease fitting and tie rod end links.
- Inspect the exhaust system.
- Inspect the brake hoses.
- Inspect the U—joints and front suspension components.
- Check the automatic transmission fluid level.
- Check the manual transmission fluid level.
- Check the coolant level, hoses, and clamps.
- Lubricate Front Drive Shaft Fitting.

### Schedule "B"

Follow schedule "B" if you usually operate your vehicle under one or more of the following conditions.

- Day or night temperatures are below 32° F (0° C).
- Stop and go driving.
- Extensive engine idling.
- Driving in dusty conditions.
- Short trips of less than 10 miles (16 km).
- More than 50% of your driving is at sustained high speeds during hot weather, above 90° F C (32°).
- Trailer towing.
- Snowplowing.
- Heavy Loading.
- Taxi, police, or delivery service (commercial service).

- Off-road or desert operation.
- **If equipped for and operating with E-85 (ethanol) fuel.**

**NOTE:** If **ANY** of these apply to you then change your engine oil every 3,000 miles (5 000 km) or 3 months, whichever comes first and follow schedule "B" of the "Maintenance Schedules" section of this manual.

**NOTE:** If **ANY** of these apply to you then flush and replace your engine coolant every 102,000 miles (170 000 km) or 60 months, whichever comes first and follow schedule "B" of the "Maintenance Schedules" section of this manual.

If none of these apply to you, then change your engine oil at every interval shown on schedule "A" of the "Maintenance Schedules" section of this manual.

## 450 SCHEDULE "B"

Miles (Kilometers)	3,000 (5 000)	6,000 (10 000)	9,000 (14 000)	12,000 (19 000)	15,000 (24 000)
Change engine oil and engine oil filter, or at 3 months, whichever comes first.	X	X	X	X	X
Lubricate Front Drive Shaft Fitting.	X	X	X	X	X
Rotate tires.		X		X	
Check spare tire for proper pressure and correct stowage.		X		X	
Lubricate tie rod end links.	X	X	X	X	X
Change rear axle fluid.					X
Change front axle fluid.					X
Inspect brake linings.				X	
Inspect engine air cleaner filter, replace if necessary.					X

<b>Miles (Kilometers)</b>	<b>18,000 (29 000)</b>	<b>21,000 (34 000)</b>	<b>24,000 (39 000)</b>	<b>27,000 (43 000)</b>	<b>30,000 (48 000)</b>
Change engine oil and engine oil filter, or at 3 months, whichever comes first.	X	X	X	X	X
Lubricate Front Drive Shaft Fitting.	X	X	X	X	X
Rotate tires.	X		X		X
Check spare tire for proper pressure and correct stowage.	X		X		X
Lubricate tie rod end links.	X	X	X	X	X
Change rear axle fluid.					X
Change front axle fluid.					X
Check transfer case fluid level.					X
Inspect brake linings.			X		
<b>Inspect engine air cleaner filter, replace if necessary.</b>					X
<b>Replace spark plugs.</b>					X
<b>Inspect PCV valve, replace as necessary.**</b>					X

452 SCHEDULE "B"

Miles (Kilometers)	33,000 (53 000)	36,000 (58 000)	39,000 (63 000)	42,000 (68 000)	45,000 (72 000)
Change engine oil and engine oil filter, or at 3 months, whichever comes first.	X	X	X	X	X
Lubricate Front Drive Shaft Fitting.	X	X	X	X	X
Rotate tires.		X		X	
Check spare tire for proper pressure and correct stowage.		X		X	
Lubricate tie rod end links.	X	X	X	X	X
Change rear axle fluid.					X
Change front axle fluid.					X
Inspect brake linings.		X			
Inspect engine air cleaner filter, replace if necessary.					X

<b>Miles (Kilometers)</b>	<b>48,000 (77 000)</b>	<b>51,000 (82 000)</b>	<b>54,000 (87 000)</b>	<b>57,000 (92 000)</b>	<b>60,000 (97 000)</b>
Change engine oil and engine oil filter, or at 3 months, whichever comes first.	X	X	X	X	X
Lubricate Front Drive Shaft Fitting.	X	X	X	X	X
Flush and replace engine coolant at 60 months, or 102, 000 miles (170 000 km) whichever comes first.					X
Rotate tires.	X		X		X
Check spare tire for proper pressure and correct stowage.	X		X		X
Lubricate tie rod end links.	X	X	X	X	X
Drain and refill transfer case fluid.					X
Change rear axle fluid.					X
Change front axle fluid.					X
Change 6-spd manual transmission (G-56) fluid.					X
Inspect brake linings.	X				X
<b>Inspect engine air cleaner filter, replace if necessary.</b>					X

454 SCHEDULE "B"

Miles (Kilometers)	48,000 (77 000)	51,000 (82 000)	54,000 (87 000)	57,000 (92 000)	60,000 (97 000)
Replace spark plugs.					X
Inspect PCV valve, replace as necessary.**					X
Drain and refill automatic transmission fluid and change main sump filter (545RFE only).					X

Miles (Kilometers)	63,000 (101 000)	66,000 (106 000)	69,000 (111 000)	72,000 (116 000)	75,000 (121 000)
Change engine oil and engine oil filter, or at 3 months, whichever comes first.	X	X	X	X	X
Lubricate Front Drive Shaft Fitting.	X	X	X	X	X
Rotate tires.		X		X	
Check spare tire for proper pressure and correct stowage.		X		X	
Lubricate tie rod end links.	X	X	X	X	X
<b>Inspect engine air cleaner filter.</b>					X
Change rear axle fluid.					X
Change front axle fluid.					X
Inspect brake linings.				X	
Inspect auto tension drive belt and replace if required.					X



456 SCHEDULE "B"

Miles (Kilometers)	78,000 (126 000)	81,000 (130 000)	84,000 (135 000)	87,000 (140 000)	90,000 (145 000)
Change engine oil and engine oil filter, or at 3 months, whichever comes first.	X	X	X	X	X
Lubricate Front Drive Shaft Fitting.	X	X	X	X	X
Rotate tires.	X		X		X
Check spare tire for proper pressure and correct storage.	X		X		X
Lubricate tie rod end links.	X	X	X	X	X
Change rear axle fluid.					X
Change front axle fluid.					X
Check transfer case fluid level.					X
Inspect brake linings.			X		
<b>Inspect engine air cleaner filter, replace if necessary.</b>					X
<b>Replace spark plugs.</b>					X
<b>Inspect PCV valve, replace as necessary.**</b>					X
Inspect auto tension drive belt and replace if required.					X

<b>Miles (Kilometers)</b>	<b>93,000 (150 000)</b>	<b>96,000 (154 000)</b>	<b>99,000 (159 000)</b>	<b>102,000 (164 000)</b>
Change engine oil and engine oil filter, or at 3 months, whichever comes first.	X	X	X	X
Lubricate Front Drive Shaft Fitting.	X	X	X	X
Rotate tires.		X		X
Check spare tire for proper pressure and correct stowage.		X		X
Lubricate tie rod end links.	X	X	X	X
Flush and replace engine coolant, if not replaced at 60 months.				X
Inspect brake linings.		X		

458 SCHEDULE "B"

Miles (Kilometers)	105,000 (169 000)	108,000 (174 000)	111,000 (179 000)	114,000 (183 000)	117,000 (188 000)	120,000 (193 000)
Change engine oil and engine oil filter, or at 3 months, whichever comes first.	X	X	X	X	X	X
Lubricate Front Drive Shaft Fitting.	X	X	X	X	X	X
Rotate tires.		X		X		X
Check spare tire for proper pressure and correct stowage.		X		X		X
Lubricate tie rod end links.	X	X	X	X	X	X
Drain and refill transfer case fluid.						X
Change rear axle fluid.	X					X
Change front axle fluid.	X					X
Change 6-spd manual transmission (G-56) fluid.						X
Inspect brake linings.		X				X
<b>Inspect engine air cleaner filter, replace if necessary.</b>	X					X
<b>Replace spark plugs.</b>						X

Miles (Kilometers)	105,000 (169 000)	108,000 (174 000)	111,000 (179 000)	114,000 (183 000)	117,000 (188 000)	120,000 (193 000)
Inspect PCV valve, replace as necessary.**						X
Inspect auto tension drive belt and replace if required.	X					X
Drain and refill automatic transmission fluid and change main sump and spin-on cooler return filter (if equipped) [545RFE only].						X
Flush and replace engine coolant at 120 months, if not replaced at 102,000 miles (170 000 km).						X

\* This applies only if the vehicle is used for frequent trailer towing, snowplowing, fleet vehicle or commercial service.

\*\*This maintenance is recommend, but not required.

Inspection and service should also be performed anytime a malfunction is observed or suspected. Retain all receipts.

## 460 SCHEDULE "A"

## Schedule "A"

Miles (Kilometers) [Months]	6,000 (10 000) [6]	12,000 (19 000) [12]	18,000 (29 000) [18]	24,000 (39 000) [24]	30,000 (48 000) [30]
Change engine oil and engine oil filter.	X	X	X	X	X
Lubricate Front Prop Shaft fitting.	X	X	X	X	X
Rotate tires.	X	X	X	X	X
Check spare tire for proper pressure and correct stowage.	X	X	X	X	X
Check transfer case fluid level.					X
Lubricate tie rod end links.	X	X	X	X	X
Inspect brake linings.			X		
<b>Inspect engine air cleaner filter, replace if necessary.</b>					X
<b>Replace spark plugs.</b>					X

Miles (Kilometers) [Months]	36,000 (58 000) [36]	42,000 (68 000) [42]	48,000 (77 000) [48]	54,000 (87 000) [54]	60,000 (97 00) [60]	66,000 (106 000) [66]
Change engine oil and engine oil filter.	X	X	X	X	X	X
Lubricate Front Prop Shaft fitting.	X	X	X	X	X	X
Rotate tires.	X	X	X	X	X	X
Check spare tire for proper pressure and correct stowage.	X	X	X	X	X	X
Check transfer case fluid level.					X	
Lubricate tie rod end links.	X	X	X	X	X	X
Flush and replace engine coolant at 60 months, if not replaced at 102,000 miles (170 000 km).					X	
Inspect brake linings.	X			X		
<b>Inspect engine air cleaner filter, replace if necessary.</b>					X	
<b>Replace spark plugs.</b>					X	
<b>Inspect PCV valve, replace as necessary.**</b>					X	

## 462 SCHEDULE "A"

Miles (Kilometers) [Months]	72,000 (116 000) [72]	78,000 (126 000) [78]	84,000 (135 000) [84]	90,000 (145 000) [90]	96,000 (154 000) [96]
Change engine oil and engine oil filter.	X	X	X	X	X
Lubricate Front Prop Shaft fitting.	X	X	X	X	X
Rotate tires.	X	X	X	X	X
Check spare tire for proper pressure and correct stowage.	X	X	X	X	X
Lubricate tie rod end links.	X	X	X	X	X
Check transfer case fluid level.				X	
Inspect brake linings.	X			X	
<b>Inspect engine air cleaner filter, replace if necessary.</b>				X	
<b>Replace spark plugs.</b>				X	
<b>Inspect PCV valve, replace as necessary.**</b>				X	
Inspect auto tension drive belt and replace if required.				X	

Miles (Kilometers) [Months]	102,000 (164 000) [102]	108,000 (174 000) [108]	114,000 (183 000) [114]	120,000 (193 000) [120]
Change engine oil and engine oil filter.	X	X	X	X
Lubricate Front Prop Shaft fitting.	X	X	X	X
Rotate tires.	X	X	X	X
Check spare tire for proper pressure and correct stowage.	X	X	X	X
Drain and refill transfer case fluid.				X
Flush and replace engine coolant, if not replaced at 60 months.	X			
Flush and replace engine coolant at 120 months, if not replaced at 102,000 miles (170 000 km).				X
Lubricate tie rod end links.	X	X	X	X
Inspect brake linings.		X		
Inspect auto tension drive belt and replace if required.	X			X
<b>Inspect engine air cleaner filter, replace if necessary.</b>				X



464 SCHEDULE "A"

Miles (Kilometers) [Months]	102,000 (164 000) [102]	108,000 (174 000) [108]	114,000 (183 000) [114]	120,000 (193 000) [120]
Replace spark plugs.				X
Inspect PCV Valve, replace as necessary.**				X

Inspection and service should also be performed anytime a malfunction is observed or suspected. Retain all receipts.

\*\*This maintenance is recommend, but not required.

<b>WARNING!</b>
<p><b>You can be badly injured working on or around a motor vehicle. Do only that service work for which you have the knowledge and the right equipment. If you have any doubt about your ability to perform a service job, take your vehicle to a competent mechanic.</b></p>

# IF YOU NEED CONSUMER ASSISTANCE

## CONTENTS

---

■ Suggestions For Obtaining Service For Your Vehicle . . . . .	466	■ Reporting Safety Defects . . . . .	469
□ Prepare For The Appointment . . . . .	466	□ In Canada . . . . .	469
□ Prepare A List . . . . .	466	■ Publication Order Forms . . . . .	470
□ Be Reasonable With Requests . . . . .	466	■ Department Of Transportation Uniform Tire Quality Grades . . . . .	471
■ If You Need Assistance . . . . .	466	□ Treadwear . . . . .	471
■ Warranty Information (U.S. Vehicles Only) . . . . .	469	□ Traction Grades . . . . .	471
■ Mopar® Parts . . . . .	469	□ Temperature Grades . . . . .	472

## **SUGGESTIONS FOR OBTAINING SERVICE FOR YOUR VEHICLE**

### **Prepare For The Appointment**

If you're having warranty work done, be sure to have the right papers with you. Take your warranty folder. All work to be performed may not be covered by the warranty, discuss additional charges with the service manager. Keep a maintenance log of your vehicle's service history. This can often provide a clue to the current problem.

### **Prepare A List**

Make a written list of your vehicle's problems or the specific work you want done. If you've had an accident, or work done that is not on your maintenance log, let the service advisor know.

### **Be Reasonable With Requests**

If you list a number of items, and you must have your vehicle by the end of the day, discuss the situation with the service advisor and list the items in order of priority. At many dealers you may obtain a rental vehicle at a minimal daily charge. If you need a rental, it is advisable to make these arrangements when you call for an appointment.

## **IF YOU NEED ASSISTANCE**

The manufacturer and its dealers are vitally interested in your satisfaction. We want you to be happy with our products and services.

Warranty service must be done by an authorized Chrysler, Dodge, or Jeep dealer. We strongly recommend that you take your vehicle to your selling dealer. They know you and your vehicle best, and are most concerned that you get prompt and high quality service. The manufacturer's dealers have the facilities, factory-trained

technicians, special tools, and the latest information to assure your vehicle is fixed correctly and in a timely manner.

This is why you should always talk to your dealer's service manager first. Most matters can be resolved with this process.

- If for some reason you are still not satisfied, talk to the general manager or owner of the dealership. They want to know if you need assistance.
- If your dealership is unable to resolve the concern, you may contact the Manufacturer's Customer Center.

Any communication to the Manufacturer's Customer Center should include the following information:

- Owner's name and address
- Owner's telephone number (home and office)
- Dealership name

- Vehicle identification number
- Vehicle delivery date and mileage

***DaimlerChrysler Motors Corporation Customer Center***

P.O. Box 21-8004

Auburn Hills, MI 48321-8004

Phone: (800) 992-1997

***DaimlerChrysler Canada Inc. Customer Center***

P.O. Box 1621

Windsor, Ontario N9A 4H6

Phone —(800) 465-2001

***In Mexico contact:***

Av. Prolongacion Paseo de la Reforma, 1240

Sante Fe C.P. 05109

Mexico, D. F.

In Mexico (915) 729-1248 or 729-1240

Outside Mexico (525) 729-1248 or 729-1240

***Customer Assistance For The Hearing Or Speech Impaired (TDD/TTY)***

To assist customers who have hearing difficulties, the manufacturer has installed special TDD (Telecommunication Devices for the Deaf) equipment at its Customer Center. Any hearing or speech impaired customer who has access to a TDD or a conventional teletypewriter (TTY) in the United States can communicate with the manufacturer by dialing 1-800-380-CHRY.

***Service Contract***

You may have purchased a service contract for your vehicle to help protect you from the high cost of unexpected repairs after your manufacturer's new vehicle limited warranty expires. The manufacturer stands behind only the manufacturer's Service Contracts. If you purchased a manufacturer's Service Contract, you will receive Plan Provisions and an Owner Identification Card in the mail within three weeks of your vehicle delivery date. If you have any questions about your service

contract, call the manufacturer's Service Contract National Customer Hotline at 1-800-521-9922.

The manufacturer will not stand behind any service contract that is not the manufacturer's Service Contract. It is not responsible for any service contract other than the manufacturer's Service Contract. If you purchased a service contract that is not a manufacturer's Service Contract, and you require service after your manufacturer's new vehicle limited warranty expires, please refer to your contract documents, and contact the person listed in those documents.

We appreciate that you have made a major investment when you purchased your new vehicle. Your dealer has also made a major investment in facilities, tools, and training to assure that you are absolutely delighted with your ownership experience. You'll be pleased with their sincere efforts to resolve any warranty issues or related concerns.

**WARRANTY INFORMATION (U.S. Vehicles Only)**

See the Warranty Information Booklet for the terms and provisions of DaimlerChrysler's warranties applicable to this vehicle.

**MOPAR® PARTS**

Mopar® fluids, lubricants, parts, and accessories are available from your dealer. They will help you keep your vehicle operating at its best.

**REPORTING SAFETY DEFECTS**

In the 50 United States and Washington D.C.: If you believe that your vehicle has a defect, which could cause a crash or cause injury or death, you should immediately inform the National Highway Traffic Safety Administration (NHTSA) in addition to notifying the manufacturer.

If NHTSA receives similar complaints, it may open an investigation, and if it finds that a safety defect exists in a group of vehicles, it may order a recall and remedy

campaign. However, NHTSA cannot become involved in individual problems between you, your dealer, and the manufacturer.

To contact NHTSA, you may either call the Auto Safety Hotline toll free at 1-888-327-4236 (TTY: 1-800-424-9153), or go to <http://www.NHTSA.gov> or write to: NHTSA, U.S. Dept. of Transportation, Washington DC 20590. You can also obtain other information about motor vehicle safety from the Hotline.

**In Canada:**

If you believe that your vehicle has a safety defect, you should contact the Customer Service Department immediately. Canadian customers who wish to report a safety defect to the Canadian government should write to Transport Canada, Motor Vehicle Defect Investigations and Recalls, 2780 Sheffield Road, Ottawa, Ontario K1B 3V9.

## PUBLICATION ORDER FORMS

To order the following manuals, you may use either the website or the phone numbers listed below. Visa, Mastercard, American Express, and Discover orders are accepted. If you prefer mailing your payment, please call for an order form.

**NOTE:** A street address is required when ordering manuals. (No P.O. Boxes).

- *Service Manuals.*

These comprehensive service manuals provide the information that students and professional technicians need in diagnosing/troubleshooting, problem solving, maintaining, servicing, and repairing DaimlerChrysler Corporation vehicles. A complete working knowledge of the vehicle, system, and/or components is written in straightforward language with illustrations, diagrams, and charts.

- *Diagnostic Procedure Manuals.*

Filled with diagrams, charts and detailed illustrations, these practical manuals make it easy for students and technicians to find and fix problems on computer-controlled vehicle systems and features. They show exactly how to find and correct problems the first time, using step-by-step troubleshooting and driveability procedures, proven diagnostic tests and a complete list of all tools and equipment.

- *Owner's Manuals.*

These manuals have been prepared with the assistance of service and engineering specialists to acquaint you with specific Chrysler group vehicles. Included are starting, operating, emergency and maintenance procedures as well as specifications, capabilities and safety tips.

**Call Toll Free at:**

- 1-800-890-4038 (U.S.)
- 1-800-387-1143 (Canada)

Or

**Visit us on the World Wide Web at:**

- [www.techauthority.daimlerchrysler.com](http://www.techauthority.daimlerchrysler.com)
- [www.daimlerchrysler.ca/manuals](http://www.daimlerchrysler.ca/manuals)

## DEPARTMENT OF TRANSPORTATION UNIFORM TIRE QUALITY GRADES

The following describes the tire grading categories established by the National Highway Traffic Safety Administration. The specific grade rating assigned by the tire's manufacturer in each category is shown on the sidewall of the tires on your car.

All Passenger Car Tires Must Conform to Federal Safety Requirements in Addition to These Grades.

### Treadwear

The treadwear grade is a comparative rating based on the wear rate of the tire when tested under controlled conditions on a specified government test course. For example, a tire graded 150 would wear one and a half (1 1/2) times as well on the government course as a tire graded 100. The relative performance of tires depends upon the actual conditions of their use, however, and may depart significantly from the norm due to variations in driving habits, service practices and differences in road characteristics and climate.

### Traction Grades

The traction grades, from highest to lowest, are AA, A, B, and C. Those grades represent the tire's ability to stop on wet pavement as measured under controlled conditions



on specified government test surfaces of asphalt and concrete. A tire marked C may have poor traction performance.

**WARNING!**

**The traction grade assigned to this tire is based on straight-ahead braking traction tests, and does not include acceleration, cornering, hydroplaning, or peak traction characteristics.**

**Temperature Grades**

The temperature grades are A (the highest), B, and C, representing the tire's resistance to the generation of heat and its ability to dissipate heat when tested under controlled conditions on a specified indoor laboratory test wheel. Sustained high temperature can cause the material of the tire to degenerate and reduce tire life, and excessive temperature can lead to sudden tire failure. The

grade C corresponds to a level of performance which all passenger car tires must meet under the Federal Motor Vehicle Safety Standard No. 109. Grades B and A represent higher levels of performance on the laboratory test wheel than the minimum required by law.

**WARNING!**

**The temperature grade for this tire is established for a tire that is properly inflated and not overloaded. Excessive speed, under inflation, or excessive loading, either separately or in combination, can cause heat buildup and possible tire failure.**

---

# INDEX

- Adding Fuel . . . . . 339
- Air Cleaner, Engine (Engine Air Cleaner Filter) . 393,417
- Air Conditioner Maintenance . . . . . 397
- Air Conditioning Refrigerant . . . . . 397,398
- Air Conditioning System . . . . . 230,397
- Air Conditioning System, Zone Control . . . . . 233
- Air Pressure, Tires . . . . . 323,332
- Airbag . . . . . 45,51
- Airbag Light . . . . . 164,174
- Airbag On/Off Switch . . . . . 51
- Airbag, Side . . . . . 54
- Alarm (Security Alarm) . . . . . 18,176
- Alarm System (Security Alarm) . . . . . 18
- Alignment and Balance . . . . . 331
- Alterations/Modifications, Vehicle . . . . . 7
- Antenna, Satellite Radio . . . . . 223
- Antifreeze (Engine Coolant) . . . . . 404,405,441
- Disposal . . . . . 406
- Anti-Lock Warning Light . . . . . 178,310
- Anti-Theft Security Alarm (Theft Alarm) . . . . . 18
- Anti-Theft System . . . . . 18,176
- Appearance Care . . . . . 420
- Ashtray . . . . . 150
- Automatic Dimming Mirror . . . . . 84
- Automatic Transaxle . . . . . 13
- Interlock System . . . . . 16
- Automatic Transmission
- Adding Fluid . . . . . 413
- Fluid and Filter Changes . . . . . 415
- Fluid Level Check . . . . . 412,413
- Fluid Type . . . . . 414,443
- Shift Indicator . . . . . 176
- Shifting . . . . . 250
- Special Additives . . . . . 415
- Axle Fluid . . . . . 411,443
- Axle Lubrication (Axle Fluid) . . . . . 411
- Ball Joints . . . . . 399

Bar, Stabilizer/Sway System . . . . .	267	Bulbs, Light . . . . .	430
Battery . . . . .	396	Cab Top Clearance Lights . . . . .	438
Emergency Starting . . . . .	375	Calibration, Compass . . . . .	136
Saving Feature (Protection) . . . . .	120	Camper . . . . .	160
Bearings . . . . .	415	Capacities, Fluid . . . . .	441
Belts, Drive . . . . .	393	Caps, Filler	
Belts, Seat . . . . .	34	Oil (Engine) . . . . .	391
Body Mechanism Lubrication . . . . .	401	Power Steering . . . . .	398
B-Pillar Location . . . . .	318	Radiator (Coolant Pressure) . . . . .	406
Brake Fluid . . . . .	443	Car Washes . . . . .	421
Brake System . . . . .	309,409	Carbon Monoxide Warning . . . . .	163,339
Anti-Lock (ABS) . . . . .	310	Cargo Light . . . . .	122
Disc Brakes . . . . .	409	Cassette Tape and Player Maintenance . . . . .	225
Hoses . . . . .	410	Catalytic Converter . . . . .	394
Master Cylinder . . . . .	409	CD (Compact Disc) Player . . . . .	183,191,204
Parking . . . . .	308	Cellular Phone . . . . .	87
Warning Light . . . . .	178	Center High Mounted Stop Light . . . . .	437
Break-In Recommendations, New Vehicle . . . . .	70	Center Lap Belts . . . . .	42
Bulb Replacement . . . . .	431		

Center Seat Storage Compartment . . . . .	152	Computer, Trip/Travel . . . . .	132
Certification Label . . . . .	341	Console, Overhead . . . . .	131
Chart, Tire Sizing . . . . .	315	Contract, Service . . . . .	468
Check Engine Light (Malfunction Indicator Light) . . . . .	177	Coolant Pressure Cap (Radiator Cap) . . . . .	406
Child Restraint . . . . .	58,59	Cooling System . . . . .	403
Child Restraint Tether Anchors . . . . .	62,66	Adding Coolant (Antifreeze) . . . . .	405
Child Seat . . . . .	59,65	Coolant Capacity . . . . .	441
Cigar Lighter . . . . .	150	Coolant Level . . . . .	403,407
Cleaning		Disposal of Used Coolant . . . . .	406
Wheels . . . . .	422	Drain, Flush, and Refill . . . . .	404
Climate Control . . . . .	227	Inspection . . . . .	407
Clock . . . . .	181,185,193,206,219	Points to Remember . . . . .	407
Clutch . . . . .	410	Pressure Cap . . . . .	406
Clutch Linkage Maintenance . . . . .	410	Radiator Cap . . . . .	406
Compact Disc (CD) Maintenance . . . . .	226	Selection of Coolant (Antifreeze) . . . . .	404,441,442
Compact Spare Tire . . . . .	327	Temperature Gauge . . . . .	175
Compass . . . . .	136	Cruise Control (Speed Control) . . . . .	128
Compass Calibration . . . . .	136	Cup Holder . . . . .	151
Compass Variance . . . . .	137	Customer Assistance . . . . .	466

Data Recorder, Event . . . . .	56	Driving	
Daytime Running Lights . . . . .	121	Off-Pavement . . . . .	268
Dealer Service . . . . .	388	Off-Road . . . . .	268
Defroster, Rear Window . . . . .	86,154	Electric Rear Window Defrost . . . . .	86,154
Defroster, Windshield . . . . .	163,229,232	Electrical Power Outlets . . . . .	148
Delay (Intermittent) Wipers . . . . .	125	Electronic Speed Control (Cruise Control) . . . . .	128
Differential . . . . .	78	Emergency Brake . . . . .	308
Differential, Limited-Slip . . . . .	262	Emergency, In Case of	
Digital Video Disc (DVD) Player . . . . .	78	Freeing Vehicle When Stuck . . . . .	378
Dipsticks		Hazard Warning Flasher . . . . .	366
Automatic Transmission . . . . .	413	Jacking . . . . .	369
Power Steering . . . . .	398	Jump Starting . . . . .	375
Disc Brakes . . . . .	409	Tow Hooks . . . . .	379
Disposal		Towing . . . . .	380
Antifreeze (Engine Coolant) . . . . .	406	Emission Control System Maintenance . . . . .	446
Door Ajar . . . . .	181	Emission Related Components . . . . .	396
Door Locks . . . . .	26	Engine . . . . .	384
Door Opener, Garage . . . . .	139	Air Cleaner . . . . .	393
Drive Belts . . . . .	393		

Block Heater	249	Filters	
Break-In Recommendations	70	Air Cleaner	393,417
Compartment Identification	384	Engine Fuel	394
Coolant (Antifreeze)	442	Engine Oil	392,442
Exhaust Gas Caution	339	Engine Oil Disposal	392
Flooded, Starting	246	Flashers	
Fuel Requirements	441	Turn Signal	123
Oil	389,441,442	Flat Tire Stowage	368,374
Oil Filler Cap	391	Flooded Engine Starting	246
Oil Selection	391,441	Fluid, Brake	443
Oil Synthetic	392	Fluid Capacities	441
Temperature Gauge	175	Fluid Level Checks	
Equipment Identification Plate	363	Automatic Transmission	413
Event Data Recorder	56	Power Steering	398
Exhaust Gas Caution	163,339,403	Fluids, Lubricants and Genuine Parts	442
Exhaust System	163,402,403	Fog Lights	122,179,440
Exterior Lighting	120	Fold Flat Load Floor	155
		Four Wheel Drive	258
Fabric Care	423	Four-Way Hazard Flasher	366

Freeing A Stuck Vehicle . . . . .	378	Oil Pressure . . . . .	174
Front Axle (Differential) . . . . .	411	Speedometer . . . . .	174
Front Wheel Bearings . . . . .	415	Tachometer . . . . .	173
Fuel . . . . .	335	Voltmeter . . . . .	173
Adding . . . . .	339	Gear Ranges . . . . .	250,257
Filter . . . . .	394	Gear Ratios . . . . .	78
Gauge . . . . .	180	General Information . . . . .	18
Octane Rating . . . . .	335,442	Glass Cleaning . . . . .	424
Requirements . . . . .	335,441	Gross Axle Weight Rating . . . . .	346
Tank Capacity . . . . .	441	Gross Vehicle Weight Rating . . . . .	345
Fuses . . . . .	425	GVWR . . . . .	342
Garage Door Opener (HomeLink®) . . . . .	139	Hands-Free Phone (UConnect™) . . . . .	87
Gas Cap (Fuel Filler Cap) . . . . .	341,385	Hazard Warning Flasher . . . . .	366
Gasoline (Fuel) . . . . .	335	Head Restraints . . . . .	112
Gasoline, Reformulated . . . . .	335	Headlights . . . . .	431
Gauges . . . . .	173	High Beam . . . . .	124
Coolant Temperature . . . . .	175	High Beam/Low Beam Select Switch . . . . .	124
Fuel . . . . .	180	Lights On Reminder . . . . .	122



- Passing ..... 124  
Switch ..... 120  
Heated Mirrors ..... 86,154  
Heated Seats ..... 115  
Heater ..... 230  
Heater, Engine Block ..... 249  
High Beam/Low Beam Select (Dimmer) Switch .. 124  
Hitches  
Trailer Towing ..... 349  
Hoisting ..... 375  
HomeLink® (Garage Door Opener) Transmitter .. 139  
Hood Release ..... 117  
Hoses ..... 408  
Hub Caps ..... 373  
Ignition ..... 13  
Cables (Spark Plug Wires) ..... 393  
Key ..... 12,13  
Wiring System (Spark Plug Wires) ..... 393  
Ignition Key Removal ..... 13  
Illuminated Entry ..... 20  
Infant Restraint ..... 58,59  
Inflation Pressure Tires ..... 332  
Inside Rearview Mirror ..... 83  
Instrument Cluster ..... 172,173  
Instrument Panel and Controls ..... 171  
Instrument Panel Lens Cleaning ..... 424  
Integrated Power Module (Fuses) ..... 425  
Interior Appearance Care ..... 423  
Interior Lights ..... 119  
Intermittent Wipers (Delay Wipers) ..... 125  
Introduction ..... 4  
Jack Location ..... 367  
Jack Operation ..... 369  
Jump Starting ..... 375  
Key, Replacement ..... 17

Key, Sentry (Immobilizer) . . . . .	16	Cruise . . . . .	181
Keyless Entry System . . . . .	20	Daytime Running . . . . .	121
Keys . . . . .	12	Fog . . . . .	122,179,440
Lane Change and Turn Signals . . . . .	123	Four-Wheel Drive Indicator . . . . .	262
Lap Belts . . . . .	42	Hazard Warning Flasher . . . . .	366
Lap/Shoulder Belts . . . . .	34	Headlights . . . . .	120
LATCH (Lower Anchors and Tether for CHildren) . . . . .	62	High Beam . . . . .	124,174
Life of Tires . . . . .	330	High Beam Indicator . . . . .	174
Lights . . . . .	118,164	High Beam/Low Beam Select . . . . .	124
Airbag . . . . .	56,174	Illuminated Entry . . . . .	20
Anti-Lock Warning . . . . .	178,310	Instrument Cluster . . . . .	173
Brake Warning . . . . .	178	Intensity Control . . . . .	119
Bulb Replacement . . . . .	430,431	Interior . . . . .	119,132
Cap Top Clearance . . . . .	438	Lights On Reminder . . . . .	122
Cargo . . . . .	122	Passing . . . . .	124
Center Mounted Stop . . . . .	437	Seat Belt Reminder . . . . .	174
Check Engine (Malfunction Indicator) . . . . .	177	Service . . . . .	430,431
Courtesy/Reading . . . . .	132	Transfer Case . . . . .	262
		Transmission Warning . . . . .	180

Turn Signal . . . . .	123,173,431,434	Maintenance Procedures . . . . .	388
Warning (Instrument Cluster Description) . . . . .	173	Maintenance Schedule . . . . .	446
Limited-Slip Differential . . . . .	262,411	Schedule "A" . . . . .	460
Loading Vehicle . . . . .	341	Schedule "B" . . . . .	449
Tires . . . . .	318	Malfunction Indicator Light (Check Engine) . . . . .	386
Locks . . . . .	26	Manual, Service . . . . .	470
Child Protection . . . . .	29	Manual Transmission . . . . .	255,412
Door . . . . .	26	Fluid Level Check . . . . .	412
Keys . . . . .	12	Lubricant Selection . . . . .	412,443
Power Door . . . . .	26	Shift Speeds . . . . .	257
Steering Wheel . . . . .	15	Mirrors . . . . .	83
Lower Anchors and Tether for Children (LATCH) . . . . .	62	Automatic Dimming . . . . .	84
Lubricants . . . . .	416	Electric Powered . . . . .	85
Lubrication, Body . . . . .	401	Outside . . . . .	84
Lug Nuts . . . . .	372	Rearview . . . . .	83
Lumbar Support . . . . .	113	Trailer Towing . . . . .	86,358
Maintenance . . . . .	388	Modifications/Alterations, Vehicle . . . . .	7
Maintenance Free Battery . . . . .	396	Mopar Parts . . . . .	387,469
		Multi-Displacement Engine System . . . . .	313

Multi-Function Control Lever . . . . .	123	Disposal . . . . .	392
Navigation Radio . . . . .	219	Filter . . . . .	392,442
Navigation System . . . . .	219	Filter Disposal . . . . .	392
Noise Control		Identification Logo . . . . .	391
Maintenance . . . . .	416	Materials Added to . . . . .	392
Tampering Prohibited . . . . .	417,418	Pressure Gauge . . . . .	174
Noise Emission Warranty . . . . .	418	Recommendation . . . . .	391,441
		Synthetic . . . . .	392
Occupant Restraints . . . . .	33	Viscosity . . . . .	391,441
Octane Rating, Gasoline (Fuel) . . . . .	335	Onboard Diagnostic System . . . . .	385,386
Odometer . . . . .	176,180	Opener, Garage Door (HomeLink®) . . . . .	139
Trip . . . . .	176,180	Operating Precautions . . . . .	385
Off-Pavement Driving (Off-Road) . . . . .	268	Outside Rearview Mirrors . . . . .	84
Off-Road Driving (Off-Pavement) . . . . .	268	Overdrive . . . . .	252
Oil, Engine . . . . .	389,442	Overdrive OFF Switch . . . . .	252
Capacity . . . . .	441	Overhead Console . . . . .	131,132
Change Interval . . . . .	390	Overhead Travel Information Center . . . . .	132
Dipstick . . . . .	389	Owner's Manual (Operator Manual) . . . . .	470

- Parking Brake . . . . . 308
- Passenger Airbag On/Off Switch . . . . . 51
- Passing Light . . . . . 124
- Phone, Cellular . . . . . 87
- Phone, Hands-Free (UConnect™) . . . . . 87
- Pickup Box . . . . . 159
- Placard, Tire and Loading Information . . . . . 318
- Positive Crankcase Valve . . . . . 396
- Power
- Distribution Center (Fuses) . . . . . 425
  - Door Locks . . . . . 26
  - Mirrors . . . . . 85
  - Outlet (Auxiliary Electrical Outlet) . . . . . 148
  - Seats . . . . . 114
  - Sliding Rear Window . . . . . 154
  - Steering . . . . . 312,398
  - Sunroof . . . . . 145
  - Windows . . . . . 31
- Power Steering Fluid . . . . . 443
- Power Wagon Features . . . . . 78
- Pregnant Women and Seat Belts . . . . . 45
- Pretensioners
- Seat Belts . . . . . 43
- Programmable Electronic Features . . . . . 141,144
- Programming Transmitters  
(Remote Keyless Entry) . . . . . 141,144
- Radial Ply Tires . . . . . 326
- Radiator Cap (Coolant Pressure Cap) . . . . . 404,406
- Radio Broadcast Signals . . . . . 182
- Radio, Navigation . . . . . 219
- Radio Operation . . . . . 183,191,204
- Radio Remote Controls . . . . . 224
- Radio, Satellite . . . . . 219,220
- Radio (Sound Systems) . . . . . 183,191,204
- Ramp Travel Index . . . . . 269
- Rear Axle (Differential) . . . . . 411
- Rear Wheel Bearings . . . . . 415

Rear Window Features . . . . .	154	Safety Checks Inside Vehicle . . . . .	163
Rear Window, Sliding . . . . .	155	Safety Checks Outside Vehicle . . . . .	164
Reclining Front Seats . . . . .	112	Safety Defects, Reporting . . . . .	469
Recorder, Event Data . . . . .	56	Safety Information, Tire . . . . .	313
Recreational Towing . . . . .	360	Safety Tips . . . . .	162
Shifting into Transfer Case Neutral (N) . . . . .	361	Satellite Radio . . . . .	219,220
Shifting out of Transfer Case Neutral (N) . . . . .	362	Satellite Radio Antenna . . . . .	223
Reformulated Gasoline . . . . .	335	Schedule, Maintenance . . . . .	446
Refrigerant . . . . .	398	Seat Belt Maintenance . . . . .	424
Reminder, Seat Belt . . . . .	43	Seat Belt Reminder . . . . .	43
Remote Keyless Entry (RKE) . . . . .	20	Seat Belts . . . . .	33,34,164
Remote Sound System (Radio) Controls . . . . .	224	Adjustable Upper Shoulder Anchorage . . . . .	41
Remote Starting System . . . . .	24	And Pregnant Women . . . . .	45
Replacement Tires . . . . .	330	Child Restraint . . . . .	58,70
Reporting Safety Defects . . . . .	469	Extender . . . . .	45
Restraint, Head . . . . .	112	Front Seat . . . . .	34
Restraints, Child . . . . .	58,65	Pretensioners . . . . .	43
Ride Height . . . . .	79	Reminder . . . . .	174
Rotation, Tires . . . . .	334	Seats . . . . .	110,111

Adjustment	110	Transfer Case, Shifting into Transfer Case Neutral (N)	361
Child	70	Transfer Case, Shifting out of Transfer Case Neutral (N)	362
Cleaning	423	Shoulder Belt Upper Anchorage	41
Folding Floor	155	Shoulder Belts	34
Heated	115	Side Airbag	54
Lumbar Support	113	Signals, Turn	123
Power	114	Skid Plates	80
Reclining	112	Sliding Rear Window	
Security Alarm (Theft Alarm)	18,176	Power	154
Selection of Coolant (Antifreeze)	404,442	Slippery Surfaces, Driving On	263
Sentry Key (Immobilizer)	16	Snow Chains (Tire Chains)	332
Service Assistance	466	Snow Plow	359
Service Contract	468	Snow Tires	333
Service Manuals	470	Spare Tire	327,328
Setting the Clock	181,185,193,206,219	Spark Plug Wires (Ignition Cables/Wires)	393
Shifting	249	Spark Plugs	393
Automatic Transmission	250	Speed Control (Cruise Control)	128
Manual Transmission	255		
Transfer Case	261		

Speedometer . . . . .	174	Storage, Vehicle . . . . .	430
Springs . . . . .	80	Storing Your Vehicle . . . . .	430
Stabilizer Bars, Electronic Disconnecting . . . . .	79	Sun Roof . . . . .	145
Stabilizer/Sway Bar System . . . . .	267	Supplemental Tire Pressure Information . . . . .	332
Starting . . . . .	245	Synthetic Engine Oil . . . . .	392
Automatic Transmission . . . . .	245	System, Navigation . . . . .	219
Engine Fails to Start . . . . .	246	System, Remote Starting . . . . .	24
Manual Transmission . . . . .	245		
Remote . . . . .	24	Tachometer . . . . .	173
Starting Procedures (Gas Engines) . . . . .	245	Tailgate . . . . .	160
Steering		Tether Anchor, Child Restraint . . . . .	62,66
Linkage . . . . .	400	Tilt Steering Column . . . . .	127
Power . . . . .	312,398	Tip Start . . . . .	246
Wheel Lock . . . . .	15	Tire and Loading Information Placard . . . . .	318,332
Wheel, Tilt . . . . .	127	Tire Identification Number (TIN) . . . . .	317
Steering Wheel Mounted Sound System		Tire Markings . . . . .	313
Controls . . . . .	224	Tire Safety Information . . . . .	313
Storage, Behind the Seat . . . . .	152	Tires . . . . .	80,164,322,471
Storage Compartment, Center Seat . . . . .	152	Aging (Life of Tires) . . . . .	330



Air Pressure . . . . .	322	Spare Tire . . . . .	368
Alignment . . . . .	331	Spinning . . . . .	328
Chains . . . . .	332	Tread Wear Indicators . . . . .	329
Changing . . . . .	368	Wheel Mounting . . . . .	369
Compact Spare . . . . .	327	Wheel Nut Torque . . . . .	372
General Information . . . . .	322	Tongue Weight/Trailer Weight . . . . .	350
High Speed . . . . .	325	Torque Converter Clutch . . . . .	255
Inflation Pressures . . . . .	323	Tow Hooks, Emergency . . . . .	379
Jacking . . . . .	369	Towing . . . . .	345
Life of Tires . . . . .	330	Disabled Vehicle . . . . .	380
Load Capacity . . . . .	318,319	Guide . . . . .	350
Off-Road . . . . .	80	Recreational . . . . .	360
Quality Grading . . . . .	471	Weight . . . . .	350
Radial . . . . .	326	Traction . . . . .	263
Replacement . . . . .	330	Trailer Towing . . . . .	345
Rotation . . . . .	334	Cooling System Tips . . . . .	357
Safety . . . . .	313,322	Hitches . . . . .	349
Sizes . . . . .	315	Minimum Requirements . . . . .	351
Snow Tires . . . . .	333	Mirrors . . . . .	86,358

Trailer and Tongue Weight . . . . .	350	Turn Signals . . . . .	123,173,431,434
Wiring . . . . .	355	UConnect™ (Hands-Free Phone) . . . . .	87
Trailer Towing Guide . . . . .	350	Underhood Fuses . . . . .	425
Trailer Weight . . . . .	350	Uniform Tire Quality Grades . . . . .	471
Transaxle		Universal Transmitter . . . . .	139
Automatic . . . . .	13	Variance, Compass . . . . .	137
Manual . . . . .	14	Vehicle Identification Number (VIN) . . . . .	6
Transfer Case . . . . .	412	Vehicle Loading . . . . .	319,341
Fluid . . . . .	443	Vehicle Modifications/Alterations . . . . .	7
Transmission		Vehicle Storage . . . . .	430
Automatic . . . . .	250,412	Voltmeter . . . . .	173
Fluid . . . . .	443	Warning Lights (Instrument Cluster Description) . . . . .	173
Maintenance . . . . .	412	Warnings and Cautions . . . . .	6
Manual . . . . .	245,255,412	Warranty Information . . . . .	469
Shifting . . . . .	249	Washers, Windshield . . . . .	126,401
Transmitter, Garage Door Opener (HomeLink®) . . . . .	139	Washing Vehicle . . . . .	421
Tread Wear Indicators . . . . .	329		
Trip Computer . . . . .	132		
Trip Odometer . . . . .	176,180		

- Wheel Alignment and Balance . . . . . 331
- Wheel and Wheel Trim . . . . . 422
- Wheel and Wheel Trim Care . . . . . 422
- Wheel Changing . . . . . 368
- Wheel Flares . . . . . 80
- Wheel Mounting . . . . . 369
- Wheel Nut Torque . . . . . 372,374
- Wheels . . . . . 81
- Winch . . . . . 79,289
- Accessories . . . . . 293
- Operation . . . . . 294
- Rigging Techniques . . . . . 305
- Usage . . . . . 289
- Wind Buffeting . . . . . 32,148
- Window Airbag (Side Curtain) . . . . . 54
- Window Fogging . . . . . 238
- Windows . . . . . 31
- Power . . . . . 31
- Rear Sliding . . . . . 155
- Windshield Defroster . . . . . 229,232
- Windshield Washers . . . . . 125,126,401
- Fluid . . . . . 125,401
- Windshield Wiper Blades . . . . . 401
- Windshield Wipers . . . . . 125
- Wiper Blade Replacement . . . . . 401
- Wipers, Intermittent . . . . . 125
- Wiring, Ignition (Spark Plug Wires) . . . . . 393
- YES Essentials® Fabric Cleaning Procedure . . . . . 423



**Stick with the Specialists™**

DaimlerChrysler Corporation

81-326-0724



First Edition

Printed in U.S.A.