

TABLE OF CONTENTS

SECTION		PAGE
1	INTRODUCTION	3
2	THINGS TO KNOW BEFORE STARTING YOUR VEHICLE	9
3	UNDERSTANDING THE FEATURES OF YOUR VEHICLE	67
4	UNDERSTANDING YOUR INSTRUMENT PANEL	131
5	STARTING AND OPERATING	159
6	WHAT TO DO IN EMERGENCIES	223
7	MAINTAINING YOUR VEHICLE	243
8	MAINTENANCE SCHEDULES	293
9	IF YOU NEED CONSUMER ASSISTANCE	313
10	INDEX	323

INTRODUCTION

CONTENTS

■ Introduction	4	■ Van Conversions/Campers	5
■ How To Use This Manual	5	■ Vehicle Identification Number	6
■ Warnings And Cautions	5	■ Vehicle Modifications / Alterations	7

4 INTRODUCTION

INTRODUCTION

This manual has been prepared with the assistance of service and engineering specialists to acquaint you with the operation and maintenance of your new vehicle. It is supplemented by a Warranty Information Booklet and various customer oriented documents. You are urged to read these publications carefully. Following the instructions and recommendations in this manual will help assure safe and enjoyable operation of your vehicle.

NOTE: After you read the manual, it should be stored in the vehicle for convenient reference and remain with the vehicle when sold, so that the new owner will be aware of all safety warnings.

When it comes to service, remember that your dealer knows your vehicle best, has the factory-trained technicians and genuine Mopar® parts, and is interested in your satisfaction.

WARNING!

Engine exhaust, some of its constituents, and certain vehicle components contain or emit chemicals known to the State of California to cause cancer and birth defects or other reproductive harm. In addition, certain fluids contained in vehicles and certain products of component wear contain or emit chemicals known to the State of California to cause cancer and birth defects or other reproductive harm.

HOW TO USE THIS MANUAL

Consult the table of contents to determine which section contains the information you desire.

The detailed index, at the rear of this manual, contains a complete listing of all subjects.

WARNINGS AND CAUTIONS

This manual contains **WARNINGS** against operating procedures which could result in an accident or bodily injury. It also contains **CAUTIONS** against procedures which could result in damage to your vehicle. If you do not read this entire manual you may miss important information. Observe all Warnings and Cautions.

VAN CONVERSIONS/CAMPERS

The Manufacturer's Warranty does not apply to body modifications or special equipment installed by van conversion/camper manufacturers/ body builders. See the Warranty information book, Section 2.1.C. Such equipment includes video monitors, VCRs, heaters, stoves, refrigerators, etc. For warranty coverage and service on these items, contact the applicable manufacturer.

Operating instructions for the special equipment installed by the conversion/camper manufacturer should also be supplied with your vehicle. If these instructions are missing, please contact your selling dealer for assistance in obtaining replacement documents from the applicable manufacturer.

VEHICLE IDENTIFICATION NUMBER

The vehicle identification number (VIN) is found on a stamped plate located on the left front corner of the instrument panel pad, visible from outside of the vehicle through the windshield. This number also appears on the Automobile Information Disclosure Label affixed to a window on your vehicle. Save this label for a convenient record of your vehicle identification number and optional equipment.

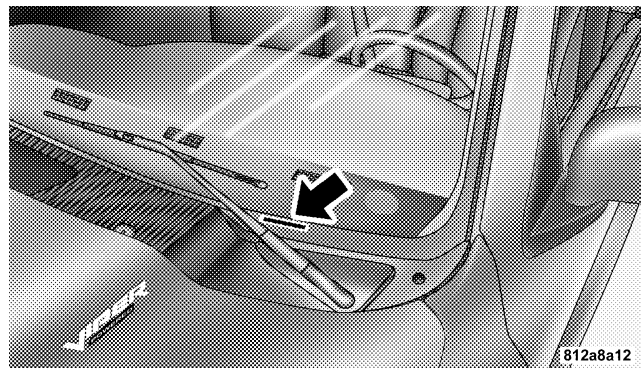

NOTE: It is illegal to remove the VIN plate.

VEHICLE MODIFICATIONS / ALTERATIONS**WARNING!**

Any modifications or alterations to this vehicle could seriously affect its roadworthiness and safety and may lead to an accident resulting in serious injury or death.

THINGS TO KNOW BEFORE STARTING YOUR VEHICLE

CONTENTS

■ A Word About Your Keys11	□ To Unlock The Doors18
□ Key-In-Ignition Reminder11	□ To Lock The Doors19
□ Sentry Key — If Equipped11	□ Using The Panic Alarm21
■ Ignition And Steering Lock — If Equipped14	□ Programming Additional Transmitters21
□ Manual Transmissions14	□ General Information23
■ Door Key14	□ Transmitter Battery Service23
■ Door Locks14	■ Security Alarm System — If Equipped24
□ Power Door Locks14	□ Rearming Of The System24
■ Remote Keyless Entry — If Equipped17	□ To Set The Alarm25

10 THINGS TO KNOW BEFORE STARTING YOUR VEHICLE

<input type="checkbox"/> To Disarm The System	25	<input type="checkbox"/> Seat Belts And Pregnant Women	40
■ Windows	26	<input type="checkbox"/> Seat Belt Extender	40
<input type="checkbox"/> Power Windows—If Equipped	26	<input type="checkbox"/> Driver And Right Front Passenger Supplemental Restraint System (SRS)—Airbag	40
<input type="checkbox"/> Sliding Rear Window	27	<input type="checkbox"/> Child Restraint	51
<input type="checkbox"/> Wind Buffeting	27	■ Engine Break-In Recommendations	62
■ Occupant Restraints	28	■ Safety Tips	63
<input type="checkbox"/> Lap/Shoulder Belts	29	<input type="checkbox"/> Transporting Passengers	63
<input type="checkbox"/> Adjustable Upper Shoulder Belt Anchorage	36	<input type="checkbox"/> Lock Your Vehicle	63
<input type="checkbox"/> Automatic Locking Mode (If Equipped)	37	<input type="checkbox"/> Exhaust Gas	64
<input type="checkbox"/> Center Lap Belts	37	<input type="checkbox"/> Safety Checks You Should Make Inside The Vehicle	65
<input type="checkbox"/> Seat Belt Pretensioners	38	<input type="checkbox"/> Safety Checks You Should Make Outside The Vehicle	66
<input type="checkbox"/> Enhanced Driver Seat Belt Reminder System (BeltAlert)	38		

A WORD ABOUT YOUR KEYS

The double sided keys may be inserted into the locks with either side up. The keys for your new vehicle are enclosed in a plastic bag with a bar code label affixed to the front. The bar code can be used to order duplicate keys from your dealer or a locksmith. If you received your keys without the bag, ask your dealer to give you the number.

Key-In-Ignition Reminder

If you open the driver's door when the key is in the ignition switch, a chime will sound to remind you to remove the key.

CAUTION!

An unlocked vehicle is an invitation to thieves. Always remove the key from the ignition and lock all the doors when leaving the vehicle unattended.

2**SENTRY KEY — IF EQUIPPED**

With this system, an electronically coded ignition key sends a signal to the vehicle electronics. If the electronics recognizes the signal, the vehicle will start and continue to run. If the system does not recognize the signal the vehicle will start and run for a maximum of 2 seconds after the initial key ON. After six unsuccessful attempts at starting, the system will shut down until the correct key is used.

NOTE: The Sentry Key Immobilizer System is not compatible with remote starting systems. Use of these systems may result in vehicle starting problems and a

loss of security protection. Additional Sentry Keys or Mobil Speed-pass™ devices held against or immediately adjacent to the ignition key when starting the engine may cause vehicle starting problems. If a problem occurs, remove the Sentry Key from the key-ring and attempt to start the vehicle again. Pagers, cell phones, walkman, etc. will have no effect on this system.

The "Security Light", located in the instrument cluster, will illuminate for about 2 seconds when the ignition switch is first turned to the ON position. If the vehicle electronics do not receive a valid signal from the ignition key, the "Security Light" will flash continuously to signal that the vehicle has been immobilized. If the "Security Light" remains on during vehicle operation, it indicates a fault in the system electronics. If this option was ordered, all of the keys provided with your new vehicle have been programmed to the vehicle electronics.

Replacement Keys

NOTE: Only keys that have been programmed to the vehicle electronics can be used to start the vehicle. Once a Sentry Key has been programmed to a vehicle, it cannot be programmed to any other vehicle.

At the time of purchase, the original owner is provided with a four digit PIN number. This number is required for dealer replacement of keys. Duplication of keys may be performed at an authorized dealer or by using the Customer Key Programming procedure. This procedure consists of programming a blank key to the vehicle electronics. A blank key is one which has never been programmed and needs to be cut.

NOTE: When having the Sentry Key System serviced, bring all vehicle keys to the dealer.

Customer Key Programming

You can program new keys to the system if you have two valid keys by doing the following:

1. Insert the first valid key into the ignition and turn the ignition to the ON position for at least 3 seconds but no longer than 15 seconds. Turn the ignition back to the OFF position and remove the first key.
2. Insert the second valid key and switch the ignition to the ON position within 15 seconds. After 10 seconds the "Security Light" will begin to flash. Turn the ignition back to the OFF position and remove the second key.
3. Insert a blank Sentry Key into the ignition and switch the ignition to the ON position within 60 seconds of having removed the second key. After 10 seconds the "Security Light" will stop flashing, then turn on for 3 seconds; then turn off.

The new Sentry Key has been programmed. Repeat this process to program up to an additional 6 keys. A maximum of 8 keys can be programmed to the system, including the original keys provided with the vehicle.

2

General Information

This device complies with part 15 of FCC rules and with RS-210 of Industry Canada. Operation is subject to the following conditions:

1. This device may not cause harmful interference.
2. This device must accept any interference that may be received including interference that may cause undesired operation.

NOTE: Changes or modifications not expressly approved by the party responsible for compliance could void the user's authority to operate the equipment.

IGNITION AND STEERING LOCK — IF EQUIPPED

Manual Transmissions

Depress and hold the release button located between the ignition switch and the instrument panel. Turn the ignition key to LOCK and remove the key.

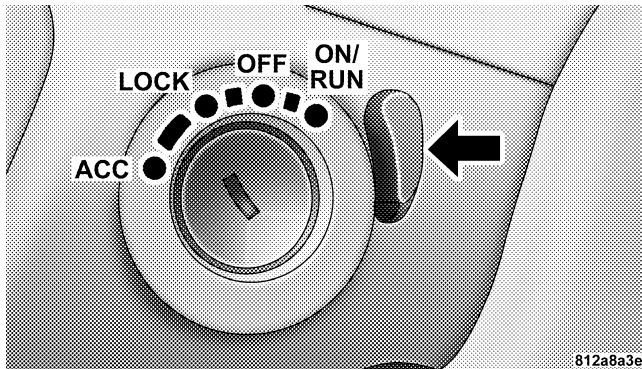

Manual Transmissions

DOOR KEY

The same key used to start the vehicle is also used to unlock the doors. To unlock the vehicle doors, insert the key into the lock and turn.

To lock the doors, insert the key and turn.

DOOR LOCKS

Power Door Locks

WARNING!

For personal security and safety in the event of an accident, lock the vehicle doors when you drive as well as when you park and leave the vehicle.

WARNING!

When leaving the vehicle always remove the key from the ignition lock, and lock your vehicle. Do not leave children unattended in the vehicle, or with access to an unlocked vehicle. Unsupervised use of vehicle equipment may cause severe personal injuries and death.

NOTE: Vehicles equipped with remote keyless entry do not have a passenger side door lock cylinder.

Vehicles equipped with power door locks can be locked or unlocked from inside by either the use of the door lock switches located on the front doors or by pressing the LOCK or UNLOCK buttons on the Remote Keyless Entry key fob (if equipped).

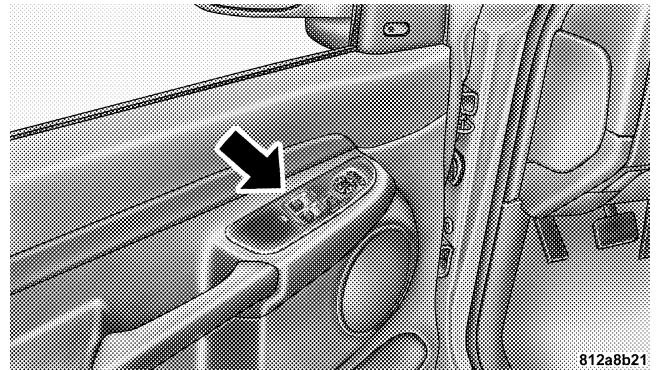

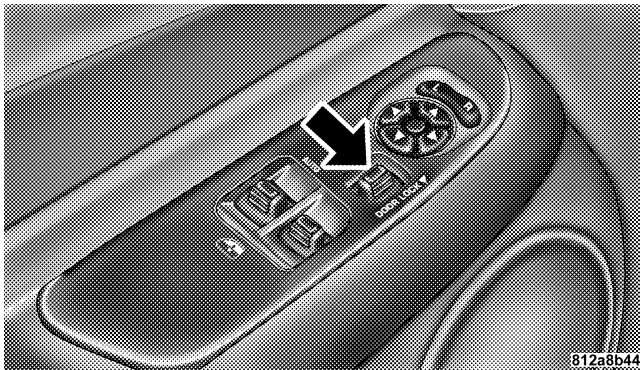

As a safety feature the doors will not lock when using the door lock switches during the following condition:

1. The driver's door is open while the key is in the ignition.

Central Locking — If Equipped

Vehicles with security will have a feature called "Central Locking". When the key is placed in the door cylinder and turned to the "Unlock" position, the security will be disarmed, the illuminated entry will be turned on and that door will be mechanically unlocked. If the key is once again turned to the unlock position within 5 seconds of the first unlock, the remaining doors will unlock. If the key is turned to the "Lock" position while all doors are closed, illuminated entry will be canceled, security will begin arming, and all doors will lock.

Automatic Door Locks

If this feature is enabled, your door locks will lock automatically when the vehicle's speed exceeds 15 mph.

This feature is enabled when your vehicle is shipped from the assembly plant and can be disabled by using the following procedure:

1. Enter your vehicle and close all doors.

2. Fasten your seat belt (Fastening the seat belt will cancel any chiming that may confuse you during this programming procedure).
3. Place the key into the ignition.
4. Within 10 seconds cycle the key from the OFF position to the ON position four times; ending in the ON position (**Do not start the engine**).
5. Within 30 seconds, press the driver's door lock switch in the LOCK direction.
6. A single chime will be heard to indicate the feature has been disabled.
7. To reactivate this feature, repeat the above steps.
8. If a chime is not heard, program mode was canceled before the feature could be disabled. If necessary, repeat the above procedure.

REMOTE KEYLESS ENTRY — IF EQUIPPED

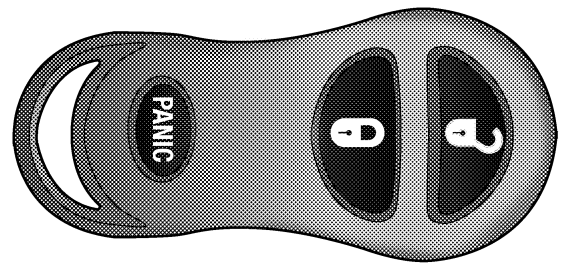

2

80b6f052

This system allows you to lock or unlock the doors from distances up to about 23 feet (7 meters) using a hand held radio transmitter. The transmitter need not be pointed at the vehicle to activate the system.

18 THINGS TO KNOW BEFORE STARTING YOUR VEHICLE

To unlock the doors:

Press and release the UNLOCK button on the key fob once to unlock only the driver's door or twice to unlock all the doors. When the UNLOCK button is pressed, the illuminated entry will initiate, the parking lights will flash on twice and if installed, the cargo lamp will turn on for 30 seconds.

The system can be programmed to unlock all the doors upon the first UNLOCK button press by using the following procedure:

1. Enter your vehicle and close all doors.
2. Fasten your seat belt.(Fastening the seat belt will cancel any chiming that may confuse you during this programming procedure).
3. Place the key into the ignition.
4. Turn the ignition to the ON position (**Do not start the engine**).
5. Press and hold the UNLOCK button on a programmed (i.e. functional) key fob.
6. Continue to hold the UNLOCK button, wait at least 4 seconds, but no longer than 10 seconds, then press and hold the LOCK button.
7. When a single chime is heard, release both buttons.
8. Turn the ignition to the OFF position or wait 60 seconds.
9. To reactivate this feature, repeat the above steps.
10. If a chime is not heard, program mode was canceled before the feature could be changed. If necessary, repeat the above procedure.

To lock the doors:

Press and release the LOCK button on the transmitter to lock all doors. If the ignition is OFF, when the doors are locked, the parking lights will flash on once and the horn will chirp once.

The horn chirp feature will be shipped from the assembly plants activated. If desired this feature can be disabled by using the following procedure:

1. Enter your vehicle and close all doors.
2. Fasten your seat belt (fastening the seat belt will cancel any chiming that may confuse you during this programming procedure).
3. Place the key into the ignition.
4. Turn the ignition to the ON position (**Do not start the engine**).
5. Press and hold the LOCK button on a programmed (i.e. functional) key fob.
6. Continue to hold the LOCK button, wait at least 4 seconds, but no longer than 10 seconds, then press and hold the UNLOCK button.
7. When a single chime is heard, release both buttons.
8. Turn the ignition to the OFF position or wait 60 seconds.
9. Test the horn chirp feature by pressing the LOCK button on the key fob with the ignition in the OFF position, or the key removed.
10. To reactivate this feature, repeat the above steps.

20 THINGS TO KNOW BEFORE STARTING YOUR VEHICLE

Vehicles will be shipped from the assembly plants with the park lamp flash feature activated. If desired, this feature can be disabled by using the following procedure:

1. Enter your vehicle and close all doors.
2. Fasten your seat belt (fastening the seat belt will cancel any chiming that may confuse you during this programming procedure).
3. Place the key into the ignition.
4. Turn the ignition to the ON position (**Do not start the engine**).
5. Press and hold the LOCK button on a programmed (i.e. functional) key fob.
6. Continue to hold the LOCK button, wait at least 4 seconds, but no longer than 10 seconds, then press and hold the PANIC button.
7. When a single chime is heard, release both buttons.
8. Turn the ignition to the OFF position or wait 60 seconds.
9. Test the park lamp flash feature by pressing the LOCK button on the key fob with the ignition in the OFF position or the key removed.
10. To reactivate this feature, repeat the above steps.
11. If a chime is not heard, program mode was canceled before the feature could be disabled. If necessary, repeat the above procedure.

Using the Panic Alarm

To activate the Panic mode while the ignition is OFF press and release the PANIC button on the transmitter once. When the Panic mode is activated, the interior lights will illuminate, the headlamps and parking lights will flash, and the horn will sound.

To cancel the Panic mode press and release the PANIC button on the transmitter a second time. Panic mode will automatically cancel after 3 minutes or if the vehicle is started and exceeds 15 mph. During the Panic Mode, the door locks and remote keyless entry systems will function normally. Panic mode will not disarm the security system on vehicles so equipped.

Programming Additional Transmitters

Vehicles with the keyless entry option will be shipped from the assembly plants with two key fob transmitters programmed only for that vehicle. A total of four fobs can be programmed for your vehicle. Additional fobs can be programmed to your vehicle through the use of a currently programmed fob.

NOTE: When entering program mode using that fob, ALL currently programmed fobs will be erased and you will have to reprogram them for your vehicle. However, if program mode is entered and no action is performed, the previously programmed fobs will continue to function.

1. Enter your vehicle and close all doors.
2. Fasten your seat belt (fastening the seat belt will cancel any chiming that may confuse you during this programming procedure).

22 THINGS TO KNOW BEFORE STARTING YOUR VEHICLE

3. Place the key into the ignition.
 4. Turn the ignition to the ON position (**Do not start the engine**).
 5. Press and hold the UNLOCK button on a programmed (i.e. functional) key fob.
 6. Continue to hold the UNLOCK button, wait at least 4 seconds, but no longer than 10 seconds, then press and hold the PANIC button.
 7. When a single chime is heard, release both buttons. The chime indicates that the system is in program mode.
 8. Press and release both the LOCK and UNLOCK buttons, simultaneously on the fob to be programmed.
 9. A single chime will be heard. The chime indicates that the fob has been recognized.
 10. Within 4 seconds of hearing the chime, press and release any button on the fob being programmed.
 11. A single chime will be heard. The chime indicates that the fob has been programmed.
 12. Repeat steps 8 to 11 for a total of 4 fobs.
 13. Turn the ignition to the OFF position or wait 60 seconds to exit program mode.
 14. Your vehicle will remain in program mode for up to 60 seconds from when the original chime (i.e. Step #7) was heard. After 60 seconds, all programmed fobs will function normally.
- NOTE:** If you do not have a programmed transmitter, contact your dealer for details.

General Information

This device complies with part 15 of FCC rules and with RS-210 of Industry Canada. Operation is subject to the following conditions:

1. This device may not cause harmful interference.
2. This device must accept any interference that may be received including interference that may cause undesired operation.

NOTE: Changes or modifications not expressly approved by the party responsible for compliance could void the user’s authority to operate the equipment.

If your Keyless Entry Transmitter fails to operate from a normal distance, check for these two conditions.

1. Weak batteries in transmitter. The expected life of the batteries is from one to two years.

2. Closeness to a radio transmitter such as a radio station tower, airport transmitter, and some mobile or CB radios.

Transmitter Battery Service

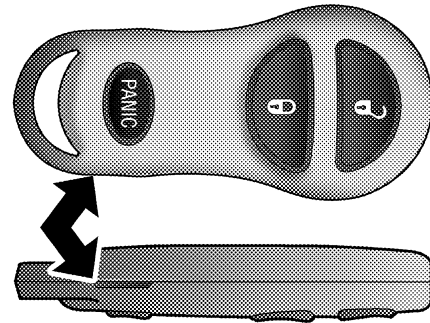

809dd6c1

The recommended replacement battery is a 3V lithium 2016 cell. This transmitter requires two batteries.

NOTE: Do not touch the battery terminals that are on the back housing or the printed circuit board.

1. With transmitter buttons facing down, use a flat blade or dime to pry the two halves of the transmitter apart. Make sure not to damage the rubber gasket during removal.
2. Remove and replace the batteries. Be careful not to disturb the metal terminal near the batteries. Install the batteries with the positive terminal up, reference the note "+ SIDE UP" on the inside of the bottom half of the transmitter case. Avoid touching the new batteries with your fingers. Skin oils may cause battery deterioration. If you touch a battery, clean it with rubbing alcohol.
3. To reassemble the transmitter case snap the two halves together. Make sure there is an even gap between the two halves. Test transmitter operation.

SECURITY ALARM SYSTEM — IF EQUIPPED

This system monitors the vehicle doors and ignition for unauthorized operation. When the alarm is activated, the system provides both audible and visual signals. For the first 3 minutes the horn will sound and the headlights and security telltale will flash repeatedly. For an additional 15 minutes only the headlights and security telltale will flash. The engine will run only if a valid Sentry Key is used to start the vehicle. Use of the Sentry Key will disable the alarm.

Rearming of the System:

The security system will rearm itself after the 15 additional minutes of headlights and security telltale flashing, if the system has not been disabled. If the condition which initiated the alarm is still present, the system will ignore that condition and monitor the remaining doors and ignition.

To Set the Alarm:

The alarm will set when you use the power door locks, turn the key in the driver's door lock cylinder, or use the Keyless Entry transmitter to lock the doors. After all the doors are locked and closed the SECURITY light in the instrument cluster will flash rapidly to signal that the system is arming. The security light in the instrument panel cluster will flash rapidly for about 16 seconds to indicate that the alarm is being set. After the alarm is set, the security light will flash at a slower rate to indicate that the system is armed.

NOTE: If the SECURITY light stays on continuously during vehicle operation, have the system checked by your dealer.

To Disarm the System:

Use the Keyless Entry transmitter or the key to turn the driver's door lock to the unlock position. If something has triggered the system in your absence, the horn will sound three times when you unlock the doors and the security lamp will flash for 30 seconds. Check the vehicle for tampering.

The Security system will also disarm, if the vehicle is started with a programmed Sentry Key. If an unprogrammed Sentry Key is used to start a vehicle, the engine will run for 2 seconds and then the security alarm will be initiated. To exit alarming mode, press the transmitter Unlock button, unlock the driver's door using the key cylinder, or start the vehicle with a programmed Sentry Key.

The Security Alarm System is designed to protect your vehicle; however, you can create conditions where the system will arm unexpectedly. If you remain in the

vehicle and lock the doors with the transmitter, the alarm will sound when you pull the door handle to exit. You may also accidentally disarm the system by unlocking the driver's door with the door key and then locking it manually with the lock plunger. The door will be locked but the Security Alarm will not arm.

WINDOWS

Power Windows—If Equipped

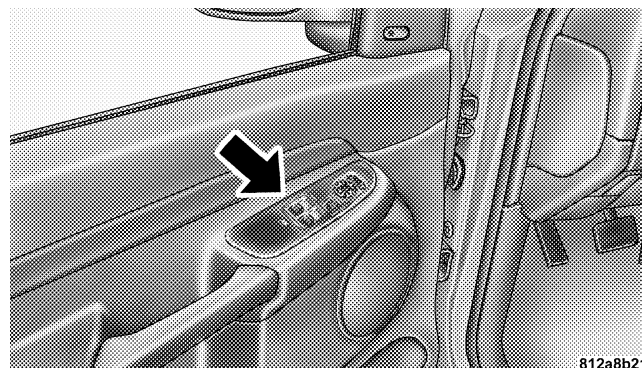

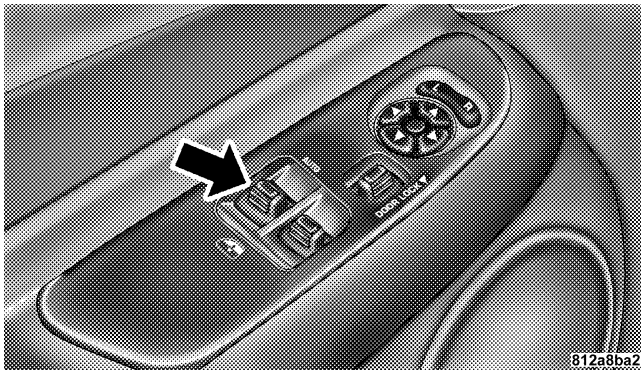

The control on the left front door panel has up-down switches that give you fingertip control of all power windows. There is a single opening and closing switch on the front passenger door for passenger window control. The windows will operate only when the ignition switch is turned to the ON or ACC (Accessory) position.

Auto Down (Driver's Side Only)

The driver's window switch has an Auto Down feature. Press the window switch past the detent, release, and the window will go down automatically.

2

Sliding Rear Window

A locking device in the center of the window helps to prevent entry from the rear of the vehicle. Squeeze the lock to release the window.

WIND BUFFETING

Wind buffeting can be described as the perception of pressure on the ears or a helicopter type sound in the ears. Your vehicle may exhibit wind buffeting with the windows down or partially open positions. This is a normal occurrence and can be minimized. If the buffeting occurs with the rear sliding glass open, open the front and rear sliding glass together to minimize the buffeting.

OCCUPANT RESTRAINTS

Some of the most important safety features in your vehicle are the restraint systems. These include the front and rear seat belts for the driver and all passengers, front airbags for both the driver and front passenger and, if so equipped, window bags for the driver and passengers seated next to a window. If you will be carrying children too small for adult-size belts, your seat belts also can be used to hold infant and child restraint systems.

Please pay close attention to the information in this section. It tells you how to use your restraint system properly to keep you and your passengers as safe as possible.

WARNING!

In a collision, you and your passengers can suffer much greater injuries if you are not properly buckled up. You can strike the interior of your vehicle or other passengers, or you can be thrown out of the vehicle. Always be sure you and others in your vehicle are buckled up properly.

Buckle up even though you are an excellent driver, even on short trips. Someone on the road may be a poor driver and cause a collision that includes you. This can happen far away from home or on your own street.

Research has shown that seat belts save lives, and that they can reduce the seriousness of injuries in a collision. Some of the worst injuries happen when people are thrown from the vehicle. Seat belts reduce the possibility of ejection and the risk of injury caused by striking the inside of the vehicle. **Everyone** in a motor vehicle should be belted at all times.

Lap/Shoulder Belts

All seating positions except the Quad Cab front center seating position have combination lap/shoulder belts. The belt webbing retractor is designed to lock during very sudden stops or collisions. This feature allows the shoulder part of the belt to move freely with you under normal conditions. But in a collision, the belt will lock and reduce the risk of your striking the inside of the vehicle or being thrown out.

WARNING!

It is extremely dangerous to ride in a cargo area, inside or outside of a vehicle. In a collision, people riding in these areas are more likely to be seriously injured or killed.

Do not allow people to ride in any area of your vehicle that is not equipped with seats and seat belts.

Be sure everyone in your vehicle is in a seat and using a seat belt properly.

WARNING!

- Wearing a seat belt incorrectly is dangerous. Seat belts are designed to go around the large bones of your body. These are the strongest parts of your body and can take the forces of a collision the best. Wearing your belt in the wrong place could make your injuries in a collision much worse. You might suffer internal injuries, or you could even slide out of part of the belt. Follow these instructions to wear your seat belt safely and to keep your passengers safe, too.
- Two people should never be belted into a single seat belt. People belted together can crash into one another in an accident, hurting one another badly. Never use a lap/shoulder belt or a lap belt for more than one person, no matter what their size.

Lap/Shoulder Belt Operating Instructions

1. Enter the vehicle and close the door. Sit back and adjust the seat.

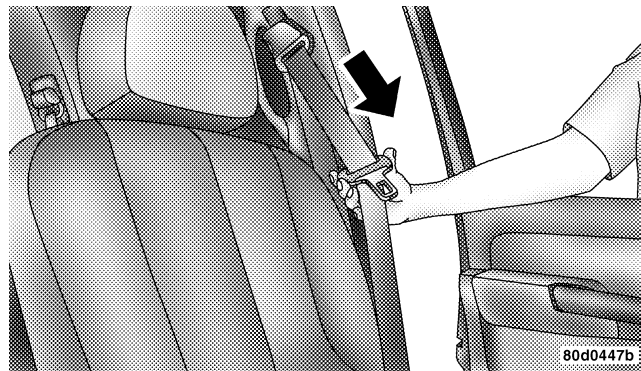

2. The seat belt latch plate is above the back of the front seat, next to your arm in the rear seat. Grasp the latch

plate and pull out the belt. Slide the latch plate up the webbing as far as necessary to allow the belt to go around your lap.

3. When the belt is long enough to fit, insert the latch plate into the buckle until you hear a “click.”

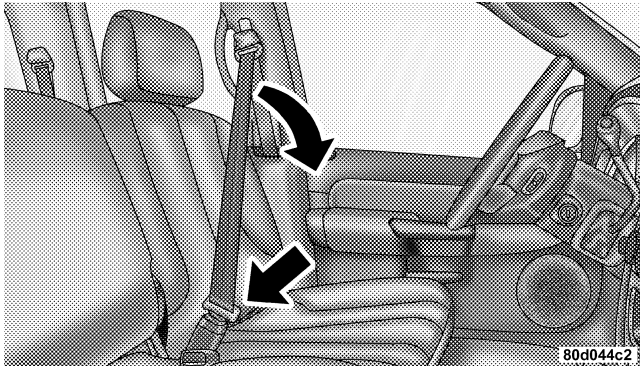

WARNING!

- A belt buckled into the wrong buckle will not protect you properly. The lap portion could ride too high on your body, possibly causing internal injuries. Always buckle your belt into the buckle nearest you.
- A belt that is too loose will not protect you as well. In a sudden stop you could move too far forward, increasing the possibility of injury. Wear your seat belt snugly.
- A belt that is worn under your arm is very dangerous. Your body could strike the inside surfaces of the vehicle in a collision, increasing head and neck injury. And a belt worn under the arm can cause internal injuries. Ribs aren't as strong as shoulder bones. Wear the belt over your shoulder so that your strongest bones will take the force in a collision.
- A shoulder belt placed behind will not protect you from injury during a collision. You are more likely to hit your head in a collision if you do not wear your shoulder belt. The lap and shoulder belt are meant to be used together.

32 THINGS TO KNOW BEFORE STARTING YOUR VEHICLE

4. Position the lap belt across your thighs, below your abdomen. To remove slack in the lap belt portion, pull up on the shoulder belt. To loosen the lap belt if it is too tight, tilt the latch plate and pull on the lap belt. A snug belt reduces the risk of sliding under the belt in a collision.

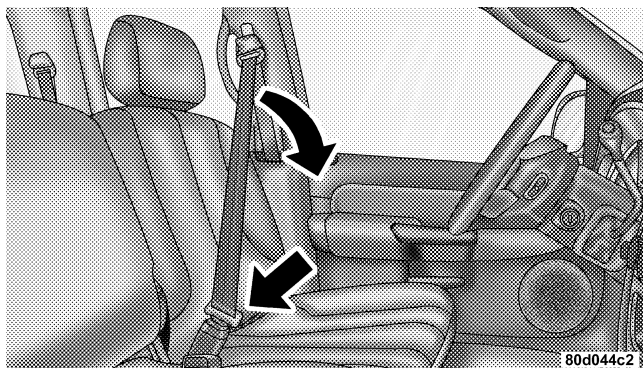

WARNING!

- A lap belt worn too high can increase the risk of internal injury in a collision. The belt forces won't be at the strong hip and pelvic bones, but across your abdomen. Always wear the lap belt as low as possible and keep it snug.
- A twisted belt can't do its job as well. In a collision it could even cut into you. Be sure the belt is straight. If you can't straighten a belt in your vehicle, take it to your dealer and have it fixed.

5. Position the shoulder belt on your chest so that it is comfortable and not resting on your neck. The retractor will withdraw any slack in the belt.
6. To release the belt, push the red button on the buckle. The belt will automatically retract to its stowed position. If necessary, slide the latch plate down the webbing to allow the belt to retract fully.

WARNING!

A frayed or torn belt could rip apart in a collision and leave you with no protection. Inspect the belt system periodically, checking for cuts, frays, or loose parts. Damaged parts must be replaced immediately. Do not disassemble or modify the system. Seat belt assemblies must be replaced after a collision if they have been damaged (bent retractor, torn webbing, etc.) or if the airbag deployed.

2**Standard Cab Front Center Three Point Belt**

1. The front center seat belt on the Standard Cab may be disconnected to open up utilization of the storage areas behind the front seats. The black latch plate can be detached from the black keyed seat belt buckle located on the inboard side of the passenger seat. Insert the vehicle ignition key into the center white slot on the black buckle.

34 THINGS TO KNOW BEFORE STARTING YOUR VEHICLE

The black buckle latch plate can be removed when the key is pressed into the buckle. Allow the retractor to take up the surplus webbing, and the buckles will hang vertically from the cab back exit bezel, thus freeing up all the area behind the front seats.

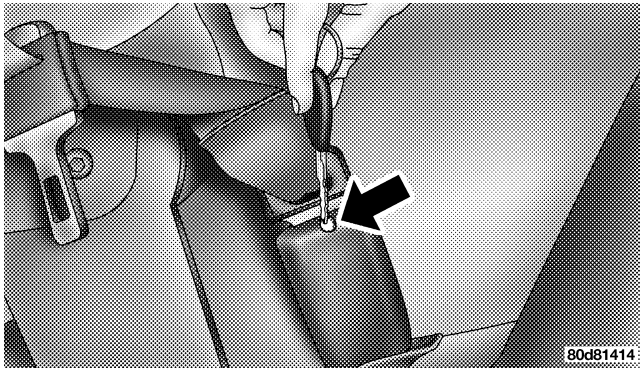

Detaching Buckle with Key

2. To reattach the seat belt to the front center seat, pull the black buckle latch plate forward from the cab back panel and insert it into the black keyed buckle until there is an audible click. Refer to the previous section for the proper seat belt usage.

WARNING!

- If the black latch and black buckle are not properly connected when the seat belt is used by an occupant, the seat belt will not be able to provide proper restraint and will increase the risk of injury in a collision.
- When reattaching the black latch and black buckle, ensure the seat belt webbing is not twisted. If the webbing is twisted, follow the preceding procedure to detach the black latch and black buckle, untwist the webbing, and reattach the black latch and black buckle.

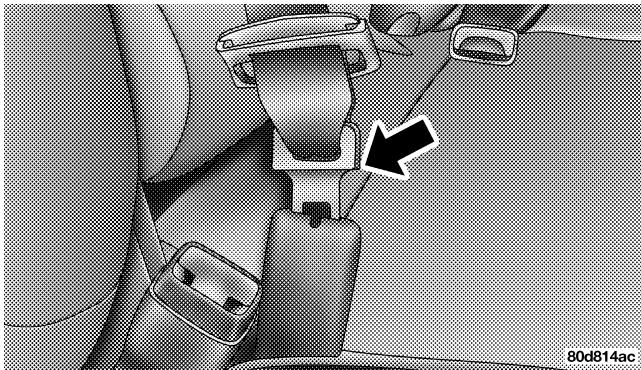

Inserting Latch Plate

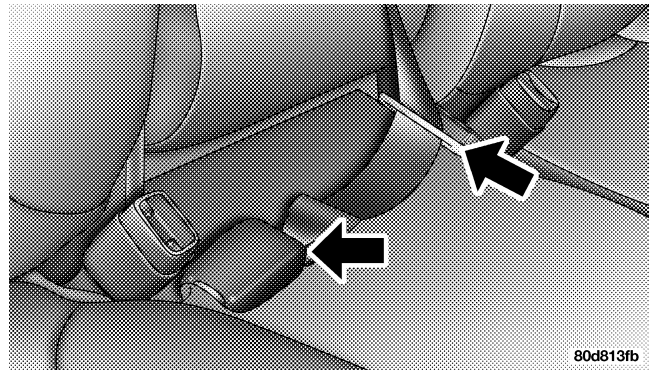

In Use Position

WARNING!

If the black latch and buckle are not connected when the seat belt is used by an occupant, the seat belt will not restrain you properly.

Adjustable Upper Shoulder Belt Anchorage

In the front row outboard seats, the shoulder belt can be adjusted upward or downward to help position the belt away from your neck. Press the button located on the upper belt guide, and then move it up or down to the position that serves you best.

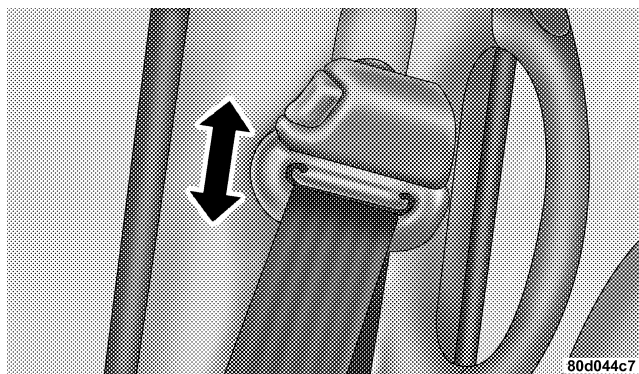

80d044c7

As a guide, if you are shorter than average, you will prefer a lower position, and if you are taller than average, you'll prefer a higher position. When you release the anchorage, try to move it up or down to make sure that it is locked in position.

Automatic Locking Mode (if Equipped)

In this mode, the shoulder belt is automatically pre-locked. The belt will still retract to remove any slack in the shoulder belt. The automatic locking mode is only available on the front passenger side belt.

When To Use The Automatic Locking Mode

Anytime a child safety seat is installed in a passenger front seating position. Children 12 years old and under should be properly restrained in the rear seat whenever possible.

How To Use The Automatic Locking Mode

1. Buckle the combination lap and shoulder belt.
2. Grasp the shoulder portion and pull downward until the entire belt is extracted.
3. Allow the belt to retract. As the belt retracts, you will hear a clicking sound. This indicates the safety belt is now in the automatic locking mode.

How To Disengage The Automatic Locking Mode

Disconnect the combination lap/shoulder belt and allow it to retract completely to disengage the automatic locking mode and activate the vehicle sensitive (emergency) locking mode.

Center Lap Belts

The center seating position for the Quad Cab front seat has a lap belt only. To fasten the lap belt, slide the latch plate into the buckle until you hear a "click." To lengthen the lap belt, tilt the latch plate and pull. To remove slack, pull the loose end of the webbing. Wear the lap belt snug against the hips. Sit back and erect in the seat, then adjust the belt as tightly as is comfortable.

WARNING!

- A lap belt worn too loose or too high is dangerous.
- A belt worn too loose can allow you to slip down and under the belt in a collision.
- A belt that is too loose or too high will apply crash forces to the abdomen, not to the stronger hip bones. In either case, the risk of internal injuries is greater. Wear a lap belt low and snug.

Seat Belt Pretensioners

The seat belts for both front seating positions are equipped with pretensioning devices that are designed to remove any slack from the seat belt system in the event of a collision. These devices improve the performance of the seat belt by assuring that the belt is tight about the occupant early in a collision. Pretensioners work for all size occupants, including those in child restraints.

NOTE: These devices are not a substitute for proper seat belt placement by the occupant. The seat belt still must be worn snugly and positioned properly.

The pretensioners are triggered by the airbag control module. Like the airbags, the pretensioners are single use items. After a collision that is severe enough to deploy the airbags and pretensioners, both must be replaced.

Enhanced Driver Seat Belt Reminder System (BeltAlert)

If the driver's seat belt has not been buckled within 60 seconds of starting the vehicle and if the vehicle speed is greater than 5 mph (8 km/h), the Enhanced Warning System (BeltAlert) will alert the driver to buckle their seat belt. The driver should also instruct all other occupants to buckle their seat belts. Once the warning is triggered, the Enhanced Warning System (BeltAlert) will continue to chime and flash the Seat Belt Warning Light for 96 seconds or until the driver's seat belt is buckled. The

Enhanced Warning System (BeltAlert) will be reactivated if the driver's seat belt is unbuckled for more than 10 seconds and the vehicle speed is greater than 5 mph (8 km/h).

The Enhanced Warning System (BeltAlert) can be enabled or disabled by your authorized dealer or by following these steps:

NOTE: The following steps must occur within the first 60 seconds of the ignition switch being turned to the ON or START position. DaimlerChrysler does not recommend deactivating the Enhanced Warning System (BeltAlert).

1. Turn the ignition switch to the OFF position and buckle the driver's seat belt.
2. Start the engine and wait for the Seat Belt Warning Light to turn off.

3. Within 60 seconds of starting the vehicle, unbuckle and then re-buckle the driver's seat belt at least three times within 10 seconds, ending with the seat belt buckled.

4. Turn off the engine. A single chime will sound to signify that you have successfully completed the programming.

The Enhanced Warning System (BeltAlert) can be reactivated by repeating this procedure.

NOTE: Although the Enhanced Warning System (BeltAlert) has been deactivated, the Seat Belt Warning Light will continue to illuminate while the driver's seat belt remains unbuckled.

Seat Belts and Pregnant Women

We recommend that pregnant women use seat belts throughout their pregnancies. Keeping the mother safe is the best way to keep the baby safe.

Pregnant women should wear the lap part of the belt across the thighs and as snug against the hips as possible. Keep the belt low so that it does not come across the abdomen. That way the strong bones of the hips will take the force if there is a collision.

Seat Belt Extender

If a seat belt is too short, even when fully extended, your dealer can provide you with a seat belt extender. This extender should be used only if the existing belt is not long enough. When it is not required, remove the extender and store it.

WARNING!

Using a seat belt extender when not needed can increase the risk of injury in a collision. Only use the seat belt extender when the lap belt is not long enough when it is worn low and snug, and in the recommended seating positions. Remove and store the extender when not needed.

Driver And Right Front Passenger Supplemental Restraint System (SRS)—Airbag

This vehicle has front airbags for both the driver and front passenger as a supplement to the seat belt restraint systems. The driver's front airbag is mounted in the center of the steering wheel. The passenger's front airbag is mounted in the instrument panel, above the glove compartment. The words SRS AIRBAG are embossed on the airbag covers.

These airbags are certified to the new Federal regulations that allow less forceful deployments.

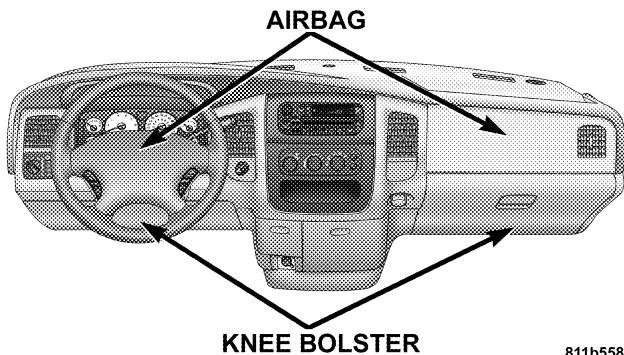

This vehicle may also be equipped with window bags to protect the driver and passengers in the first and second row sitting next to a window. If the vehicle is equipped with window bags, they are located above the side windows. Their covers are also labeled SRS AIRBAG.

WARNING!

- Do not put anything on or around the airbag covers or attempt to manually open them. You may damage the airbags and you could be injured because the airbags are not there to protect you. These protective covers for the airbag cushions are designed to open only when the airbags are inflating.
- Do not mount any aftermarket equipment such as trailer brake controllers, snowplow controllers, auxiliary light switches, radios, etc. on or behind the knee bolster. Knee bolsters are designed to work with the air bag and seat belt to protect you. Mounting any additional equipment on or behind the knee bolster can cause injury during a crash.
- If your vehicle is equipped with window bags, do not stack luggage or other cargo up high enough to block the location of the window bag. The area where the window bag is located should remain free from any obstructions.
- If your vehicle is equipped with window bags, do not have any accessory items installed which will alter the roof, including adding a sunroof to your vehicle. Do not add roof racks that require permanent attachments (bolts or screws) for installation on the vehicle roof. Do not drill into the roof of the vehicle for any reason.

42 THINGS TO KNOW BEFORE STARTING YOUR VEHICLE

Airbags inflate in moderate to high speed impacts. Along with the seatbelts, front airbags work with the instrument panel knee bolsters to provide improved protection for the driver and front passenger. Window bags also work with seat belts to improve occupant protection.

The seat belts are designed to protect you in many types of collisions. The front airbags deploy in moderate to severe frontal collisions. If your vehicle is so equipped, the window bag on the crash side of the vehicle is triggered in moderate to severe side collisions. In certain types of collisions, both the front and side airbags may be triggered. But even in collisions where the airbags work, you need the seat belts to keep you in the right position for the airbags to protect you properly.

Here are some simple steps you can follow to minimize the risk of harm from a deploying airbag.

- Children 12 years and under should ride buckled up in a rear seat, if available.
- Infants in rear facing child restraints must **NEVER** ride in the front seat of a vehicle with a passenger front airbag **unless the airbag is turned off** (Standard Cab Vehicles Only). An airbag deployment can cause severe injury or death to infants in that position. See the Passenger Airbag On/Off Switch section.
- If your vehicle does not have a rear seat, see the Passenger Airbag On/Off Switch section.
- Children that are not big enough to properly wear the vehicle seat belt (see section on Child Restraints) should be secured in the rear seat in child restraints or belt-positioning booster seats. Older children who do not use child restraints or belt-positioning booster seats should ride properly buckled up in the rear seat. Never allow children to slide the shoulder belt behind them or under their arm.
- All occupants should use their seat belts properly.

- The driver and front passenger seats should be moved back as far as practical to allow the airbag room to inflate.

WARNING!

- Relying on the airbags alone could lead to more severe injuries in a collision. The airbags work with your seat belt to restrain you properly. In some collisions the airbags won't deploy at all. Always wear your seat belts even though you have airbags.
- Being too close to the steering wheel or instrument panel during airbag deployment could cause serious injury. Airbags need room to inflate. Sit back, comfortably extending your arms to reach the steering wheel or instrument panel.
- If the vehicle has window airbags, they also need room to inflate. Do not lean against the door or window. Sit upright in the center of the seat.

Airbag System Components

The airbag system consists of the following:

- Airbag Control Module
- AIRBAG Readiness Light
- Driver Airbag
- Passenger Airbag
- Steering Wheel and Column
- Instrument Panel
- Crash Sensor
- Interconnecting Wiring
- Knee Impact Bolsters
- Passenger Side Frontal Airbag ON/OFF Switch (Standard Cab Vehicles Only)

The Window Airbag System, on vehicles equipped, consists of the following:

- AIRBAG Readiness Light (shared with the front airbag system)
- Window Bags Above the Side Windows.
- Airbag Control Module (shared with the front airbag system)
- Side impact sensors
- Interconnecting Wiring

How The Airbag System Works

- The airbag control module determines if a frontal collision is severe enough to require the airbags to inflate.
- The airbag control module will not detect roll over, or rear collisions.

- The airbag control module also monitors the readiness of the electronic parts of the system whenever the ignition switch is in the START or RUN positions. These include all of the items listed above except the knee bolsters, the instrument panel, and the steering wheel and column. If the key is in the "Off" position, in the ACC position or not in the ignition, the airbags are not on and will not inflate
- The airbag control module also turns on the AIR BAG light in the instrument panel for 6 to 8 seconds when the ignition is first turned on, then turns the light off.
 - **AIR BAG** If it detects a malfunction in any part of the system, it turns on the light either momentarily or continuously. The instrument cluster will flash the seat belt indicator if it detects a fault with the airbag indicator.

WARNING!

Ignoring the AIR BAG light in your instrument panel could mean you won't have the airbags to protect you in a collision. If the light does not come on, stays on after you start the vehicle, or if it comes on as you drive, have the airbag system checked right away.

- When the airbag control module detects a collision requiring the airbags, it signals the inflator units. A large quantity of nontoxic gas is generated to inflate the airbags. The airbag covers separate and fold out of the way as the airbags inflate to their full size. The airbags fully inflate in milliseconds. This is less time than it takes you to blink your eyes. The airbags then quickly deflate while helping to restrain the driver and front passenger. The driver's front airbag deflates through vents towards the instrument panel. The passenger's front airbag is deflated through vent holes in the sides of the airbag. In this way the airbags do not interfere with your control of the vehicle.
- The knee impact bolsters help protect the knees and position you for the best interaction with the front airbag.

Passenger Airbag On/Off Switch – (Standard Cab Vehicles Only)

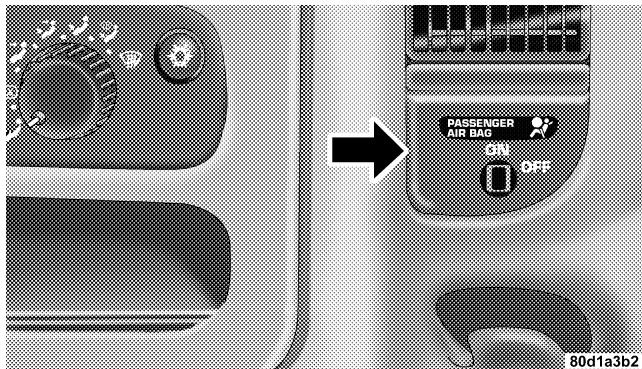

The passenger front airbag is to be turned off only if the passenger:

- is an infant (less than 1 year old) who must ride in the front seat because there is no rear seat, because the rear seat is too small for a rear-facing infant restraint or because the infant has a medical condition which makes it necessary for the driver to be able to see the infant,
- is a child, age 1 to 12 who must ride in the front seat because there is no rear seat, because there is no rear seat position available, or because the child has a medical condition which makes it necessary for the driver to be able to see the child,
- has a medical condition which makes passenger airbag inflation (deployment) a greater risk for the passenger than the risk of hitting the dashboard (instrument panel) or windshield in a crash.

WARNING!

Whenever an airbag is turned off, even a lap/shoulder belted passenger may hit their head, neck, or chest on the dashboard (instrument panel) or windshield in a crash. This may result in serious injury or death.

To Shut Off the Passenger Airbag (Standard Cab Vehicles Only)

Place the ignition key in the Passenger Airbag On/Off Switch, push the key in and turn clockwise, and remove the key from the switch. This will shut off the passenger side airbag. The "Off" light near the switch will illuminate when the ignition switch is turned to the ON position.

To Turn On the Passenger Airbag (Standard Cab Vehicles Only)

Place the ignition key in the Passenger Airbag On/Off Switch, push the key in and turn counterclockwise, and remove the key from the switch. This will turn on the passenger airbag. The "Off" light near the switch will be off when the ignition switch is turned to the ON position.

If A Deployment Occurs

The airbag system is designed to deploy when the air bag control module detects a moderate-to-severe frontal collision, and then immediately to deflate.

NOTE: A frontal collision that is not severe enough to need airbag protection will not activate the system. This does not mean something is wrong with the airbag system.

48 THINGS TO KNOW BEFORE STARTING YOUR VEHICLE

If you do have a collision which deploys the airbags, any or all of the following may occur:

- The nylon airbag material may sometimes cause abrasions and/or skin reddening to the driver and front passenger as the airbags deploy and unfold. The abrasions are similar to friction rope burns or those you might get sliding along a carpet or gymnasium floor. They are not caused by contact with chemicals. They are not permanent and normally heal quickly. However, if you haven't healed significantly within a few days, or if you have any blistering, see your doctor immediately.
- As the airbags deflate you may see some smoke-like particles. The particles are a normal by-product of the process that generates the nontoxic gas used for airbag inflation. These airborne particles may irritate the skin, eyes, nose, or throat. If you have skin or eye irritation, rinse the area with cool water. For nose or throat

irritation, move to fresh air. If the irritation continues, see your doctor. If these particles settle on your clothing, follow the garment manufacturer's instructions for cleaning.

- It is not advisable to drive your vehicle after the airbags have deployed. If you are involved in another collision, the airbags will not be in place to protect you.

WARNING!

Deployed airbags can't protect you in another collision. Have the airbags replaced by an authorized dealer as soon as possible.

Window Airbags Supplemental Restraint System (SRS)—If Equipped

The window airbag control module determines if a side collision is severe enough to require the side airbags to inflate. The window airbag control module will not detect roll over, front or rear collisions.

The airbag control module monitors the readiness of the electronic parts of the system whenever the ignition switch is in the "START" or "RUN" positions. These include all of the items listed above. The airbag control module also turns on the AIRBAG light in the instrument panel for 6 to 8 seconds when the ignition is first turned on as a diagnostic or system check, then turns the light off. If it detects a malfunction in any part of the system, it turns on the light either momentarily or continuously.

The side (window) impact SRS Airbags are designed to activate only in certain side collisions. When the airbag control module detects a collision requiring the window

bags to inflate, it signals the inflators on the crash side of the vehicle. A quantity of nontoxic gas is generated to inflate the window bag. The inflating window bag pushes the side pillar molding out of the way and covers the window. The airbag inflates in about 30 milliseconds (about one-quarter of the time it takes to blink your eyes) with enough force to injure you if you are not belted and seated properly, or if items are positioned in the area where the window bag inflates. This especially applies to children. The window bag is only about 3 ½ inches (8.9 cm) thick when it is inflated.

Enhanced Accident Response System

If the airbags deploy after an impact and the electrical system remains functional, vehicles equipped with power door locks will unlock automatically. In addition, approximately 10 seconds after the vehicle has stopped moving, the interior lights will light until the ignition switch is turned off.

Maintaining Your Airbag Systems

WARNING!

- **Modifications to any part of the airbag system could cause it to fail when you need it. You could be injured because the airbags are not there to protect you. Do not modify the components or wiring, including adding any kind of badges or stickers to the steering wheel hub trim cover or the upper right side of the instrument panel. Do not modify the front bumper, vehicle body structure, or frame.**
- **You need proper knee impact protection in a collision. Do not mount or locate any aftermarket equipment on or behind the knee bolster.**
- **It is dangerous to try to repair any part of the airbag system yourself. Be sure to tell anyone who works on your vehicle that it has airbags.**

Airbag Light

You will want to have the airbags ready to inflate for your protection in an impact. While the airbag system is designed to be maintenance free, if any of the following occurs, have an authorized dealer service the system promptly:

- The airbag light does not come on or flickers during the 6 to 8 seconds when the ignition switch is first turned on.
- The light remains on or flickers after the 6 to 8 second interval.
- The light flickers or comes on and remains on while driving.

NOTE: If the speedometer, tachometer or any engine related gauges are not working, the airbag control module may also be disabled. The airbags may not be ready to inflate for your protection. Promptly check fuse numbers 52 and 53 in the fuse and relay center. See your dealer if the fuse is good.

Child Restraint

Everyone in your vehicle needs to be buckled up all the time — babies and children, too. Every state in the United States and all Canadian provinces require that small children ride in proper restraint systems. This is the law, and you can be prosecuted for ignoring it.

Children 12 years and under should ride properly buckled up in a rear seat, if available. According to crash statistics, children are safer when properly restrained in the rear seats rather than in the front.

WARNING!

In a collision, an unrestrained child, even a tiny baby, can become a missile inside the vehicle. The force required to hold even an infant on your lap can become so great that you could not hold the child, no matter how strong you are. The child and others could be badly injured. Any child riding in your vehicle should be in a proper restraint for the child's size.

2**Infants and Small Children**

There are different sizes and types of restraints for children from newborn size to the child almost large enough for an adult safety belt. Use the restraint that is correct for your child:

- Safety experts recommend that children ride rearward-facing in the vehicle until they are at least one year old and weigh at least 20 lbs (9 kg). Two types

52 THINGS TO KNOW BEFORE STARTING YOUR VEHICLE

of child restraints can be used rearward-facing: infant carriers and "convertible" child seats. Both types of child restraints are held in the vehicle by the lap/shoulder belt.

- The infant carrier is only used rearward-facing in the vehicle. It is recommended for children who weigh up to about 20 lbs (9 kg). "Convertible" child seats can be used either rearward-facing or forward-facing in the vehicle. Convertible child seats often have a higher weight limit in the rearward-facing direction than infant carriers do, so they can be used rearward-facing by children who weigh more than 20 lbs (9 kg) but are less than one year old.
- Rearward-facing child seats must **NEVER** be used in the front seat of a vehicle with a front passenger airbag unless the airbag is turned off. An airbag deployment could cause severe injury or death to infants in this position.
- Children who weigh more than 20 lbs (9 kg) and who are older than one year can ride forward-facing in the vehicle. Forward-facing child seats and convertible child seats used in the forward-facing direction are for children who weigh 20 to 40 lbs (9 to 18 kg) and who are older than one year. These child seats are also held in the vehicle by the lap/shoulder belt.
- The belt-positioning booster seat is for children weighing more than 40 lbs (18 kg), but who are still too small to fit the vehicle's seat belts properly. If the child cannot sit with knees bent over the vehicle's seat cushion while the child's back is against the seat back, they should use a belt-positioning-booster seat. The child and booster seat are held in the vehicle by the lap/shoulder belt. (Some booster seats are equipped with a front shield and are held in the vehicle by the lap portion.) For further information refer to www.seatcheck.org.

WARNING!

- **Improper installation can lead to failure of an infant or child restraint. It could come loose in a collision. The child could be badly injured or killed. Follow the manufacturer's directions exactly when installing an infant or child restraint.**
- **A rearward facing child restraint should only be used in a rear seat, or in the front seat if the passenger's front airbag is Off. If the airbag is left On, a rearward facing child restraint in the front seat may be struck by a deploying passenger airbag which may cause severe or fatal injury to the infant.**

Here are some tips for getting the most out of your child restraint:

- Before buying any restraint system, make sure that it has a label certifying that it meets all applicable Safety Standards. We also recommend that you make sure that you can install the child restraint in the vehicle where you will use it before you buy it.
- The restraint must be appropriate for your child's weight and height. Check the label on the restraint for weight and height limits.
- Carefully follow the instructions that come with the restraint. If you install the restraint improperly, it may not work when you need it.
- The passenger seat belts are equipped with either cinching latch plates or switchable seat belt retractors, which are designed to keep the lap portion tight around the child restraint so that it is not necessary to use a locking clip.

If the seat belt has a cinching latch plate, pulling up on the shoulder portion of the lap/shoulder belt will tighten the belt. The cinching latch plate will keep the belt tight, however, any seat belt system will loosen with time, so check the belt occasionally and pull it tight if necessary.

If the seat belt has a switchable retractor, it will have a distinctive label: Pull the belt from the retractor until there is enough to allow you to pass through the child restraint and slide the latch plate into the buckle. Then pull on the belt until it is all removed from the retractor. Allow the belt to return to the retractor, pulling on the excess webbing to tighten the lap portion about the child restraint. Refer to the "Automatic Locking Mode" earlier in this section.

- In the rear seat, you may have trouble tightening the lap/shoulder belt on the child restraint because the buckle or latch plate is too close to the belt path

opening on the restraint. Disconnect the latch plate from the buckle and twist the short buckle-end belt several times to shorten it. Insert the latch plate into the buckle with the release button facing out.

- If the belt still can't be tightened, or if pulling and pushing on the restraint loosens the belt, disconnect the latch plate from the buckle, turn the buckle around, and insert the latch plate into the buckle again. If you still can't make the child restraint secure, try a different seating position.
- Buckle the child into the seat according to the child restraint manufacturer's directions.
- When your child restraint is not in use, secure it in the vehicle with the seat belt or remove it from the vehicle. Do not leave it loose in the vehicle. In a sudden stop or collision, it could strike the occupants or seat backs and cause serious personal injury.

WARNING!

Improper installation can lead to failure of an infant or child restraint. It could come loose in a collision. The child could be badly injured or killed. Follow the manufacturer's directions exactly when installing an infant or child restraint.

Lower Anchors and Tether for Children (LATCH)

Each vehicle is equipped with the child restraint anchorage system called LATCH, which stands for Lower Anchors and Tether for Children. LATCH child restraint anchorage systems are installed in the Standard Cab passenger seat position and the Quad Cab rear seat outboard positions and also feature tether strap anchorages, which must be used, located behind the seatback (refer to Child Restraint Tether Anchor later in this section).

Identification dots are located above the standard cab front seat lower anchorages as a guide for locating lower anchors.

NOTE: For children riding in the front seat of a Standard Cab model refer to the "Passenger Airbag On/Off Switch" located in this section.

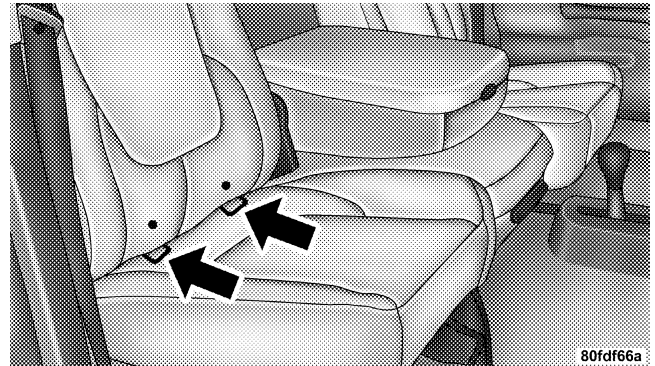

Standard Cab Passenger Seat

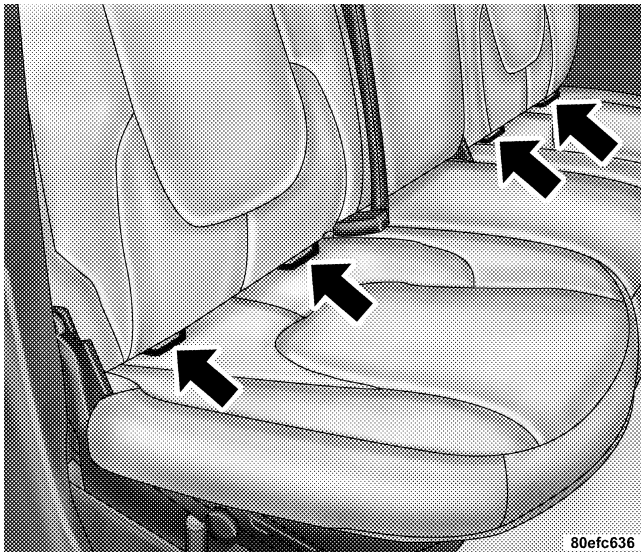

Quad Cab Outboard Seat

Child restraint systems having attachments designed to connect to the lower anchorages are now available. Child restraints having tether straps and hooks for connection to the seatback tether anchorage have been available for some time. In fact, many child restraint manufacturers will provide add-on tether strap kits for some of their older products.

Because the lower anchorages are to be introduced to passenger carrying vehicles over a period of years, child restraint systems having attachments for those anchorages will continue to have features for installation in vehicles using the lap or lap/shoulder belt. They will also have tether straps, and you are urged to take advantage of all of the available attachments provided with your child restraint in any vehicle.

NOTE: If your child restraint seat is not LATCH compatible, install the restraint using the vehicle seat belting.

Installing the Child Restraint System

WARNING!

Do not install child restraint systems equipped with LATCH attachments in the center position of a Quad Cab model rear seat. The LATCH anchorages in this seat are designed for the two outboard seating positions only. A child may be placed in the rear center seating position of a Quad Cab model using the seat belt and child tether anchorage. Failure to follow this may result in serious or fatal injury.

We urge that you carefully follow the directions of the manufacturer when installing your child restraint. Many, but not all, restraint systems will be equipped with separate straps on each side, with each having a hook or connector and a means for adjusting the tension in the strap. Forward-facing toddler restraints and some rearward-facing infant restraints will also be equipped with a tether strap, a hook and means for adjusting the tension in the strap.

In general, you will first loosen the adjusters on the lower straps and tether straps so that you can more easily attach the hook or connector to the lower anchorages and tether anchorages. Then tighten all three straps as you push the child restraint rearward and downward into the seat.

Not all child restraint systems will be installed as we have described here. Again, carefully follow the instructions that come with the child restraint system.

WARNING!

Improper installation of a child restraint to the LATCH anchorages can lead to failure of an infant or child restraint. The child could be badly injured or killed. Follow the manufacturer's directions exactly when installing an infant or child restraint.

Child Restraint Tether Anchor

Child restraints having tether straps and hooks for connection to tether anchors have been available for some time. In fact, many child restraint manufacturers will provide add-on tether strap kits for their older products. Regular Cab models of Ram Pickups have two tether anchorages, one each behind the front center and right seats. Quad Cab models have three anchorages, one behind each of the rear seats.

WARNING!

An incorrectly anchored tether strap could lead to seat failure and injury to the child. In a collision, the seat could come loose and allow the child to crash into the inside of the vehicle or other passengers, or even be thrown from the vehicle. Use only the anchor positions directly behind the child seat to secure a child restraint top tether strap. Follow the instructions below. See your dealer for help if necessary.

Tether Anchorage Points at the Right and Center Front Seat (Regular Cab - All Seats)

1. Place the child restraint on the seat and adjust the tether strap so that it will reach over the seat back under the head restraint to the tether anchor directly behind the seat.

2. Lift the cover (if so equipped), and attach the hook to the square opening in the sheet metal.
3. Install the child restraint and remove the slack in the tether strap according to the manufacturer's instructions.

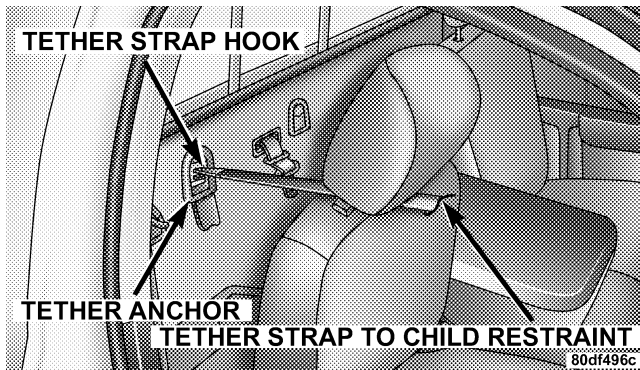

Regular Cab With Any Bench Seat

Multiple Child Restraint Installation Sequence - (Quad Cab Rear Seats)

2

1. Obtain tether straps by raising the head restraints and reaching between the rear glass and rear seat. The tether strap may be retained with an elastic band. Accessibility to the tether strap is greatly improved by raising the seat cushion to the "up" position. Remove the elastic before use.
2. Place a child restraint on each outboard rear seat and adjust the tether strap so that it will reach under the head restraint to the tether anchor directly behind the seat and then to the anchor directly behind the center rear seat.
3. Pass each tether strap hook under the head restraint and through the loop of webbing behind the child seat.
4. Route each tether strap to the anchor behind the center seat, and attach the hooks to the metal ring.

60 THINGS TO KNOW BEFORE STARTING YOUR VEHICLE

5. Place a child restraint on the center rear seat and adjust the tether strap so that it will reach under the head restraint to the tether anchor directly behind the seat and to the anchor directly behind the right seat.

6. Install each child restraint and remove the slack in the tether strap according to the child restraint manufacturer's instructions.

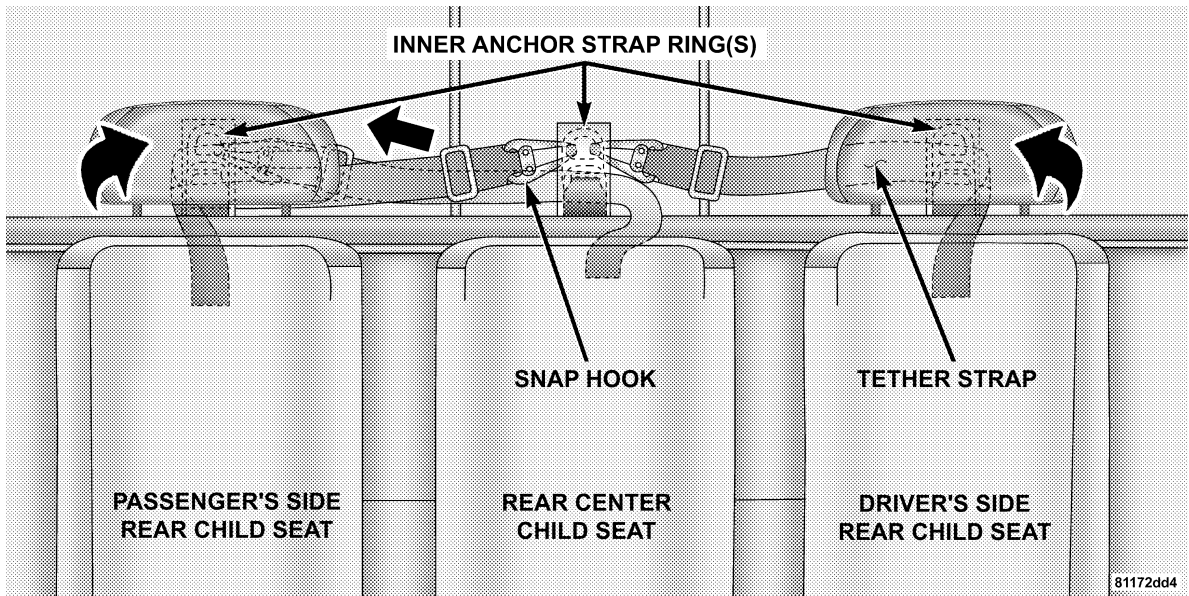

Multiple Child Restraints

81172dd4

Children Too Large for Booster Seats

Children who are large enough to wear the shoulder belt comfortably, and whose legs are long enough to bend over the front of the seat when their back is against the seat back should use the lap/shoulder belt in a rear seat.

- Make sure that the child is upright in the seat.
- The lap portion should be low on the hips and as snug as possible.
- Check belt fit periodically. A child's squirming or slouching can move the belt out of position.

If the shoulder belt contacts the face or neck, move the child closer to the center of the vehicle. Never allow a child to put the shoulder belt under an arm or behind their back.

ENGINE BREAK-IN RECOMMENDATIONS

The engine in your new SRT-10 does not require a long break-in period. Following these few simple guidelines is all that is necessary for a good break-in:

For the first 500 miles (800 km):

- Keep your vehicle speed below the legal, posted speed limit and your engine speed below 4,000 rpm.
- Avoid driving at a constant speed, either fast or slow, for long periods of time.
- Do not make any full throttle starts and avoid full throttle acceleration.
- Use the proper gear for your speed range.
- Wait until the engine has reached normal operating temperature before driving at the recommended maximum break-in speed.
- Avoid excessive idling.
- Check the engine oil level at every fuel fill.

NOTE: A new engine will consume some oil during the first few thousand miles of operation. This should be considered as a normal part of the break-in and not interpreted as a sign of difficulty.

SAFETY TIPS

Transporting Passengers

This vehicle is designed to carry passengers in the cab only. For safety reasons, NEVER TRANSPORT PASSENGERS IN THE CARGO AREA.

WARNING!

It is extremely dangerous to ride in a cargo area, inside or outside of a vehicle. In a collision, people riding in these areas are more likely to be seriously injured or killed.

Do not allow people to ride in any area of your vehicle that is not equipped with seats and seat belts.

Be sure everyone in your vehicle is in a seat and using a seat belt properly.

Lock Your Vehicle

Always remove the keys from the ignition and lock all doors when leaving the vehicle unattended, even in your own driveway or garage. Try to park your vehicle in a well-lighted area and never invite theft by leaving articles of value exposed.

Exhaust Gas**WARNING!**

Exhaust gases contain carbon monoxide, a potentially toxic gas that by itself is colorless and odorless. To avoid inhaling these gases, the following precautions should be observed:

- Do not run the engine in a closed garage or in confined areas any longer than needed to move your vehicle in or out of the area.
- If it is necessary to sit in a parked vehicle with the engine running for more than a short period, adjust your climate control system to force outside air into the vehicle. Set the blower at high speed and the controls in any position except OFF or MAX A/C.

- The best protection against carbon monoxide entry into the vehicle body is a properly maintained engine exhaust system.

Be aware of changes in the sound of the exhaust system; exhaust fumes detected inside the vehicle; or damage to the underside or rear of the vehicle. Have a competent mechanic inspect the complete exhaust system and adjacent body areas for broken, damaged, deteriorated or mispositioned parts. Open seams or loose connections could permit exhaust fumes to seep into the passenger compartment. In addition, inspect the exhaust system each time the vehicle is raised for lubrication or oil change. Replace or adjust as required.

Safety Checks You Should Make Inside The Vehicle

Seat Belts

Inspect the belt system periodically, checking for cuts, frays and loose parts. Damaged parts must be replaced immediately. Do not disassemble or modify the system.

Seat belt assemblies must be replaced after an accident if they have been damaged (bent retractor, torn webbing, etc.) or if the front airbags have deployed. If there is any question regarding belt or retractor condition, replace the belt.

Airbag Light

The light should come on and remain on for 6 to 8 seconds as a bulb check when the ignition switch is first turned ON. If the light is not lit during starting, see your authorized dealer. If the light stays on, flickers or comes on while driving, have the system checked by an authorized dealer. If there is a problem with the airbag light the seatbelt light will flash.

Safety Checks You Should Make Outside The Vehicle

Tires

Examine tires for tread wear or uneven wear patterns. Check for stones, nails, glass or other objects lodged in the tread.

Inspect for tread cuts or sidewall cracks. Check wheel nuts for tightness and tires for proper pressure.

Lights

Check the operation of all exterior lights. Check turn signal and high beam indicator lights on the instrument panel.

Door Latches

Check for positive closing, latching and locking.

Fluid Leaks

Check area under vehicle after overnight parking for fuel, water, oil, or other fluid leaks. Also, if fuel fumes are detected the cause should be located and corrected.

UNDERSTANDING THE FEATURES OF YOUR VEHICLE

CONTENTS

■ Mirrors71	□ Phone Call Features79
□ Automatic Dimming Mirror— If Equipped71	□ Advanced Phone Connectivity82
□ Outside Mirrors71	□ UConnect™ System Features83
□ Exterior Mirrors Folding Feature72	■ Seats86
□ Electronic Power Mirrors — If Equipped72	□ 40-20-40 Front Seat87
□ Electric Rear Window Defroster And Heated Sideview Mirrors — If Equipped73	□ Power Driver Seat88
■ Hands-Free Communication (UConnect™) — If Equipped73	□ Manual Passenger Seat89
□ Operation75	□ Manual Seatback Recline90
		□ Adjustable Head Restraints90

68 UNDERSTANDING THE FEATURES OF YOUR VEHICLE

■ To Open And Close The Hood91	□ Passing Light98
■ Lights93	□ High Beam / Low Beam Select Switch98
□ Interior Lights93	□ Windshield Wipers99
□ Battery Saver94	□ Windshield Washers	100
□ Headlamp Delay — If Equipped95	■ Tilt Steering Column	101
□ Headlights, Parking Lights, Panel Lights95	■ Driver Adjustable Pedals	102
□ Daytime Running Lights (Canada And Fleet Vehicles Only)96	□ Adjustment	102
□ Lights-On Reminder96	■ Electronic Speed Control	103
□ Fog Lights96	□ To Activate	104
□ Cargo Light97	□ To Set At A Desired Speed	104
■ Multifunction Control Lever97	□ To Deactivate	104
□ Turn Signals97	□ To Resume Speed	104
		□ To Vary The Speed Setting	104

<hr/>		UNDERSTANDING THE FEATURES OF YOUR VEHICLE 69
□ To Accelerate For Passing	105	□ Automatic Compass Calibration
■ Overhead Console	106	□ Manual Compass Calibration
□ Courtesy/Reading Lights	106	□ To Put Into a Calibration Mode
■ Compass/Temperature Mini-Trip Computer	107	□ Outside Temperature
□ US/M Button	107	■ Garage Door Opener
□ Reset Button	108	□ Programming Homelink
□ Global Reset	108	□ Canadian Programming/Gate Programming . .
□ Step Button	108	□ Using Homelink
□ Average Fuel Economy (AVG ECO)	109	□ Erasing Homelink Buttons
□ Distance To Empty (DTE)	109	□ Reprogramming a Single Homelink Button . .
□ Trip Odometer (ODO)	109	□ Security
□ Elapsed Time (ET)	110	■ Power Sunroof — If Equipped
□ C/T Button	110	□ Opening Sunroof - Express

70 UNDERSTANDING THE FEATURES OF YOUR VEHICLE

□ Closing Sunroof - Express	120	■ Cigar Lighter And Ash Receiver	123
□ Pinch Protect Feature	120	■ Cupholders	124
□ Pinch Protect Override	120	□ Front Cupholders	124
□ Venting Sunroof - Express	120	■ Storage	124
□ Sunshade Operation	121	□ Center Storage Compartment	124
□ Wind Buffeting	121	□ Storage And Seats	125
□ Sunroof Maintenance	121	■ Pickup Box	126
□ Ignition Off Operation	121	■ Slide-In Campers	128
□ Sunroof Fully Closed	121	■ Easy-Off Tailgate	128
■ Electrical Power Outlets	122		

MIRRORS

Automatic Dimming Mirror— If Equipped

This mirror automatically adjusts for annoying headlight glare from vehicles behind you. You can turn the feature on or off by pressing the button at the base of the mirror. A light in the button will indicate when the dimming feature is activated.

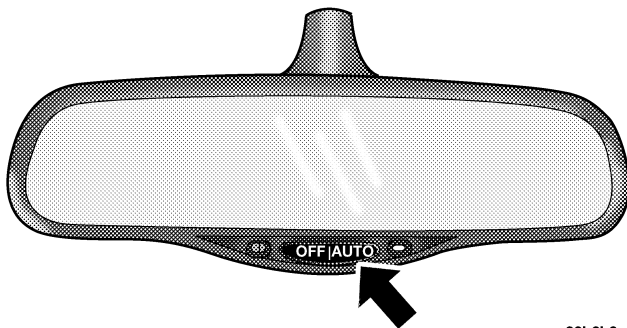

80b6b3a6

CAUTION!

To avoid damage to the mirror during cleaning, never spray any cleaning solution directly onto the mirror. Apply the solution onto a clean cloth and wipe the mirror clean.

3

Outside Mirrors

To receive maximum benefit, adjust the outside mirror(s) to center on the adjacent lane of traffic with a slight overlap of the view obtained on the inside mirror.

WARNING!

Vehicles and other objects seen in a right side convex mirror will look smaller and farther away than they really are. Relying too much on your right side convex mirror could cause you to collide with another vehicle or other object. Use your inside mirror when judging the size or distance of a vehicle seen in the right side convex mirror. Some vehicles will not have a convex right side mirror.

Exterior Mirrors Folding Feature

All exterior mirrors are hinged and may be moved either forward or rearward to resist damage. The hinges have three detent positions; full forward, full rearward, and normal.

Electronic Power Mirrors — If Equipped

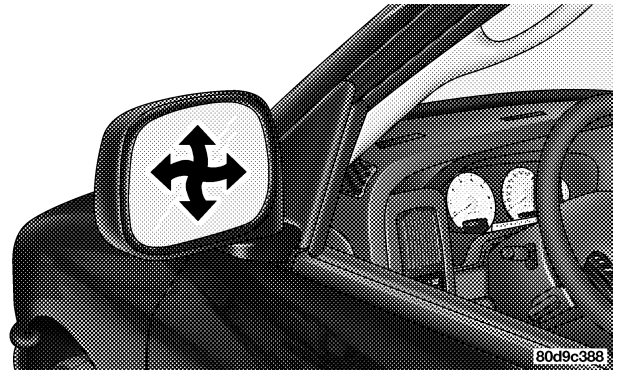

The controls for the power mirrors are located on the driver's door trim panel.

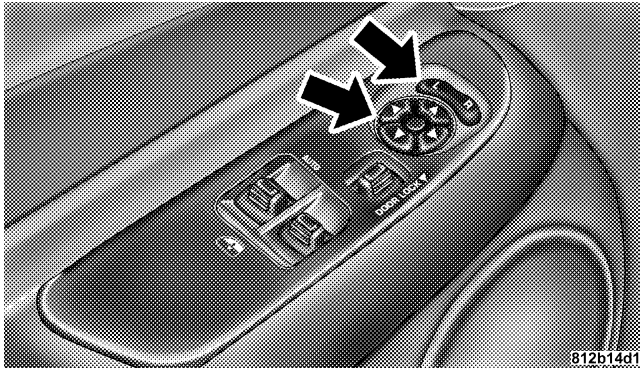

Set the top switch to the left or right for the left or right mirror, and set it to the center off position to prevent accidentally moving a mirror when you are finished adjusting the mirror. To adjust a mirror, select left or right with the top switch, and press one of the four arrows for the direction you want the mirror to move.

Electric Rear Window Defroster and Heated Sideview Mirrors — If Equipped

 The Electric Rear Window Defroster and Heated side view mirrors are activated by pressing the heated grid button, located on the Climate Control panel, with the ignition On. Turning Off the ignition will deactivate the Electric Rear Window Defroster and Heated side view mirrors feature. These features also turn off after activation, when 15 minutes have elapsed. To reactivate, simply press the button again.

3

HANDS-FREE COMMUNICATION (UConnect™) — IF EQUIPPED

UConnect™ is a voice-activated, hands-free, in-vehicle communications system. UConnect™; allows you to dial your cellular phone using simple voice commands (e.g., “Call” or “Dial”). Your cellular phone’s audio is transmitted through your vehicle’s stereo system; the system will automatically mute your radio before receiving or sending a call.

74 UNDERSTANDING THE FEATURES OF YOUR VEHICLE

UConnect™ allows you to transfer calls between the system and your cellular phone as you enter or exit your vehicle, and enables you to mute the system's microphone for private conversations.

The UConnect™ phone book enables you to store up to 32 names and four numbers per name. This system is driven through your Bluetooth™ Hands-Free Profile cellular phone. UConnect™ features Bluetooth™ technology - the global standard that enables different electronic devices to connect to each other without wires or a docking station, so UConnect™ works no matter where you stow your cellular phone (be it your purse, pocket, or briefcase). UConnect™ allows up to seven cellular phones to be linked to the system, and it is available in English, French, or Spanish formats (as equipped).

The rearview mirror contains the microphone for the system and the control buttons that will enable you to

access the system. The diagram below shows the mirror with the appropriate buttons. Individual button behavior is discussed in the "Operation" Section.



8105b20d

The UConnect™ system can be used with any Hands Free Profile certified Bluetooth™ cellular phone. If your cellular phone has a different profile (i.e. headset profile), you will not be able to use any UConnect™ features.

The UConnect™ system is fully integrated into your vehicle, including your vehicle's stereo system. All voice prompts as well as the other party's voice in a conversation will be played over your vehicle's stereo system. The volume of the UConnect™ system can be controlled through your normal stereo controls.

The radio display will be used for visual prompts from the UConnect™ system such as caller ID.

Operation

Voice commands can be used in the operation of the UConnect™ system and to navigate through the UConnect™ menu structure. Voice commands should be given after each UConnect™ system prompt. You will be prompted for a specific command and then guided through the available options. There are two ways to give commands to the UConnect™ system:

- You can say "Dial" at the "Ready" prompt. When prompted for the phone number you wish to dial, say the phone number ("123 456 7890").

Pairing a Cellular Phone to the UConnect™ System

To begin using your UConnect™ system, you must pair your compatible Bluetooth™ enabled cellular phone. To complete the registration process, you will need to reference your cellular phone owner's manual.

- Press the 'Phone' button to begin.
- After the "Ready" prompt, say "Setup".
- When prompted, say " Phone Pairing".
- You will be asked to say a four-digit pin number into the UConnect™ system which you will later need to enter into your cellular phone during the cellular phone pairing process. You can enter any four-digit pin number. You will not need to remember this pin number after the initial registration process.

- The UConnect™ system will then prompt you to begin the cellular phone pairing process on your cellular phone. Please see your cellular phone user's manual for instructions on how to complete this step.
- For identification purposes, you will be prompted to give the UConnect™ system a name for your cellular phone. Each cellular phone that is paired should be given a unique phone name.
- You will then be asked to give your cellular phone a priority level between 1 and 7, 1 having the highest priority. You can connect up to seven cellular phones to your UConnect™ system and the priority allows the UConnect™ system to know which cellular phone to use if multiple cellular phones are in the vehicle at the same time. For example, if a priority 3 and priority 5 cellular phone are both in the vehicle, the UConnect™ system will use the priority 3 cellular phone when you make a call. You can select to use a lower priority cellular phone at any time.

Making a Phone Call Using Digit Dialing

- Press the 'Phone' button to begin.
- After the "Ready" prompt, say "Dial" or "Call" followed by the phone number you wish to dial. For example, you can say "Dial" wait for ready prompt 123 456 7890. The phone number that you enter must be a valid length.

Making a Phone Call Using Your UConnect™ Phonebook

- Press the "Phone" button to begin.
- After the "Ready" prompt, say "Dial" or "Call" wait for the ready prompt followed by the name and designation of a phonebook entry that you wish to dial. For example, you can say "Call John Doe Work".

Add Names to Your UConnect™ Phonebook

- Press the “Phone” button to begin.
- After the “Ready” prompt, say “Phonebook New Entry”.
- Or, After the “Ready” prompt, say “Phonebook”.
- When prompted, say “New Entry”.
- When prompted, say the name of the new entry.
- Next, enter the number designation (e.g. “Home”, “Work”, “Mobile”, or “Pager”). This will allow you to have multiple numbers for each phonebook entry.
- Recite the phone number for the phonebook entry that you are adding.

After you are finished adding an entry into the phonebook, you will be given the opportunity to add more phone numbers to the current entry or to return to the main menu.

The UConnect™ system will allow you to enter up to 32 names into the phonebook with each name having up to four associated phone numbers and designations.

Edit Entries in the UConnect™ Phonebook

- Press the ‘Phone’ button to begin.
- After the “Ready” prompt, say “Phonebook Edit”.
- You will then be asked for the name of the phonebook entry that you wish to edit.
- Next, choose the number designation that you wish to edit. The choices are home, work, mobile, or pager.
- Recite the new phone number for the phonebook entry that you are editing.

After you are finished editing an entry in the phonebook, you will be given the opportunities to edit another entry in the phonebook, call the number you just edited, or return to the main menu.

Phonebook edit can be used to add another phone number to a name entry that already exists in the phonebook. For example, the entry John Doe may have a mobile and a home number, but you can add John Doe's work number later through phonebook edit.

Delete Entries in the UConnect™ Phonebook

- Press the 'Phone' button to begin.
- After the "Ready" prompt, say "Phonebook Delete".
- After you enter the phonebook delete menu, you will then be asked for the name of the phonebook entry that you wish to delete. You can either say the name of a phonebook entry that you wish to delete or you can say "List Names" to hear a list of the entries in the phonebook from which you can choose. To select one of the entries from the list, press the "Voice Recognition" button while the UConnect™ system is playing the desired entry and say "Delete".
- After you enter the name, the UConnect™ system will ask you if you wish to delete the home, work, mobile, or pager number for this entry.

Delete All Entries in the UConnect™ Phonebook

- Press the 'Phone' button to begin.
- After the "Ready" prompt, say "Phonebook Delete All".
- The UConnect™ system will ask you to verify that you wish to delete all the entries from the phonebook.
- After confirmation, the phonebook entries will be deleted.

List All Names in the UConnect™ Phonebook

- Press the 'Phone' button to begin.
- After the "Ready" prompt, say "Phonebook List Names".
- The UConnect™ system will play the names of all the phonebook entries.

- To call one of the names in the list, press the 'Voice Recognition' button during the playing of the desired name and say "Call".
- The UConnect™ system will then prompt you as to number designation you wish to call.
- The selected number will be dialed.

Phone Call Features

The following feature(s) can be accessed through the UConnect™ system if the feature(s) are available on your cellular service plan. For example, if your cellular service plan provides three-way calling, this feature can be accessed through the UConnect™ system.

Answer or Reject an Incoming Call - No Call Currently in Progress

When you receive a call on your cellular phone, the UConnect™ system will interrupt the stereo audio and will ask if you would like to answer the call by pressing the 'Phone' button. Press the 'Phone' button to answer the call. To reject the call, press the 'Phone' button until you hear a single beep indicating that the incoming call was rejected.

Answer or Reject an Incoming Call - Call Currently in Progress

If a call is currently in progress and you have another incoming call, press the 'Phone' button to place the current call on hold and answer the incoming call. To reject the incoming call, you can disregard the call and continue with your current conversation.

Making a Second Call while Current Call in Progress

To make a second call while you are currently in a call, press the 'Voice Recognition' button and say "Dial" or "Call" followed by the phone number or phonebook entry you wish to call. The first call will be on hold while the second call is in progress.

Putting a Call on Hold and Retrieving a Call from Hold

To put a call on hold, press the 'Phone' button until you hear a single beep which will indicate that the call has been placed on hold. To bring the call back from hold, press the 'Phone' button.

Toggling Between Two Calls

If two calls are in progress (one active and one on hold), press the 'Phone' button until you hear a single beep indicating that the active and hold status of the two calls have switched. Only one call can be placed on hold at one time.

Conference Call

When two calls are in progress (one active and one on hold), press the 'Phone' button until you hear a double beep indicating that the two calls have been joined into one conference call.

Three-Way Calling

To initiate three-way calling, press the 'Voice Recognition' button while a call is in progress and make a second phone call. When the second call is established, press the 'Phone' button until you hear a double beep indicating that the two calls have been joined into one conference call.

Call Termination

To end a call in progress, press the 'Phone' button. All calls in progress will be terminated.

Phone Redial

- Press the 'Phone' button to begin.
- After the "Ready" prompt, say "Redial".
- The UConnect™ system will call the last number that was dialed on your cellular phone. This may not be the last number dialed by your UConnect™ system.

Advanced Phone Connectivity

Transferring an Active Call between the UConnect™ System and Your Cellular Phone

The UConnect™ system allows ongoing calls to be transferred to your cellular phone or to the UConnect™ system without terminating the call. To transfer an ongoing call from your cellular phone to the UConnect™ system or vice versa, press the 'Voice Recognition' button and say "Transfer Call".

Delete Paired Cellular Phones

- Press the 'Phone' button to begin.
- After the "Ready" prompt, say "Setup".
- When prompted, say " Phone Pairing".
- At the next prompt, say "Delete".

- You will be asked to say the name of the phone that you wish to delete. You can either say the name of the phone that you wish to delete or you can say "All" to delete all the phones.

Connect or Disconnect the Connection between the UConnect™ System and Your Cellular Phone

Your cellular phone can be paired with many different electronic devices, but can only be actively "connected" with one electronic device at a time.

If you would like to connect or disconnect the Bluetooth™ connection between a paired cellular phone and the UConnect™ system, follow the instruction described in your cellular phone user's manual.

List Paired Cellular Phone Names

- Press the 'Phone' button to begin.
- After the "Ready" prompt, say "Setup List Phones" and the UConnect™ system will play the phone names of all paired cellular phones in order from highest priority to lowest priority.

Select a Lower Priority Paired Cellular Phone

- Press the 'Phone' button to begin.
- After the "Ready" prompt, say "Setup".
- When prompted, say "Select Phone".
- When prompted, say the phone name of the cellular phone you wish to use, or say "List Phones" to hear a list of all the phones that have been paired to your UConnect™ system. To select a phone from the list, press the 'Voice Recognition' button and say "Select".

- The lower priority phone will only be used for the next phone call. After that, the UConnect™ system will return to using the highest priority phone in the vehicle.

UConnect™ System Features**Barge In - Touch Tone Phone Inputs**

You can use your UConnect™ system to access a voice mail system, an automated service, or any other phone number that you can dial with any phone. When calling a number with your UConnect™ system that normally requires you to enter in a touch-tone sequence on your cellular phone keypad, you can push the 'Voice Recognition' button and say the sequence you wish to enter followed by "Send". For example, if required to enter your pin number, you can press the 'Voice Recognition' button and say "3 7 4 6 Send", or whatever you have made your pin. This method can also be used in instances where you

are pressing a number on your keypad to navigate through a menu structure or to enter a number for a pager.

Barge In - Overriding Prompts

The 'Voice Recognition' button can be used when you wish to skip part of a prompt and issue your voice recognition command immediately. For example, if a prompt is playing "Would you like to pair a phone, clear a...", you could press the 'Voice Recognition' button and say "Pair A Phone" to select that option without having to listen to the rest of the voice prompt.

Language Selection

To change the language that the UConnect™ system is using, press the 'Phone' button and say the name of the language you wish to switch to (English, Español, or Français as equipped). After selecting one of the languages, all prompts and voice commands will be in the selected language.

Turning Confirmation Prompts On/Off

Turning confirmation prompts off will stop the system from confirming your choices (e.g. the UConnect™ system will not repeat a phone number before you dial it).

- Press the 'Phone' button to begin.
- After the "Ready" prompt, say "Setup Confirmation". The UConnect™ system will play the current confirmation prompt status and you will be given the choice to change it.

Low Signal, Battery Strength, and Roam Notification

The UConnect™ system will provide notification to inform you if your cellular phone is in roaming status, has low signal strength, or has a low battery when you are trying to place a phone call.

Dialing Using the Cellular Phone Keypad

You can dial a phone number with your cellular phone keypad and still use the UConnect™ system. By dialing a number with your paired Bluetooth™ cellular phone, the audio will be played through your vehicle's stereo system. The UConnect™ system will work the same as if you dialed the number using voice recognition.

Mute/Unmute

When you mute the UConnect™ system, you will still be able to hear the conversation coming from the other party, but the other party will not be able to hear you. In order to mute the UConnect™ system press the 'Voice Recognition' button and say "Mute". In order to unmute the UConnect™ system; press the 'Voice Recognition' button and say "Unmute".

Help

If you need assistance at any prompt or if you want to know what your options are at any prompt, say "Help". The UConnect™ system will play all the options at any prompt if you ask for help.

Cancel

At any prompt, you can say "Cancel" and you will be returned to the previous menu.

Emergency Assistance

If you are in an emergency, say "Dial Emergency" or "Call Emergency" and the UConnect™ system will instruct your cellular phone to call 911.

Towing Assistance

If you need towing assistance, say "Dial Towing Assistance" or "Call Towing Assistance". Please refer to the 24-Hour Towing Assistance coverage details in the DaimlerChrysler Motors Company 24-Hour Towing Assistance Program Guide.

SEATS

The seating options available in this truck are the result of extensive customer research and evaluations.

WARNING!

It is extremely dangerous to ride in a cargo area, inside or outside of a vehicle. In a collision, people riding in these areas are more likely to be seriously injured or killed.

Do not allow people to ride in any area of your vehicle that is not equipped with seats and seat belts.

Be sure everyone in your vehicle is in a seat and using a seat belt properly.

WARNING!

Adjusting a seat while the vehicle is moving is dangerous. The sudden movement of the seat could cause you to lose control. The seat belt might not be properly adjusted and you could be injured. Adjust any seat only while the vehicle is parked.

WARNING!

You can be seriously, even fatally injured riding in a seat with the seatback reclined. Do not ride with the seatback reclined so that the shoulder belt is no longer resting against your chest. If you ride in this position, the shoulder harness will no longer be restraining you. In a collision you could slide under the seat belt and receive serious or fatal injuries. Recline in a seat only when the vehicle is parked.

40-20-40 Front Seat

As the name implies, the seat is divided into 3 segments. The outboard seat portions are each 40% of the total width of the seat. The back of the center portion (20%) easily folds down to provide an armrest/center storage compartment (if equipped).

Power Driver Seat

CAUTION!

Don't put anything under a power seat. It may cause damage to the seat controls.

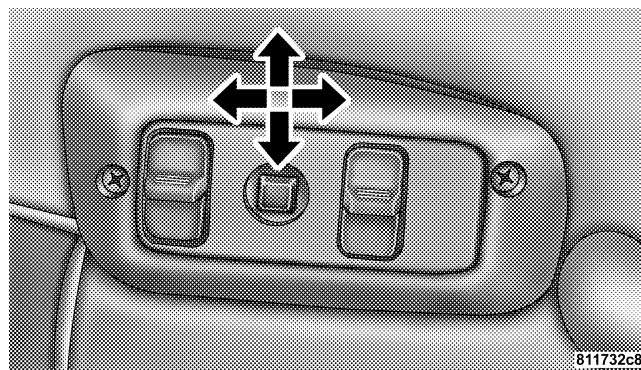
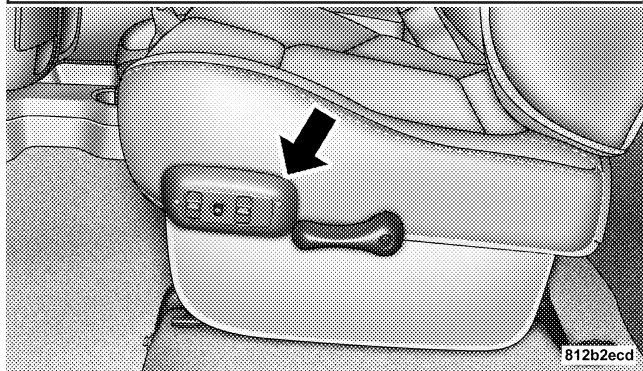

Up, Down, Forward, and Rearward

The power seat controls are on the outboard side of the front seat cushions. Three switches control the seat movement. The four-way switch in the center can be moved forward or backwards to get the most comfortable position. The same switch can be moved up and down to

control seat height. Change the seat angle by using the two toggle switches, tilting it up or down.

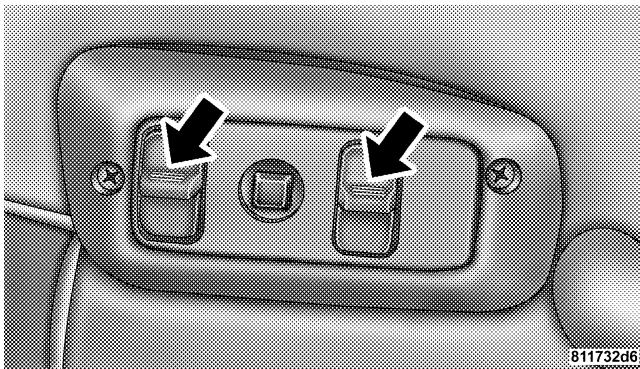

Tilt Adjustment

Manual Passenger Seat

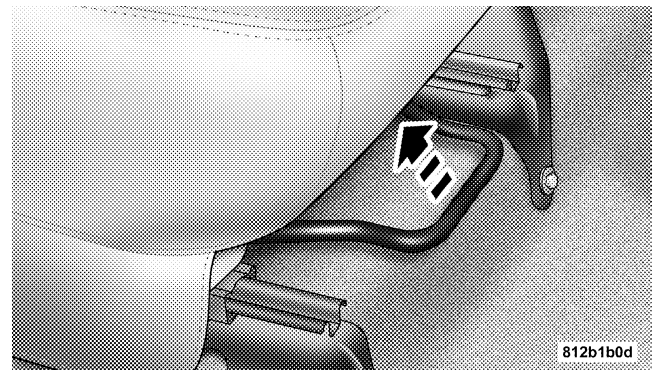

Passenger Side Manual

The passenger seat is adjustable forward or backward and is equipped with a back recliner.

Manual Seatback Recline

The recliner mechanism control is on the outboard side of the seat. To recline, lean forward slightly, lift the lever, then push back to the desired position and release the lever. Lean forward and lift the lever to return the seatback to its normal position. Using body pressure, lean forward and rearward on the seat to be sure the seatback has latched.

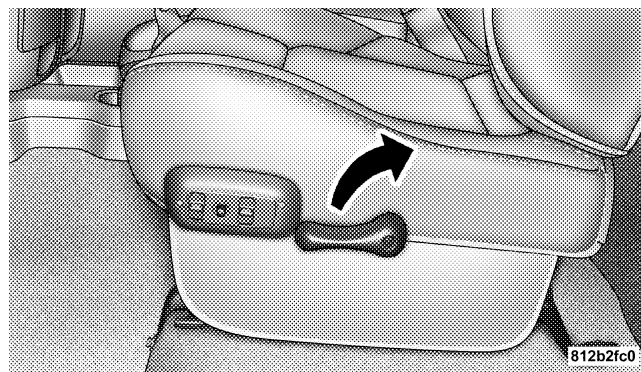

Manual Recline Lever

Adjustable Head Restraints

Head restraints can reduce the risk of whiplash injury in the event of impact from the rear. Pull up or push down on the restraints so that the upper edge is as high as practical, at least to the level of the ears.

To lower the head restraint, push in the button and then push down on the head restraint.

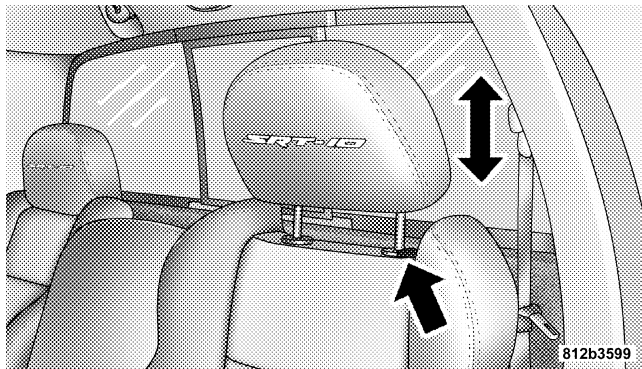

TO OPEN AND CLOSE THE HOOD

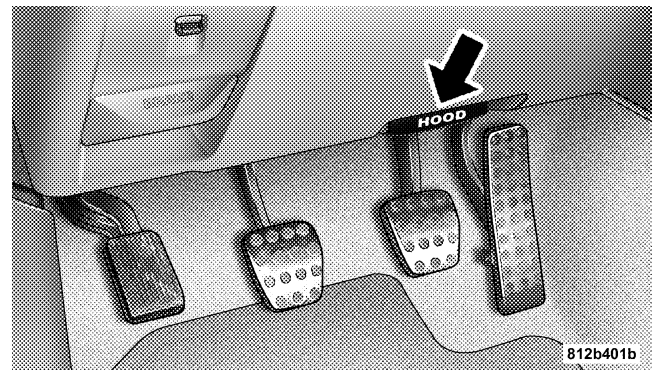

To open the hood, two latches must be released. First pull the hood release lever located below the steering wheel at the base of the instrument panel. Once the hood is released you must reach into the opening beneath the center of the grille and push up the latch to release the safety catch before raising the hood.

92 UNDERSTANDING THE FEATURES OF YOUR VEHICLE

To prevent possible damage, do not slam the hood to close it. Use a firm downward push at the front center of the hood to ensure that both latches engage.

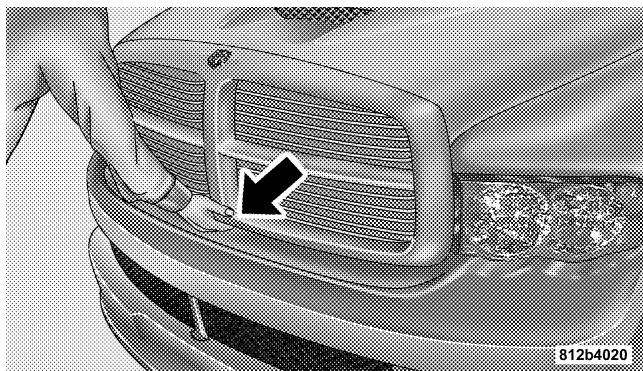

WARNING!

If the hood is not fully latched, it could fly up when the vehicle is moving and block your forward vision. Be sure all hood latches are latched fully before driving.

LIGHTS

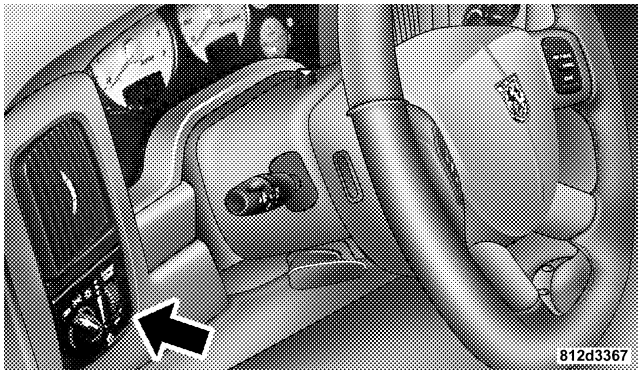

Interior Lights

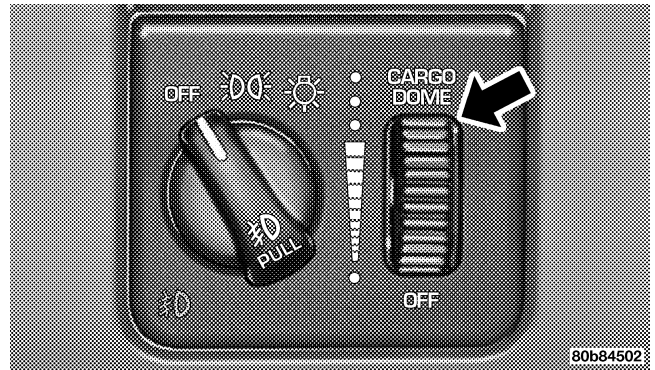

Courtesy/ dome lights are turned on when the front doors are opened, when the dimmer control (rotating wheel on the right side of the switch) is rotated to the second upward detent position, or if equipped, when the UNLOCK button is pressed on the key fob. Rotating the dimmer control to the optional fully upward position will

turn on the cargo light located on the back of the cab. When a door is open and the interior lights are on, rotating the dimmer control all the way down to the OFF detent will cause all the interior lights to go out. This is also known as the "Party" mode because it allows the doors to stay open for extended periods of time without discharging the vehicle's battery.

The brightness of the instrument panel lighting can be regulated by rotating the dimmer control up (brighter) or down (dimmer). When the headlights are ON you can supplement the brightness of the odometer, trip odometer, radio and overhead console by rotating the control up until you hear a click. This feature is termed the "Parade" mode and is useful when headlights are required during the day.

Battery Saver

To protect the life of your vehicle's battery, Load Shedding is provided for both the interior and exterior lights.

If the ignition is off and any door is left ajar for 15 minutes or the dimmer control is rotated upwards for 15 minutes, the interior lights will automatically turn off.

If the headlamps remain on while the ignition is cycled off, the exterior lights will automatically turn off after 5 minutes. After 5 minutes timeout, if the headlamp switch is turned off and then turned on, the exterior lights will automatically turn off after 15 minutes.

If the dimmer control is rotated to the cargo lamp position with the ignition off, the cargo lamps will automatically turn off after 15 minutes.

NOTE: Battery Saver mode is cancelled if the ignition is ON.

Headlamp Delay — If Equipped

To aid in your exit, your vehicle, if equipped, can be programmed by your dealer with a headlamp delay that will leave the headlamps on for 0, 30, 60, or 90 seconds. This delay is initiated when the ignition is turned OFF while the headlamp switch is on, and then the headlamp switch is cycled off. The headlamps will remain on for 60 seconds. Headlamp delay can be cancelled by either turning the headlamp switch ON then OFF or by turning the ignition ON.

Headlights, Parking Lights, Panel Lights

 When the headlight switch is rotated to the first position, the parking lights, taillights, side marker lights, license plate light and instrument panel lights are all turned on. The headlights will turn ON when the switch is rotated to the second position. The "LAMP OUT" indicator will be illuminated in the instrument cluster if a defective bulb or wiring circuit is detected for the headlamp system.

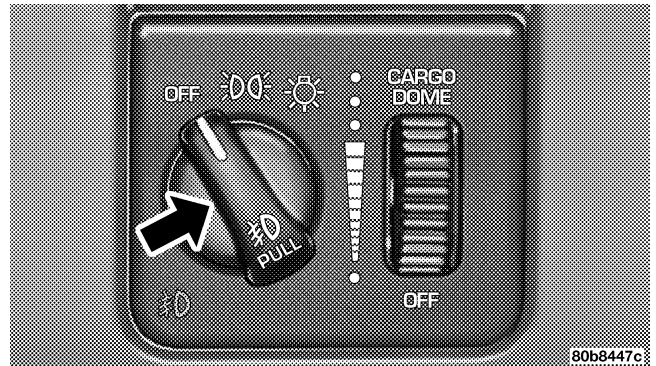

3

Your vehicle is equipped with plastic headlight lenses that are lighter and less susceptible to stone breakage than glass headlights.

Plastic is not as scratch resistant as glass and therefore different lens cleaning procedures must be followed.

To minimize the possibility of scratching the lenses and reducing light output, avoid wiping with a dry cloth. To remove road dirt, wash with a mild soap solution followed by rinsing.

Do not use abrasive cleaning components, solvents, steel wool or other abrasive materials to clean the lenses.

Daytime Running Lights (Canada and Fleet Vehicles Only)

The headlights on your vehicle will illuminate when the engine is started. This provides a constant "Lights ON" condition until the ignition is turned OFF. The lights illuminate at less than normal intensity. If the parking brake is applied the Daytime Running Lights will turn off.

Lights-on Reminder

If the headlights, parking lights, courtesy lights or cargo lights are left on, after the ignition is turned off, a continuous chime will sound when the driver's door is opened.

Fog Lights

The foglights are turned ON by placing the headlight rotary control in the parking light or headlight position and pulling out the headlight rotary control. The fog lights will operate only when the parking lights are ON or when the vehicle headlights are ON low beam. An indicator light located left of the switch will illuminate when the fog lights are on. The fog lights will turn off when the switch is pressed in, when the headlight switch is rotated to the OFF position or the high beam is selected.

CARGO LIGHT

The cargo lights are turned on by rotating the dimmer control to the optional fully upward position. The cargo lights will also turn on for 30 seconds when a key fob Unlock is pressed, as part of the illuminated entry feature.

MULTIFUNCTION CONTROL LEVER

The multifunction control lever is located on the left side of the steering column.

Turn Signals

Move the lever up or down to signal a right-hand or left-hand turn.

The arrow on either side of the instrument cluster flashes to indicate the direction of the turn, and proper operation of the front and rear turn signal lights. If a defective bulb or wiring circuit is detected for the turn signal system, the arrow indicators will flash at a faster rate. Also, the "LAMP OUT" indicator in the instrument cluster will be

illuminated and a chime will be heard. If an indicator fails to light when the lever is moved, it would suggest that the switch or indicator lamp is defective.

You can signal a lane change by moving the lever partially up or down.

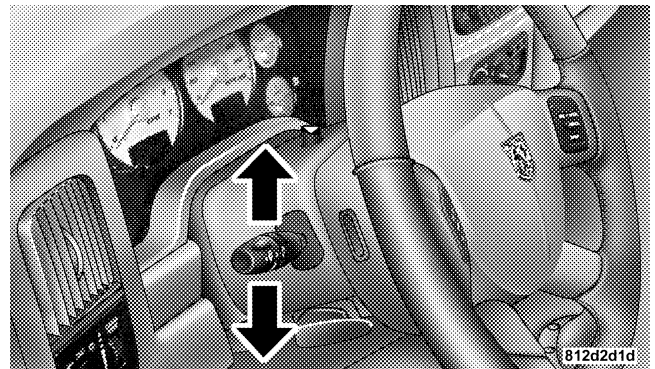

Passing Light

You can signal another vehicle with your headlights by partially pulling the multifunction lever toward the steering wheel. This will cause the high beam headlights to turn on until the lever is released.

High Beam / Low Beam Select Switch

Pull the multifunction control lever fully toward the steering wheel to switch the headlights from HIGH or LOW beam.

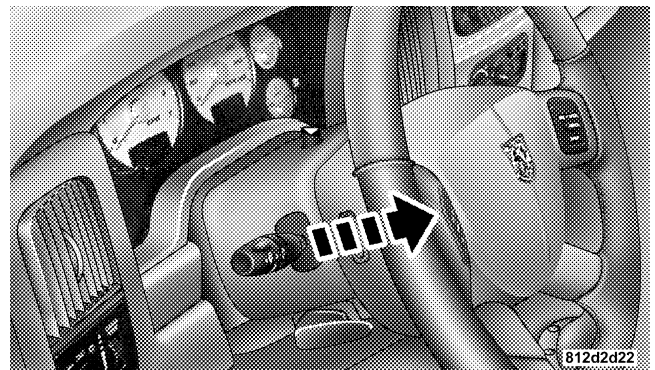

Windshield Wipers

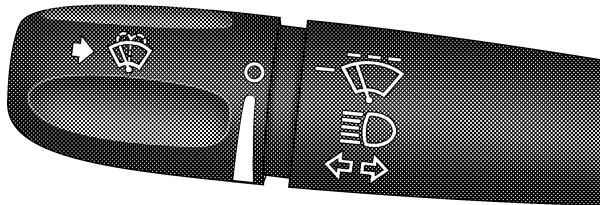

80d06ac5

The wipers and washers are operated by a switch in the multifunction control lever. Turn the end of the handle to select the desired wiper speed.

Intermittent Wiper System

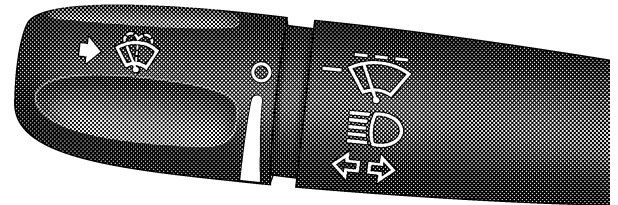

3

80d06ac5

The intermittent feature of this system was designed for use when weather conditions make a single wiping cycle, with a variable pause between cycles, desirable. For maximum delay between cycles, rotate the control knob into the upper end of the delay range.

The delay interval decreases as you rotate the knob until it enters the LO continual speed position. The delay can be regulated from a maximum of about 15 seconds between cycles, to a cycle every 2 seconds. The delay intervals will double in duration when the vehicle speed is 10 mph (16 km) or less.

WARNING!

Sudden loss of visibility through the windshield could lead to an accident. You might not see other vehicles or other obstacles. To avoid sudden icing of the windshield during freezing weather, warm the windshield with defroster before and during windshield washer use.

Windshield Washers

To use the washer, push in on the washer knob on the end of the multifunction control lever and hold while spray is desired. If the washer knob is depressed while in the delay range, the wiper will operate for several seconds after the washer knob is released. It will then resume the intermittent interval previously selected. If the washer knob is pushed, for a period greater than 1 second, while in the OFF position, the wiper will wipe approximately three wipes, after the wash knob is released.

To prevent freeze-up of your windshield washer system in cold weather, select a solution or mixture that meets or exceeds the temperature range of your climate. This rating information can be found on most washer fluid containers.

TILT STEERING COLUMN

To tilt the column, push down on the lever below the turn signal control and move the wheel up or down, as desired. Push the lever back up to lock the column firmly in place.

**WARNING!**

Tilting the steering column while the vehicle is moving is dangerous. Without a stable steering column, you could lose control of the vehicle and have an accident. Adjust the column only while the vehicle is stopped. Be sure it is locked before driving.

DRIVER ADJUSTABLE PEDALS

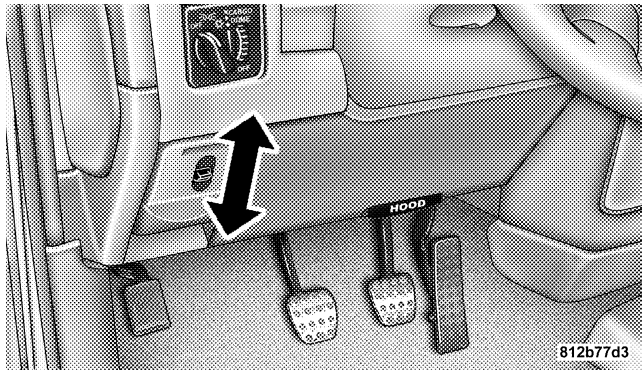

The power adjustable accelerator and brake pedals allow the driver to establish a comfortable position relative to the steering wheel and pedals.

Adjustment

1. Position the driver seat so that you are at least 10 inches (254 mm) away from the airbag located in the center of the steering wheel.
2. Fasten and adjust the seatbelts.
3. Move the adjustable pedal switch, located to the left of the steering column near the parking brake release, in the direction you desire to move the pedals.
4. The pedals **cannot** be adjusted when the vehicle is in R (Reverse) or when the Speed Control is SET.

CAUTION!

Do not place any article under the adjustable pedals or impede its ability to move as it may cause damage to the pedal controls. Pedal travel may become limited if movement is stopped by an obstruction in the adjustable pedal's path.

ELECTRONIC SPEED CONTROL

When engaged, this device takes over accelerator operation at speeds greater than 35 mph (56 km/h). The controls are mounted on the steering wheel.

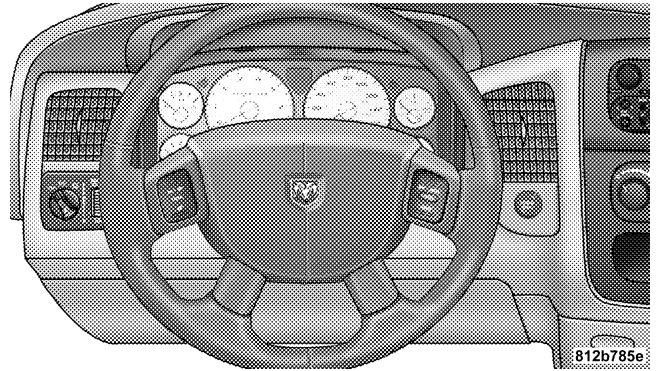

To Activate

Push the ON/OFF button to the ON position. In the instrument cluster, the word "CRUISE" illuminates when the system is on.

To Set At A Desired Speed

When the vehicle has reached the desired speed, press and release the SET button. Release the accelerator and the vehicle will operate at the selected speed.

To Deactivate

A soft tap on the brake pedal, normal braking, clutch pressure while slowing the vehicle, or pressing the CANCEL button will deactivate speed control without erasing the memory. Pushing the ON/OFF button to the OFF position or turning off the ignition erases the memory.

WARNING!

Leaving the Speed Control ON when not in use is dangerous. You could accidentally set the system to cause it to go faster than you want. You could lose control and have an accident. Always leave the system OFF when you aren't using it.

To Resume Speed

To resume a previously set speed, push and release the RESUME button. Resume can be used at any speed above 30 mph (50 km/h).

To Vary The Speed Setting

When the speed control is on, speed can be increased by pressing and holding the ACCEL button. When the button is released, a new set speed will be established.

Tapping the ACCEL button once will result in a speed increase of 2 mph (3 km/h). Each time the button is

tapped, speed increases so that tapping the button three times will increase speed by three increments.

Tapping the COAST button once will result in a speed decrease of 1 mph (2 km/h). Each time the button is tapped, speed will decrease. For example, tapping the button 3 times will decrease the speed by 3 mph (6 km/h).

To decrease speed while the speed control is on, press and hold the COAST button. Release the button when the desired speed is reached, and the new speed will be set.

To Accelerate For Passing

Depress the accelerator as you would normally. When the pedal is released, the vehicle will return to the set speed.

NOTE: When driving uphill, at elevations above 2,000 feet (610 meters), or when the vehicle is heavily loaded the vehicle may slow below the SET speed. If the vehicle speed drops below (refer to the table below for the speed

for your specific engine), the speed control will automatically disengage. If this happens, you can push down on the accelerator pedal to maintain the desired speed.

Vehicles equipped with a 6-speed-manual transmission should be operated in 5th gear or lower under the above conditions.

WARNING!

Speed Control can be dangerous where the system can't maintain a constant speed. Your vehicle could go too fast for the conditions, and you could lose control. An accident could be the result. Don't use Speed Control in heavy traffic or on roads that are winding, icy, snow-covered, or slippery.

OVERHEAD CONSOLE

The overhead console consists of the following features:

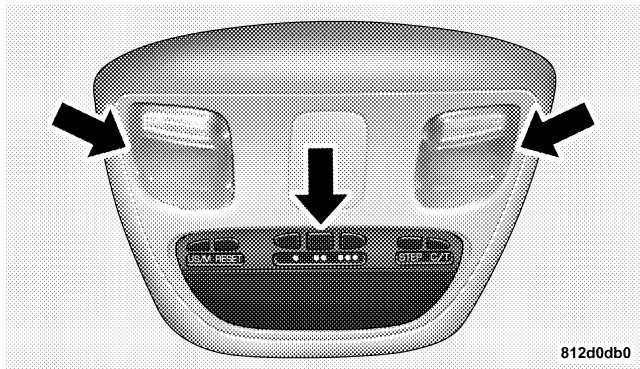

- Courtesy/Reading Lights
- Compass/Temperature Mini-Trip Computer (CMTC)
- Universal Garage Door Opener

Courtesy/Reading Lights

In the middle of the console are two courtesy/reading lights.

Both lights illuminate as courtesy lights when a door is opened, when the dimmer control is rotated to the courtesy light position (fully upward position), or when the UNLOCK button is pressed on the Remote Keyless Entry transmitter, if so equipped. These lights are also operated individually as reading lights by pressing the recessed area of the corresponding lens.

NOTE: The courtesy/reading lights will remain on until the switch is pressed a second time, so be sure they have been turned off before leaving the vehicle. If the interior lights are left on after the vehicle is turned off, they will extinguish after 15 minutes.

COMPASS/TEMPERATURE MINI-TRIP COMPUTER

This overhead console consists of the following:

- Courtesy Lights
- Compass/Temperature Mini-Trip Computer
- Universal Garage Door Opener

This overhead console allows you to choose between a compass/temperature display and one of four trip conditions being monitored.

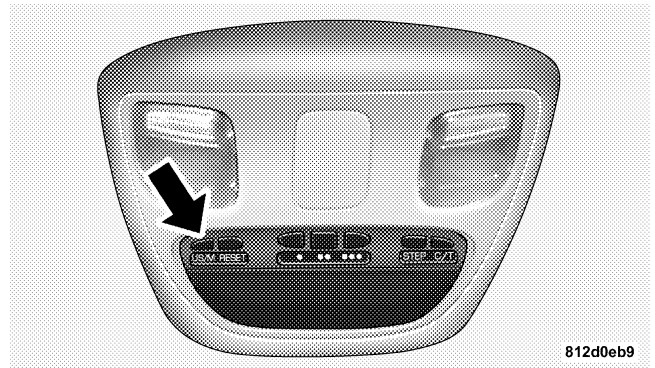
US/M Button

Use this button to change the display from U.S. to metric measurement units.

RESET Button

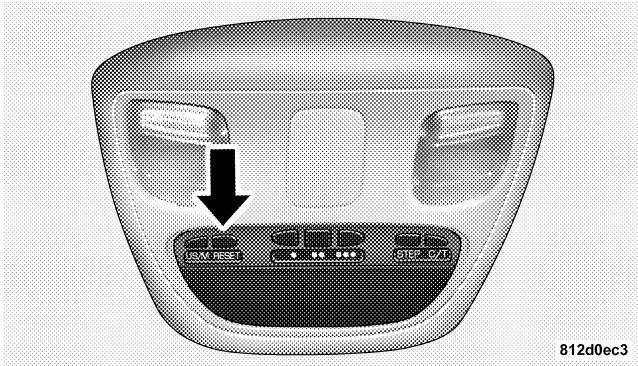

812d0ec3

Use this button to reset the following displays to zero:
Average Fuel Economy
Trip Odometer
Elapsed time

Global Reset

If the RESET button is pressed twice within 4 seconds while in any of the 3 resettable displays, the Global Reset will reset all 3 displays.

Step Button

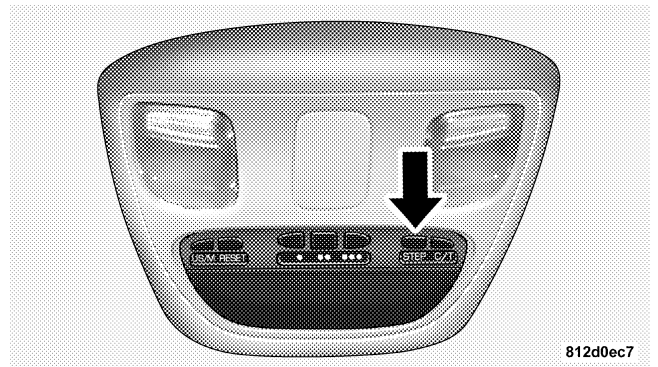

812d0ec7

Use this button to choose or cycle through the four trip conditions.

Average Fuel Economy (AVG ECO)

Shows the average fuel economy since the last reset. This display mode becomes less sensitive to instantaneous changes in fuel consumption as the number of total vehicle miles since the last reset increases. It is suggested that this mode be reset periodically for general operation or when driving conditions change significantly (for example, at the end of a trip or when a trailer is connected or disconnected) to make the displayed average fuel economy a more meaningful number.

Distance To Empty (DTE)

Shows the estimated distance that can be travelled with the fuel remaining in the tank. The estimated distance is determined by a weighted average of the instantaneous and average fuel economy, according to the current fuel tank level.

When Distance To Empty = 0, the fuel gauge pointer will initially be on the left edge of the red "E" marker. At this point (fuel gauge pointer on the left edge of the red "E" marker) there is reserve fuel capacity, which corresponds to approximately 8% of tank volume. This reserve capacity was put in place to prevent the likelihood of customers running out of fuel when operating at maximum load conditions in areas where there aren't many gas stations.

NOTE: The Distance To Empty will remain equal to zero, until the vehicle runs out of fuel or is refueled.

Ram SRT-10 fuel tank volume is as follows:

- 26 gallons

Trip Odometer (ODO)

This display shows the distance traveled since the last reset.

Elapsed Time (ET)

This display shows the accumulated ignition ON time since the last reset.

C/T Button

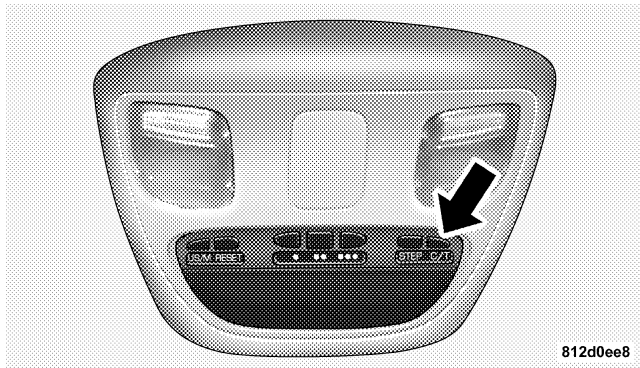

Use this button to select a readout of the outside temperature and one of eight compass headings that indicate the direction in which the vehicle is facing.

WARNING!

Even if the display still reads a few degrees above 32°F (0°C), the road surface may be icy, particularly in woods or on bridges. Drive carefully under such conditions to prevent an accident and possible personal injury or property damage.

Automatic Compass Calibration

This compass is self-calibrating which eliminates the need to manually set the compass. When the vehicle is new, the compass may appear erratic and the CAL symbol will be displayed.

After completing one 360° turn, with the vehicle traveling less than 5 mph (8 km/h), in an area free from large metal or metallic objects, the CAL symbol will turn off and the compass will function normally.

Manual Compass Calibration

NOTE: To ensure proper compass calibration, make sure the compass variance is properly set before manually calibrating the compass.

If the compass appears erratic and the CAL symbol does not appear, you must manually put the compass into the "Calibration" mode.

To Put Into a Calibration Mode

Turn on the ignition and set the display to "Compass/Temperature." Press and hold the RESET button to change the display between VAR (compass variance) and CAL (compass calibration) modes. When the CAL symbol is displayed complete one 360 degree turn in an area free from large metal objects or power lines. The CAL

symbol will turn off and the compass will function normally.

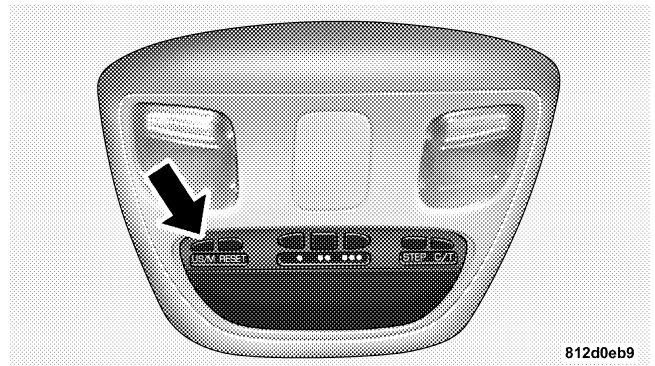

812d0eb9

Compass Variance is the difference between magnetic north and geographic north. In some areas of the country, the difference between magnetic and geographic north is great enough to cause the compass to give false readings. If this occurs, the compass variance must be set according to the Compass Variance Map.

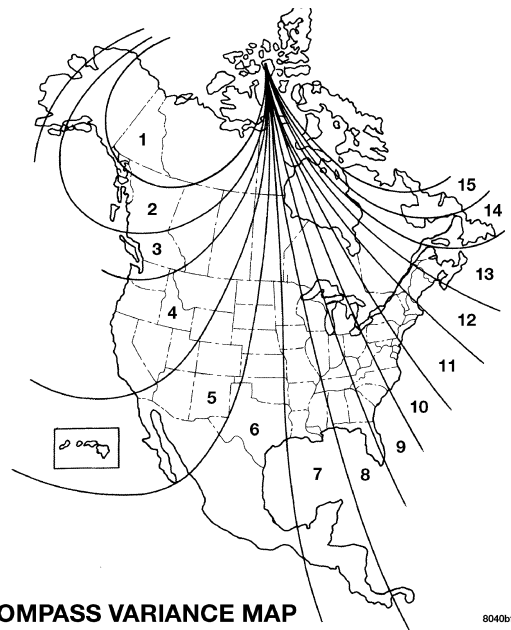

To set the variance: Turn the ignition ON and set the display to “Compass/Temperature.” Press the RESET button approximately five seconds. The last variance zone number will be displayed. Press the STEP button to select the new variance zone and press the RESET button to resume normal operation.

Outside Temperature

Because the ambient temperature sensor is located underhood, engine temperature can influence the displayed temperature, therefore, temperature readings are slowly updated when the vehicle speed is below 20 mph (30 km/h) or during stop and go driving.

GARAGE DOOR OPENER

The HomeLink® Universal Transceiver replaces up to three remote controls (hand held transmitters) that operate devices such as garage door openers, motorized gates, or home lighting. It triggers these devices at the push of a button. The Universal Transceiver operates off your vehicle’s battery and charging system; no batteries are needed.

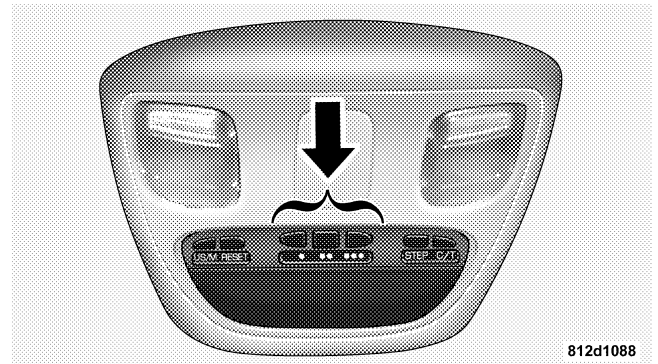

812d1088

For additional information on HomeLink®, call 1-800-355-3515, or on the internet at www.homelink.com.

WARNING!

A moving garage door can cause injury to people and pets in the path of the door. People or pets could be seriously or fatally injured. Only use this transceiver with a garage door opener that has a "stop and reverse" feature as required by federal safety standards. This includes most garage door opener models manufactured after 1982. Do not use a garage door opener without these safety features it could cause injury or death. Call toll-free 1-800-355-3515 or, on the Internet at www.homelink.com for safety information or assistance.

Programming HomeLink

NOTE: When programming a garage door opener, it is advised to park outside the garage. Some vehicles may require the ignition switch to be turned to the second (or "accessories") position for programming and/or operation of HomeLink. It is also recommended that a new battery be placed in the hand-held transmitter of the device being programmed to HomeLink for quicker training and accurate transmission of the radio-frequency signal.

1. Press and hold the two outer HomeLink buttons, and release only when the indicator light begins to flash (after 20 seconds). **Do not** hold the buttons for longer than 30 seconds and **do not** repeat step one to program a second and/or third hand-held transmitter to the remaining two HomeLink buttons.

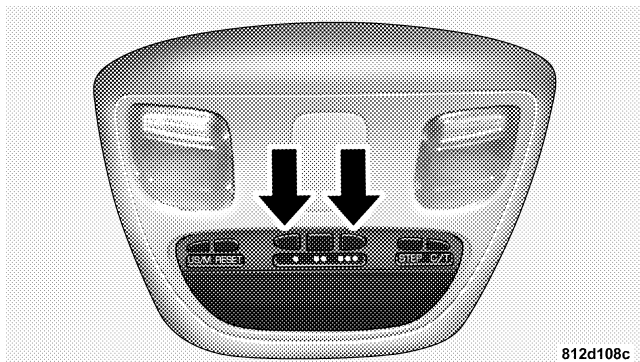

812d108c

WARNING!

Vehicle exhaust contains carbon monoxide, a dangerous gas. Do not run the vehicle's exhaust while training the transceiver. Exhaust gas can cause serious injury or death.

WARNING!

Your motorized door or gate will open and close while you are training the Universal Transceiver. Do not train the transceiver if people or pets are in the path of the door or gate. A moving door or gate can cause serious injury or death to people and pets or damage to objects.

3

2. Position the end of your hand-held transmitter 1-3 inches (3-8 cm) away from the HomeLink buttons while keeping the indicator light in view.
3. Simultaneously press and hold both the HomeLink button that you want to train and the hand-held transmitter buttons. Do not release the buttons until step 4 has been completed.

NOTE: Some gate operators and garage door openers may require you to replace this Programming Step 3 with procedures noted in the "Gate Operator/Canadian Programming" section.

4. The HomeLink indicator light will flash slowly and then rapidly after HomeLink successfully receives the frequency signal from the hand-held transmitter. Release both buttons after the indicator light changes from the slow to the rapid flash.

5. Press and hold the just trained HomeLink button and observe the indicator light. If the indicator light **stays on constantly, programming is complete** and your device should activate when the HomeLink button is pressed and released.

NOTE: To program the remaining two HomeLink buttons, begin with "Programming" **step two. Do not repeat step one.**

If the indicator light blinks **rapidly for two seconds and then turns to a constant light, continue with "Programming" steps 6-8** to complete the programming of a rolling code equipped device (most commonly a garage door opener).

6. At the garage door opener receiver (motor-head unit) in the garage, locate the "learn" or "smart" button. This can usually be found where the hanging antenna wire is attached to the motor-head unit.

7. Firmly press and release the "learn" or "smart" button. (The name and color of the button may vary by manufacturer.)

NOTE: There are 30 seconds in which to initiate step eight.

8. Return to the vehicle and firmly **press, hold for two seconds and release** the programmed HomeLink button. Repeat the "**press/hold/release**" sequence a second time, and, depending on the brand of the garage door opener (or other rolling code equipped device), repeat this sequence a third time to complete the programming.

HomeLink should now activate your rolling code equipped device.

NOTE: To program the remaining two HomeLink buttons, begin with "Programming" **step two. Do not repeat step one.** For questions or comments, please contact HomeLink at www.homelink.com or 1-800-355-3515.

Canadian Programming/Gate Programming

Canadian radio-frequency laws require transmitter signals to "time-out" (or quit) after several seconds of transmission which may not be long enough for HomeLink to pick up the signal during programming.

Similar to this Canadian law, some U.S. gate operators are designed to "time-out" in the same manner.

If you live in Canada or you are having difficulties programming a gate operator by using the "Programming" procedures (regardless of where you live), **replace "Programming HomeLink" step 3** with the following:

NOTE: If programming a garage door opener or gate operator, it is advised to unplug the device during the "cycling" process to prevent possible overheating.

3. Continue to press and hold the HomeLink button while you **press and release every two seconds** ("cycle") your hand-held transmitter until the frequency signal has successfully been accepted by HomeLink. (The indicator light will flash slowly and then rapidly.) Proceed with "Programming" step four to complete.

Using HomeLink

To operate, simply press and release the programmed HomeLink button. Activation will now occur for the trained device (i.e. garage door opener, gate operator, security system, entry door lock, home/office lighting, etc.). For convenience, the hand-held transmitter of the device may also be used at any time. In the event that there are still programming difficulties or questions, contact HomeLink at: www.homelink.com or 1-800-355-3515.

Erasing HomeLink Buttons

To erase programming from the three buttons (individual buttons cannot be erased but can be "reprogrammed" - note below), follow the step noted:

- Press and hold the two outer HomeLink buttons until the indicator light begins to flash-after 20 seconds. Release both buttons. Do not hold for longer than 30 seconds. HomeLink is now in the train (or learning) mode and can be programmed at any time beginning with "Programming" - step 2.

Reprogramming a Single HomeLink Button

To program a device to HomeLink using a HomeLink button previously trained, follow these steps:

1. Press and hold the desired HomeLink button. **Do NOT** release the button.
2. The indicator light will begin to flash after 20 seconds. Without releasing the HomeLink button, proceed with "Programming" step 2

For questions or comments, contact HomeLink at: www.homelink.com or 1-800-355-3515.

Security

If you sell your vehicle, be sure to erase the frequencies.

To erase all of the previously trained frequencies, hold down both outside buttons until the green light begins to flash.

This device complies with part 15 of FCC rules and with RSS-210 of Industry Canada. Operation is subject to the following conditions:

- This device may not cause harmful interference.
- This device must accept any interference that may be received including interference that may cause undesired operation.

NOTE: Changes or modifications not expressly approved by the party responsible for compliance could void the user's authority to operate the equipment.

HomeLink® is a trademark owned by Johnson Controls, Inc.

POWER SUNROOF — IF EQUIPPED

The power sunroof switch is located between the sun visors on the overhead console.

WARNING!

- Never leave children in a vehicle, with the keys in the ignition switch. Occupants, particularly unattended children, can become entrapped by the power sunroof while operating the power sunroof switch. Such entrapment may result in serious injury or death.
- In an accident, there is a greater risk of being thrown from a vehicle with an open sunroof. You could also be seriously injured or killed. Always fasten your seat belt properly and make sure all passengers are properly secured too.
- Do not allow small children to operate the sunroof. Never allow fingers or other body parts, or any object to project through the sunroof opening. Injury may result.

Opening Sunroof - Express

Press the switch rearward and release, and the sunroof will open automatically from any position. The sunroof will open fully, then stop automatically. This is called Express Open. During Express Open operation, any movement of the sunroof switch will stop the sunroof.

Closing Sunroof - Express

Press the switch forward and release, and the sunroof will close automatically from any position. The sunroof will close fully and stop automatically. This is called Express Close. During Express Close operation, any movement of the switch will stop the sunroof.

Pinch Protect Feature

This feature will detect an obstruction in the opening of the sunroof during Express Close operation. If an obstruction in the path of the sunroof is detected, the

sunroof will automatically retract. Remove the obstruction if this occurs. Next, press the switch forward and release to Express Close.

Pinch Protect Override

If a known obstruction (ice, debris, etc.) prevents closing, press the switch forward and hold for two seconds after the reversal occurs. This allows the sunroof to move towards the closed position.

NOTE: Pinch protection is disabled while the switch is pressed.

Venting Sunroof - Express

Press and release the "V" button, and the sunroof will open to the vent position. This is called Express Vent, and will occur regardless of sunroof position. During Express Vent operation, any movement of the switch will stop the sunroof.

Sunshade Operation

The sunshade can be opened manually. However, the sunshade will open automatically as the sunroof opens.

NOTE: The sunshade cannot be closed if the sunroof is open.

Wind Buffeting

Wind buffeting can be described as the perception of pressure on the ears or a helicopter type sound in the ears. Your vehicle may exhibit wind buffeting with the windows down, or the sunroof (if equipped) in certain open or partially open positions. This is a normal occurrence and can be minimized. If the buffeting occurs with the rear windows open, open the front and rear windows together to minimize the buffeting. If the buffeting occurs with the sunroof open, adjust the sunroof opening to minimize the buffeting or open any window.

Sunroof Maintenance

Use only a non-abrasive cleaner and a soft cloth to clean the glass panel.

Ignition Off Operation

The power sunroof switches remain active for 10 minutes after the ignition switch has been turned off. Opening either front door will cancel this feature.

Sunroof Fully Closed

Press the switch forward and release to ensure that the sunroof is fully closed.

ELECTRICAL POWER OUTLETS

The auxiliary electrical outlets can provide power for in cab accessories designed for use with the standard “cigar lighter” plugs.

One of the outlets is the cigar lighter outlet, located in the instrument panel below the ash receiver. This outlet has a fused direct feed from the battery so it receives power whether the ignition is ON or OFF.

All accessories connected to this outlet should be removed or turned OFF when the vehicle is not in use to protect the battery against discharge.

There is an additional Pop-Up Power Outlet in the center console ahead of the shifter lever. This outlet is powered only when the ignition switch is in the On or Accessories position.

CAUTION!**Direct Battery Fed Electrical Outlet(s) Use With Engine Off**

- Many accessories that can be plugged in draw power from the vehicle’s battery, even when not in use (i.e. cellular phones, etc.). Eventually, if plugged in long enough, the vehicle’s battery will discharge sufficiently to degrade battery life and/or prevent engine starting.
- Accessories that draw higher power (i.e. coolers, vacuum cleaners, lights, etc.), will discharge the battery even more quickly. Only use these intermittently and with greater caution.
- After the use of high power draw accessories, or long periods of the vehicle not being started (with accessories still plugged in), the vehicle must be driven a sufficient length of time to allow the generator to recharge the vehicle’s battery.

CIGAR LIGHTER AND ASH RECEIVER

The ash receiver is opened and closed by **pushing** on the front surface of the receiver and then allowing the receiver to open.

The cigar lighter is located in the instrument panel below the ash receiver.

NOTE: This outlet has a fused direct feed from the battery so it receives power whether the ignition is ON or OFF. Leaving items such as cell phones in this outlet when the engine is not running will cause the battery to run down.

It heats when pushed in and pops out automatically when ready for use. **To preserve the heating element, do not hold the lighter in the heating position.**

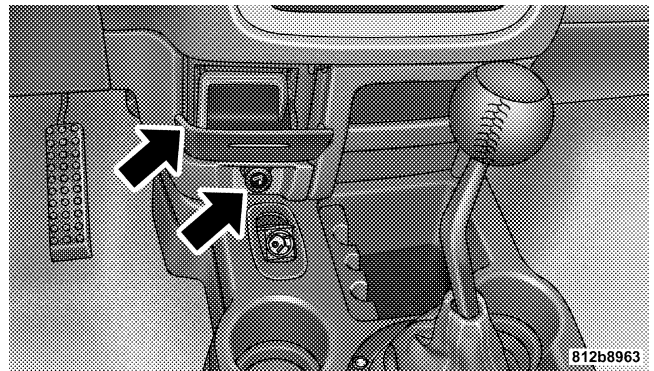

CUPHOLDERS

Front Cupholders

The cupholders consist of two cupwells for passenger convenience.

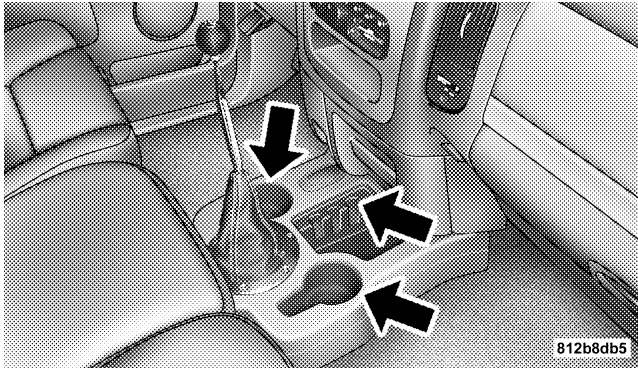

STORAGE

Center Storage Compartment

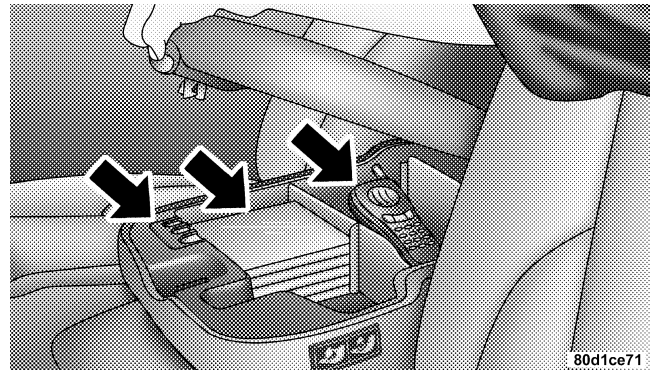

The center portion of the seat folds down to provide an armrest with unique storage compartments under the lid. Push the button on the front of the armrest to raise the cover. Inside there is a power outlet (if equipped), removable coin holder (if equipped), and two dividers to

configure the storage area into compartments. For example, compartments can be configured to hold a lap-top computer, a cellular telephone, CD's and miscellaneous items. The top of the cover provides a generous firm surface to serve as a desktop for your "mobile office."

WARNING!

- This armrest is not a seat. Anyone seated on the armrest could be seriously injured during vehicle operation, or an accident. Only use the center seating position when the armrest is fully upright.
- In an accident, the latch may open if the total weight of the items stored exceeds about 10 lbs (4.5 kg). These items could be thrown about endangering occupants of the vehicle. Items stored should not exceed a total of 10 lbs (4.5 kg).

Storage and Seats

Located in the center of the front 40/20/40 seat cushion below the armrest storage is a second storage compartment. This lower bin of the 20% seat has additional storage and for the vehicles equipped with the RDQ audio system (if equipped) it will also contain the sub-woofer audio amplifier in the lower bin.

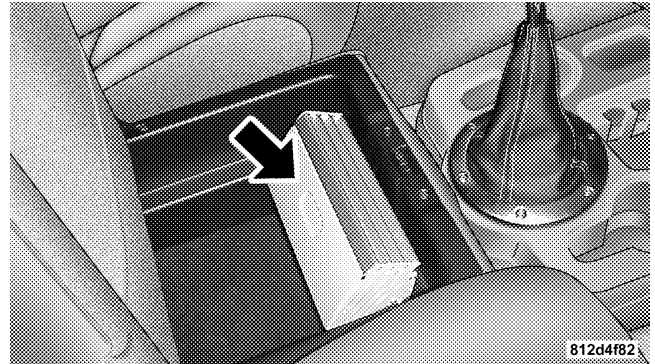

There is also storage behind the seat. This storage area contains the 10 inch subwoofer (if equipped).

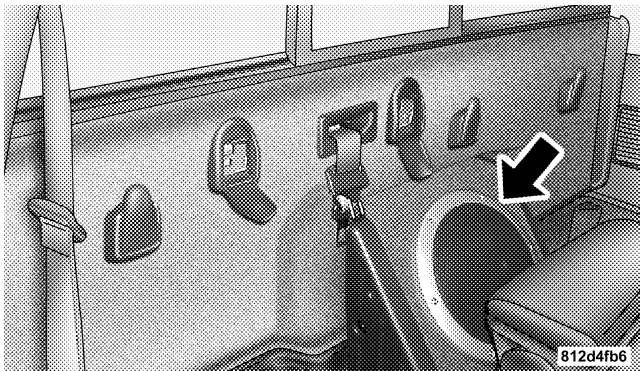

PICKUP BOX

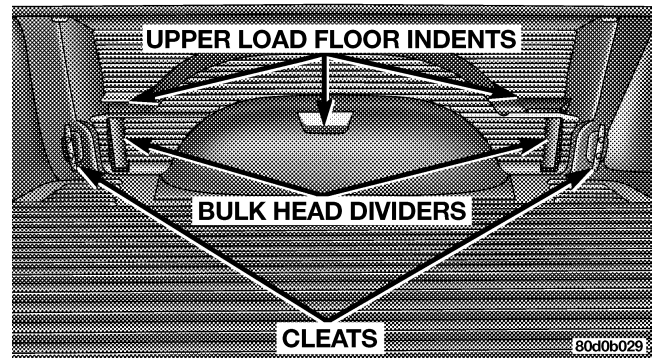

The pickup box on your new Ram has many features designed for utility and convenience.

NOTE: If you are installing a toolbox to the front of the pickup box, you must use Mopar® toolbox brackets available from your dealer.

You can carry wide building materials (sheets of plywood, etc.) by building a raised load floor. Place lumber across the box in the indentations provided above the wheel housings and in the bulkhead dividers to form the floor.

WARNING!

The pickup box is intended for load carrying purposes only, not for passengers, who should sit in seats and use seat belts.

WARNING!

- Care should always be exercised when operating a vehicle with unrestrained cargo. Vehicle speeds may need to be reduced. Severe turns or rough roads may cause shifting or bouncing of the cargo that may result in vehicle damage. If wide building materials are to be frequently carried, the installation of a support is recommended. This will restrain the cargo and transfer the load to the pickup box floor.
- If you wish to carry more than 600 lbs (272 kg) of material suspended above the wheelhouse, supports must be installed to transfer the weight of the load to the pickup box floor or vehicle damage may result. The use of proper supports will permit loading up to the rated payload.
- Unrestrained cargo may be thrown forward in an accident causing serious or fatal injury.

There are stampings in the sheet metal on the inner side bulkheads of the box in front of and behind both wheel housings. Place wooden boards across the box from side to side to create separate load compartments in the pickup box.

There are four tie-down cleats bolted to the lower sides of the pickup box that can sustain loads up to 1000 lbs (450 kg) total.

SLIDE-IN CAMPERS

DO NOT use slide-in campers on SRT-10 models.

EASY-OFF TAILGATE

Unlatch the tailgate and remove the support cables by releasing the lock tang from the pivot, then rotate and pull away from the box. Once the cables are free, move to the right side of the tailgate hinge bracket.

Raise the right side of the tailgate until the right side pivot clears the hanger bracket. Slide the entire tailgate to the right to free the left side pivot. Remove the tailgate from the vehicle entirely. Do not carry the tailgate loose in the truck pickup box.

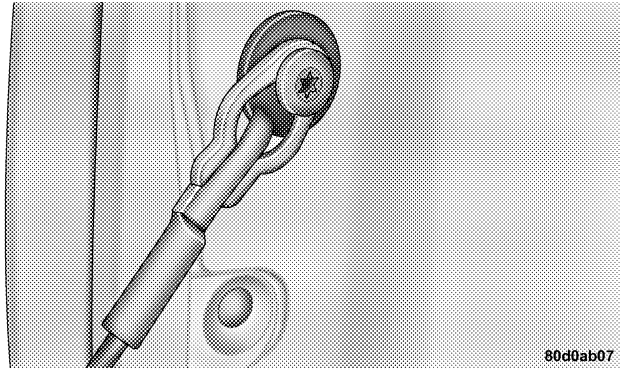
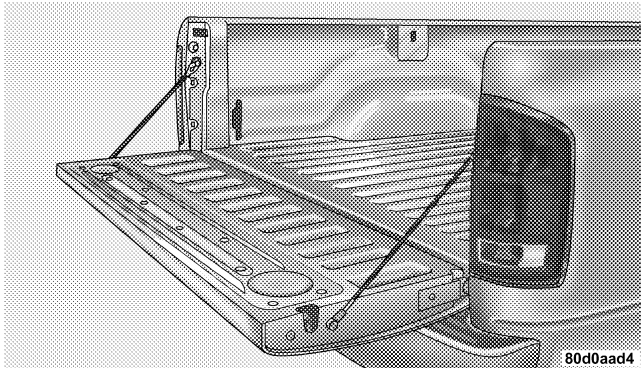

UNDERSTANDING YOUR INSTRUMENT PANEL

CONTENTS

■ Instruments And Controls	132	■ Remote Sound System Controls	149
■ Instrument Cluster	133	□ Radio Operation	149
■ Instrument Cluster Description	134	□ CD Player	150
■ Electronic Digital Clock	141	■ Compact Disc Maintenance	150
□ Clock Setting Procedure	141	■ Radio Operation And Cellular Phones	151
■ Sales Code RBQ—AM/FM Stereo Radio With 6 - Disc CD Changer	141	■ Climate Controls	151
□ Radio Operation	142	□ Air Conditioning With Dual Zone Temperature Control	151
□ CD Player Operation	144	□ Operating Tips	156
		□ Operating Tips Chart	158

INSTRUMENTS AND CONTROLS

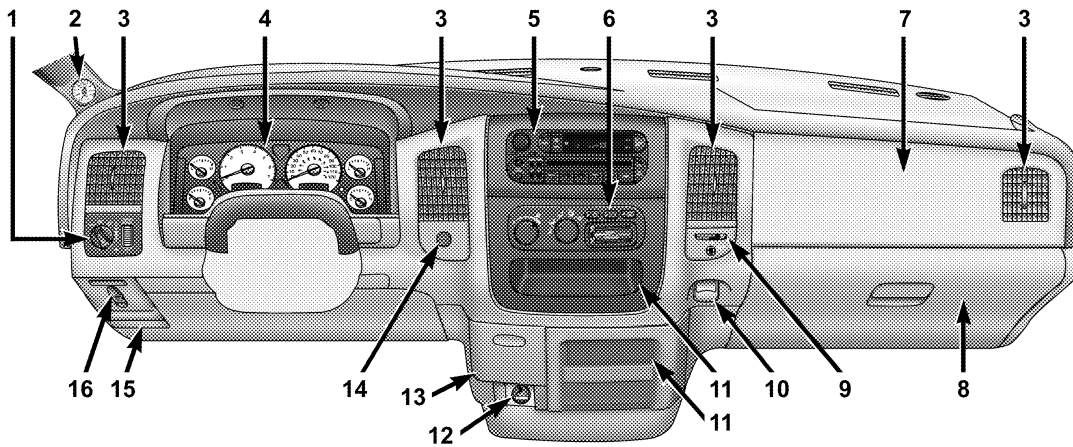

- 1. Headlight Switch
- 2. Engine Oil Temp Gauge*
- 3. Air Outlets
- 4. Instrument Cluster
- 5. Radio
- 6. Climate Controls

- 7. Airbag
- 8. Glove Box
- 9. Passenger Airbag Disable Switch
- 10. Bag Hook
- 11. Storage Bins
- 12. Cigar Lighter*

- 13. Ash Tray*
 - 14. Engine Start Button
 - 15. Parking Brake Release
 - 16 Adjustable Pedals Switch
- *If Equipped

INSTRUMENT CLUSTER

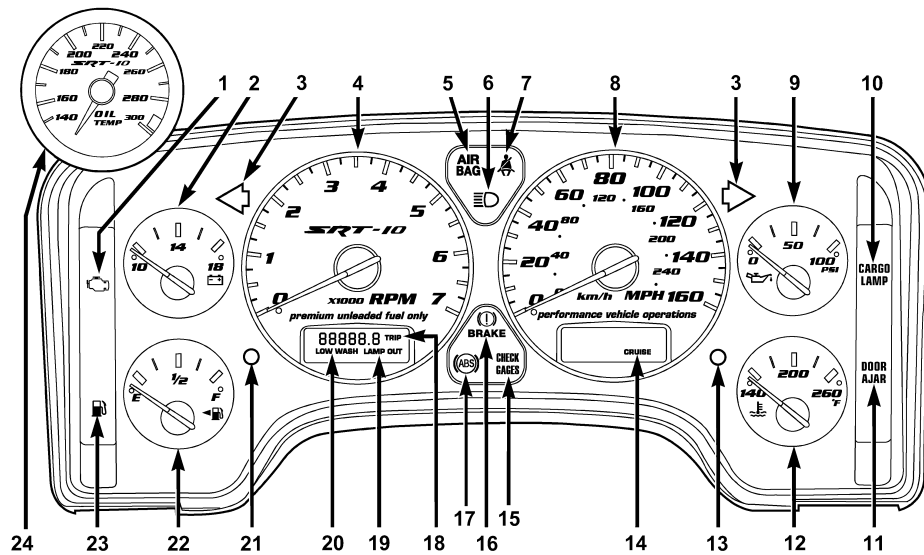

INSTRUMENT CLUSTER DESCRIPTION**1. Malfunction Indicator Light**

This light is part of an onboard diagnostic system which monitors the emissions and engine control system. If the vehicle is ready for emissions testing the light will come on when the ignition is first turned on and remain on, as a bulb check, until the engine is started. If the vehicle is not ready for emissions testing the light will come on when the ignition is first turned on and remain on for 15 seconds, then blink for 5 seconds, and remain on until the vehicle is started. If the bulb does not come on during starting, have the condition investigated promptly.

If this light comes on and remains on while driving, it suggests a potential engine control problem and the need for system service.

Although your vehicle will usually be drivable and not need towing, see your dealer for service as soon as possible.

CAUTION!

Prolonged driving with the MIL on could cause damage to the engine control system. It also could affect fuel economy and driveability.

If the MIL is flashing, severe catalytic converter damage and power loss will soon occur. Immediate service is required.

2. Voltage Gauge



When the engine is running, the gauge indicates the electrical system voltage. The pointer should stay within the normal range if the battery is charged. Typically this would be between 12 and 14 volts. If the pointer moves to either extreme left or right and remains there during normal driving, the electrical system should be serviced.

NOTE: If the gauge pointer moves to either extreme of the gauge, the “Check Gages” indicator will illuminate and a single chime will sound.

3. Turn Signal Indicators

Lights in instrument cluster flash when outside turn signals are operating.

4. Tachometer

The tachometer indicates engine speed in revolutions per minute.

CAUTION!

Do not operate the engine with the tachometer pointer at high rpm for extended periods. Engine damage may occur.

5. Airbag Indicator Light

The indicator lights and remains lit for 6 to 8 seconds when the ignition is first turned on. If the light stays on, flickers or comes on while driving, have the airbag system checked by an authorized dealer.

6. High Beam Indicator



This indicator shows that headlights are on high beam.

7. Seat Belt Reminder Light



When the ignition switch is first turned ON, this light will turn on for 5 to 8 seconds as a bulb check. During the bulb check, if the driver’s seat belt is

unbuckled, a chime will sound. After the bulb check or when driving, if the driver seat belt remains unbuckled, the Seat Belt Warning Light will flash or remain on continuously. Refer to "Enhanced Driver Seat Belt Reminder System (BeltAlert)" in the Occupant Restraints section for more information.

8. *Speedometer*

The speedometer shows the vehicle speed in miles per hour and/or kilometers per hour.

9. *Oil Pressure Gauge*

 The pointer should always indicate some oil pressure when the engine is running. Typically this would be between 40 and 100 psi. A continuous high or low reading, under normal driving conditions, may indicate a lubrication system malfunction. Immediate service should be obtained.

NOTE: If the gauge pointer moves to either extreme of the gauge, the "Check Gages" indicator will illuminate and a single chime will sound.

10. *CARGO LAMP*

The Cargo Lamp light will illuminate when the Cargo Lamp is activated from the dimmer control switch, located next to the headlight switch.

11. *DOOR AJAR*

DOOR AJAR The Door Ajar light will illuminate when any door is opened. When the ignition is ON the Door Ajar light will stay illuminated until the open door is closed. When the ignition is OFF the Door Ajar light will stay illuminated until the open door is closed or the battery saver feature automatically turns the light off.

12. *Temperature Gauge*



The temperature gauge indicates engine coolant temperature. Any reading within the normal range (less than the red zone) indicates that the cooling system is operating satisfactorily. The gauge needle will likely indicate a higher temperature when driving in hot weather, up mountain grades, in heavy traffic. If the needle rises into the red zone, stop the vehicle, shift into N (Neutral), and increase the engine idle speed for 2 to 3 minutes. If the temperature reading does not return to normal, shut your engine OFF and allow it to cool. Seek authorized service immediately. See Cooling System information in the section on "Maintaining Your Vehicle."

NOTE: If the gauge pointer moves to either extreme of the gauge, the "Check Gages" indicator will illuminate and a single chime will sound.

CAUTION!

Do not leave your vehicle unattended with the engine running as you would not be able to react to the temperature indicator if the engine overheats.

13. *Security*

The light will flash rapidly for approximately 16 seconds when the vehicle theft alarm is arming. The light will flash at a slower rate after the alarm is set. The security light will also come on for about two seconds when the ignition is first turned ON.

14. *CRUISE Light*

This indicator lights when the electronic speed control system is turned on.

15. CHECK GAGES

CHECK GAGES This light illuminates when the Voltmeter, Engine Oil Pressure or Engine Coolant Temperature gages indicate a reading either too high or too low. Examine the gages carefully, and follow the instructions above for each indicated problem.

NOTE: When the ignition switch is turned to OFF, the Fuel Gage, Voltmeter, Oil Pressure and Engine Coolant Temperature gages may not show accurate readings. When the engine is not running, turn the ignition switch to ON to obtain accurate readings.

16. BRAKE System Warning Light

This light illuminates when the ignition key is turned to the ON position and remains on for a few seconds. If the light stays on longer, it may be an indication that the parking brake has not been released. This light will illuminate if the brake fluid is low, especially when braking or accelerating hard. This light will illuminate if

the ABS indicator light has a malfunction. This light will flash if the engine is running and the parking brake is on. If the light remains on when the parking brake is released, it indicates a possible brake hydraulic system malfunction. In this case, the light will remain on until the cause is corrected.

If brake failure is indicated, immediate repair is necessary and continued operation of the vehicle in this condition is dangerous.

Acceleration which causes the rear wheels to slip for a period of time may result in the red brake light illuminating and a brake switch code being set on ABS equipped vehicles. Depressing the brake pedal should extinguish the red brake light.

17. ABS Warning Light

 This light monitors the Anti-Lock Brake System which is described elsewhere in this manual. This light will come on when the ignition key is turned to the

ON position and may stay on for five seconds. If the ABS light remains on or comes on during driving, it indicates that the anti-lock portion of the brake system is not functioning and that service is required. See your authorized dealer immediately. The ABS light could also illuminate during loss of traction and remain illuminated until the brake pedal is pressed.

18. Odometer/Trip Odometer

The odometer shows the total distance the vehicle has been driven.

If the odometer reading is changed during repair or replacement, be sure to keep a record of the reading before and after the service so that the correct mileage can be determined.

The trip odometer shows individual trip mileage. To toggle between the odometer and the trip odometer,

press the Odometer/Trip Odometer Button. To reset the Trip Odometer, press and hold the button while in trip mode, until the Trip Odometer resets.

NOTE: There is also an engine hour function. This indicates the number of hours the engine has been running. To display the engine hours perform the following: Place the ignition in RUN, but do not start the engine. With the odometer value displayed, hold the trip button down for a period of 6 seconds. The odometer will change to trip value first, then it will display the engine hour value. The engine hours will be displayed for a period of 30 seconds until the ignition is turned off or the engine is started.

19. LAMP OUT Light

The LAMP OUT indicator in the instrument cluster alerts the driver if a defective bulb or wiring circuit is detected for most of the exterior lamps - headlamps, turn signal lamps, and stop lamps.

20. LOW WASH Light

This light comes on when the washer fluid level falls below approximately 1/4 filled. The light will remain on until fluid is added and one minute has elapsed.

21. Odometer/Trip Odometer Button

Press this button to toggle between the odometer and the trip odometer display. Holding the button in resets the trip odometer reading when in trip mode.

22. Fuel Gauge

Shows level of fuel in tank when ignition switch is in the ON position.

23. Low Fuel Warning Light

Illuminates when the pointer is between "E" and 1/8 indication mark (approximately 15% of tank volume) on the fuel gauge. When the fuel gauge pointer is on "E" (equivalent to Distance To Empty [DTE] = 0 on the overhead console if so equipped) there is reserve fuel capacity, which corresponds to approximately 8% of tank volume. This reserve capacity was put

in place to prevent the likelihood of customers running out of fuel when operating at maximum load conditions in areas where there aren't many gas stations.

Ram SRT-10 fuel tank volume is as follows:

- 26 gallons (98L)

24. Oil Temperature Gauge – if equipped

This gauge shows the oil temperature. The gauge pointer will likely show higher temperatures when driving in hot weather, up mountain grades, or in heavy stop and go traffic. If this gauge reaches the red zone you should stop the vehicle, shift into Neutral, and increase the engine idle speed for 2 to 3 minutes. If the temperature reading does not return to normal, shut OFF your engine and allow it to cool.

NOTE: The oil temperature gauge will not illuminate the CHECK GAGES Light.

ELECTRONIC DIGITAL CLOCK

The clock and radio each use the display panel built into the radio. A digital readout shows the time in hours and minutes whenever the ignition switch is in the “ON” or “ACC” position.

When the ignition switch is in the “OFF” position, or when the radio frequency is being displayed, time keeping is accurately maintained.

Clock Setting Procedure

1. Turn the ignition switch to the “ON” or “ACC” position. Using the point of a ballpoint pen or similar object, press either the “H” (Hour) or “M” (Minute) buttons on the radio. The display will show the time.
2. Press the “H” button to set hours or the “M” button to set minutes. The time setting will increase each time you press a button.

SALES CODE RBQ—AM/FM STEREO RADIO WITH 6 - DISC CD CHANGER

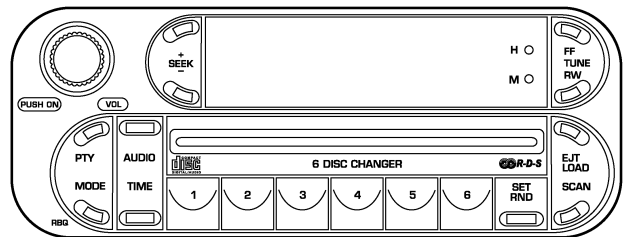

813ebacd

RBQ Radio

Radio Operation

Power/Volume Control

Press the PWR/VOL control to turn the radio on. Turn the volume control clockwise to increase the volume.

NOTE: Power to operate the radio is controlled by the ignition switch. It must be in the ON or ACC position to operate the radio.

Mode

Press the MODE button repeatedly to select between AM, FM, the CD changer and Sirius Satellite Radio™ (if equipped). The display will show ST when a stereo station is received.

To select Sirius Satellite Radio™ (if equipped), press the MODE button until the word SIRIUS appears. The following will be displayed in this order: After three seconds, the current channel name and number will be displayed for five seconds. The current program type and

channel number will then be displayed for five seconds. The current channel name and number will then be displayed until an action occurs. CD's may remain in the player while in the Satellite Radio mode.

Seek

Press and release the SEEK button to search for the next station in either the AM or FM mode. Press the top of the button to seek up and the bottom to seek down. The radio will remain tuned to the new station until you make another selection. Holding the button in will bypass stations without stopping until you release it.

Tune

Press the TUNE control up or down to increase or decrease the frequency. If the button is pressed and held, the radio will continue to tune until the button is released. The frequency will be displayed and continuously updated while the button is pressed.

To Set The Radio Push-Button Memory

When you are receiving a station that you wish to commit to push-button memory, press the SET RND button. SET 1 will show in the display window. Select the “1–6” button you wish to lock onto this station and press and release that button. If a button is not selected within 5 seconds after pressing the SET RND button, the station will continue to play but will not be locked into push-button memory.

You may add a second station to each push-button by repeating the above procedure with this exception: Press the SET button twice and SET 2 will show in the display window. Each button can be set for SET 1 and SET 2 in both AM and FM. This allows a total of 12 AM and 12 FM stations to be locked into push-button memory. The stations stored in SET 2 memory can be selected by pressing the corresponding push-button twice. Every time a preset button is used, a corresponding button number will be displayed.

Audio

The audio button controls the BASS, TREBLE, BALANCE, and FADE.

Press the AUDIO button and BASS will be displayed. Press the SEEK + or SEEK – to increase or decrease the Bass tones.

Press the AUDIO button a second time and TREB will be displayed. Press the SEEK + or SEEK – to increase or decrease the Treble tones.

Press the AUDIO button a third time and BAL will be displayed. Press the SEEK + or SEEK – to adjust the sound level from the right or left side speakers.

Press the AUDIO button a fourth time and FADE will be displayed. Press the SEEK + or SEEK – to adjust the sound level between the front and rear speakers.

Press the AUDIO button again or wait 5 seconds to exit setting tone, balance, and fade.

Time Button

Press the TIME button to change the display between radio frequency and time.

General Information

This radio complies with Part 15 of FCC rules and with RSS-210 of Industry Canada. Operation is subject to the following conditions:

1. This device may not cause harmful interference,
2. This device must accept any interference received, including interference that may cause undesired operation.

NOTE: Changes or modifications not expressly approved by the party responsible for compliance could void the user's authority to operate the equipment.

CD Player Operation

NOTE: The ignition switch must be in the ON or ACC position and the Power / Volume control pushed ON before the CD player will operate.

Inserting The Compact Disc**CAUTION!**

This CD player will accept 4 ¾ inch (12 cm) discs only. The use of other sized discs may damage the CD player mechanism.

You may either insert or eject a disc with the radio OFF.

If you insert a disc with the ignition ON and the radio OFF, the display will show the time of day. If you insert a disc with the ignition OFF, the display will show the time of day for about 5 seconds, then go out.

If you insert a disc with the ignition ON and the radio ON, the unit will switch from radio to CD mode and begin to play when you insert the disc. The display will show the disc number, the track number, and index time in minutes and seconds. Play will begin at the start of track 1.

LOAD/ EJT — Load

Press the LOAD/ EJT button and the button with the corresponding number where the CD is being loaded. After the radio displays "load" insert the CD into the player.

Radio display will show "loading" when it is being loaded.

LOAD / EJT — Eject

Press the LOAD/ EJT button and the button with the corresponding number where the CD was loaded and the disc will unload and move to the entrance for easy removal.

Radio display will show "ejecting" when it is being ejected.

If you have ejected a disc and have not removed it within 15 seconds, it will be reloaded. If the CD is not removed, the radio will continue to play the non-removed CD. If the CD is removed and there are other CD's in the radio, the radio will play the next CD. If the CD is removed and there are no other CD's in the radio, the radio will return to the last selected AM or FM mode.

The disc can be ejected with the radio and ignition OFF.

Seek

Press the top of the SEEK button for the next selection on the CD. Press the bottom of the button to return to the beginning of the current selection, or return to the beginning of the previous selection if the CD is within the first second of the current selection.

Scan

Press the Scan button to scan through each track on the CD currently playing.

FF/TUNE/RW

Press FF (Fast Forward) and the CD player will begin to fast forward until FF is released. The RW (Reverse) button works in a similar manner.

Random Play — SET / RND

Press the RND button while the CD is playing to activate Random Play. This feature plays the tracks on the disc in random order to provide an interesting change of pace.

Press the SEEK button to move to the next randomly selected track.

Press the SET / RND button a second time to stop Random Play.

PTY (Program Type) Button

Pressing this button once will turn on the PTY mode for 5 seconds. If no action is taken during the 5 second time out the PTY icon will turn off. Pressing the PTY button repeatedly within 5 seconds will allow the program format type to be selected. Many radio stations do not currently broadcast PTY information.

Toggle the PTY button to select the following format types:

Program Type	Radio Display
Adult Hits	Adlt Hit
Classical	Classicl
Classic Rock	Cls Rock
College	College
Country	Country
Emergency	ALERT!
Emergency Test	Test

Program Type	Radio Display
Information	Inform
Jazz	Jazz
Foreign Language	Language
News	News
Nostalgia	Nostalga
Oldies	Oldies
Personality	Persnlty
Public	Public
Rhythm and Blues	R & B
Religious Music	Rel Musc
Religious Talk	Rel Talk
Rock	Rock
Soft	Soft
Soft Rock	Soft Rck
Soft Rhythm and Blues	Soft R&B
Sports	Sports

Program Type	Radio Display
Talk	Talk
Top 40	Top 40
Weather	Weather

By pressing the SEEK button when the PTY icon is displayed, the radio will be tuned to the next frequency station with the same selected PTY name. The PTY function only operates when in the FM mode.

The radio display will flash "SEEK" and the selected PTY program type when searching for the next PTY station. If no station is found with the selected PTY program type, the radio will return to the last station.

If a preset button is activated while in the PTY (Program Type) mode, the PTY mode will be exited and the radio will tune to the preset station.

By pressing the SCAN button when the PTY icon is displayed, the radio will stop at every PTY station on the band and list each corresponding program type in the radio display.

Time

Press the TIME button to change the display from elapsed CD playing time to time of day.

Operating Instructions - Satellite Radio Mode (If Equipped)

Refer to the Satellite Radio section of the Owner's Manual.

CD Diagnostic Indicators

When driving over a very rough road, the CD player may skip momentarily. Skipping will not damage the disc or the player, and play will resume automatically.

As a safeguard and to protect your CD player, one of the following warning symbols may appear on your display.

A CD HOT symbol indicates the player is too hot.

CD HOT will pause the operation. Play can be resumed when the operating temperature is corrected or another MODE is selected.

CD ERROR will appear on the display if the laser is unable to read the Disc data for the following reasons:

- Warped disc
- Excessive vibration
- Disc inserted upside down
- Damaged disc
- Water condensation on optics

REMOTE SOUND SYSTEM CONTROLS

The remote sound system controls are located on the rear surface of the steering wheel. Reach behind the wheel to access the switches.

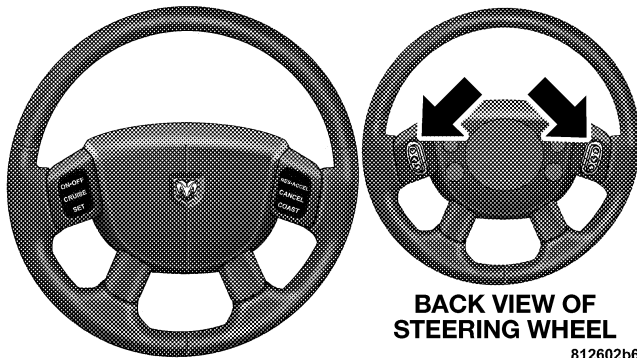

The right hand control is a rocker type switch with a button in the center. Pressing the top of the switch will increase the volume and pressing the bottom of the

switch will decrease the volume. The center button of the right hand control will allow you to change the mode.

The left hand control is a rocker type switch with a push button in the center. The function of the left hand control is different depending on which mode you are in.

The following describes the left hand control operation in each mode.

Radio Operation

Pressing the top of the left side switch will SEEK up for the next listenable station and pressing the bottom of the switch will SEEK down for the next listenable station.

The button located in the center of the left hand control will tune to the next pre-set station that you have programmed in the radio pre-set push-buttons.

CD Player

Pressing the top of the switch once will go to the next track on the CD. Pressing the bottom of the switch once will go to the beginning of the current track or to the beginning of the previous track if it is within one second after the current track begins to play.

If you press the switch up or down twice it plays the second track, three times, it will play the third, etc.

The button in the center of the left hand switch has no function in this mode.

COMPACT DISC MAINTENANCE

To keep the compact discs in good condition, take the following precautions:

1. Handle the disc by its edge; avoid touching the surface.
2. If the disc is stained, clean the surface with a soft cloth, wiping from center to edge.

3. Do not apply paper or tape to the disc; avoid scratching the disc.

4. Do not use solvents such as benzene, thinner, cleaners, or antistatic sprays.

5. Store the disc in its case after playing.

6. Do not expose the disc to direct sunlight.

7. Do not store the disc where temperatures may become too high.

NOTE: If you experience difficulty in playing a particular disc, it may be damaged, oversized, or have theft protection encoding. Try a known good disc before considering disc player service.

RADIO OPERATION AND CELLULAR PHONES

Under certain conditions, the operation of a cellular phone in your vehicle can cause erratic or noisy performance from your radio. This condition may be lessened or eliminated by relocating the cellular phone antenna. This condition is not harmful to the radio. If your radio performance does not satisfactorily “clear” by the repositioning of the antenna, it is recommended that the radio volume be turned down or off during cellular phone operation.

CLIMATE CONTROLS

Air Conditioning with Dual Zone Temperature Control

With the Dual Zone Temperature Control System, each front seat occupant can independently control the temperature of air coming from the outlets on their side of the vehicle.

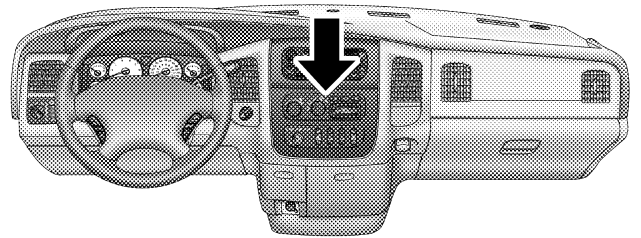

4

80d0ba9c

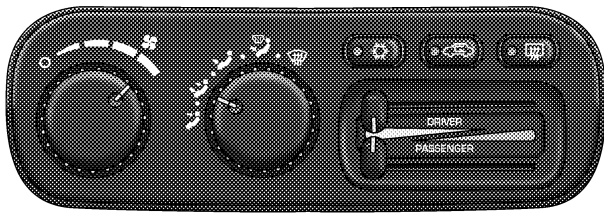

811b8652

Air Conditioning Operation

To turn on the Air Conditioning, set the fan control at any speed and press the snowflake button located on the control panel. Conditioned air will be directed through the outlets selected by the mode control. A light in the

snowflake button shows that the air conditioning is on. Press the button a second time to turn the air conditioning off.

A/C Pushbutton

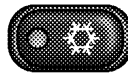

80d0bd96

With the fan control in the ON position, pushing the A/C button turns on the air conditioning compressor. An indicator light on the button shows that the Air Conditioning compressor is on. Conditioned air is now directed through the mode outlets selected.

Pushing the button a second time turns the compressor OFF.

Recirculation Pushbutton

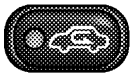

811b86fe

Pushing the Recirculation button allows interior air to recirculate continuously in any position except defrost and defrost/floor mode for rapid cool down of the interior. See “Fast Cooldown” later in this section.

Mode Control



80d0c02d

The mode control allows you to choose from several patterns of air distribution.

NOTE: To improve your selection choices, the system allows you to operate at intermediate positions between

the major modes. These intermediate positions are identified by the small dots and give an even blend of both modes.

Panel

Outside air flows through the outlets located in the instrument panel. These outlets can be adjusted to direct the airflow.

Bi-Level

Air flows through the outlets located in the instrument panel and those located on the floor.

NOTE: There is a difference in temperature between the upper and lower outlets for added comfort. The warmer air goes to the floor outlets. This feature gives improved comfort during sunny but cool conditions.

Heat

Outside air flows primarily through the floor outlets located under the instrument panel.

Mix

 Outside air flows in equal proportions through the floor and defroster outlets.

Defrost

 Outside air is primarily directed to the windshield through the defroster outlets located at the base of the windshield and side window demist outlets.

NOTE: The air conditioning compressor operates in both Mix and Defrost or a blend of these modes, even if the A/C button has not been pressed. This dehumidifies the air to help dry the windshield.

Blower Control

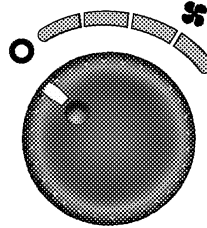

80a01359

The rotary knob on the left of the control panel is the blower control. Turn the knob clockwise to one of the four positions to obtain the blower speed you desire. To turn the blower off, turn the knob to the far left position.

Dual Zone Temperature Control

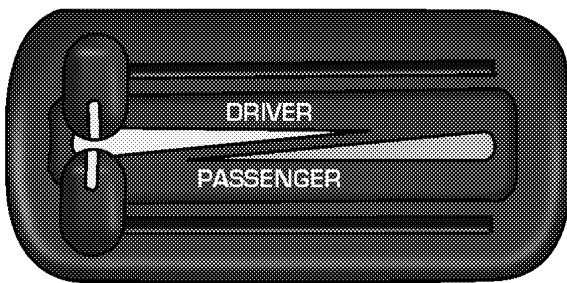

80d0bccc

Use this control to regulate the temperature of the air inside the passenger compartment. This is accomplished by having separate temperature control slides for both the driver and front passenger. The blue area of the scale indicates cooler temperatures while the red area indicates warmer temperatures.

Electric Rear Window Defroster and Heated Sideview Mirrors — If Equipped



The Electric Rear Window Defroster and Heated side view mirrors are activated by pressing the heated grid button, located on the Climate Control panel, with the ignition On. Turning Off the ignition will deactivate the Electric Rear Window Defroster and Heated side view mirrors feature. These features also turn off after activation, when 15 minutes have elapsed. To reactivate, simply press the button again.

4

Circulation

The cab is designed with features to promote outside air circulation. There are grilles in the cab back panel. These are air exhausters that provide the means for regular exchange of cab air.

Side window demisters direct air flow specifically to the window glass to help prevent interior fogging of the glass. They are located in the extreme outside upper

edges of the instrument panel. The demisters also provide extra air ducts for circulation. They are in operation whenever the Floor, Mix or Defrost modes are in use.

NOTE: When you turn off the engine you may hear a hissing sound from under the hood for a short period of time. This is a normal condition that occurs if the air conditioning system has been on. It is not an indication of a problem with the air conditioning system.

Operating Tips

Fast Cooldown

For a fast cooldown, turn the blower fan rotary knob to the extreme right position, turn the mode control to the panel fresh position, press the snowflake button to turn on the air conditioning, and drive with the windows open for the first few minutes. Once the hot air has been expelled, close the windows and press the Recirculation pushbutton. When a comfortable condition has been

reached, choose a mode position and adjust the temperature control slide and blower speed as necessary to maintain comfort. For high humidity conditions it may be necessary to remain in the Recirculation mode to maintain comfort.

Window Fogging

Windows will fog on the inside when the humidity inside the vehicle is high. This often occurs in mild or cool temperatures when it's rainy or humid. In most cases turning on the Air-conditioning (pressing the snowflake button) will clear the fog. Adjust the temperature control, air direction and blower speed to maintain comfort.

As the temperature gets colder it may be necessary to direct air onto the windshield by using MIX Mode position on the control. Adjust the temperature control and blower speed to maintain comfort. Higher blower

speeds will reduce fogging. Interior fogging on the windshield can be quickly removed by selecting the defrost mode.

Regular cleaning of the inside of the windows with a non-filming cleaning solution (vinegar and water works very well) will help prevent contaminants (cigarette smoke, perfumes, etc.) from sticking to the windows. Contaminates increase the rate of window fogging.

Summer Operation

Air conditioned vehicles must be protected with a high quality antifreeze coolant during summer to provide proper corrosion protection and to raise the boiling point of the coolant for protection against overheating. A 50 % concentration is recommended. Refer to Recommended Fluids and Genuine Parts for the proper coolant type.

When using the air conditioner in extremely heavy traffic in hot weather especially when towing a trailer, additional engine cooling may be required. If this situation is

encountered, operate the transmission in a lower gear to increase engine RPM, coolant flow and fan speed. When stopped in heavy traffic, it may be necessary to shift into NEUTRAL and depress the accelerator slightly for fast idle operation to increase coolant flow and fan speed.











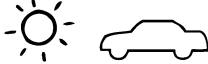















NOTE: On models equipped with Diesel engines, the idle speed will automatically increase to 1000 rpm at elevated coolant temperatures to improve engine cooling.

Your air conditioning system is also equipped with an automatic recirculation system. When the system senses a heavy load or high heat conditions, it may use partial Recirculation A/C mode to provide additional comfort.

Winter Operation

When operating the system during the winter months, make sure the air intake, located directly in front of the windshield, is free of ice, slush, snow, or other obstructions.

Operating Tips Chart

WEATHER	CONTROL SETTINGS
<p>HOT WEATHER AND VEHICLE INTERIOR IS VERY HOT</p> 	<p>Start the vehicle, open the windows and turn the blower control knob to the high position (full clockwise). Set Mode control knob at or between  and . Set temperature control to full cold and press the  button on. After the hot air has been expelled, close the windows and turn the mode control knob to the  setting (counterclockwise) at either  or , or press the  button (if so equipped). Once comfortable, choose a mode position and adjust temperature control and blower speed as necessary for comfort.</p>
<p>WARM WEATHER</p> 	<p>If sunny, set the Mode control at or near  and press the  button on. If cloudy or dark, set the Mode control at or near . No  is necessary.</p>
<p>COOL OR COLD HUMID CONDITIONS</p> 	<p>If sunny, set the Mode control at or between  and , then press the  button on. If cloudy or dark set the Mode control at or near . No  is necessary.</p>
<p>COLD DRY CONDITIONS</p> 	<p>In cloudy or dark weather set the Mode control at or near . If sunny, set the Mode control at or between  and  and for snowy or very cold weather requiring extra heat to the windshield, use .</p>
<p>WINDOW FOGGING</p>	<p>In most cases turning on the Air-Conditioning (press the  button) will clear the fog, then adjust temperature control, air direction and blower speed to maintain comfort. As it gets colder it may be necessary to direct air onto the windshield. If so, set the Mode control at  or  and adjust temperature control and blower speed to maintain comfort. Higher blower speeds will reduce fogging.</p>

STARTING AND OPERATING

CONTENTS

■ Ignition/Starter Switch	162	□ If Engine Fails To Start	164
□ Lock	162	□ After Starting	165
□ Off	162	■ Transmission Shifting	165
□ On	162	□ Automatic Transmission With Overdrive	165
□ ACC	162	□ Manual Transmission — 6-Speed	171
□ Manual Transmission Key Release Button	162	■ Limited-Slip Differential	174
□ Key Reminder	162	■ Parking Brake	175
■ Starting Procedures	163	■ Brake System	176
□ Manual Transmission	163	□ Brake Noise	177

□ Four-Wheel Anti-Lock Brake System (ABS) . . .	177	□ Tread Wear Indicators	194
■ Power Steering	179	□ Replacement Tires	195
■ Tire Safety Information	179	□ Alignment And Balance	196
□ Tire Markings	179	■ Supplemental Tire Pressure Information	197
□ Tire Identification Number (TIN)	183	■ Tire Chains	197
□ Tire Loading And Tire Pressure	184	■ Snow Tires	199
■ Tires—General Information	188	■ Tire Rotation Recommendations	199
□ Tire Pressure	188	■ Fuel Requirements	200
□ Tire Inflation Pressures	189	□ Reformulated Gasoline	201
□ Radial-Ply Tires	192	□ Gasoline/Oxygenate Blends	201
□ Compact Spare Tire — If Equipped	192	□ MMT In Gasoline	202
□ Limited Use Spare — If Equipped	193	□ Sulfur In Gasoline	202
□ Tire Spinning	194	□ Materials Added To Fuel	203

□ Fuel System Cautions	203	□ Connecting Trailer Lighting And Electric Trailer Brakes	216
□ Carbon Monoxide Warnings	204	□ Trailer Weight And Trailer Tongue Weight	217
■ Adding Fuel	204	□ Trailer Towing Information (Maximum Trailer Weight Ratings)	218
□ Fuel Filler Cap (Gas Cap)	205	□ Trailer Towing Mirrors — If Equipped	219
■ Catalytic Converter	206	□ Cooling System Tips — Trailer Towing	219
■ Vehicle Loading	208	□ Automatic Transmission Oil Temperature Warning Light	220
□ Certification Label	208	□ Towing With An Automatic Transmission	220
■ Trailer Towing	211	■ Snowplow	221
□ Definitions	211	□ Dodge SRT-10 Models	221
□ Axle Lubricant And Trailer Towing	213	■ Traction	222
□ Trailer Towing Recommendations	214	■ Equipment Identification Plate	222
□ Trailer Towing — Hitches	215		

IGNITION/STARTER SWITCH

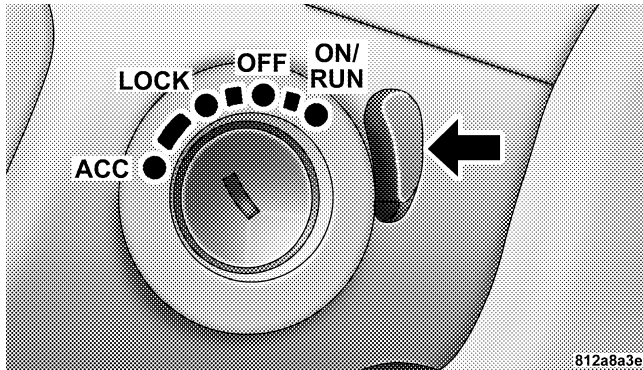

LOCK

Engages the steering wheel lock (if equipped) when the steering wheel is turned.

OFF

Unlocks the steering wheel (if equipped with locking wheel).

ON

This is the normal running position.

ACC

Allows the electrical accessories to be used when the engine is not running.

Manual Transmission Key Release Button

To remove the key on vehicles equipped with manual transmissions, turn the key to the Lock position and press the button to remove the ignition key.

Key Reminder

An alarm will sound to remind you if the key is left in the ignition and the driver's door is opened.

STARTING PROCEDURES

The starter should not be operated for more than 15-second intervals. Waiting a few seconds between such intervals will protect the starter from overheating.

Manual Transmission

Apply the parking brake, place the gearshift control lever in NEUTRAL and depress the clutch pedal to the floor before starting the vehicle. This vehicle is equipped with a clutch interlocking ignition system. It will not start unless the clutch is fully depressed. Place the ignition switch in the ON position.

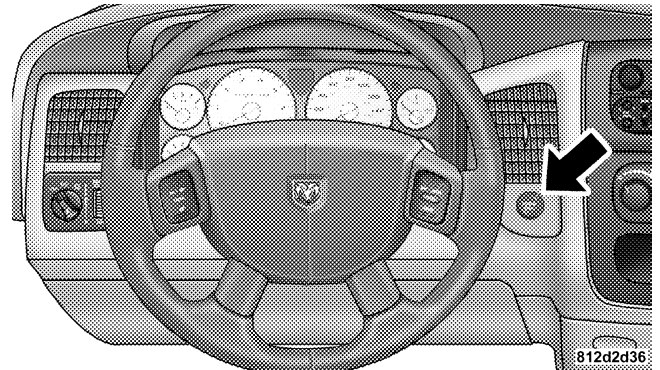

Start Button Locator

Normal starting of either a cold or a warm engine does not require pumping or depressing the accelerator pedal. To start the vehicle, turn the key to the ON position and press the red ENGINE START button located on the



812d2d3d

instrument panel and release when the engine starts. If the engine fails to start within 10 seconds, turn the key to the OFF position, wait 5 seconds, then repeat the normal starting procedure.

If Engine Fails To Start

If the engine fails to start after you have followed the normal starting procedure, it may be flooded. Push the accelerator pedal all the way to the floor and hold it there while cranking the engine. This should clear any excess fuel in case the engine is flooded.

CAUTION!

To prevent damage to the starter, do not crank the engine for more than 15-seconds at a time. Wait 10 to 15 seconds before trying again.

If the engine has been flooded, it may start to run, but not have enough power to continue running when the key is released. If this occurs, continue cranking with the accelerator pedal pushed all the way to the floor. Release the accelerator pedal and the key once the engine is running smoothly.

If the engine shows no sign of starting after two 15 second periods of cranking with the accelerator pedal held to the floor, the normal starting procedure should be repeated.

WARNING!

Never pour fuel or other flammable liquids into the throttle body air inlet opening in an attempt to start the vehicle. This could result in a flash fire causing serious personal injury.

After Starting

The idle speed is automatically controlled and will decrease as the engine warms up.

CAUTION!

Long periods of engine idling, especially at high engine speeds can cause excessive exhaust temperatures which can damage your vehicle. Do not leave your vehicle unattended with the engine running.

WARNING!

Do not leave children or animals inside parked vehicles in hot weather. Interior heat build up may cause serious injury or death.

TRANSMISSION SHIFTING**Automatic Transmission with Overdrive**

The gear shift selector display, located in the instrument panel cluster, indicates the transmission gear range (the selector is illuminated for night driving). The selector lever is mounted on the right side of the steering column. You must depress the brake pedal, to pull the selector lever out of park (P) position (Brake Interlock System). To drive, move the selector lever from Park or Neutral to the desired drive position. Pull the selector lever toward you when shifting into Reverse, Second, First or Park, or when shifting out of Park.

NOTE: The automatic transmission shift quality has been matched to the SRT-10 performance resulting in a more firm feeling shift.

Gear Ranges

DO NOT race the engine when shifting from Park or Neutral position into another gear range.

“P” Park

This gear position supplements the parking brake by locking the transmission. The engine can be started in this range. Never use Park while the vehicle is in motion. Apply the parking brake when leaving the vehicle in this range. Always apply parking brake first, then place the selector in Park position. On 4-wheel-drive vehicles be sure that the transfer case is in a drive position!

WARNING!

Never use Park position on an automatic transmission as a substitute for the parking brake. Always apply parking brake fully when parked to guard against vehicle movement and possible injury or damage.

WARNING!

Your vehicle could move and injure you and others if it is not completely in P (Park). Check by trying to move the gearshift lever back and forth without first pulling it toward you after you have set it in P. Make sure it is in Park before leaving the vehicle.

WARNING!

It is dangerous to shift the selector lever out of "P" or "N" if the engine speed is higher than idle speed. If your foot is not firmly on the brake pedal, the vehicle could accelerate quickly forward or in reverse. You could lose control of the vehicle and hit someone or something. Only shift into gear when the engine is idling normally and when your right foot is firmly on the brake pedal.

"R" Reverse

Use this range only after the vehicle has come to a complete stop.

"N" Neutral

Shift to Neutral when the vehicle is standing for prolonged periods with the engine running. The engine may be started in this range. Set the parking brake if you must leave the vehicle.

"D" Drive

This position provides all forward gears, including 3rd gear direct and 4th gear overdrive (see Overdrive Operation). Use this range for most city and highway driving.

"2" Second

Use this position for driving slowly in heavy city traffic or on mountain roads where more precise speed control is desirable. Use it also when climbing long grades, and for engine braking when descending moderately steep grades.

NOTE: Do not exceed maximum engine speed.

"1" First

Use this position for driving up very steep hills and for engine braking at low speeds (20 mph [32 km/h] or less) when going downhill.

NOTE: Do not exceed a maximum engine speed of 5500 rpm.

Overdrive Operation

The overdrive automatic transmission contains an electronically controlled fourth speed (Overdrive). The transmission will automatically shift from Drive to Overdrive if the following conditions are present:

- the transmission selector is in Drive;
- the engine coolant has reached normal operating temperature;
- vehicle speed is above approximately 30 mph (48 km/h);

- the "TOW/HAUL" switch has not been activated;
- transmission has reached normal operating temperature.

NOTE: If the vehicle is started in extremely cold temperatures, the transmission may not shift into Overdrive and will automatically select the most desirable gear for operation at this temperature. Normal operation will resume when the transmission fluid temperature has risen to a suitable level. Refer also to the Note under torque converter clutch, later in this section.

If the transmission temperature gets extremely hot, the transmission will automatically select the most desirable gear for operation at this temperature. If the transmission temperature becomes hot enough the TRANS TEMP light may illuminate and the transmission may downshift out of Overdrive until the transmission cools down. After cooldown, the transmission will resume normal operation.

The transmission will downshift from Overdrive to Drive if the accelerator pedal is fully depressed at vehicle speeds above approximately 35 mph (56 km/h).

Overdrive Operation

The four-speed overdrive automatic transmission contains an electronically controlled fourth speed (Overdrive). The transmission will automatically shift from Drive to Overdrive if the following conditions are present:

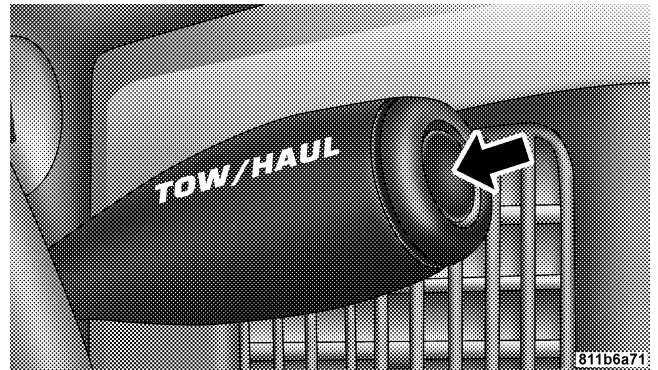

5

- the transmission selector is in Drive;
- the engine coolant has reached normal operating temperature;
- vehicle speed is above approximately 30 mph (48 km/h);
- the "TOW/HAUL" switch has not been activated;

- transmission has reached normal operating temperature.

The transmission will downshift from Overdrive to Drive if the accelerator pedal is fully depressed at vehicle speeds above approximately 35 mph (56 km/h).

Overdrive can be locked out by pressing the "TOW/HAUL" button located on the selector lever. The "TOW/HAUL" light will illuminate in the instrument cluster to indicate that the switch has been activated. Pressing the switch a second time restores the Overdrive function. If the "TOW/HAUL" feature is desired, the "TOW/HAUL" button must be pressed each time the engine is started.

NOTE: If the vehicle is started in extremely cold temperatures, the transmission may not shift into Overdrive and will automatically select the most desirable gear for operation at this temperature. Normal operation will resume when the transmission fluid temperature has

risen to a suitable temperature. Refer also to the Note under torque converter clutch, later in this section.

If the transmission temperature gets extremely hot, the transmission will automatically select the most desirable gear for operation at this temperature. If the transmission temperature becomes hot enough the "TOW/HAUL" and/or TRANS TEMP light(s) may illuminate and the transmission may downshift out of Overdrive until the transmission cools down. After cooldown, the transmission will resume normal operation.

When To Lock Out Overdrive

When driving in hilly areas, towing a trailer, carrying a heavy load, etc., and frequent 4-3-4 transmission shifting occurs, press the "TOW/HAUL" button. This will improve performance and reduce the potential for transmission overheating or failure due to excessive shifting.

The "TOW/HAUL" light will illuminate in the instrument cluster to indicate when the switch has been

activated. Pressing the switch a second time restores normal operation. If the "TOW/HAUL" mode is desired, the button must be pressed each time the engine is started.

Torque Converter Clutch

A feature, designed to improve fuel economy, has been included in the automatic transmission on your vehicle. A clutch within the torque converter engages automatically at calibrated speeds. This may result in a slightly different feeling or response during normal operation in high gear. When the vehicle speed drops or during acceleration when the transmission downshifts to second gear, the clutch automatically disengages.

NOTE: The torque converter clutch will not engage until the transmission fluid and engine coolant are warm [usually after 1-3 miles (1.6 - 4.8 km) of driving]. Because the engine speed is higher when the torque converter clutch is not engaged, it may seem as if the transmission

is not shifting into Overdrive when cold. This is normal. Pressing the "TOW/HAUL" button, when the transmission is sufficiently warm, will demonstrate that the transmission is able to shift into and out of overdrive.

NOTE: If the vehicle has not been driven in several days, the first few seconds of operation after shifting the transmission into gear may seem sluggish. This is due to the fluid partially draining from the torque converter into the transmission. This condition is normal and will not cause damage to the transmission. The torque converter will refill within five seconds of shifting from Park into any other gear position.

Manual Transmission — 6-Speed

NOTE: The parking brake should be engaged before leaving the vehicle, especially on an incline.

This model is equipped with a clutch interlocking ignition system. The clutch pedal must be fully depressed to start the vehicle.

Fully depress the clutch pedal before shifting gears. As you release the clutch pedal, lightly depress the accelerator pedal. When launching a stationary vehicle, keep the engine speed low until the clutch is fully engaged.

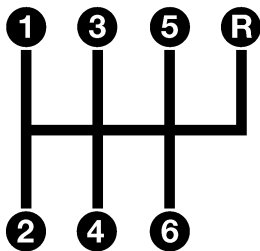

Damage to the clutch can result from starting in 2nd or 3rd gear with a loaded vehicle. Use each gear in numerical order – do not skip a gear.

For improved clutch life, all six forward gears should be used. For steady highway driving with light acceleration, 6th gear is recommended. When shifting from 4th to 5th gear, apply side effort away and forward without pushing hard enough to engage Reverse gear. Shifting from 5th to 6th requires the same side effort or the lever will return to center resulting in a shift into 4th gear and damage the transmission, clutch, or engine.

You should use low gear when starting from a standing position if under a heavy load.

To shift into Reverse, come to a complete stop. Depress the clutch and pause briefly to allow the gear train to stop. Move the shift lever from the Neutral position straight across and up into Reverse.

Never drive with your foot resting on the clutch pedal, or attempt to hold the vehicle on a hill with the clutch pedal partially engaged, as this will cause abnormal wear on the clutch.

Recommended Shift Speeds

To use your manual transmission for fuel economy it should be upshifted as listed below. Shift at the vehicle speeds listed for acceleration. Earlier upshifts during cruise conditions (relatively steady speeds) will result in increased fuel economy, and may be used as indicated.

MANUAL TRANSMISSION RECOMMENDED SHIFT SPEEDS					
	1-2	2-3	3-4	4-5	5-6
MPH	15	25	40	45	50
(km/h)	(24)	(40)	(65)	(72)	(80)

Higher upshift speeds may be used to obtain a desired acceleration rate.

Downshifting

Moving from a high gear down to a lower gear is recommended to preserve brakes when driving down steep hills. In addition, downshifting at the right time provides better acceleration when you desire to resume speed. Downshifting progressively. Do not skip gears to avoid overspeeding the engine and clutch. For acceleration at speeds less than 15 mph (25 km/h), 2nd gear is recommended.

CAUTION!

When descending a hill, be very careful to downshift one gear at a time to prevent overspeeding the engine which can cause valve damage.

LIMITED-SLIP DIFFERENTIAL

The limited-slip differential provides additional traction on snow, ice, mud, sand and gravel, particularly when there is a difference between the traction characteristics of the surface under the right and left rear wheels. During normal driving and cornering, the limited-slip unit performs similarly to a conventional differential. On slippery surfaces, however, the differential delivers more of the driving effort to the rear wheel having the better traction.

The limited-slip differential is especially helpful during slippery driving conditions. With both rear wheels on a slippery surface, a slight application of the accelerator will supply maximum traction. When starting with only one rear wheel on an excessively slippery surface, slight momentary application of the parking brake may be necessary to gain maximum traction.

WARNING!

On vehicles equipped with a limited-slip differential, never run the engine with one rear wheel off the ground, since the vehicle may drive through the rear wheel remaining on the ground. You could lose control of the vehicle.

Care should be taken to avoid sudden accelerations when both rear wheels are on a slippery surface. This could cause both rear wheels to spin, and allow the vehicle to slide sideways on the crowned surface of a road or in a turn.

PARKING BRAKE

The foot operated parking brake is positioned below the lower left corner of the instrument panel. To release the parking brake, pull the parking brake release handle.

NOTE: The instrument cluster red brake warning light will come on and flash to indicate that the parking brake is applied. You must be sure that the parking brake is fully applied before leaving the vehicle.

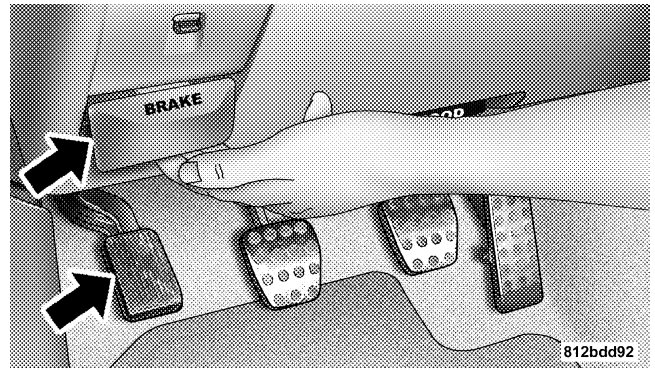

Be sure the parking brake is firmly set when parked and the gear shift lever is in the REVERSE position.

WARNING!

- Always fully apply the parking brake when leaving your vehicle, or it may roll and cause damage or injury. Also be certain to leave a manual transmission in Reverse or first gear. Failure to do so may allow the vehicle to roll and cause damage or injury.
- Leaving children in a vehicle unattended is dangerous for a number of reasons. A child or others could be injured. Children should be warned not to touch the parking brake or the gear selector lever. Don't leave the keys in the ignition. A child could operate power windows, other controls, or move the vehicle.
- Be sure the parking brake is fully disengaged before driving, failure to do so can lead to brake problems due to excessive heating of the rear brakes.

When parking on a hill, turn the front wheels toward the curb on a downhill grade and away from the curb on an uphill grade.

The parking brake should always be applied whenever the driver is not in the vehicle.

BRAKE SYSTEM

If power assist is lost for any reason (for example, repeated brake applications with the engine off), the brakes will still function. However, you will experience a substantial increase in braking effort to stop the vehicle.

If either the front or rear hydraulic systems lose normal capability, the remaining system will still function with some loss of overall braking effectiveness. This will be evident by increased pedal travel during application, greater pedal force required to slow or stop, and activation of the BRAKE warning lamp and the ABS lamp (if equipped) during brake use.

Brake Noise

During normal operation of the brake system certain noises may be present from time to time. Occasional "groan" or "squeal" noises may occur during normal operation of the brake system which may not be indicative of a problem. These noises may be heard at any time the brakes are applied but may be more noticeable during the first few brake applications in the morning. Moisture, hot or cold temperature, dust, and or other debris may also contribute to the noise condition. Repeated or continuous noises during braking may be an indication that the brake linings are worn and in need of replacement.

Four-Wheel Anti-Lock Brake System (ABS)

This Anti-lock Brake System is designed to aid the driver in maintaining vehicle control under adverse braking conditions. The system operates with a separate computer to modulate hydraulic pressure to prevent wheel lockup and help avoid skidding on slippery surfaces.

The system's pump motor runs during an ABS stop to provide regulated hydraulic pressure. The pump motor makes a low humming noise during operation. This is normal.

When you are in a severe braking condition involving use of the Anti-lock Brake System, you will experience some pedal drop as the vehicle comes to a complete stop. This is the result of the system reverting to the base brake system and is normal.

Engagement of the Anti-lock Brake System may be accompanied by a pulsing sensation. You may also hear a clicking noise. These occurrences are normal, and indicate that the system is functioning.

ABS Warning Light

The Anti-lock Brake System includes an amber warning light. When the light is illuminated, the Anti-lock Brake System is not functioning. The system reverts to standard non-anti-lock brakes.

WARNING!

Pumping of the anti-lock brakes will diminish their effectiveness and may lead to an accident. Pumping makes the stopping distance longer. Just press firmly on your brake pedal when you need to slow down or stop.

WARNING!

- Anti-lock system (ABS) cannot prevent the natural laws of physics from acting on the vehicle, nor can it increase braking or steering efficiency beyond that afforded by the condition of the vehicle brakes and tires or the traction afforded.
- The ABS cannot prevent accidents, including those resulting from excessive speed in turns, following another vehicle too closely, or hydroplaning. Only a safe, attentive, and skillful driver can prevent accidents.
- The capabilities of an ABS equipped vehicle must never be exploited in a reckless or dangerous manner which could jeopardize the user's safety or the safety of others.

POWER STEERING

Your power steering system will provide mechanical steering capability if power assist is lost.

If for any reason the hydraulic pressure is interrupted, it will still be possible to steer your vehicle. Under these conditions you will experience a substantial increase in steering effort.

TIRE SAFETY INFORMATION

Tire Markings

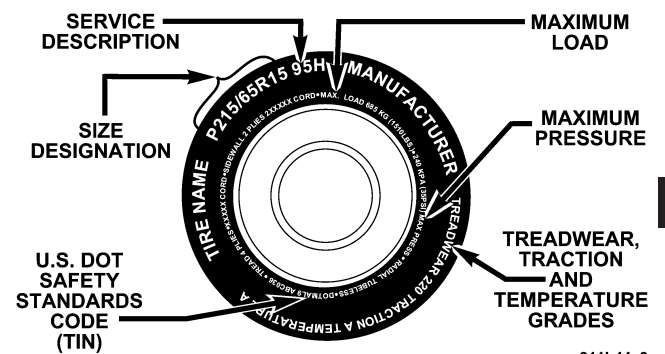

811b44e8

NOTE:

- P(Passenger)-Metric tire sizing is based on U.S. design standards. P-Metric tires have the letter "P" molded into the sidewall preceding the size designation. Example: P215/65R15 95H.

- European Metric tire sizing is based on European design standards. Tires designed to this standard have the tire size molded into the sidewall beginning with the section width. The letter "P" is absent from this tire size designation. Example: 215/65R15 96H
- LT(Light Truck)-Metric tire sizing is based on U.S. design standards. The size designation for LT-Metric tires is the same as for P-Metric tires except for the letters "LT" that are molded into the sidewall preceding the size designation. Example: LT235/85R16.
- Temporary Spare tires are high pressure compact spares designed for temporary emergency use only. Tires designed to this standard have the letter "T" molded into the sidewall preceding the size designation. Example: T145/80D18 103M.
- High Flotation tire sizing is based on U.S. design standards and begins with the tire diameter molded into the sidewall. Example: 31x10.5 R15 LT.

Tire Sizing Chart

EXAMPLE:
Size Designation: P = Passenger car tire size based on U.S. design standards "...blank..." = Passenger car tire based on European design standards LT = Light Truck tire based on U.S. design standards T = Temporary Spare tire 31 = Overall Diameter in Inches (in)
215 = Section Width in Millimeters (mm)
65 = Aspect Ratio in Percent (%) —Ratio of section height to section width of tire. 10.5 = Section Width in Inches (in)
R = Construction Code —"R" means Radial Construction. —"D" means Diagonal or Bias Construction.
15 = Rim Diameter in Inches (in)

EXAMPLE:	
Service Description:	
95 = Load Index	—A numerical code associated with the maximum load a tire can carry.
H = Speed Symbol	—A symbol indicating the range of speeds at which a tire can carry a load corresponding to its load index under certain operating conditions. —The maximum speed corresponding to the Speed Symbol should only be achieved under specified operating conditions. (ie. tire pressure, vehicle loading, road conditions and posted speed limits).
Load Identification:	
"....blank...." = Absence of any text on sidewall of the tire indicates a Standard Load (SL) Tire	
Extra Load (XL) = Extra Load (or Reinforced) Tire	
Light Load = Light Load Tire	
C,D,E = Load range associated with the maximum load a tire can carry at a specified pressure	
Maximum Load — Maximum Load indicates the maximum load this tire is designed to carry.	
Maximum Pressure — Maximum Pressure indicates the maximum permissible cold tire inflation pressure for this tire.	

Tire Identification Number (TIN)

The TIN may be found on one or both sides of the tire however the date code may only be on one side. Tires with white sidewalls will have the full TIN including date code located on the white sidewall side of the tire.

Look for the TIN on the outboard side of black sidewall tires as mounted on the vehicle. If the TIN is not found on the outboard side then you will find it on the inboard side of the tire.

EXAMPLE:	
DOT MA L9 ABCD 0301	
DOT = Department of Transportation	—This symbol certifies that the tire is in compliance with the U.S. Department of Transportation tire safety standards, and is approved for highway use.
MA = Code representing the tire manufacturing location.(2 digits)	
L9 = Code representing the tire size.(2 digits)	
ABCD = Code used by tire manufacturer.(1 to 4 digits)	
03 = Number representing the week in which the tire was manufactured.(2 digits)	—03 means the 3rd week.
01 = Number representing the year in which the tire was manufactured.(2 digits)	—01 means the year 2001. —Prior to July 2000, tire manufacturers were only required to have 1 number to represent the year in which the tire was manufactured. Example: 031 could represent the 3rd week of 1981 or 1991.

Tire Loading and Tire Pressure

Tire Placard Location

NOTE: The proper cold tire inflation pressure for passenger cars is listed on either the face of the driver's door or the driver's side "B" pillar. For vehicles other than passenger cars, the cold tire inflation pressures are listed on either the "B" pillar, the Certification Label or in the Tire Inflation Pressures brochure in the glove compartment.

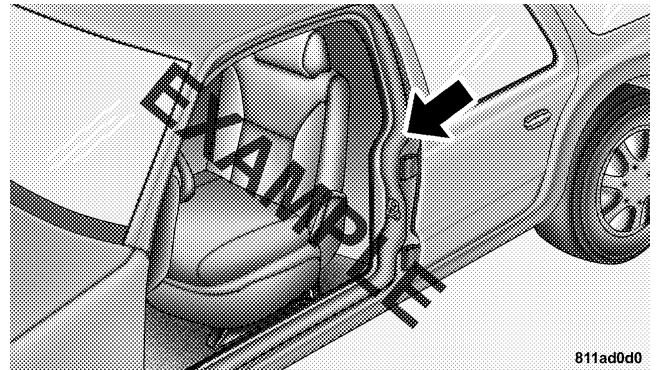

Tire Placard Location

Tire and Loading Information Placard

TIRE AND LOADING INFORMATION			
SEATING CAPACITY - TOTAL 5 FRONT 2 REAR 3			
THE COMBINED WEIGHT OF OCCUPANTS AND CARGO SHOULD NEVER EXCEED XXX KG OR XXX LBS.			
TIRE	FRONT	REAR	SPARE
ORIGINAL TIRE SIZE	P195/70R14	P195/70R14	T125/70D15
COLD TIRE INFLATION PRESSURE	200kPa, 29PSI	200kPa, 29PSI	420kPa, 60PSI
SEE OWNER'S MANUAL FOR ADDITIONAL INFORMATION			4N109268

811b5a9a

Tire and Loading Information

This placard tells you important information about the:

- 1) number of people that can be carried in the vehicle
- 2) the total weight your vehicle can carry
- 3) the tire size designed for your vehicle
- 4) the cold tire inflation pressures for the front, rear and spare tires.

Loading

The vehicle maximum load on the tire must not exceed the load carrying capacity of the tire on your vehicle. You will not exceed the tire's load carrying capacity if you adhere to the loading conditions, tire size and cold tire inflation pressures specified on the Tire and Loading Information placard and the Vehicle Loading section of this manual.

NOTE: Under a maximum loaded vehicle condition, gross axle weight ratings (GAWR's) for the front and rear axles must not be exceeded. For further information on GAWR's, vehicle loading and trailer towing, see the Vehicle Loading section of this manual.

To determine the maximum loading conditions of your vehicle, locate the statement "The combined weight of occupants and cargo should never exceed XXX kg or XXX lbs." on the Tire and Loading Information placard. The

combined weight of occupants, cargo/luggage and trailer tongue weight (if applicable) should never exceed the weight referenced here.

Steps for Determining Correct Load Limit

1. Locate the statement "The combined weight of occupants and cargo should never exceed XXX pounds" on your vehicle's placard.
2. Determine the combined weight of the driver and passengers that will be riding in your vehicle.
3. Subtract the combined weight of the driver and passengers from XXX kilograms or XXX pounds.
4. The resulting figure equals the available amount of cargo and luggage load capacity. For example, if "XXX" amount equals 1400 lbs. and there will be five 150 lb. passengers in your vehicle, the amount of available cargo and luggage load capacity is 650 lb. (since $5 \times 150 = 750$, and $1400 - 750 = 650$ lb.)

5. Determine the combined weight of luggage and cargo being loaded on the vehicle. That weight may not safely exceed the available cargo and luggage load capacity calculated in step 4.

6. If your vehicle will be towing a trailer, load from your trailer will be transferred to your vehicle. Consult this manual to determine how this reduces the available cargo and luggage load capacity of your vehicle.

NOTE: The following table shows examples on how to calculate total load, cargo/luggage and towing capacities of your vehicle with varying seating configurations and number and size of occupants. This table is for illustration purposes only and may not be accurate for the seating and load carry capacity of your vehicle.

NOTE: For the following example the combined weight of occupants and cargo should never exceed 865 lbs. (392 Kg).

Occupants			Combined weight of occupants and cargo from Tire Placard	MINUS	Combined Occupant's weight	=	AVAILABLE Cargo/Luggage and Trailer Tongue Weight
TOTAL	FRONT	REAR					
<u>EXAMPLE 1</u>			865 lbs	minus	Occupant 1: 200 lbs Occupant 2: 130 lbs Occupant 3: 160 lbs Occupant 4: 100 lbs Occupant 5: 80 lbs TOTAL WEIGHT: 670 lbs	=	195 lbs
5	2	3					
<u>EXAMPLE 2</u>			865 lbs	minus	Occupant 1: 210 lbs Occupant 2: 180 lbs Occupant 3: 150 lbs TOTAL WEIGHT: 540 lbs	=	325 lbs
3	2	1					
<u>EXAMPLE 3</u>			865 lbs	minus	Occupant 1: 200 lbs Occupant 2: 200 lbs TOTAL WEIGHT: 400 lbs	=	465 lbs
2	2	0					

811a4d11

WARNING!

Overloading of your tires is dangerous. Overloading can cause tire failure, affect vehicle handling, and increase your stopping distance. Use tires of the recommended load capacity for your vehicle. Never overload them.

TIRES—GENERAL INFORMATION**Tire Pressure**

Proper tire inflation pressure is essential to the safe and satisfactory operation of your vehicle. Three primary areas are affected by improper tire pressure:

1. Safety—**WARNING!**

Improperly inflated tires are dangerous and can cause accidents.

- Under inflation increases tire flexing and can result in tire failure.
- Over inflation reduces a tire's ability to cushion shock. Objects on the road and chuck holes can cause damage that results in tire failure.
- Unequal tire pressures can cause steering problems. You could lose control of your vehicle.
- Over inflated or under inflated tires can affect vehicle handling and can fail suddenly, resulting in loss of vehicle control.
- Unequal tire pressures from one side of the vehicle to the other can cause the vehicle to drift to the right or left.

Always drive with each tire inflated to the recommended cold tire inflation pressure.

2. *Economy*—

Improper inflation pressures can cause uneven wear patterns to develop across the tire tread. These abnormal wear patterns will reduce tread life resulting in a need for earlier tire replacement. Underinflation also increases tire rolling resistance and results in higher fuel consumption.

3. *Ride Comfort and Vehicle Stability*—

Proper tire inflation contributes to a comfortable ride. Overinflation produces a jarring and uncomfortable ride.

Tire Inflation Pressures

The proper cold tire inflation pressure for passenger cars is listed on either the face of the driver's door or the driver's side "B" pillar. For vehicles other than passenger cars, the cold tire inflation pressures are listed on either the "B" pillar, the Certification Label or in the Tire Inflation Pressures brochure in the glove compartment.

Some vehicles may have Supplemental Tire Pressure Information for vehicle loads that are less than the

maximum loaded vehicle condition. These pressure conditions will be found in the "Supplemental Tire Pressure Information" section of this manual.

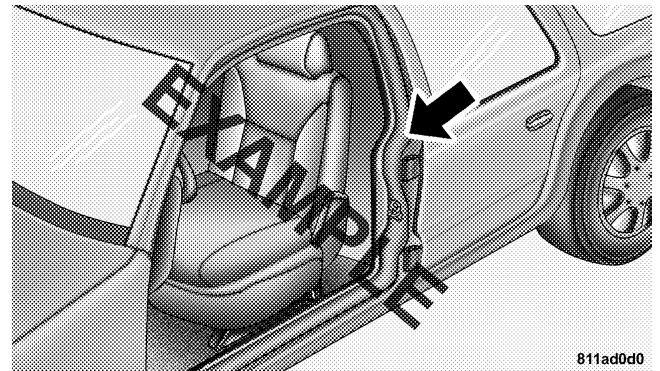

Tire Placard Location

The pressure should be checked and adjusted as well as inspecting for signs of tire wear or visible damage at least once a month. Use a good quality pocket-type gauge to

check tire pressure. Do not make a visual judgement when determining proper inflation. Radial tires may look properly inflated even when they are under inflated.

CAUTION!

After inspecting or adjusting the tire pressure always reinstall the valve stem cap—if equipped. This will prevent moisture and dirt from entering the valve stem, which could damage the valve stem.

Inflation pressures specified on the placard are always “cold tire inflation pressure”. Cold tire inflation pressure is defined as the tire pressure after the vehicle has not been driven for at least 3 hours, or driven less than 1 mile (1 km) after a 3 hour period. The cold tire inflation pressure must not exceed the maximum inflation pressure molded into the tire side wall.

Check tire pressures more often if subject to a wide range of outdoor temperatures, as tire pressures vary with temperature changes.

Tire pressures change by approximately 1 psi (7 kPa) per 12° F (7° C) of air temperature change. Keep this in mind when checking tire pressure inside a garage especially in the winter.

Example: If garage temperature = 68° F (20° C) and the outside temperature = 32° F (0° C) then the cold tire inflation pressure should be increased by 3 psi (21 kPa), which equals 1 psi (7 kPa) for every 12° F (7° C) for this outside temperature condition.

Tire pressure may increase from 2 to 6 psi (13 to 40 kPa) during operation. DO NOT reduce this normal pressure build up or your tire pressure will be too low.

Tire Pressures for High Speed Operation

The manufacturer advocates driving at safe speeds within posted speed limits. Where speed limits or conditions are such that the vehicle can be driven at high speeds, maintaining correct tire inflation pressure is very important. Increased tire pressure and reduced vehicle loading may be required for high speed vehicle operation. Refer to original equipment or an authorized tire dealer for recommended safe operating speeds, loading and cold tire inflation pressures.

WARNING!

High speed driving with your vehicle under maximum load is dangerous. The added strain on your tires could cause them to fail. You could have a serious accident. Don't drive a vehicle loaded to the maximum capacity at continuous speeds above 75 mph (120 km/h).

Radial-Ply Tires

WARNING!

Combining radial ply tires with other types of tires on your vehicle will cause your vehicle to handle poorly. The instability could cause an accident. Always use radial ply tires in sets of four (or 6, in case of trucks with dual rear wheels). Never combine them with other types of tires.

Cuts and punctures in radial tires are repairable only in the tread area because of sidewall flexing. Consult your authorized tire dealer for radial tire repairs.

Compact Spare Tire — If Equipped

The compact spare is for temporary emergency use with radial tires. It is engineered to be used on your style vehicle only. Since this tire has limited tread life, the original tire should be repaired (or replaced) and reinstalled at the first opportunity.

WARNING!

Temporary use spare tires are for emergency use only. With these tires, do not drive more than 50 mph (80 km/h). Temporary-use spare tires have limited tread life. When two or more tread wear indicators appear in adjacent grooves, the temporary use spare tire needs to be replaced. Be sure to follow the warnings which apply to your spare. Failure to do so could result in spare tire failure and loss of vehicle control.

Do not install a wheel cover or attempt to mount a conventional tire on the compact spare wheel, since the wheel is designed specifically for the compact spare.

Do not install more than one compact spare tire/wheel on the vehicle at any given time.

CAUTION!

Because of the reduced ground clearance, do not take your vehicle through an automatic car wash with the compact spare installed. Damage to the vehicle may result.

Limited Use Spare — If Equipped

The limited use spare tire is for temporary emergency use on your vehicle. This tire is identified by a limited use spare tire warning label located on the limited use spare tire and wheel assembly. This tire may look like the original equipped tire on the front or rear axle of your vehicle, but it is not. Installation of this limited use spare tire affects vehicle handling. Since it is not the same tire, replace (or repair) the original tire and reinstall on vehicle at the first opportunity.

WARNING!

The limited use spare tires are for emergency use only. Installation of this limited use spare tire affects vehicle handling. With this tire, do not drive more than 60 mph (100 km/h). Keep inflated to the cold tire inflation pressure listed on either your tire placard or limited use spare tire and wheel assembly. Replace (or repair) the original tire at the first opportunity and reinstall it on your vehicle. Failure to do so could result in loss of vehicle control.

Tire Spinning

When stuck in mud, sand, snow, or ice conditions, do not spin your vehicle's wheels above 35 mph (55 km/h).

See the paragraph on Freeing A Stuck Vehicle in Section 6 of this manual.

WARNING!

Fast spinning tires can be dangerous. Forces generated by excessive wheel speeds may cause tire damage or failure. A tire could explode and injure someone. Do not spin your vehicle's wheels faster than 35 mph (55 km/h) when you are stuck. And don't let anyone near a spinning wheel, no matter what the speed.

Tread Wear Indicators

Tread wear indicators are in the original equipment tires to help you in determining when your tires should be replaced.

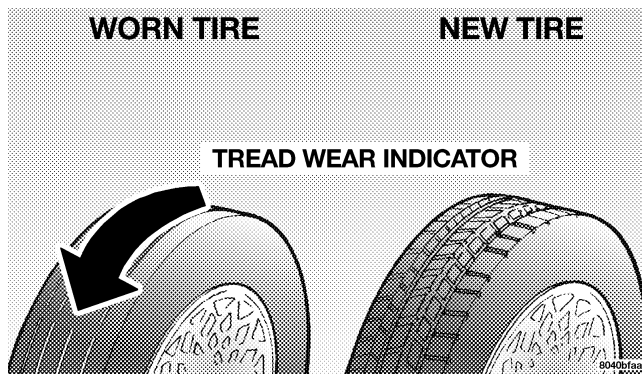

These indicators are molded into the bottom of the tread grooves and will appear as bands when the tread depth becomes 1/16 inch (2 mm). When the indicators appear in 2 or more adjacent grooves, the tire should be replaced.

Many states have laws requiring tire replacement at this point.

Replacement Tires

The tires on your new vehicle provide a balance of many characteristics. They should be inspected regularly for wear and correct cold tire inflation pressure. The manufacturer strongly recommends that you use tires equivalent to the originals in size, quality and performance when replacement is needed (see the paragraph on tread wear indicators). Refer to the Tire and Loading Information placard for the size designation of your tire. The service description and load identification will be found on the original equipment tire. Failure to use equivalent replacement tires may adversely affect the safety, handling, and ride of your vehicle. We recommend that you contact your original equipment or an authorized tire dealer with any questions you may have on tire specifications or capability.

WARNING!

- Do not use a tire, wheel size or rating other than that specified for your vehicle. Some combinations of unapproved tires and wheels may change suspension dimensions and performance characteristics, resulting in changes to steering, handling, and braking of your vehicle. This can cause unpredictable handling and stress to steering and suspension components. You could lose control and have an accident resulting in serious injury or death. Use only the tire and wheel sizes with load ratings approved for your vehicle.
- Never use a tire with a smaller load index or capacity, other than what was originally equipped on your vehicle. Using a tire with a smaller load index could result in tire overloading and failure. You could lose control and have an accident.
- Failure to equip your vehicle with tires having adequate speed capability can result in sudden tire failure and loss of vehicle control.

CAUTION!

Replacing original tires with tires of a different size may result in false speedometer and odometer readings.

Alignment And Balance

Poor suspension alignment may result in:

- Fast tire wear.
- Uneven tire wear, such as feathering and one-sided wear.
- Vehicle pull to right or left.

Tires may also cause the vehicle to pull to the left or right. Alignment will not correct this condition. See your dealer for proper diagnosis.

Improper alignment will not cause vehicle vibration. Vibration may be a result of tire and wheel out-of-balance. Proper balancing will reduce vibration and avoid tire cupping and spotty wear.

SUPPLEMENTAL TIRE PRESSURE INFORMATION

A light load vehicle condition is defined as two passengers {150 lbs (68 kg) each} plus 200 lbs (91kg) of cargo. Cold tire inflation pressures for a lightly loaded vehicle will be found on a "Supplemental Tire Pressure Inflation" label located on the face of the driver's door or in the Tire Information Pressures pamphlet in the glove box.

TIRE CHAINS

Use "Class S" chains on SRT-10 models, or other traction aids that meet SAE Type "S" specifications.

Tire chain use is permitted only on the rear tires of SRT-10 models.

NOTE: Chains must be the proper size for the vehicle, as recommended by the chain manufacturer.

CAUTION!

To avoid damage to your vehicle, tires or chains, observe the following precautions:

- Because of limited chain clearance between tires and other suspension components, it is important that only chains in good condition are used. Broken chains can cause serious vehicle damage. Stop the vehicle immediately if noise occurs that could suggest chain breakage. Remove the damaged parts of the chain before further use.
- Install chains as tightly as possible and then retighten after driving about 1/2 mile (0.8 km).
- Do not exceed 45 mph (72 km/h).
- Drive cautiously and avoid severe turns and large bumps, especially with a loaded vehicle.
- Do not install tire chains on front wheels of 4x2 vehicles.
- Do not drive for a prolonged period on dry pavement.
- Observe the tire chain manufacturer's instructions on method of installation, operating speed, and conditions for usage. Always use the lower suggested operating speed of the chain manufacturer if different than the speed recommended by the manufacturer.

These cautions apply to all chain traction devices, including link and cable (radial) chains.

Tire chain use is permitted only on the rear tires of SRT-10 Models.

NOTE: The use of class "S" chains is permitted on SRT-10 Models with the use of 17 x 8 steel wheels (part number 52113265AC) available from your authorized dealer.

CAUTION!

Do not use tire chains on the front wheels. There may not be adequate clearance for the chains and you are risking structural or body damage to your vehicle.

SNOW TIRES

Snow tires should be of the same size and type construction as the front tires. Consult the manufacturer of the snow tire to determine any maximum vehicle speed requirement associated with the tire. These tires should always be operated at the vehicle maximum capacity inflation pressures under any load condition.

While studded tires improve performance on ice, skid and traction capability on wet or dry surfaces may be poorer than that of non-studded tires. Some states prohibit studded tires; therefore, local laws should be checked before using these tire types.

TIRE ROTATION RECOMMENDATIONS

Tires on the front and rear axles of vehicles operate at different loads and perform different steering, driving, and braking functions. For these reasons, they wear at unequal rates, and develop irregular wear patterns. These effects can be reduced by timely rotation of tires. The benefits of rotation are especially worthwhile with aggressive tread designs such as those on On/Off Road type tires. Rotation will increase tread life, help to maintain mud, snow, and wet traction levels, and contribute to a smooth, quiet ride.

Follow the recommended tire rotation frequency for your type of driving found in the “Maintenance Schedules” Section of this manual. More frequent rotation is permissible if desired. The reasons for any rapid or unusual wear should be corrected prior to rotation being performed.

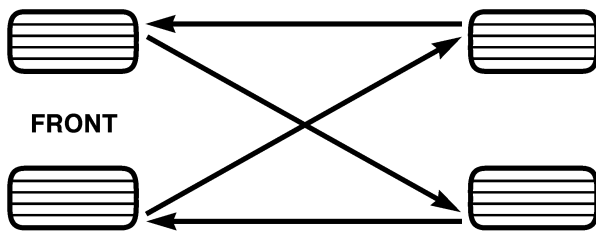

8031e864

NOTE: On Canadian vehicles only, if your Ram truck is equipped with All-Season type tires on the front and ON/OFF Road type tires mounted on the rear, do not use a front to back rotation pattern. Instead, rotate your tires side to side at the recommended intervals.

FUEL REQUIREMENTS



Your vehicle is designed to meet all emission regulations and provide excellent fuel economy when using high quality premium unleaded gasoline having an octane rating of 91 or higher.

Light spark knock at low engine speeds is not harmful to your engine. However, continued heavy spark knock at high speeds can cause damage and immediate service is required.

Poor quality gasoline can cause problems such as hard starting, stalling and hesitations. If you experience these symptoms, try another brand of “regular” gasoline before considering service for the vehicle.

Over 40 automobile manufacturers around the world have issued and endorsed consistent gasoline specifications (the World Wide Fuel Charter, WWFC) to define fuel properties necessary to deliver enhanced emissions, engine performance, and durability for your vehicle. The manufacturer recommends the use of gasolines that meet the WWFC specifications if they are available.

Reformulated Gasoline

Many areas of the country require the use of cleaner burning fuel referred to as Reformulated Gasoline.

Reformulated gasolines contain oxygenates, and are specially blended to reduce vehicle emissions and improve air quality.

The manufacturer strongly supports the use of reformulated gasolines. Properly blended reformulated gasolines will provide excellent performance and durability of engine and fuel system components.

Gasoline/Oxygenate Blends

Some fuel suppliers blend unleaded gasoline with materials called oxygenates such as 10% alcohol, MTBE, ETBE or TAME. Oxygenates are required in some areas of the country during the winter months to reduce carbon monoxide emissions. Fuels blended with these oxygenates may be used in your vehicle.

CAUTION!

DO NOT use gasolines containing METHANOL. Gasoline containing methanol may damage critical fuel system components.

MMT In Gasoline

MMT is a manganese containing metallic additive that is blended into some gasoline to increase the octane. Gasolines blended with MMT offer no performance advantage beyond gasolines of the same octane number without MMT. Gasolines blended with MMT reduce spark plug life and reduce emission system performance in some vehicles. The manufacturer recommends that gasolines without MMT be used in your vehicle. The MMT content of gasoline may not be indicated on the gasoline pump, therefore, you should ask your gasoline retailer whether or not his/her gasoline contains MMT.

It is even more important to look for gasolines without MMT in Canada because MMT can be used at higher levels than are allowed in the United States. MMT is prohibited in Federal and California reformulated gasolines.

Sulfur In Gasoline

Your vehicle may have been designed to meet California low emission standards on clean burning, low sulfur, California gasoline. Gasoline sold outside of California is allowed to have higher sulfur levels that may affect the performance of your vehicle's catalytic converter. This may cause the Malfunction Indicator Light or Service Engine Soon Light to illuminate.

The illumination of this light while operating on high sulfur gasoline does not necessarily mean your emission system control system is malfunctioning. The manufacturer recommends that you try a different brand of unleaded gasoline having lower sulfur to determine if the problem is fuel related before returning your vehicle to an authorized dealer for service.

NOTE: If the Malfunction Indicator light or Service Engine Soon light is flashing, immediate service is required.

Materials Added to Fuel

All gasoline sold in the United States and Canada is required to contain effective detergent additives. The use of additional detergents or other additives is not needed under normal conditions.

Fuel System Cautions**CAUTION!**

Follow these guidelines to maintain your vehicle's performance:

- The use of leaded gas is prohibited by Federal law. Using leaded gasoline can impair engine performance, damage the emission control system.
- An out-of-tune engine, or certain fuel or ignition malfunctions, can cause the catalytic converter to overheat. If you notice a pungent burning odor or

some light smoke, your engine may be out of tune or malfunctioning and may require immediate service. Contact your dealer for service assistance.

- When pulling a heavy load or driving a fully loaded vehicle when the humidity is low and the temperature is high, use a premium unleaded fuel to help prevent spark knock. If spark knock persists, lighten the load, or engine piston damage may result.
- The use of fuel additives which are now being sold as octane enhancers is not recommended. Many of these products contain high concentrations of methanol. Fuel system damage or vehicle performance problems may result from the use of such fuels or additives and is not the responsibility of the manufacturer.

NOTE: Intentional tampering with emissions control systems can result in civil penalties being assessed against you.

Carbon Monoxide Warnings**WARNING!**

Carbon monoxide (CO) in exhaust gases is deadly. Follow the precautions below to prevent carbon monoxide poisoning:

- Do not inhale exhaust gases. They contain carbon monoxide, a colorless and odorless gas which can kill. Never run the engine in a closed area, such as a garage, and never sit in a parked vehicle with the engine running for an extended period. If the vehicle is stopped in an open area with the engine running for more than a short period, adjust the ventilation system to force fresh, outside air into the vehicle.
- Guard against carbon monoxide with proper maintenance. Have the exhaust system inspected every time

the vehicle is raised. Have any abnormal conditions repaired promptly. Until repaired, drive with all side windows fully open.

ADDING FUEL

NOTE: The fuel tank filler tube is about 2 inches (50 mm) down from the opening. If fuel is poured from a portable container, the container should have a flexible nozzle long enough to extend into the fuel filler tube.

CAUTION!

To avoid fuel spillage and overfilling, do not “top off” the fuel tank after filling.

NOTE: When the fuel nozzle “clicks” or shuts off, the fuel tank is full.

NOTE: Tighten the gas cap until you hear a “clicking” sound. This is an indication that the gas cap is properly tightened. Make sure that the gas cap is tightened each time the vehicle is refueled.

WARNING!

A fire may result if gasoline is pumped into a portable container that is inside of a vehicle or on a truck bed. You could be burned. Always place gas containers on the ground while filling.

Fuel Filler Cap (Gas Cap)

The gas cap is behind the fuel filler door. If the gas cap is lost or damaged, be sure the replacement cap is for use with this vehicle.

CAUTION!

Damage to the fuel system or emission control system could result from using an improper fuel tank filler tube cap (gas cap). A poorly fitting cap could let impurities into the fuel system.

WARNING!

- Remove the fuel tank filler tube cap (gas cap) slowly to prevent fuel spray from the filler neck which may cause injury.
- The volatility of some gasolines may cause a buildup of pressure in the fuel tank that may increase while you drive. This pressure can result in a spray of gasoline and/or vapors when the cap is removed from a hot vehicle. Removing the cap slowly allows the pressure to vent and prevents fuel spray.
- Never allow any lit smoking materials near the vehicles while removing the cap or filling the tank.
- Never add fuel to the vehicle when the engine is running.

CATALYTIC CONVERTER

The catalytic converter requires the use of unleaded fuel only. Leaded gasoline will destroy the effectiveness of the catalyst as an emission control device. Under normal operating conditions, the catalytic converter will not require maintenance. However, you must keep the engine maintained to assure proper operation and prevent possible damage.

NOTE: Intentional tampering with emissions control systems can result in civil penalties being assessed against you.

CAUTION!

Damage to the catalytic converter can result if your vehicle is not kept in proper operating condition. In the event of engine malfunction, particularly involving engine misfire or other apparent loss of performance, have your vehicle serviced promptly. Continued operation of your vehicle with a severe malfunction could cause the converter to overheat, resulting in possible damage to the converter and vehicle.

As with any vehicle, do not park or operate this vehicle in areas where combustible materials such as grass or leaves can come in contact with a hot exhaust system.

A scorching odor may be detected if you continue to run a malfunctioning engine. The odor may indicate severe and abnormal catalyst overheating. If this occurs, the

vehicle should be stopped, the engine shut off and the vehicle allowed to cool. Service, including a tune-up to manufacturer's specifications should be obtained immediately.

To minimize the possibility of catalyst damage:

- Do not try to start the engine by pushing or towing the vehicle.
- Do not idle the engine with any spark plug wires disconnected or removed.
- Do not idle the engine for prolonged periods during very rough idle or malfunctioning operating conditions.
- Do not allow vehicle to run out of fuel.

VEHICLE LOADING

Certification Label

As required by National Highway Traffic Safety Administration Regulations, your vehicle has a certification label affixed to the driver's side door or pillar.

This label contains the month and year of manufacture, Gross Vehicle Weight Rating (GVWR), Gross Axle Weight Rating (GAWR) front and rear, and Vehicle Identification Number (VIN). A Month-Day-Hour (MDH) number is included on this label and indicates the Month, Day and Hour of manufacture. The bar code that appears on the bottom of the label is your Vehicle Identification Number (VIN).

Gross Vehicle Weight Rating (GVWR)

The GVWR is the total permissible weight of your vehicle including driver, passengers, vehicle, options and cargo. The label also specifies maximum capacities of front and

rear axle systems (GAWR). Total load must be limited so GVWR and front and rear GAWR are not exceeded.

Payload

The payload of a vehicle is defined as the allowable load weight a truck can carry, including the weight of the driver, all passengers, options and cargo.

Gross Axle Weight Rating (GAWR)

The GAWR is the maximum permissible load on the front and rear axles. The load must be distributed in the cargo area so that the GAWR of each axle is not exceeded.

Each axle GAWR is determined by the components in the system with the lowest load carrying capacity (axle, springs, tires or wheels). Heavier axles or suspension components sometimes specified by purchasers for increased durability does not necessarily increase the vehicle's GVWR.

Tire Size

This is the minimum allowable tire size for your vehicle. Replacement tires must be equal to the load capacity of this tire size.

Rim Size

This is the rim size that is appropriate for the tire size listed.

Inflation Pressure

This is the cold tire inflation pressure for your vehicle for all loading conditions up to full GAWR.

Curb Weight

The curb weight of a vehicle is defined as the total weight of the vehicle with all fluids, including vehicle fuel, at full capacity conditions, and with no occupants or cargo loaded into the vehicle. The front and rear curb weight values are determined by weighing your vehicle on a commercial scale before any occupants or cargo are added.

Loading

The actual total weight and the weight of the front and rear of your vehicle at the ground can best be determined by weighing it when it is loaded and ready for operation.

The entire vehicle should first be weighed on a commercial scale to insure that the GVWR has not been exceeded. The weight on the front and rear of the vehicle should then be determined separately to be sure that the load is properly distributed over front and rear axle. Weighing the vehicle may show that the GAWR of either the front or rear axles has been exceeded but the total load is within the specified GVWR. If so, weight must be shifted from front to rear or rear to front as appropriate until the specified weight limitations are met. Store the heavier items down low and be sure that the weight is distributed equally. Stow all loose items securely before driving.

Improper weight distributions can have an adverse effect on the way your vehicle steers and handles and the way the brakes operate.

CAUTION!

Do not load your vehicle any heavier than the GVWR or the maximum front and rear GAWR. If you do, parts on your vehicle can break, or it can change the way your vehicle handles. This could cause you to lose control. Also overloading can shorten the life of your vehicle.

An EXAMPLE of a loaded vehicle is shown in the following chart. Note that neither GVWR nor GAWR capabilities are exceeded. Overloading can cause potential safety hazards and shorten service life.

NOTE: The weights shown in this chart are not necessarily the weights for your vehicle. Also, the amount of load added to both the front and rear axles can be computed after the vehicle has been weighed both in its "curb weight" condition, and in its "loaded and ready for operation" condition.

Gross Vehicle Weight Rating (GVWR) 6500 LBS.

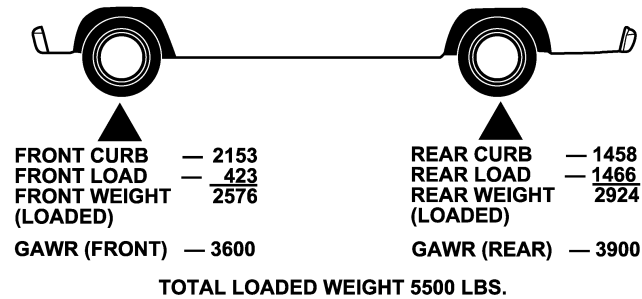

8120c425

TRAILER TOWING

All Dodge Ram Pickup trucks are intended to tow trailers up to 2,000 lbs (907 kg) without added equipment or alterations to standard equipment. Your vehicle may be factory equipped for safe towing of trailers weighing over 2,000 lbs (907 kg) with the optional Trailer Tow Prep Package. See your Dodge dealer for package content.

Definitions

The following trailer towing related terminology definitions will assist in understanding the subsequent sections:

GROSS COMBINATION WEIGHT RATING (GCWR) is the total permissible weight of your vehicle and trailer when weighed in combination. (Note that GCWR ratings include a 150 lb (68 kg) allowance for the presence of a driver.) Tongue Weight (of a trailer) is the weight placed on a vehicle's trailer hitch by the trailer.

GROSS TRAILER WEIGHT (GTW) is the weight of the trailer plus the weight of all cargo, consumables and equipment (permanent or temporary) loaded in or on the trailer in its "loaded and ready for operation" condition.

TRAILER SWAY CONTROL is a telescoping link that can be installed between the hitch receiver and the trailer tongue that typically provides adjustable friction associated with the telescoping motion to dampen any unwanted trailer swaying motions while traveling.

CAUTION!

- **During the first 500 miles (805 km) your new vehicle is driven, do not tow a trailer. Doing so may damage your vehicle.**
- **When first towing a trailer, limit your speed to 50 mph (80 km/h) during the first 500 miles (805 km) of towing.**

Consider the following items when computing the weight on the rear axle:

- the tongue weight of the trailer
- the weight of any other type of cargo or equipment put in or on your vehicle

NOTE: Remember that everything put into or on the trailer adds to the load on your vehicle. Also, additional factory-installed options, or dealer-installed options,

must be considered as part of the total load on your vehicle. Refer to the Certification label located at the driver's door for the Gross Vehicle Weight Rating.

WARNING!

Improper towing can lead to an injury accident. Follow these guidelines to make your trailer towing as safe as possible:

Perform the maintenance listed in the "Maintenance Schedules" section of this manual (Section 8). When towing a trailer, never exceed the Gross Axle Weight Rating (GAWR), or Gross Combined Vehicle Weight (GCVW).

CAUTION!

When hauling cargo or towing a trailer, do not overload your vehicle or trailer. Overloading can cause a loss of control, poor performance or damage to brakes, axle, engine, transmission, steering, suspension, body structure or tires.

Axle Lubricant and Trailer Towing

5

1500 Models

- **1500 Model** rear axles are trailer tow ready. Limited slip rear axles on 1500 models require the use of a limited slip additive (refer to the "Recommended Fluids, Lubricants, and Genuine Parts" section.)
- The limited slip additive is included with the factory fill.
- If the axle fluid is changed, 4 oz. (118 ml) of limited slip additive must be added.

2500/3500 Models

- **The Axles on 2500/3500 Models** are trailer tow ready and **DO NOT REQUIRE** any special axle lubes or additives.

Trailer Towing Recommendations

- All trailer hitches should be professionally installed on your vehicle.
- Safety chains must always be used between your vehicle and trailer.
- Do **not** interconnect the hydraulic brake system or vacuum system of your vehicle with that of the trailer. This could cause inadequate braking and possible personal injury. An electrically-actuated electric trailer brake controller is recommended.
- Trailer brakes are recommended for trailers over 1000 lbs (454 kg) and are required for trailers in excess of 2,000 lbs (907 kg)
- Use an approved wiring harness connector on the trailer. Standard equipment on all RAM pickup models provides a 4-way trailer tow connector located under the bumper. This connector contains the following vehicle circuits: park/tail lamps, left stop/turn lamp, right stop/turn lamp, and ground. With the optional Trailer Tow Prep package a 7-way connector is provided with the following additional circuits: backup lamp, trailer battery and electric brake.

NOTE: Connect trailer lighting and brakes using factory harnesses only. Do not cut or splice wiring to the brake circuits.

- Be sure the trailer is loaded heavier in front, with 60% to 65% of the weight in front of the axle(s). Loads balanced over the wheels or heavier in the rear can cause the trailer to sway severely side to side which will cause loss of control of vehicle and trailer. Failure to load trailers heavier in front is the cause of many trailer accidents. (For a "5th Wheel" style trailer, this range of loading on the "King Pin" should be between 15% and 25%.)
- Make certain that the load is secured in the trailer and will not shift during travel. When towing cargo such as livestock, dynamic load shifts can occur that require the driver to maintain attention.

Trailer Towing — Hitches

With a Class I Hitch, your vehicle can be equipped to tow trailers with a Gross Trailer Weight (GTW) of 2,000 lbs (907 kg) maximum.

With a Class II Hitch, your vehicle can be equipped to tow trailers with a Gross Trailer Weight (GTW) of 3,500 lbs (1 587 kg) maximum. Tongue weight must be equal to at least 10% of GTW, but no more than 15% of GTW.

With a Class III Hitch, your vehicle can be equipped to tow trailers with a Gross Trailer Weight (GTW) of 5,000 lbs (2 268 kg) maximum. Factory-installed rear step bumpers are rated a Class III hitch.

A frame mounted hitch of up to Class IV rating, as rated by the hitch manufacturer, may also be installed. With a Class IV Hitch, you can tow a trailer with a Gross Trailer Weight of up to 12,000 lbs (5 443 kg) maximum depending on your vehicle equipment.

Connecting Trailer Lighting And Electric Trailer Brakes

NOTE: A 4-way trailer tow connector, located behind the bumper, is standard equipment on all Ram pickup models. This connector contains the following vehicle circuits: park/tail lamps, left stop/turn lamp, right stop/turn lamp, and ground. With the optional Trailer Tow Prep package a 7-way connector is also provided with the following additional circuits: backup lamp, trailer battery and electric brake.

NOTE: There is also a 4-way connector located under the instrument panel, located to the left of the brake pedal that is used for the electric brake. This connector contains the following vehicle circuits; power ground, battery, stop lamp switch and electric brake feed. The 4-way is optional with the trailer tow prep package.

CAUTION!

Adding lights or electrical devices to the headlamp/park lamp circuit can be accomplished by connecting to the standard 4-way trailer tow connector located behind the rear bumper. The maximum current capacity for the park lamp circuit should not exceed 15 amps total (a typical park lamp bulb can draw from 0.5 to 1.0 amperes of current).

No connections can be made to the headlamp switch itself, because it is not designed for high current applications. Connections to the headlamp switch will cause the exterior lights to malfunction.

CAUTION!

Connect trailer lighting and brakes using factory harnesses only. Do not cut or splice wiring to the brake circuits. Use an approved wiring harness connector on the trailer.

Trailer Weight and Trailer Tongue Weight

Gross Trailer Weight (GTW) means the weight of the trailer plus the weight of all cargo, consumables and equipment loaded on the trailer when in actual under-way towing condition. The recommended way to measure GTW is to put your fully loaded trailer on a vehicle scale. The entire weight of the trailer must be supported by the scale.

Tongue Weight is the weight placed on the vehicle's trailer hitch by the trailer. Always load a trailer with 60%

to 65% of the weight in the front of the trailer. This places 10% to 15% of the GTW on the tow hitch of your vehicle.

Trailer sway control and equalizing hitch are required for Class III or IV trailer hitches and tongue weights above 350 lbs (159 kg).

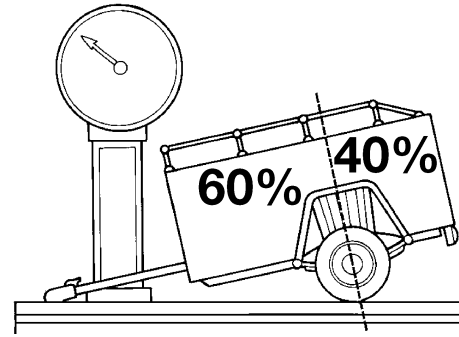

Tongue weight must be equal to at least 10% of GTW, but no more than 15% of GTW.

Also, there are maximum tongue weight ratings that are not to be exceeded, as follows:

- Class III (the bumper ball type) 500 lbs (227 kg)
- Class IV (the receiver hitch type) 1200 lbs (544 kg)

NOTE: When towing a trailer, the following requirements must be adhered to:

- GCWR must not be exceeded
- Total weight must be distributed between the tow vehicle and the trailer such that the following four (4) ratings are not exceeded:
 1. GVWR
 2. GTW
 3. Tongue weight rating for the trailer hitch utilized (This requirement may limit the ability to always achieve the 10% to 15% range of tongue weight [15% to 25% for a "5th Wheel" style trailer] as a percentage of total trailer weight.)

4. GAWR ratings

Trailer Towing Information (Maximum Trailer Weight Ratings)

"Trailer Towing Guide"

NOTE: For trailer towing information (maximum trailer weight ratings) refer to the following website address: [http:// www.dodge.com/towing](http://www.dodge.com/towing).

In Canada, refer to the following website address: [http:// www.dodge.ca](http://www.dodge.ca).

NOTE: For additional general trailer towing information refer to the following National Highway Traffic Safety Administration (NHTSA) website address: [http:// www.nhtsa.dot.gov/cars/problems/Equipment/towing/index.htm](http://www.nhtsa.dot.gov/cars/problems/Equipment/towing/index.htm).

Trailer Towing Mirrors — If Equipped

These mirrors are designed with an adjustable mirror head to provide a greater vision range when towing extra-wide loads. To change position inboard or outboard, the mirror head should be rotated (flipped Out or In). A small blindspot mirror is integrated onto the main mirror surface.

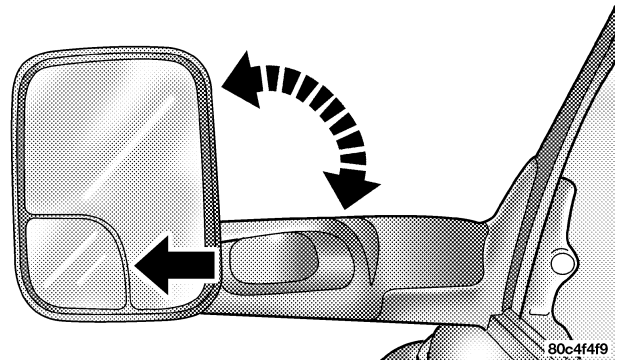
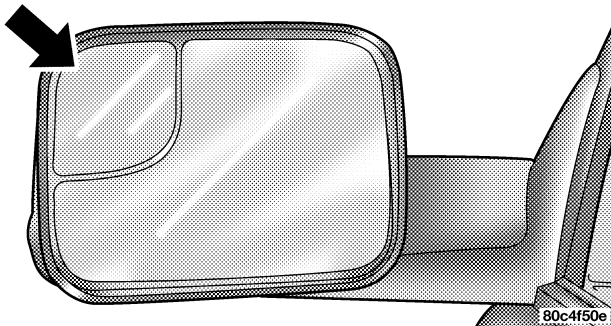

5

Cooling System Tips — Trailer Towing

To reduce potential for engine and transmission overheating, take the following actions:

- **City Driving**— when stopped, put the transmission in N (Neutral) and increase the engine idle speed.
- **Highway Driving**— reduce your speed.

- **Air Conditioning**— turn it off temporarily.
- **Hilly Terrain**— Turn overdrive off.

See Cooling System Operating information in the Service and Maintenance section of this manual for more information.

Automatic Transmission Oil Temperature Warning Light

All vehicles with automatic transmissions are equipped with a transmission sump oil temperature sensor and warning light. If elevated transmission temperatures are encountered, the engine controller will select the most desirable gear until the transmission temperatures are reduced. If transmission oil temperatures continue to rise, a warning light located in the instrument cluster will illuminate. If this should occur, stop the vehicle, shift to Neutral, and run the engine at idle or faster until the light goes off.

Towing With An Automatic Transmission

Vehicles equipped with an automatic transmission may shift into and out of Overdrive, or a lower gear, when driving in hilly areas, when heavily loaded, or when towing into heavy winds.

When this condition occurs, select TOW/HAUL mode or shift into a lower gear to prevent excessive transmission wear and/or overheating, and to provide better engine braking.

NOTE: Do not exceed the following RPM while manually downshifting:

- 5500 rpm with 8.3 L engines.

SNOWPLOW**Dodge SRT-10 Models**

NOTE: DO NOT use Dodge SRT- 10 Models for snowplow applications.

WARNING!

Snowplows, winches, and other aftermarket equipment should not be added to the front end of your vehicle. The airbag crash sensors may be affected by the change in the front end structure. The airbags could deploy unexpectedly or could fail to deploy during a collision resulting in serious injury or death.

CAUTION!

Using this vehicle for snowplow applications can cause damage to the vehicle.

WARNING!

Attaching a snowplow to this vehicle could adversely affect performance of the airbag system in an accident. Do not expect that the airbag will perform as described earlier in this manual

TRACTION

When driving on wet or slushy roads, it is possible for a wedge of water to build up between the tire and road surface. This is known as hydroplaning and may cause partial or complete loss of vehicle control and stopping ability. To reduce this possibility, the following precautions should be observed:

1. Slow down during rainstorms or when roads are slushy.
2. Slow down if road has standing water or puddles.
3. Replace tires when tread wear indicators first become visible.
4. Keep tires properly inflated.
5. Maintain sufficient distance between your vehicle and the car in front to avoid a collision in a sudden stop.

EQUIPMENT IDENTIFICATION PLATE

The equipment Identification Plate is located on the hood inner surface.

The following information about your vehicle is displayed on this plate: Model, Wheelbase, Vehicle Identification Number, Truck Order Number, and code numbers with descriptions of all production and special equipment on the truck as shipped from the factory.

NOTE: Always refer to the Equipment Identification Plate When Ordering Parts.

WHAT TO DO IN EMERGENCIES

CONTENTS

■ Hazard Warning Lights	224	□ Removing The Spare Tire	231
■ Adding Fuel	225	□ Tire Changing Procedure	232
■ Jack Location	226	■ Hoisting	237
□ Removal	226	■ Jump-Starting	237
□ Reinstalling The Scissors-Type Jack And Tools (Srt-10 Models)	228	■ Freeing A Stuck Vehicle	241
■ Changing A Flat Tire	231	■ Towing A Disabled Vehicle	241

HAZARD WARNING LIGHTS

The Hazard Warning switch is mounted on the top of the steering column as shown in the illustration.

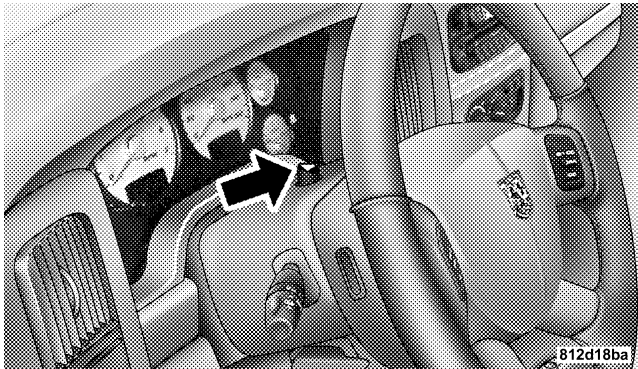

To engage the Hazard Warning lights, depress the button on the top of the steering column. When the Hazard Warning switch is activated, all directional turn signals

will flash off and on to warn oncoming traffic of an emergency. Push the button a second time to turn off the flashers.

This is an emergency warning system and should not be used when the vehicle is in motion. Use it when your vehicle is disabled and is creating a safety hazard for other motorists.

When you must leave the vehicle to seek assistance, the Hazard Warning lights will continue to operate even though the ignition switch is OFF.

NOTE: With extended use, the Hazard Warning lights may discharge your battery.

ADDING FUEL

The fuel tank filler tube has a restriction about 2 inches (50 mm) inside the opening. If using a portable fuel container, it should have a flexible nozzle long enough to reach past the restriction.

WARNING!

A fire may result if gasoline is pumped into a portable container that is in a vehicle or on a truck bed. You could be burned. Always place gas containers on the ground while filling.

WARNING!

Remove the gas cap slowly to prevent fuel spray from the filler neck which may cause injury.

The volatility of present gasolines may cause a build up of pressure in the fuel tank that may increase while you drive. This pressure can result in a spray of gasoline and/or vapors when you remove the cap from a hot vehicle. Removing the cap slowly allows the pressure to vent and prevents fuel spray.

Never allow any lit smoking materials near the vehicles while removing the cap or filling the tank.

Never add fuel to the vehicle when the engine is running.

JACK LOCATION

Removal

The jack and jack tools are stored under the front passenger seat. Lift the flap on the side of the seat for access.

Remove the jack and tools by removing the wing bolt and sliding the assembly from under the seat.

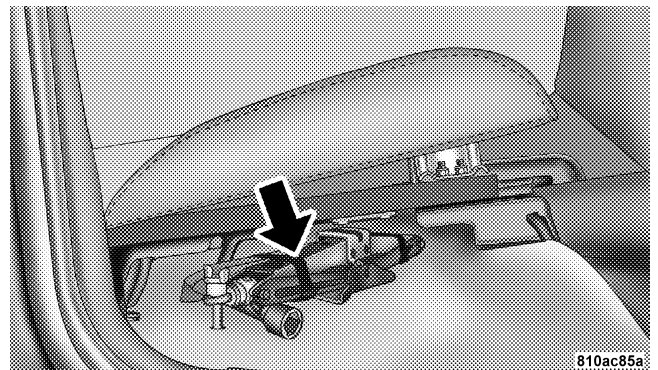

1500 Model Vehicles

WARNING!

The jack is designed to use as a tool for changing tires only. The jack should not be used to lift the vehicle for service purposes, unless suitable supports are placed under the vehicle as a safety measure. The vehicle should be jacked on a firm level surface only. Avoid ice or slippery areas.

WARNING!

After using the jack and tools, always reinstall them in the original carrier and location. While driving you may experience, abrupt stopping, rapid acceleration, or sharp turns. A loose jack, tools, bracket or other objects in the vehicle may move around with force, resulting in serious injury.

Reinstalling The Scissors-Type Jack And Tools (SRT-10 Models)

1. Lower the jack all the way down by turning the jack turn-screw until the jack is snug.
2. Position the jack and tool bag (unrolled). Make sure the lug wrench is under the jack near the jack turn-screw.

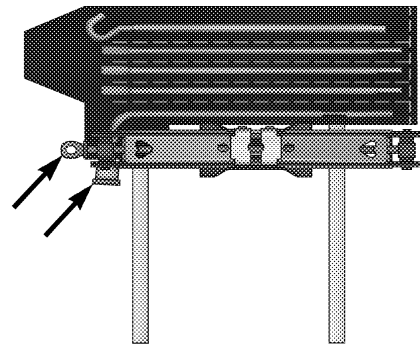

8105e6b6

Turn Screw and Lug Wrench Position

3. Fold the flap and roll the jack tool kit into a cylindrical package (in direction of arrows), and tie to the jack using the tie straps.

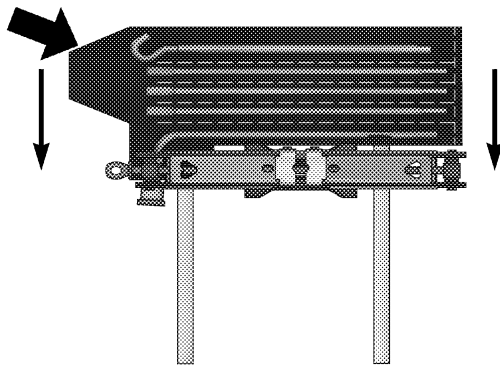

Folding Flap and Rolling Bag

81054f07

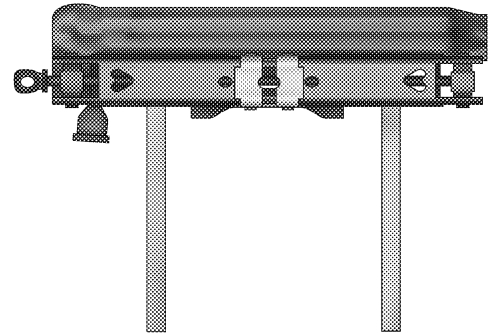

Tying Bag to Jack with Straps

81054ece

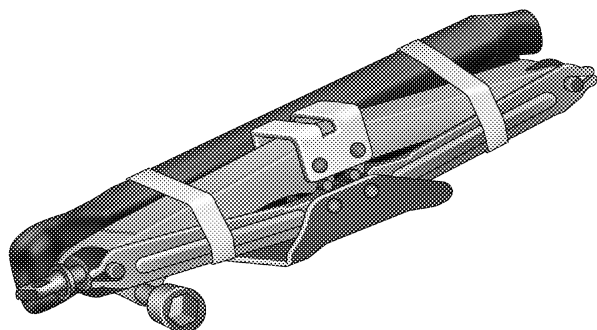

Jack and Tools Tied Together

81054ed3

4. Place the jack and tools in the storage position holding the jack by the jack turn-screw, slip the jack and tools under seat so that the bottom slot engages into the fastener on the floor and then secure to the floor pan using the wing bolt.

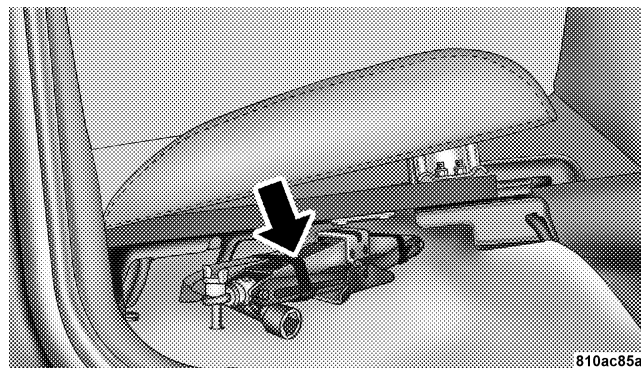

810ac85a

1500 Model Vehicles

CHANGING A FLAT TIRE

Removing The Spare Tire

Remove the spare tire before attempting to jack the truck. Attach the wheel wrench to the jack extension tube. Insert the tube through the access hole between the lower tailgate and the top of the bumper and into the winch mechanism tube. Rotate the wheel wrench handle counterclockwise until the spare tire is on the ground with enough cable slack to allow you to pull it out from under the vehicle. When the spare is clear, tilt the retainer at the end of the cable and pull it through the center of the wheel.

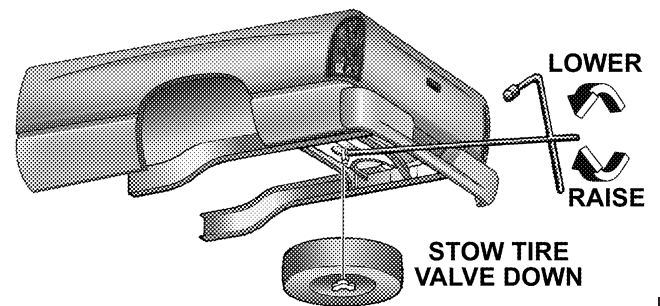

810ae782

6

It is recommended that you stow the flat or spare to avoid tangling the loose cable.

NOTE: The winch mechanism is designed for use with the jack extension tube only. Use of an air wrench or other power tools is not recommended and can damage the winch.

Tire Changing Procedure

WARNING!

Getting under a jacked-up vehicle is dangerous. The vehicle could slip off the jack and fall on you. You could be crushed. Never get any part of your body under a vehicle that is on a jack. Never start or run the engine while the vehicle is on a jack. If you need to get under a raised vehicle, take it to a service center where it can be raised on a lift.

Do not raise this vehicle using a bumper jack. The jack is designed as a tool for changing tires on this vehicle only. It is not recommended that the jack be used for service purposes or to lift more than one wheel at a time.

Preparations

Park the vehicle on a firm level surface, avoiding ice or slippery areas. Set the parking brake and place the gear selector in REVERSE (manual transmission).

WARNING!

Do not attempt to change a tire on the side of the vehicle close to moving traffic. Pull far enough off the road to avoid the danger of being hit when operating the jack or changing the wheel.

- Turn on the Hazard Warning Flasher.

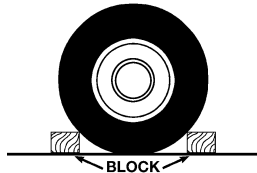

- Block both the front and rear of the wheel diagonally opposite the jacking position. For example, if the right front wheel is being changed, block the left rear wheel.
- Passengers should not remain in the vehicle when the vehicle is being jacked.

Instructions**WARNING!**

Carefully follow these tire changing warnings to help prevent personal injury or damage to your vehicle:

- Always park on a firm, level surface as far from the edge of the roadway as possible before raising the vehicle.
- Block the wheel diagonally opposite the wheel to be raised.
- Apply the parking brake firmly before jacking.
- Never start the engine with the vehicle on a jack.
- Do not let anyone sit in the vehicle when it is on a jack.
- Do not get under the vehicle when it is on a jack.
- Only use the jack in the positions indicated.
- If working on or near a roadway, be extremely careful of motor traffic.

1. Remove the spare wheel, jack, and tools from storage.
2. Using the wheel wrench, loosen, but do not remove, the wheel nuts by turning them counterclockwise one turn while the wheel is still on the ground.

3. Placement of the Jack:

- When changing a front wheel, place the scissors jack under the rear portion of the lower control arm as shown below.

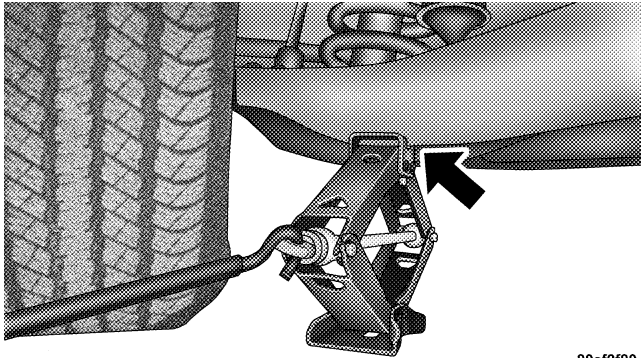

80ef9f80

- Operate the jack using the jack drive tube and the wheel wrench. The tube extension, may be used, but is not required.

- When changing a rear wheel, assemble the jack drive tube to the jack and connect the drive tube to the extension tube. Place the jack under the axle between the spring and the shock absorber with the drive tubes extending to the rear.

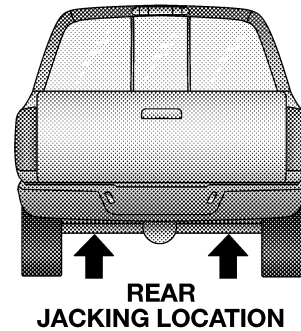

80ef9fa5

- Connect the jack tube extension and wheel wrench.

Before raising the wheel off the ground, make sure that the jack will not damage surrounding truck parts and adjust the jack position as required.

4. By rotating the wheel wrench clockwise, raise the vehicle until the wheel just clears the surface.

WARNING!

Raising the vehicle higher than necessary can make the vehicle unstable and cause an accident. It could slip off the jack and hurt someone near it. Raise the vehicle only enough to remove the tire.

5. Remove the wheel nuts and pull the wheel off. Install the spare wheel and wheel nuts. Lightly tighten the nuts. To avoid risk of forcing the vehicle off the jack, do not fully tighten the nuts until the vehicle has been lowered.

6. Using the wheel wrench, finish tightening the nuts using a crisscross pattern. Correct nut tightness is 90–110 ft. lbs. (125–150 N·m). If in doubt about the correct tightness, have them checked with a torque wrench by your dealer or at a service station.

WARNING!

A loose tire or jack thrown forward in a collision or hard stop could injure someone in the vehicle. Always stow the jack parts and the extra tire and wheel in the places provided.

7. Remove wheel blocks. Do not install chrome or aluminum wheel center caps on the spare wheel. This may result in cap damage.

8. Lower the jack to its fully closed position. Stow the replaced tire, jack, and tools as previously described.

9. Adjust the tire pressure when possible.

NOTE: Do not oil wheel studs. For chrome wheels, do not substitute with chrome plated wheel nuts.

Wheel Nuts

All wheel nuts should be tightened occasionally to eliminate the possibility of wheel studs being sheared or the bolt holes in the wheels becoming elongated. This is especially important during the first few hundred miles of operation to allow the wheel nuts to become properly set. All nuts should first be firmly seated against the wheel. The nuts should then be tightened to recommended torque. Tighten the nuts to final torque in increments. Progress around the bolt circle, tightening the nut opposite to the nut just previously tightened until final torque is achieved. Recommended torques are shown in the following chart.

Disc Wheels	Type Nut	Stud Size	Torque Ft. Lbs.	Torque Newton Meters
	Cone	1/2-20	90-110	125-150

To Stow The Flat Or Spare

Turn the wheel so that the valve stem is down. Slide the wheel retainer through the center of the wheel and position it properly across the wheel opening.

For convenience in checking the spare tire inflation, stow with the valve stem toward the rear of the vehicle.

Attach the wheel wrench to the extension tube. Rotate the winch mechanism until the wheel is drawn into place against the underside of the vehicle. Continue to rotate until you feel the winch mechanism slip or click 3 or 4 times. It cannot be overtightened. Push against the tire several times to be sure it is firmly in place.

HOISTING

A conventional floor jack may be used at the jacking locations, refer to the graphics that show jacking locations. However, a floor jack or frame hoist must never be used on any other parts or the underbody.

CAUTION!

Never use a floor jack directly under the differential housing of a loaded truck or damage to your vehicle may result.

JUMP-STARTING

You should not try to start your vehicle by pushing or towing. Pushing or towing a vehicle equipped with a manual transmission may overheat and damage the catalytic converter. Also, there is a greater risk of an accident when a vehicle is being pushed or towed. If the vehicle has a discharged battery, booster cables may be used to obtain a start from a booster battery or the battery in another vehicle. This type of start can be dangerous if done improperly, so follow this procedure carefully.



WARNING!

Battery fluid is a corrosive acid solution; do not allow battery fluid to contact eyes, skin or clothing. Don't lean over battery when attaching clamps or allow the clamps to touch each other. If acid splashes in eyes or on skin, flush contaminated area immediately with large quantities of water.

A battery generates hydrogen gas which is flammable and explosive. Keep flame or spark away from the vent holes.

Do not use a booster battery or any other booster source that has a greater than 12 volt system, i.e. Do not use a 24 volt power source.

Check the Battery Test Indicator (If Equipped). If a yellow or bright colored dot is visible in the indicator (if equipped), DO NOT jump-start the battery.

BATTERY CONDITION INDICATOR	O.K. TO JUMP START		DARKENED INDICATOR WITH GREEN DOT • BATTERY CHARGE OK • FLUID LEVEL OK
	DO NOT JUMP START		DARKENED INDICATOR NO GREEN DOT • BATTERY CHARGE LOW • FLUID LEVEL OK
	DO NOT JUMP START		YELLOW OR BRIGHT INDICATOR • BATTERY CHARGE UNKNOWN • FLUID LEVEL LOW (CHARGE MAY STILL BE SUFFICIENT TO START YOUR CAR)

8000cbce

If the indicator (if equipped) is dark or shows a green dot, proceed as follows:

1. Remove all metal jewelry such as watch bands or bracelets which might make an unintended electrical contact.

2. Park the booster vehicle within cable reach but without letting the vehicles touch. Set the parking brake on both vehicles, place transmission in Neutral, and turn the ignition OFF.
3. Turn off the heater, radio, and all unnecessary electrical loads.
4. Connect one end of a jumper cable to the positive terminal of the booster battery. Connect the other end of the same cable to the positive terminal of the discharged battery.

WARNING!

Do not permit vehicles to touch each other as this could establish a ground connection and personal injury could result.

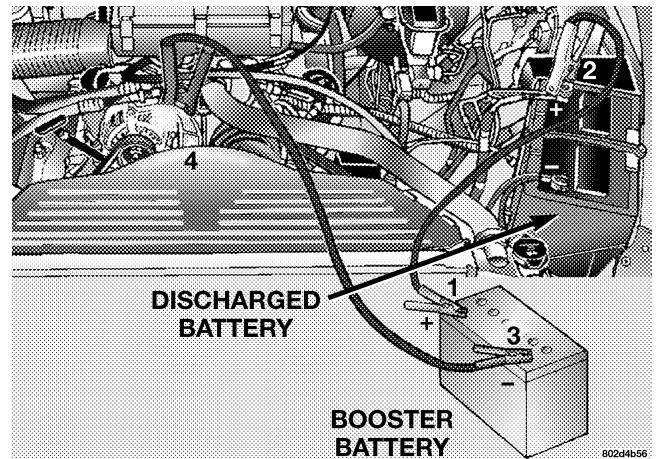

5. Connect the other cable, first to the negative terminal of the booster battery and then to the engine of the vehicle with the discharged battery. Make sure you have a good contact on the engine.

WARNING!

- Do not connect the cable to the negative post of the discharge battery. The resulting electrical spark could cause the battery to explode.
- During cold weather when temperatures are below freezing point, electrolyte in a discharged battery may freeze. Do not attempt jump starting because the battery could rupture or explode. The battery temperature must be brought up above freezing point before attempting jump start.

6. Start the engine in the vehicle which has the booster battery, let the engine idle a few minutes, then start the engine in the vehicle with the discharged battery.

7. When removing the jumper cables, reverse the above sequence exactly. Be careful of the moving belts and fan.

WARNING!

- Any procedure other than above could result in:
1. Personal injury caused by electrolyte squirting out the battery vent;
 2. Personal injury or property damage due to battery explosion;
 3. Damage to charging system of booster vehicle or of immobilized vehicle.

FREEING A STUCK VEHICLE

If vehicle becomes stuck in snow, sand, or mud, it can often be moved by a rocking motion. Move the gear selector rhythmically between FIRST and REVERSE, while applying slight pressure to the accelerator.

In general, the least amount of accelerator pedal pressure to maintain the rocking motion without spinning the wheels or racing the engine is most effective. Racing the engine or spinning the wheels, due to the frustration of not freeing the vehicle, may lead to transmission overheating and failure. Allow the engine to idle with the transmission selector in NEUTRAL for at least one minute after every five rocking-motion cycles. This will minimize overheating and reduce the risk of transmission failure during prolonged efforts to free a stuck vehicle.

TOWING A DISABLED VEHICLE

Proper towing or lifting equipment is required to prevent damage to your vehicle. Use only tow bars and other equipment designed for the purpose, following equipment manufacturer's instructions. Use of safety chains is mandatory. Attach a tow bar or other towing device to the main structural members of the vehicle—not to bumpers or associated brackets. State and local laws applying to vehicles under tow must be observed.

Provided that the transmission is operable, tow with the transmission in Neutral and the ignition key in the OFF position along with the front wheels raised and the rear wheels on the ground. Speed must not exceed 30 mph (50 km/h) and distance must not exceed 15 miles (25 km).

If the vehicle is to be towed more than 15 miles (25 km) the vehicle must be towed with the rear wheels raised and the front wheels on the ground. It may also be towed on a flatbed or with the front wheels raised and the rear wheels on a dolly.

MAINTAINING YOUR VEHICLE

CONTENTS

■ Engine Compartment— 8.3L	246	□ Drive Belts — Check Condition And Tension . .	254
■ Onboard Diagnostic System (OBD II)	247	□ Spark Plugs	255
■ Emissions Inspection And Maintenance Programs	247	□ Engine Air Cleaner Filter	255
■ Dealer Service	249	□ Engine Fuel Filter	255
■ Replacement Parts	250	□ Catalytic Converter	256
■ Maintenance Procedures	250	□ Crankcase Emission Control System	258
□ Engine Oil	250	□ Maintenance Free Battery	258
□ Engine Oil Filter	254	□ Air Conditioner	259
		□ Power Steering — Fluid Check	260

244 MAINTAINING YOUR VEHICLE

□ Front Suspension Ball Joints	261	□ Manual Transmission	271
□ Steering Linkage — Inspection	261	□ Automatic Transmission	272
□ Body Lubrication	262	□ Front Wheel Bearings	274
□ Windshield Wiper Blades	262	□ Selection Of Lubricating Grease	274
□ Windshield Washers	262	□ Appearance Care And Protection From Corrosion	275
□ Exhaust System	263	■ Fuse And Relay Center	279
□ Cooling System	264	■ Vehicle Storage	280
□ Hoses And Vacuum/Vapor Harnesses	268	■ Replacement Light Bulbs	280
□ Brake System	268	■ Bulb Replacement	281
□ Clutch Hydraulic System	270	□ Headlight (Halogen)/Front Park And Turn Lights	281
□ Clutch Linkage	270	□ Tail, Stop, Turn And Backup Lights	285
□ Propeller Shaft Universal Joints	270		
□ Rear Axle Fluid Level	270		

<input type="checkbox"/> Center High-Mounted Stoplight With Cargo Light	287	<input checked="" type="checkbox"/> Recommended Fluids, Lubricants And Genuine Parts	291
<input type="checkbox"/> Fog Lights	289	<input type="checkbox"/> Engine	291
<input checked="" type="checkbox"/> Fluid Capacities	290	<input type="checkbox"/> Chassis	292

ENGINE COMPARTMENT— 8.3L

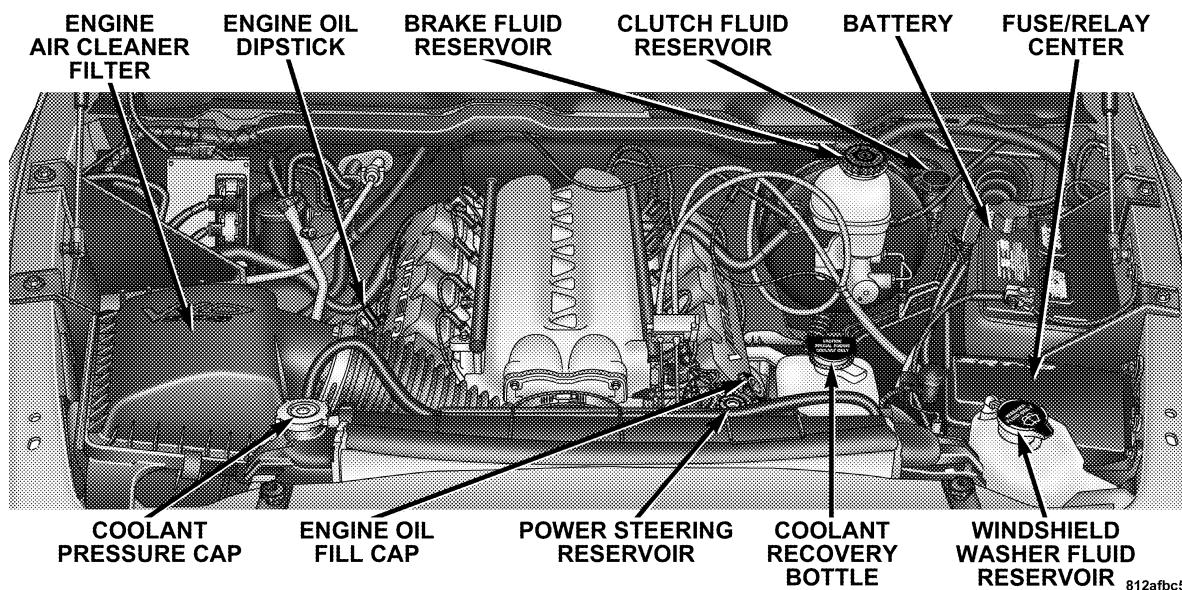

812afbc5

ONBOARD DIAGNOSTIC SYSTEM (OBD II)

Your vehicle is equipped with a sophisticated onboard diagnostic system called OBD II. This system monitors the performance of the emissions and engine control systems. When these systems are operating properly, your vehicle will provide excellent performance and fuel economy, as well as engine emissions well within current government regulations.

If any of these systems require service, the OBD II system will turn on the "Malfunction Indicator Light." It will also store diagnostic codes and other information to assist your service technician in making repairs. Although your vehicle will usually be driveable and not need towing, see your dealer for service as soon as possible.

CAUTION!

Prolonged driving with the "Malfunction Indicator Light" on could cause further damage to the emission control system. It could also affect fuel economy and driveability. The vehicle must be serviced before any emissions tests can be performed.

If the "Malfunction Indicator Light" is flashing, severe catalytic converter damage and power loss will soon occur. Immediate service is required.

EMISSIONS INSPECTION AND MAINTENANCE PROGRAMS

In some localities, it may be a legal requirement to pass an inspection of your vehicle's emissions control system. Failure to pass could prevent vehicle registration.



For states which have an I/M (Inspection and Maintenance) requirement, this check verifies the following: the MIL (Malfunction Indicator Lamp) is functioning and is not on when the engine is running, and that the OBD (On Board Diagnostic) system is ready for testing.

Normally, the OBD system will be ready. The OBD system may **not** be ready if your vehicle was recently serviced, if you recently had a dead battery, or a battery replacement. If the OBD system should be determined not ready for the I/M test, your vehicle may fail the test.

Your vehicle has a simple ignition key actuated test which you can use prior to going to the test station. To check if your vehicle's OBD system is ready, you must do the following:

1. Insert your ignition key into the ignition switch.
2. Turn the ignition to the ON position, but do not crank or start the engine.
3. If you crank or start the engine, you will have to start this test over.
4. As soon as you turn your key to the ON position, you will see your MIL symbol come on as part of a normal bulb check.
5. Approximately 15 seconds later, one of two things will happen:
 - a. The MIL light will blink for approximately 5 seconds and then remain on until the first engine crank or the key is turned off. This means that your vehicle's OBD system is **not ready** and you should **not** proceed to the I/M station.

b. The MIL light will remain fully illuminated until the first engine crank or the key is turned off. This means that your vehicle's OBD system is **ready** and you can proceed to the I/M station.

If your OBD system is **not ready**, you should see your dealer or repair facility. If your vehicle was recently serviced or had a battery failure or replacement, you may need to do nothing more than drive your vehicle as you normally would in order for your OBD system to update. A recheck with the above test routine may then indicate that the system is now ready.

Regardless of whether your vehicle's OBD system is ready or not ready, if the MIL symbol is illuminated during normal vehicle operation, you should have your vehicle serviced before going to the I/M station. The I/M station can fail your vehicle because the MIL symbol is on with the engine running.

DEALER SERVICE

Your dealer has the qualified service personnel, special tools and equipment to perform all service operations in an expert manner. Service manuals are available which include detailed service information for your vehicle. Refer to these manuals before attempting any procedure yourself.

NOTE: Intentional tampering with emissions control systems can result in civil penalties being assessed against you.

WARNING!

You can be badly injured working on or around a motor vehicle. Do only that service work for which you have the knowledge and the proper equipment. If you have any doubt about your ability to perform a service job, take your vehicle to a competent mechanic.

REPLACEMENT PARTS

Use of genuine Mopar® parts for normal/scheduled maintenance and repairs is highly recommended to insure the designed performance. Damage or failures caused by the use of non-Mopar parts for maintenance and repairs will not be covered by the manufacturer's warranty.

MAINTENANCE PROCEDURES

The pages that follow contain the **required** maintenance services determined by the engineers who designed your vehicle.

Besides the maintenance items for which there are fixed maintenance intervals, there are other items that should operate satisfactorily without periodic maintenance. However, if a malfunction of these items does occur, it could adversely affect the engine or vehicle performance. These items should be inspected if a malfunction is observed or suspected.

Engine Oil**Checking Oil Level**

To assure proper lubrication of your vehicle's engine, the engine oil must be maintained at the correct level. The best time to check the engine oil level is about 5 minutes after a fully warmed up engine is shut off or before starting the engine after it has sat overnight.

Checking the oil while the vehicle is on level ground will improve the accuracy of the oil level readings. Maintain the oil level between the ADD and SAFE markings on the dipstick. Adding one quart of oil when the reading is at the ADD mark will result in a SAFE reading on these engines.

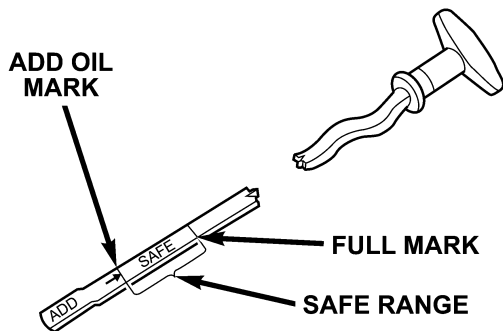

80bd0aae

Change Engine Oil

CAUTION!

Overfilling or underfilling the crankcase will cause oil aeration or loss of oil pressure. This could damage your engine.

Road conditions as well as your kind of driving affect the interval at which your oil should be changed. Check the following to determine if any apply to you:

- Day or night temperatures are below 32°F (0°C).
- Stop and go driving.
- Extensive engine idling.
- Driving in dusty conditions
- Short trips of less than 10 miles (16.2 km)

- More than 50% of your driving is at sustained high speeds during hot weather, above 32°C (90°F)
- Taxi, Police or delivery service (commercial service)
- Off-road or desert operation
- **If equipped for and operating with E-85 (ethanol) fuel.**

NOTE: If ANY of these apply to you then change your engine oil every 3,000 miles (5 000 km) or 3 months, whichever comes first and follow schedule "B" of the "Maintenance Schedules" section of this manual.

If none of these apply to you, then change your engine oil at every interval shown on schedule "A" of the "Maintenance Schedules" section of this manual.

Dusty Conditions

Driving through dust-laden air increases the problems of keeping abrasive materials out of the engine. Under these

conditions, special attention should be given to the engine air cleaner, the crankcase inlet air cleaner and, the crankcase ventilation system. Make sure that these units are clean at all times. This will tend to reduce to a minimum the amount of abrasive material that may enter the engine.

Engine Oil Selection

For best performance and maximum protection under all types of operating conditions, the manufacturer only recommends full synthetic engine oils that are API rated as SL/CF and meet the requirements of DaimlerChrysler Material Standard MS-10725. Use Mopar or an equivalent oil meeting the specification MS-10725.

If you choose to operate this vehicle in a very aggressive driving style, the manufacturer recommends the use of a full synthetic engine oil, such as Mobil 1® SAE 0W-40.

Engine Oil Identification (API) Symbol

There is a symbol to aid you in selecting the proper engine oil.



This symbol means that the oil has been certified by the American Petroleum Institute (API). We only recommend synthetic API Certified engine oils, such as Mobil 1®, that meet the requirements of Material Standard MS-10725. Use Mopar or an equivalent oil meeting the specification MS-10725.

Engine Oil Viscosity Chart

The proper SAE viscosity grade of engine oil should be selected based on the following recommendation and be within the operating temperature shown in the engine oil viscosity chart.

ENGINE OIL VISCOSITY CHART								
°F	-20°	0°	10°	20°	32°	60°	80°	100°
°C	-29°	-18°	-12°	-7°	0°	16°	27°	38°
Temperature range anticipated before next oil change								
<small>813eda54</small>								

Synthetic Engine Oils

There are a number of engine oils being promoted as either synthetic or semi-synthetic. If you chose to use such a product, use **only** those oils that meet the American Petroleum Institute (API) and SAE viscosity standard. Follow the service schedule that describes your driving type.

Materials Added to Engine Oil

Do not add any materials (other than leak detection dyes) to engine oil. Engine oil is an engineered product and its performance may be impaired by supplemental additives.

Disposing of Used Engine Oil And Oil Filters

Care should be taken in disposing of used engine oil and oil filters from your vehicle. Used oil and oil filters, indiscriminately discarded, can present a problem to the environment. Contact your dealer, service station, or governmental agency for advice on how and where used oil and oil filters can be safely discarded in your area.

Engine Oil Filter

The engine oil filter should be replaced at every engine oil change.

Engine Oil Filter Selection

The manufacturer's engines have a full-flow type oil filter. Use a filter of this type for replacement. The quality

of replacement filters varies considerably. Only high quality filters should be used to assure most efficient service. Mopar Engine Oil Filters are a high quality oil filter and are recommended.

Drive Belts — Check Condition and Tension

At the mileage indicated in the maintenance schedule, all belts should be checked for condition and proper tension. Improper belt tension can cause belt slippage and failure.

Belts should be inspected for evidence of cuts, cracks, or glazing, and replaced if there is indication of damage which could result in belt failure. If adjustment is required, see your authorized dealer for service. Low generator belt tension can cause battery failure. A special tool is required to properly measure tension and to restore belt tension to factory specifications.

Also check belt routing to make sure there is no interference between the belts and other engine components.

Spark Plugs

Spark plugs must fire properly to assure engine performance and emission control. New plugs should be installed at the specified mileage. The entire set should be replaced if there is any malfunction due to a faulty spark plug, malfunctioning spark plugs can damage the catalytic converter. For proper type of replacement spark plugs, refer to the "Vehicle Emission Control Information" label in the engine compartment.

Engine Air Cleaner Filter

Under normal driving conditions, replace the air filter at the intervals shown on Schedule "A". If, however, you drive the vehicle frequently under dusty or severe conditions, the filter element should be inspected periodically and replaced if necessary at the intervals shown on Schedule "B".

WARNING!

The air cleaner can provide a measure of protection in the case of engine backfire. Do not remove the air cleaner unless such removal is necessary for repair or maintenance. Make sure that no one is near the engine compartment before starting the vehicle with the air cleaner removed. Failure to do so can result in serious personal injury.

Engine Fuel Filter

A plugged fuel filter can cause stalling, limit the speed at which a vehicle can be driven or cause hard starting. Should an excessive amount of dirt accumulate in the fuel tank, frequent filter replacement may be necessary.

Catalytic Converter

The catalytic converter requires the use of unleaded fuel only. Leaded gasoline will destroy the effectiveness of the catalyst as an emission control device.

Under normal operating conditions, the catalytic converter will not require maintenance. However, it is important to keep the engine properly tuned to assure proper catalyst operation and prevent possible catalyst damage.

CAUTION!

Damage to the catalytic converter can result if your vehicle is not kept in proper operating condition. In the event of engine malfunction, particularly involving engine misfire or other apparent loss of performance, have your vehicle serviced promptly. Continued operation of your vehicle with a severe malfunction could cause the converter to overheat, resulting in possible damage to the converter and the vehicle.

NOTE: Intentional tampering with emissions control systems can result in civil penalties being assessed against you.

WARNING!

A hot exhaust system can start a fire if you park over materials that can burn. Such materials might be grass or leaves coming into contact with your exhaust system. Do not park or operate your vehicle in areas where your exhaust system can contact anything that can burn.

In unusual situations involving grossly malfunctioning engine operation, a scorching odor may indicate severe and abnormal catalyst overheating. If this occurs, the vehicle should be stopped, the engine shut off and the vehicle allowed to cool. Thereafter, service, including a tune-up to manufacturer's specifications, should be obtained immediately.

To minimize the possibility of catalyst damage:

- Do not shut off the engine or interrupt the ignition when the transmission is in gear and the vehicle is in motion.
- Do not try to start engine by pushing or towing the vehicle.
- Do not idle the engine with any spark plug wires disconnected or removed, such as when diagnostic testing, or for prolonged periods during very rough idling or malfunctioning operating conditions.

Crankcase Emission Control System



Proper operation of this system depends on freedom from plugging due to deposits. As vehicle mileage builds up, the Crankcase Ventilation Valve orifice may accumulate deposits. If a valve is not working properly, replace it with a new orifice. **DO NOT ATTEMPT TO CLEAN THE OLD ORIFICE!**

Check the ventilation hose for indication of damage or plugging deposits. Replace if necessary.

Maintenance Free Battery

The top of the maintenance free battery is permanently sealed. You will never have to add water, nor is periodic maintenance required.

To determine the battery charge, check the battery test indicator (if equipped) on top of the battery. If the test indicator (if equipped) appears light or yellow, replace the battery.

BATTERY CONDITION INDICATOR	O.K. TO JUMP START	 	DARKENED INDICATOR WITH GREEN DOT • BATTERY CHARGE OK • FLUID LEVEL OK DARKENED INDICATOR NO GREEN DOT • BATTERY CHARGE LOW • FLUID LEVEL OK
	DO NOT JUMP START		YELLOW OR BRIGHT INDICATOR • BATTERY CHARGE UNKNOWN • FLUID LEVEL LOW (CHARGE MAY STILL BE SUFFICIENT TO START YOUR CAR)

WARNING!

Battery fluid is a corrosive acid solution and can burn or even blind you. Don't allow battery fluid to contact your eyes, skin or clothing. Don't lean over a battery when attaching clamps. If acid splashes in eyes or on skin, flush the area immediately with large amounts of water.

Battery gas is flammable and explosive. Keep flame or sparks away from the battery. Don't use a booster battery or any other booster source with an output greater than 12 volts. Don't allow cable clamps to touch each other.

Battery posts, terminals and related accessories contain lead and lead compounds. Wash hands after handling.

CAUTION!

It is essential when replacing the cables on the battery that the positive cable is attached to the positive post and the negative cable is attached to the negative post. Battery posts are marked (+) positive and negative (-) and identified on the battery case. Also, if a "fast charger" is used while battery is in vehicle, disconnect both vehicle battery cables before connecting the charger to battery. Do not use a "fast charger" to provide starting voltage.

Air Conditioner

For best possible performance, your air conditioner should be checked and serviced by an Authorized Dealer at the start of each warm season. This service should include cleaning of the condenser fins and a system performance check. Drive belt tension should also be checked at this time.

WARNING!

- Use only refrigerants approved by the manufacturer for your air conditioning system. Some unapproved refrigerants are flammable and can explode, injuring you. Other unapproved refrigerants can cause the system to fail, requiring costly repairs.
- Never add air conditioning refrigerant to correct a non-cooling problem unless pressure gauges are connected to the system by a certified technician. Lack of cooling could be due to a restriction and adding refrigerant may cause a dangerous pressure rise and you could be injured.

Refrigerant Recovery And Recycling

The air conditioning system of your vehicle contains R-134a, a refrigerant that does not deplete the ozone layer in the upper atmosphere. The manufacturer recommends

that air conditioning service be done by facilities using refrigerant recycling and recovery equipment that meets SAE standard J1991.

Power Steering — Fluid Check

Checking the power steering fluid level at a defined service interval is not required. The fluid should only be checked if a leak is suspected, abnormal noises are apparent, and/or the system is not functioning as anticipated. Coordinate inspection efforts through a certified DaimlerChrysler Dealership."

WARNING!

Fluid level should be checked on a level surface and with the engine off to prevent injury from moving parts and to insure accurate fluid level reading. Do not overfill. Use only manufacturers recommended power steering fluid.

If necessary, add fluid to restore to the proper indicated level. With a clean cloth, wipe any spilled fluid from all surfaces. Refer to Recommended Fluids, Lubricants, and Genuine Parts for correct fluid type.

Front Suspension Ball Joints

The ball joints and seals should be inspected whenever the vehicle is serviced for other reasons.

The ball joints originally supplied with the vehicle are permanently lubricated at the factory and do not require

service. However, if the seals on the ball joints are damaged, the joints should be replaced. Serviceable replacement ball joints are available.

Front suspension ball joints should be replaced only by a qualified service technician using tools specially designed for this purpose. Damage to the joints and/or suspension components may result if improper replacement procedures are used.

If seals are damaged the ball joints should be replaced to prevent leakage or contamination of the grease.

Steering Linkage — Inspection

Whenever the vehicle is hoisted, all steering linkage joints should be inspected for evidence of damage. If seals are damaged, parts should be replaced to prevent leakage or contamination of the grease. Lubricate the steering linkage regularly according to the "Maintenance Schedule" in this manual.

Body Lubrication

Locks and all body pivot points, including such items as seat tracks, doors, tailgate and hood hinges, should be lubricated periodically to assure quiet, easy operation and to protect against rust and wear. Prior to the application of any lubricant, the parts concerned should be wiped clean to remove dust and grit; after lubricating excess oil and grease should be removed. Particular attention should also be given to hood latching components to insure proper function. When performing other underhood services, the hood latch, release mechanism and safety catch should be cleaned and lubricated.

The external lock cylinders should be lubricated twice a year, preferably in the fall and spring. Apply a small amount of a high quality lubricant such as Mopar® Lock Cylinder Lubricant directly into the lock cylinder.

Windshield Wiper Blades

The rubber edges of the wiper blades and the windshield should be cleaned periodically with a sponge or soft cloth and a mild nonabrasive cleaner. This will remove accumulations of salt or road film.

Operation of the wipers on dry glass for long periods may cause deterioration of the wiper blades. Always use washer fluid when using the wipers to remove salt or dirt from a dry windshield.

Avoid using the wiper blades to remove frost or ice from the windshield. Keep the blade rubber out of contact with petroleum products such as engine oil, gasoline, etc.

Windshield Washers

The fluid reservoir is located under the hood and should be checked for fluid level at regular intervals. Fill the reservoir with windshield washer solvent only (not radiator antifreeze).

To prevent freeze-up of your windshield washer system in cold weather, select a solution or mixture that meets or exceeds the temperature range of your climate. This rating information can be found on most washer fluid containers.

WARNING!

Commercially available windshield washer solvents are flammable. They could ignite and burn you. Care must be exercised when filling or working around the washer solution.

After the engine has warmed, operate the defroster for a few minutes to reduce the possibility of smearing or freezing the fluid on the cold windshield. Mopar All Weather Windshield Washer Solution, used with water as

directed on the container, aids cleaning action, reduces the freezing point to avoid line clogging, and is not harmful to paint or trim.

Exhaust System

The best protection against carbon monoxide entry into the vehicle body is a properly maintained engine exhaust system.

Whenever a change is noticed in the sound of the exhaust system, when exhaust fumes can be detected inside the vehicle, or when the underside or rear of the vehicle is damaged, have a competent mechanic inspect the complete exhaust system and adjacent body areas for broken, damaged, deteriorated, or mispositioned parts. Open seams or loose connections could permit exhaust fumes to seep into the passenger compartment. In addition, inspect the exhaust system each time the vehicle is raised for lubrication or oil change. Replace as required.

WARNING!

Exhaust gases can injure or kill. They contain carbon monoxide (CO) which is colorless and odorless. Breathing it can make you unconscious and can eventually poison you. To avoid breathing CO, follow the preceding safety tips.

Exhaust System Rubber Isolator and Loop-Type Hanger — If Equipped

Inspect surfaces whenever the vehicle is hoisted for rubber to metal separation or deep cracks. SLIGHT CRACKING DUE TO WEATHERING DOES NOT ADVERSELY AFFECT PERFORMANCE. If, however, excessively deep localized cracks are present, or any part of the exhaust system abnormally contacts the underbody hardware, the isolator and/or hanger should be replaced.

Cooling System**Cooling System Maintenance**

At the intervals shown in the Maintenance Schedules Section of the manual, the system should be drained, flushed and filled.

Inspection

Check engine coolant (antifreeze) protection every 12 months (before the onset of freezing weather, where applicable). If coolant is dirty or rusty in appearance, the system should be drained, flushed and refilled with fresh coolant as specified.

Inspect the entire cooling system for leaks. Check the face of the radiator for any accumulation of bugs, leaves, or other foreign matter. If dirty, clean the radiator core with a garden hose. With the engine OFF, gently spray water from the back of the radiator core.

Check the coolant reserve tank tube for condition and tightness or connections at the reserve tank and radiator.

Check the coolant pressure cap and coolant reserve system for proper vacuum sealing. With the engine at normal operating temperature, note the level of the coolant in the coolant reserve tank. Without removing the pressure cap (with the engine off), drain a small amount of coolant from the radiator draincock. If the coolant level in the reserve tank drops, the system is sealing properly.

Coolant Level

The coolant reserve system provides a quick visual method of determining that the coolant level is adequate. With the engine idling, and warmed to the normal operating temperature, the level of the coolant on the overflow bottle should be between the fluid level marks. Check the coolant level whenever the hood is raised.

The radiator normally remains completely full, so there is no longer a need to remove the coolant pressure cap except for checking coolant freeze point or replacement with new antifreeze coolant.

WARNING!

Never add coolant to the radiator when the engine is overheated. Do not loosen or remove pressure cap to cool an overheated engine! The coolant is under pressure and severe scalding could result.

Drain, Flush And Refill

At intervals shown on the Maintenance Schedules, the system should be drained, flushed and refilled. Refer to your dealer or consult a service manual for proper procedures.

Adding Coolant

When adding coolant, or refilling the system, a minimum solution of 50% recommended HOAT ethylene glycol engine coolant (antifreeze) and distilled water should be used. Use higher concentrations (not to exceed 70%) if temperatures below -34°F (-37°C) are anticipated.

Use only high purity water such as distilled or deionized water when mixing the water/engine coolant solution. The use of lower quality water will reduce the amount of corrosion protection in the engine cooling system.

NOTE: It is the owner's responsibility to maintain the proper level of protection against freezing according to the temperatures occurring in the area where the vehicle is operated.

NOTE: Mixing coolant types will decrease the life of the engine coolant and will require more frequent coolant changes.

When additional coolant is needed to maintain the proper level, add the recommended concentration of antifreeze and water to the overflow bottle. Do not overfill.

NOTE: Failure to follow the antifreeze concentration and replacement recommendations, or failure to use antifreeze formulated to prevent corrosion of all cooling system metals, may result in radiator plugging, overheating, or cooling system leaks such as in core hole plugs.

WARNING!

Never add coolant to the radiator when the engine is overheated. Do not loosen or remove pressure cap to cool an overheated engine. The coolant is under pressure and severe scalding could result.

Recommended Engine Coolant

Refer to Recommended Fluids, Lubricants and Genuine Parts for correct fluid type.

CAUTION!

- **Mixing of coolants other than specified engine coolant, may result in engine damage, and decrease corrosion protection. If a non-HOAT coolant is introduced into the cooling system in an emergency, it should be replaced with the specified coolant as soon as possible.**
- **Do not use plain water alone or alcohol base engine coolant (antifreeze) products. Do not use additional rust inhibitors or antirust products, as they may not be compatible with the radiator engine coolant and may plug the radiator.**
- **This vehicle has not been designed for use with Propylene Glycol based coolants. Use of Propylene Glycol based coolants is not recommended.**

Disposal Of Used Engine Coolant

Used ethylene glycol based engine coolant is a regulated substance requiring proper disposal. Check with your local authorities to determine the disposal rules for your community. Do not store ethylene glycol-based engine coolant in open containers or allow it to remain in puddles on the ground. Prevent ingestion by animals and children. If ingested by a child, contact a physician immediately. Clean up any ground spills immediately.

Coolant Pressure Cap

The coolant pressure cap must be fully tightened to prevent the loss of coolant and to insure that the coolant will return to the radiator from the coolant reserve tank. The pressure cap should be inspected and cleaned if there is any accumulation of foreign material on the sealing surfaces.

WARNING!

The warning words "DO NOT OPEN HOT" on the radiator pressure cap are a safety precaution. Heat causes pressure to build up in the cooling system. To prevent scalding or injury, do not remove the pressure cap.

Hoses And Vacuum/Vapor Harnesses

Inspect surfaces of hoses and nylon tubing for evidence of heat and mechanical damage. Hard or soft spots, brittle rubber, cracking, tears, cuts, abrasions, and excessive swelling indicate deterioration of the rubber.

Pay particular attention to those hoses nearest to high heat sources such as the exhaust manifold. Inspect hose routing to be sure hoses do not come in contact with any heat source or moving component which may cause heat damage or mechanical wear.

Insure nylon tubing in these areas has not melted or collapsed.

Inspect all hose connections such as clamps and couplings to make sure they are secure and no leaks are present.

Components should be replaced immediately if there is any evidence of wear or damage that could cause failure.

Brake System**Power Disc Brakes (front and rear)**

Disc brakes do not require adjustment; however, several hard stops during the break-in period are recommended to seat the linings and wear off any foreign material.

Brake Master Cylinder

The fluid level of the master cylinder should be checked when performing under the hood service, or immediately if the brake system warning lamp indicates system failure.

The brake master cylinder has a translucent plastic reservoir. On the outboard side of the reservoir, there is a "MAX" dot and an "MIN" dot. The fluid level must be kept within these two dots. Do not add fluid above the MAX mark, because leakage may occur at the cap.

With disc brakes the fluid level can be expected to fall as the brake linings wear. However, an unexpected drop in fluid level may be caused by a leak and a system check should be conducted.

Refer to Recommended Fluids, Lubricants and Genuine Parts for the correct Fluid type.

WARNING!

Use of a brake fluid that may have a lower initial boiling point, or is unidentified as to specification, may result in sudden brake failure during hard prolonged braking. You could have an accident.

WARNING!

Overfilling the brake fluid reservoir can result in spilling brake fluid on hot engine parts and the brake fluid catching fire.

Use only brake fluid that has been in a tightly closed container to avoid contamination from foreign matter or moisture.

CAUTION!

Do not allow a petroleum-base fluid to contaminate the brake fluid. Seal damage may result.

Brake Hoses

Inspection should be performed whenever the brake system is serviced or at intervals specified. Inspect hydraulic brake hoses for surface cracking, scuffing or worn spots. If there is any evidence of cracking, scuffing, or worn spots, the hose should be replaced immediately! Eventual deterioration of the hose can take place with possible burst failure.

Clutch Hydraulic System

The clutch hydraulic system is a sealed maintenance-free system. In the event of leakage or other malfunction, the system must be replaced.

Clutch Linkage

If the clutch pedal linkage begins to squeak or grunt, the clutch pedal pivot bushings should be lubricated. Refer to Recommended Fluids, Lubricants and Genuine Parts for the correct lubricant type.

Propeller Shaft Universal Joints

Cross Type (No fittings) — Relubrication of this type of universal joint is not required. The seals should be inspected for external leaks or damage. If external leaks or damage is evident, the universal joint should be replaced.

Rear Axle Fluid Level

Refer to Recommended Fluids, Lubricants and Genuine Parts for the correct Fluid type. For normal service, periodic fluid level checks are not required. When the vehicle is serviced for other reasons the exterior surfaces of the axle assembly should be inspected. If gear oil leakage is suspected inspect the fluid level.

This inspection should be made with the vehicle in a level position. The fluid level should be $3/4'' \pm 1/4''$ below the plug on DANA M60 HD/248 mm rear axles.

Drain and Refill

Vehicles operated in normal service do not have regularly scheduled oil changes. If fluid has become contaminated with water or to provide the correct viscosity grade, drain and refill.

Lubricant Selection

Refer to Recommended Fluids, Lubricants and Genuine Parts for correct fluid type.

NOTE: The presence of water in the gear lubricant will result in corrosion and possible failure of differential components. Operation of the vehicle in water, as may be encountered in some off-highway types of service, will require draining and refilling the axle to avoid damage.

Manual Transmission

Lubricant Selection

Refer to the Recommended Fluids, Lubricants and Genuine Parts section for correct fluid type.

CAUTION!

Using a transmission fluid other than the manufacturer's recommended fluid may cause deterioration in transmission shift quality. Refer to the Recommended Fluids, Lubricants and Genuine Parts section for correct fluid type.

7

Fluid Level Check

The fluid in the transmission should be checked whenever other underhood services are done. Check the fluid level by removing the fill plug located on the left side of

the transmission. The fluid level should be at the bottom of the fill hole. Add fluid, if necessary, to maintain the proper level.

Frequency of Fluid Change

Under normal operating conditions, the fluid installed at the factory will give satisfactory lubrication for the life of the vehicle. If the vehicle is operated under severe conditions, change the fluid as specified in Maintenance Schedule **B**. If contaminated with water, the fluid should be changed immediately.

Automatic Transmission

Fluid Level Check

The fluid level should be checked when the engine is fully warmed up and the fluid in the transmission is at normal operating temperature. Operation of the transmission with an improper fluid level will greatly reduce the life of the transmission and of the fluid. Check the fluid level whenever the vehicle is serviced.

Procedure For Checking Fluid Level

To properly check the automatic transmission fluid level, the following procedure must be used:

1. The vehicle must be on level ground.
2. The engine should be running at curb idle speed for a minimum of 60 seconds.
3. Fully apply parking brake.
4. Place the gear selector briefly in each gear position ending with the lever in N (Neutral).
5. Remove the dipstick and determine if the fluid is hot or warm. Hot fluid is approximately 180°F (82°C) which is the normal operating temperature after the vehicle has been driven at least 15 miles. The fluid can not be comfortably held between the finger tips. Warm is when fluid is between 85° - 125°F (29° - 52°C).

6. Wipe the dipstick clean and reinsert until seated. Remove dipstick and note reading.

- a. If the fluid is hot, the reading should be in the crosshatched area marked "OK".
- b. If the fluid is warm, the reading should be between the two holes. If the fluid level indicates low, add sufficient fluid to bring to the proper level.

Fluid is added through the dipstick tube.

NOTE: To prevent dirt and water from entering the transmission after checking or replenishing fluid, make certain that the dipstick cap is properly seated.

Selection Of Lubricant

Refer to Recommended Fluids, Lubricants and Genuine Parts for the correct lubricant type. It is important that the transmission fluid be maintained at the prescribed level using the recommended fluid.

CAUTION!

Using a transmission fluid other than the manufacturers recommended fluid may cause deterioration in transmission shift quality and/or torque converter shudder. Using a transmission fluid other than the manufacturers recommended fluid will result in more frequent fluid and filter changes. Refer to Recommended Fluids, Lubricants and Genuine Parts for correct fluid type.

Automatic Transmission Fluid and Filter Change

To obtain best performance and long life for automatic transmissions, the manufacturer recommends that you follow the maintenance schedule that applies to your type of driving (Refer to the Maintenance Schedule Section 8).

It is important that proper lubricant is used in the transmission. Refer to Recommended Fluids, Lubricants and Genuine Parts for the correct lubricant type. A band adjustment and filter change should be made at the time of the oil change.

The fluid and filter should be changed and the bands adjusted as specified in the Maintenance Schedule (Section 8). Vehicles having severe usage should follow Maintenance Schedule "B" of the Maintenance Schedule (Section 8).

NOTE: If the transmission is disassembled for any reason, the fluid and filter should be changed, and the bands adjusted.

Special Additives

The manufacturer recommends against the addition of any additives to the transmission. Exception to this

policy is the use of special dyes to aid in detecting fluid leaks. The use of transmission sealers should be avoided, since they may adversely affect seals.

Front Wheel Bearings

Front wheel bearings for all Dodge Ram Trucks are sealed-for-life. They do not require greasing or seal replacement. In some instances, these bearings will "purge" excess grease and the bearing will look slightly wet. This is normal. Periodic inspection for excess play is recommended.

Selection of Lubricating Grease

The National Lubricating Grease Institute (NLGI) has developed a symbol (Certification Mark) to aid the vehicle owner in the proper selection of grease for the lubrication of wheel bearings and chassis components. This symbol (an example is shown below) is located on the grease container and identifies the application and quality of the grease.



There are two groups identified, those for wheel bearings (Letter "G") and those for chassis (Letter "L") lubrication. Performance categories within these groups result in dual letter designations for each group. The letter designations shown in the example are the highest quality level available and when combined as shown can be used for both wheel bearing and chassis lubrication. Use only those greases that have the NLGI symbol on the container along with the proper quality level for your application.

Appearance Care and Protection from Corrosion

Protection of Body and Paint from Corrosion

Vehicle body care requirements vary according to geographic locations and usage. Chemicals that make roads passable in snow and ice, and those that are sprayed on trees and road surfaces during other seasons, are highly corrosive to the metal in your vehicle. Outside parking, which exposes your vehicle to airborne contaminants, road surfaces on which the vehicle is operated, extreme hot or cold weather and other extreme conditions will have an adverse effect on paint, metal trim, and underbody protection.

The following maintenance recommendations will enable you to obtain maximum benefit from the corrosion resistance built into your vehicle.

What Causes Corrosion?

Corrosion is the result of deterioration or removal of paint and protective coatings from your vehicle.

The most common causes are:

- Road salt, dirt and moisture accumulation.
- Stone and gravel impact.
- Insects, tree sap and tar.
- Salt in the air near seacoast localities.
- Atmospheric fallout/industrial pollutants.

Washing

- Wash your vehicle regularly. Always wash your vehicle in the shade using a mild car wash soap, and rinse the panels completely with clear water.
- If insects, tar or other similar deposits have accumulated on your vehicle, wash it as soon as possible.
- Use Mopar® auto polish to remove road film and stains and to polish your vehicle. Take care never to scratch the paint.

- Avoid using abrasive compounds and power buffing that may diminish the gloss or thin out the paint finish.

CAUTION!
Do not use abrasive or strong cleaning materials such as steel wool or scouring powder, which will scratch metal and painted surfaces.

Special Care

- If you drive on salted or dusty roads or if you drive near the ocean, hose off the undercarriage at least once a month.
- It is important that the drain holes in the lower edges of the doors, rocker panels and tailgate be kept clear and open.

- If you detect any stone chips or scratches in the paint, touch them up immediately. The cost of such repairs is considered the responsibility of the owner.
- If your vehicle is damaged due to an accident or similar cause which destroys the paint and protective coating have your vehicle repaired as soon as possible. The cost of such repairs is considered the responsibility of the owner.
- All wheels and wheel trim, especially aluminum and chrome plated wheels should be cleaned regularly with mild soap and water to prevent corrosion. To remove heavy soil, select a nonabrasive, non-acidic cleaner. Do not use scouring pads, steel wool, a bristle brush or metal polishes. Only Mopar cleaners are recommended. Do not use oven cleaner. Avoid automatic car washes that use acidic solutions or harsh brushes that may damage the wheels' protective finish.
- If you carry special cargo such as chemicals, fertilizers, de-icer salt, etc., be sure that such materials are well packaged and sealed.
- If a lot of driving is done on gravel roads, consider mud or stone shields behind each wheel.
- Use Mopar® touch up paint on scratches as soon as possible. Your dealer has touch up paint to match the color of your vehicle.

Interior Care

Use Mopar® Fabric Cleaner to clean fabric upholstery and carpeting.

Use Mopar® Vinyl Cleaner to clean vinyl upholstery and trim.

Mopar® Total Clean is specifically recommended for leather upholstery.

Your leather upholstery can be best preserved by regular cleaning with a damp soft cloth. Small particles of dirt can act as an abrasive and damage the leather upholstery and should be removed promptly with a damp cloth. Stubborn soils can be removed easily with a soft cloth and Mopar® Total Clean. Care should be taken to avoid soaking your leather upholstery with any liquid. Please do not use polishes, oils, cleaning fluids, solvents, detergents, or ammonia based cleaners to clean your leather upholstery. Application of a leather conditioner is not required to maintain the original condition.

WARNING!

Do not use volatile solvents for cleaning purposes. Many are potentially flammable, and if used in closed areas they may cause respiratory harm.

Glass Surfaces

All glass surfaces should be cleaned on a regular basis with any commercial household-type glass cleaner. Never use an abrasive type cleaner. Use caution when cleaning inside rear windows equipped with electric defrosters or windshields equipped with a windshield wiper de-icer. Do not use scrapers or other sharp instruments which may scratch the elements.

When cleaning the rear view mirror, spray cleaner on the towel or rag that you are using. Do not spray cleaner directly on the mirror.

Cleaning Plastic Instrument Cluster Lenses

The lenses in front of the instruments in this vehicle are molded in clear plastic. When cleaning the lenses, care must be taken to avoid scratching the plastic.

1. Clean with a wet soft rag. A mild soap solution may be used, but do not use high alcohol content or abrasive cleaners. If soap is used, wipe clean with a clean damp rag.

2. Dry with a soft tissue.

Seat Belt Maintenance

Do not bleach, dye or clean the belts with chemical solvents or abrasive cleaners. This will weaken the fabric. Sun damage will also weaken the fabric.

If the belts need cleaning, use a mild soap solution or lukewarm water. Do not remove the belts from the car to wash them.

Replace the belts if they appear frayed or worn or if the buckles do not work properly.

FUSE AND RELAY CENTER

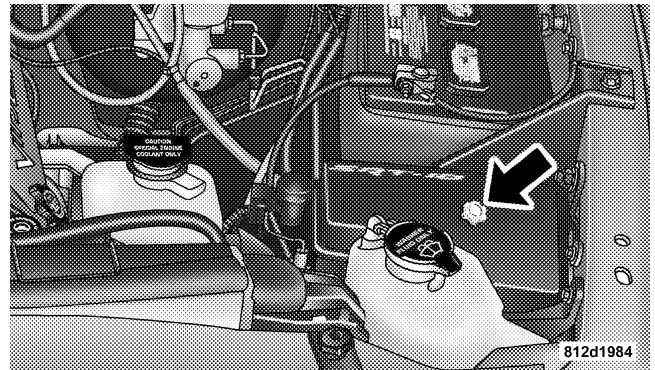

Your vehicle is equipped with a fuse and relay center located in the engine compartment near the battery. Located on the underside of the cover is a label that identifies each component.

1. Disconnect the battery negative (-) cable before removing the cover.

2. Use specified fuses only.
3. Always properly reinstall the cover.

VEHICLE STORAGE

If you are storing your vehicle for more than 21 days, we recommend that you take the following steps to minimize the drain on your vehicle’s battery:

- Disconnect the Ignition-Off Draw fuse (I.O.D.) fuse located in the Fuse and Relay Center, located in the engine compartment. The I.O.D. cavity includes a snap-in retainer that allows the fuse to be disconnected, without removing it from the fuse block.
- As an alternative to the above steps you may, disconnect the negative cables from both batteries.

REPLACEMENT LIGHT BULBS

LIGHT BULBS — Inside	Bulb No.
Overhead Console Lights	TS 212-2
Dome Light.	7679

All of the inside bulbs are brass or glass wedge base. Aluminum base bulbs are not approved.

LIGHT BULBS — Outside	Bulb No.
Back-Up	3057
Center High Mounted Stop Lamp	912
Fog Lamp	9006LL
Headlamp (Halogen)	9007QL
Park & Turn Signal	3157NAK
Rear License Plate Lamp	168
Rear Cargo Light.	912
Tail & Stop	3057
Cab Clearance Lights	168
Dual Rear Wheel Sidemarker Light	168
Dual Rear Wheel Tailgate ID Lights (3)	168

BULB REPLACEMENT**Headlight (Halogen)/Front Park and Turn Lights****CAUTION!**

This is a halogen bulb. Avoid touching the glass with your fingers. Reduced bulb life will result.

1. Remove the two (2) expanding fasteners from the headlight welt.

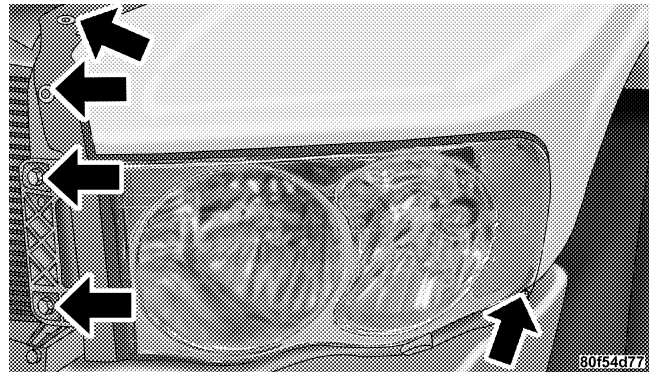

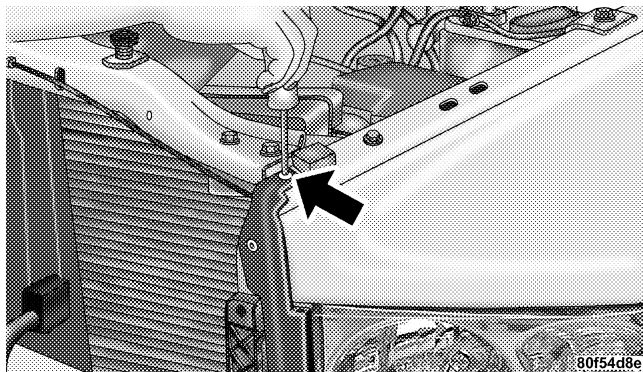

2. Remove the three (3) bolts from the headlight housing.

NOTE: The lower bolt on the driver side headlight also retains the ambient temperature sensor between the headlight assembly and the frame.

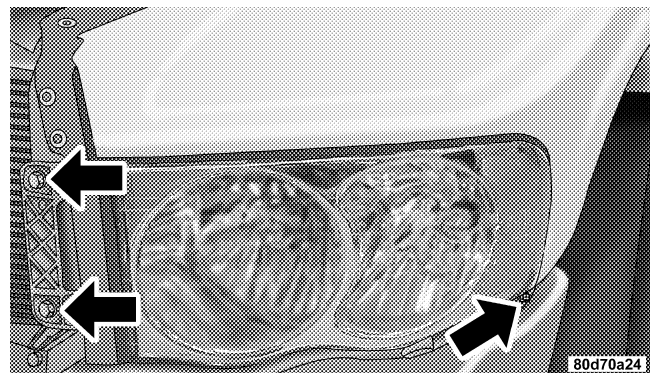

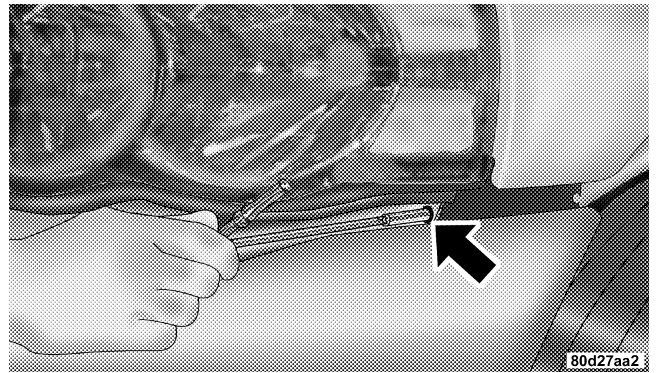
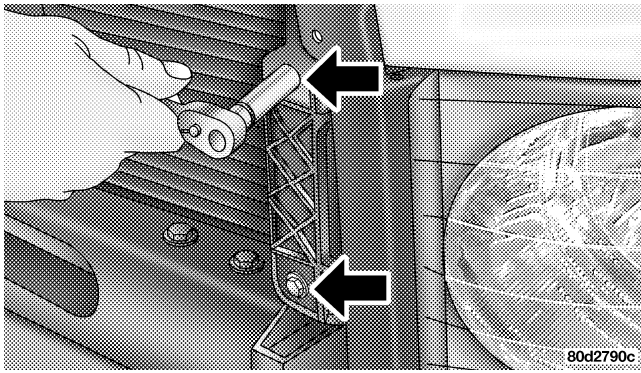

3. Pull the housing out from the fender to allow room to disconnect the electrical connectors.

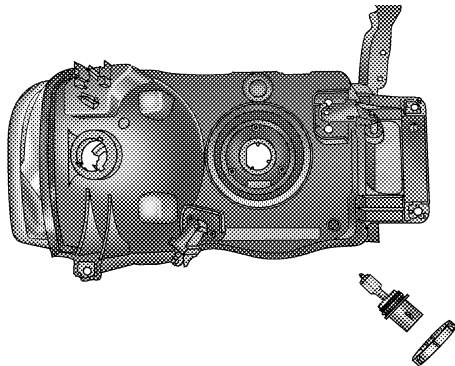

80d27aa4

4. Unlock and pull connector straight from the base of the headlight halogen bulb.

5. Twist connector on turn signal/park light bulb $\frac{1}{4}$ turn and remove connector and bulb from housing.

6. Remove housing from vehicle with headlight halogen bulb in housing.

7. Twist collar on headlight halogen bulb $\frac{1}{4}$ turn and remove headlight bulb from the housing.

8. Replace headlight or turn signal bulb. Do not touch the headlight halogen bulb.

9. Reverse procedure for installation of bulbs and housing.

10. Tighten the outboard fastener first.

Tail, Stop, Turn and Backup Lights

1. Remove the two (2) screws that pass through the bed sheetmetal.

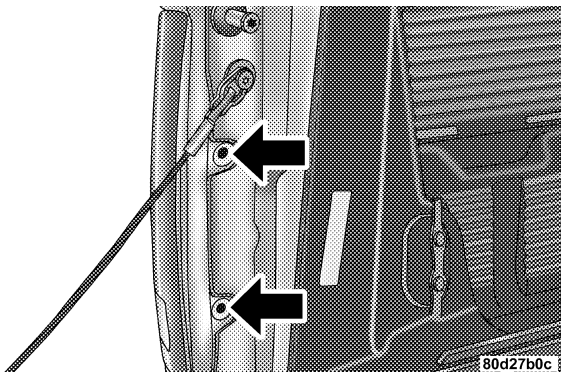

2. Pull the housing straight out from the body, with a quick motion, to separate the housing from the body. If not pulled straight, locators may be damaged.

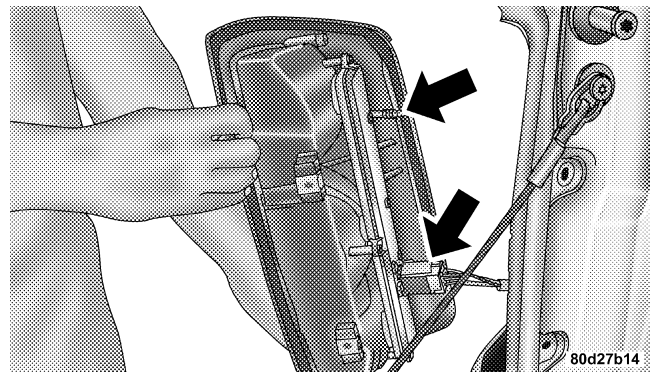

3. Push the red lock slide in on the connector and remove the housing from the vehicle.

4. Remove the four (4) screws from the bulb strip in the housing.

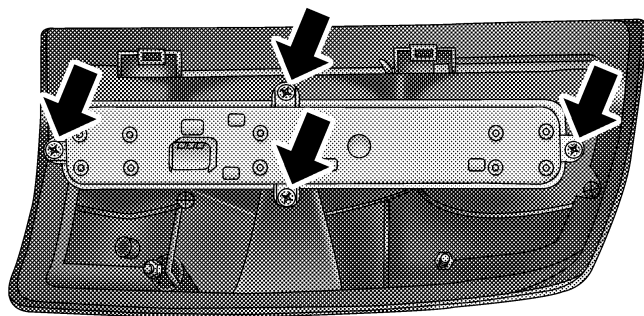

80d27b44

5. Pull the appropriate bulb straight from the bulb strip.

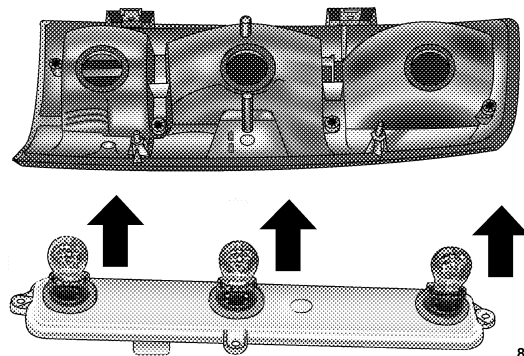

80d27b4e

- Top Bulb: Park/Turn/Hazard
- Center Bulb: Stop/Park/Sidemarker
- Bottom Bulb: Backup Lights

6. Reverse procedure for installation of bulbs and housing.
7. While holding the taillight firmly in place, fasten the top screw first.

Center High-Mounted Stoplight With Cargo Light

1. Remove the two (2) screws holding the housing/lens to the body as shown.

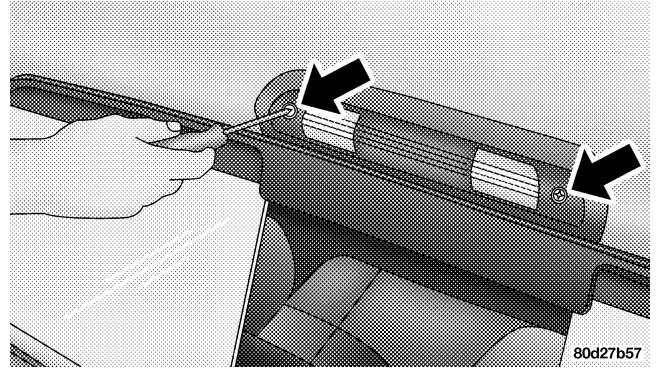

2. Separate the connector holding the housing and wiring harness to the body.

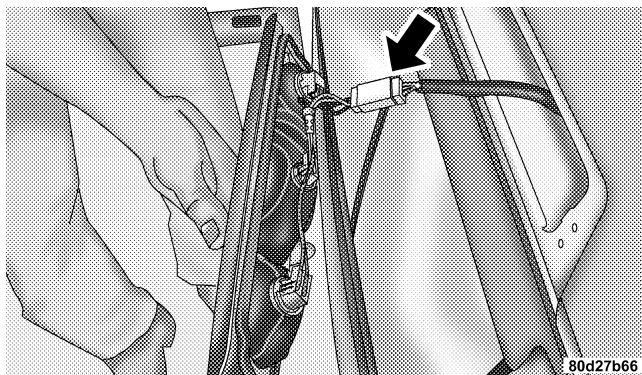

3. Turn desired bulb socket $\frac{1}{4}$ turn and remove socket and bulb from housing.

4. Pull desired bulb straight from the socket.

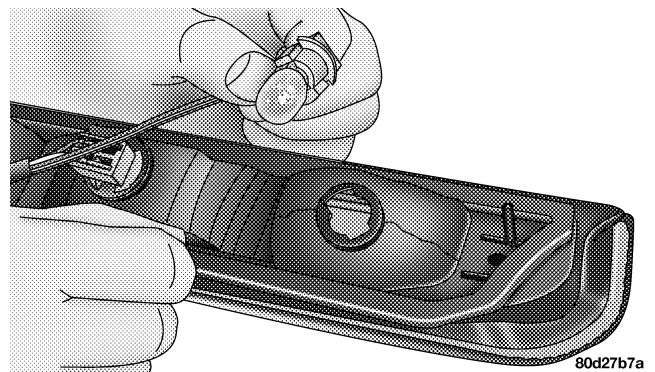

- Outside Bulbs: Cargo Lamps
- Inside Bulb: Center High Mount Stop Lamp

5. Reverse procedure for installation of bulbs and housing.

Fog Lights

1. Reach under the vehicle, unlock and twist connector counterclockwise $\frac{1}{4}$ turn and remove connector and bulb from housing.

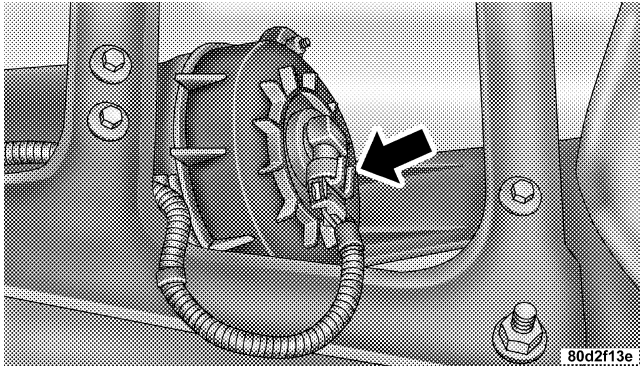

2. Pull bulb straight from the connector.

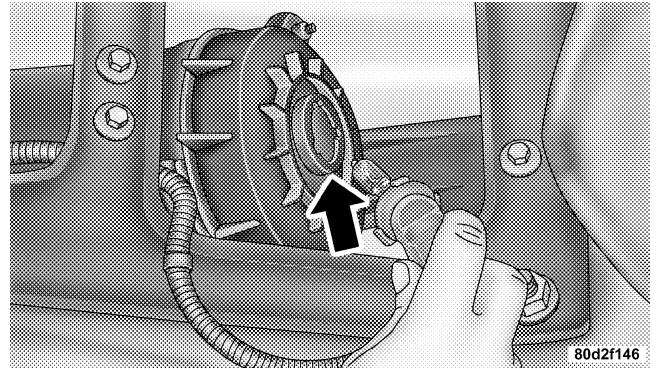

3. Reverse procedure for installation of bulbs and housing.

FLUID CAPACITIES

	U.S.	Metric
Fuel		
SRT-10 Models	26 gal.	98L
Engine Oil (with filter)		
8.3L (SAE 0W-40 MS-10725)	8.5 qts.	8.0L
Cooling System		
8.3L	20 qts.	19L

RECOMMENDED FLUIDS, LUBRICANTS AND GENUINE PARTS**Engine**

Component	Fluids, Lubricants and Genuine Parts
Engine Coolant	Mopar® Antifreeze/Coolant 5 Year/102,000 Mile Formula HOAT (Hybrid Organic Additive Technology) P/N 05066386AA or equivalent.
Engine Oil	We only recommend synthetic engine oils, such as Mobil 1®, that are API Certified and meet the requirements of Material Standard MS-10725.
Engine Oil Filter	Mopar® Engine Oil Filter, P/N 5281090 or equivalent.
Spark Plugs	Refer to the Vehicle Emission Control Information label in the engine compartment.
Fuel Selection	91 Octane, (R+M)/2 Method

Chassis

Component	Fluids, Lubricants and Genuine Parts.
Manual Transmission Fluid	Mopar Synthetic Manual Transmission Lubricant 75W/85W (Castrol Syntorq LT 75W/85W)
Automatic Transmission Fluid	Mopar® ATF+4, Automatic Transmission Fluid.
Clutch Linkage	Multipurpose Grease, NLGI Grade 2 E.P.
Limited-Slip Rear Axle	Mopar® SAE 90W. Limited-Slip Rear Axles require the addition of 147 ml (5 oz.) Mopar® limited slip additive.
Brake Master Cylinder	Mopar® DOT 3 and SAE J1703 should be used. If DOT 3 brake fluid is not available, then DOT 4 or DOT 4+ is acceptable. Use only recommended brake fluids.
Power Steering Reservoir	Mopar® ATF+4, Automatic Transmission Fluid

MAINTENANCE SCHEDULES

CONTENTS

■ Emission Control System Maintenance	294	□ Schedule "B"	297
■ Maintenance Schedules	294	□ Schedule "A"	307

EMISSION CONTROL SYSTEM MAINTENANCE

The “Scheduled” maintenance services, listed in **bold type** in this section (Section 8) must be done at the times or mileages specified to assure the continued proper functioning of the emission control system. These, and all other maintenance services included in this manual, should be done to provide best vehicle performance and reliability. More frequent maintenance may be needed for vehicles in severe operating conditions such as dusty areas and very short trip driving.

Inspection and service also should be done any time a malfunction is suspected.

NOTE: Maintenance, replacement, or repair of the emission control devices and systems on your vehicle may be performed by any automotive repair establishment or individual using any automotive part which has been certified pursuant to U.S. EPA or, in the State of California, California Air Resources Board regulations.

MAINTENANCE SCHEDULES

There are two maintenance schedules that show the **required** service for your vehicle.

First is Schedule “**B**”. It is for vehicles that are operated under the conditions that are listed below and at the beginning of the schedule.

- Day or night temperatures are below 32° F (0° C).
- Stop and go driving.
- Extensive engine idling.
- Driving in dusty conditions.
- Short trips of less than 10 miles (16 km).
- More than 50% of your driving is at sustained high speeds during hot weather, above 90° F C (32°).
- Drag Race Operation.
- Heavy Loading.

- Taxi, police, or delivery service (commercial service).
- Off-road or desert operation.
- **If equipped for and operating with E-85 (ethanol) fuel.**

NOTE: If **ANY** of these apply to you then change your engine oil every 3,000 miles (5 000 km) or 3 months, whichever comes first and follow schedule "B" of the "Maintenance Schedules" section of this manual.

NOTE: If **ANY** of these apply to you then flush and replace your engine coolant every 102,000 miles (163 000 km) or 60 months, whichever comes first and follow schedule "B" of the "Maintenance Schedules" section of this manual.

NOTE: Most vehicles are operated under the conditions listed for Schedule "B".

Second is Schedule "A". It is for vehicles that are not operated under any of the conditions listed under Schedule "B".

Use the schedule that best describes your driving conditions. Where time and mileage are listed, follow the interval that occurs first.

NOTE: Under no circumstances should oil change intervals exceed 6000 miles (10 000 km) or 6 months whichever comes first.

CAUTION!

Failure to perform the required maintenance items may result in damage to the vehicle.

296 MAINTENANCE SCHEDULES

At Each Stop for Fuel

- Check the engine oil level about 5 minutes after a fully warmed engine is shut off. Checking the oil level while the vehicle is on level ground will improve the accuracy of the oil level reading. Add oil only when the level is at or below the ADD or MIN mark.
- Check the windshield washer solvent and add if required.

Once a Month

- Check tire pressure and look for unusual wear or damage.
- Inspect the battery and clean and tighten the terminals as required.
- Check the fluid levels of coolant reservoir, brake master cylinder, and transmission and add as needed.

- Check all lights and all other electrical items for correct operation.

At Each Oil Change

- Change the engine oil filter.
- Inspect the exhaust system.
- Inspect the brake hoses.
- Inspect the CV joints (if equipped) and front suspension components.
- Check the automatic transmission fluid level.
- Check the manual transmission fluid level.
- Check the coolant level, hoses, and clamps.

Schedule "B"

Follow schedule "B" if you usually operate your vehicle under one or more of the following conditions.

- Day or night temperatures are below 32° F (0° C).
- Stop and go driving.
- Extensive engine idling.
- Driving in dusty conditions.
- Short trips of less than 10 miles (16 km).
- More than 50% of your driving is at sustained high speeds during hot weather, above 90° F C (32°).
- Drag Race Operation.
- Heavy Loading.
- Taxi, police, or delivery service (commercial service).
- Off-road or desert operation.
- **If equipped for and operating with E-85 (ethanol) fuel.**

NOTE: If ANY of these apply to you then change your engine oil every 3,000 miles (5 000 km) or 3 months, whichever comes first and follow schedule "B" of the "Maintenance Schedules" section of this manual.

If none of these apply to you, then change your engine oil at every interval shown on schedule "A" of the "Maintenance Schedules" section of this manual.

298 SCHEDULE "B"

Miles (Kilometers)	3,000 (5 000)	6,000 (10 000)	9,000 (14 000)	12,000 (19 000)	15,000 (24 000)
Change engine oil and engine oil filter at interval shown or 3 months, whichever comes first.	X	X	X	X	X
Drain and refill automatic transmission fluid. Replace filter and adjust bands.*					X
Rotate tires.		X		X	
Change rear axle fluid.					X
Inspect brake linings.				X	
Inspect engine air cleaner filter, replace if necessary.					X

Miles (Kilometers)	18,000 (29 000)	21,000 (34 000)	24,000 (38 000)	27,000 (43 000)	30,000 (48 000)
Change engine oil and engine oil filter at interval shown or 3 months, whichever comes first.	X	X	X	X	X
Drain and refill automatic transmission fluid. Replace filter and adjust bands.					X
Rotate tires.	X		X		X
Change rear axle fluid.					X
Inspect brake linings.			X		
Inspect engine air cleaner filter, replace if necessary.					X
Replace spark plugs.					X
Inspect and replace, if necessary, the PCV valve.					X*

300 SCHEDULE "B"

Miles (Kilometers)	33,000 (53 000)	36,000 (58 000)	39,000 (62 000)	42,000 (67 000)	45,000 (72 000)
Change engine oil and engine oil filter at interval shown or 3 months, whichever comes first.	X	X	X	X	X
Drain and refill automatic transmission fluid. Replace filter and adjust bands.*					X
Rotate tires.		X		X	
Change rear axle fluid.					X
Inspect brake linings.		X			
Inspect engine air cleaner filter, replace if necessary.					X

Miles (Kilometers)	48,000 (77 000)	51,000 (82 000)	54,000 (86 000)	57,000 (91 000)	60,000 (96 000)
Change engine oil and engine oil filter at interval shown or 3 months, whichever comes first.	X	X	X	X	X
Drain and refill automatic transmission fluid. Replace filter and adjust bands.					X
Rotate tires.	X		X		X
Change rear axle fluid.					X
Inspect brake linings.	X				X
Inspect engine air cleaner filter, replace if necessary.					X
Replace spark plugs.					X
Replace ignition cables.					X
Inspect and replace, if necessary, the PCV valve.					X*
Flush and replace engine coolant at 60 months, if not done at 102,000 miles (163 000 km)					X

302 SCHEDULE "B"

Miles (Kilometers)	63,000 (101 000)	66,000 (106 000)	69,000 (110 000)	72,000 (115 000)	75,000 (120 000)
Change engine oil and engine oil filter at interval shown or 3 months, whichever comes first.	X	X	X	X	X
Drain and refill automatic transmission fluid. Replace filter and adjust bands.*					X
Rotate tires.		X		X	
Inspect engine air cleaner filter.					X
Change rear axle fluid.					X
Inspect brake linings.				X	
Inspect auto tension drive belt and replace if required.					X

Miles (Kilometers)	78,000 (125 000)	81,000 (130 000)	84,000 (134 000)	87,000 (139 000)	90,000 (144 000)
Change engine oil and engine oil filter at interval shown or 3 months, whichever comes first.	X	X	X	X	X
Drain and refill automatic transmission fluid. Replace filter and adjust bands.					X
Rotate tires.	X		X		X
Change rear axle fluid.					X
Inspect brake linings.			X		
Inspect engine air cleaner filter, replace if necessary.					X
Replace spark plugs.					X
Inspect PCV valve, replace as necessary.					X*
Inspect auto tension drive belt and replace if required.					X†

304 SCHEDULE "B"

Miles (Kilometers)	93,000 (149 000)	96,000 (154 000)	99,000 (158 000)	100,000 (160 000)	102,000 (163 000)
Change engine oil and engine oil filter at interval shown or 3 months, whichever comes first.	X	X	X		X
Rotate tires.		X			X
Flush and replace engine coolant.					X
Flush and replace Power Steering Fluid.				X	
Inspect brake linings.		X			

Miles (Kilometers)	105,000 (168 000)	108,000 (173 000)	111,000 (178 000)	114,000 (182 000)	117,000 (187 000)	120,000 (192 000)
Change engine oil and engine oil filter at interval shown or 3 months, whichever comes first.	X	X	X	X	X	X
Drain and refill automatic transmission fluid. Replace filter and adjust bands.*	X					
Drain and refill automatic transmission fluid. Replace filter and adjust bands.						X
Rotate tires.		X		X		X
Change rear axle fluid.	X					X
Inspect brake linings.		X				X
Inspect engine air cleaner filter, replace if necessary.	X					X
Replace spark plugs.						X
Replace ignition cables.						X
Inspect and replace, if necessary, the PCV valve.						X*

306 SCHEDULE "B"

Miles (Kilometers)	105,000 (168 000)	108,000 (173 000)	111,000 (178 000)	114,000 (182 000)	117,000 (187 000)	120,000 (192 000)
Inspect auto tension drive belt and replace if required.	X‡					X‡

* Drain and refill automatic transmission fluid. Replace filter and adjust bands every 15, 000 miles if vehicle is used for frequent wide open throttle upshifts (For example Drag Racing).

‡ This maintenance is not required if previously replaced. Inspection and service should also be performed anytime a malfunction is observed or suspected. Retain all receipts.

Schedule "A"

Miles (Kilometers) [Months]	6,000 (10 000) [6]	12,000 (19 000) [12]	18,000 (29 000) [18]	24,000 (38 000) [24]	30,000 (48 000) [30]
Change engine oil and engine oil filter.	X	X	X	X	X
Rotate tires.	X	X	X	X	X
Inspect brake linings.			X		
Replace engine air cleaner filter.					X
Replace spark plugs.					X

308 SCHEDULE "A"

Miles (Kilometers) [Months]	36,000 (58 000) [36]	42,000 (67 000) [42]	48,000 (77 000) [48]	54,000 (84 000) [54]	60,000 (96 000) [60]	66,000 (106 000) [66]
Change engine oil and engine oil filter.	X	X	X	X	X	X
Rotate tires.	X	X	X	X	X	X
Flush and replace engine coolant at 60 months, regardless of mileage.					X	
Inspect brake linings.	X			X		
Replace engine air cleaner filter.					X	
Replace spark plugs.					X	
Inspect and replace, if necessary, the PCV valve.					X*	
Replace ignition cables.					X	

Miles (Kilometers) [Months]	72,000 (115000) [72]	78,000 (125 000) [78]	84,000 (134 000) [84]	90,000 (144 000) [90]	96,000 (154 000) [96]	100,000 160 000
Change engine oil and engine oil filter.	X	X	X	X	X	
Drain and refill automatic transmission fluid. Replace filter and adjust bands.						X
Rotate tires.	X	X	X	X	X	
Flush and replace Power Steering Fluid.						X
Inspect brake linings.	X			X		
Replace engine air cleaner filter.				X		
Replace spark plugs.				X		
Inspect and replace, if necessary, the PCV valve.				X*		
Inspect auto tension drive belt and replace if required.				X		

310 SCHEDULE "A"

Miles (Kilometers) [Months]	102,000 (163 000) [102]	108,000 (173 000) [108]	114,000 (182 000) [114]	120,000 (192 000) [120]
Change engine oil and engine oil filter.	X	X	X	X
Rotate tires.	X	X	X	X
Flush and replace engine coolant, if not done at 60 mos.	X			
Flush and replace engine coolant, if not done at 102, 000 miles.				X
Inspect brake linings.		X		
Inspect auto tension drive belt and replace if required.	X‡			X‡
Replace ignition cables.				X
Replace engine air cleaner filter.				X
Replace spark plugs.				X
Inspect and replace, if necessary, the PCV valve.				X*

* This maintenance is recommended by the manufacture to the owner, but is not required to maintain the emissions warranty.

‡ This maintenance is not required if previously replaced.

Inspection and service should also be performed anytime a malfunction is observed or suspected. Retain all receipts.

WARNING!

You can be badly injured working on or around a motor vehicle. Do only that service work for which you have the knowledge and the right equipment. If you have any doubt about your ability to perform a service job, take your vehicle to a competent mechanic.

IF YOU NEED CONSUMER ASSISTANCE

CONTENTS

■ Suggestions For Obtaining Service For Your Vehicle	314	■ Warranty Information	317
□ Prepare For The Appointment	314	■ Mopar® Parts	319
□ Prepare A List	314	■ Reporting Safety Defects	319
□ Be Reasonable With Requests	314	□ In Canada	319
■ If You Need Assistance	315	■ Publication Order Forms	320

SUGGESTIONS FOR OBTAINING SERVICE FOR YOUR VEHICLE

Prepare For The Appointment

If you're having warranty work done, be sure to have the right papers with you. Take your warranty folder. All work to be performed may not be covered by the warranty, discuss additional charges with the service manager. Keep a maintenance log of your vehicle's service history. This can often provide a clue to the current problem.

Prepare A List

Make a written list of your vehicle's problems or the specific work you want done. If you've had an accident, or work done that is not on your maintenance log, let the service advisor know.

Be Reasonable With Requests

If you list a number of items, and you must have your vehicle by the end of the day, discuss the situation with the service advisor and list the items in order of priority. At many dealers you may obtain a rental vehicle at a minimal daily charge. If you need a rental, it is advisable to make these arrangements when you call for an appointment.

IF YOU NEED ASSISTANCE

The manufacturer and its dealers are vitally interested in your satisfaction. We want you to be happy with our products and services.

Warranty service must be done by an authorized Chrysler, Dodge, or Jeep dealer. We strongly recommend that you take your vehicle to your selling dealer. They know you and your vehicle best, and are most concerned that you get prompt and high quality service. The manufacturer's dealers have the facilities, factory-trained technicians, special tools, and the latest information to assure your vehicle is fixed correctly and in a timely manner.

This is why you should always talk to your dealer's service manager first. Most matters can be resolved with this process.

- If for some reason you are still not satisfied, talk to the general manager or owner of the dealership. They want to know if you need assistance.
- If your dealership is unable to resolve the concern, you may contact the Manufacturer's Customer Center.

Any communication to the Manufacturer's Customer Center should include the following information:

- Owner's name and address
- Owner's telephone number (home and office)
- Dealership name
- Vehicle identification number
- Vehicle delivery date and mileage

DaimlerChrysler Motors Corporation Customer Center

P.O. Box 21-8004
Auburn Hills, MI 48321-8004
Phone: (800) 992-1997

DaimlerChrysler Canada Inc. Customer Center

P.O. Box 1621
Windsor, Ontario N9A 4H6
Phone —(800) 465-2001

In Mexico contact:

Av. Prolongacion Paseo de la Reforma, 1240
Sante Fe C.P. 05109
Mexico, D. F.
In Mexico (915) 729-1248 or 729-1240
Outside Mexico (525) 729-1248 or 729-1240

Customer Assistance For The Hearing Or Speech Impaired (TDD/TTY)

To assist customers who have hearing difficulties, the manufacturer has installed special TDD (Telecommunication Devices for the Deaf) equipment at its Customer Center. Any hearing or speech impaired customer who has access to a TDD or a conventional teletypewriter (TTY) in the United States can communicate with the manufacturer by dialing 1-800-380-CHRY.

Service Contract

You may have purchased a service contract for your vehicle to help protect you from the high cost of unexpected repairs after your manufacturer's new vehicle limited warranty expires. The manufacturer stands behind only the manufacturer's Service Contracts. If you purchased a manufacturer's Service Contract, you will receive Plan Provisions and an Owner Identification Card in the mail within three weeks of your vehicle delivery date. If you have any questions about your service

contract, call the manufacturer's Service Contract National Customer Hotline at 1-800-521-9922.

The manufacturer will not stand behind any service contract that is not the manufacturer's Service Contract. It is not responsible for any service contract other than the manufacturer's Service Contract. If you purchased a service contract that is not a manufacturer's Service Contract, and you require service after your manufacturer's new vehicle limited warranty expires, please refer to your contract documents, and contact the person listed in those documents.

We appreciate that you have made a major investment when you purchased your new vehicle. Your dealer has also made a major investment in facilities, tools, and training to assure that you are absolutely delighted with your ownership experience. You'll be pleased with their sincere efforts to resolve any warranty issues or related concerns.

WARRANTY INFORMATION

See your manufacturer's Warranty Information Booklet for information on warranty coverage and transfer of warranty.

318 IF YOU NEED CONSUMER ASSISTANCE

DESCRIPTION	1 Yr/ 12,000	2 Yr/ 24,000	3 Yr/ 36,000	3 Yr/ 50,000	3 Yr/ Unlmtd	5 Yr/ 50,000	5 Yr/ 100,000	7 Yr/ 70,000	7 Yr/ 100,000	8 Yr/ 80,000
Basic Limited Warranty Coverage	██████████									
Special Extended Warranty Coverage										
Anti-Corrosion Perforation Limited Warranty: All Panels	██									
Outer Panels	██									
Federal Emission Warranty - Light Duty Truck	██████████									
Federal Emission Warranty - Specified Components - Light Duty Truck	██									
California Emission Warranty - Light & Medium Duty Truck	████████████████									
California Emission Warranty - Specified Components	██									

2003 DaimlerChrysler Corporation

8131a2da

U.S. Vehicles Only

MOPAR® PARTS

Mopar® fluids, lubricants, parts, and accessories are available from your dealer. They will help you keep your vehicle operating at its best.

REPORTING SAFETY DEFECTS

In the 50 United States and Washington D.C.: If you believe that your vehicle has a defect which could cause a crash or cause injury or death, you should immediately inform the National Highway Traffic Safety Administration (NHTSA) in addition to notifying the manufacturer.

If NHTSA receives similar complaints, it may open an investigation, and if it finds that a safety defect exists in a group of vehicles, it may order a recall and remedy campaign. However, NHTSA cannot become involved in individual problems between you, your dealer, and the manufacturer.

To contact NHTSA, you may either call the Auto Safety Hotline toll free at 1-800-424-9393 (or 366-0123 in Washington DC area) or write to: NHTSA, U.S. Dept. of Transportation, Washington DC 20590. You can also obtain other information about motor vehicle safety from the Hotline.

In Canada:

If you believe that your vehicle has a safety defect, you should contact the Customer Service Department immediately. Canadian customers who wish to report a safety defect to the Canadian government should write to Transport Canada, Motor Vehicle Defect Investigations and Recalls, 2780 Sheffield Road, Ottawa, Ontario K1B 3V9.

PUBLICATION ORDER FORMS

To order the following manuals, you may use either the website or the phone numbers listed below. Visa, Mastercard, American Express, and Discover orders are accepted. If you prefer mailing your payment, please call for an order form.

NOTE: A street address is required when ordering manuals. (No P.O. Boxes).

- *Service Manuals.*

These comprehensive service manuals provide the information that students and professional technicians need in diagnosing/troubleshooting, problem solving, maintaining, servicing and repairing DaimlerChrysler Corporation vehicles. A complete working knowledge of the vehicle, system and/or components is written in straightforward language with illustrations, diagrams and charts.

- *Diagnostic Procedure Manuals.*

Filled with diagrams, charts and detailed illustrations, these practical manuals make it easy for students and technicians to find and fix problems on computer-controlled vehicle systems and features. They show exactly how to find and correct problems the first time, using step-by-step troubleshooting and driveability procedures, proven diagnostic tests and a complete list of all tools and equipment.

- *Owner's Manuals.*

These manuals have been prepared with the assistance of service and engineering specialists to acquaint you with specific Chrysler group vehicles. Included are starting, operating, emergency and maintenance procedures as well as specifications, capabilities and safety tips.

Call Toll Free at 1-800-890-4038 (U.S.) or 1-800-387-1143
(Canada)

Or

Visit us on the World Wide Web at:

www.techauthority.daimlerchrysler.com or
www.daimlerchrysler.ca/manuals

INDEX

Adding Fuel	204,225	Appearance Care	275
Additives, Fuel	203	Ashtray	123
Air Cleaner, Engine (Engine Air Cleaner Filter)	255	Automatic Transmission	272
Air Conditioner Maintenance	259	Adding Fluid	272
Air Conditioning Refrigerant	259	Fluid and Filter Changes	273
Air Conditioning System	259	Fluid Level Check	272
Air Conditioning System, Zone Control	151	Fluid Type	273,292
Air Pressure, Tires	189,197	Shifting	165
Airbag	40,46	Special Additives	274
Airbag Light	65,135	Axle Fluid	213,270,292
Airbag On/Off Switch	46	Axle Lubrication	213,270
Airbag, Side	49	Ball Joints	261
Alarm	24,137	Battery	258
Alignment and Balance	196	Emergency Starting	237
Alterations/Modifications, Vehicle	7	Bearings	274
Antifreeze (Engine Coolant)	267	Belts, Drive	254
Capacities	290	Belts, Seat	29
Anti-Lock Warning Light	138,177	Body Mechanism Lubrication	262
Anti-Theft System	24,137		

B-Pillar Location	184	Caps, Filler	
Brake Fluid	292	Power Steering	260
Brake System	176,268	Car Washes	276
Anti-Lock	177	Carbon Monoxide Warning	64,204
Disc Brakes	268	Cargo Light	97
Hoses	270	Catalytic Converter	206,256
Master Cylinder	268	CD Player	141,144
Parking	175	Cellular Phone	73
Warning Light	138	Center High Mounted Stop Light	287
Break-In Recommendations, New Vehicle	62	Center Lap Belts	37
Bulb Replacement	281	Center Seat Storage Compartment	124
Bulbs, Light	280	Certification Label	208
Button, Start	163	Chart, Tire Sizing	181
Calibration, Compass	110	Check Engine Light (Malfunction Indicator Light)	134
Camper	128	Child Restraint	51
Capacities, Antifreeze (Engine Coolant)	290	Child Restraint Tether Anchors	55,58
Capacities, Fluid	290	Child Seat	51,57
		Cigar Lighter	123
		Clean Air Gasoline	201

Climate Control	151	Radiator Cap	265,267
Clock	141	Selection of Coolant	267,291
Clutch	270	Temperature Gauge	137
Clutch Linkage Maintenance	270	Crankcase Emission Control System	258
Compact Disc Maintenance	150	Cruise Control (Speed Control)	103
Compact Spare Tire	192	Cup Holder	124
Compass	110	Customer Assistance	315
Compass Calibration	110	Daytime Running Lights	96
Compass Variance	112	Dealer Service	249
Computer, Trip/Travel	107	Defroster, Rear Window	73,155
Console, Overhead	106	Delay (Intermittent) Wipers	99
Contract, Service	316	Differential, Limited-Slip	174
Converter, Catalytic	206	Dipsticks	
Cooling System	264	Power Steering	260
Coolant Capacity	290	Disc Brakes	268
Coolant Level	265	Disposal	
Disposal of Used Coolant	267	Engine Oil	267
Drain, Flush, and Refill	265	Door Ajar	136
Inspection	264		

- Door Locks 14
 Door Opener, Garage 113
 Drive Belts 254
- Electric Rear Window Defrost 73,155
 Electrical Power Outlets 122
 Electronic Speed Control 103
 Emergency Brake 175
 Emergency, In Case of
 - Freeing Vehicle When Stuck 241
 - Hazard Warning Flasher 224
 - Jacking 232
 - Jump Starting 237
 - Towing 241
- Emission Control System Maintenance 294
 Engine 246
 - Air Cleaner 255
 - Break-In Recommendations 62
 - Compartment Identification 246
 - Coolant (Antifreeze) 267,291
 - Exhaust Gas Caution 204
 - Flooded, Starting 164
 - Oil 250,291
 - Oil Selection 252
 - Oil Synthetic 253
 - Temperature Gauge 137
- Engine Oil Viscosity 253
 Engine Oil Viscosity Chart 253
 Equipment Identification Plate 222
 Ethylene Glycol Antifreeze 267
 Exhaust Gas Caution 64,204,264
 Exhaust System 64,263,264
 Exterior Lighting 95
- Filters
 - Air Cleaner 255
 - Engine Fuel 255
 - Engine Oil 254,291

Engine Oil Disposal	254	Octane Rating	200,291
Flashers		Tank Capacity	290
Turn Signal	97	Fueling	204
Flat Tire Stowage	231,236	Fuses	279
Flooded Engine Starting	164	Garage Door Opener	113
Fluid, Brake	292	Gas Cap	205
Fluid Capacities	290	Gasoline/Oxygenate Blends	201
Fluid Level Checks		Gauges	138
Manual Transmission	271	Coolant Temperature	137
Power Steering	260	Fuel	140
Fog Lights	96,289	Oil Pressure	136
Four-Way Hazard Flasher	224	Speedometer	136
Freeing A Stuck Vehicle	241	Tachometer	135
Front Axle	270	Voltmeter	135
Front Wheel Bearings	274	Gear Ranges	165
Fuel	200	Glass Cleaning	278
Adding	204	GVWR	208
Filter	255		
Gauge	140		

Hands-Free Phone	73	Key	11,14
Hazard Warning Flasher	224	Lock	14
Head Restraints	90	Infant Restraint	51
Headlights	95,281	Inflation Pressure Tires	197
High Beam	98	Instrument Cluster	133,134
High Beam/Low Beam Select Switch	98	Instrument Panel and Controls	132
Lights On Reminder	96	Instrument Panel Lens Cleaning	278
Passing	98	Interior Appearance Care	277
Switch	95	Intermittent Wipers	99
Heated Mirrors	73,155	Introduction	4
High Beam/Low Beam Select (Dimmer) Switch	98	Jack Location	226
Hitches		Jack Operation	232
Trailer Towing	215	Jump Starting	237
Hoisting	237	Key, Replacement	12
Homelink Transmitter	113	Key, Sentry	11
Hood Release	91	Key-In Reminder	11
Hoses	268	Keyless Entry System	17
Ignition	14,162		

Keys	11,14	Headlights	95
Lane Change and Turn Signals	97	High Beam	98,135
Lap Belts	37	High Beam Indicator	135
Lap/Shoulder Belts	29	High Beam/Low Beam Select	98
LATCH (Lower Anchors and Tether for Children)	55	Instrument Cluster	134
Lights	66,93	Intensity Control	94
Airbag	50,135	Interior	93,106
Anti-Lock Warning	138,177	Lights On Reminder	96
Battery Saver	94	Low Washer Fluid	140
Brake Warning	138	Passing	98
Bulb Replacement	280,281	Seat Belt Reminder	135
Center Mounted Stop	287	Service	280,281
Check Engine	134	Transmission Warning	220
Courtesy/Reading	106	Turn Signal	97,135,281,285
Cruise	137	Warning (Instrument Cluster Description)	134
Daytime Running	96	Limited-Slip Differential	174
Fog	96,289	Loading Vehicle	208
Hazard Warning Flasher	224	Tires	184
		Locks	14

Door	14	Lubricant Selection	292
Ignition	14	Mirrors	71
Keys	11	Automatic Dimming	71
Power Door	14	Electric Powered	72
Steering Wheel	14	Outside	71
Lower Anchors and Tether for CHildren (LATCH)	55	Trailer Towing	219
Lubricants	274	Modifications/Alterations, Vehicle	7
Lubrication, Body	262	Mopar Parts	250,319
Lug Nuts	235	Multi-Function Control Lever	97
Maintenance	250	Occupant Restraints	28
Maintenance Free Battery	258	Odometer	139,140
Maintenance Procedures	250	Trip	139,140
Maintenance Schedule	294	Oil, Engine	250,291
Schedule "A"	307	Capacity	290
Schedule "B"	297	Change Interval	251
Malfunction Indicator Light	248	Dipstick	250
Manual, Service	320	Disposal	254
Manual Transmission	171	Filter	254,291

332 INDEX

Filter Disposal	254	PCV Valve	258
Identification Logo	253	Pedals, Adjustable	102
Materials Added to	254	Phone, Cellular	73
Pressure Gauge	136	Phone, Hands-Free	73
Recommendation	252	Pickup Box	126
Synthetic	253	Placard, Tire and Loading Information	185
Onboard Diagnostic System	247	Power	
Opener, Garage Door	113	Distribution Center	279
Operating Precautions	247	Door Locks	14
Outside Rearview Mirrors	71	Mirrors	72
Overdrive	168,169	Outlet	122
Overdrive OFF Switch	168,169	Seats	88
Overhead Console	106,107	Steering	179,260
Overhead Travel Information Center	107	Sunroof	119
Owner's Manual	320	Windows	26
		Power Steering Fluid	292
Parking Brake	175	Pregnant Women and Seat Belts	40
Passenger Airbag On/Off Switch	46	Pretensioners	
Passing Light	98	Seat Belts	38

Programmable Electronic Features	114,118	Safety Checks Inside Vehicle	65
Programming Transmitters	114,118	Safety Checks Outside Vehicle	66
Radial Ply Tires	192	Safety Defects, Reporting	319
Radiator Cap (Coolant Pressure Cap)	265,267	Safety Information, Tire	179
Radio (Sound Systems)	141	Safety Tips	63
Rear Axle	270	Schedule, Maintenance	294
Recommended Fluids, Lubricants and Genuine Parts	291	Seat Belt Maintenance	279
Reformulated Gasoline	201	Seat Belt Reminder	38
Relays and Flashers	279	Seat Belts	28,29,65
Reminder, Seat Belt	38	Adjustable Upper Shoulder Anchorage	36
Remote Keyless Entry	17	And Pregnant Women	40
Replacement Tires	195	Child Restraint	51,62
Reporting Safety Defects	319	Extender	40
Restraint, Head	90	Front Seat	29
Restraints, Child	51,57	Pretensioners	38
Rotation, Tires	199	Reminder	135
		Seats	86,89
		Adjustment	86
		Child	62

Power	88	Snow Tires	199
Security Alarm (Theft Alarm)	24,137	Spare Tire	192,193
Selection of Coolant	291	Spark Plugs	255
Selection of Oil	252	Speed Control	103
Sentry Key	11	Speedometer	136
Service Assistance	314,315	Start Button	163
Service Contract	316	Starting	163
Service Manuals	320	Engine Fails to Start	164
Setting the Clock	141	Manual Transmission	163
Shift Speeds	173	Steering	
Shifting	165	Column Controls	97
Automatic Transmission	165	Column Lock	14
Manual Transmission	171	Linkage	261
Shoulder Belt Upper Anchorage	36	Power	179,260
Shoulder Belts	29	Wheel, Tilt	101
Side Airbag	49	Storage, Behind the Seat	124
Signals, Turn	97	Storage Compartment, Center Seat	124
Snow Chains (Tire Chains)	197	Storage, Vehicle	280
Snow Plow	221	Storing Your Vehicle	280

Sulfur in Gasoline	202	General Information	188
Sun Roof	119	High Speed	191
Supplemental Tire Pressure Information	197	Inflation Pressures	189
Synthetic Engine Oil	253	Jacking	232
Tachometer	135	Load Capacity	184,185
Tailgate	128	Radial	192
Tether Anchor, Child Restraint	55,58	Replacement	195
Tilt Steering Column	101	Rotation	199
Tire and Loading Information Placard	184,185,197	Safety	179,188
Tire Identification Number (TIN)	183	Sizes	181
Tire Markings	179	Snow Tires	199
Tire Safety Information	179	Spare Tire	231
Tires	66,188	Spinning	194
Air Pressure	188	Tread Wear Indicators	194
Alignment	196	Wheel Mounting	232
Chains	197	Wheel Nut Torque	235
Changing	231	Tongue Weight/Trailer Weight	217
Compact Spare	192	Torque Converter Clutch	171

Towing		Manual	163,171
Disabled Vehicle	241	Shifting	165,173
Guide	218	Transmitter, Garage Door Opener	113
Trailer	213	Tread Wear Indicators	194
Weight	218	Trip Computer	107
Traction	222	Trip Odometer	139,140
Trailer Towing	211	Turn Signals	97,135,281,285
Hitches	215	Underhood Fuses	279
Mirrors	219	Universal Transmitter	113
Tips	219	Variance, Compass	112
Trailer and Tongue Weight	217	Vehicle Identification Number	6
Trailer Towing Guide	218	Vehicle Loading	185,208
Trailer Weight	218	Vehicle Modifications/Alterations	7
Transfer Case		Vehicle Storage	280
Fluid	292	Viscosity, Engine Oil	253
Transmission	271	Voltmeter	135
Automatic	165,272		
Fluid	292		
Maintenance	272		

Warning Lights (Instrument Cluster Description) . . .	134	Windshield Wipers	99
Warnings and Cautions	5	Wiper Blade Replacement	262
Warranty Information	317	Wipers, Intermittent	99
Washers, Windshield	100,262		
Washing Vehicle	276		
Wheel Alignment and Balance	196		
Wheel and Wheel Trim	277		
Wheel Changing	231		
Wheel Mounting	232		
Wheel Nut Torque	235,236		
Wind Buffeting	27,121		
Window Airbag	49		
Window Fogging	156		
Windows	26		
Power	26		
Rear Sliding	27		
Windshield Washers	99,100,262		
Fluid	99,262		
Windshield Wiper Blades	262		

