

TABLE OF CONTENTS

SECTION		PAGE
1	INTRODUCTION	3
2	THINGS TO KNOW BEFORE STARTING YOUR VEHICLE	7
3	UNDERSTANDING THE FEATURES OF YOUR VEHICLE	47
4	UNDERSTANDING YOUR INSTRUMENT PANEL	65
5	STARTING AND OPERATING	93
6	WHAT TO DO IN EMERGENCIES	127
7	MAINTAINING YOUR VEHICLE	139
8	MAINTENANCE SCHEDULES	179
9	IF YOU NEED CONSUMER ASSISTANCE	195
10	INDEX	203

INTRODUCTION

CONTENTS

■ Introduction	4	■ Vehicle Identification Number	6
■ How To Use This Manual	4	■ Vehicle Modifications / Alterations	6
■ Warnings And Cautions	6		

4 INTRODUCTION

INTRODUCTION

This manual has been prepared with the assistance of service and engineering specialists to acquaint you with the operation and maintenance of your new vehicle. It is supplemented by a Warranty Information Booklet and various customer oriented documents. You are urged to read these publications carefully. Following the instructions and recommendations in this manual will help assure safe and enjoyable operation of your vehicle.

NOTE: After you read the manual, it should be stored in the vehicle for convenient reference and remain with the vehicle when sold, so that the new owner will be aware of all safety warnings.

When it comes to service, remember that your dealer knows your vehicle best, has the factory-trained technicians and genuine Mopar® parts, and is interested in your satisfaction.

WARNING!

Engine exhaust, some of its constituents, and certain vehicle components contain or emit chemicals known to the State of California to cause cancer and birth defects or other reproductive harm. In addition, certain fluids contained in vehicles and certain products of component wear contain or emit chemicals known to the State of California to cause cancer and birth defects or other reproductive harm.

HOW TO USE THIS MANUAL

Consult the table of contents to determine which section contains the information you desire.

The detailed index, at the rear of this manual, contains a complete listing of all subjects.

Consult the following table for a description of the symbols that may be used on your vehicle or throughout this owner's manual:

									
TURN SIGNALS	REAR WINDOW WIPER	WINDSHIELD WIPER INTERMITTENT	BRAKE SYSTEM WARNING PARKING BRAKE	HIGH BEAM	HORN	UPPER AIR OUTLET	HEATED SEAT LOW	DOOR LOCK	ADJUSTABLE PEDALS
									
FUEL	REAR WINDOW INTERMITTENT WIPER	WINDSHIELD WASHER	FAILURE OF ANTI-LOCK BRAKING SYSTEM	LOW BEAM	KEY ACTIVATE (POWER OUTLET)	UPPER AND LOWER AIR OUTLET	HEATED SEAT HIGH	WINDOW LIFT	TIRE PRESSURE MONITOR
									
FUEL FILL SIDE	REAR WINDOW WASHER	WINDSHIELD WASHER FLUID LEVEL	SEAT BELT	FRONT FOG LIGHT	HOOD RELEASE	LOWER AIR OUTLET	RECIRCULATION	CONVERTIBLE 4 WINDOW DOWN	VOICE RECOGNITION BUTTON
									
ENGINE OIL	REAR WINDOW DEFROST	WINDSHIELD, ELECTRICALLY HEATED	AIRBAG	EXTERIOR BULB FAILURE	LIFTGATE RELEASE AND LIFTGATE OPEN	DEFROST AND LOWER AIR OUTLET	VENTILATING FAN	POWER STEERING FLUID	UCONNECT™ BUTTON
									
BATTERY CHARGING	HEATED MIRROR	WINDSHIELD DEFROST	SIDE AIRBAG	DOMELIGHT	SLIDING DOOR	TRUNK / DECK RELEASE	AIR CONDITIONING	SEE OWNER'S MANUAL I/O	TRACTION CONTROL
									
ENGINE COOLANT TEMPERATURE	CHILD SEAT TETHER ANCHOR	WINDSHIELD WIPER AND WASHER	HAZARD	PARK LIGHTS	SLIDING DOOR	CONVERTIBLE TOP UP	EMERGENCY RELEASE HANDLE	INSTRUMENT PANEL ILLUMINATION	WARNING
									
MALFUNCTION INDICATOR LIGHT	LOWER ANCHORS AND TETHER FOR CHILDREN (LATCH)	SRS AIRBAG SUPPLEMENTAL RESTRAINT SYSTEM	WINDOW LOCK	LIGHTER	DOOR AJAR	CONVERTIBLE TOP DOWN	PASSENGER AIRBAG OFF	MASTER LIGHTING SWITCH	ESP BAS ELECTRONIC STABILITY PROGRAM / BRAKE ASSIST SYSTEM

6 INTRODUCTION

WARNINGS AND CAUTIONS

This manual contains **WARNINGS** against operating procedures which could result in an accident or bodily injury. It also contains **CAUTIONS** against procedures which could result in damage to your vehicle. If you do not read this entire manual you may miss important information. Observe all Warnings and Cautions.

VEHICLE IDENTIFICATION NUMBER

Vehicle Identification Number (VIN) is found on a laser etched plate, located on the left front corner of the instrument panel, visible through the windshield. This number also appears on the vehicle registration or title.

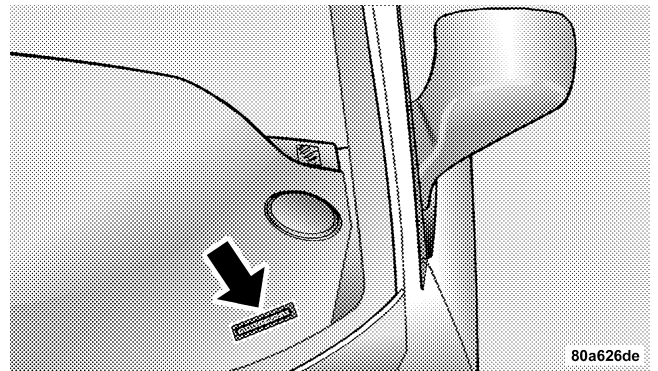

Vehicle Identification Number

VEHICLE MODIFICATIONS / ALTERATIONS

WARNING!

Any modifications or alterations to this vehicle could seriously affect its roadworthiness and safety and may lead to an accident resulting in serious injury or death.

THINGS TO KNOW BEFORE STARTING YOUR VEHICLE

CONTENTS

■ A Word About Your Keys	9	■ Door Locks13
□ Ignition Key Removal	9	□ Manual Door Locks13
□ Locking Doors With The Key10	□ Power Door Locks14
□ Key-In-Ignition Reminder10	□ Central Locking/Unlocking14
■ Sentry Key10	□ Automatic Door Locks15
□ Replacement Keys11	□ Child-Protection Door Lock System (Rear Doors)16
□ Customer Key Programming12	■ Internal Emergency Trunk Lid Release17
□ General Information12	■ Remote Trunk Lid Release17
■ Steering Wheel Lock13	■ Remote Keyless Entry — If Equipped18
□ To Manually Lock The Steering Wheel13	□ To Unlock The Doors18
□ To Release The Steering Wheel Lock13	□ To Lock The Doors18

8 THINGS TO KNOW BEFORE STARTING YOUR VEHICLE

□ Horn Chirp Feature18	□ Lap/Shoulder Belt Untwisting Procedure28
□ To Unlock The Trunk19	□ Seat Belts And Pregnant Women29
□ Using The Panic Alarm19	□ Seat Belt Extender30
□ Programming Additional Transmitters19	□ Driver And Front Passenger Supplemental Restraint System (SRS) - Airbags30
□ General Information20	□ Child Restraint38
□ Transmitter Battery Service20	□ Transporting Pets44
■ Vehicle Theft Alarm21	■ Engine Break-In Recommendations45
□ To Set The Alarm21	■ Safety Tips45
□ To Disarm The System22	□ Exhaust Gas45
□ Security System Manual Override22	□ Safety Checks You Should Make Inside The Vehicle46
■ Power Windows — If Equipped22	□ Periodic Safety Checks You Should Make Outside The Vehicle46
■ Occupant Restraints23		
□ Lap/Shoulder Belts23		
□ Adjustable Upper Shoulder Belt Anchorage27		

A WORD ABOUT YOUR KEYS

The dealer that sold you your new vehicle has the key code numbers for your vehicle locks. These numbers can be used to order duplicate keys from your dealer. Ask your dealer for these numbers and keep them in a safe place.

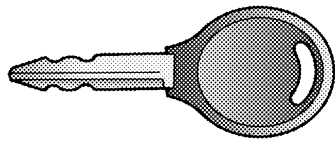

809dc554

The double sided keys may be inserted into the locks with either side up.

Ignition Key Removal

Depress and hold the release button located between the ignition switch and the instrument panel. Turn the ignition key to LOCK and remove the key.

2

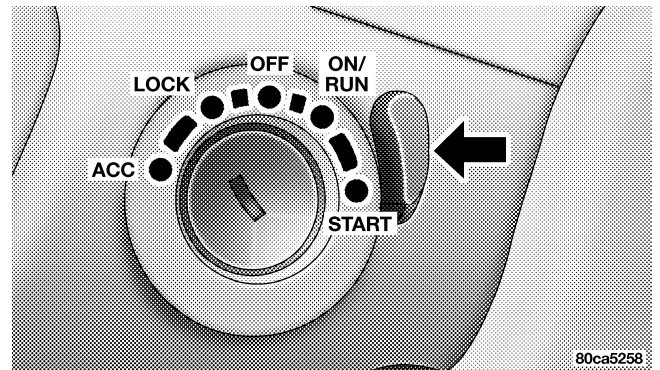

80ca5258

Ignition Key Positions

WARNING!

Leaving children in a vehicle unattended is dangerous for a number of reasons. A child or others could be injured. Children should be warned not to touch the parking brake, brake pedal or the gear selector lever. Don't leave the keys in the ignition. A child could operate power windows, other controls, or move the vehicle.

CAUTION!

An unlocked car is an invitation to thieves. Always remove key from the ignition and lock all doors when leaving the vehicle unattended.

Locking Doors With The Key

You can insert the key with either side up. To lock the door, turn the key rearward. To unlock the door, turn the key forward. See Section 7, Body Mechanism Lubrication of this manual for external lock lubrication.

Key-In-Ignition Reminder

Opening the driver's door when the key is in the ignition switch, sounds a signal to remind you to remove the key.

NOTE: With the driver's door open, and the key in the ignition, the power door locks will not lock via the interior door lock switch.

SENTRY KEY

The Sentry Key Immobilizer System prevents unauthorized operation of the vehicle by disabling the engine. The system will shut the engine off after 2 seconds of running if an invalid key is used to start the vehicle. This system utilizes ignition keys which have an electronic chip (transponder) embedded into them. Only keys that have been programmed to the vehicle can be used to start and operate the vehicle.

The Sentry Key Immobilizer System does not need to be armed or activated. Operation of the system is automatic regardless of whether or not the vehicle is locked or unlocked. During normal operation, the Theft Alarm/Immobilizer Light will come on for three (3) seconds

immediately after the ignition switch is turned on for a bulb check. Afterwards, if the bulb remains on, this indicates a problem with the electronics.

If the bulb begins to flash after the bulb check, this indicates that an invalid key has been used to start the vehicle. Both of these conditions will result in the engine being shut off after two (2) seconds of running.

Keep in mind that a key which has not been programmed is also considered an invalid key even if it is cut to fit the ignition lock cylinder for that vehicle.

If the Theft Alarm/Immobilizer Light comes on during normal vehicle operation (vehicle has been running for longer than 10 seconds), a fault has been detected in the electronics and the vehicle should be serviced as soon as possible.

NOTE:

- The Sentry Key Immobilizer System is not compatible with remote starting systems. Use of these systems may result in vehicle starting problems and loss of security protection.

- Exxon/Mobil Speed Pass,TM additional Sentry Keys, or any other transponder equipped components on the same keychain will **not** cause a key-related (transponder) fault unless the additional part is **physically held against the ignition key** being used when starting the vehicle. Cell phones, pagers, or other RF electronics will not cause interference with this system.

All of the keys provided with your new vehicle have been programmed to the vehicle electronics.

Replacement Keys

NOTE: Only keys that have been programmed to the vehicle electronics can be used to start the vehicle. Once a Sentry Key has been programmed to a vehicle, it can not be programmed to any other vehicle.

At the time of purchase, the original owner is provided with a four digit PIN number. This number is required for dealer replacement of keys. Duplication of keys may be performed at an authorized dealer or by using the Customer Key Programming procedure. This procedure

12 THINGS TO KNOW BEFORE STARTING YOUR VEHICLE

consists of programming a blank key to the vehicle electronics. A blank key is one which has never been programmed.

NOTE: When having the Sentry Key Immobilizer System serviced, bring all vehicle keys with you to the dealer.

Customer Key Programming

You can program new keys to the system if you have two valid sentry keys by doing the following:

1. Cut the additional Sentry Key Transponder blank(s) to match the ignition switch lock cylinder key code.
2. Insert the first valid key into the ignition switch and turn the ignition switch ON for at least 3 seconds but no longer than 15 seconds. Turn the ignition switch OFF and remove the first key.
3. Insert the second valid key and turn the ignition switch ON within 15 seconds. After ten seconds a chime will sound and the Theft Alarm Light will begin to flash. Turn the ignition switch OFF and remove the second key.

4. Insert a blank Sentry Key into the ignition switch and turn the ignition switch ON within 60 seconds. After 10 seconds a single chime will sound. The Theft Alarm Light will stop flashing, turn on again for 3 seconds; then turn off.

The new Sentry Key has been programmed. Repeat this process to program up to a total of 8 keys.

General Information

The Sentry Key system complies with FCC rules part 15 and with RSS-210 of Industry Canada. Operation is subject to the following conditions:

- This device may not cause harmful interference.
- This device must accept any interference that may be received, including interference that may cause undesired operation.

STEERING WHEEL LOCK

Your vehicle is equipped with a passive steering wheel lock. This lock prevents steering the vehicle without the ignition key. If the steering wheel is rotated no more than 1/2 turn in either direction and the key is not in the ignition switch, the steering wheel will lock.

To manually lock the steering wheel:

With the engine running, rotate the steering wheel 1/2 turn, turn off the engine and remove the key. Turn the steering wheel slightly in either direction until the lock engages.

To release the steering wheel lock:

Insert the key in the ignition switch and start the engine. If the key is difficult to turn, rotate the wheel slightly to the right or left to disengage the lock.

NOTE: If you turned the wheel to the right to engage the lock, you must turn the wheel slightly to the right to disengage it. If you turned the wheel to the left to engage the lock, turn the wheel slightly to the left to disengage it.

An unlocked car is an invitation to thieves. Always remove the key from the ignition and lock all the doors when leaving the vehicle unattended.

DOOR LOCKS**Manual Door Locks**

All doors are equipped with a rocker-type interior door lock. To lock a door when leaving your vehicle, press the rocker switch to the LOCK position and close the door.

NOTE: To avoid accidentally locking your keys in the vehicle, make sure you have them with you before closing any door.

WARNING!

For personal security, and safety in the event of an accident, lock the vehicle doors as you drive as well as when you park and leave the vehicle.

WARNING!

When leaving the vehicle always remove the key from the ignition lock, and lock your vehicle. Do not leave children unattended in the vehicle, or with access to an unlocked vehicle. Unsupervised use of vehicle equipment may cause severe personal injuries and death.

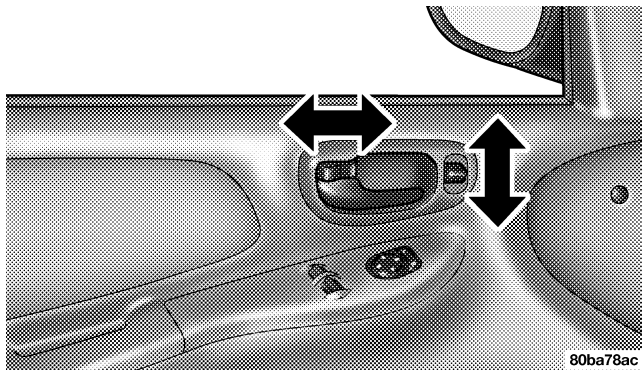

Door Lock Switches

Power Door Locks

A power door lock switch is on each front door panel. Press this switch to lock or unlock the doors.

Central Locking/Unlocking

All vehicle doors are locked with the first turn of the key to the LOCK position. The double activation feature requires you to turn the key in the cylinder lock two times within five seconds to UNLOCK all vehicle doors at once.

You may disable this feature and unlock all the doors with one turn of the key by performing the following procedure:

NOTE: Steps 2 and 3 must be completed within 10 seconds.

1. Close all doors and place the key in the ignition switch.
2. Cycle the ignition switch ON/OFF four times ending in the OFF position.
3. Press the interior door lock switch to the UNLOCK position.

4. A single chime will sound to signify that you have successfully disabled the double activation feature. You can turn the feature back on by repeating the above mentioned procedure.

You can turn the feature back on by repeating the above mentioned procedure.

Automatic Door Locks

The doors will lock automatically if:

1. all doors are closed,
2. vehicle speed is above 15 mph (24 km/h),
3. the accelerator pedal is depressed.

The Automatic Door Locks can be enabled or disabled by performing the following procedure:

1. Close all doors and place the key in the ignition switch.
2. Cycle the ignition switch ON/OFF four times ending in the OFF position.
3. Press the interior door lock switch to the LOCK position.
4. A single chime will sound to signify that you have successfully completed the programming.

You can turn the feature back on by repeating the above mentioned procedure.

Child-Protection Door Lock System (Rear Doors)

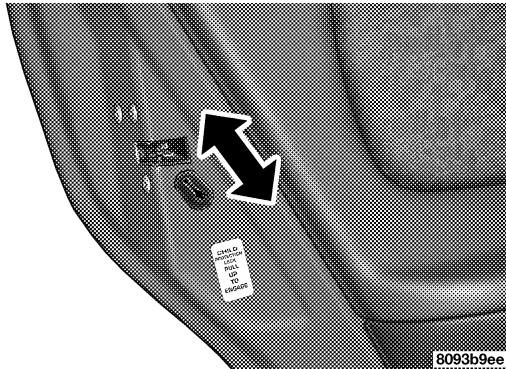

Child Lock Control

To provide a safer environment for children riding in the rear seat, the rear doors of your vehicle have the child-protection door lock system.

To use the system, open each rear door and slide the control UP to engage the locks and DOWN to disengage the child-protection locks. When the system on a door is engaged, that door can only be opened by using the outside door handle even if the inside door lock is in the unlocked position.

WARNING!

Avoid trapping anyone in a vehicle in a collision. Remember that the rear doors can only be opened from the outside when the child protection locks are engaged.

NOTE: For emergency exit with the system engaged, move the door lock rocker switch to the UNLOCK position, roll down the window and open the door with the outside door handle.

INTERNAL EMERGENCY TRUNK LID RELEASE**WARNING!**

Do not allow children to have access to the trunk, either by climbing into the trunk from outside, or through the inside of the vehicle. Always close the trunk lid when your vehicle is unattended. Once in the trunk, young children may not be able to escape, even if they entered through the rear seat. If trapped in the trunk, children can die from suffocation or heat stroke.

As a security measure, a Trunk Internal Emergency Release lever is built into the trunk latching mechanism. In the event of an individual being locked inside the trunk, the trunk can be simply opened by pulling on the glow-in-the-dark lever attached to the trunk latching mechanism. See picture below.

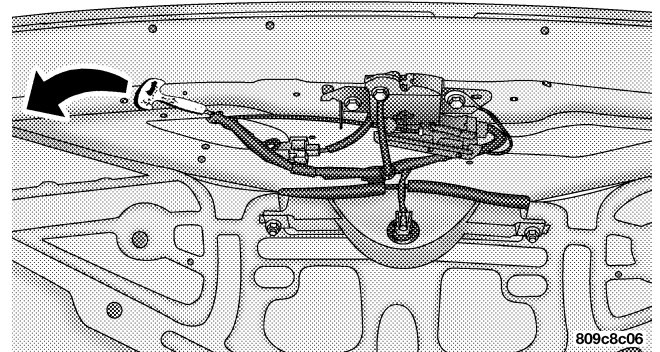

Emergency Release

REMOTE TRUNK LID RELEASE

You can open the trunk from inside the vehicle by pressing a switch located inside the glove compartment.

NOTE: The remote trunk release feature will operate with the ignition switch in all positions. The remote trunk release will not operate above 5 mph.

REMOTE KEYLESS ENTRY — IF EQUIPPED

This system allows you to lock or unlock the doors and trunk or activate the panic alarm from distances up to about 23 feet (7 meters) using a hand held transmitter.

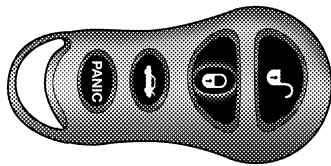

80b31f52

Four Button Transmitter

NOTE: A slight delay of up to two seconds can occur before the doors or trunk will unlock.

To Unlock the Doors

Press and release the UNLOCK button once to unlock the driver's door. Press the button twice within 5 seconds to unlock all doors. The interior lights also come on and remain on for about 30 seconds when you unlock the doors.

NOTE: You may turn off this feature and unlock all doors with one press of the button by following the procedure shown in the Central Locking/Unlocking paragraph.

To Lock the Doors

Press and release the LOCK button to lock all doors. The park/lamps will flash and the horn will chirp to acknowledge the signal.

Horn Chirp Feature

The horn chirp that signals that the doors have been locked can be toggled on or off by using the following procedure:

1. Insert the ignition key and turn the switch to the ON/RUN position.
2. Press and hold the UNLOCK button on the transmitter for 4 to 10 seconds.
3. Continue to hold the UNLOCK button and press the LOCK button.
4. Release both buttons.

A chime will sound to signify that the feature has been successfully completed.

To Unlock the Trunk

Press the TRUNK button on the transmitter twice to unlock the trunk.

NOTE: A slight delay of up to two seconds can occur before the trunk unlatches.

Using The Panic Alarm

To turn on the panic alarm feature, press and release the PANIC button. When the panic alarm is on the headlights and park/lamps will flash, the horn will pulse on and off and the interior lights will turn on.

The panic alarm will stay on for 3 minutes unless you press the PANIC button a second time, or until vehicle speed reaches 15 mph (24 km/h).

NOTE: When you turn off the panic alarm by pressing the PANIC button a second time, you may have to be closer to the vehicle due to the radio frequency noises of the system.

Programming Additional Transmitters

Up to four transmitters can be programmed to your vehicle. Your new vehicle was shipped with two transmitters. See your dealer for additional transmitters.

2

Additional transmitters can be programmed to the system by using the following procedure:

1. Insert the key into the ignition and turn the switch to the RUN position.
2. Press and hold the UNLOCK button on the transmitter for between four and ten seconds.
3. Continue to hold the UNLOCK button and press the PANIC button. A chime will sound to indicate that the transmitter programming mode has been entered.
4. Press a button on all transmitters to be programmed to the system, including any previously programmed transmitters. A chime will sound when each transmitter has been programmed.
5. Turn the ignition switch off to exit the transmitter programming mode.

General Information

This device complies with FCC rules part 15. Operation is subject to the following two conditions: (1) This device may not cause harmful interference and (2) This device must accept any interference that may be received, including interference that may cause undesired operation.

If your transmitter fails to operate from a normal distance, check for these two conditions.

1. Weak batteries in transmitter. The expected life of batteries is from one to two years.
2. Closeness to a radio transmitter such as a radio station tower, airport transmitter, and some mobile or CB radios.

Transmitter Battery Service

The recommended replacement battery is 2016 or its equivalent.

NOTE: Do not touch the battery terminals that are on the back housing or the printed circuit board.

1. With the transmitter buttons facing down, use a thin coin or similar object to pry the two halves of the transmitter apart. Make sure not to damage the rubber gasket during removal.

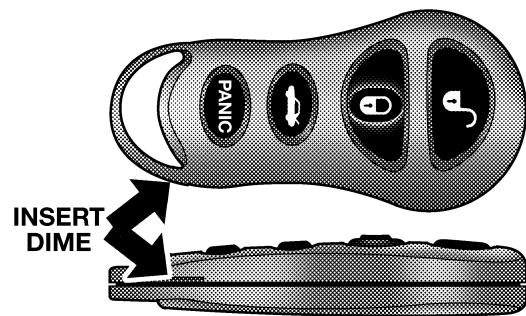

80b31f53

Separating Transmitter Halves

2. Remove and replace the batteries. Avoid touching the new batteries with your fingers. Skin oils may cause battery deterioration. If you touch a battery, clean it with rubbing alcohol.

3. To reassemble the transmitter case, snap two halves together. Make sure there is an even gap between the two halves. Test transmitter operation.

VEHICLE THEFT ALARM

The system monitors the doors, trunk latch, and ignition for unauthorized operation.

If something triggers the alarm, the system will signal for about 18 minutes. For the first 3 minutes the horn will sound and the headlights, park/turn signal lights, tail lights and the indicator light in the cluster will flash. Then the exterior lights will flash for another 15 minutes.

If the monitored system which triggered the alarm is deactivated, the alarm will continue to sound until 3 minutes of alarm time is reached. If the monitored system which triggered the alarm is deactivated after the alarm has been on for 3 minutes, the alarm will shut off immediately.

To set the alarm:

1. Remove the keys from the ignition switch and get out of the vehicle.
2. Lock the door using either the door key, power door lock switch, or the Keyless Entry Transmitter and close all doors.
3. The indicator light in the instrument cluster will flash rapidly for 16 seconds. This shows that the system is arming. During this period, if a door is opened, the ignition switch is turned on, or the power door locks are unlocked in any manner, the system will automatically disarm. If the light comes on but does not flash, the system is arming but there is a problem in the trunk circuit. After 16 seconds the indicator light will flash slowly. This shows that the system is fully armed.

Vehicles equipped with the Sentry Key Immobilizer System can be safely started with a valid key. A valid key is one that is programmed to that particular vehicle. A valid key will disarm the system from the driver's side door, an invalid key will trigger the alarm.

22 THINGS TO KNOW BEFORE STARTING YOUR VEHICLE

NOTE: If the trunk is opened with the key while the system is armed, the alarm will sound.

To disarm the system:

Unlock a front door using either the key or the Keyless Entry Transmitter.

Starting the vehicle with a valid Sentry key will disarm the system.

Tamper Alert

If the horn sounds 3 times when you unlock a front door using either a key or the Keyless Entry Transmitter, the alarm has been activated. Check the vehicle for tampering.

Security System Manual Override

The system will not arm if you lock the doors using the manual lock control.

POWER WINDOWS — IF EQUIPPED

The window switches on the driver's door panel control both front windows. The switch on the passenger's door panel controls the passenger's window.

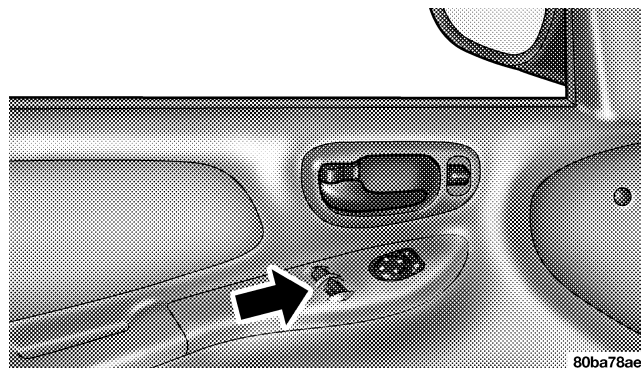

Power Window Switches

OCCUPANT RESTRAINTS

Some of the most important safety features in your vehicle are the restraint systems. These include the front and rear seat belts for the driver and all passengers, front airbags for both the driver and front passenger and side airbags for both the driver and front passenger. If you will be carrying children too small for adult-size belts, your seat belts also can be used to hold infant and child restraint systems.

Please pay close attention to the information in this section. It tells you how to use your restraint system properly to keep you and your passengers as safe as possible.

WARNING!

In a collision, you and your passengers can suffer much greater injuries if you are not properly buckled up. You can strike the interior of your vehicle or other passengers, or you can be thrown out of the vehicle. Always be sure you and others in your vehicle are buckled up properly.

Buckle up even though you are an excellent driver, even on short trips. Someone on the road may be a poor driver and cause a collision that includes you. This can happen far away from home or on your own street.

Research has shown that seat belts save lives, and that they can reduce the seriousness of injuries in a collision. Some of the worst injuries happen when people are thrown from the vehicle. Seat belts reduce the possibility of ejection and the risk of injury caused by striking the inside of the vehicle. **Everyone** in a motor vehicle should be belted at all times.

Lap/Shoulder Belts

All the seats in your vehicle are equipped with Lap/Shoulder Belts.

The belt webbing retractor is designed to lock during very sudden stops or collisions. This feature allows the shoulder part of the belt to move freely with you under normal conditions. But in a collision, the belt will lock and reduce your risk of striking the inside of the vehicle or being thrown out.

WARNING!

- Wearing a seat belt incorrectly is dangerous. Seat belts are designed to go around the large bones of your body. These are the strongest parts of your body and can take the forces of a collision the best.
- Wearing your belt in the wrong place could make your injuries in a collision much worse. You might suffer internal injuries, or you could even slide out of part of the belt. Follow these instructions to wear your seat belt safely and to keep your passengers safe, too.
- Two people should never be belted into a single seat belt. People belted together can crash into one another in an accident, hurting one another badly. Never use a lap/shoulder belt or lap belt for more than one person, no matter what their size.

Lap/Shoulder Belt Operating Instructions

1. Enter the vehicle and close the door. Sit back and adjust the seat.

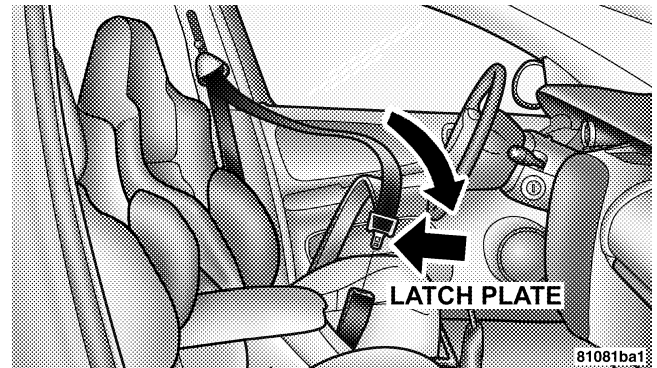

Latch Plate

2. The seat belt latch plate is above the back of the front seat, next to your arm in the rear seat. Grasp the latch plate and pull out the belt. Slide the latch plate up the webbing as far as necessary to allow the belt to go around your lap.

3. When the belt is long enough to fit, insert the latch plate into the buckle until you hear a “click.”

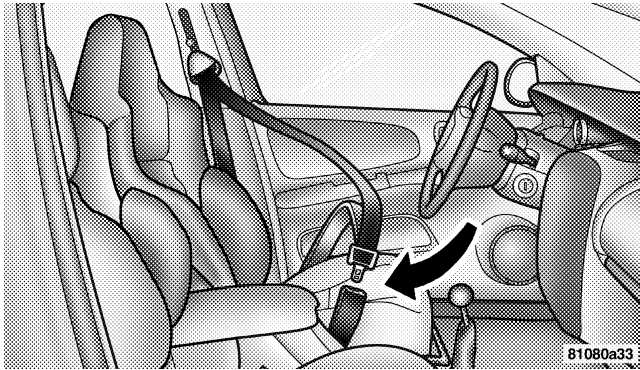

Latch Plate To Buckle

WARNING!

- A belt that is buckled into the wrong buckle will not protect you properly. The lap portion could ride too high on your body, possibly causing internal injuries. Always buckle your belt into the buckle nearest you.
- A belt that is too loose will not protect you as well. In a sudden stop you could move too far forward, increasing the possibility of injury. Wear your seat belt snugly.
- A belt that is worn under your arm is very dangerous. Your body could strike the inside surfaces of the vehicle in a collision, increasing head and neck injury. A belt worn under the arm can cause internal injuries. Ribs aren't as strong as shoulder bones. Wear the belt over your shoulder so that your strongest bones will take the force in a collision.
- A shoulder belt placed behind will not protect you from injury during a collision. You are more likely to hit your head in a collision if you do not wear your shoulder belt. The lap and shoulder belt are meant to be used together.

4. Position the lap belt across your thighs, below your abdomen. To remove slack in the lap belt portion, pull up on the shoulder belt. To loosen the lap belt if it is too tight, tilt the latch plate and pull on the lap belt. A snug belt reduces the risk of sliding under the belt in a collision.

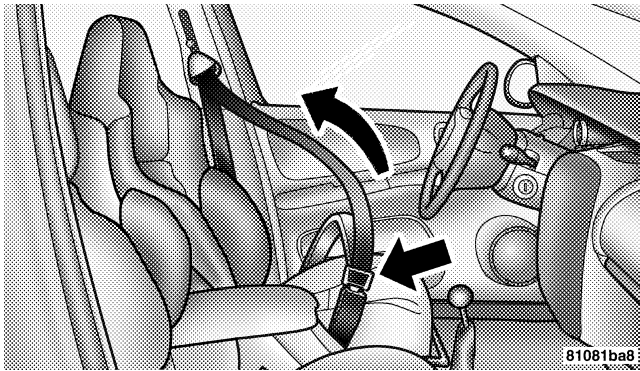

Removing Slack From Belt

WARNING!

- A lap belt worn too high can increase the risk of internal injury in a collision. The belt forces won't be at the strong hip and pelvic bones, but across your abdomen. Always wear the lap belt as low as possible and keep it snug.
- A twisted belt can't do its job as well. In a collision it could even cut into you. Be sure the belt is straight. If you can't straighten a belt in your vehicle, take it to your dealer and have it fixed.

5. Position the shoulder belt on your chest so that it is comfortable and not resting on your neck. The retractor will withdraw any slack in the belt.

6. To release the belt, push the red button on the buckle. The belt will automatically retract to its stowed position. If necessary, slide the latch plate down the webbing to allow the belt to retract fully.

WARNING!

A frayed or torn belt could rip apart in a collision and leave you with no protection. Inspect the belt system periodically, checking for cuts, frays, or loose parts. Damaged parts must be replaced immediately. Do not disassemble or modify the system. Front seat belt assemblies must be replaced after a collision. Rear seat belt assemblies must be replaced after a collision if they have been damaged (bent retractor, torn webbing, etc.).

Adjustable Upper Shoulder Belt Anchorage

In the driver and front passenger seats, the shoulder belt can be adjusted upward or downward to position the belt away from your neck. Push up or down on the anchorage button to release the anchorage, and then move it up or down to the position that serves you best.

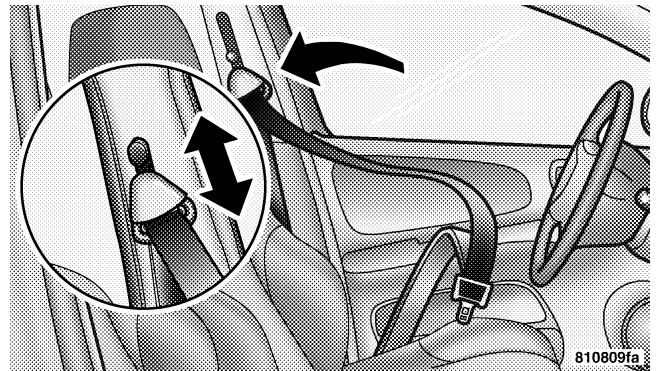
**Adjusting Upper Shoulder Belt**

As a guide, if you are shorter than average, you will prefer a lower position, and if you are taller than average, you'll prefer a higher position. When you release the anchorage, try to move it up or down to make sure that it is locked in position.

Lap/Shoulder Belt Untwisting Procedure

Use the following procedure to untwist a twisted lap/shoulder belt.

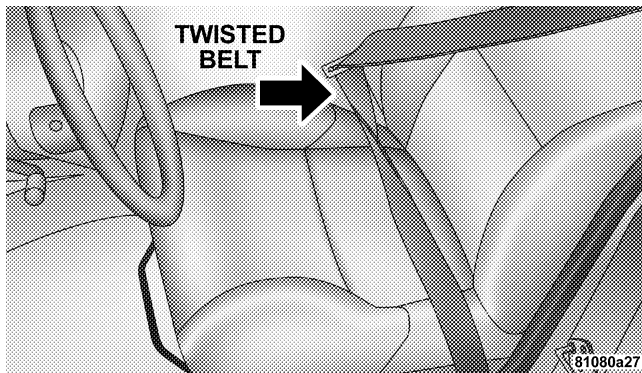

Twisted Seat Belt

1. Position the latch plate as close as possible to the anchor point.

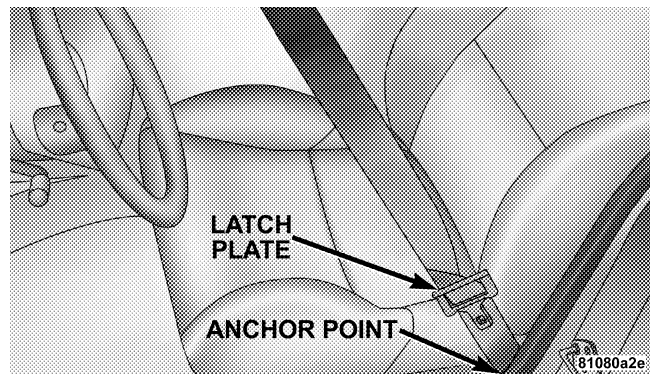

Positioning Latch Plate

2. At about 6 to 12 inches above the latch plate, grasp and twist the belt webbing 180° to create a fold that begins immediately above the latch plate.

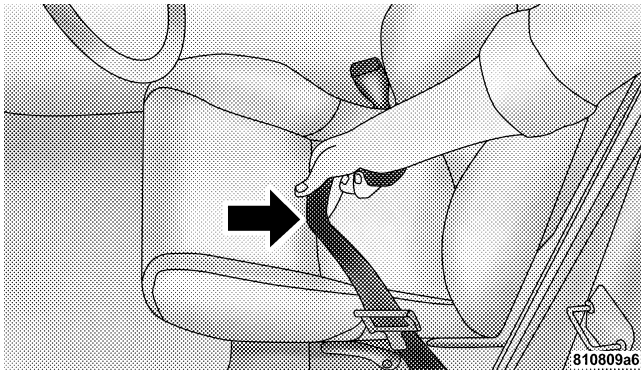

Creating A Fold

3. Slide the latch plate upward over the folded webbing. The folded webbing must enter the slot at the top of the latch plate.

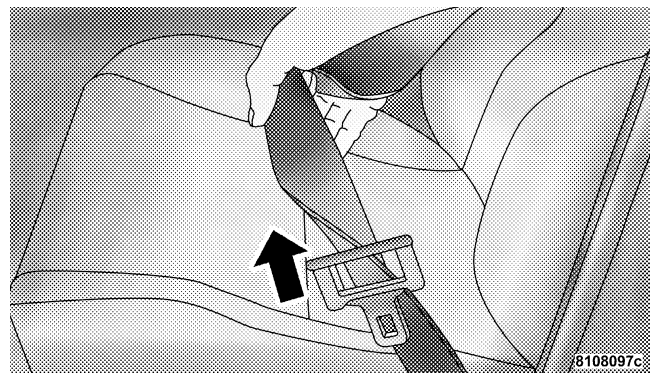

Sliding The Latch Plate

4. Continue to slide the latch plate up until it clears the folded webbing.

Seat Belts And Pregnant Women

We recommend that pregnant women use the seat belts throughout their pregnancy. Keeping the mother safe is the best way to keep the baby safe.

Pregnant women should wear the lap part of the belt across the thighs and as snug across the hips as possible.

30 THINGS TO KNOW BEFORE STARTING YOUR VEHICLE

Keep the belt low so that it does not come across the abdomen. That way the strong bones of the hips will take the force if there is a collision.

Seat Belt Extender

If a seat belt is too short, even when fully extended and when the adjustable upper shoulder belt anchorage (if equipped) is in its lowest position, your dealer can provide you with a seat belt extender. This extender should be used only if the existing belt is not long enough. When it is not required, remove the extender and store it.

WARNING!

Using a seat belt extender when not needed can increase the risk of injury in a collision. Only use when the seat belt is not long enough when it is worn low and snug, and in the recommended seating positions. Remove and store the extender when not needed.

Driver and Front Passenger Supplemental Restraint System (SRS) - Airbags

This vehicle has front airbags for both the driver and front passenger as a supplement to the seat belt restraint systems. The driver's front airbag is mounted in the center of the steering wheel. The passenger's front airbag is mounted in the instrument panel, above the glove compartment. The words SRS AIRBAG are embossed on the airbag covers.

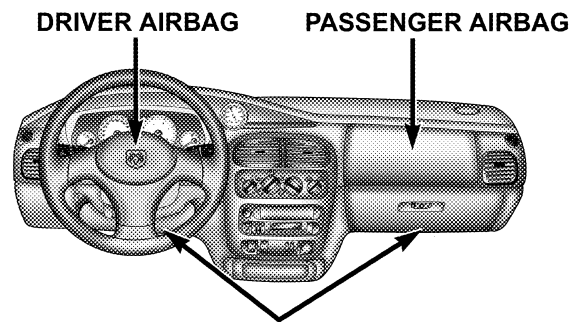

KNEE BOLSTER
Front Airbag Components

810193dc

NOTE: The front airbags are certified to the Federal regulations that allow less forceful deployment.

If the vehicle is equipped with side airbags, they are located inside the driver and front passenger seats, and their covers are also labeled SRS AIRBAG.

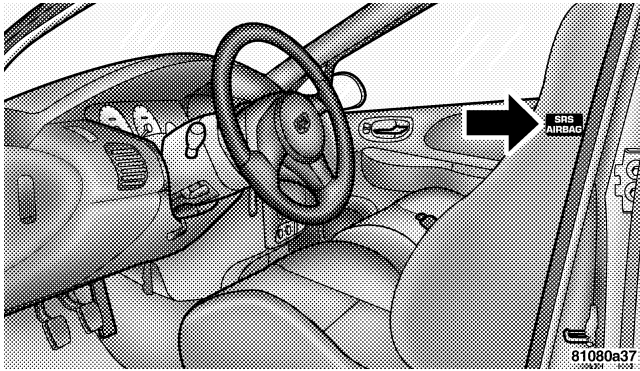

Side Airbags

NOTE: Airbag covers may not be obvious in the interior trim; but they will open to allow airbag deployment.

WARNING!

- Do not put anything on or around the front airbag covers or attempt to manually open them. You may damage the airbags and you could be injured because the airbags are not there to protect you. These protective covers for the airbag cushions are designed to open only when the airbags are inflating.
- If your vehicle is equipped with side airbags, do not use accessory seat covers or place objects between you and the side airbags; the performance could be adversely affected and/or objects could be pushed into you, causing serious injury.
- If your vehicle is equipped with side airbags, do not attach cup holders or any other objects on or around the door. The inflating side airbag could drive the objects into occupants, causing serious injury.

32 THINGS TO KNOW BEFORE STARTING YOUR VEHICLE

Airbags inflate in moderate to high speed impacts. Along with the seat belts, front airbags work with the instrument panel knee bolsters to provide improved protection for the driver and front passenger. Side airbags also work with seat belts to improve occupant protection.

The seat belts are designed to protect you in many types of collisions. The front airbags deploy in moderate to severe frontal collisions. If your vehicle is equipped, the side airbag on the crash side of the vehicle is triggered in moderate to severe side collisions. In certain types of collisions, both the front and side airbags may be triggered. But even in collisions where the airbags work, you need the seat belts to keep you in the right position for the airbags to protect you properly.

Here are some simple steps you can take to minimize the risk of harm from a deploying airbag.

1. Children 12 years old and under should always ride buckled up in a rear seat.

Infants in rear facing child restraints (designed for children up to 20 lbs (9 kg) and less than one year old) should

NEVER ride in the front seat of a vehicle with a passenger front airbag. An airbag deployment could cause severe injury or death to infants in that position.

Children that are not big enough to properly wear the vehicle's seat belt (see section on Child Restraint) should be secured in the rear seat in child restraints or belt-positioning booster seats.

Older children who do not use child restraints or belt-positioning booster seats should ride properly buckled up in the rear seat. Never allow children to slide the shoulder belt behind them or under their arm.

If a child from 1 to 12 years old must ride in the front passenger seat because the vehicle is crowded, move the seat as far back as possible, and use the proper child restraint. See the section on Child Restraint.

You should read the instructions provided with your child restraint to make sure that you are using it properly.

2. All occupants should wear their lap and shoulder belts properly.

- 3. The driver and front passenger seats should be moved back as far as practical to allow the front airbags room to inflate.
- 4. If your vehicle has side airbags, do not lean against the door, airbags will inflate forcefully into the space between you and the door.

WARNING!
<ul style="list-style-type: none"> • Relying on the airbags alone could lead to more severe injuries in a collision. The airbags work with your seat belt to restrain you properly. In some collisions the airbags won't deploy at all. Always wear your seat belts even though you have airbags. • Being too close to the steering wheel or instrument panel during airbag deployment could cause serious injury. Airbags need room to inflate. Sit back, comfortably extending your arms to reach the steering wheel or instrument panel. • If the vehicle has side airbags, they also need room to inflate. Do not lean against the door. Sit upright in the center of the seat.

Airbag System Components

The front airbag system consists of the following:

- Airbag Control Module (ACM)
- AIRBAG Readiness Light
- Driver Airbag
- Passenger Airbag
- Steering Wheel and Column
- Instrument Panel
- Crash Sensor
- Interconnecting Wiring
- Knee Impact Bolsters

The side airbag system, if equipped, consists of the following:

- AIRBAG Readiness Light (shared with the front airbag system)
- Side Airbag in the Driver's Seat
- Side Airbag in the Passenger's Seat

34 THINGS TO KNOW BEFORE STARTING YOUR VEHICLE

- Right and Left Side Impact Airbag Control Modules (SIACM)
- Interconnecting Wiring

How The Airbag System Works Front Airbag System

- The front Airbag Control Module determines if a frontal collision is severe enough to require the airbags to inflate.
- The Airbag Control Module is not designed to detect side, roll over, or rear collisions.
- The Airbag Control Module also monitors the readiness of the electronic parts of the system whenever the ignition switch is in the START or ON/RUN positions. These include all of the items listed above except the knee bolsters, the instrument panel, and the steering wheel and column. If the key is in the OFF position, in the ACC position, or not in the ignition switch, the airbags are not on and will not inflate.

- The Airbag Control Module also turns on the AIRBAG light in the instrument panel for 6 to 8 seconds when the ignition switch is first turned to ON/RUN, then turns the light off. If it detects a malfunction in any part of the system, it turns on the light either momentarily or continuously.

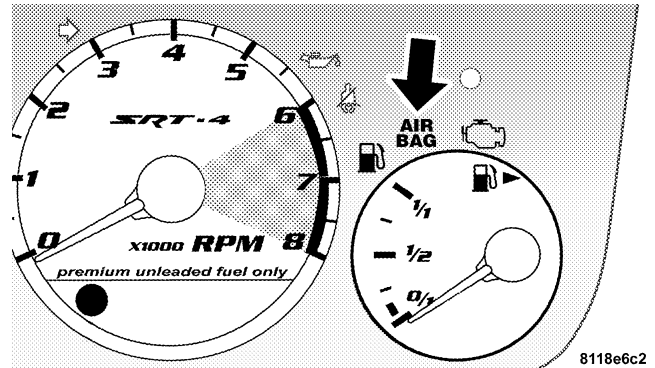

Airbag Light

WARNING!

Ignoring the AIRBAG light in your instrument panel could mean you won't have the airbags to protect you in a collision. If the light does not come on, stays on after you start the vehicle, or if it comes on as you drive, have the airbag system checked right away.

- When the Airbag Control Module detects a collision requiring the airbags, it signals the inflator units. A large quantity of nontoxic gas is generated to inflate the airbags. The airbag covers separate and fold out of the way as the airbags inflate to their full size. The airbags fully inflate in about 50 milliseconds. This is only about half of the time it takes you to blink your eyes. The airbags then quickly deflate while helping to restrain the driver and front passenger. The driver's front airbag gas is vented through the airbag material towards the instrument panel. The passenger's front airbag gas is vented through vent holes in the sides of the airbag. In this way the airbags do not interfere with your control of the vehicle.

- The knee impact bolsters help protect the knees and position you for the best interaction with the front airbag.

If A Deployment Occurs

The airbag system is designed to deploy when the Airbag Control Module detects a moderate-to-severe frontal collision, to help restrain the driver and front passenger, and then to immediately deflate.

NOTE: A frontal collision that is not severe enough to need airbag protection will not activate the system. This does not mean something is wrong with the airbag system.

If you do have a collision which deploys the airbags, any or all of the following may occur:

- The nylon airbag material may sometimes cause abrasions and/or skin reddening to the driver and front passenger as the airbags deploy and unfold. The abrasions are similar to friction rope burns or those you might get sliding along a carpet or gymnasium floor. They are not caused by contact with chemicals. They are not permanent and normally heal quickly.

However, if you have not healed significantly within a few days, or if you have any blistering, see your doctor immediately.

- As the airbags deflate you may see some smoke-like particles. The particles are a normal by-product of the process that generates the nontoxic gas used for airbag inflation. These airborne particles may irritate the skin, eyes, nose, or throat. If you have skin or eye irritation, rinse the area with cool water. For nose or throat irritation, move to fresh air. If the irritation continues, see your doctor. If these particles settle on your clothing, follow the garment manufacturer's instructions for cleaning.
- It is not advisable to drive your vehicle after the airbags have deployed. If you are involved in another collision, the airbags will not be in place to protect you.

WARNING!

Deployed airbags can't protect you in another collision. Have the airbags replaced by an authorized dealer as soon as possible.

Side Airbag System — If Equipped

- The Side Impact Airbag Control Modules determine if a side collision is severe enough to require the airbag to inflate. The Side Impact Airbag Control Modules is not designed to detect roll over, front, or rear impacts.
- The Side Impact Airbag Control Module monitors the readiness of the electronic parts of the system whenever the ignition switch is in the START or ON/RUN positions. These include all of the items listed above. If the left or right SIACM detects a malfunction in any part of the system, it will send a message to the frontal ACM to turn the Airbag Light on. The Airbag Control Module also turns on the AIRBAG light in the instrument panel for 6 to 8 seconds when the ignition switch is first turned on as a diagnostic or system check, then turns the light off.

- In moderate to severe side collisions, the side airbag inflator on the crash side of the vehicle is triggered by the appropriate SIACM, releasing a quantity of non-toxic gas. The inflating side airbag exits through the seat seam into the space between the occupant and the door. The side airbag moves at a very high speed and with such a high force, that it could injure you if you are not seated properly, or if items are positioned in the area where the side airbag inflates. This especially applies to children.

Enhanced Accident Response Time — If Equipped

If the airbags deploy after an impact and the electrical system remains functional, vehicles equipped with power door locks will unlock automatically. In addition, approximately 10 seconds after the vehicle has stopped moving, the interior lights will light until the ignition switch is turned off.

Maintaining Your Airbag Systems

WARNING!

- **Modifications to any part of the airbag system could cause it to fail when you need it. You could be injured because the airbags are not there to protect you. Do not modify the components or wiring, including adding any kind of badges or stickers to the steering wheel hub trim cover or the upper right side of the instrument panel. Do not modify the front bumper, vehicle body structure, or frame.**
- **You need proper knee impact protection in a collision. Do not mount or locate any aftermarket equipment on or behind the knee bolster.**
- **It is dangerous to try to repair any part of the airbag system yourself. Be sure to tell anyone who works on your vehicle that it has airbags.**

Airbag Light

You will want to have the airbags ready to inflate for your protection in an impact. While the airbag system is designed to be maintenance free, if any of the following occurs, have an authorized dealer service the system immediately:

- The AIRBAG light does not come on or flickers during the 6 to 8 seconds when the ignition switch is first turned on.
- The light remains on or flickers after the 6 to 8 second interval.
- The light flickers or comes on and remains on while driving.

Child Restraint

Everyone in your vehicle needs to be buckled up at all times — babies and children, too. Every state in the United States and all Canadian provinces require that small children ride in proper restraint systems. This is the law, and you can be prosecuted for ignoring it.

Children 12 years and under should ride properly buckled up in a rear seat, if available. According to crash statistics, children are safer when properly restrained in the rear seats, rather than in the front.

WARNING!

In a collision, an unrestrained child, even a tiny baby, can become a missile inside the vehicle. The force required to hold even an infant on your lap could become so great that you could not hold the child, no matter how strong you are. The child and others could be badly injured. Any child riding in your vehicle should be in a proper restraint for the child's size.

Infants And Small Children

There are different sizes and types of restraints for children from newborn size to the child almost large enough for an adult safety belt. Always check the child seat Owner's Manual to ensure you have the right seat for your child. Use the restraint that is correct for your child:

- Safety experts recommend that children ride rearward-facing in the vehicle until they are at least one year old **and** weigh at least 20 lbs (9 kg). Two types of child restraints can be used rearward-facing: infant carriers and “convertible” child seats. Both types of child restraints are held in the vehicle by the lap/shoulder belt or the LATCH child restraint anchorage system.
 - The infant carrier is only used rearward-facing in the vehicle. It is recommended for children who weigh up to about 20 lbs (9 kg). “Convertible” child seats can be used either rearward-facing or forward-facing in the vehicle. Convertible child seats often have a higher weight limit in the rearward-facing direction than infant carriers do, so they can be used rearward-facing by children who weigh more than 20 lbs (9 kg) but are less than one year old.
 - Rearward-facing child seats must **NEVER** be used in the front seat of a vehicle with the front passenger airbag. An airbag deployment could cause severe injury or death to infants in this position.
 - Children who weigh more than 20 lbs (9 kg) and who are older than one year can ride forward-facing in the vehicle. Forward-facing child seats and convertible child seats used in the forward-facing direction are for children who weigh 20 to 40 lbs (9 to 18 kg) and who are older than one year. These child seats are also held in the vehicle by the lap/shoulder belt or the LATCH child restraint anchorage system.
 - The belt-positioning booster seat is for children weighing more than 40 lbs (18 kg), but who are still too small to fit the vehicle’s seat belts properly. If the child cannot sit with knees bent over the vehicle’s seat cushion while the child’s back is against the seat back; they should use a Belt Positioning Booster Seat. The child and booster seat are held in the vehicle by the lap/shoulder belt. (Some booster seats are equipped with a front shield and are held in the vehicle by the lap portion).
- NOTE:** For additional information refer to www.seatcheck.org.

WARNING!

- **Improper installation can lead to failure of an infant or child restraint. It could come loose in a collision. The child could be badly injured or killed. Follow the manufacturer's directions exactly when installing an infant or child restraint.**
- **A rearward facing infant restraint should only be used in a rear seat. A rearward facing infant restraint in the front seat may be struck by a deploying passenger airbag which may cause severe or fatal injury to the infant.**

Here are some tips on getting the most out of your child restraint:

- Before buying any restraint system, make sure that it has a label certifying that it meets all applicable Safety Standards. We also recommend that you make sure that you can install the child restraint in the vehicle where you will use it before you buy it.
- The restraint must be appropriate for your child's weight and height. Check the label on the restraint for weight and height limits.
- Carefully follow the instructions that come with the restraint. If you install the restraint improperly, it may not work when you need it.

The passenger seat belts are equipped with cinching latch plates which are designed to keep the lap portion tight around the child restraint so that it is not necessary to use a locking clip. Pulling up on the shoulder portion of the lap/shoulder belt will tighten the belt. The cinching latch plate will keep the belt tight, however, any seat belt system will loosen with time, so check the belt occasionally and pull it tight if necessary.

- In the rear seat, you may have trouble tightening the lap/shoulder belt on the child restraint because the buckle or latch plate is too close to the belt path opening on the restraint. Disconnect the latch plate from the buckle and twist the short buckle-end belt several times to shorten it. Insert the latch plate into the buckle with the release button facing out.

- If the belt still can't be tightened, or if pulling and pushing on the restraint loosens the belt, disconnect the latch plate from the buckle, turn the buckle around, and insert the latch plate into the buckle again. If you still can't make the child restraint secure, try a different seating position.
- Buckle the child into the seat according to the child restraint manufacturer's directions.
- When your child restraint is not in use, secure it in the vehicle with the seat belt or remove it from the vehicle. Do not leave it loose in the vehicle. In a sudden stop or collision, it could strike the occupants or seat backs and cause serious personal injury.

LATCH —Lower **A**nchors and **T**ether for **C**hildren
Your vehicle's rear seat is equipped with the child restraint anchorage system called LATCH, which stands for Lower Anchors and Tether for Children. The LATCH system provides for the installation of the child restraint without using the vehicle seat belt. All three rear seating positions have exclusive lower anchorages. These are round bars, located at the rear of the seat cushion where it meets the seat back, and just visible when you lean into

the rear seat to install the child restraint. You will easily feel them if you run your finger along the intersection of the surfaces. The lower strap hooks are passed over the top of each bar, pushing aside the seat cover material.

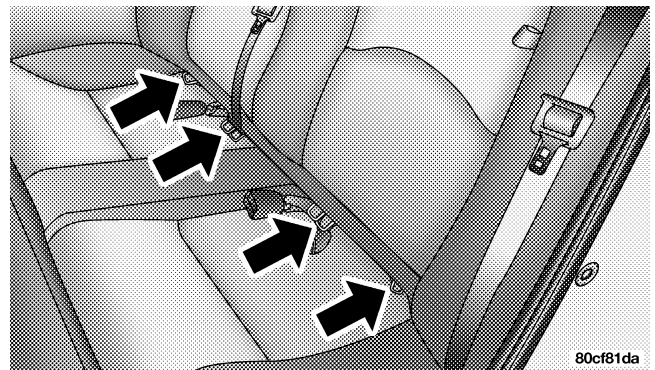

Latch Anchorages



In addition, there are tether strap anchorages behind each rear seating position located in the panel between the rear seat back and the rear window — under a hinged plastic cover with this symbol on it. (Shown to the left) In recent years, only the tether anchorage has been provided in new vehicles.

To attach a child restraint tether strap:

1. Lift the cover over the anchor directly behind the seat where you are placing the child restraint.

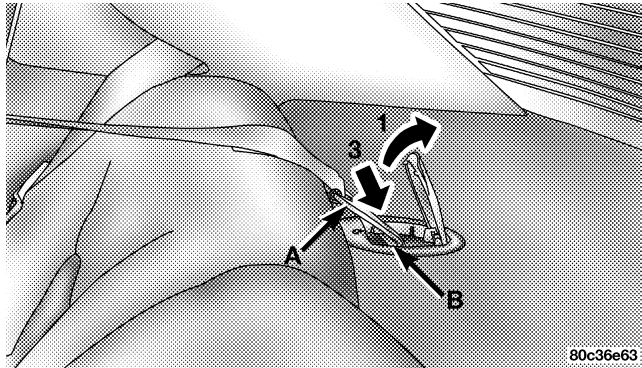

Tether Strap Mounting

2. Route the tether strap to provide the most direct path for the strap between the anchor and the child seat. If your vehicle is equipped with adjustable rear head restraints, raise the head restraint and, where possible, route the tether strap under the head restraint and

between the two posts. If not possible, lower the head restraint and pass the tether strap around the outboard side of the head restraint.

3. Attach the tether strap hook (A) of the child restraint to the anchor (B) and remove slack in the tether strap according to the child restraint manufacturer's instructions.

WARNING!

An incorrectly anchored tether strap could lead to increased head motion and possible injury to the child. Use only the anchor positions directly behind the child seat to secure a child restraint top tether strap.

Child restraint systems having attachments designed to connect to the lower anchorages are now available. Child restraints having tether straps and hooks for connection to the top tether anchorage have been available for some time. In fact, many child restraint manufacturers will

provide add-on tether strap kits for some of their older products. Tether anchorage kits are also available for most older vehicles.

Because the lower anchorages are to be introduced to passenger carrying vehicles over a period of years, child restraint systems having attachments for those anchorages will continue to have features for installation in vehicles using the lap or lap/shoulder belt. They will also have tether straps, and you are urged to take advantage of all of the available attachments provided with your child restraint in any vehicle.

Installing the Child Restraint System

While there are LATCH anchorages at all three rear seating positions, do not install child restraints at all three positions at the same time. The anchorages are not designed to restrain three child restraints at one time. Instead, you may install one child restraint at the center position, or two child restraints at the right and left positions.

WARNING!

Do not install child restraint systems equipped with LATCH attachments at all three rear seating positions at one time. The LATCH anchorages are designed to restrain no more than two child restraints at a time in the event of a collision.

2

We urge that you carefully follow the directions of the manufacturer when installing your child restraint. Many, but not all, restraint systems will be equipped with separate straps on each side, with each having a hook or connector and a means for adjusting the tension in the strap. Forward-facing toddler restraints and some rearward-facing infant restraints will also be equipped with a tether strap, a hook and means for adjusting the tension in the strap.

In general, you will first loosen the adjusters on the lower straps and tether straps so that you can more easily attach the hook or connector to the lower anchorages and tether anchorages. Then tighten all three straps as you push the child restraint rearward and downward into the seat.

44 THINGS TO KNOW BEFORE STARTING YOUR VEHICLE

Not all child restraint systems will be installed as we have described here. Again, carefully follow the instructions that come with the child restraint system.

WARNING!

Improper installation of a child restraint to the LATCH anchorages can lead to failure of an infant or child restraint. The child could be badly injured or killed. Follow the manufacturer's directions exactly when installing an infant or child restraint.

NOTE: If your child restraint seat is not LATCH compatible, install the restraint using the vehicle seat belts.

Children Too Large For Booster Seats

Children who are large enough to wear the shoulder belt comfortably, and whose legs are long enough to bend over the front of the seat when their back is against the seat back, should use the lap/shoulder belt in a rear seat.

- Make sure that the child is upright in the seat.

- The lap portion should be low on the hips and as snug as possible.
- Check belt fit periodically. A child's squirming or slouching can move the belt out of position.
- If the shoulder belt contacts the face or neck, move the child closer to the center of the vehicle. Never allow a child to put the shoulder belt under an arm or behind their back.

Transporting Pets

Airbags deploying in the front seat could harm your pet. An unrestrained pet will be thrown about and possibly injured, or injure a passenger during panic braking or in a collision.

Pets should be restrained in the rear seat in pet harnesses or pet carriers that are secured by seat belts.

ENGINE BREAK-IN RECOMMENDATIONS

The engine in your new vehicle does not require a long break-in period.

Drive moderately during the first 300 miles (500 km). After the initial 60 miles (100 km), speeds up to 50 or 55 mph (80 or 90 km/h) are desirable.

While cruising, brief full-throttle acceleration, within the limits of local traffic laws, contributes to a good break-in.

Wide open throttle acceleration in low gear can be detrimental and should be avoided.

The crankcase oil installed in the engine at the factory is a high quality energy conserving type lubricant. Oil changes should be consistent with expected climate conditions under which vehicle operations will occur. The recommended viscosity and quality grades are in Section 7 of this manual.

Do not use non-detergent or straight mineral oils.

A new engine may consume some oil during its first few thousand miles of operation. This is a normal part of the break-in and not an indication of a problem.

SAFETY TIPS**Exhaust Gas****WARNING!**

Exhaust gases can injure or kill. They contain carbon monoxide (CO) which is colorless and odorless. Breathing it can make you unconscious and can eventually poison you. To avoid breathing (CO) follow the safety tips below.

Do not run the engine in a closed garage or in confined areas any longer than needed to move your vehicle in or out of the area.

If it is necessary to sit in a parked vehicle with the engine running, adjust your heating or cooling controls to force outside air into the vehicle. Set the blower at high speed.

To avoid drawing exhaust gases into the vehicle, close the trunk while driving. However, if for some reason it must remain open, close all windows. Adjust the heating or cooling system to force outside air into the vehicle. Set the blower at high speed.

Safety Checks You Should Make Inside The Vehicle

Seat Belts

Inspect the belt system periodically, checking for cuts, frays and loose parts. Damaged parts must be replaced immediately. Do not disassemble or modify the system.

Front seat belt assemblies must be replaced after a collision. Rear seat belt assemblies must be replaced after a collision if they have been damaged (bent retractor, torn webbing, etc.). If there is any question regarding belt or retractor condition, replace the belt.

Airbag Light

AIR BAG The light should come on and remain on for 6 to 8 seconds as a bulb check when the ignition switch is first turned to ON/RUN. If the bulb is not lit during starting, have it replaced. If the light stays on or comes on while driving, have the system checked by an authorized dealer.

Defrosters

Check operation by selecting the defrost mode and place the blower control on high speed. You should be able to feel the air directed against the windshield.

Periodic Safety Checks You Should Make Outside The Vehicle

Tires

Examine tires for excessive tread wear or uneven wear patterns. Check for stones, nails, glass, or other objects lodged in the tread. Inspect for tread cuts or sidewall cracks. Check wheel nuts for tightness, and tires (including spare) for proper pressure.

Lights

Have someone observe the operation of exterior lights while you work the controls. Check turn signal and high beam indicator lights on the instrument panel.

Fluid Leaks

Check area under vehicle after overnight parking for fuel, water, oil, or other fluid leaks. Also, if gasoline fumes are present, the cause should be corrected immediately.

UNDERSTANDING THE FEATURES OF YOUR VEHICLE

CONTENTS

■ Mirrors49	□ Front Map/Reading Lights54
□ Inside Day/Night Mirror49	□ Interior Lights55
□ Outside Mirror — Driver’s Side49	□ Multi-Function Control Lever56
□ Outside Mirror — Passenger’s Side49	□ Headlights, Parking Lights, Instrument Panel Lights56
□ Electric Remote-Control Mirrors50	□ Daytime Running Lights (Canada Only)57
■ Seats50	□ Lights-On Reminder57
□ Front Seat Adjustment50	□ Fog Lights57
□ Reclining Bucket Seats51	□ Turn Signals57
□ Folding Rear Seat52	□ Headlight Dimmer Switch57
■ To Open And Close The Hood53	□ Passing Light57
■ Lights54	■ Windshield Wipers And Washers58

48 UNDERSTANDING THE FEATURES OF YOUR VEHICLE

<input type="checkbox"/> Windshield Washers58	<input checked="" type="checkbox"/> Power Sunroof — If Equipped60
<input type="checkbox"/> Mist Function58	<input type="checkbox"/> Sunroof Maintenance61
<input type="checkbox"/> Intermittent Wiper System59	<input type="checkbox"/> Wind Buffeting62
<input type="checkbox"/> Lo Speed Wipers59	<input checked="" type="checkbox"/> Console Features62
<input type="checkbox"/> Hi Speed Wipers59	<input type="checkbox"/> Ash Receiver And Cigar Lighter63
<input checked="" type="checkbox"/> Tilt Steering Column59		

MIRRORS

Inside Day/Night Mirror

Adjust the mirror to center on the view through the rear window. A two point pivot system allows for horizontal and vertical mirror adjustment.

Annoying headlight glare can be reduced by moving the small control under the mirror to the night position (toward rear of vehicle). The mirror should be adjusted while set in the day position (toward windshield).

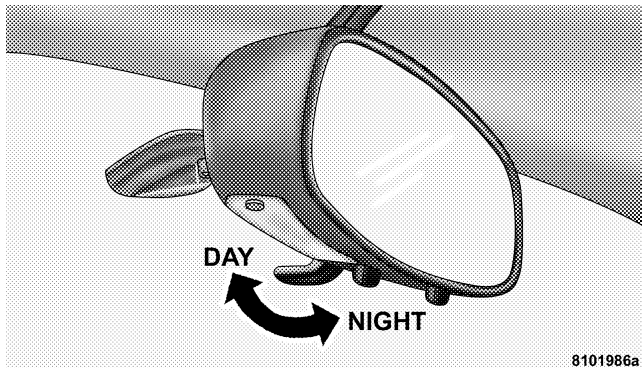

Adjusting Rear View Mirror

8101986a

Outside Mirror — Driver’s Side

Adjust the outside mirror to center on the adjacent lane of traffic, with a slight overlap of the view obtained on the inside mirror.

Outside Mirror — Passenger’s Side

Adjust the convex outside mirror so you can just see the side of your vehicle in the part of the mirror closest to the vehicle.

3

WARNING!

Vehicles and other objects seen in the passenger side convex mirror will look smaller and farther away than they really are. Relying too much on your passenger side mirror could cause you to collide with another vehicle or other object. Use your inside mirror when judging the size or distance of a vehicle seen in this convex mirror.

Electric Remote-Control Mirrors

Use the mirror select switch, located on the drivers door trim panel, to adjust the view obtained in the outside mirrors. Press the rocker knob to the L or R for Left or Right mirror selection. Use the center off position to guard against accidentally moving a mirror position.

Select a mirror and press one of the four arrows for the direction you want the mirror to move.

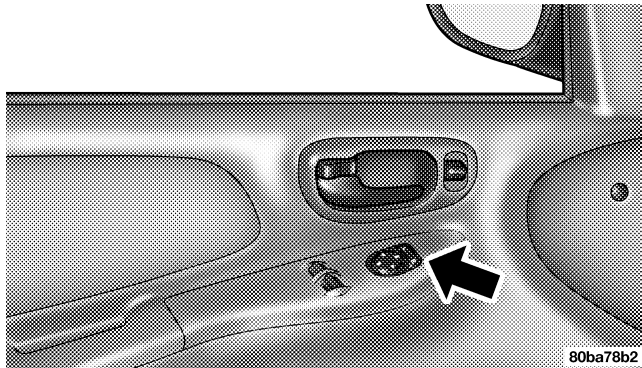

Power Mirror Switches

SEATS

Front Seat Adjustment

The adjusting bar is at the front of the seats, near the floor. Pull the bar up to move the seat to the desired position.

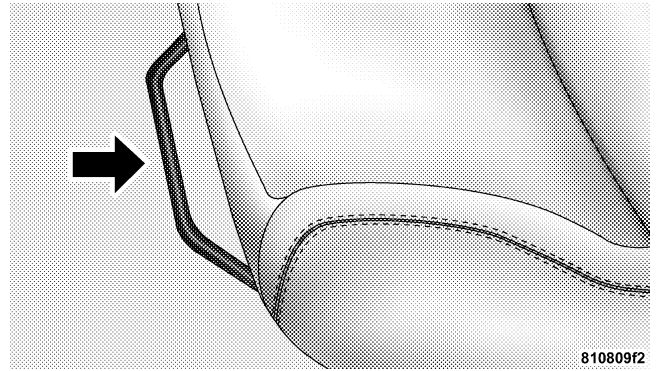

Manual Front Seat Adjuster

Using body pressure, move forward and rearward on the seat to be sure the seat adjusters have latched after the adjustment bar is released.

WARNING!

- Adjusting a seat while the vehicle is moving is dangerous. The sudden movement of the seat could cause you to lose control. The seat belt might not be properly adjusted and you could be injured. Adjust the seat only while the vehicle is parked.
- Do not ride with the seatback reclined so that the shoulder belt is no longer resting against your chest. In a collision you could slide under the seat belt and be seriously or even fatally injured. Use the recliner only when the vehicle is parked.

Reclining Bucket Seats

The recliner control is on the side of the seat. To recline, lean forward slightly before lifting the lever, then lean back to the desired position and release the lever. Lean forward and lift the lever to return the seatback to its normal position.

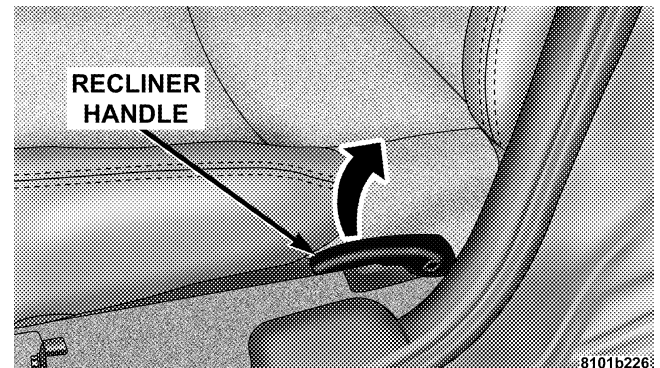

Folding Rear Seat

To provide additional storage area, the center of each rear seatback can be folded forward. Pull on the loops shown in the picture to fold down either or both seatbacks.

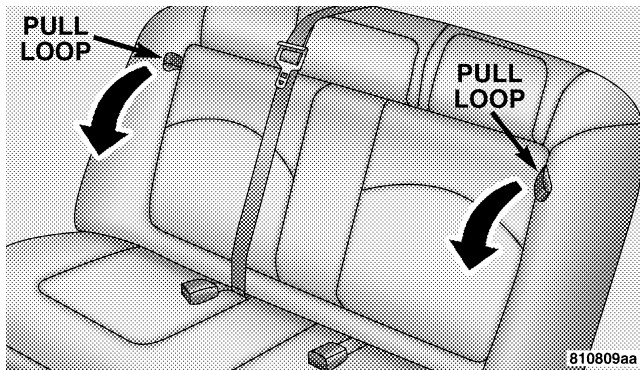

Folding Rear Seat

WARNING!

- It is extremely dangerous to ride in a cargo area, inside or outside of a vehicle. In a collision, people riding in these areas are more likely to be seriously injured or killed.
- Do not allow people to ride in any area of your vehicle that is not equipped with seats and seatbelts.
- Be sure that everyone in your vehicle is in a seat and using a seatbelt properly.

TO OPEN AND CLOSE THE HOOD

To open the hood, two latches must be released. First pull the hood release lever located under the driver's side of the instrument panel.

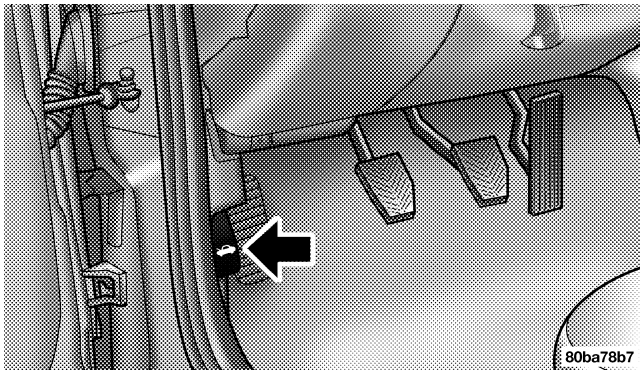

Hood Release Lever

Then lift the safety catch located under the front edge of the hood, near the center and raise the hood.

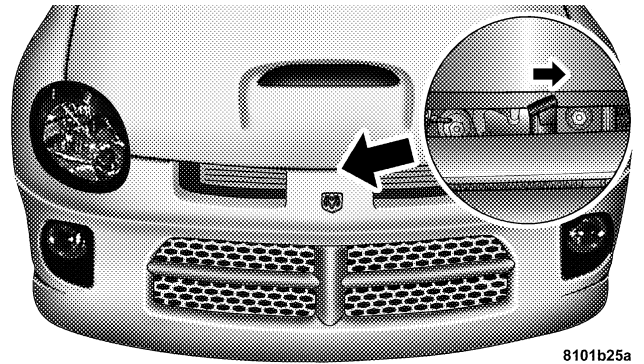

Hood Safety Catch

Use the hood prop rod to secure the hood in the open position as shown. To prevent possible damage, do not slam the hood to close it. Use a firm downward push at the center of the hood to ensure that both latches engage.

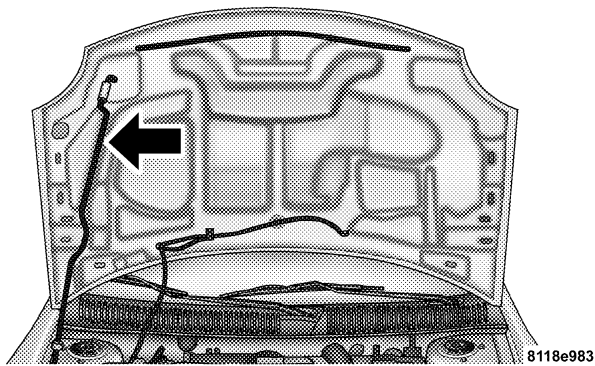

Hood Prop Rod

WARNING!

If the hood is not fully latched it could fly up when the vehicle is moving and block your forward vision. You could have a collision. Be sure all hood latches are fully latched before driving.

LIGHTS

Front Map/Reading Lights

These lights, located under the rearview mirror, can be turned on by means of switches located at the base of the rearview mirror.

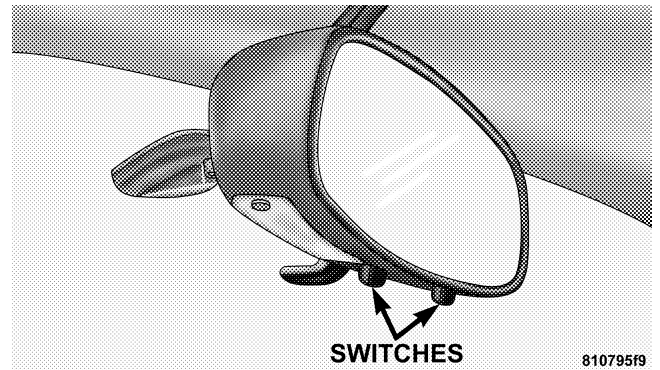

Front Map/Reading Lights

NOTE: The map lights will remain on when the ignition switch is in the Run or Accessory positions.

Interior Lights

The interior lights come on when a door is opened.

The interior lights will automatically turn off in about 8 minutes if a door is left open or the dimmer control is left in the Dome light position. Turn the ignition switch ON to restore the interior light operation.

Dimmer Control

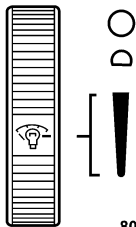

809b46a8

With the park lights or headlights on, rotating the dimmer control for the interior lights on the Multi-Function Control Lever upward will increase the brightness of the instrument panel lights.

Dome Light Position



809b46b6

Rotate the dimmer control completely upward to the second detent to turn on the interior lights. The interior lights will remain on when the dimmer control is in this position.

Daytime Brightness Feature

Certain instrument panel components can be illuminated at full brightness during the daytime. These are the Odometer and Radio. This can be helpful when driving with your headlights on during the daytime such as in a parade or a funeral procession. To activate this feature, rotate the dimmer ring on the left stalk one detent lower than the dome light.

Multi-Function Control Lever

The Multi-Function Control Lever controls the operation of the headlights, parking lights, turn signals, headlight beam selection, instrument panel light dimming, interior lights, the passing lights, and fog lights. The lever is located on the left side of the steering column.

Headlights, Parking Lights, Instrument Panel Lights

Turn the end of the Multi-Function Control Lever to the first detent for parking light operation. Turn to the second detent for headlight operation.

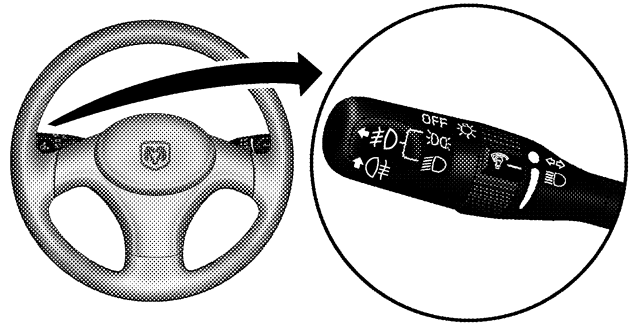

8101b291

Multi-Function Control Lever

To change the brightness of the instrument panel lights, rotate the center portion of the Multi-Function Control Lever up or down.

Daytime Running Lights (Canada Only)

The front fog lights will come on as Daytime Running Lights whenever the ignition is on, the headlights are off, and the parking brake is off. The headlight switch must be used for normal night time driving.

Lights-on Reminder

If the headlights or parking lights are on after the ignition is turned OFF, a chime will sound when the driver's door is opened. Leaving the headlights on for an extended period of time will discharge the battery resulting in reduced battery life and possible inability to start the vehicle.

Fog Lights

 The front fog light switch is on the Multi-Function Control Lever. To activate the front fog lights, turn on the headlights and pull out the end of the control lever.

NOTE: The fog lights will only operate with the headlights on low beam. Selecting high beam headlights or park lights will turn off the fog lights.

Turn Signals

Move the Multi-Function Control Lever up or down to detent and the arrows on each side of the instrument cluster flash to show proper operation of the front and rear turn signal lights. You can signal a lane change by moving the lever partially up or down.

If either light remains on and does not flash, or there is a very fast flash rate, check for a defective outside light bulb. If an indicator fails to light when the lever is moved, it would suggest that the fuse or indicator bulb is defective.

Headlight Dimmer Switch

Pull the Multi-Function Control Lever towards you to switch the headlights to HIGH beam. Pull the control lever a second time to switch the headlights to LOW beam.

Passing Light

You can signal another vehicle with your headlights by lightly pulling the Multi-Function Control Lever toward you. This will cause the headlights to turn on at high beam and remain on until the lever is released.

WINDSHIELD WIPERS AND WASHERS

The wipers and washers are operated by a switch in the control lever. Move the control lever up to select the desired wiper speed.

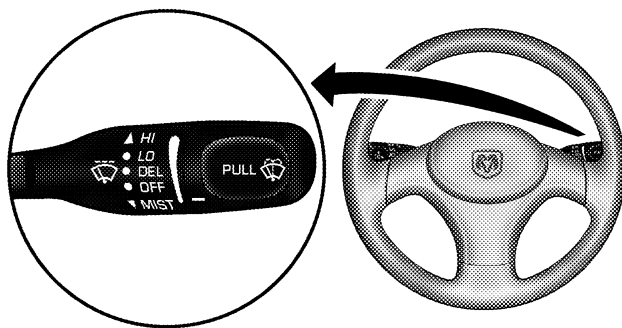

8101b2c5

Windshield Wiper/Washer Control

Windshield Washers

To use the washer, pull the control lever toward you and hold while spray is desired. If the lever is pulled while in the delay range, the wiper will operate in low speed for two wipe cycles after the lever is released, and then resume the intermittent interval previously selected.

If the lever is pulled while in the OFF position, the wipers will operate for two wipe cycles, then turn OFF.

CAUTION!

- In cold weather, always turn off the wiper switch and allow the wipers to return to the park position before turning off the engine. If the wiper switch is left on and the wipers freeze to the windshield, damage to the wiper motor may occur when the vehicle is restarted.

Mist Function

Push down on the wiper control lever to activate a single wipe to clear the windshield of road mist or spray from a passing vehicle. The wiper blade will continue to wipe until you release the stalk.

Intermittent Wiper System

Use the intermittent wiper when weather conditions make a single wiping cycle, with a variable pause between cycles, desirable. Move the lever to the first detent (DEL) position, then select the delay interval by turning the end of the stalk. Rotate the end upward to decrease the delay time and downward to increase it. The delay can be regulated from a maximum of approximately 18 seconds between cycles, to a second between cycles.

Lo Speed Wipers

Move the wiper stalk upward to the 2nd detent to obtain a low speed wiper function.

Hi Speed Wipers

Move the wiper stalk upward to the 3rd position to obtain the fastest wiper speed.

TILT STEERING COLUMN

To tilt the column, push down on the lever below the turn signal control and move the wheel up or down, as desired. Pull the lever back towards you to lock the column firmly in place.

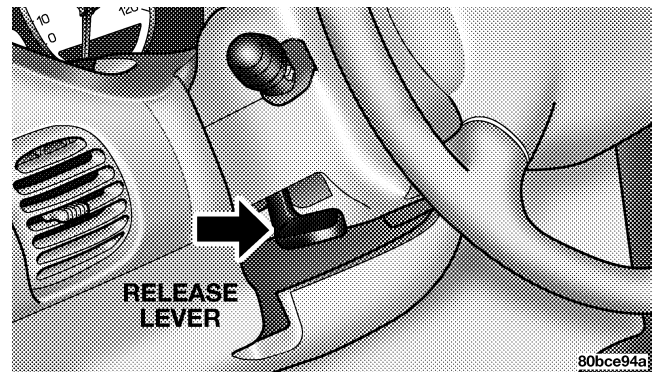

Tilt Steering Column Control

WARNING!

Tilting the steering column while the vehicle is moving is dangerous. Without a stable steering column, you could lose control of the vehicle and have an accident. Adjust the column only while the vehicle is stopped. Be sure it is locked before driving.

POWER SUNROOF — IF EQUIPPED

The sunroof control is located on the headliner between the sun visors.

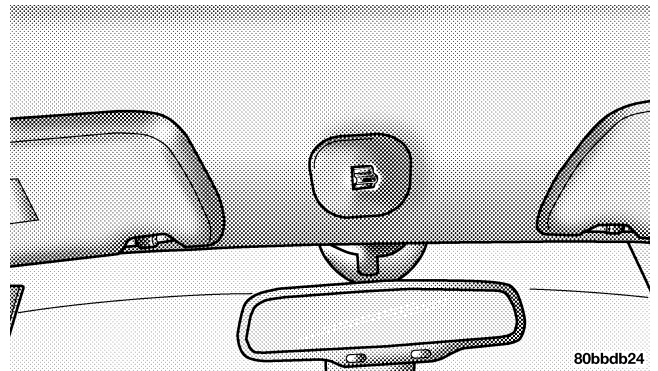

Power Sunroof Switch

A single control “tilts” the sunroof to the vent position and also slides the sunroof rearward to the full open position. Move the switch rearward to move the sunroof panel to the full vent position. The sunroof can be stopped at any position between closed and full vent open.

Once the sunroof panel is in the full vent position, you may momentarily move the switch rearward (less than one second) to initiate the express open mode. During this operation, any movement of the switch will stop the sunroof and it will remain in a partial open position.

NOTE: When closing the sunroof, make sure the close button is held in the close position until the motor stops. This ensures the sunroof is fully closed and latched.

To close the sunroof, hold the switch in the forward position. Again, any release of the switch will stop the movement and the sunroof will remain in a partial open condition until the switch is pushed forward again.

CAUTION!

The sunroof should not be operated above 70 mph. Opening or closing the sunroof above 70 mph may jam the sunroof mechanism.

WARNING!

In an accident, there is a greater risk of being thrown from a vehicle with an open sunroof. You could also be seriously injured or killed. Always fasten your seat belt properly and make sure all passengers are properly secured too.

Do not allow small children to operate the sunroof. Never allow fingers or other body parts, or any object to project through the sunroof opening. Injury may result.

Sunroof Maintenance

Use only a non-abrasive cleaner and a soft cloth to clean the glass panel.

Wind Buffeting

Wind buffeting can be described as the perception of pressure on the ears or a helicopter type sound in the ears. Your vehicle may exhibit wind buffeting with the windows down, or the sunroof (if so equipped) in certain open or partially open positions. This is a normal occurrence and can be minimized. If the buffeting occurs with the rear windows open, open the front and rear windows together to minimize the buffeting. If the buffeting occurs with the sunroof open, adjust the sunroof opening to minimize the buffeting.

CONSOLE FEATURES

The Standard console with armrest has two front cup holders and a front storage tray. There are two additional cupholders; one is molded in the center of the console to hold large cups, and the other is on the underside of the console lid to serve passengers in the rear seat. The underside console lid also has an integral tissue pack holder. The covered storage area has CD and cassette holders.

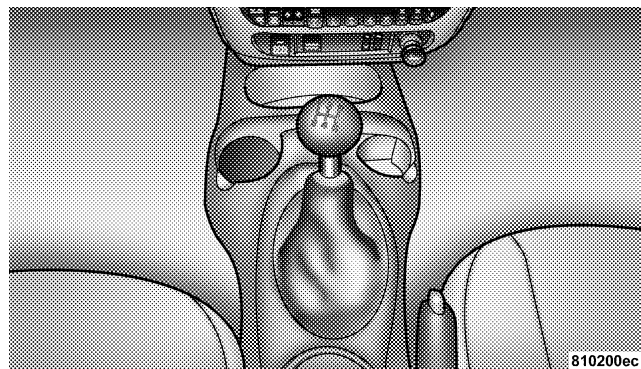

Front Console

Ash Receiver and Cigar Lighter

When the Smoker's Package is ordered from your authorized dealer, an ash receiver tray and a cigar lighter element are furnished. The lighter element can be inserted in the auxiliary power outlet. The ash receiver fits snugly in a cupholder position. To clean the ash receiver, lift it from the cupholder.

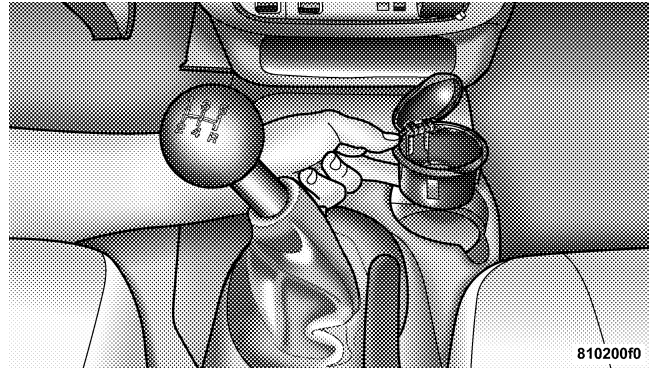
**Ash Receiver Tray**

UNDERSTANDING YOUR INSTRUMENT PANEL

CONTENTS

■ Instrument Panel Features67	■ Sales Code RBK—AM/ FM Stereo Radio With CD Player And CD Changer Controls75
■ Instrument Cluster—Turbo68	□ Radio Operation75
■ Instrument Cluster Descriptions69	□ CD Player Operation77
■ Electronic Digital Clock74	□ CD Changer Control Capability — If Equipped79
□ Clock Setting Procedure74	■ Satellite Radio — If Equipped80
■ Radio General Information74	□ System Activation80
□ Radio Broadcast Signals74	□ Electronic Serial Number/Sirius Identification Number (ENS/SID)81
□ Two Types Of Signals74	□ Selecting Satellite Mode In RBB, RAH And RBK Radios81
□ Electrical Disturbances75		
□ AM Reception75		
□ FM Reception75		

66 UNDERSTANDING YOUR INSTRUMENT PANEL

□ Selecting Satellite Mode In RBP, RBU, RAZ, RB1 And RBQ Radios81	□ Reception Quality83
□ Selecting a Channel82	■ Compact Disc Maintenance83
□ Storing And Selecting Pre-Set Channels82	■ Radio Operation And Cellular Phones84
□ Using The PTY (Program Type) Button (If Equipped)82	■ Climate Controls84
□ PTY Button "Scan"82	□ Air Conditioning84
□ PTY Button "Seek"83	□ Operating Tips88
□ Satellite Antenna83	■ Electric Rear Window Defroster90
		■ Turbo Boost Gauge91

INSTRUMENT PANEL FEATURES

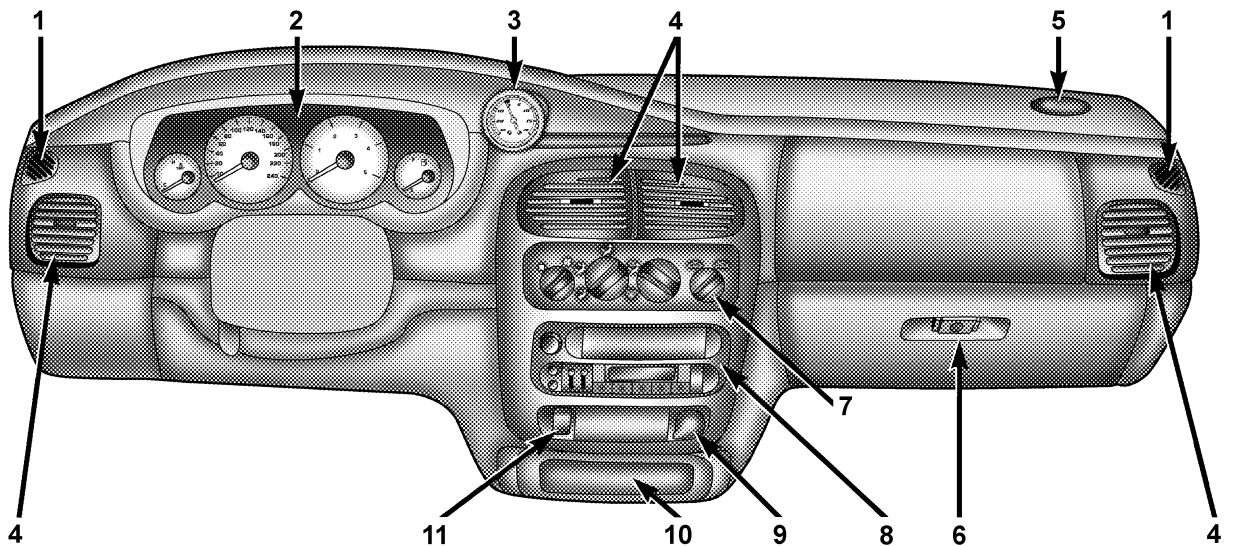

1. Side Window Demist Outlet
2. Instrument Cluster
3. Turbo Boost Gauge

4. Air Outlet
5. Radio Speaker

7. Climate Control
8. Radio
9. Cigar Lighter/
Auxiliary Power Outlet

10. Storage
11. Rear Window Defrost Switch

INSTRUMENT CLUSTER—TURBO

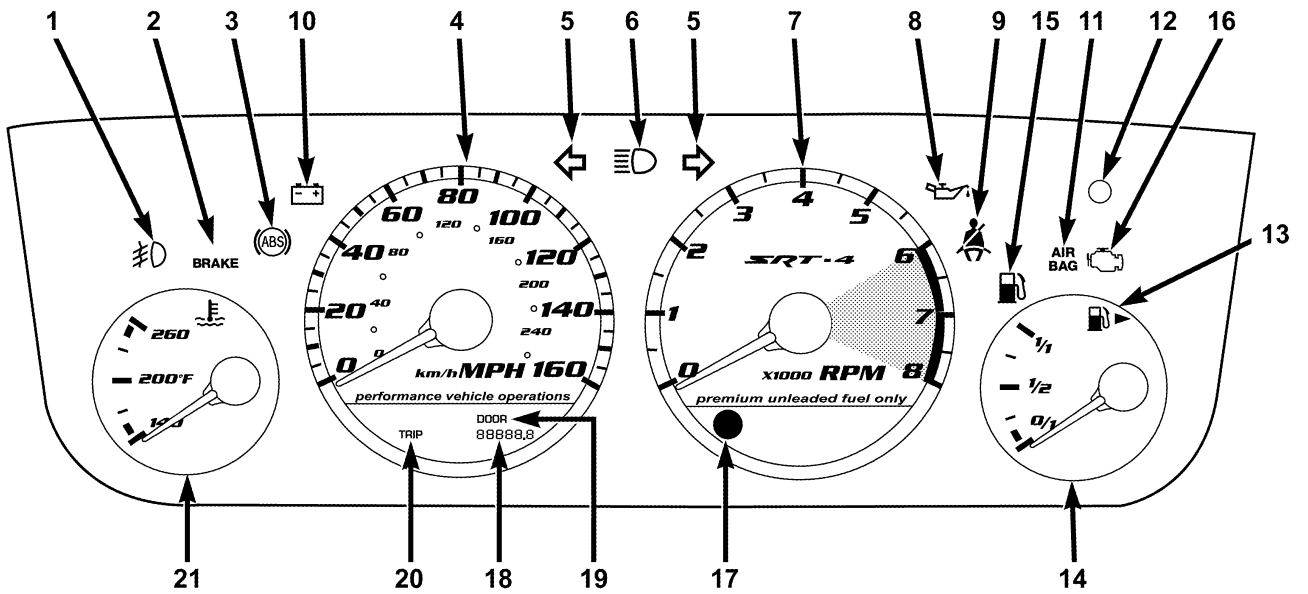

INSTRUMENT CLUSTER DESCRIPTIONS**1. Fog Light Indicator**

 This light shows when the fog lights are ON.

2. Brake System Warning Light

BRAKE This light monitors various brake functions, including brake fluid level and parking brake application. If the brake light comes on, it may indicate that the parking brake is applied, or there is a low brake fluid level. It may also indicate an ABS malfunction that could lead to reduced braking performance.

WARNING!

Driving a vehicle with the brake light on is dangerous. A significant decrease in braking performance or vehicle stability during braking may occur. It will take you longer to stop the vehicle or will make your vehicle harder to control. You could have an accident. Have the vehicle checked immediately.

The operation of the Brake Warning light can be checked by turning the ignition key from the OFF to the ON position. The light should illuminate for three seconds, or until the engine is started, whichever comes first. The light should then go out unless the parking brake is applied or a brake fault is detected. If the light does not illuminate, have the light inspected and serviced as soon as possible.

The light will also come on when the parking brake is applied with the ignition in the ON position.

NOTE: This light shows only that the parking brake is on. It does not show the degree of brake application.

If the parking brake is off and the light remains on, have the brake system inspected as soon as possible.

3. Anti-Lock Warning Light (ABS)

 This light monitors the Anti-Lock Brake System (ABS) described elsewhere in this manual. This light will come on when the ignition key is turned to the ON position and may stay on for as long as four seconds.

If the ABS light remains on or comes on during driving, it indicates that the Anti-Lock portion of the brake system is not functioning and that service is required, however, the conventional brake system will continue to operate normally provided that the BRAKE warning light is not on.

If the ABS light is on, the brake system should be serviced as soon as possible to restore the benefit of Anti-Lock Brakes.

The warning light should be checked frequently to assure that it is operating properly. Turn the ignition key to a point midway between ON and START. The light should come on. If the light does not come on, have the system checked by an authorized dealer.

4. Speedometer

Indicates vehicle speed.

5. Turn Signal Indicators

The arrows will flash in unison with the exterior turn signal, when using the turn signal lever.

6. High Beam Indicator

 This light shows that the headlights are on high beam. Pull the turn signal lever toward the steering wheel to switch the headlights from high or low beam.

7. Tachometer

The silver area of the scale shows the permissible engine revolutions-per-minute (rpm x 1000) for each gear range. Before reaching the red area, ease up on the accelerator to prevent engine damage.

8. Oil Pressure Light

 Shows low engine oil pressure. The light will come on and remain on when the ignition key is turned from OFF to the ON position, and the light will turn off after the engine is started. If the bulb does not come on during starting, have the system checked by an authorized dealer.

If the light comes on and remains on while driving, stop the vehicle and shut off the engine. **DO NOT OPERATE THE VEHICLE UNTIL THE CAUSE IS CORRECTED.**

The light does not show the quantity of oil in the engine. This can be determined using the procedure shown in Section 7.

9. *Seat Belt Reminder Light*



When the ignition key is first turned on, this light will come on for about six seconds. A chime will sound if you have not pulled the shoulder belt out of the retractor. This is a reminder to “buckle up”. If you do not buckle up, the light will remain on.

10. *Charging System Light*



This light shows the status of the electrical charging system. The light should come on briefly when the ignition is first turned on and remain on briefly as a bulb check. If the light stays on or comes on while driving, it means that there is a problem with the charging system. Obtain SERVICE IMMEDIATELY.

11. *Airbag Light*



The light comes on and remains on for 6 to 8 seconds as a bulb check when the ignition switch is first turned ON. If the light does not

come on during starting, stays on, or comes on while driving, have the system checked by an authorized dealer.

12. *Theft Alarm Light*

This light will flash rapidly for several seconds when the alarm system is arming. The light will begin to flash slowly indicating that the system is armed.

13. *Fuel Door Reminder*

This symbol is a reminder that the Fuel Filler Door is located on the passenger’s side of the vehicle

14. *Fuel Gauge*



When the ignition key is in the ON position, the pointer will show the level of fuel remaining in the fuel tank.

15. *Low Fuel Light*



When the fuel level drops to about 1/8 tank, the fuel symbol will light and a single chime will sound. The light will remain on until fuel is added. If the fuel level drops to about 1/2 gallon, the fuel symbol will begin to flash and the chime will sound several times.

16. Malfunction Indicator Light



This light is part of an onboard diagnostic system called OBD that monitors engine control systems. The light will be illuminated when the key is in the ON/RUN position before engine start. If the bulb does not come on when turning the key from OFF to ON/RUN, have the condition checked promptly.

Certain conditions such as a loose or missing gas cap, poor fuel quality, etc., may illuminate the light after engine start. The vehicle should be serviced if the light stays on through several of your typical driving cycles. In most situations, the vehicle will drive normally and will not require towing.

If the Malfunction Indicator Light flashes when the engine is running, serious conditions may exist that could lead to immediate loss of power or severe catalytic converter damage. The vehicle should be serviced as soon as possible if this occurs.

17. Odometer/Trip Odometer Reset Knob

Press this knob to switch between the odometer and trip odometer. While the trip odometer is being displayed, press and hold this knob for a few seconds to reset the trip odometer to zero miles/kilometers.

18. Odometer/Trip Odometer

Shows the total distance the vehicle has been driven.

U.S. Federal regulations require that upon transfer of vehicle ownership, the seller certify to the purchaser the correct mileage that the vehicle has been driven. Therefore, if the odometer reading changes during repair or replacement, be sure to keep a record of the reading before and after the service so the correct mileage can be determined.

19. Door Ajar Indicator

This vacuum fluorescent indicator illuminates when a door is not completely closed. If the door is open for more than 8 minutes and the ignition key is in the OFF position, the indicator will turn off.

20. Trip Indicator

This light will illuminate when the Trip Odometer is in use.

21. Temperature Gauge



The temperature gauge shows engine coolant temperature.

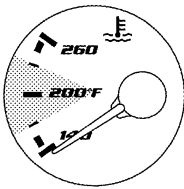

Normal operating range should be within one notch above or one notch below the 200 degree mark. The gauge pointer may show a higher than normal temperature when driving in hot weather, up mountain grades, or in heavy stop and go

traffic.

If the pointer rises to the **H** (red) mark, the instrument cluster will sound a chime. Pull off to the side of the road at a safe area. With the vehicle in Park (automatic transmission), or with the vehicle in neutral and the emergency brake applied (manual transmission), idle the vehicle with the air conditioner turned off until the

pointer drops back into the normal range. If the pointer remains on the **H** (red) mark, turn the engine off immediately and call for service.

There are steps that you can take to slow down an impending overheating condition. If your air conditioning is on, turn it off. The air conditioning system adds heat to the engine cooling system and turning off the A/C removes this heat. You can also turn the Temperature control to maximum heat, the Mode control to Floor and the Fan control to High. This allows the heater core to act as a supplement to the radiator and aids in removing heat from the engine cooling system.

ELECTRONIC DIGITAL CLOCK

The clock and radio each use the display panel built into the radio. A digital readout shows the time in hours and minutes whenever the ignition switch is in the ON or ACC position.

When the ignition switch is in the OFF position, or when the radio frequency is being displayed, time keeping is accurately maintained.

Clock Setting Procedure

1. Turn the ignition switch to the ON or ACC position. Using the tip of a ballpoint pen or similar object, press either the hour (H) or minute (M) buttons on the radio. The display will show TIME.
2. Press the H button to set hours or the M button to set minutes. The time setting will increase each time you press a button.

RADIO GENERAL INFORMATION

Radio Broadcast Signals

Your new radio will provide excellent reception under most operating conditions. Like any system, however, car radios have performance limitations, due to mobile operation and natural phenomena, which might lead you to believe your sound system is malfunctioning. To help you understand and save you concern about these “apparent” malfunctions, you must understand a point or two about the transmission and reception of radio signals.

Two Types of Signals

There are two basic types of radio signals... AM or Amplitude Modulation, in which the transmitted sound causes the amplitude, or height, of the radio waves to vary... and FM or Frequency Modulation, in which the frequency of the wave is varied to carry the sound.

Electrical Disturbances

Radio waves may pick up electrical disturbances during transmission. They mainly affect the wave amplitude, and thus remain a part of the AM reception. They interfere very little with the frequency variations that carry the FM signal.

AM Reception

AM sound is based on wave amplitude, so AM reception can be disrupted by such things as lightning, power lines and neon signs.

FM Reception

Because FM transmission is based on frequency variations, interference that consists of amplitude variations can be filtered out, leaving the reception relatively clear, which is the major feature of FM radio.

SALES CODE RBK—AM/ FM STEREO RADIO WITH CD PLAYER AND CD CHANGER CONTROLS

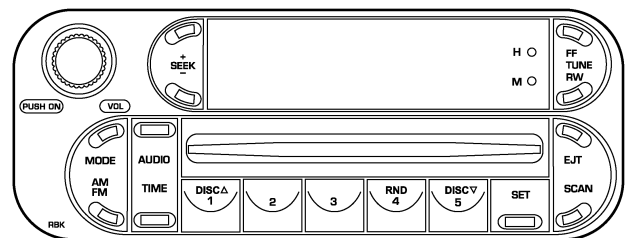

4

813ebac3

RBK Radio

Radio Operation

Power/Volume Control

Press the ON/VOL control to turn the radio on. Turn the volume control clockwise to increase the volume.

NOTE: Power to operate the radio is supplied through the ignition switch. It must be in the ON or ACC position to operate the radio.

Seek

Press and release the SEEK button to search for the next station in either the AM or FM mode. Press the top of the button to seek up and the bottom to seek down. The radio will remain tuned to the new station until you make another selection. Holding the button in will bypass stations without stopping until you release it.

Tune

Press the TUNE control up or down to increase or decrease the frequency. If you press and hold the button, the radio will continue to tune until you release the button. The frequency will be displayed and continuously updated while the button is pressed.

To Set The Radio Push-Button Memory

When you are receiving a station that you wish to commit to push-button memory, press the SET button. SET 1 will show in the display window. Select the "1-5" button you wish to lock onto this station and press and release that button. If a button is not selected within 5

seconds after pressing the SET button, the station will continue to play but will not be locked into push-button memory.

You may add a second station to each push-button by repeating the above procedure with this exception: Press the SET button twice and SET 2 will show in the display window. Each button can be set for SET 1 and SET 2 in both AM and FM. This allows a total of 10 AM and 10 FM stations to be locked into push-button memory. The stations stored in SET 2 memory can be selected by pressing the push-button twice. Every time a preset button is used a corresponding button number will be displayed.

Audio

The audio button controls the BASS, TREBLE, BALANCE, and FADE.

Press the AUDIO button and BASS will be displayed. Press the SEEK + or SEEK - to increase or decrease the Bass tones.

Press the AUDIO button a second time and TREB will be displayed. Press the SEEK + or SEEK - to increase or decrease the Treble tones.

Press the AUDIO button a third time and BAL will be displayed. Press the SEEK + or SEEK - to adjust the sound level from the right or left side speakers.

Press the AUDIO button a fourth time and FADE will be displayed. Press the SEEK + or SEEK - to adjust the sound level between the front and rear speakers.

Press the AUDIO button again or wait 5 seconds to exit setting tone, balance, and fade.

AM/FM Selection

Press the AM/FM button to change from AM to FM. The operating mode will be displayed next to the station frequency. The display will show ST when a stereo station is received.

Time

Press the TIME button to change the display between radio frequency and time.

General Information

This radio complies with Part 15 of FCC rules and with RSS-210 of Industry Canada. Operation is subject to the following conditions:

1. This device may not cause harmful interference,
2. This device must accept any interference received, including interference that may cause undesired operation.

NOTE: Changes or modifications not expressly approved by the party responsible for compliance could void the user's authority to operate the equipment.

CD Player Operation

NOTE: The ignition switch must be in the ON or ACC position and the volume control ON before the CD player will operate.

Inserting The Compact Disc

CAUTION!

This CD player will accept 4 ¾ inch (12 cm) discs only. The use of other sized discs may damage the CD player mechanism.

You may either insert or eject a disc with the radio OFF.

If you insert a disc with the ignition ON and the radio OFF, the display will show the time of day.

If the power is ON, the unit will switch from radio to CD mode and begin to play when you insert the disc. The display will show the track number and index time in minutes and seconds. Play will begin at the start of track one.

Seek

Press the top of the SEEK button for the next selection on the CD. Press the bottom of the button to return to the

beginning of the current selection, or return to the beginning of the previous selection if the CD is within the first second of the current selection.

EJT — Eject

Press the EJT button and the disc will unload and move to the entrance for easy removal. The unit will switch to the radio mode.

If you do not remove the disc within 15 seconds, it will be reloaded. The unit will continue in radio mode.

The disc can be ejected with the radio and ignition OFF (except on convertibles).

FF/TUNE/RW

Press FF (Fast Forward) and the CD player will begin to fast forward until FF is released. The RW (Reverse) button works in a similar manner.

Random Play — RND/Program Button 4

Press the RND (button 4) button while the CD is playing to activate Random Play. This feature plays the tracks on the selected disc in random order to provide an interesting change of pace.

Press the SEEK button to move to the next randomly selected track.

Press the RND (button 4) button a second time to stop Random Play.

Mode

Press the MODE button repeatedly to select between the CD player, the optional remote CD changer and the Satellite Radio (if equipped). When Satellite Radio (if equipped) is selected "SAT" will appear in your radio display.

A CD or tape may remain in the player while in the Satellite mode.

Time

Press the TIME button to change the display from elapsed CD playing time to time of day.

CD Changer Control Capability — If Equipped

This radio is compatible with a remote mounted CD changer available through Mopar Accessories. The following instructions are for the radio controls that operate this CD changer.

Mode Button

To activate the CD changer, press the MODE button until CD information appears on the display.

Disc Up/Program Button 1

Press the DISC up (button 1) button to play the next available disc.

Disc Down/Program Button 5

Press the DISC down (button 5) button to play the previous disc.

Seek Button

Press the SEEK up or down to select another track on the same disc. A SEEK symbol will appear on the display.

Fast Forward And Rewind Buttons

Press and hold the FF button for fast forward. Press and hold the RW button for fast reverse.

The audio output can be heard when fast forward and fast reverse are activated.

Random Play (RND)

Press the Random button to play the tracks on the selected disc in random order for an interesting change of pace.

Random can be cancelled by pressing the button a second time or by ejecting the CD from the changer.

Operating Instructions - Satellite Radio Mode (If Equipped)

Refer to the Satellite Radio section of the Owner's Manual.

CD Diagnostic Indicators

When driving over a very rough road, the CD player may skip momentarily. Skipping will not damage the disc or the player, and play will resume automatically.

As a safeguard and to protect your CD player, one of the following warning symbols may appear on your display.

A CD HOT symbol indicates the player is too hot.

CD HOT will pause the operation. Play can be resumed when the operating temperature is corrected or another MODE is selected.

An ERR symbol will appear on the display if the laser is unable to read the Disc data for the following reasons:

- Excessive vibration
- Disc inserted upside down
- Damaged disc
- Water condensation on optics

SATELLITE RADIO — IF EQUIPPED

Satellite radio uses direct satellite to receiver broadcasting technology to provide clear digital sound, coast to coast. The subscription service provider is Sirius™ Satellite Radio. This service offers up to 100 channels of music, sports, news, entertainment, and programming for children, directly from its satellites and broadcasting studios.

System Activation

To activate your Sirius Satellite Radio service, call the toll-free number 888-539-7474, or visit the Sirius web site at www.sirius.com. Please have the following information available when activating your system:

1. The Electronic Serial Number/Sirius Identification Number (ESN/SID).
2. Credit card information.
3. Your Vehicle Identification Number.

Electronic Serial Number/Sirius Identification Number (ENS/SID)

The Electronic Serial Number/Sirius Identification Number is needed to activate your Sirius Satellite Radio system. To access the ESN/SID, refer to the following steps:

ESN/SID Access With RBB, RAH and RBK Radios

With the ignition switch in the ACCESSORY position and the radio OFF, press the Tape Eject or CD Eject (depending on the radio type) and Time buttons simultaneously for 3 seconds. The first four digits of the twelve-digit ESN/SID number will be displayed. Press the SEEK UP button to display the next four digits. Continue to press the SEEK UP button until all twelve ESN/SID digits have been displayed. The SEEK DOWN will page down until the first four digits are displayed. The radio will exit the

ESN/SID mode when any other button is pushed, the ignition is turned OFF, or 5 minutes has passed since any button was pushed.

ESN/SID Access With RBP, RBU, RAZ, RB1 and RBQ Radios

With the ignition switch in the ACCESSORY position and the radio OFF, press the CD Eject and TIME buttons simultaneously for 3 seconds. All twelve ESN/SID numbers will be displayed. The radio will exit the ESN/SID mode when any other button is pushed, the ignition is turned OFF, or 5 minutes has passed since any button was pushed.

Selecting Satellite Mode in RBB, RAH and RBK Radios

Press the MODE button repeatedly until "S A" appears in the display. A CD or tape may remain in the radio while in the Satellite radio mode.

Selecting Satellite Mode in RBP, RBU, RAZ, RB1 and RBQ Radios

Press the MODE button repeatedly until the word "SIRIUS" appears in the display. These radios will also display the following:

- After 3 seconds, the current channel name and channel number will be displayed for 5 seconds.
- The current program type and channel number will then be displayed for 5 seconds.
- The current channel number will then be displayed until an action occurs.

A CD or tape may remain in the radio while in the Satellite radio mode.

Selecting a Channel

Press and release the SEEK or TUNE buttons to search for the next channel. Press the top of the button to search up and the bottom of the button to search down. Holding the TUNE button causes the radio to bypass channels until the button is released.

Press and release the SCAN button (if equipped) to automatically change channels every 7 seconds. The radio will pause on each channel for 7 seconds before moving on to the next channel. The word "SCAN" will appear in the display between each channel change. Press the SCAN button a second time to stop the search.

NOTE: Channels that may contain objectionable content can be blocked. Contact Sirius Customer Care at 888-539-7474 to discuss options for channel blocking or unblocking. Please have your ESN/SID information available.

Storing and Selecting Pre-Set Channels

In addition to the 10 AM and 10 FM pre-set stations, you may also commit 10 satellite stations to push button memory. These satellite channel pre-set stations will not erase any AM or FM pre-set memory stations. Follow the memory pre-set procedures that apply to your radio.

Using the PTY (Program Type) Button (if equipped)

Follow the PTY button instructions that apply to your radio.

PTY Button "SCAN"

When the desired program type is obtained, press the "SCAN" button within five seconds. The radio will play 7 seconds of the selected channel before moving to the next channel of the selected program type. Press the "SCAN" button a second time to stop the search.

NOTE: Pressing the "SEEK" or "SCAN" button while performing a music type scan will change the channel by one and stop the search. Pressing a pre-set memory button during a music type scan, will call up the memory channel and stop the search.

PTY Button "SEEK"

When the desired program is obtained, press the "SEEK" button within five seconds. The channel will change to the next channel that matches the program type selected.

Satellite Antenna

To ensure optimum reception, do not place items on the roof around the rooftop antenna location. Metal objects placed within the line of sight of the antenna will cause decreased performance. Larger luggage items should be placed as far forward as possible. Do not place items directly on or above the antenna.

Reception Quality

Satellite reception may be interrupted due to one of the following reasons.

- The vehicle is parked in an underground parking structure or under a physical obstacle.
- Dense tree coverage may interrupt reception in the form of short audio mutes.
- Driving under wide bridges or along tall buildings can cause intermittent reception.
- Placing objects over or too close to the antenna can cause signal blockage.

COMPACT DISC MAINTENANCE

To keep the compact discs in good condition, take the following precautions:

1. Handle the disc by its edge; avoid touching the surface.
2. If the disc is stained, clean the surface with a soft cloth, wiping from center to edge.
3. Do not apply paper or tape to the disc; avoid scratching the disc.
4. Do not use solvents such as benzine, thinner, cleaners, or antistatic sprays.
5. Store the disc in its case after playing.

6. Do not expose the disc to direct sunlight.
7. Do not store the disc where temperatures may become too high.

NOTE: If you experience difficulty in playing a particular disc, it may be damaged, oversized, or have theft protection encoding. Try a known good disc before considering disc player service.

RADIO OPERATION AND CELLULAR PHONES

Under certain conditions, the operation of a cellular phone in your vehicle can cause erratic or noisy performance from your radio. This condition may be lessened or eliminated by relocating the cellular phone antenna. This condition is not harmful to the radio. If your radio performance does not satisfactorily "clear" by the repositioning of the antenna, it is recommended that the radio volume be turned down or off during cellular phone operation.

CLIMATE CONTROLS

Air Conditioning

The Air Conditioning System allows you to balance the temperature, amount, and direction of air circulating throughout the vehicle.

The air conditioning system of your vehicle contains R-134a, a refrigerant that does not deplete the ozone layer in the upper atmosphere.

The controls are as follows:

Fan and Air Conditioning Control

Use this control to regulate the amount of air forced through the system in any mode you select. The fan speeds to the left of the OFF position are for Air Conditioning. Choosing one of these speeds turns on the air conditioning compressor. The fan speed increases as you move the control counter-clockwise from the OFF position.

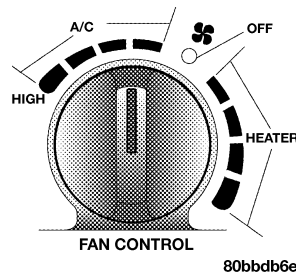

NOTE: The air conditioning compressor will not engage until the engine has been running for about 10 seconds.

Fan speeds to the right of OFF are for heater or ventilation operation. The fan speed increases as you move the control clockwise from the OFF position.

Mode Control (Air Direction)

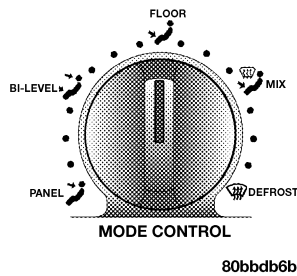

The mode control allows you to choose from several patterns of air distribution. You can select either a primary mode, as identified by the symbols, or a blend of two of these modes. The center point between modes gives an even blend of both modes. The closer the control is to a particular mode, the more air distribution you receive from that mode.

The closer the control is to a particular mode, the more air distribution you receive from that mode.

Panel

 Air is directed through the outlets in the instrument panel. These outlets can be adjusted to direct air flow.

Bi-Level

 Air is directed through the panel and floor outlets.

NOTE: There is a difference in temperature between the upper and lower outlets for added comfort. The warmer air goes to the floor outlets. This feature gives improved comfort during sunny but cool conditions.

NOTE: If you choose Defrost mode while the Circulation control is in the Recirculation Mode, the system will automatically switch to the Outside Air mode and the knob will move to that position.

Floor

 Air is directed through the floor outlets and side window demist outlets with a small amount through the defrost outlet.

Mix

 Air is directed through the floor, defrost and side window demist outlets. This setting works best in cold or snowy conditions that require extra heat at the windshield. This setting is good for maintaining comfort while reducing moisture on the windshield.

Defrost

 Air is directed through the windshield and side window demist outlets. Use this mode with maximum fan and temperature settings for best windshield and side window defrosting.

NOTE: The air conditioning compressor operates in both Mix and Defrost or a blend of these modes even if the fan switch is not in the A/C position. This dehumidifies the air to help dry the windshield. To improve fuel economy, use these modes only when necessary.

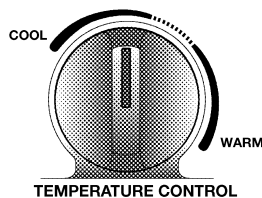
Temperature Control

80bdb6c

Use this control to regulate the temperature of the air inside the passenger compartment. The blue area of the scale indicates cooler temperatures while the red area indicates warmer temperatures.

NOTE: If your air conditioning performance seems lower than expected, check the front of the A/C condenser located in front of the radiator, for an accumulation of dirt or insects. Clean with a gentle water spray from behind the radiator and through the condenser. Fabric front fascia protectors may reduce air flow to the condenser, reducing air conditioning performance.

Circulation Control

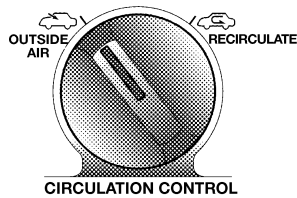

80bbdb6d

Use this control to choose between outside air intake or recirculation of the air inside the vehicle. Only use the recirculate mode to temporarily block out any outside odors, smoke, or dust and to cool the interior rapidly upon initial start up in very hot or humid weather.

This control only operates in the Outside Air and Recirculate modes; there is no in between position. Do not place the control between these positions.



















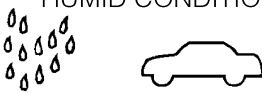

NOTE: Continuous use of the recirculate mode may make the inside air stuffy and window fogging may occur. Extended use of this mode is not recommended.

In cold weather, the use of the Recirculate position will cause windows to fog on the inside because of moisture build up inside the vehicle. For maximum defogging, select the Outside Air position.

If the mode control is in the range between Mix and Defrost and you choose the Recirculate mode, the mode control knob will automatically move to the Mix position.

NOTE: If you choose either the Mix or Defrost modes and the Circulation control is in the Recirculate Mode, the system will automatically switch to the Outside Air position.

Operating Tips

WEATHER	CONTROL SETTINGS
<p>HOT WEATHER AND VEHICLE INTERIOR IS VERY HOT</p> 	<p>Open the windows, start the vehicle, and place the Circulation control at . Set the Fan control to the high A/C position (full counterclockwise) position. Set the Mode control at or between  and . Set the temperature control to full cool. After the hot air is flushed from the vehicle, turn the Circulation control to  and roll up the windows. Once you are comfortable, place the Circulation control at  and adjust the temperature control for comfort.</p>
<p>WARM WEATHER</p> 	<p>Set the Circulation control to . If it's sunny, set the Mode control at or near  and turn the air conditioning on. If it's cloudy or dark, set the Mode control at or near .</p>
<p>COOL OR COLD HUMID CONDITIONS</p> 	<p>Set the Circulation control to . If it's sunny, set the Mode control at or between  and  then turn the air conditioning on. If it's cloudy or dark, set the Mode control at or near  and turn the air conditioning on.</p>
<p>COLD DRY CONDITIONS</p> 	<p>Set the Circulation control to . Set the Mode control at or near . If it is sunny, you may want more upper air. In this case, set the Mode control at or between  and . In very cold weather, if you need extra heat at the windshield, set the Mode control at or near the .</p>

Window Fogging

Vehicle side windows tend to fog on the inside in mild rainy or humid weather. To clear the windows, use the A/C, PANEL and blower controls. Direct the panel outlets toward the side windows. Do not use recirculate without A/C for long periods as fogging may occur.

Interior fogging on the windshield can be quickly removed by using the defrost position.

If the fogging problem persists, clean the inside window surfaces. The cause of undue fogging may be dirt collecting on the inside surface of the glass

NOTE: In cold weather, the use of the recirculate position will cause windows to fog on the inside because of moisture build up inside the vehicle. For maximum defogging, use the Outside Air position.

Summer Operation

Air conditioned vehicles must be protected with a high-quality antifreeze coolant to provide proper corrosion protection and to raise the boiling point of the coolant for protection against overheating. A 50% concentration is recommended.

Outside Air Intake

When operating the system during the winter months, make sure the air intake, directly in front of the windshield, is free of ice, slush, snow or other obstructions such as leaves. Leaves collected in the air-intake plenum may reduce air flow and plug the plenum water drains.

The blower air will heat faster in cold weather if you use only a low blower speed for the first few minutes of vehicle operation.

Side Window Demisters

A side window demister outlet is at each end of the instrument panel. These nonadjustable outlets direct air toward the side windows when the system is in either the FLOOR, MIX, or DEFROST mode. The air is directed at the area of the windows through which you view the outside mirrors.

ELECTRIC REAR WINDOW DEFROSTER

 A push-button at the center of the instrument panel, below the radio, turns the defroster and the heated mirrors (if equipped) ON or OFF. An amber light shows that the defroster is on.



Rear Defroster Switch

NOTE: The defroster turns off automatically after 10 minutes of operation. Each following activation of the defroster will last for five minutes.

CAUTION!

To avoid damaging the electrical conductors, do not use scrapers, sharp instruments, or abrasive window cleaners on the interior surface of the rear window. Labels can be peeled off after soaking with warm water.

TURBO BOOST GAUGE

Your vehicle is equipped with a boost gauge that indicates the intake manifold pressure relative to barometric pressure. The engine management system in your vehicle intelligently regulates intake manifold pressure based on environmental (ambient) and engine operating conditions. With the accelerator pedal fully depressed, it is normal for the maximum intake manifold pressure (boost) to vary from 11 to 15 psi.

If low octane fuel (below the recommended 91 octane (R+M)/2)) is used, boost will be reduced significantly. Normal boost levels will return once the recommended fuel is used and the engine controller adapts to the fuel octane level.

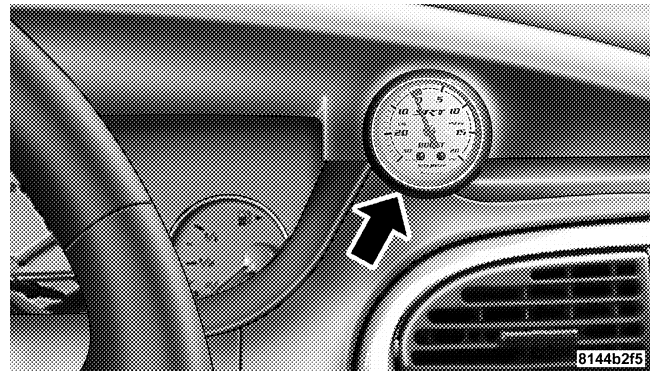

Turbo Boost Gauge

STARTING AND OPERATING

CONTENTS

■ Starting Procedures95	■ Parking Brake	100
□ Manual Transaxle95	■ Brake System	102
□ Normal Starting95	□ Anti-Lock Brake System (ABS)	102
□ Starting In Cold Weather (Below 32°F Or 0°C)95	■ Power Steering	103
□ Extremely Cold Weather (Below -20°F Or -29°C)96	■ Tire Safety Information	104
□ If Engine Fails To Start96	□ Tire Markings	104
□ After Starting97	□ Tire Identification Number (TIN)	107
□ Turbocharger “Cool Down”97	□ Tire Loading And Tire Pressure	108
■ Manual Transaxle98	■ Tires—General Information	112
□ Recommended Shift Speeds99	□ Tire Pressure	112
□ Downshifting	100	□ Tire Inflation Pressures	113

94 STARTING AND OPERATING

□ Radial-Ply Tires	115	□ Spark Knock	121
□ Compact Spare Tire	115	□ Reformulated Gasoline	121
□ Tire Spinning	116	□ Gasoline/Oxygenate Blends	122
□ Tread Wear Indicators	117	□ MMT In Gasoline	122
□ Replacement Tires	117	□ Materials Added To Fuel	122
□ Alignment And Balance	118	□ Fuel System Cautions	123
■ Tire Chains	119	□ Carbon Monoxide Warnings	123
■ Snow Tires	119	■ Adding Fuel	124
■ Tire Rotation Recommendations	120	□ Fuel Tank Filler Cap	124
■ Selecting Fuel	121	■ Vehicle Loading	125
□ 2.4L Turbo	121		

STARTING PROCEDURES

Before starting your vehicle, adjust your seat, adjust both inside and outside mirrors, and fasten your seat belts.

CAUTION!

Long periods of engine idling, especially at high engine speeds can cause excessive exhaust temperatures which can damage your vehicle. Do not leave your vehicle unattended with the engine running.

WARNING!

Do not leave children or animals inside parked vehicles in hot weather. Interior heat build up may cause serious injury or death.

Manual Transaxle

Place the gear selector in NEUTRAL, press the clutch pedal to the floor, and fully apply the parking brake before starting the engine.

NOTE: The engine will not start unless the clutch pedal is pressed to the floor.

Normal Starting

Normal Starting of either a cold or a warm engine does not require pumping or depressing the accelerator pedal. Simply turn the key to the START position and release when the engine starts. If the engine has not started within 5 seconds, slightly depress the accelerator pedal while continuing to crank. If the engine fails to start within 15 seconds, turn the key to the OFF position, wait 10 to 15 seconds, then repeat the normal starting procedure.

Starting in Cold Weather (Below 32°F or 0°C)

Slightly depress and hold the accelerator before starting the engine. Turn the key to the START position. When the engine starts, release the key, then the accelerator pedal.

If the engine fails to start within 15 seconds, turn the key OFF wait 10 to 15 seconds, then repeat the normal starting procedure.

WARNING!

Do not attempt to push or tow your vehicle to get it started. Unburned fuel could enter the catalytic converter and once the engine has started, ignite and damage the converter and vehicle. If the vehicle has a discharged battery, booster cables may be used to obtain a start from another vehicle. This type of start can be dangerous if done improperly, so follow the procedure carefully. See section 6 of this manual for jump starting instructions.

Extremely Cold Weather (below -20°F or -29°C)

To insure reliable starting at these temperatures, use of an externally powered electric engine block heater (available from your dealer) is recommended.

If Engine Fails to Start

If the engine fails to start after you have followed the "NORMAL STARTING" procedure, it may be flooded. Push the accelerator pedal all the way to the floor and hold it there. Crank the engine for no more than 15 seconds. This should clear any excess fuel in case the engine is flooded. Leave the ignition key in the ON position, release the accelerator pedal and repeat the "NORMAL STARTING" procedure.

WARNING!

Never pour fuel or other flammable liquid into the throttle body air inlet opening in an attempt to start the vehicle. This could result in flash fire causing serious personal injury.

CAUTION!

To prevent damage to the starter, do not crank the engine for more than 15 seconds at a time. Wait 10 to 15 seconds before trying again.

After Starting

The idle speed will automatically decrease as the engine warms up.

Turbocharger “Cool Down”

NOTE: Letting the engine idle after severe operation allows the turbine housing to cool to normal operating temperature.

The following chart should be used as a guide in determining the amount of engine idle time required to sufficiently cool down the turbocharger before shut down, depending upon the type of driving and the amount of cargo.

TURBOCHARGER "COOL DOWN" CHART	
Driving Conditions	Idle Time (in minutes) Before Shut Down
Normal Driving	Not required.
Aggressive Driving or Heavily Loaded	3

MANUAL TRANSAXLE

NOTE: The parking brake should be engaged and the gear selector placed in REVERSE before leaving the vehicle, especially on an incline.

NOTE: Clutch must be depressed for engine to start.

Fully depress the clutch pedal before you shift gears. As you release the clutch pedal, lightly depress the accelerator pedal.

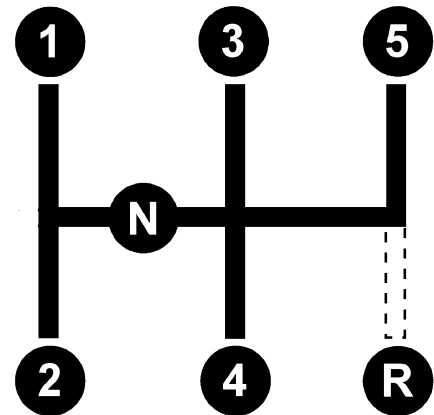

80aa960d

Use each gear in numerical order - do not skip a gear. Be sure the transaxle is in FIRST gear, (not THIRD), when starting from a standing position. Damage to the clutch can result from starting in THIRD.

For most city driving you will find it easier to use only the lower gears. For steady highway driving with light accelerations, 5th gear is recommended.

Never drive with your foot resting on the clutch pedal, or try to hold the vehicle on a hill with the clutch pedal partially engaged. This will cause abnormal wear on the clutch.

Never shift into REVERSE until the vehicle has come to a complete stop.

NOTE: During cold weather, until the transaxle lubricant has warmed, you may have difficulty shifting. This is normal and not harmful to the transaxle.

Recommended Shift Speeds

To use your manual transaxle for optimal fuel economy, it should be upshifted as listed in tables 1 and 2.

TABLE 1-MANUAL TRANSAXLE RECOMMENDED SHIFT SPEEDS IN MPH (KM/H)				
ENGINE	NORMAL ACCELERATION SHIFT SPEEDS			
	1 to 2	2 to 3	3 to 4	4 to 5
2.4L TURBO	15 (24)	25 (40)	33 (53)	44 (71)

TABLE 2-MANUAL TRANSAXLE RECOMMENDED SHIFT SPEEDS IN MPH (KM/H)				
ENGINE	CRUISE SHIFT SPEEDS			
	1 to 2	2 to 3	3 to 4	4 to 5
2.4L TURBO	16 (26)	20 (32)	28 (45)	38 (61)

For improved performance, your manual transaxle may be upshifted up to the maximum speeds listed in table 3 (within legal speed limits).

TABLE 3-MANUAL TRANSAXLE RECOMMENDED SHIFT SPEEDS IN MPH (KM/H)				
ENGINE SIZE	MAXIMUM PERFORMANCE SHIFT SPEEDS			
	1 to 2	2 to 3	3 to 4	4 to 5
2.4L TURBO	30 (48)	50 (80)	80 (129)	110 (177)

If you exceed these speeds, you may notice the engine cut in and out. This is caused by an electronic limiter in the engine computer. The engine will run normally when you reduce engine speed.

Downshifting

Proper downshifting may improve fuel economy and prolong engine life.

CAUTION!

If you skip more than one gear while downshifting or downshift at too high an engine speed, you could damage the engine, transaxle, or clutch.

To maintain a safe speed and prolong brake life, shift down to 2nd or 1st when descending a steep grade.

When turning a corner, or driving up a steep grade, shift down early so that the engine will not be overburdened.

PARKING BRAKE

BRAKE When the parking brake is applied with the ignition on, the Brake Light in the instrument cluster will come on.

NOTE: This light only shows that the parking brake is on. It does not show the degree of brake application.

Before leaving the vehicle, make sure that the parking brake is set. To set the parking brake, pull up firmly on the lever. Also place the gear selector in Reverse (manual transaxle). To release the parking brake, apply the brake pedal and pull up on the parking brake lever. Push the release button and lower the lever fully.

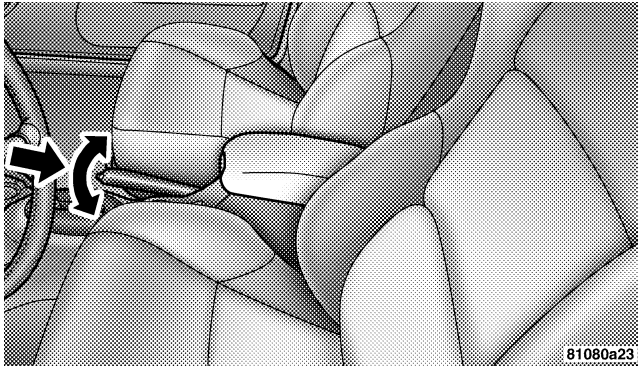

Parking Brake Lever

When parking on a hill,, turn the front wheels toward the curb on a downhill grade and away from the curb on a uphill grade.

You should always apply the parking brake before leaving the vehicle.

WARNING!

- Leaving children in a vehicle unattended is dangerous for a number of reasons. A child or others could be injured. Children should be warned not to touch the parking brake or the gear selector. Don't leave the keys in the ignition. A child could operate power windows, other controls, or move the vehicle.
- Be sure the parking brake is fully disengaged before driving; failure to do so can lead to brake failure and an accident.

BRAKE SYSTEM

Your vehicle is equipped with power assisted brakes as standard equipment. In the event power assist is lost for any reason (for example, repeated brake applications with the engine off), the brakes will still function. The effort required to brake the vehicle will be much greater than that required with the power system operating.

WARNING!

Riding the brakes can lead to brake failure and possibly an accident. Driving with your foot resting or riding on the brake pedal can result in abnormally high brake temperatures, excessive lining wear, and possible brake damage. You wouldn't have your full braking capacity in an emergency.

If either of the two hydraulic systems lose normal capability, the remaining system will still function with some loss of overall braking effectiveness. This will be evident by increased pedal travel during application and greater pedal force required to slow or stop. In addition, if the

malfunction is caused by an internal leak, as the brake fluid in the master cylinder drops, the brake warning indicator will light.

Anti-Lock Brake System (ABS)

The ABS gives increased vehicle stability and brake performance under most braking conditions. The system automatically "pumps" the brakes during severe braking conditions to prevent wheel lock up.

All vehicle wheels and tires must be the same size and tires must be properly inflated to produce accurate signals for the computer. However, the system will compensate when the compact spare is in use.

During stops where ABS is activated, a vibration of the brake pedal may be felt and associated system noises may be heard.

NOTE: Pumping of the brake pedal will diminish the effectiveness of Anti-lock brakes and may lead to an accident. Pumping makes the stopping distance longer. Just press firmly on your brake pedal when you need to slow down or stop.

WARNING!

- Anti-lock system (ABS) cannot prevent the natural laws of physics from acting on the vehicle, nor can it increase braking or steering efficiency beyond that afforded by the condition of the vehicle brakes and tires or the traction afforded.
- The ABS cannot prevent accidents, including those resulting from excessive speed in turns, following another vehicle too closely, or hydroplaning. Only a safe, attentive, and skillful driver can prevent accidents.
- The capabilities of an ABS equipped vehicle must never be exploited in a reckless or dangerous manner which could jeopardize the user's safety or the safety of others.

POWER STEERING

The power assisted steering system of your SRT-4 provides mechanical steering capability in the event power assist is lost.

If for some reason the hydraulic pressure is interrupted, it will still be possible to steer your vehicle. Under these conditions you will observe a substantial increase in steering effort.

TIRE SAFETY INFORMATION

Tire Markings

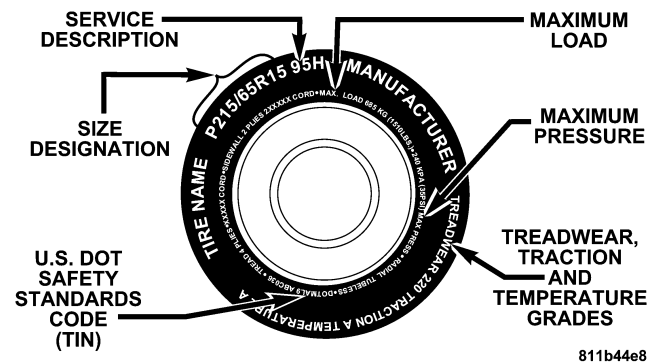

NOTE:

- P(Passenger)-Metric tire sizing is based on U.S. design standards. P-Metric tires have the letter "P" molded into the sidewall preceding the size designation. Example: P215/65R15 95H.

- European Metric tire sizing is based on European design standards. Tires designed to this standard have the tire size molded into the sidewall beginning with the section width. The letter "P" is absent from this tire size designation. Example: 215/65R15 96H
- LT(Light Truck)-Metric tire sizing is based on U.S. design standards. The size designation for LT-Metric tires is the same as for P-Metric tires except for the letters "LT" that are molded into the sidewall preceding the size designation. Example: LT235/85R16.
- Temporary Spare tires are high pressure compact spares designed for temporary emergency use only. Tires designed to this standard have the letter "T" molded into the sidewall preceding the size designation. Example: T145/80D18 103M.
- High Flotation tire sizing is based on U.S. design standards and begins with the tire diameter molded into the sidewall. Example: 31x10.5 R15 LT.

Tire Sizing Chart

EXAMPLE:	
Size Designation:	
P = Passenger car tire size based on U.S. design standards	
"...blank..." = Passenger car tire based on European design standards	
LT = Light Truck tire based on U.S. design standards	
T = Temporary Spare tire	
31 = Overall Diameter in Inches (in)	
215 = Section Width in Millimeters (mm)	
65 = Aspect Ratio in Percent (%)	—Ratio of section height to section width of tire.
10.5 = Section Width in Inches (in)	
R = Construction Code	—"R" means Radial Construction. —"D" means Diagonal or Bias Construction.
15 = Rim Diameter in Inches (in)	

EXAMPLE:	
Service Description:	
95 = Load Index	—A numerical code associated with the maximum load a tire can carry.
H = Speed Symbol	—A symbol indicating the range of speeds at which a tire can carry a load corresponding to its load index under certain operating conditions. —The maximum speed corresponding to the Speed Symbol should only be achieved under specified operating conditions. (ie. tire pressure, vehicle loading, road conditions and posted speed limits).
Load Identification:	
"....blank...."	= Absence of any text on sidewall of the tire indicates a Standard Load (SL) Tire
Extra Load (XL)	= Extra Load (or Reinforced) Tire
Light Load	= Light Load Tire
C,D,E	= Load range associated with the maximum load a tire can carry at a specified pressure
Maximum Load — Maximum Load indicates the maximum load this tire is designed to carry.	
Maximum Pressure — Maximum Pressure indicates the maximum permissible cold tire inflation pressure for this tire.	

Tire Identification Number (TIN)

The TIN may be found on one or both sides of the tire however the date code may only be on one side. Tires with white sidewalls will have the full TIN including date code located on the white sidewall side of the tire.

Look for the TIN on the outboard side of black sidewall tires as mounted on the vehicle. If the TIN is not found on the outboard side then you will find it on the inboard side of the tire.

EXAMPLE:
DOT MA L9 ABCD 0301
<p>DOT = Department of Transportation —This symbol certifies that the tire is in compliance with the U.S. Department of Transportation tire safety standards, and is approved for highway use.</p>
<p>MA = Code representing the tire manufacturing location.(2 digits)</p>
<p>L9 = Code representing the tire size.(2 digits)</p>
<p>ABCD = Code used by tire manufacturer.(1 to 4 digits)</p>
<p>03 = Number representing the week in which the tire was manufactured.(2 digits) —03 means the 3rd week.</p>
<p>01 = Number representing the year in which the tire was manufactured.(2 digits) —01 means the year 2001. —Prior to July 2000, tire manufacturers were only required to have 1 number to represent the year in which the tire was manufactured. Example: 031 could represent the 3rd week of 1981 or 1991.</p>

Tire Loading and Tire Pressure

Tire Placard Location

NOTE: Some vehicles have a “Tire and Loading Information” placard located on the driver’s side “B” pillar.

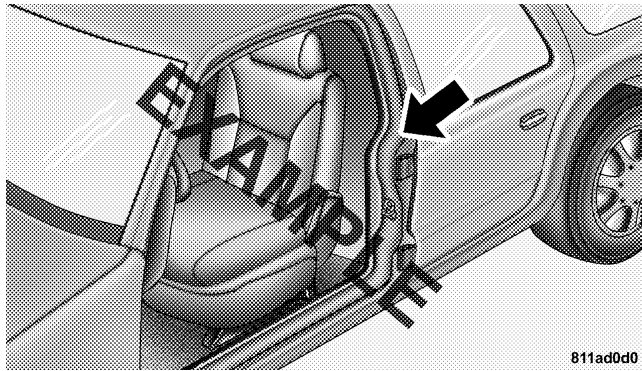

Tire Placard Location

Tire and Loading Information Placard

TIRE AND LOADING INFORMATION			
SEATING CAPACITY - TOTAL 5 FRONT 2 REAR 3			
THE COMBINED WEIGHT OF OCCUPANTS AND CARGO SHOULD NEVER EXCEED XXX KG OR XXX LBS.			
TIRE	FRONT	REAR	SPARE
ORIGINAL TIRE SIZE:	P195/70R14	P195/70R14	T125/70D15
COLD TIRE INFLATION PRESSURE	200kPa, 29PSI	200kPa, 29PSI	420kPa, 60PSI
SEE OWNER'S MANUAL FOR ADDITIONAL INFORMATION			4N109268

811b5a9a

Tire and Loading Information

This placard tells you important information about the,

- 1) number of people that can be carried in the vehicle
- 2) the total weight your vehicle can carry
- 3) the tire size designed for your vehicle
- 4) the cold tire inflation pressures for the front, rear and spare tires.

Loading

The vehicle maximum load on the tire must not exceed the load carrying capacity of the tire on your vehicle. You will not exceed the tire's load carrying capacity if you adhere to the loading conditions, tire size and cold tire inflation pressures specified on the Tire and Loading Information placard and the Vehicle Loading section of this manual.

NOTE: Under a maximum loaded vehicle condition, gross axle weight ratings (GAWR's) for the front and rear axles must not be exceeded. For further information on GAWR's, vehicle loading and trailer towing, see the Vehicle Loading section of this manual.

To determine the maximum loading conditions of your vehicle, locate the statement "The combined weight of occupants and cargo should never exceed XXX kg or XXX lbs." on the Tire and Loading Information placard. The combined weight of occupants, cargo/luggage and trailer tongue weight (if applicable) should never exceed the weight referenced here.

Steps for Determining Correct Load Limit

1. Locate the statement "The combined weight of occupants and cargo should never exceed XXX pounds" on your vehicle's placard.
2. Determine the combined weight of the driver and passengers that will be riding in your vehicle.
3. Subtract the combined weight of the driver and passengers from XXX kilograms or XXX pounds.
4. The resulting figure equals the available amount of cargo and luggage load capacity. For example, if "XXX" amount equals 1400 lbs. and there will be five 150 lb. passengers in your vehicle, the amount of available cargo and luggage load capacity is 650 lb. (1400–750 (5 x 150) = 650 lb.)
5. Determine the combined weight of luggage and cargo being loaded on the vehicle. That weight may not safely exceed the available cargo and luggage load capacity calculated in step 4.

6. If your vehicle will be towing a trailer, load from your trailer will be transferred to your vehicle. Consult this manual to determine how this reduces the available cargo and luggage load capacity of your vehicle.

NOTE: The following table shows examples on how to calculate total load, cargo/luggage and towing capacities of your vehicle with varying seating configurations and

number and size of occupants. This table is for illustration purposes only and may not be accurate for the seating and load carry capacity of your vehicle.

NOTE: For the following example the combined weight of occupants and cargo should never exceed 865 lbs. (392 Kg).

Occupants			Combined weight of occupants and cargo from Tire Placard	MINUS	Combined Occupant's weight	=	AVAILABLE Cargo/Luggage and Trailer Tongue Weight
TOTAL	FRONT	REAR					
EXAMPLE 1			865 lbs	minus	Occupant 1: 200 lbs Occupant 2: 130 lbs Occupant 3: 160 lbs Occupant 4: 100 lbs Occupant 5: 80 lbs TOTAL WEIGHT: 670 lbs	=	195 lbs
5	2	3					
EXAMPLE 2			865 lbs	minus	Occupant 1: 210 lbs Occupant 2: 180 lbs Occupant 3: 150 lbs TOTAL WEIGHT: 540 lbs	=	325 lbs
3	2	1					
EXAMPLE 3			865 lbs	minus	Occupant 1: 200 lbs Occupant 2: 200 lbs TOTAL WEIGHT: 400 lbs	=	465 lbs
2	2	0					

WARNING!

Overloading of your tire is dangerous. Overloading can cause tire failure, affect vehicle handling, and increase your stopping distance. Use tires of the recommended load capacity for your vehicle-never overload them.

TIRES—GENERAL INFORMATION**Tire Pressure**

Proper tire inflation pressure is essential to the safe and satisfactory operation of your vehicle. Three primary areas are affected by improper tire pressure:

1. Safety—**WARNING!**

Improperly inflated tires are dangerous and can cause accidents.

- Under inflation increases tire flexing and can result in tire failure.
- Over inflation reduces a tire's ability to cushion shock. Objects on the road and chuck holes can cause damage that results in tire failure.
- Unequal tire pressures can cause steering problems. You could lose control of your vehicle.
- Overinflated or under inflated tires can affect vehicle handling and can fail suddenly, resulting in loss of vehicle control.

Always drive with each tire inflated to the recommended cold tire inflation pressure.

2. *Economy*—

Improper inflation pressures can cause uneven wear patterns to develop across the tire tread. These abnormal wear patterns will reduce tread life resulting in a need for earlier tire replacement. Underinflation also increases tire rolling resistance and results in higher fuel consumption.

3. *Ride Comfort and Vehicle Stability*—

Proper tire inflation contributes to a comfortable ride. Overinflation produces a jarring and uncomfortable ride.

Tire Inflation Pressures

The proper cold tire inflation pressure for passenger cars is listed on either the face of the driver's door or the driver's side "B" pillar. For vehicles other than passenger cars, the cold tire inflation pressures are listed on either the "B" pillar, the Certification Label or in the Tire Inflation Pressures brochure in the glove compartment.

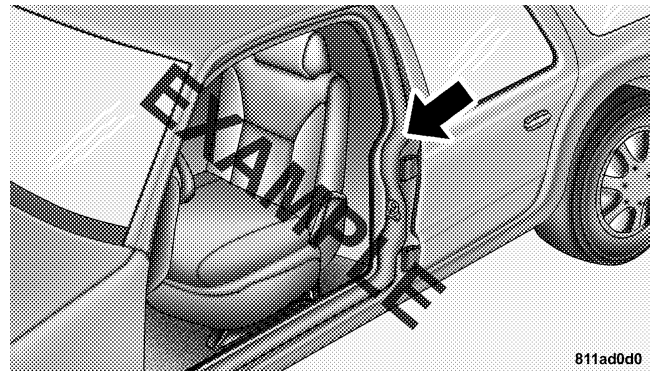

Tire Placard Location

The pressure should be checked and adjusted as well as inspecting for signs of tire wear or visible damage at least once a month. Use a good quality pocket-type gauge to check tire pressure. Do not make a visual judgement when determining proper inflation. Radial tires may look properly inflated even when they are underinflated.

CAUTION!

After inspecting or adjusting the tire pressure always reinstall the valve stem cap—if equipped. This will prevent moisture and dirt from entering the valve stem, which could damage the valve stem.

Inflation pressures specified on the placard are always “cold tire inflation pressure”. Cold tire inflation pressure is defined as the tire pressure after the vehicle has not been driven for at least 3 hours, or driven less than 1 mile (1 km) after a 3 hour period. The cold tire inflation pressure must not exceed the maximum inflation pressure molded into the tire side wall.

Check tire pressures more often if subject to a wide range of outdoor temperatures, as tire pressures vary with temperature changes.

Tire pressures change by approximately 1 psi (7 kPa) per 12° F (7° C) of air temperature change. Keep this in mind when checking tire pressure inside a garage especially in the winter.

Example: If garage temperature = 68° F (20° C) and the outside temperature = 32° F (0° C) then the cold tire inflation pressure should be increased by 3 psi (21 kPa), which equals 1 psi (7 kPa) for every 12° F (7° C) for this temperature condition.

Tire pressure may increase from 2 to 6 psi (13 to 40 kPa) during operation. DO NOT reduce this normal pressure build up or your tire pressure will be too low.

Tire Pressures for High Speed Operation

The manufacturer advocates driving at safe speeds within posted speed limits. Where speed limits or conditions are such that the vehicle can be driven at high speeds, maintaining correct tire inflation pressure is very important. Increased tire pressure and reduced vehicle loading may be required for high speed vehicle operation. Refer to original equipment or an authorized tire dealer for recommended safe operating speeds, loading and cold tire inflation pressures.

WARNING!

High speed driving with your vehicle under maximum load is dangerous. The added strain on your tires could cause them to fail. You could have a serious accident. Don't drive a vehicle loaded to the maximum capacity at continuous speeds above 75 mph (120 km/h).

Radial-Ply Tires**WARNING!**

Combining radial ply tires with other types of tires on your vehicle will cause your vehicle to handle poorly. The instability could cause an accident. Always use radial tires in sets of four. Never combine them with other types of tires.

Cuts and punctures in radial tires are repairable only in the tread area because of sidewall flexing. Consult your authorized tire dealer for radial tire repairs.

Compact Spare Tire

The compact spare is for temporary emergency use with radial tires. It is engineered to be used on your style vehicle only. Since this tire has limited tread life, the original tire should be repaired (or replaced) and reinstalled at the first opportunity.

WARNING!

Temporary use spare tires are for emergency use only. With these tires, do not drive more than 50 mph (80 km/h). Temporary-use spare tires have a total tread life of 3,000 miles (4 800 km). Be sure to follow the warnings which apply to your spare. Failure to do so could result in spare tire failure and loss of vehicle control.

Do not install a wheel cover or attempt to mount a conventional tire on the compact spare wheel, since the wheel is designed specifically for the compact spare.

Do not install more than one compact spare on your vehicle at the same time.

CAUTION!

Because of the reduced ground clearance, do not take your vehicle through an automatic car wash with the compact spare installed. Damage to the vehicle may result.

Tire Spinning

When stuck in mud, sand, snow, or ice conditions, do not spin your vehicle's wheels above 35 mph (55 km/h).

See the paragraph on Freeing A Stuck Vehicle in Section 6 of this manual.

WARNING!

Fast spinning tires can be dangerous. Forces generated by excessive wheel speeds may cause tire damage or failure. A tire could explode and injure someone. Do not spin your vehicle's wheels faster than 35 mph (55km/h) when you are stuck. And don't let anyone near a spinning wheel, no matter what the speed.

Tread Wear Indicators

Tread wear indicators are in the original equipment tires to help you in determining when your tires should be replaced.



These indicators are molded into the bottom of the tread grooves and will appear as bands when the tread depth becomes 1/16 inch (2 mm). When the indicators appear in 2 or more adjacent grooves, the tire should be replaced.

Many states have laws requiring tire replacement at this point.

Replacement Tires

The tires on your new vehicle provide a balance of many characteristics. They should be inspected regularly for wear and correct cold tire inflation pressure. The manufacturer strongly recommends that you use tires equivalent to the originals in size, quality and performance when replacement is needed (see the paragraph on tread wear indicators). Refer to the Tire and Loading Information placard for the size designation of your tire. The service description and load identification will be found on the original equipment tire. Failure to use equivalent replacement tires may adversely affect the safety, handling, and ride of your vehicle. We recommend that you contact your original equipment or an authorized tire dealer with any questions you may have on tire specifications or capability.

WARNING!

- Do not use a tire, wheel size or rating other than that specified for your vehicle. Some combinations of unapproved tires and wheels may change suspension dimensions and performance characteristics, resulting in changes to steering, handling, and braking of your vehicle. This can cause unpredictable handling and stress to steering and suspension components. You could lose control and have an accident resulting in serious injury or death. Use only the tire and wheel sizes with load ratings approved for your vehicle.
- Never use a tire with a smaller load index or capacity, other than what was originally equipped on your vehicle. Using a tire with a smaller load index could result in tire overloading and failure. You could lose control and have an accident.
- Failure to equip your vehicle with tires having adequate speed capability can result in sudden tire failure and loss of vehicle control.

CAUTION!

Replacing original tires with tires of a different size may result in false speedometer and odometer readings.

Alignment And Balance

Poor suspension alignment may result in:

- fast tire wear;
- uneven tire wear, such as feathering and one-sided wear;
- vehicle pull to right or left.

Tires may also cause the vehicle to pull to the left or right. Alignment will not correct this condition. See your dealer for proper diagnosis.

Improper alignment will not cause vehicle vibration. Vibration may be a result of tire and wheel out-of-balance. Proper balancing will reduce vibration and avoid tire cupping and spotty wear.

Tire Chains

Due to limited clearance, tire chains are not recommended.

CAUTION!

Damage to the vehicle may result if tire chains are used.

Snow Tires

Some areas of the country require the use of snow tires during winter. Some standard tires are of the all season type and satisfy this requirement as indicated by the M+S designation on the tire sidewall.

WARNING!

The SRT-4 is equipped with tires that are optimized for driving in dry and wet weather conditions. However, these tires have reduced traction capability in snow and ice. When driving an SRT-4 in these conditions with these tires, you must take special care to maintain control and avoid accidents. We recommend that you equip your vehicle with "SNOW" or "ALL SEASON" tires on all four wheels for driving in snowy and icy conditions. It is necessary to select tires equivalent in size and load rating to the original equipment tires. "SNOW" tires may have lower speed rating than factory equipped tires and may not match the maximum vehicle speed. Do not use tires or wheels other than the size recommended by the manufacturer for this vehicle.

If you need snow tires, select tires equivalent in size and load rating to the original equipment tires. Refer to the tire pressure label for inflation pressure.

Snow tires generally have lower speed ratings than what was originally equipped with your vehicle and should not be operated at sustained speeds over 75 mph (120 km/h).

Tire Rotation Recommendations

Tires on the front and rear axles of vehicles operate at different loads and perform different steering, driving and braking functions. For these reasons, they wear at unequal rates, and tend to develop irregular wear patterns.

These effects can be reduced by timely rotation of tires. The benefits of rotation are especially worthwhile with aggressive tread designs such as those on all season type tires. Rotation will increase tread life, help to maintain mud, snow and wet traction levels, and contribute to a smooth, quiet ride.

Follow the recommended tire rotation frequency for your type of driving found in the "Maintenance Schedules" Section of this manual. More frequent rotation is permissible if desired.

Your SRT-4 is equipped with directional tread pattern tires. These tires are designed to optimize dry handling as well as wet performance. To obtain the full benefits of this design, the tires must be installed so that they rotate in the correct direction. The rotation direction of this type of tire is indicated by arrows on the side wall of the tire.

TIRE ROTATION PATTERN

← FRONT OF VEHICLE

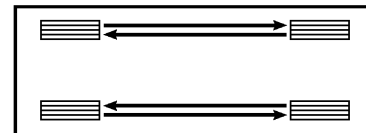

4 TIRE ROTATION

80d663f3

The required rotation method for directional tires is to swap the front tire with the rear on the same side of the vehicle. Do not cross switch tires without dismounting the tires and re-mounting them in the correct rotational direction.

SELECTING FUEL

2.4L TURBO



Your engine is designed to meet all emission regulations and provide excellent fuel economy and performance when using high quality unleaded gasoline having an octane rating of 91. The purchase of higher octane is not recommended.

High quality unleaded gasoline having a minimum octane rating of 87 may safely be used for your vehicle. Use of these lower octane gasolines, however, may result in reduced acceleration performance.

If low octane fuel (below the recommended 91 octane (R+M)/2) is used, boost will be reduced significantly. Normal boost levels will return once the recommended fuel is used and the engine controller adapts to the fuel octane level.

Spark Knock

Light spark knock at low engine speeds is not harmful to your engine. However, continued heavy spark knock at high speeds can cause damage and immediate service is required.

Poor quality gasoline can cause problems such as hard starting, stalling and hesitations. If you experience these symptoms, try another brand of “regular” gasoline before considering service for the vehicle.

Over 40 automobile manufacturers around the world have issued and endorsed consistent gasoline specifications (the World Wide Fuel Charter, WWFC) to define fuel properties necessary to deliver enhanced emissions, engine performance, and durability for your vehicle. The manufacturer recommends the use of gasolines that meet the WWFC specifications if they are available.

Reformulated Gasoline

Many areas of the country require the use of cleaner burning fuel referred to as Reformulated Gasoline. Reformulated gasolines contain oxygenates, and are specifically blended to reduce vehicle emissions and improve air quality.

The manufacturer supports the use of reformulated gasolines. Properly blended reformulated gasolines will provide excellent performance and durability for the engine and fuel system components.

Gasoline/Oxygenate Blends

Some fuel suppliers blend unleaded gasoline with materials called oxygenates such as 10% ethanol, MTBE and ETBE. Oxygenates are required in some areas of the country during the winter months to reduce carbon monoxide emissions. Fuels blended with these oxygenates may be used in your vehicle.

CAUTION!
DO NOT use gasolines containing Methanol. Gasoline containing methanol may damage critical fuel system components.

Problems that result from using methanol/gasoline blends are not the responsibility of the manufacturer. While MTBE is an oxygenate made from Methanol, it does not have the negative effects of Methanol.

MMT in Gasoline

MMT is a manganese containing metallic additive that is blended into some gasoline to increase octane. Gasolines blended with MMT provide no performance advantage beyond gasolines of the same octane number without MMT. Gasolines blended with MMT have shown to reduce spark plug life and reduce emission system performance in some vehicles. The manufacturer recommends that gasolines free of MMT be used in your vehicle. The MMT content of gasoline may not be indicated on the gasoline pump, therefore you should ask your gasoline retailer whether or not his/her gasoline contains MMT.

It is even more important to look for gasolines without MMT in Canada because MMT can be used at higher levels than allowed in the United States.

MMT is prohibited in both Federal and California reformulated gasolines.

Materials Added to Fuel

All gasoline sold in the United States is required to contain effective detergent additives. Use of additional detergents or other additives is not needed under normal

conditions and would result in unnecessary cost. Therefore you should not have to add anything to the fuel.

Fuel System Cautions

CAUTION!

Follow these guidelines to maintain your vehicle's performance:

- The use of leaded gas is prohibited by Federal law. Using leaded gasoline can impair engine performance, damage the emission control system.
- An out-of-tune engine, or certain fuel or ignition malfunctions, can cause the catalytic converter to overheat. If you notice a pungent burning odor or some light smoke, your engine may be out of tune or malfunctioning and may require immediate service. Contact your dealer for service assistance.
- The use of fuel additives which are now being sold as octane enhancers is not recommended. Most of these products contain high concentrations of methanol.

Fuel system damage or vehicle performance problems resulting from the use of such fuels or additives is not the responsibility of the manufacturer.

NOTE: Intentional tampering with emissions control systems can result in civil penalties being assessed against you.

Carbon Monoxide Warnings

WARNING!

Carbon monoxide (CO) in exhaust gases is deadly. Follow the precautions below to prevent carbon monoxide poisoning:

- Do not inhale exhaust gases. They contain carbon monoxide, a colorless and odorless gas which can kill. Never run the engine in a closed area, such as a garage, and never sit in a parked vehicle with the engine running for an extended period. If the vehicle is stopped in an open area with the engine running for more than a short period, adjust the ventilation system to force fresh, outside air into the vehicle.

- Guard against carbon monoxide with proper maintenance. Have the exhaust system inspected every time the vehicle is raised. Have any abnormal conditions repaired promptly. Until repaired, drive with all side windows fully open.
- Keep the trunk closed when driving your vehicle to prevent carbon monoxide and other poisonous exhaust gases from entering the vehicle.

ADDING FUEL

NOTE: The fuel tank filler tube has a restricting door about 2 inches (50 mm) down from the opening. If fuel is poured from a portable container, the container should have a flexible nozzle long enough to force open the restricting door.

Fuel Tank Filler Cap

The gas cap is behind the fuel filler door, on the passenger's side of the vehicle. If the gas cap is lost or damaged, be sure the replacement cap has been designed for use with this vehicle.

CAUTION!

Damage to the fuel system or emission control system could result from using an improper fuel tank filler tube cap (gas cap). A poorly fitting cap could let impurities into the fuel system.

CAUTION!

A poorly fitting gas cap may cause the Malfunction Indicator Lamp to turn on.

NOTE: When the fuel nozzle "clicks" or shuts off, the fuel tank is full.

CAUTION!

To avoid fuel spillage and overfilling, do not "top off" the fuel tank after filling.

NOTE: Tighten the gas cap about 1/4 turn until you hear one click. This is an indication that the cap is properly tightened.

If the gas cap is not tightened properly, the Malfunction Indicator light will come on. Be sure the gas cap is tightened every time the vehicle is fueled.

- To replace the cap, insert it into the filler neck and tighten to the right until at least one click is heard.

WARNING!
<ul style="list-style-type: none"> • Never have any smoking materials lit in or near the vehicle when the gas cap is removed or the tank filled. • Never add fuel when the engine is running.

WARNING!
<p>A fire may result if gasoline is pumped into a portable container that is inside of a vehicle. You could be burned. Always place gas containers on the ground while filling.</p>

- Turn off engine.
- Rotate the gas cap to the left to remove.

VEHICLE LOADING

Vehicle Loading Capacities

Front Seat Occupants	2
Rear Seat Occupants	3
Luggage	115 lbs. (52 kg)
Rated Vehicle Capacity	865 lbs. (392 kg)

WHAT TO DO IN EMERGENCIES

CONTENTS

■ Hazard Warning Flasher	128	□ Traction	136
■ If Your Engine Overheats	128	■ Freeing A Stuck Vehicle	137
■ Jacking And Tire Changing	130	■ Towing A Disabled Vehicle	138
□ Preparations For Jacking	130	□ With Ignition Key	138
□ Instructions	130	□ Without The Ignition Key	138
■ Jump-Starting Procedures Due To A Low Battery	133	□ Towing This Vehicle Behind Another Vehicle (Flat Towing With All Four Wheels On The Ground)	138
■ Driving On Slippery Surfaces	136		
□ Acceleration	136		

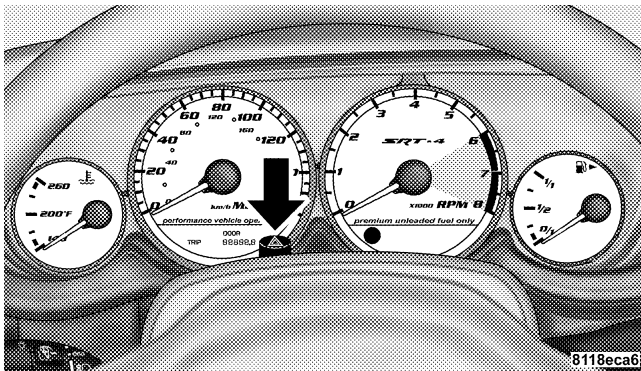
HAZARD WARNING FLASHER

Hazard Flasher Switch

 The flasher switch is on top of the steering column, just behind the steering wheel. Depress the switch and both cluster indicators and all front and rear directional signals will flash. Depress the switch again to turn Hazard Warning Flashers off.

Do not use this emergency warning system when the vehicle is in motion. Use it when your vehicle is disabled and is creating a safety hazard for other motorists.

If it is necessary to leave the vehicle to go for service, the flasher system will continue to operate with the ignition key removed and the vehicle locked.

NOTE: With extended use, the flasher may wear down your battery.

IF YOUR ENGINE OVERHEATS

In any of the following situations, you can reduce the potential for overheating by taking the appropriate action.

- On the highways — Slow down.
- In city traffic — While stopped, put transaxle in neutral, but do not increase engine idle speed.

NOTE: There are steps that you can take to slow down an impending overheat condition. If your air conditioner is on, turn it off. The air conditioning system adds heat to the engine cooling system and turning off the A/C removes this heat. You can also turn the Temperature control to maximum heat, the Mode control to floor, and the fan control to High. This allows the heater core to act as a supplement to the radiator and aids in removing heat from the engine cooling system.

CAUTION!

Driving with a hot cooling system could damage your vehicle. If temperature gauge reads over 250 degrees (in the red zone), pull over and stop the vehicle. Idle the vehicle with the air conditioner turned off until the pointer drops back into the normal range. If the pointer remains above 250 degrees (in the red zone), turn the engine off immediately, and call for service.

WARNING!

A hot engine cooling system is dangerous. You or others could be badly burned by steam or boiling coolant. You may want to call a service center if your vehicle overheats. If you decide to look under the hood yourself, see Section 7, Maintenance, of this manual. Follow the warnings under the Cooling System Pressure Cap paragraph.

JACKING AND TIRE CHANGING**WARNING!**

- Getting under a jacked-up vehicle is dangerous. The vehicle could slip off the jack and fall on you. You could be crushed. Never get any part of your body under a vehicle that is on a jack. Never start or run the engine while the vehicle is on a jack. If you need to get under a raised vehicle, take it to a service center where it can be raised on a lift.
- Do not attempt to change a tire on the side of the vehicle close to moving traffic. Pull far enough off the road to avoid the danger of being hit when operating the jack or changing the wheel.

Preparations For Jacking

Park the vehicle on a firm level surface, avoid ice or slippery areas, and set the parking brake. Place the gear selector in REVERSE.

- Turn on the Hazard Warning Flasher.

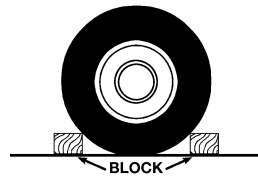

- Block both the front and rear of the wheel diagonally opposite the jacking position. For example, if changing the right front tire, block the left rear wheel.
- Passengers should not remain in the vehicle while the vehicle is being jacked.

Instructions

The spare wheel, scissors jack, and lug wrench are stowed under the spare tire cover in the rear cargo area.

Do not attempt to raise this vehicle using a bumper jack.

1. Remove the spare wheel, scissors jack and lug wrench from stowage.

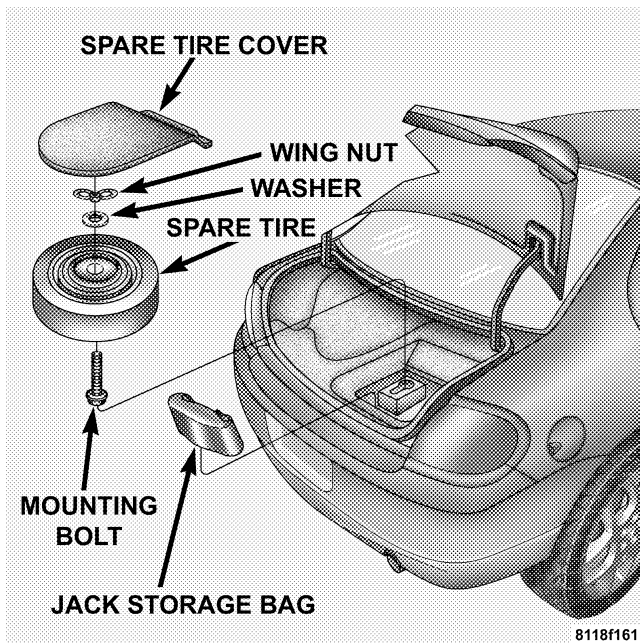

2. Loosen, but do not remove, the wheel nuts by turning them to the left one turn while the wheel is still on the ground.

CAUTION!

Do not attempt to raise the vehicle by jacking on the crossmember below the radiator or on the front suspension crossmember.

3. Jack saddle support must be positioned in between locating darts at the front of the vehicle and behind locating dart at the rear. Turn the jack screw to the right until the jack head is properly engaged with the lift area closest to the wheel to be changed.

6

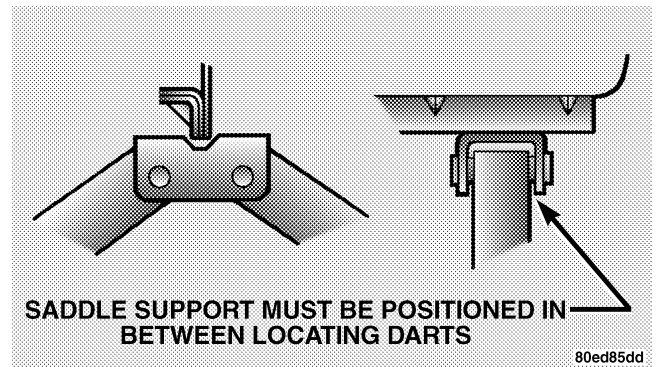

Do not raise the vehicle until you are sure the jack is securely engaged.

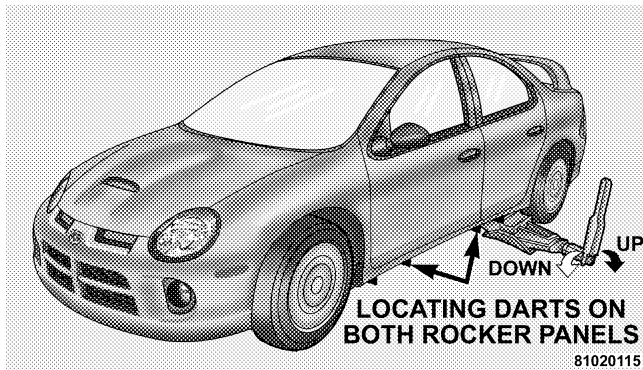

4. Raise the vehicle by turning the jack screw to the right. Raise the vehicle only until the tire clears the surface. Minimum tire lift provides maximum vehicle stability.

WARNING!

Raising the vehicle higher than necessary can make the vehicle less stable. It could slip off the jack and hurt someone near it. Raise the vehicle only enough to remove the tire.

5. Remove the wheel nuts and pull the wheel and wheel covers where applicable off the hub. Install the spare wheel and wheel nuts with the cone shaped end of the nuts toward the wheel. Lightly tighten the nuts. To avoid the risk of forcing the vehicle off the jack, do not tighten the nuts fully until the vehicle has been lowered.

WARNING!

To avoid possible personal injury, handle the wheel covers with care to avoid contact with any sharp edges.

6. Lower the vehicle by turning the jack screw to the left.

7. Finish tightening the nuts. Push down on the wrench while tightening the wheel nuts. Alternate nuts until each nut has been tightened twice. Correct wheel nut torque is 100 ft. lbs. (135 N·m.). If you are not sure about the tightness, have them checked with a torque wrench by your dealer or at a service station.

8. Remove the wheel blocks and lower the jack until it is free. Stow the lug wrench, replaced tire, and jack. Secure all parts using the means provided.

WARNING!

A loose tire or jack thrown forward in a collision or hard stop could endanger the occupants of the vehicle. Always stow the jack parts and the spare tire in the places provided.

9. Adjust the tire pressure as soon as possible.

NOTE: The spare tire well is designed to hold the compact spare tire or a deflated (flat) tire. A fully inflated tire will not fit in the spare tire well.

JUMP-STARTING PROCEDURES DUE TO A LOW BATTERY

WARNING!

Take care to avoid the radiator cooling fan whenever the hood is raised. It can start anytime the ignition switch is on. You can be hurt by the fan.

WARNING!

Do not attempt to push or tow your vehicle to get it started. Unburned fuel could enter the catalytic converter and once the engine has started, ignite and damage the converter and vehicle. If the vehicle has a discharged battery, booster cables may be used to obtain a start from another vehicle. This type of start can be dangerous if done improperly, so follow this procedure carefully.

1. Wear eye protection and remove any metal jewelry such as watch bands or bracelets that might make an inadvertent electrical contact.
2. When boosting from a battery in another vehicle, park that vehicle within booster cable reach but without letting the vehicles touch. Set parking brake, place trans-axle in NEUTRAL and turn ignition to OFF for both vehicles.
3. Turn off the heater, radio and all unnecessary electrical loads.
4. Connect one end of a jumper cable to the positive terminal of the booster battery. Connect the other end to the positive terminal of the discharged battery.

WARNING!

Do not permit vehicles to touch each other as this could establish a ground connection and person injury could result.

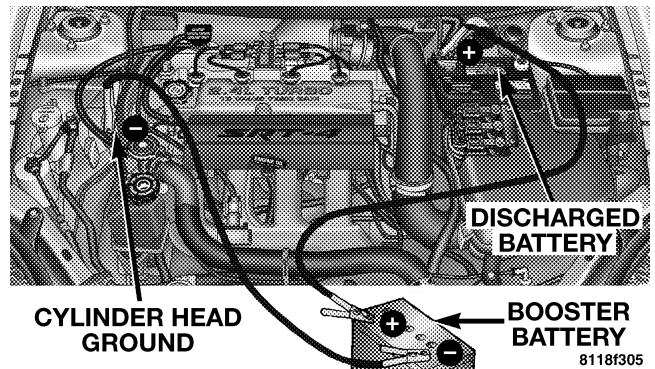

WARNING!

Battery fluid is a corrosive acid solution; do not allow battery fluid to contact eyes, skin or clothing. Don't lean over battery when attaching clamps or allow the clamps to touch each other. If acid splashes in eyes or on skin, flush the contaminated area immediately with large quantities of water.

A battery generates hydrogen gas which is flammable and explosive. Keep flame or spark away from the vent holes. Do not use a booster battery or any other booster source with an output that exceeds 12 volts.

5. Connect the other cable, first to the negative terminal of the booster battery and then to the engine of the vehicle with the discharged battery. Make sure you have a good contact on the engine.

WARNING!

Do not connect the cable to the negative post of the discharge battery. The resulting electrical spark could cause the battery to explode.

During cold weather when temperatures are below freezing point, electrolyte in a discharged battery may freeze. Do not attempt jump starting because the battery could rupture or explode. The battery temperature must be brought up above freezing point before attempting to jump start.

6. Since your vehicle is equipped with senrty key immobilizer, turn the ignition switch to the ON/RUN position for 3 seconds prior to moving the ignition switch to the crank position and starting the vehicle.

7. Start the engine in the vehicle that has the booster battery, let the engine idle a few minutes, then start the engine in the vehicle with the discharged battery.

8. When removing the jumper cables, reverse the above sequence exactly. Be careful of the moving belts and fan.

WARNING!

Any procedure other than above could result in:

1. Personal injury caused by electrolyte squirting out the battery vent;
2. Personal injury or property damage due to battery explosion;
3. Damage to charging system of booster vehicle or of immobilized vehicle.

DRIVING ON SLIPPERY SURFACES**Acceleration**

Rapid acceleration on snow covered, wet, or other slippery surfaces may cause the front wheels to pull erratically to the right or left. This phenomenon occurs when there is a difference in the surface traction under the front (driving) wheels, particularly with high output engines.

WARNING!

Rapid acceleration on slippery surfaces is dangerous. Unequal traction can cause sudden pulling of the front wheels. You could lose control of the vehicle and possibly have an accident. Accelerate slowly and carefully whenever there is likely to be poor traction (ice, snow, wet, mud, loose sand, etc.).

Traction

When driving on wet or slushy roads, it is possible for a wedge of water to build up between the tire and road surface. This is hydroplaning and may cause partial or complete loss of vehicle control and stopping ability. To reduce this possibility, the following precautions should be observed:

1. Slow down during rainstorms or when roads are slushy.
2. Slow down if road has standing water or puddles.
3. Replace tires when tread wear indicators first become visible.

4. Keep tires properly inflated.
5. Maintain enough distance between your vehicle and the vehicle in front of you to avoid a collision in a sudden stop.

FREEING A STUCK VEHICLE

If your vehicle becomes stuck in mud, sand or snow, it can often be moved by a rocking motion. Turn your steering wheel right and left to clear the area around the front wheels. Then shift back and forth between Reverse and First gear. Usually the least accelerator pedal pressure to maintain the rocking motion without spinning the wheels is most effective.

WARNING!

Fast spinning tires can be dangerous. Forces generated by excessive wheel speeds may cause tire damage or failure. A tire could explode and injure someone. Do not spin your vehicle's wheels faster than 35 mph (55km/h) when you are stuck. And don't let anyone near a spinning wheel, no matter what the speed.

CAUTION!

Racing the engine or spinning the wheels too fast may lead to transaxle overheating and failure. It can also damage the tires. Do not spin the wheels above 35 mph (55km/h).

TOWING A DISABLED VEHICLE**With Ignition Key**

Your vehicle may be towed if the gearshift lever is in NEUTRAL. If the transaxle is not operative, the vehicle must be towed with the front wheels off the ground.

CAUTION!

If the vehicle being towed requires steering, the ignition switch must be in the OFF position, not in the LOCK or ACCESSORY positions.

If it is necessary to use the accessories while being towed (wipers, defrosters, etc.), the key must be in the ON position, not the ACCESSORY position. Make certain the transaxle remains in NEUTRAL.

Without The Ignition Key

Special care must be taken when the vehicle is towed with the ignition in the LOCK position. A dolly should be used under the front wheels if the rear wheels are raised. Proper towing equipment is necessary to prevent damage to the vehicle.

Towing This Vehicle Behind Another Vehicle (Flat Towing With All Four Wheels On The Ground)

Your vehicle may be towed at any legal highway speed, for any distance, if the transaxle is in neutral.

MAINTAINING YOUR VEHICLE

CONTENTS

■ 2.4L Turbo Charged Engine Compartment	141	□ Maintenance-Free Battery	152
■ Onboard Diagnostic System — OBD II	142	□ Air Conditioner Maintenance	153
■ Emissions Inspection And Maintenance Programs	143	□ Power Steering Fluid Check	154
■ Replacement Parts	144	□ Front Suspension Ball Joints	154
■ Dealer Service	144	□ Body Lubrication	155
■ Maintenance Procedures	145	□ Windshield Wiper Blades	155
□ Engine Oil	145	□ Windshield Wiper Blade Replacement	156
□ Ignition Wiring System	151	□ Windshield Washer Aiming	156
□ Crankcase Emission Control System	151	□ Windshield Washer Reservoir	156
□ Fuel Filter	151	□ Exhaust System	156
□ Air Cleaner Element (Filter)	151	□ Cooling System	157

140 MAINTAINING YOUR VEHICLE

□ Hoses And Vacuum/Vapor Harnesses	161	□ Headlight Bulb Replacement	174
□ Brake System	162	□ Front Park/Turn Signal Lights	175
□ Manual Transaxle	164	□ Front Sidemarker Light	175
□ Appearance Care And Protection From Corrosion	165	□ Tail/Stop, Rear Turn Signals And Back-Up Lights	176
■ Fuses	170	□ Center High Mounted Stop Light	176
□ Underhood Fuses (Power Distribution Center)	170	■ Fluids And Capacities	176
□ Interior Fuses	171	■ Recommended Fluids, Lubricants And Genuine Parts	177
■ Vehicle Storage	173	□ Engine	177
■ Replacement Bulbs	173	□ Chassis	177
■ Bulb Replacement	174		

2.4L TURBO CHARGED ENGINE COMPARTMENT

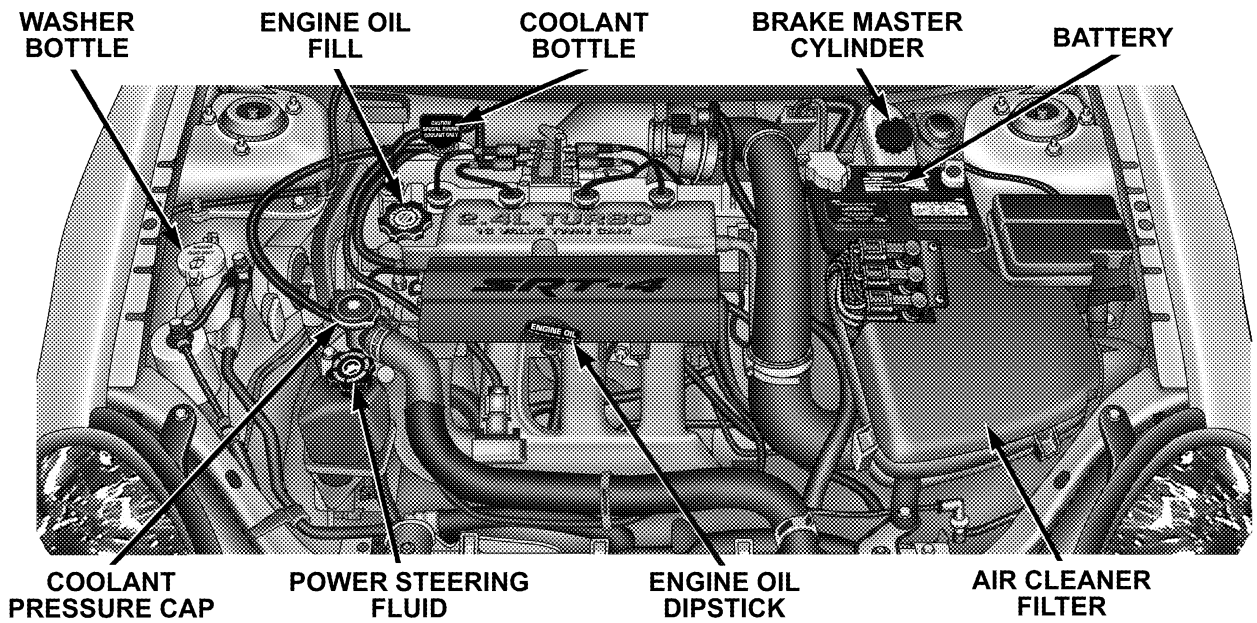

ONBOARD DIAGNOSTIC SYSTEM — OBD II

Your vehicle is equipped with a sophisticated onboard diagnostic system called OBD II. This system monitors the performance of the emissions, and engine control systems. When these systems are operating properly, your vehicle will provide excellent performance and fuel economy, as well as engine emissions well within current government regulations.

If any of these systems require service, the OBD II system will turn on the “Malfunction Indicator Light.” It will also store diagnostic codes and other information to assist your service technician in making repairs. Although your vehicle will usually be driveable and not need towing, see your dealer for service as soon as possible.

CAUTION!

Prolonged driving with the “Malfunction Indicator Light” on could cause further damage to the emission control system. It could also affect fuel economy and driveability. The vehicle must be serviced before any emissions tests can be performed.

If the “Malfunction Indicator Light” is flashing while the engine is running, severe catalytic converter damage and power loss will soon occur. Immediate service is required.

EMISSIONS INSPECTION AND MAINTENANCE PROGRAMS

In some localities, it may be a legal requirement to pass an inspection of your vehicle's emissions control system. Failure to pass could prevent vehicle registration.



For states which have an I/M (Inspection and Maintenance) requirement, this check verifies the following: the MIL (Malfunction Indicator Lamp) is functioning and is not on when the engine is running, and that the OBD (On Board Diagnostic) system is ready for testing.

Normally, the OBD system will be ready. The OBD system may **not** be ready if your vehicle was recently serviced, if you recently had a dead battery, or a battery replacement. If the OBD system should be determined not ready for the I/M test, your vehicle may fail the test.

Your vehicle has a simple ignition key actuated test which you can use prior to going to the test station. To check if your vehicle's OBD system is ready, you must do the following:

1. Insert your ignition key into the ignition switch.
2. Turn the ignition to the ON position, but do not crank or start the engine.
3. If you crank or start the engine, you will have to start this test over.
4. As soon as you turn your key to the ON position, you will see your MIL symbol come on as part of a normal bulb check.
5. Approximately 15 seconds later, one of two things will happen:
 - a. The MIL will flash for about 10 seconds and then return to being fully illuminated until you turn off the ignition key or start the engine. This means that your vehicle's OBD system is **not ready** and you should **not** proceed to the I/M station.
 - b. The MIL will not flash at all and will remain fully illuminated until you turn off the ignition key or start the engine. This means that your vehicle's OBD system is **ready** and you can proceed to the I/M station.

If your OBD system is **not ready**, you should see your authorized dealer or repair facility. If your vehicle was recently serviced or had a battery failure or replacement, you may need to do nothing more than drive your vehicle as you normally would in order for your OBD system to update. A recheck with the above test routine may then indicate that the system is now ready.

Regardless of whether your vehicle's OBD system is ready or not ready, if the MIL symbol is illuminated during normal vehicle operation, you should have your vehicle serviced before going to the I/M station. The I/M station can fail your vehicle because the MIL symbol is on with the engine running.

REPLACEMENT PARTS

Use of genuine Mopar parts for normal/scheduled maintenance and repairs is highly recommended to insure the designed performance. Damage or failures caused by the use of non-Mopar parts for maintenance and repairs will not be covered by the manufacturer warranty.

DEALER SERVICE

Your dealer has the qualified service personnel, special tools and equipment to perform all service operations in an expert manner. Service manuals are available which include detailed service information for your vehicle. Refer to these manuals before attempting any procedure yourself.

NOTE: Intentional tampering with emissions control systems can result in civil penalties being assessed against you.

WARNING!

You can be badly injured working on or around a motor vehicle. Do only that service work for which you have the knowledge and the proper equipment. If you have any doubt about your ability to perform a service job, take your vehicle to a competent mechanic.

MAINTENANCE PROCEDURES

The pages that follow contain the **required** maintenance services determined by the engineers who designed your vehicle.

Besides the maintenance items for which there are fixed maintenance intervals, there are other items that should operate satisfactorily without periodic maintenance. However, if a malfunction of these items does occur, it could adversely affect the engine or vehicle performance. These items should be inspected if a malfunction is observed or suspected.

Engine Oil**Checking Oil Level**

To assure proper engine lubrication, the engine oil must be maintained at the correct level. Check the oil level at regular intervals, such as every fuel stop.

The best time to check the engine oil level is about 5 minutes after a fully warmed engine is shut off, or before starting the engine after it has sat overnight.

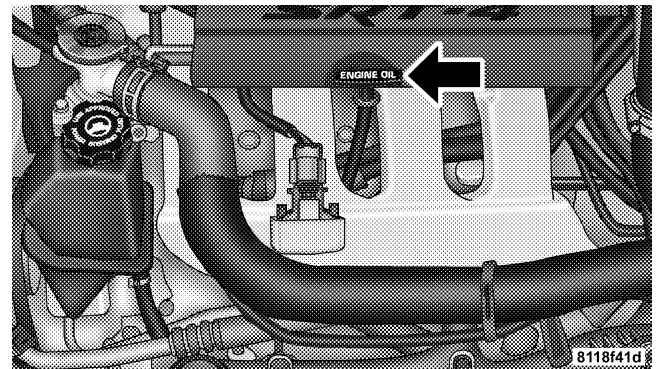

Engine Oil Dipstick Location

Checking the oil while the vehicle is on level ground will improve the accuracy of the oil level readings. Maintain the oil level between the MIN and MAX markings on the dipstick. Adding one quart of oil when the reading is at the MIN mark will result in a MAX reading on these engines.

CAUTION!

Overfilling or underfilling will cause aeration or loss of oil pressure. This could damage your engine.

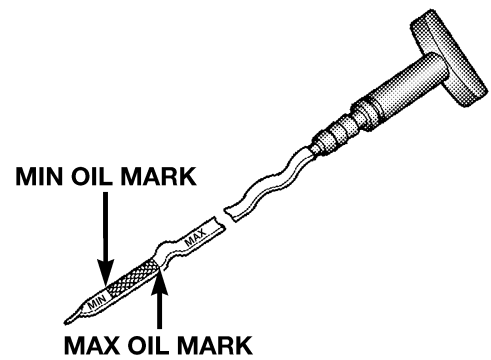

Engine Oil Dipstick

80975a64

Change Engine Oil

Road conditions and your kind of driving affects the interval at which your oil should be changed. Check the following list to decide if any apply to you.

- Day and night temperatures are below 32°F (0°C)
- Stop and Go driving
- Extensive engine idling

- Driving in dusty conditions
- Short trips of less than 10 miles (16.2 km)
- More than 50% of your driving is at sustained high speeds during hot weather, above 90°F (32°C)
- Trailer towing
- Taxi, Police, or delivery service (commercial service)
- Off-road or desert operation
- If equipped for and operating with E-85 (ethanol) fuel

NOTE: If **ANY** of these apply to you then change your engine oil every 3,000 miles (5 000 km) or 3 months, whichever comes first and follow schedule "B" of the "Maintenance Schedules" section of this manual.

If none of these apply to you, then change your engine oil at every interval shown on schedule "A" of the "Maintenance Schedules" section of this manual.

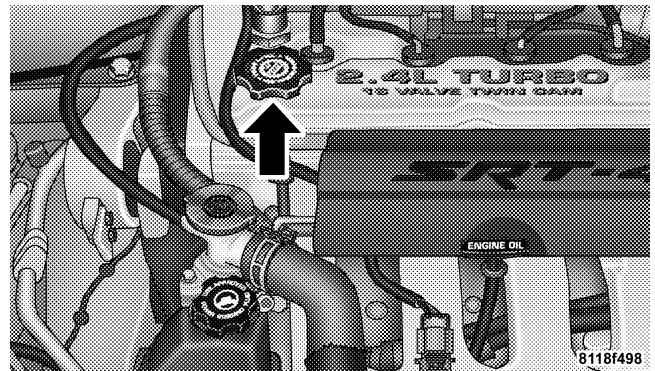

Oil Filler Cap Location

Engine Oil Selection

For best performance and maximum protection under all types of operating conditions, the manufacturer only recommends engine oils that are API certified and meet the requirements of DaimlerChrysler Material Standard MS-6395.

If you choose to operate this vehicle in a very spirited driving style, the manufacturer recommends the use of a full synthetic engine oil, such as Mobil 1® SAE 5W-30.

American Petroleum Institute (API) Engine Oil Identification Symbol



This symbol means that the oil has been certified by the American Petroleum Institute (API). The manufacturer only recommends API Certified engine oils.

Engine Oil Viscosity (SAE Grade)

SAE 5W-30 engine oil is recommended for all operating temperatures. This engine oil improves low temperature starting and vehicle fuel economy. Refer to your engine oil filler cap for the recommended engine oil viscosity for your vehicle.

For information on engine oil filler cap location, see the Engine Compartment illustration in this section.

Lubricants which do not have both, the engine oil certification mark and the correct SAE viscosity grade number should not be used.

Synthetic Engine Oils

There are a number of engine oils being promoted as either synthetic or semi-synthetic. If you chose to use such a product, use **only** those oils that are American Petroleum Institute (API) Certified and have the recommended SAE viscosity grade. Follow the maintenance schedule that describes your driving type.

Materials Added To Engine Oils

The manufacture strongly recommends against the addition of any additives (other than leak detection dyes) to the engine oil. Engine oil is an engineered product and it's performance may be impaired by supplemental additives.

Disposing of Used Engine Oil

Care should be taken in disposing of used engine oil from your vehicle. Used oil, indiscriminately discarded, can present a problem to the environment. Contact your dealer, service station, or governmental agency for advice on how and where used oil can be safely discarded in your area.

Engine Oil Filter

The engine oil filter should be replaced at every engine oil change.

Engine Oil Filter Selection

All of this manufacturer's engines have a full-flow type disposable oil filter. Use a filter of this type for replacement. The quality of replacement filters varies considerably. Only high quality filters should be used to assure most efficient service. Mopar Engine Oil Filters are high quality oil filters and are recommended.

Drive Belts — Check Condition and Tension

At the mileage shown in the maintenance schedules, check all drive belts for condition and proper tension. Improper belt tension can cause belt slippage and failure.

Inspect the drive belts for evidence of cuts, cracks, or glazing and replace them if there is any sign of damage which could result in belt failure. If adjustment is required, adjust the belts according to the specifications and procedures shown in the Service Manual.

Special tools are required to properly measure tension and to restore belt tension to factory specifications. Also,

check belt routing to make sure there is no interference between the belts and other engine components.

Spark Plugs

Spark plugs must fire properly to assure engine performance and emission control. New plugs should be installed at the specified mileage. The entire set should be replaced if there is any malfunction due to a faulty spark plug. Refer to the Vehicle Emission Control Information (VECI) label, for proper type of spark plug for use in your vehicle.

Catalytic Converter

The catalytic converter requires the use of unleaded fuel only. Leaded gasoline will destroy the effectiveness of the catalyst as an emission control device.

Under normal operating conditions, the catalytic converter will not require maintenance. However, it is important to keep the engine properly tuned to assure proper catalyst operation and prevent possible catalyst damage.

CAUTION!

Damage to the catalytic converter can result if your vehicle is not kept in proper operating condition. In the event of engine malfunction, particularly involving engine misfire or other apparent loss of performance, have your vehicle serviced promptly. Continued operation of your vehicle with a severe malfunction could cause the converter to overheat, resulting in possible damage to the converter and the vehicle.

WARNING!

A hot exhaust system can start a fire if you park over materials that can burn. Such materials might be grass or leaves coming into contact with your exhaust system. Do not park or operate your vehicle in areas where your exhaust system can contact anything that can burn.

In unusual situations involving grossly malfunctioning engine operation, a scorching odor may suggest severe and abnormal catalyst overheating. If this occurs, stop the vehicle, turn off the engine and allow it to cool. Service, including a tune up to manufacturers specifications, should be obtained immediately.

To minimize the possibility of catalyst damage:

- Do not shut off the engine or interrupt the ignition when the transaxle is in gear and the vehicle is in motion.
- Do not try to start the engine by pushing or towing the vehicle.
- Do not idle the engine with any spark plug wires disconnected for prolonged period.

Engine Timing Belt

Replace the engine timing belt at the intervals described in the appropriate maintenance schedule.

Ignition Wiring System

The ignition cables should be kept clean and properly connected. Terminals should be fully seated. Cracked, damaged, or faulty cables should be replaced.

Crankcase Emission Control System

Proper operation of this system depends on freedom from sticking or plugging due to deposits. As vehicle mileage builds up, the PCV valve and passages may accumulate deposits. If a valve is not working properly, replace it with a new valve. **DO NOT ATTEMPT TO CLEAN THE OLD PCV VALVE!**

Check ventilation hose for indication of damage or plugging deposits. Replace if necessary.

Fuel Filter

A plugged fuel filter can cause hard starting or limit the speed at which a vehicle can be driven. Should an excessive amount of dirt accumulate in the fuel tank, frequent filter replacement may be necessary.

Air Cleaner Element (Filter)

Under normal driving conditions, replace the filter at the intervals shown on Schedule "A". If, however, you drive the vehicle frequently under dusty or severe conditions, the filter element should be inspected periodically and replaced if necessary at the intervals shown on Schedule "B".

NOTE: For vehicles with a Turbo engine, a small amount of oil accumulation in the air cleaner box is normal. The amount will depend on driving style. The air cleaner box should be cleaned out and a new make-up-air filter element should be installed during the normal air filter maintenance procedure.

WARNING!

The air cleaner can provide a measure of protection in the case of engine backfire. Do not remove the air cleaner unless such removal is necessary for repair or maintenance. Make sure that no one is near the engine compartment before starting the vehicle with the air cleaner removed. Failure to do so can result in serious personal injury.

Maintenance-Free Battery

The top of the MAINTENANCE-FREE battery is permanently sealed. You will never have to add water, nor is periodic maintenance required.

CAUTION!

When servicing the battery, always reinstall the battery thermowrap. The thermowrap provides battery heat protection and will extend overall battery life. Failure to reinstall the thermowrap can result in evaporative loss of the battery fluid.

WARNING!

Battery posts, terminals and related accessories contain lead and lead compounds. Wash hands after handling.

Battery fluid is a corrosive acid solution and can burn or even blind you. Don't allow battery fluid to contact your eyes, skin or clothing. Don't lean over a battery when attaching clamps. If acid splashes in eyes or on skin, flush the area immediately with large amounts of water.

Battery gas is flammable and explosive. Keep flame or sparks away from the battery. Don't use a booster battery or any other booster source with an output greater than 12 volts. Don't allow cable clamps to touch each other.

CAUTION!

It is essential when replacing the cables on the battery that the positive cable is attached to the positive post and the negative cable is attached to the negative post. Battery posts are marked positive (+) and negative (-) and identified on the battery case. Cable clamps should be tight on the terminal posts and free of corrosion. Apply grease to posts and clamps after tightening.

If a "fast charger" is used while the battery is in the vehicle, disconnect both vehicle battery cables before connecting the charger to battery. Do not use a "fast charger" to provide starting voltage as battery damage can result.

Air Conditioner Maintenance

For best possible performance, your air conditioner should be checked and serviced by an Authorized Dealer at the start of each warm season. This service should

include cleaning of the condenser fins and a performance test. Drive belt tension should also be checked at this time.

WARNING!

- Use only refrigerants and compressor lubricants approved by the manufacturer for your air conditioning system. Some unapproved refrigerants are flammable and can explode, injuring you. Other unapproved refrigerants or lubricants can cause the system to fail, requiring costly repairs. Refer to Section 3 of the Warranty Information book for further warranty information.
- The air conditioning system contains refrigerant under high pressure. To avoid risk of personal injury or damage to the system, adding refrigerant or any repair requiring lines to be disconnected should be done by an experienced repairman.

Refrigerant Recovery and Recycling

R-134a Air Conditioning Refrigerant is a hydrofluorocarbon (HFC) that is endorsed by the Environmental Protection Agency and is an ozone-saving product. However, the manufacturer recommends that air conditioning service be performed by dealers or other service facilities using recovery and recycling equipment.

NOTE: Air Conditioning systems found to be contaminated with A/C System Sealers, Stop Leak Products, Seal Conditioners, Compressor Oil, or Refrigerants not approved by the manufacturer, voids the warranty for the Air Conditioning system.

Power Steering Fluid Check

Checking the power steering fluid level at a defined service interval is not required. The fluid should only be checked if a leak is suspected, abnormal noises are apparent, and/or the system is not functioning as anticipated. Coordinate inspection efforts through a certified DaimlerChrysler Dealership."

WARNING!

Fluid level should be checked on a level surface and with the engine off to prevent injury from moving parts and to insure accurate fluid level reading. Do not overfill. Use only manufacturers recommended power steering fluid.

If necessary, add fluid to restore to the proper indicated level. With a clean cloth, wipe any spilled fluid from all surfaces. Refer to Recommended Fluids, Lubricants, and Genuine Parts for correct fluid types.

Front Suspension Ball Joints

There are two front suspension lower ball joints that are permanently lubricated. Inspect these ball joints whenever under-vehicle service is done. Damaged seals should be replaced to prevent leakage or grease contamination.

Body Lubrication

Locks and all body pivot points, including such items as seat tracks, doors, trunk and hood hinges, should be lubricated periodically to assure quiet, easy operation and to protect against rust and wear. Prior to the application of any lubricant, the parts concerned should be wiped clean to remove dust and grit; after lubricating excess oil and grease should be removed. Particular attention should also be given to hood latching components to insure proper function. When performing other underhood services, the hood latch, release mechanism and safety catch should be cleaned and lubricated.

The external lock cylinders should be lubricated twice a year, preferably in the fall and spring. Apply a small amount of a high quality lubricant such as Mopar® Lock Cylinder Lubricant directly into the lock cylinder.

Windshield Wiper Blades

Clean the rubber edges of the wiper blades and the windshield periodically with a sponge or soft cloth and a mild non abrasive cleaner, or use the washer solvent. This will remove accumulations of salt or road film and help reduce streaking and smearing.

Operation of the wipers on dry glass for long periods may cause deterioration of the wiper blades. Always use washer fluid when using the wipers to remove salt or dirt from a dry windshield. Avoid using the wiper blades to remove frost or ice from the windshield. Make sure that they are not frozen to the glass before turning them on to avoid damaging the blade. Keep the blade rubber out of contact with petroleum products such as engine oil, gasoline, etc.

Windshield Wiper Blade Replacement

1. Lift the wiper arm away from the glass.
2. Rotate the blade 45 degrees to gain access to the release tab.
3. Push the release tab shown in the picture and slide the wiper blade assembly down along the arm. Gently place the wiper arm on the windshield.

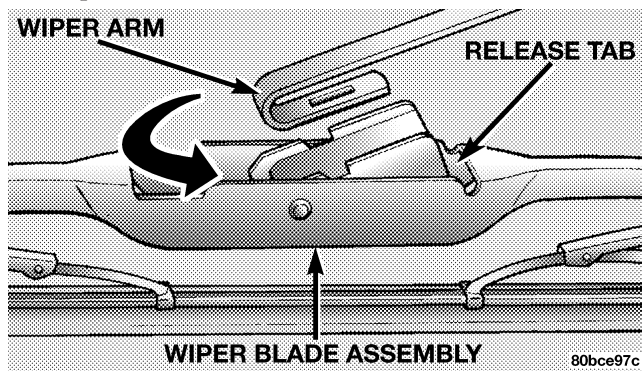

4. Install the new blade assembly onto the wiper arm tip until it locks in place.

Windshield Washer Aiming

To change the aim of the windshield washers, place a safety pin into the nozzle opening and move the nozzle slightly. Continue making slight adjustments until you obtain the desired pattern.

Windshield Washer Reservoir

The washer fluid reservoir is located in the engine compartment and should be checked for fluid level at regular intervals. Fill the reservoir with windshield washer solvent (not radiator antifreeze).

Exhaust System

The best protection against carbon monoxide entry into the vehicle body is a properly maintained engine exhaust system.

If you notice a change in the sound of the exhaust system; or if exhaust fumes can be detected inside the vehicle; or when the underside or rear of the vehicle is damaged; have a competent mechanic inspect the complete exhaust system and adjacent body areas of broken, damaged, deteriorated, or mispositioned parts. Open seams or loose connections could permit exhaust fumes to seep into the passenger compartment. In addition, inspect the exhaust system each time the vehicle is raised for lubrication or oil change. Replace as required.

WARNING!

Exhaust gases can injure or kill. They contain carbon monoxide which is colorless and odorless. Breathing it can make you unconscious and can eventually poison you. Follow the above precautions to keep your exhaust system as safe as possible.

Cooling System

WARNING!

- When working near the radiator cooling fan, disconnect the fan motor lead or turn the ignition switch to the OFF position. The fan is temperature controlled and can start at any time the ignition switch is in the ON position.
- You or others can be badly burned by hot coolant or steam from your radiator. If you see or hear steam coming from under the hood, don't open the hood until the radiator has had time to cool. Never try to open a cooling system pressure cap when the radiator is hot.

Coolant Checks

Check engine coolant (antifreeze) protection every 12 months (before the onset of freezing weather, where applicable). If coolant is dirty or rusty in appearance, the system should be drained, flushed and refilled with fresh coolant.

Check the front of the radiator for an accumulation of bugs, leaves, etc. Clean the radiator by gently spraying water from a garden hose at the back of the core.

Check the coolant recovery bottle tubing for brittle rubber, cracking, tears, cuts and tightness of the connection at the bottle and radiator. Inspect the entire system for leaks.

With the engine at normal operating temperature (but not running), check the cooling system pressure cap for proper vacuum sealing by draining a small amount of coolant from the radiator drain cock. If the cap is sealing properly, the engine coolant (antifreeze) will begin to drain from the coolant recovery bottle. **DO NOT REMOVE THE COOLANT PRESSURE CAP WHEN THE COOLING SYSTEM IS HOT.**

Cooling System — Drain, Flush and Refill

At the intervals shown on the Maintenance Schedules, the system should be drained, flushed and refilled.

If the solution is dirty and contains a considerable amount of sediment, clean and flush with a reliable cooling system cleaner. Follow with a thorough rinsing to remove all deposits and chemicals. Discard oil antifreeze solution.

Selection Of Coolant

Use only the manufacturers recommended coolant, refer to Recommended Fluids, Lubricants and Genuine Parts for correct coolant type.

CAUTION!

Mixing of coolants other than specified engine coolants, may result in engine damage and may decrease corrosion protection. If a non-HOAT coolant is introduced into the cooling system in an emergency, it should be replaced with the specified coolant as soon as possible.

Do not use plain water alone or alcohol base engine coolant (antifreeze) products. Do not use additional rust inhibitors or antirust products, as they may not be compatible with the radiator engine coolant and may plug the radiator.

This vehicle has not been designed for use with Propylene Glycol based coolants. Use of Propylene Glycol based coolants is not recommended.

Adding Coolant

When adding coolant, or refilling the system, a minimum solution of 50% recommended HOAT ethylene glycol engine coolant (antifreeze) and distilled water should be used. Use higher concentrations (not to exceed 70%) if temperatures below -37°C (-34°F) are anticipated.

Use only high purity water such as distilled or deionized water when mixing the water/engine coolant solution. The use of lower quality water will reduce the amount of corrosion protection in the engine cooling system.

Please note that it is the owner's responsibility to maintain the proper level of protection against freezing according to the temperatures occurring in the area where the vehicle is operated.

NOTE: Mixing coolant types will decrease the life of the engine coolant and will require more frequent coolant changes.

Cooling System Pressure Cap

The cap must be fully tightened to prevent loss of coolant, and to insure that coolant will return to the radiator from the coolant reserve tank.

The cap should be inspected and cleaned if there is any accumulation of foreign material on the sealing surfaces.

WARNING!

The warning words "DO NOT OPEN HOT" on the cooling system pressure cap are a safety precaution. Never add coolant when the engine is overheated. Do not loosen or remove the cap to cool an overheated engine. Heat causes pressure to build up in the cooling system. To prevent scalding or injury, do not remove the pressure cap while the system is hot or under pressure.

7

Engine Coolant Disposal

Used ethylene glycol based engine coolant is a regulated substance requiring proper disposal. Check with your local authorities to determine the disposal rules for your community. Do not store ethylene glycol based engine coolant in open containers or allow it to remain in puddles on the ground. Prevent ingestion by animals or children. If ingested by a child, contact a physician immediately.

Coolant Level

The coolant bottle provides a quick visual method for determining that the coolant level is adequate. With the engine idling, and warm to normal operating temperature, the level of the coolant in the bottle should be between the "FULL" and "ADD" marks.

The radiator normally remains completely full, so there is no need to remove the radiator cap unless checking for coolant freeze point or replacing coolant. Advise your service attendant of this. As long as the engine operating temperature is satisfactory, the coolant bottle need only be checked once a month.

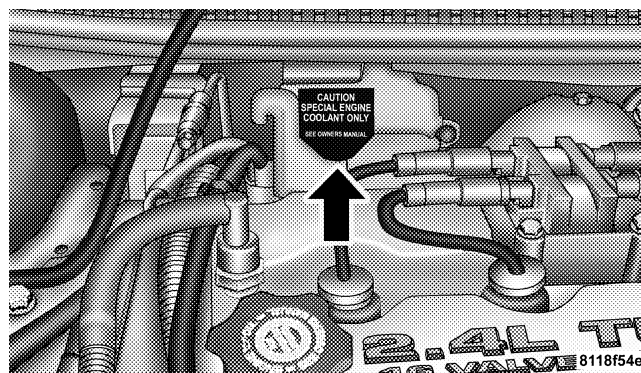

Engine Coolant Bottle

When additional coolant is needed to maintain the proper level, it should be added to the coolant bottle. Do not overfill.

Points To Remember

NOTE: When the vehicle is stopped after a few kilometers (a few miles) of operation, you may observe vapor coming from the front of the engine compartment. This is normally a result of moisture from rain, snow, or high humidity accumulation on the radiator and being vaporized when the thermostat opens, allowing hot water to enter the radiator.

If an examination of your engine compartment shows no evidence of radiator or hose leaks, the vehicle may be safely driven. The vapor will soon dissipate.

- Do not overfill the coolant recovery bottle.
- Check coolant freeze point in the system.
- If frequent coolant additions are required, the cooling system should be pressure tested for leaks.
- Maintain coolant concentration at 50% HOAT ethylene glycol engine coolant (minimum) and distilled water for proper corrosion protection of your engine which contains aluminum components.

- Make sure that the radiator and coolant recovery bottle hoses are not kinked or obstructed.
- Keep the front of the radiator clean. If your vehicle has air conditioning, keep the front of the condenser clean, also.
- Do not change the thermostat for summer or winter operation. If replacement is ever necessary, install **ONLY** the correct type thermostat. Other designs may result in unsatisfactory coolant performance, poor gas mileage, and increased emissions.

Hoses And Vacuum/Vapor Harnesses

Inspect surfaces of hoses and nylon tubing for evidence of heat and mechanical damage. Hard or soft spots, brittle rubber, cracking, checking, tear, cuts, abrasions, and excessive swelling indicate deterioration of the rubber.

Pay particular attention to the hoses nearest to high heat sources such as the exhaust manifold. Inspect hose routing to be sure hoses do not touch any heat source or moving component that may cause heat damage or mechanical wear.

Insure nylon tubing in these areas has not melted or collapsed.

Inspect all hose connections such as clamps and couplings to make sure they are secure and no leaks are present.

Components should be replaced immediately if there is any evidence of degradation that could cause failure.

Brake System

In order to assure brake system performance, all brake system components should be inspected periodically. Suggested service intervals can be found in the Maintenance Section.

WARNING!

Riding the brakes can lead to brake failure and possibly an accident. Driving with your foot resting or riding on the brake pedal can result in abnormally high brake temperatures, excessive lining wear, and possible brake damage. You wouldn't have your full braking capacity in an emergency.

Brake and Power Steering System Hoses

When servicing the vehicle for scheduled maintenance, inspect surface of hoses and nylon tubing for evidence of heat and mechanical damage. Hard and brittle rubber, cracking, checking, tears, cuts, abrasions, and excessive swelling suggest deterioration of the rubber. Particular attention should be made to examining those hose surfaces nearest to high heat sources, such as the exhaust manifold.

Inspect all hose clamps and couplings to make sure they are secure and no leaks are present.

Insure nylon tubing in these areas has not melted or collapsed.

NOTE: Often, fluids such as oil, power steering fluid, and brake fluid are used during assembly plant operations to ease the assembly of hoses to couplings. Therefore, oil wetness at the hose-coupling area is not necessarily an indication of leakage. Actual dripping of hot fluid when systems are under pressure (during vehicle operation) should be noted before hose is replaced based on leakage.

NOTE: Inspection of brake hoses should be done whenever the brake system is serviced and every engine oil change.

WARNING!

Worn brake hoses can burst and cause brake failure. You could have an accident. If you see any signs of cracking, scuffing, or worn spots, have the brake hoses replaced immediately.

Brake Master Cylinder

The fluid level in the master cylinder should be checked when performing under hood services, or immediately if the brake system warning lamp is on.

Be sure to clean the top of the master cylinder area before removing the cap. If necessary, add fluid to bring the fluid level up to the requirements described on the brake fluid reservoir. Fluid level can be expected to fall as the brake pads wear. Brake fluid level should be checked when pads are replaced. However, low fluid level may be caused by a leak and a checkup may be needed.

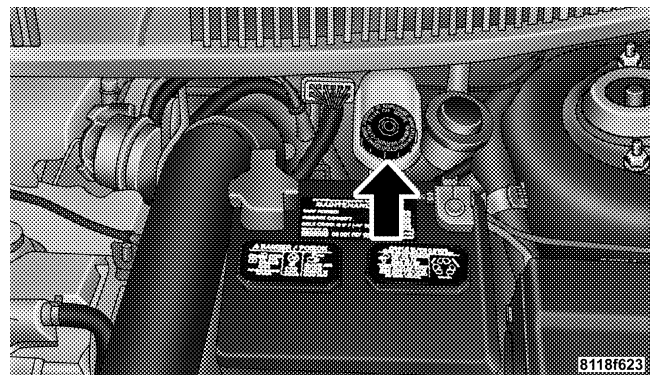

Brake Fluid Master Cylinder

Use only manufacturers recommended brake fluid, refer to Recommended Fluids, Lubricants and Genuine Parts for correct fluid type.

WARNING!

Use of a brake fluid that may have a lower initial boiling point or unidentified as to specification, may result in sudden brake failure during hard prolonged braking. You could have an accident.

WARNING!

Overfilling the brake fluid reservoir can result in spilling brake fluid on hot engine parts and the brake fluid catching fire.

Use only brake fluid that has been in a tightly closed container to avoid contamination from foreign matter.

Do not allow petroleum based fluid to contaminate the brake fluid as seal damage will result!

Manual Transaxle**Lubricant Selection**

Use only manufacturers recommended transmission fluid, refer to Recommended Fluids, Lubricants and Genuine Parts for correct fluid type.

Fluid Level Check

Check the fluid level by removing the fill plug. The fluid level should be between the bottom of the fill hole and a point not more than 3/16" (4.76 mm) below the bottom of the hole.

Add fluid, if necessary, to maintain the proper level.

Frequency of Fluid Change

Refer to the Maintenance Schedule in Section 8 of this manual.

Appearance Care and Protection from Corrosion

Protection of Body and Paint from Corrosion

Vehicle body care requirements vary according to geographic locations and usage. Chemicals that make roads passable in snow and ice, and those that are sprayed on trees and road surfaces during other seasons, are highly corrosive to the metal in your vehicle. Outside parking, which exposes your vehicle to airborne contaminants, road surfaces on which the vehicle is operated, extreme hot or cold weather and other extreme conditions will have an adverse effect on paint, metal trim, and underbody protection.

The following maintenance recommendations will enable you to obtain maximum benefit from the corrosion resistance built into your vehicle.

What Causes Corrosion?

Corrosion is the result of deterioration or removal of paint and protective coatings from your vehicle.

The most common causes are:

- Road salt, dirt and moisture accumulation.

- Stone and gravel impact.
- Insects, tree sap and tar.
- Salt in the air near sea coast localities.
- Atmospheric fallout/industrial pollutants.

Washing

- Wash your vehicle regularly. Always wash your vehicle in the shade using a mild car wash soap, and rinse the panels completely with clear water.
- If insects, tar or other similar deposits have accumulated on your vehicle, wash it as soon as possible.
- Use Mopar auto polish to remove road film and stains and to polish your vehicle. Take care never to scratch the paint.
- Avoid using abrasive compounds and power buffing that may diminish the gloss or thin out the paint finish.

CAUTION!

Do not use abrasive or strong cleaning materials such as steel wool or scouring powder, which will scratch metal and painted surfaces. Many wheel cleaners contain acids that may harm the wheel surface.

Special Care

- If you drive on salted or dusty roads or if you drive near the ocean, hose off the undercarriage at least once a month.
- It is important that the drain holes in the lower edges of the doors, rocker panels and rear deck lid be kept clear and open.
- If you detect any stone chips or scratches in the paint, touch them up immediately. The cost of such repairs is considered the responsibility of the owner.
- Use Mopar touch up paint on scratches or chips as soon as possible. Your dealer has touch up paint to match the color of your vehicle.

- If your vehicle is damaged due to an accident or similar cause which destroys the paint and protective coating, have your vehicle repaired as soon as possible. The cost of such repairs is considered the responsibility of the owner.
- If you carry special cargo such as chemicals, fertilizers, deicer salt, etc., be sure that such materials are well packaged and sealed.
- If a lot of driving is done on gravel roads, consider mud or stone shields behind each wheel.

Wheel And Wheel Trim Care

All wheels and wheel trim, especially Aluminum and Chrome plated, should be cleaned regularly, using mild soap and water to maintain their luster and to prevent corrosion. Wash them with the same soap solution as the body of your vehicle. Rinse wheels thoroughly.

When cleaning extremely dirty wheels, care must be taken in the selection of tire and wheel cleaning chemicals and equipment to prevent damage to the wheels.

Only Mopar Wheel Cleaners are recommended. Any of the "DO NOT USE" items listed below can damage wheels and wheel trim.

DO NOT USE:

- Any abrasive cleaner
- Any abrasive cleaning pad (such as steel wool) or abrasive brush
- Any cleaner that contains an acid which can react with and discolor the chrome surface.

CAUTION!

Many wheel cleaners contain acids that may harm the wheel surface.

- Oven cleaner
- A car wash that uses carbide-tipped wheel cleaning brushes or acidic solutions.

Interior Care

Use Mopar Fabric Cleaner to clean fabric upholstery and carpeting.

Use Mopar Vinyl Cleaner to clean vinyl upholstery.

Mopar Vinyl Cleaner is specifically recommended for vinyl trim.

Your leather upholstery can be best preserved by regular cleaning with a damp soft cloth. Small particles of dirt can act as an abrasive and damage the leather upholstery and should be removed promptly with a damp cloth. Stubborn soils can be removed easily with a soft cloth and Mopar Total Clean. Care should be taken to avoid soaking your leather upholstery with any liquid. Please do not use polishes, oils, cleaning fluids, solvents, detergents, or ammonia based cleaners to clean your leather upholstery. Application of a leather conditioner is not required to maintain the original condition.

WARNING!

Do not use volatile solvents for cleaning purposes. Many are potentially flammable, and if used in closed areas they may cause respiratory harm.

Cleaning Headlights

Your vehicle has plastic headlights that are lighter and less susceptible to stone breakage than glass headlights.

Plastic is not as scratch resistant as glass and therefore different lens cleaning procedures must be followed.

To minimize the possibility of scratching the lenses and reducing light output, avoid wiping with a dry cloth. To remove road dirt, wash with a mild soap solution followed by rinsing.

Do not use abrasive cleaning components, solvents, steel wool or other aggressive material to clean the lenses.

Glass Surfaces

All glass surfaces should be cleaned on a regular basis with any commercial household-type glass cleaner. Never use an abrasive type cleaner. Use caution when cleaning inside rear windows equipped with electric defrosters. Do not use scrapers or other sharp instruments which may scratch the elements.

Instrument Panel Cover

The instrument panel cover has a low glare surface which minimizes reflections in the windshield. Do not use protectants or other products which may cause undesirable reflections. Use soap and warm water to restore the low glare surface.

Cleaning Plastic Instrument Cluster Lenses

The lenses in front of the instruments in the vehicle are molded in clear plastic. When cleaning the lenses, care must be taken to avoid scratching the plastic.

1. Clean with a wet soft rag. A mild soap solution may be used, but do not use high alcohol content or abrasive cleaners. If soap is used, wipe clean with a clean damp rag.
2. Dry with a soft tissue.

Seat Belt Maintenance

Do not bleach, dye or clean the belts with chemical solvents or abrasive cleaners. This will weaken the fabric. Sun damage will also weaken the fabric.

If the belts need cleaning, use a mild soap solution or lukewarm water. Do not remove the belts from the vehicle to wash them.

Replace the belts if they appear frayed or worn or if the buckles do not work properly.

FUSES

Underhood Fuses (Power Distribution Center)

A Power Distribution Center is located in the engine compartment; next to the battery. A label identifying the components and circuits is located on the underside of the cover.

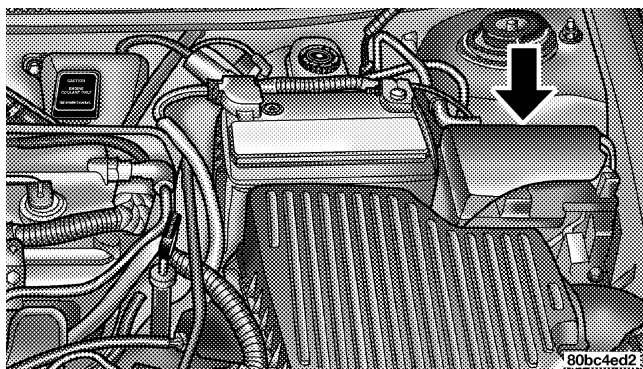

Underhood Fuses (Power Distribution Center)

FUSE	Amp/Color	Items Fused
1	—	—
2	—	—
3	40 Amp/ Green	Headlamps
4	40 Amp/Blue	Ignition Run
5	30 Amp/ Green	ABS Solenoid
6	30 Amp/Blue	Radiator Fan
7	Spare	
8	40 Amp/ Green	ABS Pump
9	30 Amp/ Green	Starter
10	40 Amp/ Green	Electric Back Light (EBL)
11	Spare	
12	Spare	
13	20 Amp/ Yellow	IOD/Int Lighting/Radio
14	20 Amp/Lt. Blue	Power Outlet

15	15 Amp/ Yellow	Hazard Flasher
16	15 Amp/Lt. Blue	MTV
17	20 Amp/ Yellow	Electronic Automatic Transaxle (EATX)
18	10 Amp/Red	Horn
19	Spare	
20	20 Amp/ Yellow	Fog Lamp (Export Only)
21	20 Amp/ Yellow	ASD/Fuel Pump
22	10 Amp/Red	A/C Clutch
23	15 Amp/Lt. Blue	Stop Lamps

Interior Fuses

The fuse access panel is behind the end cover at the left side of the instrument panel. To remove the panel, pull it out, as shown. A diagram identifying the components and circuits is located on the inside of the cover.

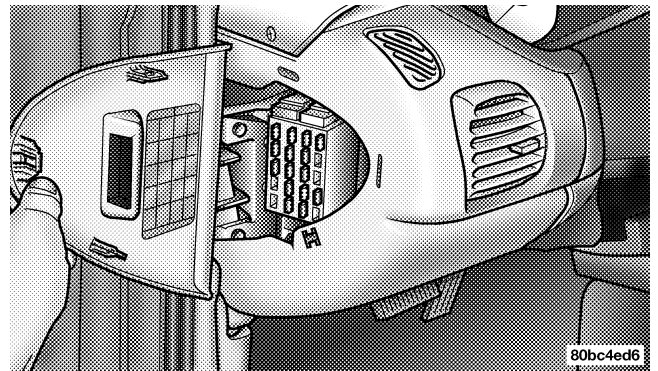

Interior Fuse Panel

FUSE	Amp/Color	Items Fused
1	10 Amp/Red	Power Mirror/ Multifunction
2	20 Amp/ Yellow	Wiper Switch/Motor
3	20 Amp/ Yellow	Radio/Power Sunroof
4	15 Amp/Lt. Blue	Interior Lighting

172 MAINTAINING YOUR VEHICLE

5	10 Amp/Red	Airbag Run Only
6	20 Amp/ Yellow	HVAC Blower
7	10 Amp/Red	Backup Switch/EBL/ Temp/Comp
8	15 Amp/Lt. Blue	High Headlamp
9	10 Amp/Red	Airbag Run-Start
10	15 Amp/Lt. Blue	ABS Engine Run Start
11	10 Amp/Red	ARKEM Run Start
12	10 Amp/Red	Ignition Off/Run/ Start
13	20 Amp/ Yellow	Power Seat Height Adjust
14	20 Amp/ Yellow	ARKEM Door Locks
15	15 Amp/Lt Blue	Exterior Lighting
16	25 Amp/ Natural	Headlamp

17	10 Amp/Red	Lt Low Beam Headlamp/ Headlamp Level Switch (Bux Only)
18	10 Amp/Red	Rt Low Beam Headlamp/ Headlamp Level Motor
19	10 Amp/Red	Fog lamps
20	Spare	

CAUTION!

When replacing a blown fuse, it is important to use only a fuse having the correct amperage rating. The use of a fuse with a rating other than indicated may result in a dangerous electrical system overload. If a properly rated fuse continues to blow, it shows a problem in the circuit that must be corrected.

VEHICLE STORAGE

If you will not be using your vehicle for more than 21 days you may want to take steps to preserve your battery. You may:

- Disengage the mini fuse in the Power Distribution Center labeled IOD (Ignition Off-Draw).
- Or, disconnect the negative cable from the battery.

REPLACEMENT BULBS

LIGHT BULBS — Inside

	Bulb No.
ABS Indicator	LED
Airbag Indicator	LED
Brake System Warning Indicator	LED
Climate Controls	LED
Console Gear Selector	PC194
Dome Light.	T579
Glove Box.	PC194
Front Fog Indicator	LED
High Beam Indicator	PC194
Instrument Cluster Illumination	PC194
Low Fuel Indicator.	LED

Low Oil Pressure Indicator	LED
Rear Cargo	T906
Seat Belt Indicator	LED
Security Alarm Indicator.	LED
Malfunction Indicator Light	LED
TRAC OFF Indicator	LED
Turn Signal Indicator	PC194
Voltage Indicator	LED

All the inside bulbs are brass or glass wedge base. Aluminum base bulbs are not approved and should not be used for replacement.

LIGHTS BULBS — Outside

	Bulb No.
Headlight	9007
Front Park/Turn Signal Light	3457AK
Front Side Marker Light.	168
Front Fog Light.	9145/H10
Center High Mounted Stop Light (CHMSL).	921-W16W
Rear Tail/Stop/Turn Signal Light	3157-P27/7W
Backup Light	921-W16W
License Light	168

BULB REPLACEMENT

Headlight Bulb Replacement

CAUTION!

Do not touch the new headlight bulb with your fingers. Oil contamination will severely shorten bulb life.

1. Remove the three upper fascia screws.

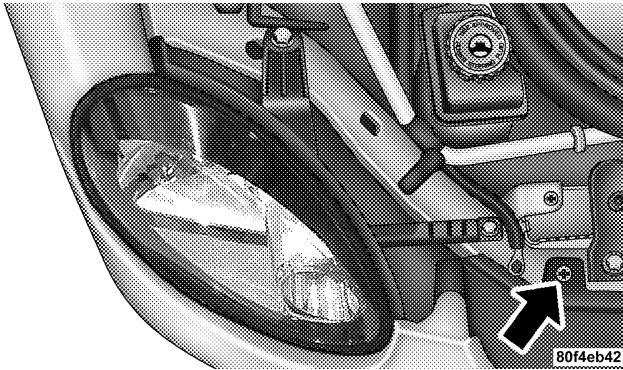

2. Remove two screws from the headlight assembly and remove the assembly from the vehicle.

NOTE: The headlight assembly is located to the fender by a molded pin. Pull the outboard side of the headlight straight out until the molded pin clears the fender, then slide the headlight out from behind the bumper fascia and grille.

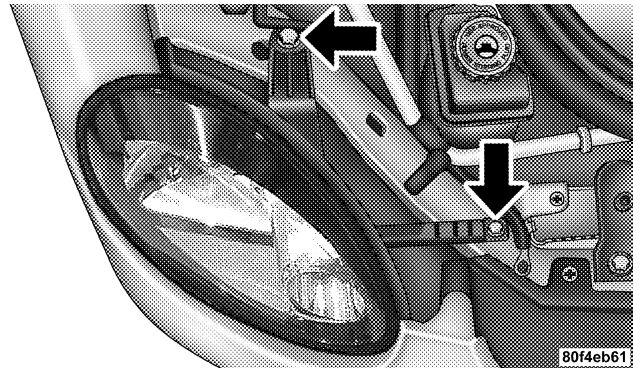

3. Disconnect the electrical connector.
4. Remove the retaining ring and replace the bulb.

CAUTION!

During installation, be sure when tightening the inboard screw, to only tighten until the rubber grommet on the screw starts to compress against the headlamp module housing.

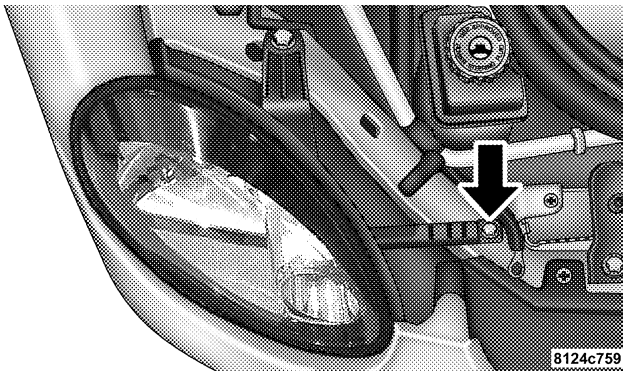
**Front Park/Turn Signal Lights**

1. Remove the headlight assembly
2. Twist the bulb socket 1/4 turn and remove.
3. Pull the bulb from the socket and replace.

Front Sidemarkers Light

1. Remove the screws and push-pins from the front fender splash shield.
2. Reach between the fender and the splash shield, grasp the bulb and socket assembly and turn it counterclockwise. Remove the bulb and socket assembly from the light housing.
3. Pull the bulb out of the socket and replace the bulb. Reinstall the bulb and socket assembly and replace the fender splash shield.

Tail/Stop, Rear Turn Signals and Back-up Lights

1. Open the trunk and move the trunk liner away from the rear light mounting area.
2. Twist the bulb socket 1/4 turn to remove it from the housing.
3. Pull bulb from socket and replace

Center High Mounted Stop Light

1. Twist the socket 1/4 turn and remove it from the housing.
2. Pull the bulb out of the socket and replace.

FLUIDS AND CAPACITIES

	U.S.	Metric
Fuel (Approximate) 91 Octane	12.5 Gallons	47.5 Liters
Engine Oil-With Filter		
2.4 Liter Turbo Charged Engines (5W-30, API Certified Engine Oils)	5.0 qts	4.7 Liters
Cooling System *		
2.4 Liter Turbo Charged Engines (Mopar® Antifreeze/Coolant 5 Year/100,000 Mile Formula)	8.1 qts	7.7 Liters

* Includes heater and coolant recovery bottle filled to MAX level.

RECOMMENDED FLUIDS, LUBRICANTS AND GENUINE PARTS

Engine

Component	Fluids, Lubricants and Genuine Parts
Engine Coolant	Mopar® Antifreeze/Coolant 5 Year/100,000 Mile Formula HOAT (Hybrid Organic Additive Technology)
Engine Oil	Use API Certified SAE 5W-30 Engine Oil. Refer to your engine oil filler cap for correct SAE grade meeting DaimlerChrysler Material Standard MS-6395.
Engine Oil Filter	Mopar 4781452AA or equiv.
Spark Plugs	Refer to the Vehicle Emission Control Information label in the engine compartment.
Fuel Selection	91 Octane.

Chassis

Component	Fluids, Lubricants and Genuine Parts.
Manual Transmission Fluid	Mopar® ATF+4 Automatic Transmission Fluid. Plus 4 oz. Mopar Limited Slip Additive Friction Modifier.
Brake Master Cylinder	Mopar® DOT 3 and SAE J1703 should be used. If DOT 3 brake fluid is not available, then DOT 4 or DOT 4+ is acceptable. Use only recommended brake fluids.
Power Steering Reservoir	Mopar® ATF+4 Automatic Transmission Fluid.

MAINTENANCE SCHEDULES

CONTENTS

■ Emission Control System Maintenance	180	□ Schedule "B"	183
■ Maintenance Schedule	180	□ Schedule "A"	190

EMISSION CONTROL SYSTEM MAINTENANCE

The “Scheduled” maintenance services, listed in **bold type** must be done at the times or mileages specified to assure the continued proper functioning of the emission control system. These, and all other maintenance services included in this manual, should be done to provide best vehicle performance and reliability. More frequent maintenance may be needed for vehicles in severe operating conditions such as dusty areas and very short trip driving.

Inspection and service also should be done any time a malfunction is suspected.

NOTE: Maintenance, replacement, or repair of the emission control devices and systems on your vehicle may be performed by any automotive repair establishment or individual using any automotive part which has been certified pursuant to U.S. EPA or, in the State of California, California Air Resources Board regulations.

MAINTENANCE SCHEDULE

There are three maintenance schedules that show **required** service for your vehicle.

First is Schedule “**B**”. It is for vehicles that are operated under the conditions that are listed below and at the beginning of the schedule.

- Day or night temperatures are below 32° F (0° C).
- Stop and go driving.
- Extensive engine idling.
- Driving in dusty conditions.
- Short trips of less than 10 miles (16 km).
- More than 50% of your driving is at sustained high speeds during hot weather, above 90° F (32° C).
- Trailer towing.
- Taxi, police, or delivery service (commercial service).
- Off-road or desert operation.
- **If equipped for and operating with E-85 (ethanol) fuel.**

NOTE: If **ANY** of these apply to you then change your engine oil every 3,000 miles (5 000 km) or 3 months, whichever comes first, and follow schedule "B" of the "Maintenance Schedules" section of this manual.

NOTE: IF **ANY** of these apply to you then flush and replace the engine coolant every 102,000 miles (163 000 km) or 60 months, whichever comes first, and follow schedule "B" of the "Maintenance Schedules" section of this manual.

NOTE: Most vehicles are operated under the conditions listed for Schedule "B".

Second is Schedule "A". It is for vehicles that are not operated under any of the conditions listed under Schedule "B"

Use the schedule that best describes your driving conditions. Where time and mileage are listed, follow the interval that occurs first.

CAUTION!

Failure to perform the required maintenance items may result in damage to the vehicle.

At Each Stop for Fuel

- Check the engine oil level about 5 minutes after a fully warmed engine is shut off. Checking the oil level while the vehicle is on level ground will improve the accuracy of the oil level reading. Add oil only when the level is at or below the ADD or MIN mark.
- Check the windshield washer solvent and add if required.

182 MAINTENANCE SCHEDULES

Once a Month

- Check tire pressure and look for unusual wear or damage.
- Inspect the battery and clean and tighten the terminals as required.
- Check the fluid levels of coolant reservoir, brake master cylinder and transaxle and add as needed.
- Check all lights and all other electrical items for correct operation.
- Check rubber seals on each side of the radiator for proper fit.

At Each Oil Change

- Change the engine oil filter.
- Inspect the exhaust system.
- Inspect the brake hoses.
- Inspect the CV joints and front suspension components.
- Check the manual transaxle fluid level and fill plug condition.
- Check the coolant level, hoses, and clamps.

SCHEDULE "B"

Follow schedule "B" If you usually operate your vehicle under one or more of the following conditions.

- Day or night temperatures are below 32° F (0° C).
- Stop and go driving.
- Extensive engine idling.
- Driving in dusty conditions.
- Short trips of less than 10 miles (16.2 km).
- More than 50% of your driving is at sustained high speeds during hot weather, above 90° F (32° C).
- Trailer towing.
- Taxi, police, or delivery service (commercial service).
- Off-road or desert operation.

- If equipped for and operating with E-85 (ethanol) fuel.

NOTE: If ANY of these apply to you then change your engine oil every 3,000 miles (5 000 km) or 3 months, whichever comes first, and follow schedule "B" of the "Maintenance Schedules" section of this manual.

NOTE: IF ANY of these apply to you then flush and replace the engine coolant every 102,000 miles (163 000 km) or 60 months, whichever comes first, and follow schedule "B" of the "Maintenance Schedules" section of this manual.

If none of these apply to you, then change your engine oil at every interval shown on schedule "A" of the "Maintenance Schedules" section of this manual.

184 SCHEDULE "B"

Miles (Kilometers)	3,000 (5 000)	6,000 (10 000)	9,000 (14 000)	12,000 (19 000)	15,000 (24 000)	18,000 (29 000)
Change engine oil and engine oil filter, if not replaced at 3 months.	X	X	X	X	X	X
Rotate tires.		X		X		X
Inspect the brake linings.				X		
Inspect the engine air cleaner filter . Replace as necessary.*					X	
Inspect and replace, if required, the make-up air filter (located inside the air cleaner).					X	
Replace manual transaxle fluid.						X

Miles (Kilometers)	21,000 (34 000)	24,000 (38 000)	27,000 (43 000)	30,000 (48 000)	33,000 (53 000)	36,000 (58 000)
Change engine oil and engine oil filter, if not replaced at 3 months.	X	X	X	X	X	X
Rotate tires.		X		X		X
Inspect the brake linings.		X				X
Replace the engine air cleaner filter .				X		
Replace the spark plugs .				X		
Inspect the tie rod ends and boot seals.				X		
Inspect the PCV valve and replace as necessary.*				X		
Replace the make-up air filter (located inside the air cleaner).				X		
Adjust the generator drive belt tension.				X		
Replace manual transaxle fluid.						X

186 SCHEDULE "B"

Miles (Kilometers)	39,000 (62 000)	42,000 (67 000)	45,000 (72 000)	48,000 (77 000)	51,000 (82 000)	54,000 (86 000)
Change engine oil and engine oil filter, if not replaced at 3 months.	X	X	X	X	X	X
Rotate tires.		X		X		X
Inspect the brake linings.				X		
Change the brake fluid. If vehicle is used for trailer towing.				X		
Inspect the engine air cleaner filter . Replace as necessary.*			X			
Change the manual transaxle fluid.						X
Inspect and replace, if required, the the make-up air filter (located inside the air cleaner).			X			

Miles (Kilometers)	57,000 (91 000)	60,000 (96 000)	63,000 (101 000)	66,000 (106 000)	69,000 (110 000)	72,000 (115 000)
Change engine oil and engine oil filter, if not replaced at 3 months.	X	X	X	X	X	X
Rotate tires.		X		X		X
Inspect the brake linings.		X				X
Replace the engine air cleaner filter .		X				
Replace the spark plugs and ignition cables .		X				
Inspect the tie rod ends and boot seals.		X				
Inspect the PCV valve and replace if necessary. Not required if previously changed. * ‡		X				
Replace the make-up air filter (located inside the air cleaner).		X				
Adjust the generator drive belt tension.		X				
Replace manual transaxle fluid.						X
Flush and replace engine coolant at 60 months, if not done at 102,000 miles.		X				

188 SCHEDULE "B"

Miles (Kilometers)	75,000 (120 000)	78,000 (125 000)	81,000 (130 000)	84,000 (134 000)	87,000 (139 000)	90,000 (144 000)
Change engine oil and engine oil filter, if not replaced at 3 months.	X	X	X	X	X	X
Rotate tires.		X		X		X
Inspect the brake linings.				X		
Inspect the engine air cleaner filter and replace as necessary.*	X					
Replace the engine air cleaner filter .						X
Replace the spark plugs .						X
Inspect the tie rod ends and boot seals.						X
Inspect the PCV valve and replace if necessary. Not required if previously changed. * ‡						X
Replace the engine timing belt . *						X
Inspect and replace, if required, the make-up air filter (located inside the air cleaner).	X					
Adjust the generator drive belt tension.						X
Replace manual transaxle fluid.						X
Replace the make-up air filter (located inside the air cleaner).						X

Miles (Kilometers)	93,000 (149 000)	96,000 (154 000)	99,000 (158 000)	102,000 (163 000)	105,000 (168 000)
Change engine oil and engine oil filter, if not replaced at 3 months.	X	X	X	X	X
Rotate tires.		X		X	
Inspect the brake linings.		X			
Change the brake fluid. If vehicle is used for trailer towing.		X			
Inspect the engine air cleaner filter and replace as necessary.*					X
Flush and replace the engine, if not done at 60 months.				X	
Inspect and replace, if required, the make-up air filter (located inside the air cleaner).					X

* This maintenance is recommended by the manufacturer to the owner but is not required to maintain the emissions warranty.

Inspection and service should also be performed anytime a malfunction is observed or suspected. Retain all receipts.

‡ This maintenance is not required if previously replaced.

190 SCHEDULE "A"

SCHEDULE "A"

Miles (Kilometers) [Months]	5,000 (8 000) [6]	10,000 (16 000) [12]	15,000 (24 000) [18]	20,000 (32 000) [24]	25,000 (40 000) [30]	30,000 (48 000) [36]
Change engine oil and engine oil filter.	X	X	X	X	X	X
Rotate tires.	X	X	X	X	X	X
Inspect the brake linings.				X		
Replace the engine air cleaner filter .						X
Replace the spark plugs .						X
Inspect the tie rod ends and boot seals.						X
Replace the make-up air filter (located inside the air cleaner).						X
Adjust the generator drive belt tension.						X
Replace manual transaxle fluid.						X

Miles (Kilometers)	35,000 (56 000)	40,000 (64 000)	45,000 (72 000)	50,000 (80 000)	55,000 (88 000)
[Months]	[42]	[48]	[54]	[60]	[66]
Change engine oil and engine oil filter.	X	X	X	X	X
Rotate tires.	X	X	X	X	X
Inspect the brake linings.		X			
Flush and replace the engine coolant at 60 months, if not done at 100,000 miles.				X	

192 SCHEDULE "A"

Miles (Kilometers)	60,000 (96 000)	65,000 (104 000)	70,000 (112 000)	75,000 (120 000)	80,000 (128 000)	85,000 (136 000)
[Months]	[72]	[78]	[84]	[90]	[96]	[102]
Change engine oil and engine oil filter.	X	X	X	X	X	X
Rotate tires.	X	X	X	X	X	X
Inspect the brake linings.	X				X	
Replace the engine air cleaner filter .	X					
Replace the spark plugs and ignition cables .	X					
Inspect the tie rod ends and boot seals.	X					
Inspect the PCV valve and replace if necessary. Not required if previously changed. * ‡	X					
Replace the make-up air filter (located inside the air cleaner).	X					
Adjust the generator drive belt tension.	X					
Replace manual transaxle fluid.	X					

Miles (Kilometers) [Months]	90,000 (144 000) [108]	95,000 (156 000) [114]	100,000 (160 000) [120]	105,000 (168 000) [126]
Change engine oil and engine oil filter.	X	X	X	X
Rotate tires.	X	X	X	X
Inspect the brake linings.			X	
Replace the engine air cleaner filter .	X			
Replace the spark plugs .	X			
Adjust the generator drive belt tension.	X			
Inspect the tie rod ends and boot seals.	X			
Inspect the PCV valve and replace if necessary. Not required if previously changed. * ‡	X			
Flush and replace the engine coolant, if not done at 60 months.			X	
Replace the make-up air filter (located inside the air cleaner).	X			
Replace the engine timing belt .				X
Replace manual transaxle fluid.	X			

* This maintenance is recommended by the manufacturer to the owner but is not required to maintain the emissions warranty.

‡ This maintenance is not required if previously replaced.

Inspection and service should also be performed anytime a malfunction is observed or suspected. Retain all receipts.

WARNING!

You can be badly injured working on or around a motor vehicle. Do only that service work for which you have the knowledge and the right equipment. If you have any doubt about your ability to perform a service job, take your vehicle to a competent mechanic.

IF YOU NEED CONSUMER ASSISTANCE

CONTENTS

■ Suggestions For Obtaining Service For Your Vehicle	196	■ Reporting Safety Defects	200
□ Prepare For The Appointment	196	□ In Canada	200
□ Prepare A List	196	■ Publication Order Forms	200
□ Be Reasonable With Requests	196	■ Department Of Transportation Uniform Tire Quality Grades	201
■ If You Need Assistance	196	□ Treadwear	202
■ Warranty Information	198	□ Traction Grades	202
■ Mopar® Parts	200	□ Temperature Grades	202

SUGGESTIONS FOR OBTAINING SERVICE FOR YOUR VEHICLE**Prepare For The Appointment**

If you're having warranty work done, be sure to have the right papers with you. Take your warranty folder. All work to be performed may not be covered by the warranty, discuss additional charges with the service manager. Keep a maintenance log of your vehicle's service history. This can often provide a clue to the current problem.

Prepare A List

Make a written list of your vehicle's problems or the specific work you want done. If you've had an accident, or work done that is not on your maintenance log, let the service advisor know.

Be Reasonable With Requests

If you list a number of items, and you must have your vehicle by the end of the day, discuss the situation with the service advisor and list the items in order of priority. At many dealers you may obtain a rental vehicle at a

minimal daily charge. If you need a rental, it is advisable to make these arrangements when you call for an appointment.

IF YOU NEED ASSISTANCE

The manufacturer and its dealers are vitally interested in your satisfaction. We want you to be happy with our products and services.

Warranty service must be done by an authorized Chrysler, Dodge, or Jeep dealer. We strongly recommend that you take your vehicle to your selling dealer. They know you and your vehicle best, and are most concerned that you get prompt and high quality service. The manufacturer's dealers have the facilities, factory-trained technicians, special tools, and the latest information to assure your vehicle is fixed correctly and in a timely manner.

This is why you should always talk to your dealer's service manager first. Most matters can be resolved with this process.

- If for some reason you are still not satisfied, talk to the general manager or owner of the dealership. They want to know if you need assistance.
- If your dealership is unable to resolve the concern, you may contact the Manufacturer's Customer Center.

Any communication to the Manufacturer's Customer Center should include the following information:

- Owner's name and address
- Owner's telephone number (home and office)
- Dealership name
- Vehicle identification number
- Vehicle delivery date and mileage

DaimlerChrysler Motors Corporation Customer Center

P.O. Box 21-8004
Auburn Hills, MI 48321-8004
Phone: (800) 992-1997

DaimlerChrysler Canada Inc. Customer Center

P.O. Box 1621
Windsor, Ontario N9A 4H6
Phone —(800) 465-2001

In Mexico contact:

Av. Prolongacion Paseo de la Reforma, 1240
Sante Fe C.P. 05109
Mexico, D. F.
In Mexico (915) 729-1248 or 729-1240
Outside Mexico (525) 729-1248 or 729-1240

Customer Assistance For The Hearing Or Speech Impaired (TDD/TTY)

To assist customers who have hearing difficulties, the manufacturer has installed special TDD (Telecommunication Devices for the Deaf) equipment at its Customer Center. Any hearing or speech impaired customer who has access to a TDD or a conventional teletypewriter (TTY) in the United States can communicate with the manufacturer by dialing 1-800-380-CHRY.

Service Contract

You may have purchased a service contract for your vehicle to help protect you from the high cost of unexpected repairs after your manufacturer's new vehicle limited warranty expires. The manufacturer stands behind only the manufacturer's Service Contracts. If you purchased a manufacturer's Service Contract, you will receive Plan Provisions and an Owner Identification Card in the mail within three weeks of your vehicle delivery date. If you have any questions about your service contract, call the manufacturer's Service Contract National Customer Hotline at 1-800-521-9922.

The manufacturer will not stand behind any service contract that is not the manufacturer's Service Contract. It is not responsible for any service contract other than the manufacturer's Service Contract. If you purchased a service contract that is not a manufacturer's Service Contract, and you require service after your manufacturer's new vehicle limited warranty expires, please refer to your contract documents, and contact the person listed in those documents.

We appreciate that you have made a major investment when you purchased your new vehicle. Your dealer has also made a major investment in facilities, tools, and training to assure that you are absolutely delighted with your ownership experience. You'll be pleased with their sincere efforts to resolve any warranty issues or related concerns.

WARRANTY INFORMATION

See your manufacturer's Warranty Information Booklet for information on warranty coverage and transfer of warranty.

DESCRIPTION	1 Yr/ 12,000	2 Yr/ 24,000	3 Yr/ 36,000	3 Yr/ 50,000	3 Yr/ Unlmtd	5 Yr/ 100,000	7 Yr/ 70,000	8 Yr/ 80,000
Basic Limited Warranty Coverage								
Special Extended Warranty Coverage								
Anti-Corrosion Perforation Limited Warranty: All Panels								
Federal Emission Warranty								
Federal Emission Warranty – Specified Components								
California Emission Warranty								
California Emission Warranty – Specified Components								

NOTE: Vehicles used as a police vehicle, taxi, limousine, postal delivery vehicles, ambulance or rental vehicles are covered only under the 3 year/36,000 mile Basic Limited Warranty.

MOPAR® PARTS

Mopar® fluids, lubricants, parts, and accessories are available from your dealer. They will help you keep your vehicle operating at its best.

REPORTING SAFETY DEFECTS

In the 50 United States and Washington D.C.: If you believe that your vehicle has a defect which could cause a crash or cause injury or death, you should immediately inform the National Highway Traffic Safety Administration (NHTSA) in addition to notifying the manufacturer.

If NHTSA receives similar complaints, it may open an investigation, and if it finds that a safety defect exists in a group of vehicles, it may order a recall and remedy campaign. However, NHTSA cannot become involved in individual problems between you, your dealer, and the manufacturer.

To contact NHTSA, you may either call the Auto Safety Hotline toll free at 1-800-424-9393 (or 366-0123 in Washington DC area) or write to: NHTSA, U.S. Dept. of

Transportation, Washington DC 20590. You can also obtain other information about motor vehicle safety from the Hotline.

In Canada:

If you believe that your vehicle has a safety defect, you should contact the Customer Service Department immediately. Canadian customers who wish to report a safety defect to the Canadian government should write to Transport Canada, Motor Vehicle Defect Investigations and Recalls, 2780 Sheffield Road, Ottawa, Ontario K1B 3V9.

PUBLICATION ORDER FORMS

To order the following manuals, you may use either the website or the phone numbers listed below. Visa, Mastercard, American Express, and Discover orders are accepted. If you prefer mailing your payment, please call for an order form.

NOTE: A street address is required when ordering manuals. (No P.O. Boxes).

- *Service Manuals.*

These comprehensive service manuals provide the information that students and professional technicians need in diagnosing/troubleshooting, problem solving, maintaining, servicing and repairing DaimlerChrysler Corporation vehicles. A complete working knowledge of the vehicle, system and/or components is written in straightforward language with illustrations, diagrams and charts.

- *Diagnostic Procedure Manuals.*

Filled with diagrams, charts and detailed illustrations, these practical manuals make it easy for students and technicians to find and fix problems on computer-controlled vehicle systems and features. They show exactly how to find and correct problems the first time, using step-by-step troubleshooting and driveability procedures, proven diagnostic tests and a complete list of all tools and equipment.

- *Owner's Manuals.*

These manuals have been prepared with the assistance of service and engineering specialists to acquaint you with specific Chrysler group vehicles. Included are

starting, operating, emergency and maintenance procedures as well as specifications, capabilities and safety tips.

Call Toll Free at 1-800-890-4038 (U.S.) or 1-800-387-1143 (Canada)

Or

Visit us on the World Wide Web at:

www.techauthority.daimlerchrysler.com or
www.daimlerchrysler.ca/manuals

DEPARTMENT OF TRANSPORTATION UNIFORM TIRE QUALITY GRADES

The following describes the tire grading categories established by the National Highway Traffic Safety Administration. The specific grade rating assigned by the tire's manufacturer in each category is shown on the sidewall of the tires on your car.

All Passenger Car Tires Must Conform to Federal Safety Requirements in Addition to These Grades.

Treadwear

The treadwear grade is a comparative rating based on the wear rate of the tire when tested under controlled conditions on a specified government test course. For example, a tire graded 150 would wear one and a half (1 1/2) times as well on the government course as a tire graded 100. The relative performance of tires depends upon the actual conditions of their use, however, and may depart significantly from the norm due to variations in driving habits, service practices and differences in road characteristics and climate.

Traction Grades

The traction grades, from highest to lowest, are A, B, and C, and they represent the tire's ability to stop on wet pavement as measured under controlled conditions on specified government test surfaces of asphalt and concrete. A tire marked C may have poor traction performance.

WARNING!

The traction grade is based on braking (straight-ahead) traction tests and does not include cornering (turning) performance.

Temperature Grades

The temperature grades are A (highest), B, and C, representing the tire's resistance to the generation of heat and its ability to dissipate heat when tested under controlled conditions on a specified indoor laboratory test wheel. Sustained high temperature can cause the material of the tire to degenerate and reduce tire life, and excessive temperature can lead to sudden tire failure. The grade C corresponds to a level of performance which all passenger car tires must meet under the Federal Motor Vehicle Safety Standard No. 109. Grades B and A represent higher levels of performance on the laboratory test wheel than the minimum required by law.

WARNING!

The temperature grade is established for a tire that is properly inflated and not overloaded. Excessive speed, underinflation, or excessive loading, either separately or in combination, can cause heat buildup and possible tire failure.

INDEX

- ABS (Anti-Lock Brake) System 102
- Adding Engine Coolant (Antifreeze) 159
- Adding Fuel 124
- Air Cleaner, Engine (Engine Air Cleaner Filter) . 151
- Air Conditioner Maintenance 153
- Air Conditioning 84
- Air Conditioning Controls 84
- Air Conditioning Refrigerant 153,154
- Air Conditioning System 153
- Air Pressure, Tires 113
- Airbag 30
- Airbag Deployment 35
- Airbag Light 38,46,71
- Airbag Maintenance 37
- Airbag, Side 36
- Alarm, Panic 19
- Alarm System 21,71
- Alignment and Balance 118
- Alterations/Modifications, Vehicle 6
- Antenna, Satellite Radio 83
- Antifreeze (Engine Coolant) 158,176,177
- Capacities 176
- Anti-Lock Brake System (ABS) 102
- Anti-Lock Warning Light 69
- Anti-Theft Security Alarm 21
- Appearance Care 165
- Arming Theft System 21
- Ashtrays and Lighter 63
- Automatic Door Locks 15
- Ball Joints 154
- Battery 152
- Keyless Transmitter Replacement 20
- Belts, Drive 149
- Belts, Engine 150
- Body Mechanism Lubrication 155
- B-Pillar Location 108
- Brake Fluid 177
- Brake, Parking 100
- Brake System 102,162
- Anti-Lock 102
- Hoses 162
- Master Cylinder 163
- Parking 100
- Warning Light 69
- Brakes 102,162

- Break-In Recommendations, New Vehicle 45
- Bulb Replacement 173,174
- Capacities, Antifreeze (Engine Coolant) 176
- Capacities, Fluid 176
- Caps, Filler
 - Fuel 124
 - Oil (Engine) 148
- Carbon Monoxide Warning 123
- Catalytic Converter 149
- CD Changer 79
- CD Player 75,77
- CD Player Maintenance 83
- Center High Mounted Stop Light 176
- Central Door Locks 14
- Central Locking 14
- Chains, Tire 119
- Changing A Flat Tire 130
- Charging System Light 71
- Chart, Tire Sizing 105
- Child Restraint 38
- Child Safety Locks 16
- Circuit Breakers 170,171
- Cleaning
 - Glass 168
 - Headlights 168
- Climate Control 84
- Clock 74
- Compact Disc Maintenance 83
- Compact Spare Tire 115
- Console 62
- Contract, Service 198
- Cool Down, Turbo 97
- Coolant 176,177
- Cooling System 157
 - Adding Coolant (Antifreeze) 159
 - Coolant Level 157,160
 - Disposal of Used Coolant 159
 - Drain, Flush, and Refill 158
 - Inspection 160
 - Points to Remember 159,161
 - Pressure Cap 159
 - Rubber and Plastic Components 161
 - Selection of Coolant 158
- Corrosion Protection 165
- Crankcase Emission Control System 151

- Cup Holder 62
- Customer Assistance 196
- Daytime Running Lights 57
- Dealer Service 144
- Defroster, Rear Window 90
- Defroster, Windshield 46,86
- Deploying, Airbag 35
- Diagnostic System, Onboard 142
- Dimmer Control 55
- Dimmer Switch, Headlight 57
- Disarming, Theft System 22
- Disposal
- Engine Oil 148
- Door Locks 13
- Door Locks, Automatic 15
- Downshifting 100
- Drive Belts 149
- Driving
- On Slippery Surfaces 136
- Electric Remote Mirrors 50
- Emergency, In Case of
- Jacking 130
 - Jump Starting 133
 - Towing 138
- Emergency Trunk Release 17
- Emission Control System Maintenance 180
- Engine 141
- Break-In Recommendations 45
 - Checking Oil Level 145
 - Compartment 141
 - Cooling 157
 - Exhaust Gas Caution 123
 - Jump Starting 133
 - Oil 145,176,177
 - Oil Change Interval 146
 - Oil Filler Cap 148
 - Oil Filter 177
 - Oil Selection 147
 - Oil Synthetic 148
 - Overheating 128
 - Temperature Gauge 73
 - Timing Belt 150
- Exhaust Gas Caution 45,123

Exhaust Pipes	156	Capacity	176
Exhaust System	156	Filler Cap	124
Extender, Seat Belt	30	Filter	151
Filters		Gauge	71
Air Cleaner	151	Light	71
Engine Fuel	151	Octane Rating	121
Engine Oil	149,177	Tank Capacity	176
Flashers		Fuel System Caution	123
Hazard Warning	128	Fuses	170
Flooded Engine Starting	96	Gas Cap	124
Fluid, Brake	177	Gasoline	176
Fluid Capacities	176	Gasoline, Reformulated	121
Fluid Leaks	46	Gasoline/Oxygenate Blends	122
Fluid Level Checks		Gauges	
Manual Transaxle	164	Coolant Temperature	73
Fluids	177	Fuel	71
Fog Lights	57,69	Tachometer	70
Folding Rear Seat	52	Turbo Boost	91,121
Freeing A Stuck Vehicle	137	General Information	12
Front Suspension Ball Joints	154	Glass Cleaning	168
Fuel	121,177	Hazard Warning Flasher	128
Adding	124		

- Headlights 56
 Bulb Replacement 174
 Cleaning 168
 High Beam 70
 Switch 56
Hood Prop 54
Hood Release 53
Hoses 161
- Ignition
 Key 9
 Wiring System 151
Immobilizer 10,21
Infant Restraint 38
Inside Rearview Mirror 49
Instrument Cluster 68,69
Instrument Panel and Controls 67
Instrument Panel Cover 168
Instrument Panel Lens Cleaning 169
Interior Appearance Care 167
Interior Fuses 171
Interior Lights 55
Intermittent Wipers 59
- Introduction 4
- Jack Operation 130
Jacking Instructions 130
Jump Starting 133
- Key, Programming 12
Key Release Button 9
Key, Replacement 11
Key, Sentry 10
Key-In Reminder 10
Keyless Entry System 18
Keys 9
- Lane Change and Turn Signals 70
Lap/Shoulder Belts 23
Lead Free Gasoline 121
Leaks, Fluid 46
Light Bulbs 173,174
Lighter, Cigar 63
Lights 54
 Airbag 38,46,71
 Anti-Lock 69

Brake Warning	69	Turn Signal	57,70,175
Center Mounted Stop	176	Voltage	71
Daytime Running	57	Warning (Instrument Cluster Description)	69
Dimmer Switch, Headlight	56,57	Loading Vehicle	125
Dome	55	Tires	108
Exterior Check	46	Locks	13
Fog	57	Child Protection	16
Headlights On Reminder	57	Door	13
High Beam Indicator	70	Ignition	143
Instrument Cluster	56	Power Door	14
Interior	55	Steering Wheel	13
Lights On Reminder	57	Lubrication, Body	155
Malfunction Indicator	72	Maintenance	145
Map Reading	54	Maintenance, Airbag	37
Oil Pressure	70	Maintenance Free Battery	152
Park	56	Maintenance Procedures	145
Passing	57	Maintenance Schedule	
Rear Servicing	176	Schedule "A"	190
Rear Tail	176	Schedule "B"	183
Seat Belt Reminder	71	Maintenance Schedules	180
Security Alarm	21	Maintenance, Sunroof	61
Side Marker	175	Malfunction Indicator Light	72,143
Theft Alarm	71		

- Manual, Service 200
- Manual Transaxle 95,98,164
- Fluid Level Check 164
- Frequency of Fluid Change 164
- Lubricant Selection 164
- Map/Reading Lights 54
- Master Cylinder 163
- Mirrors 49
- Electric Remote 50
- Outside 49
- Rearview 49
- Modifications/Alterations, Vehicle 6
- Mopar Parts 144,200
- Multi-Function Control Lever 56,57
- Occupant Restraints 23
- Odometer
- Trip 72
- Oil, Engine 145,176
- Capacity 176
- Change Interval 146
- Checking 145
- Disposal 148
- Filter 149
- Identification Logo 148
- Materials Added to 148
- Quality 148
- Recommendation 147,176
- Synthetic 148
- Viscosity 148
- Oil Pressure Light 70
- Onboard Diagnostic System 142,143
- Operator Manuals (Owner's Manuals) 4
- Outside Air Intake 89
- Overheating, Engine 128
- Owner's Manual 4,200
- Paint Care 165
- Panic Alarm 19
- Parking Brake 100
- Passing Light 57
- Pets 44
- Placard, Tire and Loading Information 108
- Power
- Door Locks 14
- Steering 103,154

Steering, Checking	154	Replacement Parts	144
Sunroof	60	Replacement Tires	117
Windows	22	Reporting Safety Defects	200
Power Steering Fluid	177	Rotation, Tires	120
Pregnant Women and Seat Belts	29	Safety Checks Inside Vehicle	46
Preparation for Jacking	130	Safety Checks Outside Vehicle	46
Programming Transmitters	19	Safety Defects, Reporting	200
Radial Ply Tires	115	Safety Information, Tire	104
Radio Broadcast Signals	74	Safety Tips	45
Radio Operation	75	Satellite Radio	80
Radio, Satellite	80	Satellite Radio Antenna	83
Radio (Sound Systems)	74,75	Schedule, Maintenance	180
Rear Window Defroster	90	Seat Belts	23
Reclining Front Seats	51	Adjustable Upper Shoulder Anchorage	27
Recommended Fluids, Lubricants and Genuine Parts	177	And Pregnant Women	29
Reformulated Gasoline	121	Child Restraint	38
Refrigerant	154	Extender	30
Remote Keyless Entry	18	Front Seat	23
Remote Trunk Release	17	Maintenance	169
Replacement Bulbs	173	Rear Seat	23
Replacement Keys	11	Untwisting Procedure	28
		Seats	50

Adjustment	50	Starting Procedures	95
Rear Folding	52	Steering	
Reclining	51	Power	103
Security Alarm (Theft Alarm)	21,71	Tilt Column	59
Sentry Key	10,21	Wheel Lock	13
Sentry Key Programming	12	Storage, Vehicle	173
Service Assistance	196	Sun Roof	60
Service Contract	198	Sunroof Maintenance	61
Service Manuals	200	Supplemental Restraint System - Airbag	30
Setting the Clock	74	Synthetic Engine Oil	148
Shift Speeds	99	Tachometer	70
Shift Speeds, Manual Transaxle	99	Temperature Gauge, Engine Coolant	73,129
Shoulder Belt Upper Anchorage	27	Theft Alarm	21
Side Airbag	36	Theft System	21
Side Window Demisters	89	Theft System Arming	21
Slippery Surfaces, Driving On	136	Theft System Disarming	22
Snow Chains (Tire Chains)	119	Tilt Steering Column	59
Snow Tires	119	Tire and Loading Information Placard	108
Spark Plugs	149	Tire Identification Number (TIN)	107
Speedometer	70	Tire Markings	104
Speedometer and Odometer	68	Tire Safety Information	104
Starting	95	Tires	46,112,201
Engine Fails to Start	96		

Alignment	118	Transporting Pets	44
Chains	119	Tread Wear Indicators	117
Changing	130	Trip Odometer Reset Button	72
Compact Spare	115	Trunk Release Button	17
General Information	112	Trunk Release, Emergency	17
High Speed	114	Trunk Release Remote Control	17
Inflation Pressures	113	Turbo Boost Gauge	91,121
Jacking	130	Turbo Cool Down	97
Load Capacity	108,109	Turn Signals	57,70
Quality Grading	201	Underhood Fuses	170
Radial	115	Uniform Tire Quality Grades	201
Replacement	117	Untwisting Procedure, Seat Belt	28
Rotation	120	Vacuum/Vapor Harnesses	161
Safety	112	Vehicle Identification Number	6
Sizes	105	Vehicle Loading	125
Snow Tires	119	Vehicle Modifications/Alterations	6
Spinning	116	Vehicle Storage	173
Tread Wear Indicators	117	Warning Lights (Instrument Cluster Description)	69
Towing		Warnings and Cautions	6
Disabled Vehicle	138	Warranty Information	198
Transaxle			
Manual	95,98		
Transmitter Battery Service	20		

Washer, Adding Fluid	156
Washers, Windshield	58
Washing Vehicle	165
Wheel Alignment and Balance	118
Wheel and Wheel Trim Care	166
Wind Buffeting	62
Window Fogging	89
Windows	
Power	22
Windshield Washer Aiming	156
Windshield Washers	58
Fluid	156
Windshield Wiper Blades	155
Windshield Wipers	58
Wiper Blade Replacement	156
Wipers, Intermittent	59
Wiring, Ignition	151

