

TABLE OF CONTENTS

SECTION		PAGE
1	INTRODUCTION	3
2	THINGS TO KNOW BEFORE STARTING YOUR VEHICLE	7
3	UNDERSTANDING THE FEATURES OF YOUR VEHICLE	65
4	INSTRUMENT PANEL AND CONTROLS	141
5	STARTING AND OPERATING	197
6	WHAT TO DO IN EMERGENCIES	269
7	MAINTAINING YOUR VEHICLE	283
8	MAINTENANCE SCHEDULES	339
9	IF YOU NEED CONSUMER ASSISTANCE	359
10	INDEX	369

INTRODUCTION

CONTENTS

■ Introduction	4	■ Vehicle Identification Number	5
■ How To Use This Manual	4	■ Vehicle Modifications / Alterations	6
■ Warnings And Cautions	5		

INTRODUCTION

This manual has been prepared with the assistance of service and engineering specialists to acquaint you with the operation and maintenance of your new vehicle. It is supplemented by a Warranty Information Booklet and various customer oriented documents. You are urged to read these publications carefully. Following the instructions and recommendations in this manual will help assure safe and enjoyable operation of your vehicle.

NOTE: After you read the manual, it should be stored in the vehicle for convenient reference and remain with the vehicle when sold, so that the new owner will be aware of all safety warnings.

When it comes to service, remember that your dealer knows your vehicle best, has the factory-trained technicians and genuine Mopar® parts, and is interested in your satisfaction.

WARNING!

Engine exhaust, some of its constituents, and certain vehicle components contain or emit chemicals known to the State of California to cause cancer and birth defects or other reproductive harm. In addition, certain fluids contained in vehicles and certain products of component wear contain or emit chemicals known to the State of California to cause cancer and birth defects or other reproductive harm.

HOW TO USE THIS MANUAL

Consult the table of contents to determine which section contains the information you desire.

The detailed index, at the rear of this manual, contains a complete listing of all subjects.

WARNINGS AND CAUTIONS

This manual contains **WARNINGS** against operating procedures which could result in an accident or bodily injury. It also contains **CAUTIONS** against procedures which could result in damage to your vehicle. If you do not read this entire manual you may miss important information. Observe all Warnings and Cautions.

VEHICLE IDENTIFICATION NUMBER

The vehicle identification number (VIN) is found on a stamped plate located on the left front corner of the instrument panel pad, visible from outside of the vehicle through the windshield. This number also appears on the Automobile Information Disclosure Label affixed to a window on your vehicle. Save this label for a convenient record of your vehicle identification number and optional equipment.

NOTE: It is illegal to remove the VIN plate.

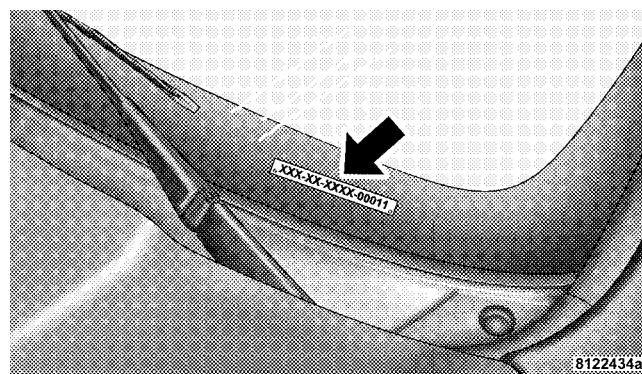

VEHICLE MODIFICATIONS / ALTERATIONS

WARNING!

Any modifications or alterations to this vehicle could seriously affect its roadworthiness and safety and may lead to an accident resulting in serious injury or death.

THINGS TO KNOW BEFORE STARTING YOUR VEHICLE

CONTENTS

■ A Word About Your Keys	9	□ Power Door Locks	14
□ Key-In-Ignition Reminder	9	□ Child Protection Door Lock	17
□ Sentry Key — If Equipped	9	■ Remote Keyless Entry	19
■ Ignition And Steering Lock	12	□ To Unlock The Doors And Liftgate	19
□ Ignition Accessory Delay Feature	13	□ To Lock The Doors And Liftgate	20
■ Illuminated Entry	13	□ Using The Panic Alarm	21
□ Vehicles Equipped With Power Door Locks	13	□ General Information	22
■ Door Locks	13	□ Programming Additional Transmitters	22
□ Manual Door Locks	13	□ Battery Replacement	24

8 THINGS TO KNOW BEFORE STARTING YOUR VEHICLE

■ Security Alarm System — If Equipped24	□ Enhanced Driver Seat Belt Reminder System (BeltAlert)35
□ To Set The Alarm25	□ Seat Belts And Pregnant Women37
□ To Disarm The System25	□ Seat Belt Extender37
■ Liftgate26	□ Driver And Right Front Passenger Supplemental Restraint System (SRS)—Airbags38
■ Windows27	□ Child Restraint50
□ Power Windows27	■ Engine Break-In Recommendations62
□ Auto Down28	■ Safety Tips62
□ Window Lockout Switch28	□ Exhaust System62
■ Occupant Restraints28	□ Safety Checks You Should Make Inside The Vehicle63
□ Lap/Shoulder Belts29	□ Safety Checks You Should Make Outside The Vehicle64
□ Adjustable Upper Shoulder Belt Anchorage34		
□ Second Row Center Seat Belt34		
□ Seat Belt Pretensioners35		

A WORD ABOUT YOUR KEYS

The double sided keys may be inserted into the locks with either side up. The keys for your new vehicle are enclosed in a plastic bag with a bar code label affixed to the front. The bar code can be used to order duplicate keys from your dealer or a locksmith. If you received your keys without the bag, ask your dealer to give you the number.

NOTE: Integrated keys (key and key fob combined) must be cut by the dealer. The dealer must have cutters that have enough clearance for integrated keys.

Key-In-Ignition Reminder

If you open the driver's door when the key is in the ignition lock, a continuous chime will sound to remind you to remove the key.

CAUTION!

An unlocked vehicle is an invitation to thieves. Always remove the key from the ignition and lock all the doors when leaving the vehicle unattended.

2

SENTRY KEY — IF EQUIPPED

With this system, an electronically coded ignition key sends a signal to the vehicle electronics. If the electronics recognizes the signal, the vehicle will start and continue to run. If the system does not recognize the signal, the vehicle will start and run for 2 seconds, then shut off. After six unsuccessful attempts at starting, the system will shut down until the correct key is used.

NOTE: If the key is in the ignition switch, then all buttons on that transmitter will be disabled. The buttons

on the remaining transmitters will work. If the vehicle is shifted out of PARK, all the transmitter buttons are disabled for all keys.

NOTE: The Sentry Key Immobilizer System is not compatible with remote starting systems. Use of these systems may result in vehicle starting problems and a loss of security protection. Additional Sentry Keys or Mobil Speed-pass™ devices held against or immediately adjacent to the ignition key when starting the engine may cause vehicle starting problems. If a problem occurs, remove the Sentry Key from the key-ring and attempt to start the vehicle again. Pagers, cell phones, walkman, etc. will have no effect on this system.

The "Security Light" will illuminate for about 3 seconds when the ignition switch is first turned to the ON position. If the vehicle electronics do not receive a valid signal from the ignition key, the "Security Light" will flash

continuously to signal that the vehicle has been immobilized. If the "Security Light" remains on during vehicle operation, it indicates a fault in the system electronics. If this option was ordered, all of the keys provided with your new vehicle have been programmed to the vehicle electronics.

Replacement Keys

NOTE: Only keys that have been programmed to the vehicle electronics can be used to start the vehicle. Once a Sentry Key has been programmed to a vehicle, it cannot be programmed to any other vehicle.

At the time of purchase, the original owner is provided with a four digit PIN number. This number is required for dealer replacement of keys. Duplication of keys may be performed at an authorized dealer or by using the Customer Key Programming procedure. This procedure

consists of programming a blank key to the vehicle electronics. A blank key is one which has never been programmed and needs to be cut.

NOTE: When having the Sentry Key System serviced, bring all vehicle keys to the dealer.

Customer Key Programming

You can program new keys to the system if you have two valid keys by doing the following:

1. Insert the first valid key into the ignition and turn the ignition to the ON position for at least 3 seconds but no longer than 15 seconds. Turn the ignition back to the OFF position and remove the first key.
2. Insert the second valid key and switch the ignition to the ON position within 15 seconds. After 10 seconds, a chime will sound and the "Security Light" will begin to flash. Turn the ignition back to the OFF position and remove the second key.

3. Insert a blank Sentry Key into the ignition and switch the ignition to the ON position within 60 seconds of having removed the second key. After 10 seconds, a single chime will sound. The "Security Light" will stop flashing, then turn on for 3 seconds; then turn off.

The new Sentry Key has been programmed. Repeat this process to program up to a total of 8 keys.

General Information

This device complies with part 15 of FCC rules and with RS-210 of Industry Canada. Operation is subject to the following conditions:

1. This device may not cause harmful interference.
2. This device must accept any interference that may be received including interference that may cause undesired operation.

12 THINGS TO KNOW BEFORE STARTING YOUR VEHICLE

NOTE: Changes or modifications not expressly approved by the party responsible for compliance could void the user's authority to operate the equipment.

IGNITION AND STEERING LOCK

In the LOCK position, the steering and ignition systems are locked to provide anti-theft protection for your vehicle. It may be difficult to turn the key from the LOCK position when starting your vehicle, if the steering wheel is locked. Move the steering wheel left and right while turning the key until it turns easily. The key can be inserted or withdrawn only in the LOCK position. Push in on the key in the ignition lock cylinder to rotate to the LOCK position.

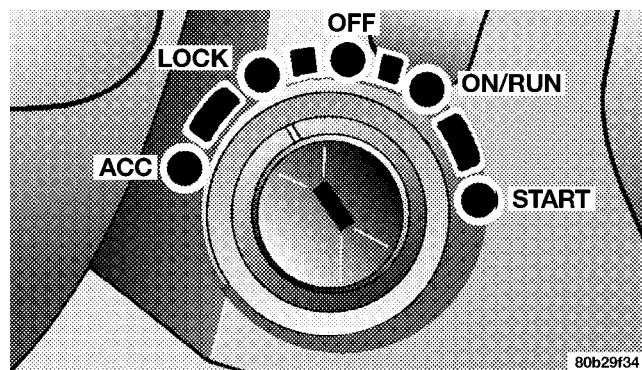

WARNING!

The key cannot be turned to LOCK until the selector is in the PARK position. Do not attempt to pull the shift lever out of PARK after the key is in the LOCK position.

NOTE: The steering wheel will lock when the key is removed, and the steering wheel is turned around 115 degrees clockwise or 65 degrees counterclockwise from the center position.

Ignition Accessory Delay Feature

When the ignition is turned to OFF/LOCK position the accessory features on the vehicle will continue to operate for ten minutes or until the driver's door is opened. The accessory features are: Power Windows, Sunroof, and Radio. This feature can be turned off by the dealer.

ILLUMINATED ENTRY

Vehicles Equipped With Power Door Locks

All interior lights will illuminate in the vehicle when the doors are unlocked using the key fob.

The interior lights will remain on for 30 seconds after the last door is closed, or until all doors are closed and either the ignition is turned to the ON position or a key fob LOCK button is pressed.

There is also a battery saver feature that will turn the interior lights off after 8 minutes if the ignition is OFF and a door is left open or the dimmer control is in the interior lights ON position.

DOOR LOCKS

Manual Door Locks

All the doors can be "manually" locked from the inside by pushing down the door lock plunger, located at the rear of the door. Both front doors may be opened from the inside with the door lock plunger in the down or locked position.

WARNING!

For personal security and safety in the event of an accident, lock the vehicle doors as you drive as well as when you park and leave the vehicle.

WARNING!

When leaving the vehicle always remove the key from the ignition lock, and lock your vehicle. Do not leave children unattended in the vehicle, or with access to an unlocked vehicle. Unsupervised use of vehicle equipment may cause severe personal injuries and death.

Power Door Locks

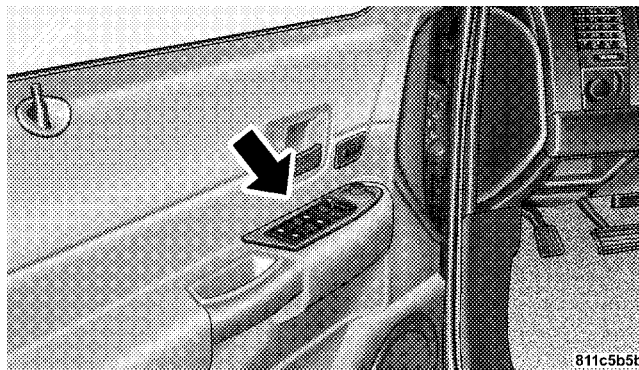

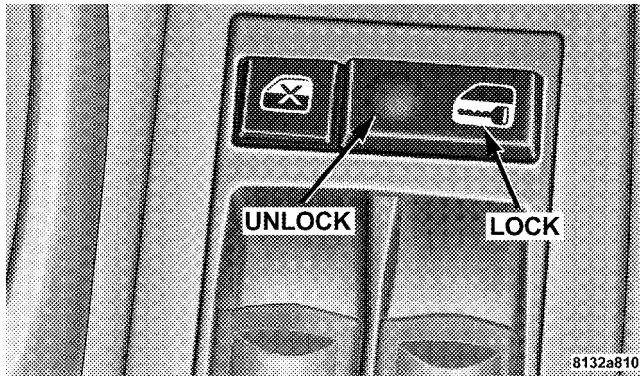

Vehicles equipped with power door locks can be locked or unlocked from inside by either the use of the door lock switches located on the front doors or by pressing the LOCK or UNLOCK buttons on the Remote Keyless Entry key fob.

As a safety feature the doors will not lock when using the door lock switches during the following conditions:

- The driver's door is open while the key is in the ignition.

Automatic Door Locks

If this feature is enabled, your door locks will lock automatically when the vehicle's speed exceeds 15 mph (24 km/h).

This feature is enabled when your vehicle is shipped from the assembly plant and can be disabled by using the following procedure:

1. Enter your vehicle and Close all doors.
2. Fasten your seat belt (Fastening the seat belt will cancel any chiming that may confuse you during this programming procedure).
3. Place the key into the ignition.

4. Within 10 seconds, cycle the key from the OFF position to the ON position four times; ending in the ON position (**Do not start the engine**).
5. Within 30 seconds, press the driver's door lock switch in the LOCK direction.
6. A single chime will be heard to indicate the feature has been disabled.
7. To re-activate this feature, repeat the above steps.
8. If a chime is not heard, program mode was canceled before the feature could be disabled. If necessary, repeat the above procedure.

Auto Unlock Feature

This feature unlocks all the doors of the vehicle when the driver's door is opened first. The following conditions must be met:

- The driver's door must be opened first.

- The Automatic Door Lock feature must be enabled.
- The doors of the vehicle must be locked automatically by the Automatic Door Lock feature.
- The vehicle is in P (Park) and the ignition switch is in the Off position.

This feature will not operate if any of the conditions above are not met or following has occurred:

- Any manual operation of a door lock switch has occurred.

NOTE: This customer programmable feature is enabled when your vehicle is shipped from the assembly plant.

Auto Unlock Feature Programming

Customer Programming sequence to disable or enable:

1. Enter your vehicle and close all doors.

2. Fasten your seat belt (fastening the seat belt will cancel any chiming that may be confusing during this programming procedure).
3. Insert the key into the ignition.
4. Within 10 seconds, cycle the key from the OFF position to the ON position four times ending in the ON position (**do not start the engine**).
5. Within 30 seconds, press the driver's door lock switch in the UNLOCK direction.
6. A single chime will sound to indicate the feature has been changed.
7. To reactivate the feature, repeat the above steps.
8. If a chime is not heard, program mode was canceled before the feature could be changed. If necessary repeat the above procedure.

Child Protection Door Lock

To provide a safer environment for children riding in the rear seat, the rear doors of your vehicle have the child-protection door lock system.

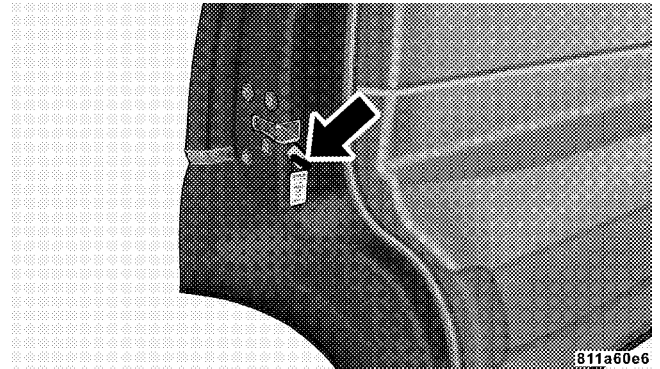

811a60e6

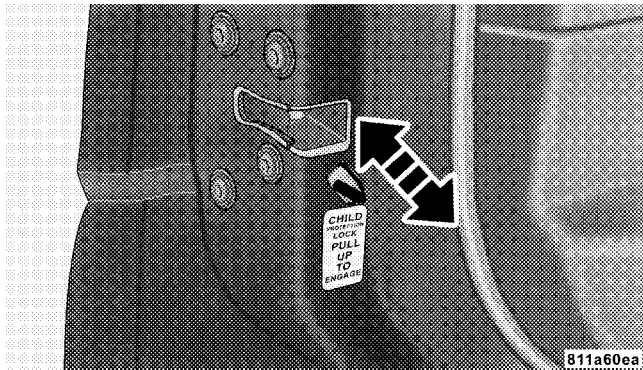

To use the system, open each rear door and slide the control UP to engage the locks and DOWN to disengage the child-protection locks. When the system on a door is engaged, that door can only be opened by using the outside door handle even if the inside door lock is in the unlocked position.

WARNING!

Avoid trapping anyone in a vehicle in a collision. Remember that the rear doors can only be opened from the outside when the child protection locks are engaged.

NOTE: After setting the child protection door lock system, always test the door from the inside to make certain it is in the desired position.

NOTE: For emergency exit with the system engaged, move the door lock switch to the UNLOCK position, roll down the window and open the door with the outside door handle.

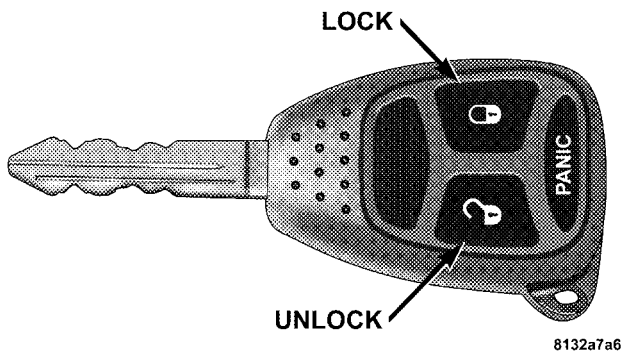
REMOTE KEYLESS ENTRY

This system allows you to lock or unlock the doors and liftgate or activate the panic alarm from distances a minimum of 66 feet (20 meters) using a hand held radio transmitter. The transmitter need not be pointed at the vehicle to activate the system.

NOTE: The line of transmission must not be blocked with metal objects.

To unlock the doors and liftgate:

Press and release the UNLOCK button on the key fob once to unlock only the driver's door or twice to unlock all the doors and liftgate. When the UNLOCK button is pressed, the illuminated entry will initiate, and the parking lights will flash on twice.

The system can be programmed to unlock all the doors upon the first UNLOCK button press by using the following procedure:

1. Press and hold the LOCK button on a programmed key fob.
2. Continue to hold the LOCK button at least 4 seconds, but not longer than 10 seconds, then press and hold the UNLOCK button.
3. Release both buttons at the same time.

4. Test the feature while outside of the vehicle, by pressing the LOCK/UNLOCK button on the keyfob.

NOTE: Pressing the LOCK button on the keyfob while you are inside the vehicle will activate the Security Alarm. Opening a door with the Security Alarm activated will cause the alarm to sound. Press the UNLOCK button to deactivate the Security Alarm.

5. If the desired programming was not achieved or to reactivate this feature, repeat the above steps.

To lock the doors and liftgate:

Press and release the LOCK button on the key fob to lock all doors and liftgate. If the ignition is OFF, when the doors are locked, the parking lights will flash on once and the horn will chirp once.

Horn Chirp Programming

The horn chirp feature will be shipped from the assembly plants activated. If desired this feature can be disabled by using the following procedure:

1. Press and hold the LOCK button on the key fob.
2. After holding the LOCK button for four seconds, also press the PANIC button within 6 seconds.
3. Release both buttons at the same time.
4. To reactivate this feature, repeat the above steps.
5. Test the horn chirp feature while outside of the vehicle, by pressing the LOCK button on the key fob with the ignition in the OFF position and the key removed.

NOTE: Pressing the LOCK button on the keyfob, while you are inside the vehicle, will activate the Security

Alarm. Opening a door with the Security Alarm activated will cause the alarm to sound. Press the UNLOCK button to deactivate the Security Alarm.

6. If the desired programming was not achieved or to reactivate this feature, repeat the above steps.

Flash Lamps with Lock Programming

1. Press and hold the UNLOCK button on the key fob.
2. After holding the UNLOCK button for four seconds, also press the LOCK button within 6 seconds.
3. Release both buttons at the same time.
4. Test the flash lamps with LOCK feature while outside of the vehicle, by pressing the LOCK button on the key fob with the ignition in the OFF position, and the key removed.

NOTE: Pressing the LOCK button on the key fob, while you are in the vehicle, will activate the Security Alarm.

Opening a door with the Security Alarm activated will cause the alarm to sound. Press the UNLOCK button to deactivate the Security Alarm.

5. If the desired programming was not achieved or to reactivate this feature, repeat the above steps.

Using the Panic Alarm

To activate the Panic mode while the ignition is OFF press and release the PANIC button on the transmitter once. When the Panic mode is activated, the interior lights will illuminate, the headlamps and parking lights will flash, and the horn will sound.

To cancel the Panic mode press and release the PANIC button on the transmitter a second time. Panic mode will automatically cancel after 3 minutes or if the vehicle is started or exceeds 15 mph (24 km/h). During the Panic Mode, the door locks and remote keyless entry systems will function normally. Panic mode will not disarm the security system on vehicles so equipped.

General Information

This device complies with part 15 of FCC rules and with RS-210 of Industry Canada. Operation is subject to the following conditions:

1. This device may not cause harmful interference.
2. This device must accept any interference that may be received including interference that may cause undesired operation.

NOTE: Changes or modifications not expressly approved by the party responsible for compliance could void the user's authority to operate the equipment.

If your Remote Lock Control fails to operate from a normal distance, check for these two conditions.

1. Weak batteries in transmitter. The expected life of batteries is five years.

2. Closeness to a radio transmitter such as a radio station tower, airport transmitter, military base, and some mobile or CB radios.

Programming Additional Transmitters

Vehicles will be shipped from the assembly plants with two key fob transmitters programmed only for that vehicle. A total of eight fobs can be programmed for your vehicle. Additional fobs can be programmed to your vehicle through the use of a currently programmed fob.

NOTE: When entering program mode using that fob, all other programmed fobs will be erased and you will have to reprogram them for your vehicle.

Use the Following procedure to program additional key fobs if the vehicle is not equipped with Sentry Key:

1. Enter your vehicle and close all doors.

2. Fasten your seat belt (Fastening the seatbelt will cancel any chiming that may confuse you during this programming procedure).
 3. Place the key into the ignition.
 4. Turn the ignition to the ON position (**Do not start the engine**).
 5. Press and hold the UNLOCK button on the key fob.
 6. After holding the UNLOCK button for four seconds, also press the PANIC button within 6 seconds.
 7. When a single chime is heard release both buttons. The chime is an indication that you have successfully entered program mode. All fobs that are to be programmed must be done so within 60 seconds of when the chime was heard.
 8. Using the fob to be programmed, press and release both the LOCK and UNLOCK buttons, simultaneously.
 9. A single chime will be heard.
 10. Within four seconds of hearing the chime, press and release the UNLOCK button on the fob.
 11. A single chime will be heard.
 12. Repeat steps 8 through 10 to program up to six additional fobs.
 13. Turn the ignition to the OFF position.
 14. Your vehicle will remain in program mode up to 60 seconds from when the original chime was heard. After 60 seconds, all programmed fobs function normally.
- NOTE:** If you do not have a programmed transmitter, contact your dealer for details.

Battery Replacement

The recommended replacement battery is CR2032.

1. If the key fob is equipped with a screw, remove the screw. With the transmitter buttons facing down, use a flat blade to pry the two halves of the transmitter apart. Make sure not to damage the elastomer seal during removal.

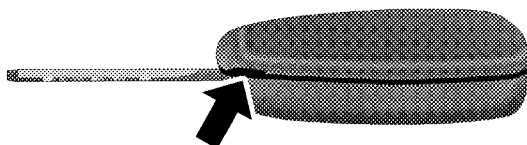

2. Remove and replace the batteries. Avoid touching the new batteries with your fingers. Skin oils may cause battery deterioration. If you touch a battery, clean it with rubbing alcohol.

3. To assemble the transmitter case, snap the two halves together.

NOTE: If the key fob is equipped with a screw, reinstall and tighten the screw until snug.

SECURITY ALARM SYSTEM — IF EQUIPPED

This system monitors the vehicle doors, liftgate, and ignition for unauthorized operation. When the alarm is activated, the system provides both audible and visual signals. The horn will sound repeatedly for 3 minutes and the headlights and security light in the instrument cluster will flash for an additional 15 minutes. The engine will not run until the system is disarmed.

To Set the Alarm:

The alarm will set when you use the power door locks or use the Keyless Entry transmitter to lock the doors. After all the doors are locked and closed the security light in the instrument cluster will flash rapidly to signal that the system is arming. The security light in the instrument panel cluster will flash rapidly for about 15 seconds to indicate that the alarm is being set. After the alarm is set, the security light will flash at a slower rate to indicate that the system is armed.

NOTE: If the security light stays on continuously during vehicle operation, have the system checked by your dealer.

To Disarm the System:

Use the Keyless Entry transmitter to unlock the doors. If something has triggered the system in your absence, the horn will sound three times when you unlock the doors. Check the vehicle for tampering.

The security system will also disarm, if the vehicle is started with a programmed Sentry Key. If an unprogrammed Sentry Key is used to start a vehicle, the engine will start and run for 2 seconds and then shut down. After six unsuccessful attempts at starting the engine, the system will shut down until the correct key is used. To exit alarming mode, press the RKE Unlock button or start the vehicle with a programmed Sentry Key.

The security alarm system is designed to protect your vehicle; however, you can create conditions where the system will arm unexpectedly. If you remain in the vehicle and lock the doors with the transmitter, the alarm will sound when you pull the door handle to exit.

NOTE: You may accidentally activate the security system (horn sounds and lights flash) by entering the vehicle without using the key fob to unlock the door(s). The security system can be disarmed with the key fob's

UNLOCK button or by inserting a programmed Sentry Key into the ignition and turning the key to the ON position.

LIFTGATE

Once unlocked, the liftgate can be opened or closed without using the key. To open the liftgate, pull out on the outside handle and lift.

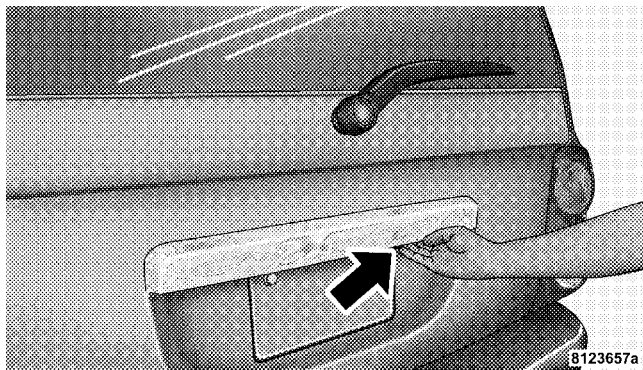

WARNING!

- **Driving with the liftgate open can allow poisonous exhaust gases into your vehicle. You and your passengers could be injured by these fumes. Keep the liftgate closed when you are operating the vehicle.**
- **If you are required to drive with the liftgate open, make sure that all windows are closed, and the climate control blower switch is set at high speed. Do NOT use the recirculation mode.**

Gas props support the liftgate in the open position. However, because the gas pressure drops with temperature, it may be necessary to assist the props when opening the liftgate in cold weather.

WINDOWS

Power Windows

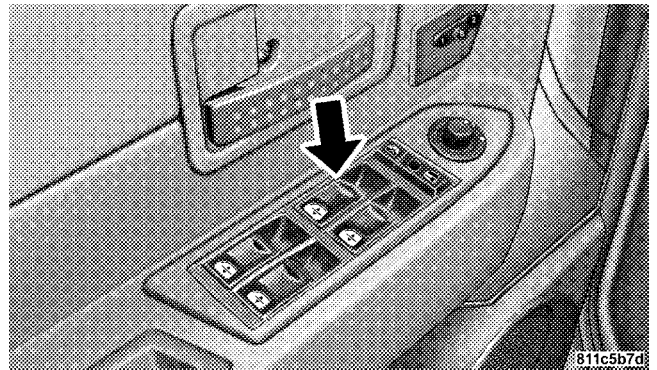
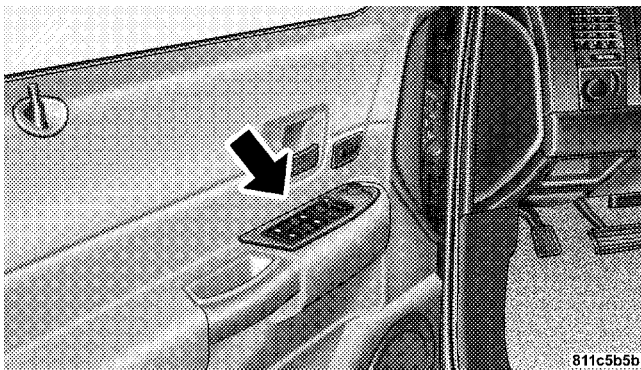

The control on the left front door has up-down switches that give you finger tip control of all four power windows. There is a single opening and closing switch on the passenger doors for passenger window control. The windows will operate only when the ignition switch is turned to the ON position and for ten minutes after the

ignition is turned OFF or the driver's door is opened. This feature can be turned off by your authorized dealer.

NOTE: The Power Accessory Delay feature will allow the power windows to operate for ten minutes after the ignition it turned OFF.

Auto Down

The driver's window switch has an Auto Down feature. Push the window switch past the first detent, release, and the window will go down automatically. To cancel the Auto Down movement, operate the switch in either the up or down direction and release the switch.

Window Lockout Switch

The window lockout switch on the driver's door allows you to disable the window control on the other doors. To disable the window controls on the other doors, press the window lock button. To enable the window controls, press the window control button again.



OCCUPANT RESTRAINTS

Some of the most important safety features in your vehicle are the restraint systems. These include the front and rear seat belts for the driver and all passengers, knee bolsters, front airbags for both the driver and front passenger, and if equipped left and right side curtain airbags for the driver and passengers seated next to a

window. If you will be carrying children too small for adult-size seat belts, your seat belts or the LATCH feature (refer to the Child Restraint section in this manual), can be used to hold infant and child restraint systems.

Please pay close attention to the information in this section. It tells you how to use your restraint system properly to keep you and your passengers as safe as possible.

WARNING!

In a collision, you and your passengers can suffer much greater injuries if you are not properly buckled up. You can strike the interior of your vehicle or other passengers, or you can be thrown out of the vehicle. Always be sure you and others in your vehicle are buckled up properly.

Buckle up even though you are an excellent driver, even on short trips. Someone on the road may be a poor driver and cause a collision that includes you. This can happen far away from home or on your own street.

Research has shown that seat belts save lives, and that they can reduce the seriousness of injuries in a collision. Some of the worst injuries happen when people are thrown from the vehicle. Seat belts reduce the possibility of ejection and the risk of injury caused by striking the inside of the vehicle. **Everyone** in a motor vehicle should be belted at all times.

Lap/Shoulder Belts

All seating positions in your vehicle have combination lap/shoulder belts. The belt webbing retractor is designed to lock during very sudden stops or collisions. This feature allows the shoulder part of the belt to move

freely with you under normal conditions. But in a collision, the belt will lock and reduce the risk of your striking the inside of the vehicle or being thrown out.

WARNING!

It is extremely dangerous to ride in a cargo area, inside or outside of a vehicle. In a collision, people riding in these areas are more likely to be seriously injured or killed.

Do not allow people to ride in any area of your vehicle that is not equipped with seats and seat belts.

Be sure everyone in your vehicle is in a seat and using a seat belt properly.

WARNING!

- **Wearing a seat belt incorrectly is dangerous. Seat belts are designed to go around the large bones of your body. These are the strongest parts of your body and can take the forces of a collision the best. Wearing your belt in the wrong place could make your injuries in a collision much worse. You might suffer internal injuries, or you could even slide out of part of the belt. Follow these instructions to wear your seat belt safely and to keep your passengers safe, too.**
- **Two people should never be belted into a single seat belt. People belted together can crash into one another in an accident, hurting one another badly. Never use a lap/shoulder belt or a lap belt for more than one person, no matter what their size.**

Lap/Shoulder Belt Operating Instructions

1. Enter the vehicle and close the door. Sit back and adjust the seat.

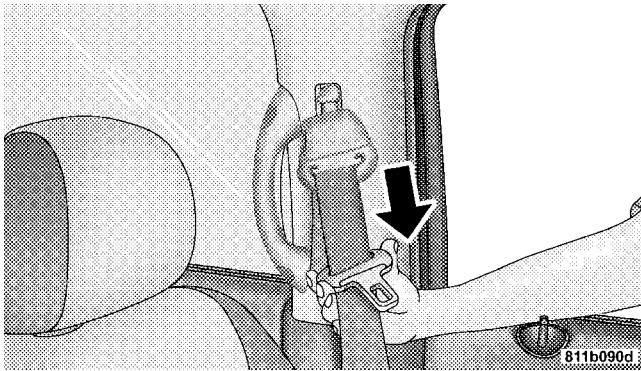

2. The seat belt latch plate is above the back of the front seat, next to your arm in the rear seat. Grasp the latch

plate and pull out the belt. Slide the latch plate up the webbing as far as necessary to allow the belt to go around your lap.

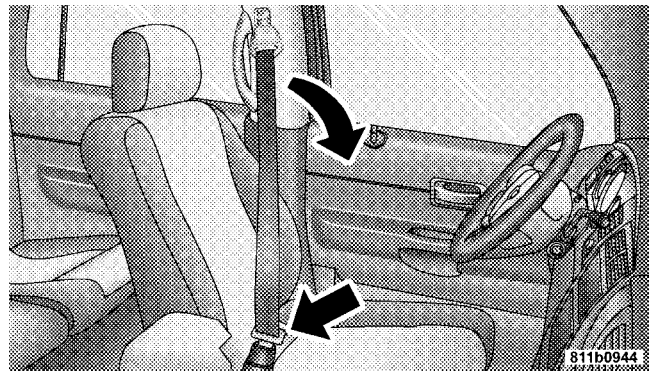

3. When the belt is long enough to fit, insert the latch plate into the buckle until you hear a “click.”

WARNING!

- A belt buckled into the wrong buckle will not protect you properly. The lap portion could ride too high on your body, possibly causing internal injuries. Always buckle your belt into the buckle nearest you.
- A belt that is too loose will not protect you as well. In a sudden stop you could move too far forward, increasing the possibility of injury. Wear your seat belt snugly.
- A belt that is worn under your arm is very dangerous. Your body could strike the inside surfaces of the vehicle in a collision, increasing head and neck injury. And a belt worn under the arm can cause internal injuries. Ribs aren't as strong as shoulder bones. Wear the belt over your shoulder so that your strongest bones will take the force in a collision.
- A shoulder belt placed behind will not protect you from injury during a collision. You are more likely to hit your head in a collision if you do not wear your shoulder belt. The lap and shoulder belt are meant to be used together.

4. Position the lap belt across your thighs, below your abdomen. To remove slack in the lap belt portion, pull up on the shoulder belt. To loosen the lap belt if it is too tight, tilt the latch plate and pull on the lap belt. A snug belt reduces the risk of sliding under the belt in a collision.

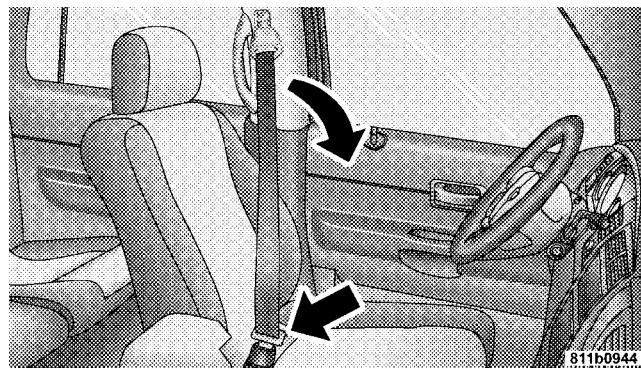

WARNING!

- **A lap belt worn too high can increase the risk of internal injury in a collision. The belt forces won't be at the strong hip and pelvic bones, but across your abdomen. Always wear the lap belt as low as possible and keep it snug.**
- **A twisted belt can't do its job as well. In a collision it could even cut into you. Be sure the belt is straight. If you can't straighten a belt in your vehicle, take it to your dealer and have it fixed.**

5. Position the shoulder belt on your chest so that it is comfortable and not resting on your neck. The retractor will withdraw any slack in the belt.

6. To release the belt, push the red button on the buckle. The belt will automatically retract to its stowed position. If necessary, slide the latch plate down the webbing to allow the belt to retract fully.

WARNING!

A frayed or torn belt could rip apart in a collision and leave you with no protection. Inspect the belt system periodically, checking for cuts, frays, or loose parts. Damaged parts must be replaced immediately. Do not disassemble or modify the system. Seat belt assemblies must be replaced after a collision if they have been damaged (bent retractor, torn webbing, etc.).

Adjustable Upper Shoulder Belt Anchorage

In the front and second row outboard seats, the shoulder belt can be adjusted upward or downward to help position the belt away from your neck. Push in on the anchorage release button to release the anchorage, and then move it up or down to the position that serves you best.

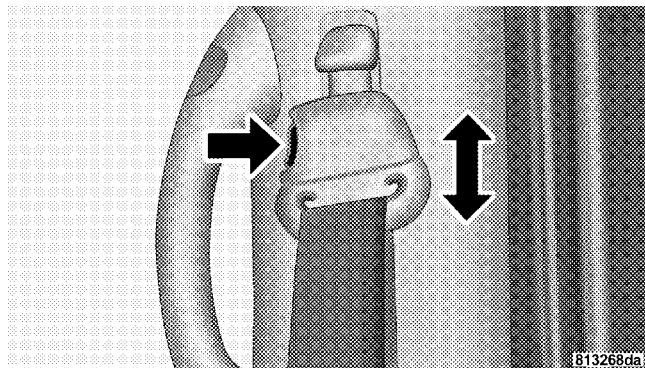

As a guide, if you are shorter than average, you will prefer a lower position, and if you are taller than average, you'll prefer a higher position. When you release the anchorage, try to move it up or down to make sure that it is locked in the desired position.

Second Row Center Seat Belt

The center seating position in the second row has a seat belt assembly that can be converted from the normal emergency locking mode to the automatic locking mode. The seat belt should only be used in the automatic locking mode when a child seat is installed at this seating location.

When sitting in this seating location, ensure the seatback is fully engaged with the seatback latch by pushing rearward on the center seatback until you hear a click that signals latch engagement.

Automatic Locking Mode

To convert from the normal emergency locking mode to the automatic locking mode, grasp the shoulder belt portion and pull all of the webbing out of the retractor. Allow some of the webbing to retract into the retractor, as the belt retracts you will hear a clicking sound to indicate the seat belt is now in the automatic locking mode. Once the automatic locking mode has been activated, you will not be able pull the webbing back out of the retractor. To disengage the automatic locking mode, simply allow the seat belt to retract fully into the retractor to return the seat belt to the normal emergency locking mode.

Seat Belt Pretensioners

The seat belts for both front seating positions are equipped with pretensioning devices that are designed to remove any slack from the seat belt system in the event of a collision. These devices improve the performance of the seat belt by assuring that the belt is tight about the

occupant early in a collision. Pretensioners work for all size occupants, including those in child restraints.

NOTE: These devices are not a substitute for proper seat belt placement by the occupant. The seat belt still must be worn snugly and positioned properly.

The pretensioners are triggered by the Occupant Restraint Controller (ORC). Like the airbags, the pretensioners are single use items. After a collision that is severe enough to deploy the airbags and pretensioners, both must be replaced.

Enhanced Driver Seat Belt Reminder System (BeltAlert)

If the driver's seat belt has not been buckled within 60 seconds of starting the vehicle and if the vehicle speed is greater than 5 mph (8 km/h), the Enhanced Warning System (BeltAlert) will alert the driver to buckle their seat belt. The driver should also instruct all other occupants to buckle their seat belts. Once the warning is triggered, the

Enhanced Warning System (BeltAlert) will continue to chime and flash the Seat Belt Warning Light for 96 seconds or until the driver's seat belt is buckled. The Enhanced Warning System (BeltAlert) will be reactivated if the driver's seat belt is unbuckled for more than 10 seconds and the vehicle speed is greater than 5 mph (8 km/h).

The Enhanced Warning System (BeltAlert) can be enabled or disabled by your authorized dealer or by following these steps:

NOTE: The following steps must occur within the first 60 seconds of the ignition switch being turned to the ON or START position. DaimlerChrysler does not recommend deactivating the Enhanced Warning System (BeltAlert).

1. Turn the ignition switch to the OFF position and buckle the driver's seat belt.

2. Start the engine and wait for the Seat Belt Warning Light to turn off.

3. Within 60 seconds of starting the vehicle, unbuckle and then re-buckle the driver's seat belt at least three times within 10 seconds, ending with the seat belt buckled.

4. Turn off the engine. A single chime will sound to signify that you have successfully completed the programming.

The Enhanced Warning System (BeltAlert) can be reactivated by repeating this procedure.

NOTE: Although the Enhanced Warning System (BeltAlert) has been deactivated, the Seat Belt Warning Light will continue to illuminate while the driver's seat belt remains unbuckled.

Seat Belts and Pregnant Women

We recommend that pregnant women use seat belts throughout their pregnancies. Keeping the mother safe is the best way to keep the baby safe.

Pregnant women should wear the lap part of the belt across the thighs and as snug against the hips as possible. Keep the belt low so that it does not come across the abdomen. That way the strong bones of the hips will take the force if there is a collision.

Seat Belt Extender

If a seat belt is too short, even when fully extended, your dealer can provide you with a seat belt extender. This extender should be used only if the existing belt is not long enough. When it is not required, remove the extender and store it.

WARNING!

Using a seat belt extender when not needed can increase the risk of injury in a collision. Only use the seat belt extender when the lap belt is not long enough when it is worn low and snug, and in the recommended seating positions. Remove and store the extender when not needed.

Driver And Right Front Passenger Supplemental Restraint System (SRS)—Airbags

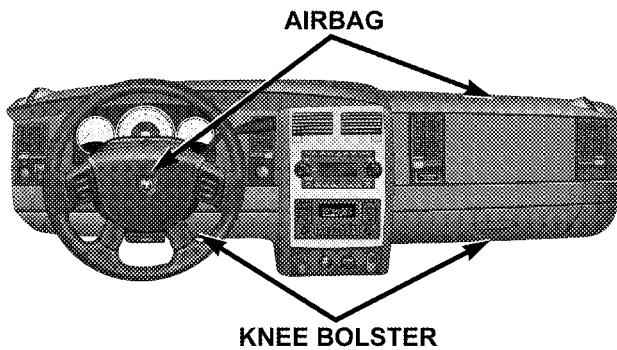

811cade0

This vehicle has airbags for both the driver and right front passenger as a supplement to the seat belt restraint systems. The driver's front airbag is mounted in the steering wheel. The passenger front airbag is mounted in

the instrument panel, above the glove compartment. The words SRS/AIRBAG are embossed on the airbag covers.

NOTE: The front airbags are certified to the Federal regulations that allow less forceful deployment.

The front airbags have a multistage inflator design. This may allow the airbag to have different rates of inflation that are based on collision severity and occupant size. Also, the front passenger airbag is certified to the Federal regulations that define Occupant Classification (Refer to "Occupant Classification System" in this section).

This vehicle may also be equipped with window bags to protect the driver, front, and rear passengers sitting next to a window. If the vehicle is equipped with window bags, they are located above the side windows. Their covers are also labeled SRS AIRBAG.

NOTE: Airbag covers may not be obvious in the interior trim; but they will open to allow airbag deployment.

WARNING!

- Do not put anything on or around the front airbag covers or attempt to manually open them. You may damage the airbags and you could be injured because the airbags are not there to protect you. These protective covers for the airbag cushions are designed to open only when the airbags are inflating.
- If your vehicle is equipped with window bags, do not stack luggage or other cargo up high enough to block the location of the window bag. The area where the window bag is located should remain free from any obstructions.
- If your vehicle is equipped with window bags, do not have any accessory items installed which will alter the roof, including adding a sunroof to your vehicle. Do not add roof racks that require permanent attachments (bolts or screws) for installation on the vehicle roof. Do not drill into the roof of the vehicle for any reason.

Along with the seat belts, front airbags work with the instrument panel knee bolsters to provide improved protection for the driver and front passenger. Window bags also work with seat belts to improve occupant protection.

The seat belts are designed to protect you in many types of collisions. The front airbags deploy in moderate to severe frontal collisions.

NOTE: The passenger front airbag may not deploy even when the driver front airbag has if the Occupant Classification System (refer to "Occupant Classification System" in this section) has determined the passenger seat is empty or is occupied by someone that is classified in the "small child" category.

If your vehicle is so equipped, the window bag on the crash side of the vehicle is triggered in moderate to severe side collisions. But even in collisions where the

40 THINGS TO KNOW BEFORE STARTING YOUR VEHICLE

airbags work, you need the seat belts to keep you in the right position for the airbags to protect you properly.

Here are some simple steps you can follow to minimize the risk of harm from a deploying airbag.

1. Children 12 years and under should always ride buckled up in a rear seat in an appropriate child restraint.

Infants in rear-facing child restraints should **NEVER** ride in the front seat of a vehicle with a passenger front airbag. An airbag deployment can cause severe injury or death to infants in that position.

If a child from 1 to 12 years old must ride in the front passenger seat because the vehicle is crowded, move the seat as far back as possible, and use the proper child restraint. See "Child Restraint" in this section.

You should read the instructions provided with your child restraint to make sure that you are using it properly.

2. All occupants should use their lap and shoulder belts properly.

3. The driver and front passenger seats should be moved back as far as practical to allow the airbag room to inflate.

4. If your vehicle has window bags, do not lean against the door or window, airbags will inflate forcefully into the space between you and the door.

5. If the airbag system in this vehicle needs to be modified to accommodate a disabled person, contact the Customer Center. Phone numbers are provided in the "If You Need Customer Assistance" section later in this owner's manual.

WARNING!

- Relying on the airbags alone could lead to more severe injuries in a collision. The airbags work with your seat belt to restrain you properly. In some collisions the airbags won't deploy at all. Always wear your seat belts even though you have airbags.
- Being too close to the steering wheel or instrument panel during airbag deployment could cause serious injury. Airbags need room to inflate. Sit back, comfortably extending your arms to reach the steering wheel or instrument panel.
- If the vehicle has window bags, they also need room to inflate. Do not lean against the door or window. Sit upright in the center of the seat.

Air Bag System Components

The airbag system consists of the following:

- Occupant Restraint Controller
- Side Remote Acceleration Sensors (If Equipped)
- Airbag Warning Light
- Driver Airbag
- Passenger Airbag
- Window Bags above Side Windows (If Equipped)
- Steering Wheel and Column
- Instrument Panel
- Interconnecting Wiring
- Knee Impact Bolsters
- Front Acceleration Sensors

- Driver and Front Passenger Seat Belt Pretensioners
- Occupant Classification System (OCS) for the Front Passenger Seat
 - Occupant Classification Module
 - Passenger Airbag Disable (PAD) Indicator Light
 - Weight Sensors

How the Airbag System Works

- The **Occupant Restraint Controller (ORC)** determines if a frontal collision is severe enough to require the airbags to inflate. The front airbag inflators are designed to provide different rates of airbag inflation from direction provided by the ORC. The ORC may also modify the rate of inflation based on the occupant size provided by the Occupant Classification Module. The ORC will not detect roll over.

The ORC also monitors the readiness of the electronic parts of the system whenever the ignition switch is in the START or RUN positions. These include all of the items listed above except the steering wheel and column, and knee bolsters. If the key is in the OFF position, in the ACC position, or not in the ignition, the airbags are not on and will not inflate.

During a moderate-to-severe rear impact the ORC may deploy the seat belt pretensioners alone.

Also, the ORC turns on the AIRBAG warning light and PAD indicator light in the instrument panel for 6 to 8 seconds for a self-check when the ignition is first turned on. After the self-check, the AIRBAG warning light will turn off. The PAD indicator light will function normally (Refer to "Passenger Airbag Disable (PAD) Indicator Light" in this section). If the ORC detects a malfunction in any part of the system, it turns on the AIRBAG warning

light either momentarily or continuously. A single chime will sound if the light comes on again after initial start up.

WARNING!

Ignoring the AIRBAG warning light in your instrument panel could mean you won't have the airbags to protect you in a collision. If the light does not come on, stays on after you start the vehicle, or if it comes on as you drive, have the airbag system checked right away.

- The **Occupant Classification System (OCS)** is part of a Federally regulated safety system required for this vehicle. It is designed to turn off the front passenger airbag in the unlikely event that a rear-facing infant seat is in the front passenger seat.

NOTE: Children 12 years and under should always ride buckled up in a rear seat in an appropriate child restraint.

- The **Passenger Airbag Disable (PAD) Indicator Light** (an amber light located in the center of the instrument panel) tells the driver and front passenger when the front passenger airbag is turned off. The PAD Indicator lamp illuminates the words "PASS AIR BAG OFF" to show that the passenger airbag will not inflate during a collision requiring airbags.

This light should not be illuminated when an adult passenger is properly seated in the front passenger seat. In this case, the airbag is ready to be inflated if a collision requiring an airbag occurs. The PAD Indicator Light is also turned off when the seat is empty. The only time that the PAD Indicator Light is turned on is when a small weight is in the front passenger seat. The system is required to turn on the PAD Indicator Light when the weight in the front passenger seat is close to

44 THINGS TO KNOW BEFORE STARTING YOUR VEHICLE

a rear-facing infant seat. Relatively light objects like brief cases and grocery bags will also turn on the PAD Indicator Light. The PAD Indicator Light will be off when teenagers, most children and most children in forward-facing seats are in the front passenger seat. The system is only required to turn the PAD Indicator Light on in the unlikely event that a rear-facing infant seat is installed in front passenger seat.

NOTE: Children 12 years and under should always ride buckled up in a rear seat in an appropriate child restraint.

Front Passenger Seat Occupant	Passenger Airbag Disable (PAD) Indicator Light	Airbag Status
Adult	OFF	ON
Grocery Bags, Heavy Briefcases and Other Relatively Light Objects	ON	OFF
Empty or Very Small Objects	OFF*	OFF

* Since the system senses weight, some small objects will turn the PAD Indicator Light on.

The OCS classifies an occupant using weight sensors mounted in the base of the front passenger seat. Any weight on the seat will be sensed by the system. Objects hanging on the seat or other passengers pushing down on the seat will also be sensed. The weight of an adult will cause the system to turn the airbag on. In this case, the OCS has classified the occupant of the seat as an adult. An adult occupant needs to sit in a normal position (with their feet on or near the floor) in order to be properly classified.

Drivers and adult passengers should verify that the PAD Indicator Light is not illuminated when an adult is riding in the front passenger seat. If an adult occupant's weight is transferred to another part of the vehicle (like the door or instrument panel), the weight sensors in the seat may not properly classify the occupant. Objects lodged under the seat or between the seat and the center console can

prevent the occupant's weight from being measured properly and may result in the occupant being improperly classified.

If the front passenger seat is damaged in any way, it should only be serviced by an authorized dealer. If the seat is removed (or even if the seat attachment bolts are loosened or tightened in any way), take the vehicle to an authorized dealer.

If there is a fault present in the OCS, the Airbag Warning Light (a red light located in the center of the instrument cluster directly in front of the driver) will be turned on. This indicates that you should take the vehicle to an authorized dealer. The Airbag Warning Light is turned on whenever there is a fault that can affect the operation of the airbag system. If there is a fault present in the OCS, both the PAD Indicator Light and the Airbag Warning Light are illuminated to show that the passenger airbag is turned off until the fault is cleared. If an object is lodged

under the seat and interferes with operation of the weight sensors, a fault will occur which turns on both the PAD Indicator Light and the Airbag Warning Light. Once the lodged object is removed, the fault will be automatically cleared after a short period of time.



Passenger Airbag Off Indicator

81321cb8

- The **Driver and Passenger Airbag/Inflator Units** are located in the center of the steering wheel and the right side of the instrument panel. When the ORC detects a collision requiring the airbags, it signals the inflator units. A large quantity of nontoxic gas is generated to inflate the front airbags. Different airbag inflation rates may be possible based on collision severity and occupant size. The steering wheel hub trim cover and the upper right side of the instrument panel separate and fold out of the way as the bags inflate to their full size. The bags fully inflate in about 50 - 70 milliseconds. This is about half of the time it takes to blink your eyes. The bags then quickly deflate while helping to restrain the driver and front passenger. The driver's front airbag gas is vented through vent holes in the sides of the airbag. The passenger's front airbag gas is vented through vent holes in the sides of the airbag. In this way the airbags do not interfere with your control of the vehicle.

- The **Occupant Classification Module (OCM)** is located beneath the front passenger seat. The OCM classifies the occupant into categories based on the measurements made by the seat weight sensors. The OCM communicates with the Occupant Restraint Controller (ORC). The ORC uses the occupant category to determine whether the front passenger airbag should be turned off. It also determines the rate of airbag inflation during a collision.
- The **Passenger Airbag Disabled (PAD) Indicator Light** indicates to the driver and passenger when the airbag is turned OFF. In the presence of a properly seated occupant, when the PAD indicator light is illuminated, the airbag is OFF. Also, when the Occupant Classification System detects either an empty seat or a weight less than the predetermined threshold, the ORC will not illuminate the PAD indicator light even though the airbag is turned OFF.
- Your vehicle has four **Weight Sensors** located between the seat and the floor pan. The weight sensors measure applied weight and transfers that information to the OCM.
- The **Side Impact SRS Window Bags** are designed to activate only in certain side collisions. When the ORC (with side impact option) detects a collision requiring the window bags to inflate, it signals the inflators on the crash side of the vehicle. A quantity of nontoxic gas is generated to inflate the window bag. The inflating window bag pushes the outside edge of the headliner out of the way and covers the window. The airbag inflates in about 30 milliseconds (about one quarter of the time it takes to blink your eyes) with enough force to injure you if you are not belted and seated properly, or if items are positioned in the area where the window bag inflates. This especially applies to children. The window bag is only about 3-1/2 inches (9 cm) thick when it is inflated.

- The **Knee Impact Bolsters** help protect the knees of the driver and the front passenger, and position everyone for the best interaction with the front airbag.

If A Deployment Occurs

The airbag system is designed to deploy the airbags when the impact sensors detect a moderate-to-severe frontal collision, to help restrain the driver and front passenger, and then immediately deflate.

NOTE: A frontal collision that is not severe enough to need airbag protection will not activate the system. This does not mean something is wrong with the airbag system.

If you do have a collision which deploys the airbags, any or all of the following may occur:

- The nylon airbag material may sometimes cause abrasions and/or skin reddening to the driver and front passenger as the airbags deploy and unfold. The

abrasions are similar to friction rope burns or those you might get sliding along a carpet or gymnasium floor. They are not caused by contact with chemicals. They are not permanent and normally heal quickly. However, if you haven't healed significantly within a few days, or if you have any blistering, see your doctor immediately. As the airbags deflate you may see some smoke-like particles. The particles are a normal by-product of the process that generates the nontoxic gas used for airbag inflation. These airborne particles may irritate the skin, eyes, nose, or throat. If you have skin or eye irritation, rinse the area with cool water. For nose or throat irritation, move to fresh air. If the irritation continues, see your doctor. If these particles settle on your clothing, follow the garment manufacturer's instructions for cleaning.

- It is not advisable to drive your vehicle after the airbags have deployed. If you are involved in another collision, the airbags will not be in place to protect you.

WARNING!

Deployed airbags and seat belt pretensioners cannot protect you in another collision. Have the airbags, seat belt pretensioners, and the front passenger seat belt retractor assembly, replaced by an authorized dealer as soon as possible. Also, have the Occupant Classification System serviced as well.

Maintaining Your Airbag System

WARNING!

- Modifications to any part of the airbag system could cause it to fail when you need it. You could be injured if the airbag system is not there to protect you. Do not modify the components or wiring, including adding any kind of badges or stickers to the steering wheel hub trim cover or the upper right side of the instrument panel. Do not modify the front bumper, vehicle body structure, or add aftermarket side steps or running boards.
- Do not attempt to modify any part of your advanced airbag system. The airbag may inflate accidentally or may not function properly if modifications are made. Take your vehicle to an authorized dealer for any advanced airbag system service. If your seat including your trim cover and cushion needs to be serviced in any way (including removal or loosening/tightening of seat attachment bolts), take the vehicle to your authorized dealer. Only manufacturer approved seat accessories may be used. If it is necessary to modify an advanced airbag system for persons with disabilities, contact your authorized dealer.
- Do not place or hang any items such as add-on video players on the right front passenger seat back. The additional weight may cause the Occupant Classification System to be unable to correctly classify the right front occupant. This could allow the passenger frontal airbag to inflate when it is not desired.
- You need proper knee impact protection in a collision. Do not mount or locate any aftermarket equipment on or behind the knee bolsters.
- It is dangerous to try to repair any part of the airbag system yourself. Be sure to tell anyone who works on your vehicle that it has an airbag system.

Enhanced Accident Response System

If the airbags deploy after an impact and the electrical system remains functional, vehicles equipped with power door locks will unlock automatically. In addition, approximately 5 seconds after the vehicle has stopped moving, the interior lights will light until the ignition switch is turned off.

Airbag Light

You will want to have the airbags ready to inflate for your protection in an impact. While the airbag system is designed to be maintenance free, if any of the following occurs, have an authorized dealer service the system promptly:

- The airbag light does not come on or flickers during the 6 to 8 seconds when the ignition switch is first turned on.
- The light remains on or flickers after the 6 to 8 second interval.

- The light flickers or comes on and remains on while driving.

NOTE: If the speedometer, tachometer or any engine related gauges are not working, the airbag control module may also be disabled. The airbags may not be ready to inflate for your protection. Promptly check fuse block for blown fuses. Refer to the label located on the inside of the fuse block cover for the proper airbag fuses. See your dealer if the fuse is good.

Child Restraint

Everyone in your vehicle needs to be buckled up all the time - babies and children, too. Every state in the United States and all Canadian provinces require that small children ride in proper restraint systems. This is the law, and you can be prosecuted for ignoring it. Children 12 years and under should ride properly buckled up in a rear seat, if available. According to crash statistics, children are safer when properly restrained in the rear seats rather than in the front.

Infants and Small Children

There are different sizes and types of restraints for children from newborn size to the child almost large enough for an adult seat belt. Always check the child seat owner's manual to ensure you have the right seat for your child. Use the restraint that is correct for your child:

- This vehicle is not capable of accommodating the installation of a car bed used for carrying newborn babies at the right front passenger seat position. If a car bed must be used to transport a newborn baby, the car bed must be installed in the second seating row only.
- Safety experts recommend that children ride rearward-facing in the vehicle until they are at least one year old and weigh at least 20 lbs (9 kg). Two types of child restraints can be used rearward facing: infant carriers and "convertible" child seats.
- The infant carrier is only used rearward-facing in the vehicle. It is recommended for children who weigh up to about 20 lbs (9 kg). "Convertible" child seats can be used either rearward-facing or forward-facing in the vehicle. Convertible child seats often have a higher weight limit in the rearward-facing direction than infant carriers do, so they can be used rearward-facing by children who weigh more than 20 lbs (9 kg) but are less than one year old.
- Rearward-facing child seats must **NEVER** be used in the front seat of a vehicle with a front passenger airbag. An airbag deployment could cause severe injury or death to infants in this position.
- Children who weigh more than 20 lbs (9 kg) and who are older than one year can ride forward-facing in the vehicle. Forward-facing child seats and convertible child seats used in the forward-facing direction are for children who weigh 20 to 40 lbs (9 to 18 kg), and are older than one year old. These child seats are also held in the vehicle by the lap/shoulder belt.

52 THINGS TO KNOW BEFORE STARTING YOUR VEHICLE

- The belt-positioning booster seat is for children weighing more than 40 lbs (18 kg), but who are still too small to fit the vehicle's seat belts properly. If the child cannot sit with knees bent over the seat cushion while the child's back is against the seatback, they need a belt-positioning booster seat. The child and booster seat are held in the vehicle by the lap/shoulder belt. (Some booster seats are equipped with a front shield and are held in the vehicle by the lap portion).
- For additional information, refer to www.seatcheck.org.

WARNING!

- **Improper installation can lead to failure of an infant or child restraint. It could come loose in a collision. The child could be badly injured or killed. Follow the manufacturer's directions exactly when installing an infant or child restraint.**
- **A rearward facing infant restraint should only be used in a rear seat. A rearward facing infant restraint in the front seat may be struck by a deploying passenger airbag which may cause severe or fatal to the infant.**

Here are some tips for getting the most out of your child restraint:

- Before buying any restraint system, make sure that it has a label certifying that it meets all applicable Safety

Standards. The manufacturer recommends that you try a child restraint in the vehicle seats where you will use it before you buy it.

- The restraint must be appropriate for your child's weight and height. Check the label on the restraint for weight and height limits.
- Carefully follow the instructions that come with the restraint. If you install the restraint improperly, it may not work when you need it.
- The second row outside seating positions and all third row seats have cinching latch plates. The second row center position has an adjustable locking retractor. These are designed to keep the lap portion tight around the child restraint so that it is not necessary to use a locking clip. If the seat belt has a cinching latch plate, pulling up on the shoulder portion of the lap/shoulder belt will tighten the belt. The cinching latch plate will keep the belt tight, however, any seat

belt system will loosen with time, so check the belt occasionally and pull it tight if necessary. If the seat belt has a automatic locking retractor, it will have a distinctive label. Pull the belt from the retractor until there is enough to allow you to pass through the child restraint and slide the latch plate into the buckle. Then, pull the belt until it is all extracted from the retractor. Allow the belt to return to the retractor, pulling on the excess webbing to tighten the lap portion about the child restraint. Refer to "Automatic Locking Mode" earlier in this section.

- Buckle the child into the restraint exactly as the manufacturer's instructions tell you.
- When your child restraint is not in use, secure it in the vehicle with the seat belt or remove it from the vehicle. Do not leave it loose in the vehicle. In a sudden stop or collision, it could strike the occupants or seat backs and cause serious personal injury.

LATCH - Child Seat Anchorage System (Lower Anchors and Tether for Children)

Your vehicle's second row seat is equipped with the child restraint anchorage system called LATCH. The LATCH system provides for the installation of the child restraint without using the vehicle's seat belts, instead securing the child restraint using lower anchorages and upper tether straps from the child restraint to the vehicle structure. LATCH-compatible child restraint systems are now available. However, because the lower anchorages are to be introduced over a period of years, child restraint systems having attachments for those anchorages will continue to also have features for installation using the vehicle's seat belts. Child restraints having tether straps and hooks for connection to the top tether anchorages have been available for some time. For some older child restraints, many child restraint manufacturers offer

add-on tether strap kits or retro-fit kits. You are urged to take advantage of all the available attachments provided with your child restraint in any vehicle.

The outboard second row seating positions have lower anchorages that are capable of accommodating LATCH-compatible child seats. **NEVER** install LATCH-compatible child seats such that two seats share a common lower anchorage. If installing child seats in adjacent seating positions or if your child restraints are not LATCH-compatible, install the restraints using the vehicle's seat belts.

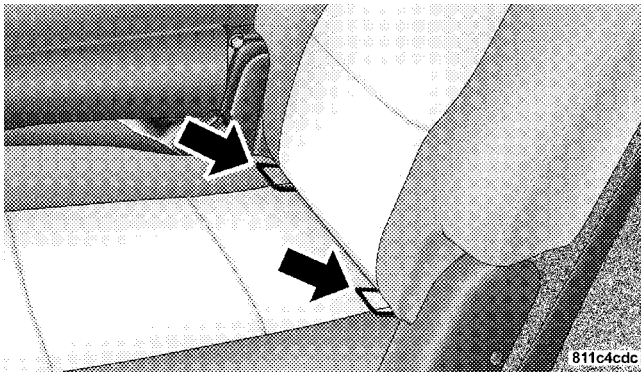

Second Row Left Side

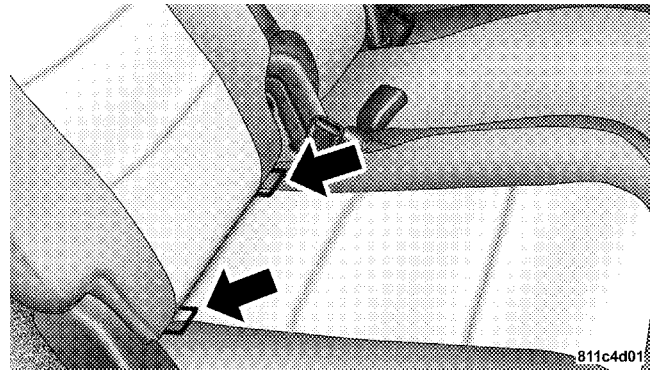

Second Row Right Side

Installing the LATCH-Compatible Child Restraint System

We urge that you carefully follow the directions of the manufacturer when installing your child restraint. Not all child restraint systems will be installed as described here. Again, carefully follow the installation instructions that

were provided with the child restraint system. The rear seat lower anchorages are round bars, located at the rear of the seat cushion where it meets the seat back, and are just visible when you lean into the rear seat to install the child restraint. You will easily feel them if you run your finger along the intersection of the seatback and seat cushion surfaces. In addition, there are tether strap anchorages behind each second row seating position located on the back of the seat. Many, but not all restraint systems will be equipped with separate straps on each side, with each having a hook or connector for attachment to the lower anchorage and a means of adjusting the tension in the strap. Forward-facing toddler restraints and some rear-facing infant restraints will also be equipped with a tether strap, a hook for attachment to the tether strap anchorage and a means of adjusting the tension of the strap. You will first loosen the adjusters on the lower straps and on the tether strap so that you can more easily attach the hooks or connectors to the vehicle

anchorages. Next attach the lower hooks or connectors over the top of the anchorage bars, pushing aside the seat cover material. Then attach the tether strap to the anchorage located on the back of the seat, being careful to route the tether strap to provide the most direct path between the anchor and the child restraint. If your vehicle is equipped with adjustable rear head restraints, raise the head restraint and, route the tether strap under the head restraint and between the two posts. Finally, tighten all three straps as you push the child restraint rearward and downward into the seat, removing slack in the straps according to the child restraint manufacturer's instructions.

WARNING!

Improper installation of a child restraint to the LATCH anchorages can lead to failure of an infant or child restraint. The child could be badly injured or killed. Follow the manufacturer's directions exactly when installing an infant or child restraint.

Installing Child Restraints Using the Vehicle Seat Belt

The passenger seat belts are equipped with either cinching latch plates or automatic locking retractors, which are designed to keep the lap portion tight around the child restraint so that it should not be necessary to use a locking clip. If the seat belt has a cinching latch plate, pulling up on the shoulder portion of the lap/shoulder belt will tighten the belt. The cinching latch plate will keep the belt tight, however, any seat belt system will loosen with time, so check the belt occasionally and pull

it tight if necessary. If the seat belt has an automatic locking retractor, it will have a distinctive label. Pull the belt from the retractor until there is enough to allow you to pass through the child restraint and slide the latch plate into the buckle. Then, pull the belt until it is all extracted from the retractor. Allow the belt to return to the retractor, pulling on the excess webbing to tighten the lap portion about the child restraint. For automatic locking retractor seat belts, refer to "Automatic Locking Mode" earlier in this section. If you have trouble tightening the lap/shoulder belt on the child restraint because the buckle or latch plate is too close to the belt path opening on the restraint, follow these steps. If the buckle is webbing mounted, disconnect the latch plate from the buckle and twist the short buckle-end belt to shorten it. Insert the latch plate into the buckle with the release button facing out. If the belt still can't be tightened, the buckle is not webbing mounted, or if by pulling and pushing on the restraint loosens the belt, you may need

to do something more. Disconnect the latch plate from the buckle, turn the latch plate around, and insert the latch plate into the buckle again. If you still can't make the child restraint secure, try a different seating position or use the locking clip provided with your child restraint.

To attach a child restraint tether strap: Route the tether strap over the seat back, between the head restraint posts and attach the hook to the tether anchor located on the back of the seat.

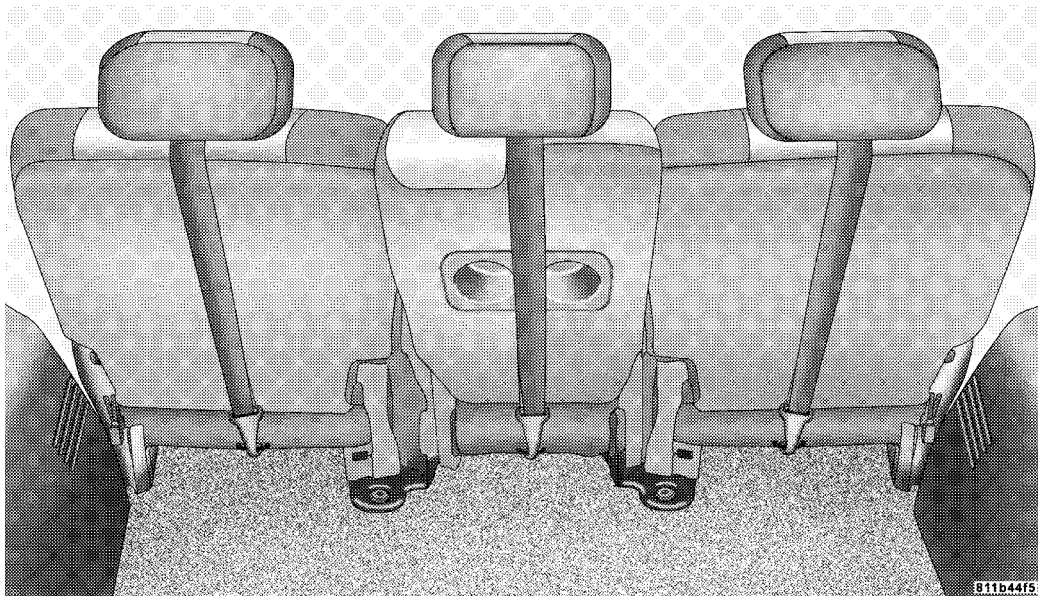

Second Row Seat

Child Restraints in Third Row Seating (If Equipped)

The third seating row is not capable of installing child restraints that require the use of a tether strap. There are no tether anchor provisions for the third seating row in your vehicle, the hooks in the rear floor are not designed to withstand the forces that may occur during a crash.

WARNING!

An incorrectly anchored tether strap could lead to increased head motion and possible injury to the child. Use only the anchor positions directly behind the child seat to secure a child restraint top tether strap. Do not install a child restraint that requires a tether strap in the third seating row (if equipped) of this vehicle.

Child Restraint Tether Anchor

There are tether strap anchorages behind each seating position in the second row. For vehicles equipped with third row seating, there is no Child Tether Anchorage provided for the third row of seats. To install child restraint tethers follow these instructions.

1. Place the child restraint in the second row of seats.
2. Route the tether strap under the head restraint and between the two posts.
3. Attach the tether strap hook of the child restraint to the tether anchor located on the seat back and remove the slack in the tether strap according to the manufacturer's instructions.

WARNING!

An incorrectly anchored tether strap could lead to seat failure and injury to the child. In a collision, the seat could come loose and allow the child to crash into the inside of the vehicle or other passengers, or even be thrown from the vehicle. Use only the anchor positions directly behind the child seat to secure a child restraint top tether strap. Follow the instructions below. See your dealer for help if necessary.

Children Too Large for Booster Seats

Children who are large enough to wear the shoulder belt comfortably, and whose legs are long enough to bend over the front of the seat when their back is against the seat back should use the lap/shoulder belt in a rear seat.

- Make sure that the child is upright in the seat.

- The lap portion should be low on the hips and as snug as possible.
- Check belt fit periodically. A child's squirming or slouching can move the belt out of position.
- If the shoulder belt contacts the face or neck, move the child closer to the center of the vehicle. Never allow a child to put the shoulder belt under an arm.

Transporting Pets

Airbags deploying in the front seat could harm your pet. An unrestrained pet will be thrown about and possibly injured, or injure a passenger during panic braking or in a collision. Pets should be restrained in the rear seat in pet harnesses or pet carriers that are secured by seat belts.

ENGINE BREAK-IN RECOMMENDATIONS

A long break-in period is not required for the engine in your new vehicle. Drive moderately during the first 300 miles (500 km). After the initial 60 miles (100 km), speeds up to 50 or 55 mph (80 or 90 km/h) are desirable. While cruising, brief full-throttle acceleration, within the limits of local traffic laws, contributes to a good break-in.

Avoid wide open throttle acceleration in low gear.

The engine oil installed in the engine at the factory is a high-quality, energy-conserving type lubricant. Oil changes should be consistent with anticipated climate conditions under which vehicle operations will occur. The recommended viscosity and quality grades are shown in Section 7.

NON-DETERGENT OR STRAIGHT MINERAL OILS MUST NEVER BE USED.

A new engine may consume some oil during its first few thousand miles of operation. This is a normal part of the break-in and is not an indication of difficulty.

SAFETY TIPS

Exhaust System

WARNING!

Exhaust gases contain carbon monoxide, an extremely toxic gas that by itself is colorless and odorless. To avoid inhaling these gases, the following precautions should be observed:

- Do not run the engine in a closed garage or in confined areas any longer than needed to move your vehicle in or out of the area.

- It may be necessary to sit in a parked vehicle with the engine running for more than a short period. If so, adjust your climate control system to force outside air into the vehicle. Set the blower at high speed and the controls in any position except OFF or RECIRC.
- The best protection against carbon monoxide entry into the vehicle body is a properly maintained engine exhaust system.

Be aware of changes in the sound of the exhaust system; exhaust fumes detected inside the vehicle; or damage to the underside or rear of the vehicle. Have a competent mechanic inspect the complete exhaust system and adjacent body areas for broken, damaged, deteriorated or mispositioned parts. Open seams or loose connections could permit exhaust fumes to seep into the passenger compartment. In addition, inspect the exhaust system each time the vehicle is raised for lubrication or oil change. Replace or adjust as required.

Safety Checks You Should Make Inside The Vehicle

Seat Belts

Inspect the belt system periodically, checking for cuts, frays and loose parts. Damaged parts must be replaced immediately. Do not disassemble or modify the system.

Seat belt assemblies must be replaced after an accident if they have been damaged (bent retractor, torn webbing, etc.). If there is any question regarding belt or retractor condition, replace the belt.

Defrosters

Check operation by selecting the defrost mode and place the blower control on high speed. You can feel the air directed against the windshield.

Safety Checks You Should Make Outside The Vehicle:

Tires

Examine tires for tread wear or uneven wear patterns. Check for stones, nails, glass or other objects lodged in the tread.

Inspect for tread cuts or sidewall cracks. Check wheel nuts for tightness and tires for proper pressure.

Lights

Have someone observe the operation of exterior lights as you turn them on. Check turn signal and high beam indicator lights on the instrument panel.

Door Latches

Check for positive closing, latching and locking.

Fluid Leaks

Check the area under vehicle after overnight parking for fuel, water, oil, or other fluid leaks. Also, if gasoline fumes are detected, the cause should be located and corrected.

UNDERSTANDING THE FEATURES OF YOUR VEHICLE

CONTENTS

■ Mirrors70	□ Automatic Dimming Driver's Exterior Mirror — If Equipped74
□ Inside Day/Night Mirror70	■ Hands-Free Communication (UConnect™) — If Equipped74
□ Automatic Dimming Mirror — If Equipped70	□ Operation76
□ Outside Mirrors71	□ Phone Call Features80
□ Exterior Mirrors Folding Feature — If Equipped71	□ Advanced Phone Connectivity82
□ Electric Remote-Control Mirrors72	□ UConnect™ System Features83
□ Illuminated Vanity Mirrors — If Equipped73	■ Seats86
□ Heated Mirrors — If Equipped73	□ Front Seat Manual Seat Adjustment86

66 UNDERSTANDING THE FEATURES OF YOUR VEHICLE

<input type="checkbox"/> Front Seats Manual Seat Recliners87	<input type="checkbox"/> Setting Memory Positions And Linking Remote Keyless Entry Transmitter To Memory98
<input type="checkbox"/> Manual Lumbar Support Adjustment — If Equipped88	<input type="checkbox"/> Memory Position Recall99
<input type="checkbox"/> Adjustable Head Restraints — All Seating Positions88	<input type="checkbox"/> To Disable A Transmitter Linked To Memory . .	100
<input type="checkbox"/> 8 - Way Driver's Power Seat — If Equipped89	<input type="checkbox"/> Self-Limiting Control	100
<input type="checkbox"/> 4 - Way Passenger's Power Seat — If Equipped89	<input type="checkbox"/> Driver Easy Exit And Easy Entry Control	101
<input type="checkbox"/> Front Heated Seats — If Equipped90	<input type="checkbox"/> Tilt Mirrors In Reverse	101
<input type="checkbox"/> Second Row 40/20/40 Seat — Fold And Tumble91	■ To Open And Close The Hood	102
<input type="checkbox"/> Third Row Seat Bench — If Equipped93	■ Lights	103
<input type="checkbox"/> Third Seat 50/50 Split Seat — If Equipped96	<input type="checkbox"/> Interior Lights	104
■ Driver Memory System — If Equipped97	<input type="checkbox"/> Battery Saver	105
		<input type="checkbox"/> Headlight Delay	106
		<input type="checkbox"/> Automatic Headlights — If Equipped	106

<ul style="list-style-type: none"> <input type="checkbox"/> Headlights, Parking Lights, Panel Lights 106 <input type="checkbox"/> Illuminated Entry 107 <input type="checkbox"/> Daytime Running Lights (Canada Only) 107 <input type="checkbox"/> Lights-On Reminder 107 <input type="checkbox"/> Fog Lights — If Equipped 107 ■ Multifunction Control Lever 108 <ul style="list-style-type: none"> <input type="checkbox"/> Turn Signals 108 <input type="checkbox"/> Passing Light 109 <input type="checkbox"/> High Beam / Low Beam Select Switch 109 <input type="checkbox"/> Windshield Wipers 110 <input type="checkbox"/> Windshield Washers 111 ■ Traction Control Switch — If Equipped 112 ■ Tilt Steering Column 113 	<ul style="list-style-type: none"> ■ Driver Adjustable Pedals — If Equipped 114 <ul style="list-style-type: none"> <input type="checkbox"/> Adjustment 115 ■ Electronic Speed Control — If Equipped 116 <ul style="list-style-type: none"> <input type="checkbox"/> To Activate 116 <input type="checkbox"/> To Set At A Desired Speed 116 <input type="checkbox"/> To Deactivate 116 <input type="checkbox"/> To Resume Speed 117 <input type="checkbox"/> To Vary The Speed Setting 117 <input type="checkbox"/> To Accelerate For Passing 118 ■ Overhead Console 119 <ul style="list-style-type: none"> <input type="checkbox"/> Courtesy/Reading Lights 120 ■ Compass/Temperature Mini-Trip Computer 120 <ul style="list-style-type: none"> <input type="checkbox"/> US/M Button 120
---	---

68 UNDERSTANDING THE FEATURES OF YOUR VEHICLE

□ Reset Button	121	■ Garage Door Opener — If Equipped	126
□ Global Reset	121	□ Programming Homelink	128
□ Step Button	122	□ Canadian Programming/Gate Programming . .	130
□ Average Fuel Economy (AVG ECO)	122	□ Using Homelink	131
□ Distance To Empty (DTE)	122	□ Erasing Homelink Buttons	131
□ Trip Odometer (ODO)	123	□ Reprogramming a Single Homelink Button . . .	132
□ Elapsed Time (ET)	123	□ Security	132
□ C/T Button	123	■ Power Sunroof — If Equipped	133
□ Compass/Temperature Display	124	□ Express Open Feature	133
□ Automatic Compass Calibration	124	□ Wind Buffeting	134
□ Manual Compass Calibration	124	□ Sunroof Maintenance	135
□ To Put Into a Calibration Mode	124	■ Electrical Power Outlets	135
□ Outside Temperature	126		

<input type="checkbox"/> Electrical Outlet Use With Engine Off (Battery Fed Configuration)	136	<input type="checkbox"/> Floor Console Features	137
<input checked="" type="checkbox"/> Floor Console	137	<input checked="" type="checkbox"/> Factory Installed Roof Luggage Rack— If Equipped	139

MIRRORS

Inside Day/Night Mirror

The mirror should be adjusted to center on the view through the rear window. A two-point pivot system allows for horizontal and vertical adjustment of the mirror.

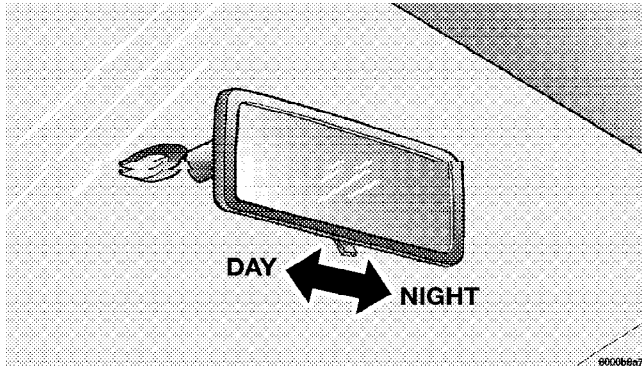

Annoying headlight glare can be reduced by moving the small control under the mirror to the night position (toward rear of truck). The mirror should be adjusted while set in the day position (toward windshield).

Automatic Dimming Mirror — If Equipped

This mirror will automatically adjust for annoying headlight glare from vehicles behind you. You can turn the feature on or off by pressing the button at the base of the mirror. A light in the button will indicate when the dimming feature is activated. This option also controls the driver's side mirror when it is equipped with auto dimming glass.

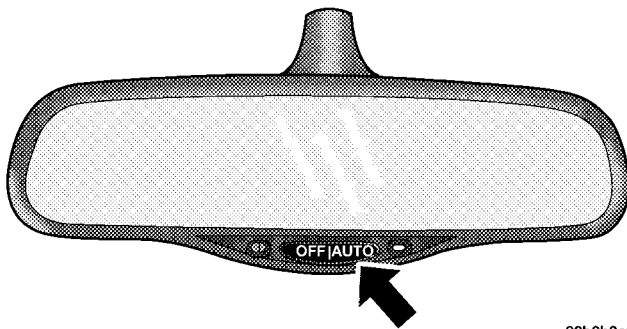

80b6b3a6

CAUTION!

To avoid damage to the mirror during cleaning, never spray any cleaning solution directly onto the mirror. Apply the solution onto a clean cloth and wipe the mirror clean.

Outside Mirrors

To receive maximum benefit, adjust the outside mirror(s) to center on the adjacent lane of traffic with a slight overlap of the view obtained on the inside mirror.

Exterior Mirrors Folding Feature — If Equipped

Folding exterior mirrors are hinged and may be moved either forward or rearward to resist damage.

Electric Remote-Control Mirrors

The controls for the power mirrors are located on the driver's door trim panel.

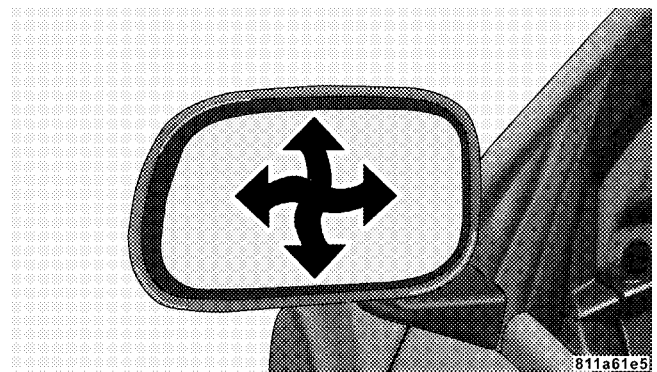
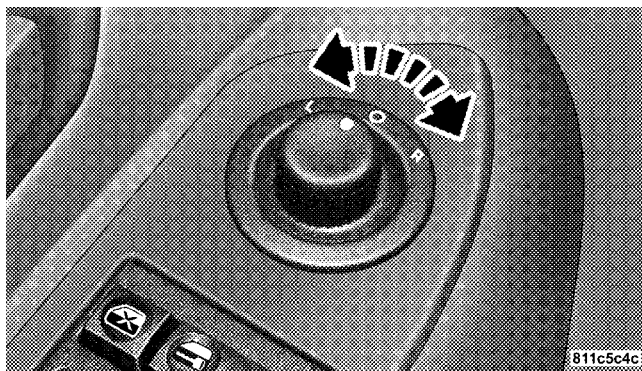

To adjust a mirror, turn the control wand toward the left or right mirror positions indicated. Tilt the control wand in the direction you want the mirror to move. When you are finished adjusting the mirror, turn the control to the center position to prevent accidentally moving a mirror.

WARNING!

Vehicles and other objects seen in the right side convex mirror will look smaller and farther away than they really are. Relying too much on your right side mirror could cause you to collide with another vehicle or other object. Use your inside mirror when judging the size or distance of a vehicle seen in the right side mirror.

Illuminated Vanity Mirrors — If Equipped

An illuminated vanity mirror is on each sun visor. To use the mirror, rotate the sun visor down and swing the mirror cover upward. The lights will turn on automatically. Closing the mirror cover turns off the light.

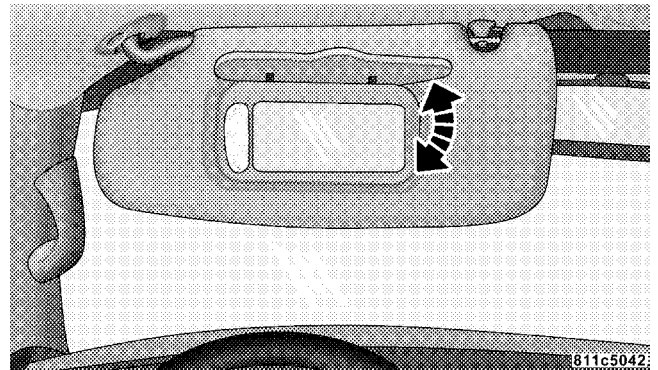
**Heated Mirrors — If Equipped**

Heated mirrors are automatically activated when you depress the rear window defroster switch located on the instrument panel. The light will illuminate to indicate that the heating elements are ON. Turning OFF the ignition will deactivate the heated mirrors.

Automatic Dimming Driver's Exterior Mirror — If Equipped

This mirror will automatically adjust for annoying light glare from vehicles behind you. This feature is controlled by the inside mirror and can be turned off by pressing the button at the base of the inside mirror.

HANDS-FREE COMMUNICATION (UConnect™) — IF EQUIPPED

UConnect™ is a voice-activated, hands-free, in-vehicle communications system. UConnect™; allows you to dial your cellular phone using simple voice commands (e.g., "Call" or "Dial"). Your cellular phone's audio is transmitted through your vehicle's stereo system; the system will automatically mute your radio before receiving or sending a call.

UConnect™ allows you to transfer calls between the system and your cellular phone as you enter or exit your vehicle, and enables you to mute the system's microphone for private conversations.

The UConnect™; phone book enables you to store up to 32 names and four numbers per name. This system is driven through your Bluetooth™ Hands-Free Profile cellular phone. UConnect™ features Bluetooth™ technology - the global standard that enables different electronic devices to connect to each other without wires or a docking station, so UConnect™ works no matter where you stow your cellular phone (be it your purse, pocket, or briefcase). UConnect™ allows up to seven cellular phones to be linked to the system, and it is available in English, French, or Spanish formats (as equipped).

The rearview mirror contains the microphone for the system and the control buttons that will enable you to

access the system. The diagram below shows the mirror with the appropriate buttons. Individual button behavior is discussed in the “Operation” Section.

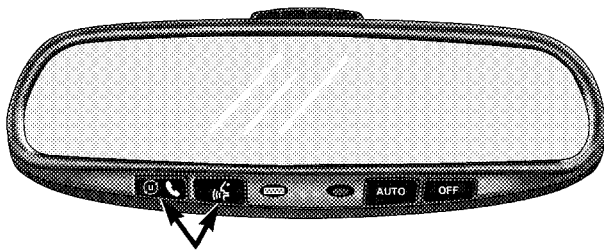

8105b20d

The UConnect™ system can be used with any Hands Free Profile certified Bluetooth™ cellular phone. If your cellular phone has a different profile (i.e. headset profile), you will not be able to use any UConnect™ features.

The UConnect™ system is fully integrated into your vehicle, including your vehicle’s stereo system. All voice prompts as well as the other party’s voice in a conversation will be played over your vehicle’s stereo system. The volume of the UConnect™ system can be controlled through your normal stereo controls.

The radio display will be used for visual prompts from the UConnect™ system such as caller ID.

Operation

Voice commands can be used in the operation of the UConnect™ system and to navigate through the UConnect™ menu structure. Voice commands should be given after each UConnect™ system prompt. You will be prompted for a specific command and then guided through the available options. There are two ways to give commands to the UConnect™ system:

- You can say "Dial" at the "Ready" prompt. When prompted for the phone number you wish to dial, say the phone number ("123 456 7890").

Pairing a Cellular Phone to the UConnect™ System

To begin using your UConnect™ system, you must pair your compatible Bluetooth™ enabled cellular phone. To complete the registration process, you will need to reference your cellular phone owner's manual.

- Press the 'Phone' button to begin.

- After the "Ready" prompt, say "Setup".
- When prompted, say " Phone Pairing".
- You will be asked to say a four-digit pin number into the UConnect™ system which you will later need to enter into your cellular phone during the cellular phone pairing process. You can enter any four-digit pin number. You will not need to remember this pin number after the initial registration process.
- The UConnect™ system will then prompt you to begin the cellular phone pairing process on your cellular phone. Please see your cellular phone user's manual for instructions on how to complete this step.
- For identification purposes, you will be prompted to give the UConnect™ system a name for your cellular phone. Each cellular phone that is paired should be given a unique phone name.

- You will then be asked to give your cellular phone a priority level between 1 and 7, 1 having the highest priority. You can connect up to seven cellular phones to your UConnect™ system and the priority allows the UConnect™ system to know which cellular phone to use if multiple cellular phones are in the vehicle at the same time. For example, if a priority 3 and priority 5 cellular phone are both in the vehicle, the UConnect™ system will use the priority 3 cellular phone when you make a call. You can select to use a lower priority cellular phone at any time.

Making a Phone Call Using Digit Dialing

- Press the 'Phone' button to begin.
- After the "Ready" prompt, say "Dial" or "Call" followed by the phone number you wish to dial. For example, you can say "Dial" wait for ready prompt 123 456 7890. The phone number that you enter must be a valid length.

Making a Phone Call Using Your UConnect™ Phonebook

- Press the "Phone" button to begin.
- After the "Ready" prompt, say "Dial" or "Call" wait for the ready prompt followed by the name and designation of a phonebook entry that you wish to dial. For example, you can say "Call John Doe Work".

Add Names to Your UConnect™ Phonebook

- Press the "Phone" button to begin.
- After the "Ready" prompt, say "Phonebook New Entry".
- Or, After the "Ready" prompt, say "Phonebook".
- When prompted, say "New Entry".
- When prompted, say the name of the new entry.

- Next, enter the number designation (e.g. “Home”, “Work”, “Mobile”, or “Pager”). This will allow you to have multiple numbers for each phonebook entry.
- Recite the phone number for the phonebook entry that you are adding.

After you are finished adding an entry into the phonebook, you will be given the opportunity to add more phone numbers to the current entry or to return to the main menu.

The UConnect™ system will allow you to enter up to 32 names into the phonebook with each name having up to four associated phone numbers and designations.

Edit Entries in the UConnect™ Phonebook

- Press the 'Phone' button to begin.
- After the "Ready" prompt, say "Phonebook Edit".

- You will then be asked for the name of the phonebook entry that you wish to edit.
- Next, choose the number designation that you wish to edit. The choices are home, work, mobile, or pager.
- Recite the new phone number for the phonebook entry that you are editing.

After you are finished editing an entry in the phonebook, you will be given the opportunities to edit another entry in the phonebook, call the number you just edited, or return to the main menu.

Phonebook edit can be used to add another phone number to a name entry that already exists in the phonebook. For example, the entry John Doe may have a mobile and a home number, but you can add John Doe's work number later through phonebook edit.

Delete Entries in the UConnect™ Phonebook

- Press the 'Phone' button to begin.
- After the "Ready" prompt, say "Phonebook Delete".
- After you enter the phonebook delete menu, you will then be asked for the name of the phonebook entry that you wish to delete. You can either say the name of a phonebook entry that you wish to delete or you can say "List Names" to hear a list of the entries in the phonebook from which you can choose. To select one of the entries from the list, press the "Voice Recognition" button while the UConnect™ system is playing the desired entry and say "Delete".
- After you enter the name, the UConnect™ system will ask you if you wish to delete the home, work, mobile, or pager number for this entry.

Delete All Entries in the UConnect™ Phonebook

- Press the 'Phone' button to begin.
- After the "Ready" prompt, say "Phonebook Delete All".
- The UConnect™ system will ask you to verify that you wish to delete all the entries from the phonebook.
- After confirmation, the phonebook entries will be deleted.

List All Names in the UConnect™ Phonebook

- Press the 'Phone' button to begin.
- After the "Ready" prompt, say "Phonebook List Names".
- The UConnect™ system will play the names of all the phonebook entries.

- To call one of the names in the list, press the 'Voice Recognition' button during the playing of the desired name and say "Call".
- The UConnect™ system will then prompt you as to number designation you wish to call.
- The selected number will be dialed.

Phone Call Features

The following feature(s) can be accessed through the UConnect™ system if the feature(s) are available on your cellular service plan. For example, if your cellular service plan provides three-way calling, this feature can be accessed through the UConnect™ system.

Answer or Reject an Incoming Call - No Call Currently in Progress

When you receive a call on your cellular phone, the UConnect™ system will interrupt the stereo audio and will ask if you would like to answer the call by pressing

the 'Phone' button. Press the 'Phone' button to answer the call. To reject the call, press the 'Phone' button until you hear a single beep indicating that the incoming call was rejected.

Answer or Reject an Incoming Call - Call Currently in Progress

If a call is currently in progress and you have another incoming call, press the 'Phone' button to place the current call on hold and answer the incoming call. To reject the incoming call, you can disregard the call and continue with your current conversation.

Making a Second Call while Current Call in Progress

To make a second call while you are currently in a call, press the 'Voice Recognition' button and say "Dial" or "Call" followed by the phone number or phonebook entry you wish to call. The first call will be on hold while the second call is in progress.

Putting a Call on Hold and Retrieving a Call from Hold

To put a call on hold, press the 'Phone' button until you hear a single beep which will indicate that the call has been placed on hold. To bring the call back from hold, press the 'Phone' button.

Toggling Between Two Calls

If two calls are in progress (one active and one on hold), press the 'Phone' button until you hear a single beep indicating that the active and hold status of the two calls have switched. Only one call can be placed on hold at one time.

Conference Call

When two calls are in progress (one active and one on hold), press the 'Phone' button until you hear a double beep indicating that the two calls have been joined into one conference call.

Three-Way Calling

To initiate three-way calling, press the 'Voice Recognition' button while a call is in progress and make a second phone call. When the second call is established, press the 'Phone' button until you hear a double beep indicating that the two calls have been joined into one conference call.

Call Termination

To end a call in progress, press the 'Phone' button. All calls in progress will be terminated.

Phone Redial

- Press the 'Phone' button to begin.
- After the "Ready" prompt, say "Redial".
- The UConnect™ system will call the last number that was dialed on your cellular phone. This may not be the last number dialed by your UConnect™ system.

Advanced Phone Connectivity

Transferring an Active Call between the UConnect™ System and Your Cellular Phone

The UConnect™ system allows ongoing calls to be transferred to your cellular phone or to the UConnect™ system without terminating the call. To transfer an ongoing call from your cellular phone to the UConnect™ system or vice versa, press the 'Voice Recognition' button and say "Transfer Call".

Delete Paired Cellular Phones

- Press the 'Phone' button to begin.
- After the "Ready" prompt, say "Setup".
- When prompted, say " Phone Pairing".

- At the next prompt, say "Delete".
- You will be asked to say the name of the phone that you wish to delete. You can either say the name of the phone that you wish to delete or you can say "All" to delete all the phones.

Connect or Disconnect the Connection between the UConnect™ System and Your Cellular Phone

Your cellular phone can be paired with many different electronic devices, but can only be actively "connected" with one electronic device at a time.

If you would like to connect or disconnect the Bluetooth™ connection between a paired cellular phone and the UConnect™ system, follow the instruction described in your cellular phone user's manual.

List Paired Cellular Phone Names

- Press the 'Phone' button to begin.
- After the "Ready" prompt, say "Setup List Phones" and the UConnect™ system will play the phone names of all paired cellular phones in order from highest priority to lowest priority.

Select a Lower Priority Paired Cellular Phone

- Press the 'Phone' button to begin.
- After the "Ready" prompt, say "Setup".
- When prompted, say "Select Phone".
- When prompted, say the phone name of the cellular phone you wish to use, or say "List Phones" to hear a list of all the phones that have been paired to your UConnect™ system. To select a phone from the list, press the 'Voice Recognition' button and say "Select".

- The lower priority phone will only be used for the next phone call. After that, the UConnect™ system will return to using the highest priority phone in the vehicle.

UConnect™ System Features**Barge In - Touch Tone Phone Inputs**

You can use your UConnect™ system to access a voice mail system, an automated service, or any other phone number that you can dial with any phone. When calling a number with your UConnect™ system that normally requires you to enter in a touch-tone sequence on your cellular phone keypad, you can push the 'Voice Recognition' button and say the sequence you wish to enter followed by "Send". For example, if required to enter your pin number, you can press the 'Voice Recognition' button and say "3 7 4 6 Send", or whatever you have made your pin. This method can also be used in instances where you

are pressing a number on your keypad to navigate through a menu structure or to enter a number for a pager.

Barge In - Overriding Prompts

The 'Voice Recognition' button can be used when you wish to skip part of a prompt and issue your voice recognition command immediately. For example, if a prompt is playing "Would you like to pair a phone, clear a...", you could press the 'Voice Recognition' button and say "Pair A Phone" to select that option without having to listen to the rest of the voice prompt.

Language Selection

To change the language that the UConnect™ system is using, press the 'Phone' button and say the name of the language you wish to switch to (English, Español, or Français as equipped). After selecting one of the languages, all prompts and voice commands will be in the selected language.

Turning Confirmation Prompts On/Off

Turning confirmation prompts off will stop the system from confirming your choices (e.g. the UConnect™ system will not repeat a phone number before you dial it).

- Press the 'Phone' button to begin.
- After the "Ready" prompt, say "Setup Confirmation". The UConnect™ system will play the current confirmation prompt status and you will be given the choice to change it.

Low Signal, Battery Strength, and Roam Notification

The UConnect™ system will provide notification to inform you if your cellular phone is in roaming status, has low signal strength, or has a low battery when you are trying to place a phone call.

Dialing Using the Cellular Phone Keypad

You can dial a phone number with your cellular phone keypad and still use the UConnect™ system. By dialing a number with your paired Bluetooth™ cellular phone, the audio will be played through your vehicle's stereo system. The UConnect™ system will work the same as if you dialed the number using voice recognition.

Mute/Unmute

When you mute the UConnect™ system, you will still be able to hear the conversation coming from the other party, but the other party will not be able to hear you. In order to mute the UConnect™ system press the 'Voice Recognition' button and say "Mute". In order to unmute the UConnect™ system; press the 'Voice Recognition' button and say "Unmute".

Help

If you need assistance at any prompt or if you want to know what your options are at any prompt, say "Help". The UConnect™ system will play all the options at any prompt if you ask for help.

Cancel

At any prompt, you can say "Cancel" and you will be returned to the previous menu.

Emergency Assistance

If you are in an emergency, say "Dial Emergency" or "Call Emergency" and the UConnect™ system will instruct your cellular phone to call 911.

Towing Assistance

If you need towing assistance, say "Dial Towing Assistance" or "Call Towing Assistance". Please refer to the 24-Hour Towing Assistance coverage details in the DaimlerChrysler Motors Company 24-Hour Towing Assistance Program Guide.

SEATS

Front Seat Manual Seat Adjustment

The adjusting lever is at the front of the seat, near the floor. Lift the lever and move the seat to the desired position. Release the bar to lock the seat into position.

Using body pressure, move forward and rearward on the seat to be sure the seat adjusters have latched.

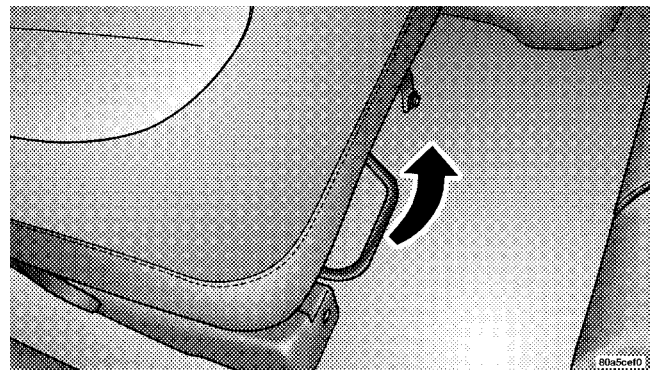

WARNING!

Adjusting a seat while the vehicle is moving is dangerous. The sudden movement of the seat could cause you to lose control. The seat belt might not be properly adjusted and you could be injured. Adjust any seat only while the vehicle is parked.

Front Seats Manual Seat Recliners

The bucket seats are equipped with recliners. The reclining mechanism is operated by a control located on the outboard side of the seat. To recline, lean forward slightly before lifting the lever, then push back to the desired position and release the lever. Lean forward and lift the lever to return the seatback to its normal position. Using body pressure, lean forward and rearward on the seat to be sure the seatback is locked.

WARNING!

Do not ride with the seatback reclined so that the shoulder belt is no longer resting against your chest. In a collision you could slide under the seat belt and be seriously or even fatally injured. Use the recliner only when the vehicle is parked.

Manual Lumbar Support Adjustment — If Equipped

The manual lumbar support adjustment lever is located on the right side of the driver's seat and on the left side of the passenger's seat. Moving the lumbar control lever fore and aft increases or decreases the lumbar support.

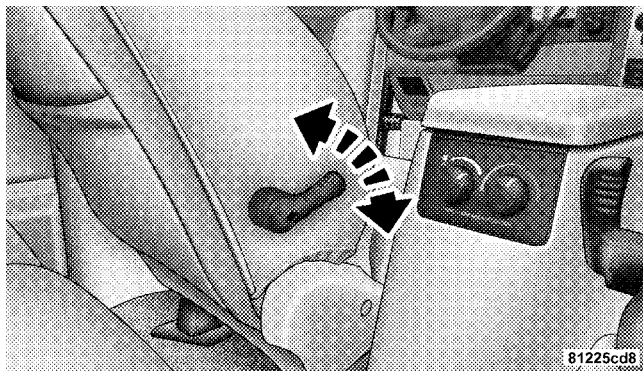

Adjustable Head Restraints — All Seating Positions

Head restraints can reduce the risk of whiplash injury in the event of impact from the rear. Pull up or push down on the restraints so that the upper edge is as high as practical, at least to the level of the ears.

To lower the head restraint, depress the release button located at the base of the head restraint and push down on the head restraint.

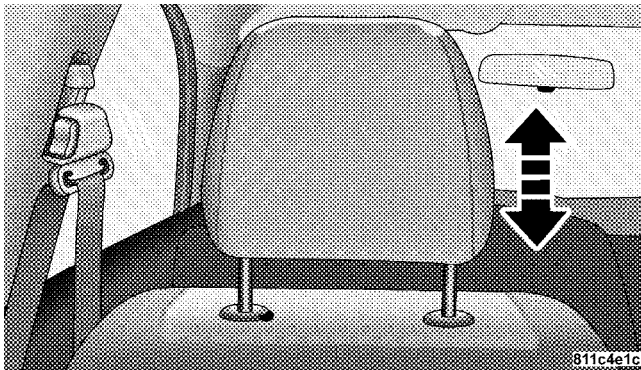

8 - Way Driver's Power Seat — If Equipped

The driver's power seat switches are located on the outboard side of the driver's seat lower side trim. The bottom switch controls up/down, forward/rearward, and tilt adjustment. The top switch controls the seatback recline adjustment.

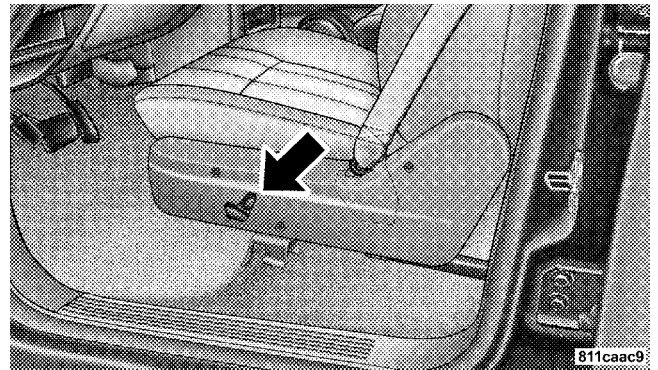

4 - Way Passenger's Power Seat — If Equipped

The front passenger's power seat switches are located on the outboard side of the passenger seat lower side trim. The bottom switch controls forward/rearward adjustment. The top switch controls the seatback recline adjustment.

NOTE: The 4 - way seat does not have an up/down adjustment.

Front Heated Seats — If Equipped

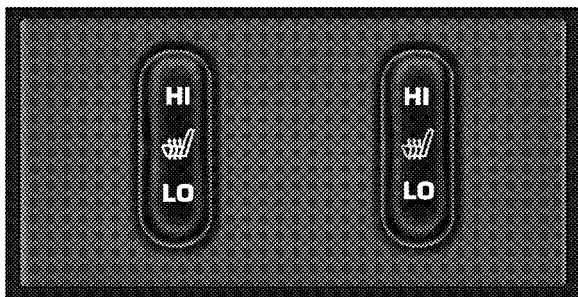

81228806

This feature heats the driver and front passenger seats. The controls for the front heated seats are located on the center of the instrument panel, below the climate controls. The heated seat system allows the driver and front

passenger to select from two different levels of supplemental electrical seat heating, or no seat heating to suit their individual comfort requirements.

With the ignition switch in the RUN position, depressing the heated seat switch rocker to its momentary High or Low position provides power to the heated seat element and maintains the requested temperature setting. If the heated seat switch is depressed to a different position (Low or High) than the currently selected state, the requested temperature setting will change to a new selection. If the heated seat switch is depressed a second time to the same position as the currently selected state, the seat heater will turn off.

NOTE: The high heat setting will operate for approximately a two hour duration. After two hours, the system will automatically transition to the low heat setting. The low heat setting will operate for a two hour duration,

then the system will turn off. Thus, a maximum of four hours of operation until the system is reactivated.

If the low heat setting is initially selected, the system will operate for two hours and then turn off.

If the indicator lamp on the heated seat switch does not light when the switch is depressed or if heated seats does not operate, the system should be serviced by a qualified technician.

Second Row 40/20/40 Seat — Fold and Tumble

The 40/20/40 seat configuration is standard on all models. This seat is equipped with a unique fold-and-tumble feature. The 40 % seatbacks have spring loaded hinges which assist with the folding of the seatbacks.

To fold the 40 % seats, operate the latches by a single lever on the outboard side of each seat. Upon raising the lever slowly, the seatback releases first, allowing the

seatbacks to fold with spring assistance. In this position, the back is horizontal and aligned to the rear floor.

Second row leather seats have seatback recliners at the 40% seating positions. Raising the lever allows the seatback to be reclined an additional 11degrees.

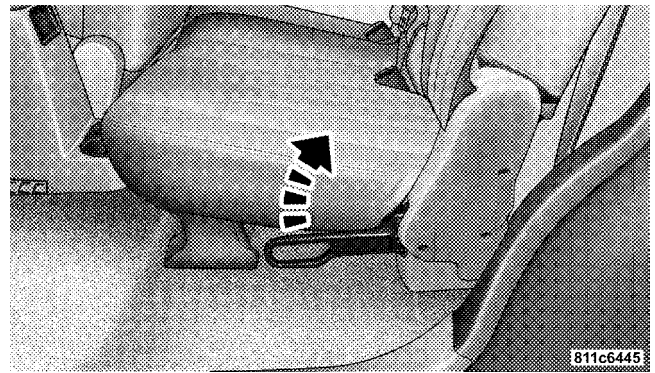



Raising the lever allows third row seat passengers to fold the seatbacks and release the latches when exiting the vehicle. Once the seatback is in a folded position continue raising the lever fully to release the cushion latches and tumble the seat. This folding and tumbling action provides easy access to the third row seat.

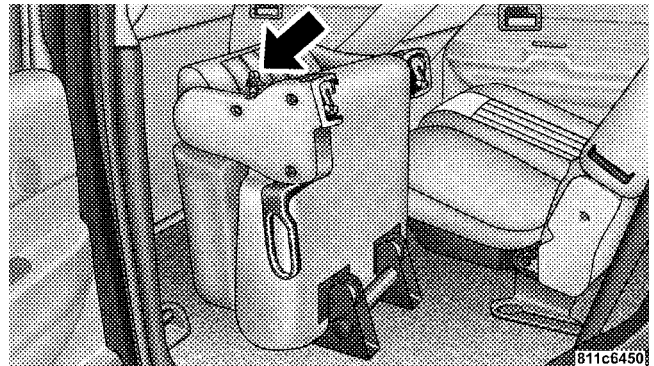

NOTE: The secondary lever on the rear of each cushion allows third row-seat passengers to release the latches and fold the seatbacks when exiting the vehicle.

NOTE: The head restraints must be lowered but do not have to be removed to fold and tumble the seats.

Third Row Seat Bench — If Equipped

To Fold The Seats

Folding the third seat occurs in two stages: the cushion is lifted and moved forward then the back is folded. Pull up and forward on either one of the 2 straps at the front of the cushion. The cushion rises on the ends of the U-shaped bracket that pivots on the floor underneath the cushion. If you continue to pull forward, the cushion drops back to the floor directly behind the second seat. Once the cushion has been moved forward, the seatback is free to fold forward flush with the floor.

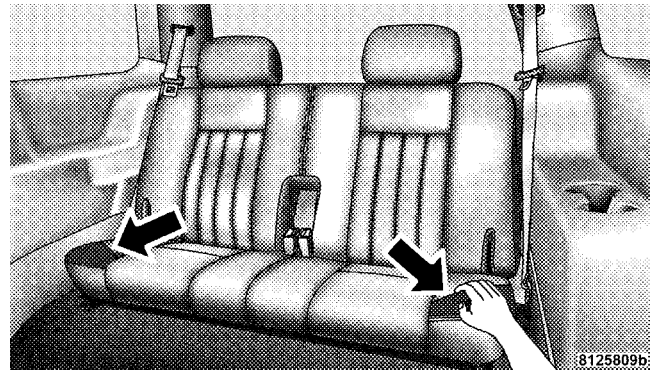

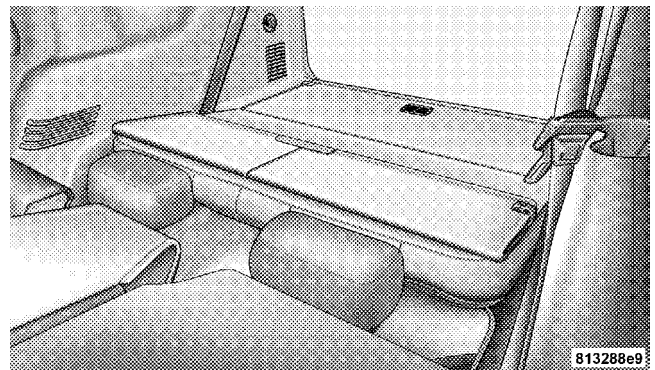
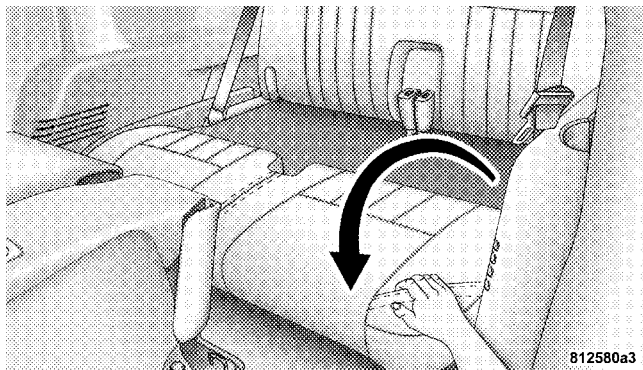

Flat Load Floor

Unsnap the flipper panels on the third row seats and flip them forward on the back(s) of the second row seat(s).

To Achieve Maximum Cargo Capacity

Pull up the release handles and strap on the second row seats and fold the seat backs flat. Then fold the third row seat flat. Unsnap the flipper panel on the third row seat and flip it forward on the backs of the second row seats.

NOTE: When returning the second row seats to their upright position, always snap the third row seat flipper panel(s) back to the third row seat first.

NOTE: The head restraints must be lowered when folding the back but do not have to be removed.

NOTE: The seat belt buckles are hinged to fold with the back.

WARNING!

Make sure the cushion is properly engaged under the seatback to properly lock the seatback in the riding position.

Do not sit in the 3rd row seat with the second row seatbacks folded or with the second row seats folded and tumbled. In a collision, you could slide under the seat belt and be seriously or even fatally injured.

Third Seat 50/50 Split Seat — If Equipped

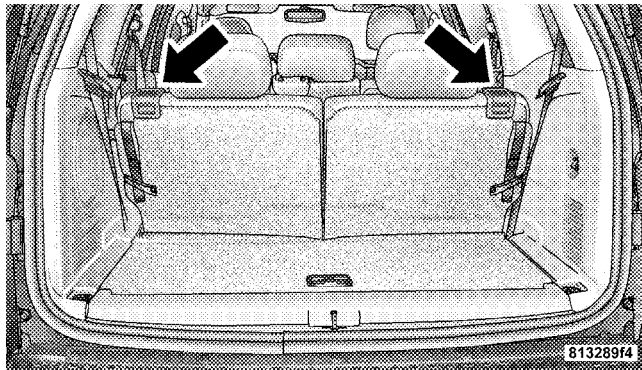

To Fold Down The Seat(s)

Folding the third row 50/50 seats requires one step. Pull up the release handle and move the seatback forward. This can be done from either in front of or behind the third row seat. The seatback and seat cushion move

simultaneously into a flat load floor position. The cushion and back will move forward together resting on the floor behind the second row seats. The seat belt buckles are hinged to fold with the seatback.

To extend the load floor, unstrap the straps and flip the flipper panel(s) on the third row seat forward on the back(s) of the second row seat(s).



To Return The Seat(s) To An Upright Position

Snap the flipper panel(s) on the seat back. Then pull on the pull strap on the seat back to reposition the seat(s) to an upright position.

NOTE: Make sure the seatback is properly engaged to lock the seatback to a upright position. This can be verified by pulling/pushing forward on the seatback. The seatback will not move forward.

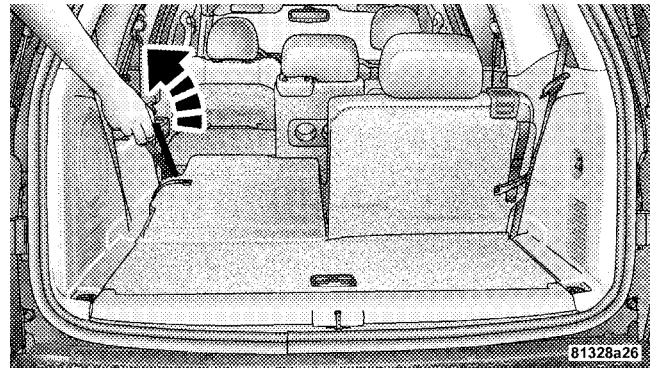

3

DRIVER MEMORY SYSTEM — IF EQUIPPED

Once programmed, the memory buttons 1 and 2 on the driver's door panel can be used to recall the driver's seat position, driver's outside mirror position, adjustable brake and accelerator pedals position, Automatic Temperature Control (ATC) temperature and radio station

preset settings. Your Remote Keyless Entry transmitters can also be programmed to recall the same positions when the UNLOCK button is pressed.

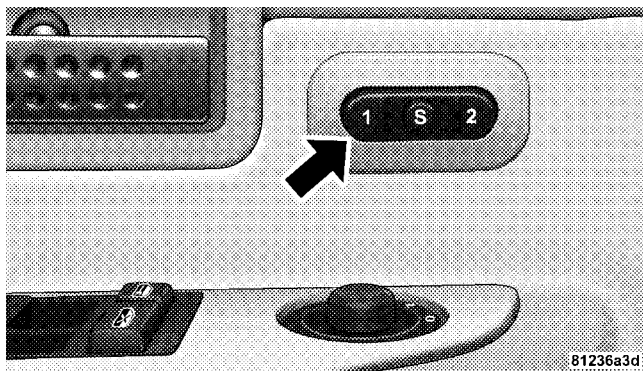

Your vehicle was delivered with two Remote Keyless Entry transmitters. One or both transmitters can be linked to either memory position. The memory system

can accommodate up to two transmitters, each transmitter linked to either of the two memory positions.

Setting Memory Positions and Linking Remote Keyless Entry Transmitter to Memory

NOTE: Each time the SET (S) button and a numbered button (1 or 2) are pressed, you erase the memory settings for that button and store new settings.

1. Adjust the driver's seat, recliner, and both side view mirrors to the desired positions.

NOTE: Not all motors may be moved at one time. Please refer to the 8-way power seat description.

2. Adjust the brake and accelerator pedals to the desired positions.

3. Turn on the radio and set the radio station presets (up to 10 AM and 10 FM stations can be set).

4. Adjust the Automatic Temperature Control (ATC) while the ATC is in Auto mode.
5. Press and release the SET (S) button located on the driver's door.
6. Within 5 seconds, press and release memory button 1 or 2 on the driver's door. The next step must be performed within 10 seconds if you desire to also use a Remote Keyless Entry transmitter to recall memory positions.
7. Press and release the LOCK button on one of the transmitters.
8. Insert the ignition key and turn the ignition switch to the ON position.
9. Repeat the above steps to set the next memory position using the other numbered memory button or to link another Remote Keyless Entry transmitter to memory.

Memory Position Recall

NOTE:

- The driver's seat belt must be unbuckled to recall memory positions.
- The vehicle must be in Park to recall memory positions.
- Not all motors may be moved at one time. Please refer to the 8-way power seat description.

To recall the memory settings for driver one, press memory button number 1 on the driver's door or the Unlock button on the Remote Keyless Entry transmitter linked to memory position 1.

To recall the memory setting for driver two, press memory button number 2 on the driver's door or the Unlock button on the Remote Keyless Entry transmitter linked to memory position 2.

A recall can be cancelled by pressing any of the memory buttons on the drivers door during a recall (S, 1, or 2), or pressing any one of the power seat buttons, or pressing the adjustable pedals button, or pressing either the LOCK or UNLOCK button on the remote keyless entry transmitter when not in the ignition switch. When a recall is cancelled, the driver's seat, and the pedals stop moving. A delay of one second will occur before another recall can be selected.

To Disable A Transmitter Linked to Memory

1. Turn the ignition switch to the OFF position and remove the key.
2. Press and release the memory SET (S) button located on the driver's door.
3. Within 10 seconds, press and release the UNLOCK button on the Remote Keyless Entry transmitter.

To disable another transmitter linked to either memory position, repeat steps 1-3 for each transmitter.

NOTE: The capability to link Remote Keyless Entry transmitters to memory is enabled when delivered from the factory. The capability to link Remote Keyless Entry transmitters to memory can be disabled (or later re-enabled) by a qualified DaimlerChrysler representative.

Self-Limiting Control

To improve vehicle reliability, the memory system includes a self-limiting control for full travel positioning of power seat and Adjustable Pedal movement (all directions). This self-limiting control may however develop an unintended movement limitation if an obstruction is encountered at sometime during usage. One example of such an occurrence may include a box or package obstructing the full rearward movement of the driver's seat. Once the obstruction is removed, the self-limiting control may be restored to maximum position. The self-limiting

control may be restored by first reaching the recently limited or obstructed position, then release and reactivate the same button or buttons. Continued seat travel beyond the obstructed position will indicate the recently encountered self-limitation has been cleared.

Driver Easy Exit and Easy Entry Control

This additional feature provides automatic driver's seat positioning which will enhance driver mobility out of and into the vehicle. The seat cushion will move rearward approximately 2.5 inches (60 mm) when the key is removed from the ignition switch. The seat will move forward approximately 2.5 inches (60 mm) when the key is placed into the ignition and turned out of the LOCK position, only when the seatbelt is unbuckled. Each stored memory setting will have an associated Easy Exit and Easy Entry position. The Easy Exit and Easy Entry feature may be automatically disabled if the seat is positioned rearward enough and no benefit from moving the seat any farther rearward.

NOTE: The Easy Exit Easy Entry feature is not enabled when delivered from the factory. The Easy Exit Easy Entry feature may be enabled (or later disabled) by a qualified DaimlerChrysler service representative.

Tilt Mirrors in Reverse

This additional feature provides automatic outside mirror positioning which will aid the driver's view of the ground rearward of the front doors. The outside mirrors will move slightly downward from the present position when the vehicle is shifted into Reverse position. The outside mirrors will then return to the original position when the vehicle is shifted out of Reverse position. Each stored memory setting will have an associated Tilt Mirrors in Reverse position.

NOTE: The tilt mirrors in Reverse feature is not enabled when delivered from the factory. The Tilt Mirrors in Reverse feature may be enabled (or later disabled) by a qualified DaimlerChrysler service representative.

TO OPEN AND CLOSE THE HOOD

To open the hood, two latches must be released. First pull the hood release lever located under the left side of the instrument panel.

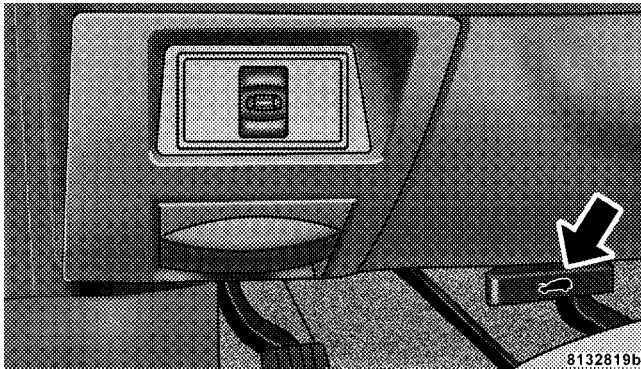

Then push the safety latch lever to the right. It is located between the grille openings left of the center.

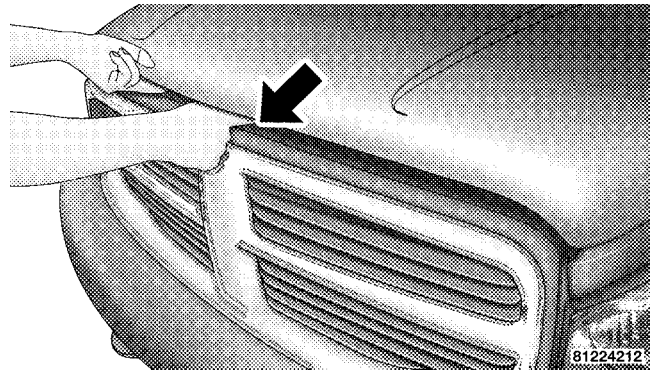

To prevent possible damage, do not slam the hood to close it. Use a firm downward push at the center of the hood to ensure that both latches engage. Never drive your vehicle unless the hood is fully closed, with both latches engaged.

WARNING!

If the hood is not fully latched, it could fly up when the vehicle is moving and block your forward vision. Be sure all hood latches are fully latched before driving.

LIGHTS

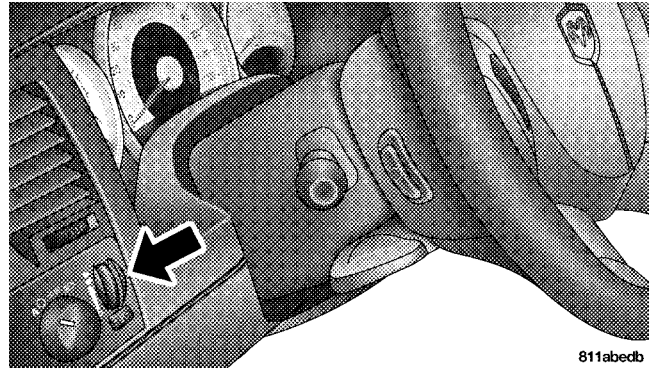

811abcdb

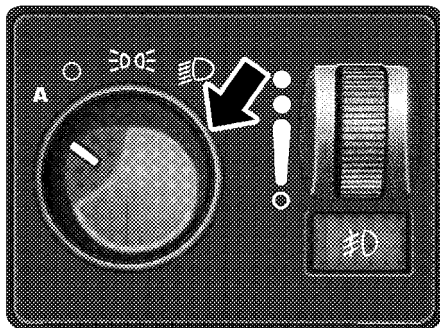

811aa567

Interior Lights

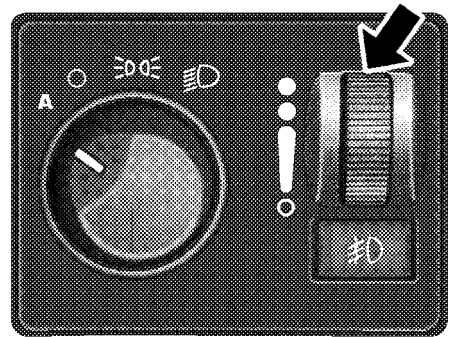

811aa583

Courtesy and dome lights are turned on when the front doors are opened, when the dimmer control (rotating wheel on the right side of the switch) is rotated to the second upward detent position, or when the UNLOCK button is pressed on the key fob. When a door is open and the interior lights are on, rotating the dimmer control

all the way down to the OFF detent will cause all the interior lights to go out. This allows the doors to stay open for extended periods of time without discharging the vehicle's battery.

The brightness of the instrument panel lighting can be regulated by rotating the dimmer control up (brighter) or down (dimmer). When the headlights are ON you can supplement the brightness of the odometer, trip odometer, radio and overhead console by rotating the control up until you hear a click. This feature is termed the "Parade" mode and is useful when headlights are required during the day.

Battery Saver

To protect the life of your vehicle's battery, Load Shedding is provided for both the interior and exterior lights.

If the ignition is off and any door is left ajar for eight minutes or the dimmer control is rotated upwards for eight minutes, the interior lights will automatically turn off.

If the headlights remain on while the ignition is cycled off, the exterior lights will automatically turn off after 8 minutes. If the headlights are turned on and left on for 8 minutes while the ignition is off, the exterior lights will automatically turn off.

NOTE: Battery Saver mode is cancelled if the ignition is ON.

NOTE: While the engine is running, the system will deactivate the Fog Lights and Heated seats if a low battery system voltage is detected.

Headlight Delay

To aid in your exit, your vehicle is equipped with a headlight delay that will leave the headlights on for 90 seconds. This delay is initiated when the ignition is cycled off while the headlight switch is on, and then the headlight switch is cycled off. The headlights will remain on for 90 seconds. Headlight delay can be cancelled by either turning the headlight switch ON then OFF or by turning the ignition ON.

NOTE: This feature can be disabled by your authorized dealer.

Automatic Headlights — If Equipped

Automatic Headlights can be activated by rotating the rotary headlight switch to the symbol "A." The headlights will turn on when the ignition is in the ON or START position and the ambient light sensor indicates that the headlights should be activated. The headlights will turn off if the headlight switch is rotated to the off position or 90 seconds after the ignition is turned to OFF.

Headlights, Parking Lights, Panel Lights

When the headlight switch is rotated to the first position to the right, the parking lights, taillights, side marker lights, license plate light and instrument panel lights are all turned on. The headlights will turn ON when the switch is rotated to the second position.

Your vehicle is equipped with plastic headlight lenses that are lighter and less susceptible to stone breakage than glass headlights.

Plastic is not as scratch resistant as glass and therefore different lens cleaning procedures must be followed.

To minimize the possibility of scratching the lenses and reducing light output, avoid wiping with a dry cloth. To remove road dirt, wash with a mild soap solution followed by rinsing.

Do not use abrasive cleaning components, solvents, steel wool or other abrasive materials to clean the lenses.

Illuminated Entry

Headlights turn on for 90 seconds, when the Remote Keyless Entry UNLOCK button is pressed.

NOTE: This feature can be activated by your authorized dealer.

Daytime Running Lights (Canada Only)

The headlights on your Durango will illuminate when the engine is started. This provides a constant “Lights ON” condition until the ignition is turned OFF. The lights illuminate at reduced intensity. If the parking brake is applied the Daytime Running Lights will turn off. If the headlights are activated, the Daytime Running Lights feature will transition to the normal headlight operating mode.

Lights-on Reminder

If the headlights, parking lights, or courtesy lights are left On, after the ignition is turned Off, a chime will sound when the driver’s door is opened.

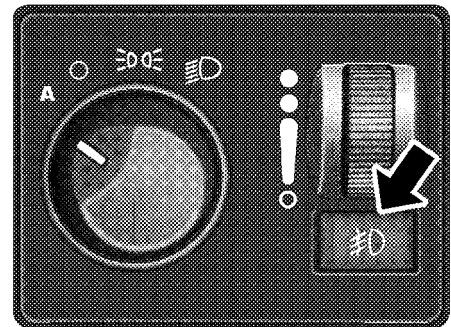
Fog Lights — If Equipped

811aa59c

The foglights are turned ON by placing the headlight rotary control in the parking light, headlight, or Auto

position and pressing the fog light button. The fog lights will operate only when the parking lights are ON or when the vehicle headlights are ON low beam. An indicator light located in the instrument cluster will illuminate when the fog lights are on. The fog lights will turn off when the switch is pressed in, when the headlight switch is rotated to the OFF position, or the high beam is selected.

MULTIFUNCTION CONTROL LEVER

The multifunction control lever is located on the left side of the steering column.

Turn Signals

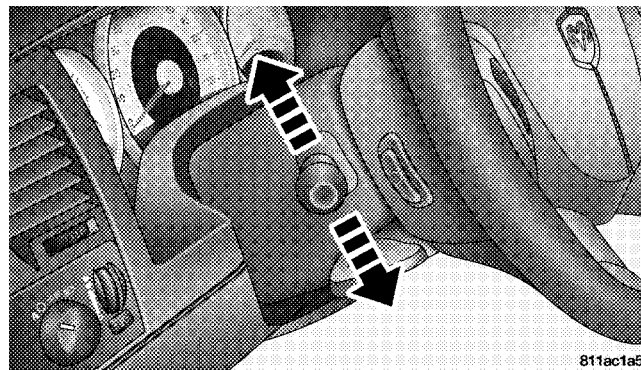

Move the lever up or down to signal a right-hand or left-hand turn.

The arrow on either side of the instrument cluster flashes to indicate the direction of the turn, and proper operation

of the front and rear turn signal lights. If an indicator fails to light when the lever is moved, it would suggest that the switch or indicator lamp is defective.

If a defective bulb or wiring circuit is detected for the turn signal system, the arrow indicators will flash at a faster rate.

You can signal a lane change by moving the lever partially up or down.

NOTE: If a turn signal has been left on for at least a mile duration, a continuous chime will sound.

Passing Light

You can signal another vehicle with your headlights by partially pulling the multifunction lever toward the steering wheel. This will cause the high beam headlights to turn on until the lever is released.

High Beam / Low Beam Select Switch

Pull the multifunction control lever fully toward the steering wheel to switch the headlights from HIGH or LOW beam.

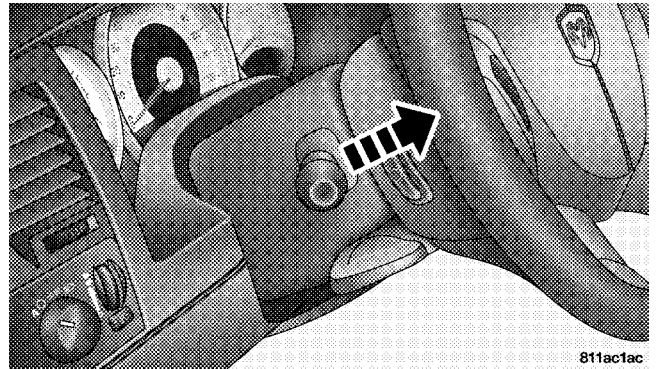

811ac1ac

Windshield Wipers

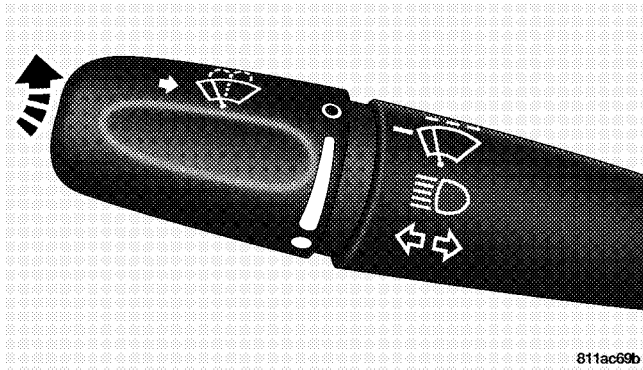

The wipers and washers are operated by a switch in the multifunction control lever. Turn the end of the handle to select the desired wiper speed.

Intermittent Wiper System

The intermittent feature of this system was designed for use when weather conditions make a single wiping cycle, with a variable pause between cycles, desirable. For maximum delay between cycles, rotate the control knob into the upper end of the delay range.

The delay interval decreases as you rotate the knob until it enters the LO continual speed position. The delay can be regulated from a maximum of about 15 seconds between cycles, to a cycle every 2 seconds. The delay intervals will double in duration when the vehicle speed is 10 mph (16 km) or less.

WARNING!

Sudden loss of visibility through the windshield could lead to an accident. You might not see other vehicles or other obstacles. To avoid sudden icing of the windshield during freezing weather, warm the windshield with defroster before and during windshield washer use.

NOTE: If the front wiper is operating when the ignition is turned off, the wiper will automatically return to the "Park" position. When the vehicle is restarted, the wipers will resume operation.

Windshield Washers

To use the washer, push in on the washer knob on the end of the multifunction control lever and hold while spray is desired. If the washer knob is depressed while in the delay range, the wiper will operate for several seconds after the washer knob is released. It will then resume the intermittent interval previously selected. If the washer knob is pushed, for a period greater than 1 second, while in the OFF position, the wiper will wipe approximately three wipes, after the wash knob is released.

To prevent freeze-up of your windshield washer system in cold weather, select a solution or mixture that meets or exceeds the temperature range of your climate. This rating information can be found on most washer fluid containers.

TRACTION CONTROL SWITCH — IF EQUIPPED

Traction control monitors the amount of wheel spin in each of the driven wheels. If wheel spin is detected, the pressure to the brake system of the slipping wheel(s) is modulated to provide enhanced acceleration. The system operates at speeds typically encountered in city traffic driving. 4WD drive models also include unique logic in 4HI or 4LO to enhance off-road capabilities.

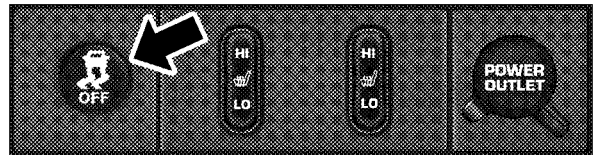

812287ad

The traction control Indicator, located in the instrument cluster, will light up when the Traction Control is in use.

To turn the system OFF, press the Traction Control switch, located below the climate controls in the center stack, until the traction control Indicator in the instrument cluster lights up.

To turn the system back ON, press the switch a second time until the traction control Indicator turns OFF.

NOTE:

- The traction control Indicator comes on each time the ignition switch is turned ON. This will occur even if you used the switch to turn the system OFF.
- The Traction Control system will make buzzing or clicking sounds when in operation.

TILT STEERING COLUMN

To tilt the column, push down on the lever below the turn signal control and move the wheel up or down, as desired.

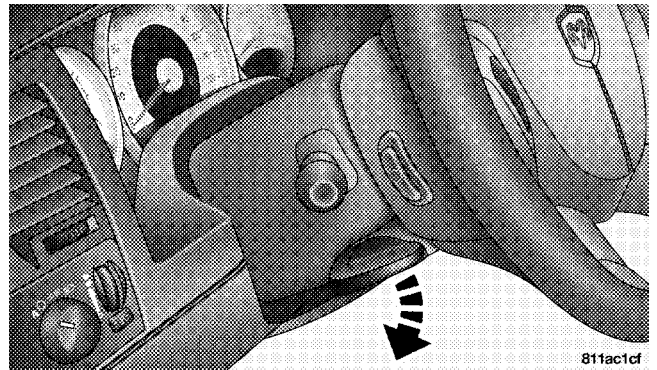

WARNING!

Tilting the steering column while the vehicle is moving is dangerous. Without a stable steering column, you could lose control of the vehicle and have an accident. Adjust the column only while the vehicle is stopped. Be sure it is locked before driving.

DRIVER ADJUSTABLE PEDALS — IF EQUIPPED

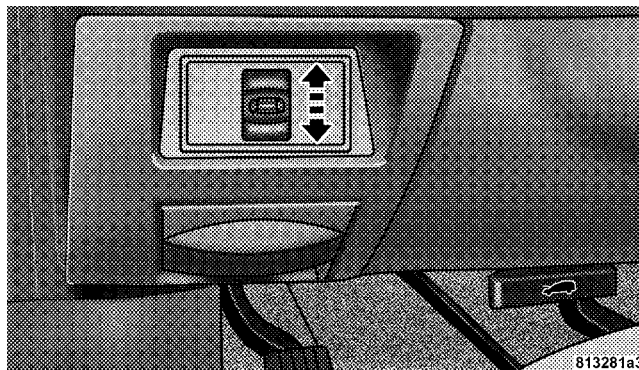

The power adjustable accelerator and brake pedals allow the driver to establish a comfortable position relative to the steering wheel and pedals.

Adjustment

1. Position the driver seat so that you are at least 10 inches (254 mm) away from the airbag located in the center of the steering wheel.
2. Fasten and adjust the seatbelts.
3. Move the adjustable pedal switch, located to the left of the steering column near the parking brake release, up to move the pedals toward the driver or down to move the pedals away from the driver.
4. The pedals **cannot** be adjusted when the vehicle is in R (Reverse) or when the Speed Control is SET.

CAUTION!

Do not place any article under the adjustable pedals or impede its ability to move as it may cause damage to the pedal controls. Pedal travel may become limited if movement is stopped by an obstruction in the adjustable pedal's path.

ELECTRONIC SPEED CONTROL — IF EQUIPPED

When engaged, this device takes over accelerator operation at speeds greater than (refer to the table below for the speed for your specific engine). The controls are mounted on the steering wheel.

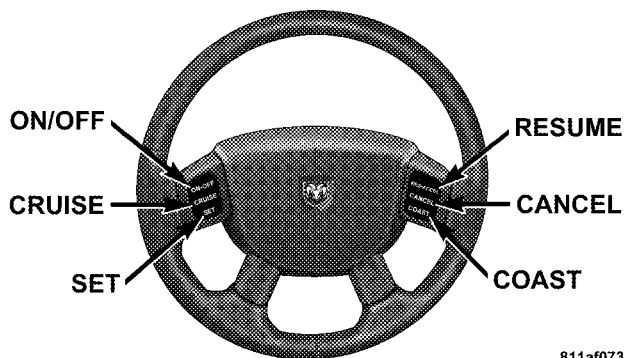

811af073

To Activate

Push the ON/OFF button to the ON position. In the instrument cluster, the word “CRUISE” illuminates when the system is on.

To Set At A Desired Speed

When the vehicle has reached the desired speed, press and release the SET button. Release the accelerator and the vehicle will operate at the selected speed.

To Deactivate

A soft tap on the brake pedal, normal braking, or pressing the CANCEL button will deactivate speed control without erasing the memory. Pushing the ON/OFF button to the OFF position or turning off the ignition erases the memory.

WARNING!

Leaving the Speed Control ON when not in use is dangerous. You could accidentally set the system to cause it to go faster than you want. You could lose control and have an accident. Always leave the system OFF when you aren't using it.

To Resume Speed

To resume a previously set speed, push and release the RESUME button. Resume can be used at any speed above (refer to the table below for the speed for your specific engine).

To Vary The Speed Setting

When the speed control is on, speed can be increased by pressing and holding the ACCEL button. When the button is released, a new set speed will be established.

Tapping the ACCEL button once will result in a speed increase (refer to the table below for the speed for your specific engine). Each time the button is tapped, speed increases so that tapping the button three times will increase speed by three increments.

Tapping the COAST button once will result in a speed decrease (refer to the table below for the speed for your specific engine). Each time the button is tapped, speed will decrease. For example, tapping the button 3 times will decrease the speed by 3 times the speed listed in the table below (refer to the table below for the speed for your specific engine).

To decrease speed while the speed control is on, press and hold the COAST button. Release the button when the desired speed is reached, and the new speed will be set.

Functions	3.7L	4.7L	5.7L
Engage Speed	35 mph (56 km/h)	35 mph (56 km/h)	25 mph (40 km/h)
Minimum RESUME Speed	30 mph (50 km/h)	30 mph (50 km/h)	20 mph (32 km/h)
ACCEL Increase	2 mph (3km/h)	2 mph (3km/h)	1 mph (2 km/h)
COAST Decrease	1 mph (2 km/h)	1 mph (2 km/h)	1 mph (2 km/h)
Dropout Speed	30 mph (50 km/h)	30 mph (50 km/h)	20 mph (32 km/h)

To Accelerate For Passing

Depress the accelerator as you would normally. When the pedal is released, the vehicle will return to the set speed.

NOTE: When driving uphill, at elevations above 2,000 feet (610 meters), or when the vehicle is heavily loaded (especially when towing) the vehicle may slow below the SET speed. If the vehicle speed drops below (refer to the table below for the speed for your specific engine), the speed control will automatically disengage. If this happens, you can push down on the accelerator pedal to maintain the desired speed.

Vehicles equipped with a Automatic transmission may exhibit several downshifts under the above conditions. To reduce the frequency of the downshifts and to improve vehicle performance, it is advisable to lock out overdrive by pressing the "TOW/HAUL" button located at the end of the gear shifter.

WARNING!

Speed Control can be dangerous where the system can't maintain a constant speed. Your vehicle could go too fast for the conditions, and you could lose control. An accident could be the result. Don't use Speed Control in heavy traffic or on roads that are winding, icy, snow-covered, or slippery.

OVERHEAD CONSOLE

The overhead console has the following features:

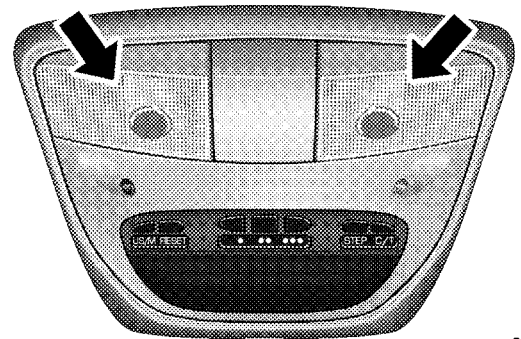

811a7133

- Courtesy Lights
- Garage Door Opener — If Equipped
- Compass/Temperature Mini-Trip Computer — If Equipped

Courtesy/Reading Lights

Near the front of the console are two courtesy/reading lights.

Both lights illuminate as courtesy lights when a door is opened, when the dimmer control is rotated to the courtesy light position (fully upward position), or when the UNLOCK button is pressed on the Remote Keyless Entry transmitter, if so equipped. These lights are also operated individually as reading lights by pressing the recessed area of the corresponding lens.

NOTE: The courtesy/reading lights will remain on until the switch is pressed a second time, so be sure they have been turned off before leaving the vehicle. If the interior lights are left on after the vehicle is turned OFF, they will extinguish after 8 minutes.

COMPASS/TEMPERATURE MINI-TRIP COMPUTER

This feature allows you to choose between a compass/temperature display and one of four trip conditions being monitored.

US/M Button

Use this button to change the display from U.S. to metric measurement units.

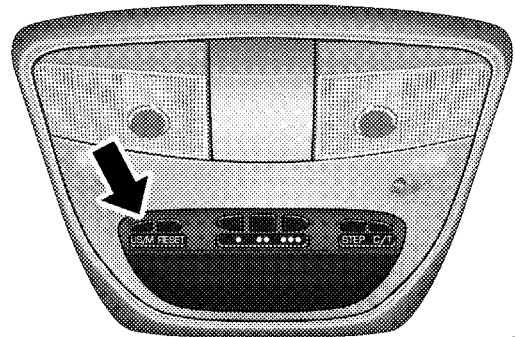

811a7292

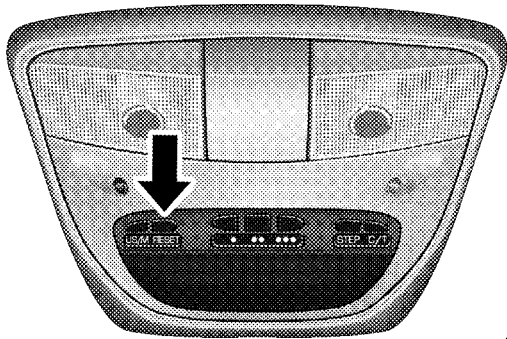
RESET Button

811a72a0

Use this button to reset the following displays to zero:
Average Fuel Economy
Trip Odometer
Elapsed time.

Global Reset

If the RESET button and STEP button are pressed at the same time and held for 3 seconds the Global Reset feature will reset the distance to empty (using a default fuel economy value), fuel economy, trip odometer, and elapsed time displays.

Step Button

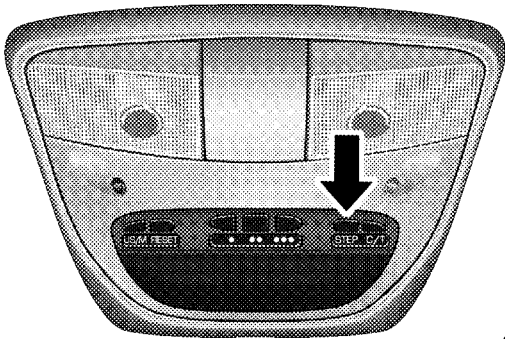

811a72be

Use this button to choose or cycle through the four trip conditions.

Average Fuel Economy (AVG ECO)

Shows the average fuel economy since the last reset. This display mode becomes less sensitive to instantaneous changes in fuel consumption as the number of total vehicle miles since the last reset increases. It is suggested that this mode be reset periodically for general operation or when driving conditions change significantly (for example, at the end of a trip or when a trailer is connected or disconnected).

Distance To Empty (DTE)

Shows the estimated distance that can be travelled with the fuel remaining in the tank. The estimated distance is determined by a weighted average of the instantaneous and average fuel economy, according to the current fuel tank level.

When Distance To Empty = 0, the fuel gauge pointer will initially be on the red "E" marker. At this point (fuel gauge pointer on the the red "E" marker) there is reserve

fuel capacity, which corresponds to approximately 8% of tank volume. This reserve capacity was put in place to prevent the likelihood of customers running out of fuel when operating at maximum load conditions in areas where there aren't many gas stations.

NOTE: The Distance To Empty will remain equal to zero, until the vehicle runs out of fuel or is refueled.

Trip Odometer (ODO)

This display shows the distance traveled since the last reset.

Elapsed Time (ET)

This display shows the accumulated ignition ON time since the last reset.

C/T Button

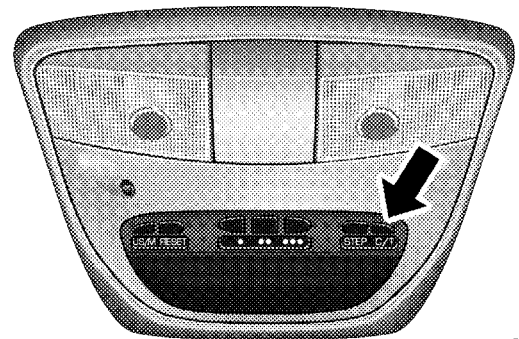

811a72d7

Use this button to select a readout of the outside temperature and one of eight compass headings that indicate the direction in which the vehicle is facing.

Compass/Temperature Display

WARNING!

Even if the display still reads a few degrees above 32°F (0°C), the road surface may be icy, particularly in woods or on bridges. Drive carefully under such conditions to prevent an accident and possible personal injury or property damage.

Automatic Compass Calibration

This compass is self-calibrating which eliminates the need to manually set the compass. When the vehicle is new, the compass may appear erratic and the CAL symbol will be displayed.

After completing one 360° turn, with the vehicle traveling less than 5 mph (8 km/h), in an area free from large metal or metallic objects, the CAL symbol will turn off and the compass will function normally.

Manual Compass Calibration

NOTE: To ensure proper compass calibration, make sure the compass variance is properly set before manually calibrating the compass.

If the compass appears erratic and the CAL symbol does not appear, you must manually put the compass into the “Calibration” mode.

To Put Into a Calibration Mode

Turn on the ignition and set the display to “Compass/Temperature.” Press and hold the RESET button to change the display between VAR (compass variance) and CAL (compass calibration) modes. When the CAL symbol is displayed complete one 360 degree turn in an area

free from large metal objects or power lines. The CAL symbol will turn off and the compass will function normally.

Compass Variance is the difference between magnetic north and geographic north. In some areas of the country, the difference between magnetic and geographic north is great enough to cause the compass to give false readings. If this occurs, the compass variance must be set according to the Compass Variance Map.

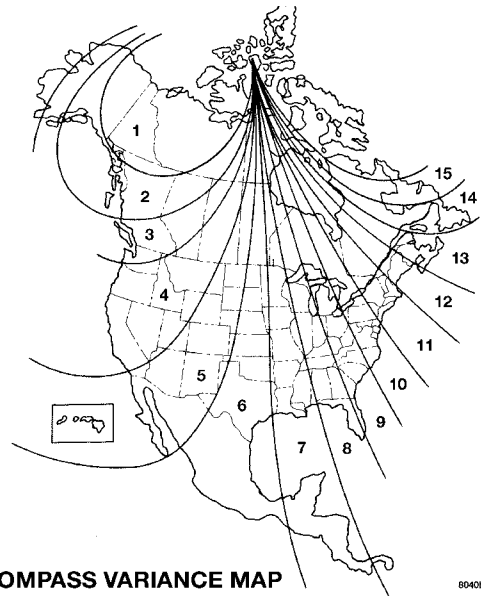

To set the variance: Turn the ignition ON and set the display to “Compass/Temperature.” Press and hold the RESET button approximately five seconds. The last variance zone number will be displayed. Press the STEP button to select the new variance zone and press the RESET button to resume normal operation.

Outside Temperature

Because the ambient temperature sensor is located underhood, engine temperature can influence the displayed temperature, therefore, temperature readings are slowly updated when the vehicle speed is below 20 mph (30 km/h) or during stop and go driving.

GARAGE DOOR OPENER — IF EQUIPPED

The HomeLink® Universal Transceiver replaces up to three remote controls (hand held transmitters) that operate devices such as garage door openers, motorized gates, or home lighting. It triggers these devices at the push of a button. The Universal Transceiver operates off your vehicle’s battery and charging system; no batteries are needed.

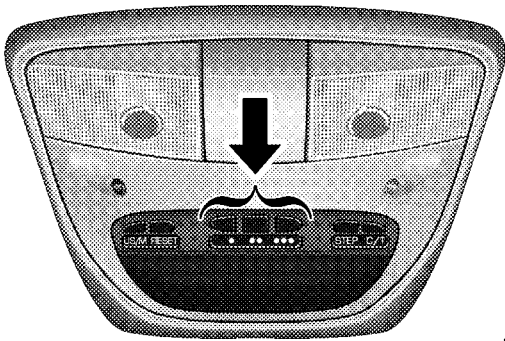

811a7ce5

For additional information on HomeLink®, call 1-800-355-3515, or on the internet at www.homelink.com.

WARNING!

A moving garage door can cause injury to people and pets in the path of the door. People or pets could be seriously or fatally injured. Only use this transceiver with a garage door opener that has a “stop and reverse” feature as required by federal safety standards. This includes most garage door opener models manufactured after 1982. Do not use a garage door opener without these safety features it could cause injury or death. Call toll-free 1-800-355-3515 or, on the Internet at www.homelink.com for safety information or assistance.

Programming HomeLink

NOTE: When programming a garage door opener, it is advised to park outside the garage. It is also recommended that a new battery be placed in the hand-held transmitter of the device being programmed to HomeLink for quicker training and accurate transmission of the radio-frequency signal.

1. Press and hold the two outer HomeLink buttons, and release only when the indicator light begins to flash (after 20 seconds). **Do not** hold the buttons for longer than 30 seconds and **do not** repeat step one to program a second and/or third hand-held transmitter to the remaining two HomeLink buttons.

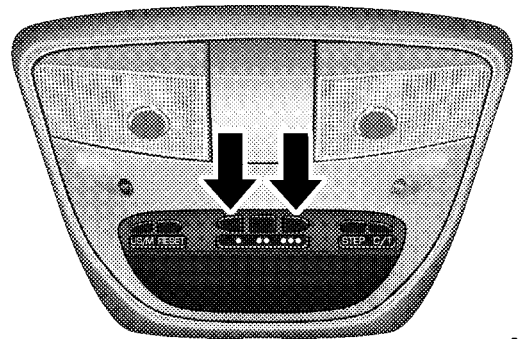

811a7ce9

WARNING!

Vehicle exhaust contains carbon monoxide, a dangerous gas. Do not run the vehicle's exhaust while training the transceiver. Exhaust gas can cause serious injury or death.

WARNING!

Your motorized door or gate will open and close while you are training the Universal Transceiver. Do not train the transceiver if people or pets are in the path of the door or gate. A moving door or gate can cause serious injury or death to people and pets or damage to objects.

2. Position the end of your hand-held transmitter 1-3 inches (3-8 cm) away from the HomeLink buttons while keeping the indicator light in view.
3. Simultaneously press and hold both the HomeLink button that you want to train and the hand-held transmitter buttons. **Do not release the buttons until step 4 has been completed.**

NOTE: Some gate operators and garage door openers may require you to replace this Programming Step 3 with procedures noted in the "Gate Operator/Canadian Programming" section.

4. The HomeLink indicator light will flash slowly and then rapidly after HomeLink successfully receives the frequency signal from the hand-held transmitter. Release both buttons after the indicator light changes from the slow to the rapid flash.

5. Press and hold the just trained HomeLink button and observe the indicator light. If the indicator light **stays on constantly, programming is complete** and your device should activate when the HomeLink button is pressed and released.

NOTE: To program the remaining two HomeLink buttons, begin with "Programming" **step two. Do not repeat step one.**

If the indicator light blinks **rapidly for two seconds and then turns to a constant light, continue with "Programming" steps 6-8** to complete the programming of a rolling code equipped device (most commonly a garage door opener).

6. At the garage door opener receiver (motor-head unit) in the garage, locate the "learn" or "smart" button. This can usually be found where the hanging antenna wire is attached to the motor-head unit.

7. Firmly press and release the "learn" or "smart" button. (The name and color of the button may vary by manufacturer.)

NOTE: There are 30 seconds in which to initiate step eight.

8. Return to the vehicle and firmly **press, hold for two seconds and release** the programmed HomeLink button. Repeat the "**press/hold/release**" sequence a second time,

and, depending on the brand of the garage door opener (or other rolling code equipped device), repeat this sequence a third time to complete the programming.

HomeLink should now activate your rolling code equipped device.

NOTE: To program the remaining two HomeLink buttons, begin with "Programming" **step two. Do not repeat step one.** For questions or comments, please contact HomeLink at www.homelink.com or 1-800-355-3515.

Canadian Programming/Gate Programming

Canadian radio-frequency laws require transmitter signals to "time-out" (or quit) after several seconds of transmission which may not be long enough for HomeLink to pick up the signal during programming. Similar to this Canadian law, some U.S. gate operators are designed to "time-out" in the same manner.

If you live in Canada or you are having difficulties programming a gate operator by using the "Programming" procedures (regardless of where you live), **replace "Programming HomeLink" step 3** with the following:

NOTE: If programming a garage door opener or gate operator, it is advised to unplug the device during the "cycling" process to prevent possible overheating.

3. Continue to press and hold the HomeLink button while you **press and release every two seconds** ("cycle") your hand-held transmitter until the frequency signal has successfully been accepted by HomeLink. (The indicator light will flash slowly and then rapidly.) Proceed with "Programming" step four to complete.

Using HomeLink

To operate, simply press and release the programmed HomeLink button. Activation will now occur for the trained device (i.e. garage door opener, gate operator, security system, entry door lock, home/office lighting,

etc.). For convenience, the hand-held transmitter of the device may also be used at any time. In the event that there are still programming difficulties or questions, contact HomeLink at: www.homelink.com or 1-800-355-3515.

Erasing HomeLink Buttons

To erase programming from the three buttons (individual buttons cannot be erased but can be "reprogrammed" - note below), follow the step noted:

- Press and hold the two outer HomeLink buttons until the indicator light begins to flash-after 20 seconds. Release both buttons. Do not hold for longer than 30 seconds. HomeLink is now in the train (or learning) mode and can be programmed at any time beginning with "Programming" - step 2.

Reprogramming a Single HomeLink Button

To program a device to HomeLink using a HomeLink button previously trained, follow these steps:

1. Press and hold the desired HomeLink button. **Do NOT** release the button.
2. The indicator light will begin to flash after 20 seconds. Without releasing the HomeLink button, proceed with "Programming" step 2

For questions or comments, contact HomeLink at: www.homelink.com or 1-800-355-3515.

Security**Garage Door Opener Operation with Security Alarm (if equipped)**

If your vehicle is equipped with the Security Alarm feature, the operation of the HomeLink feature will be purposely inhibited if the Security Alarm is "Armed". This prevents HomeLink operation due to un-authorized

vehicle entry. HomeLink operation will be re-stored when the Security Alarm has been "Disarmed".

If you sell your vehicle, be sure to erase the frequencies.

To erase all of the previously trained frequencies, hold down both outside buttons until the green light begins to flash.

This device complies with part 15 of FCC rules and with RSS-210 of Industry Canada. Operation is subject to the following conditions:

- This device may not cause harmful interference.
- This device must accept any interference that may be received including interference that may cause undesired operation.

NOTE: Changes or modifications not expressly approved by the party responsible for compliance could void the user's authority to operate the equipment.

HomeLink® is a trademark owned by Johnson Controls, Inc.

POWER SUNROOF — IF EQUIPPED

The power sunroof control is located between the sun visors on the overhead console.

Pressing the "open" end of the rocker switch once moves the panel to a comfort stop position short of full opening. Pressing and holding the switch causes the panel to continue moving rearward, up to the full-open position.

To close the panel, the "close" end of the switch must be pressed and held.

Pressing the "vent" button from a fully closed position, raises the trailing edge of the panel for ventilation. When the panel is venting, pressing the "close" end or the rocker switch returns it to the closed position. Both opening and closing operations in the vent mode occur only while the switch is held.

NOTE: The sunroof will continue to operate for ten minutes after the ignition is turned OFF or until the driver door is opened. This feature may be disabled by your authorized dealer.

Express Open Feature

During the Express Open operation, any movement of the switch will stop the sunroof and it will remain in a partial open position. Again, momentarily pressing the switch rearward will activate the Express Open Feature.

To close the sunroof, hold the switch in the forward position. Again, any release of the switch will stop the movement and the sunroof will remain in a partial open condition until the switch is pushed forward again. To close fully, hold the switch in the forward position until the glass movement has stopped.

The sunshade can be opened manually. It will also open as the sunroof opens. The sunshade cannot be closed if the sunroof is open.

WARNING!

Never leave children in a vehicle, with the keys in the ignition switch. Occupants, particularly unattended children, can become entrapped by the power sunroof while operating the power sunroof switch. Such entrapment may result in serious injury or death.

WARNING!

In an accident, there is a greater risk of being thrown from a vehicle with an open sunroof. You could also be seriously injured or killed. Always fasten your seat belt properly and make sure all passengers are properly secured too.

Do not allow small children to operate the sunroof. Never allow fingers or other body parts, or any object to project through the sunroof opening. Injury may result.

Wind Buffeting

Wind buffeting can be described as the perception of pressure on the ears or a helicopter type sound in the ears. Your vehicle may exhibit wind buffeting with the windows down, or the sunroof (if equipped) in certain open or partially open positions. This is a normal occurrence and can be minimized. If the buffeting occurs with

the rear windows open, open the front and rear windows together to minimize the buffeting. If the buffeting occurs with the sunroof open, adjust the sunroof opening to minimize the buffeting or open any window.

Sunroof Maintenance

Use only a nonabrasive cleaner and a soft cloth to clean the glass panel.

ELECTRICAL POWER OUTLETS

This vehicle has three auxiliary power outlets that can provide up to 20 Amps of current for accessories designed for use with the standard power outlet adapters. The outlet located in the lower portion of the instrument panel has a snap on a plastic cap so that it can be covered when not in use. As a safety precaution, the outlet in the instrument panel only operates with the ignition switch ON. When the optional Cigar Lighter heating element is

used, it heats when pushed in and pops out automatically when ready for use. **To preserve the heating element, do not hold the lighter in the heating position.**

There are two additional 12 V/(20 total Amps for both outlets) power outlets, one located in the storage bin of the center console and another located in the right rear cargo area. These outlets can be reconfigured by the customer to operate only when the ignition is ON (switched battery fed) or with the ignition ON or OFF (battery fed) to allow for cellular telephone charging and or operation while the ignition is off.

NOTE: All accessories connected to these outlets should be removed or turned OFF when the vehicle is not in use to protect the battery against discharge (unless the customer has reconfigured the fuse block to switched battery feed).

Electrical Outlet Use With Engine OFF (Battery Fed Configuration)**CAUTION!**

- Many accessories that can be plugged in draw power from the vehicle's battery, even when not in use (i.e. cellular phones, etc.). Eventually, if plugged in long enough, the vehicle's battery will discharge sufficiently to degrade battery life and/or prevent engine starting.
- Accessories that draw higher power (i.e. coolers, vacuum cleaners, lights, etc.), will discharge the battery even more quickly. Only use these intermittently and with greater caution.
- After the use of high power draw accessories, or long periods of the vehicle not being started (with accessories still plugged in), the vehicle must be driven a sufficient length of time to allow the generator to recharge the vehicle's battery.

Reconfiguring Power Outlets

To reconfigure the outlets, be sure the ignition is OFF before removing the fuse. The reconfigurable fuse location is a special design that allows the fuse to be installed in two different ways. If the fuse is located in the "Upper or Top Position" the outlets will work at all times. If the fuse is located in the "Lower or Bottom Position" the power outlets will only work when the ignition is ON.

NOTE: The fuse block is located in the left side kick panel behind a removable cover near the park brake pedal.

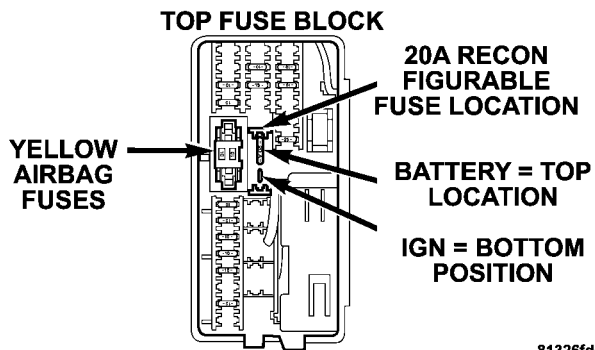

81326fdd

FLOOR CONSOLE

Floor Console Features

The Floor Console between the driver's and front passenger's seat, has the following features:

- Miscellaneous storage compartments
- Flexible cup holder inserts
- Portable phone storage bin
- Portable phone cord routing
- 12 Volt battery fed power outlet inside storage compartment
- Side open armrest lid
- Tissue holder & pen holder
- Coin slots
- Removable CD bin

The coin slots are located under the instrument panel center stack.

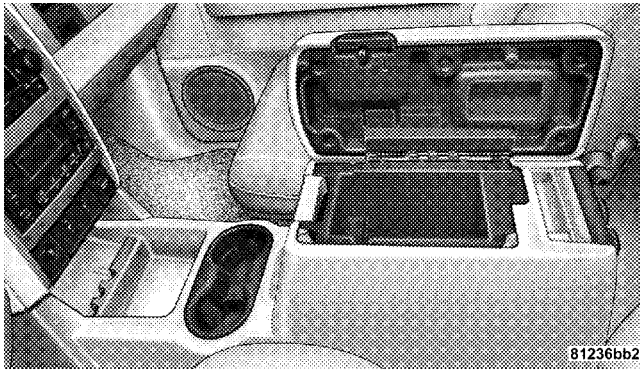

Cup Holders

The Durango has 8 cupholders. Four are located in the center console, two are located in the second row armrest, and two are located in the right hand quarter panel for

third row occupants. The four cupholders located in the center console may be removed for cleaning and are dishwasher safe.

Power Outlet and Portable Phone Storage

The console is equipped with a power outlet, portable phone storage bin, and phone cord routing. The phone storage bin can be used when easy access to the phone is needed. Also, the power outlet inside the console compartment can be used to power up the phone while it is being stored in the bin. To use, plug in the portable power recharge cord and place the cord along the opening under the forward portion of the storage bin. Close the console armrest lid and plug the power cord into the phone while resting the phone in the bin. The power outlet may be used for any portable item with a standard 12 volt power outlet adaptor, requiring up to 20 Amps of current. The power outlet is on all the time.

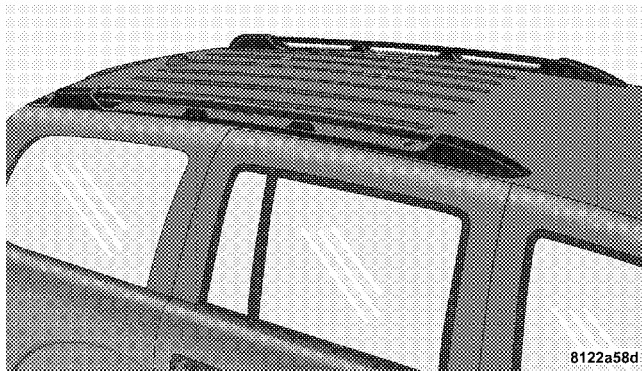
**FACTORY INSTALLED ROOF LUGGAGE RACK—
IF EQUIPPED**

The load carried on the roof when equipped with a luggage rack must not exceed 68 kg (150 lbs.), and should be uniformly distributed over the cargo area.

The side rails between the stations should be used to tie down cargo. Check the straps frequently to be sure that the load remains securely attached.

NOTE: Crossbars are offered by Mopar® accessories.

External racks do not increase the total load carrying capacity of the vehicle. Be sure that the total occupant and luggage load inside the vehicle, plus the load on the luggage rack, do not exceed the maximum vehicle load capacity.

CAUTION!

To avoid damage to the roof rack and vehicle, do not exceed the maximum roof rack load capacity. Always distribute heavy loads as evenly as possible and secure the load appropriately.

Long loads which extend over the windshield, such as wood panels or surfboards, should be secured to both the front and rear of the vehicle.

Place a blanket or other protection between the surface of the roof and the load.

Travel at reduced speeds and turn corners carefully when carrying large or heavy loads on the roof rack. Wind forces, due to natural causes or nearby truck traffic, can add sudden upward loads. This is especially true on large flat loads and may result in damage to the cargo or your vehicle.

WARNING!

Cargo must be securely tied before driving your vehicle. Improperly secured loads can fly off the vehicle, particularly at high speeds, resulting in personal injury or property damage. Follow the roof rack Cautions when carrying cargo on your roof rack.

INSTRUMENT PANEL AND CONTROLS

CONTENTS

■ Instruments And Controls	144	■ Sales Code REF — AM/FM/CD (Single Disc) Radio With Optional Hands Free Phone Capability	155
■ Instrument Cluster	145	□ Operating Instructions - Radio Mode	156
■ Instrument Cluster Description	146	□ Operation Instructions - CD Mode	159
■ Radio Reception Information	154	□ Operating Instructions - Hands Free Phone — If Equipped	161
□ AM Reception	154	■ Sales Code RAQ - AM/FM/CD (6-Disc) Radio With Optional Satellite Radio, Hands Free Phone, And Video Capabilities	161
□ FM Reception	154	□ Operating Instructions - Radio Mode	161
■ Electronic Digital Clock	154		
□ Clock Setting Procedure	155		

142 INSTRUMENT PANEL AND CONTROLS

□ Operation Instructions - (CD Mode For CD Audio Play)	165	□ Selecting a Channel	175
□ Load/Eject Button (CD Mode For CD Audio Play)	166	□ Storing And Selecting Pre-Set Channels	175
□ Notes On Playing MP3 Files	168	□ Using The PTY (Program Type) Button (If Equipped)	175
□ Operation Instructions - (CD Mode For MP3 Audio Play)	171	□ PTY Button "Scan"	175
□ Load/Eject Button (CD Mode For MP3 Play) . .	171	□ PTY Button "Seek"	176
■ Satellite Radio — If Equipped	173	□ Satellite Antenna	176
□ System Activation	173	□ Reception Quality	176
□ Electronic Serial Number/Sirius Identification Number (ENS/SID)	173	■ Remote Sound System Controls — If Equipped . .	177
□ Selecting Satellite Mode In REF Radios	174	□ Radio Operation	177
□ Selecting Satellite Mode In RAQ Radios	174	□ CD Player	178
		■ Compact Disc Maintenance	178
		■ Radio Operation And Cellular Phones	179

■ Climate Controls	179	□ Level Of Automatic Control	185
□ Manual Control	179	□ Manual Control (ATC)	186
□ Air Conditioning Operation	180	□ Rear Zone Climate Control — If Equipped . . .	189
□ Front Blower Control	180	□ Rear Rotary Temperature Control	190
□ Front Mode Control	181	□ Front Unit To Rear Unit Chart	191
□ Rear Temperature Control — If Equipped	183	□ Operating Tips	191
□ Rear Window Defrosting And Rear Window Washer/Wiper	184	□ Operating Tips Chart	193
□ Automatic Temperature Control (ATC) — If Equipped	184	■ Rear Window Features	194
□ Automatic Control	184	□ Rear Window Wiper/Washer	194
		□ Rear Window Defrosting	195

INSTRUMENTS AND CONTROLS

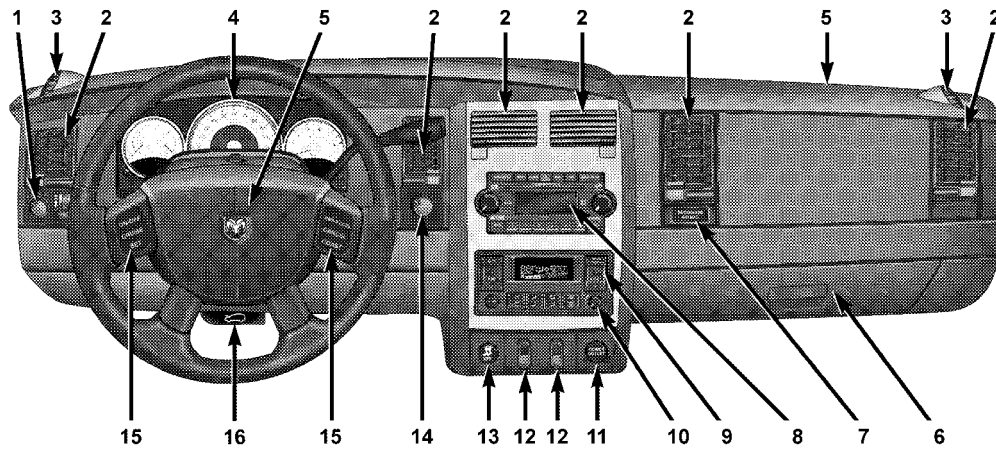

- 1. Headlight Switch
- 2. Air Outlets
- 3. Demister Outlets
- 4. Instrument Cluster
- 5. Airbags
- 6. Glove Box

- 7. Passenger Airbag Off Indicator
- 8. Radio
- 9. Climate Controls
- 10. Rear Washer/Wiper
- 11. Power Outlet
- 12. Heated Seat Switches*

- 13. Traction Control Switch*
- 14. Transfer Case Switch*
- 15. Speed Control Switches
- 16. Hood Release

*If Equipped

Instrument Cluster

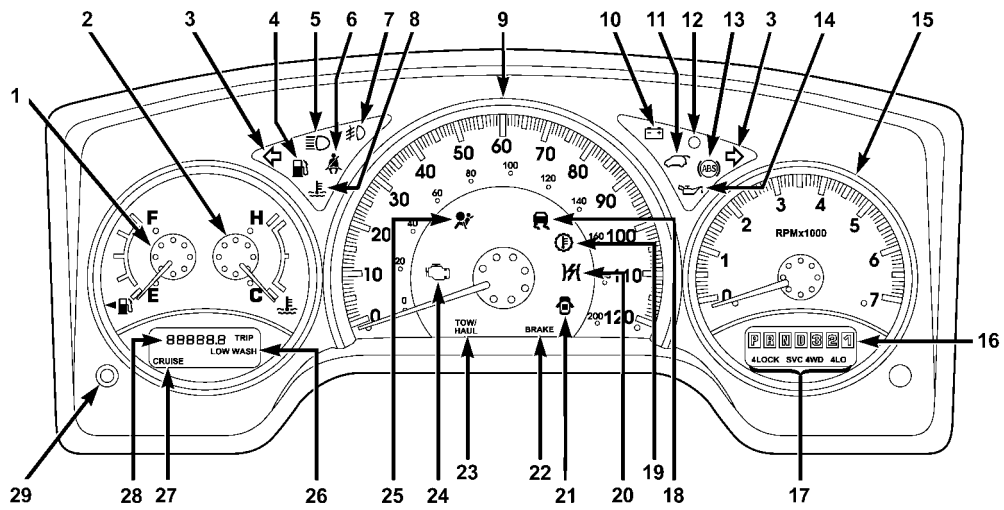

INSTRUMENT CLUSTER DESCRIPTION**1. Fuel Gage**

The fuel gauge shows level of fuel in tank when ignition switch is in the ON position.

2. Temperature Gage

The temperature gage indicates engine coolant temperature. Any reading within the normal range indicates that the cooling system is operating satisfactorily. The gage needle in V6 and V8 engines will likely indicate a high temperature when driving in hot weather, up mountain grades, in heavy traffic, or when towing a trailer. If the needle rises to the “H” mark, stop the vehicle, shift into N (Neutral) increase engine speed for 2-3 minutes. If the temperature reading does not return to normal, seek authorized service immediately.

CAUTION!

Do not leave your vehicle unattended with the engine running as you would not be able to react to the temperature indicator if the engine overheats.

The gage pointer will remain near its last reading when the engine is turned off. It will return to a true reading when the engine is restarted.

3. Turn Signal Indicators

When a turn signal is activated, a right-pointing or left-pointing arrow lights up and flashes to indicate the direction of the turn. These indicators also indicate proper operation of the front and rear turn signal lights. If either indicator flashes at a faster rate than normal, check for a defective bulb. If either indicator fails to light up when the lever is moved, check for a defective fuse or turn signal LED. A single chime is activated when the

left/right turn signal is left on with the engine RPM vehicle speed greater than 15 mph (24 km/h) for more than one mile.

4. Low Fuel Warning Light



This indicator lights when the fuel gauge reads 1/8 of a tank or less.

5. High Beam Indicator



Indicates that headlights are on high beam.

6. Seat Belt Reminder Light



This light comes on for several seconds after the ignition is turned ON as a reminder to “buckle up.” This light will remain on as long as the seat belt remains unbuckled. If this light flashes, it indicates a fault in the airbag system. Have the system checked by an authorized dealer.

7. Fog Light Indicator — If Equipped



This light shows when the fog lights are ON.

8. Coolant Temperature Light



This light warns of an overheated engine condition. For a bulb check, this light will come on momentarily when the ignition is turned On. If the light turns on while driving, stop the vehicle, shift into N (Neutral) and increase the engine speed for 2 to 3 minutes. If the temperature reading does not return to normal, seek authorized service immediately.

CAUTION!

Driving with a hot engine cooling system could damage your vehicle. If the temperature light is on, safely pull over and stop the vehicle. Idle the vehicle in neutral with the air conditioner turned off until the light turns off. If the light remains on, turn the engine off immediately, and call for service.

WARNING!

A hot engine cooling system is dangerous. You or others could be badly burned by steam or boiling coolant. You may want to call a service center if your vehicle overheats. If you decide to look under the hood yourself, see Section 7 of this manual. Follow the warnings under the Cooling System Pressure Cap paragraph.

9. Speedometer

Shows vehicle speed in miles per hour and kilometers per hour.

10. Voltage Light

This light monitors the electrical system voltage. The light should turn on momentarily as the

engine is started. If the light stays on or turns on while driving, it indicates a problem with the charging system. Immediate service should be obtained.

11. Liftgate Open

The Gate Open light will illuminate when the liftgate is not properly closed and the ignition is ON.

12. Security Light

This light will flash rapidly for approximately 15 seconds when the vehicle theft alarm is arming. The light will flash at a slower speed continuously after the alarm is set. The security light will also come on for about three seconds when the ignition is first turned on.

13. ABS Warning Light



This light monitors the Anti-Lock Brake System which is described elsewhere in this manual. This light will come on when the ignition key is turned to the ON position and may stay on for approximately 3 seconds. If this light remains on or

comes on during driving, it indicates that the Anti-Lock portion of the brake system is not functioning and that service is required. See your authorized dealer immediately.

14. Engine Oil Pressure Indicator Light

 This light indicates that the engine oil pressure has become too low. For a bulb check, this light will come on momentarily when the ignition is turned On. If the light turns on while driving, stop the vehicle and shut off the engine as soon as possible. Immediate service should be obtained.

15. Tachometer

This gage measures engine revolutions-per-minute (rpm x 1000).

16. Gear Selector

The electronic gear selector display is self-contained within the instrument cluster. It displays the position of the automatic transmission shift lever, and the relation of

each position to all other positions. For a good signal the display will place a box around the selected transmission range (PRND21). If the PRNDL displays only the characters PRND21 (no boxes) have the system checked by an authorized dealer.

17. Transfer Case Position and Service (SVC) Indicators

These lights monitor the electric shift 4WD system for transfer case position and function. If there are no indicator lights ON or flashing the transfer case is in All-Wheel-Drive (AWD) position. The SVC 4WD lights will come on when the ignition key is turned to the ON position and will stay on for 2 seconds. If the light stays on or comes on during driving, it means that the 4WD system is not functioning properly and that service is required.

18. Traction Control — If Equipped



This display indicator illuminates momentarily as a bulb check when the ignition switch is first turned ON. The indicator will blink during an active traction event, but will remain solid when the system is deactivated or if a system malfunction occurs.

The Traction Control indicator will turn ON if:

- The Traction Control system is in use.
- The Traction Control switch has been used to turn the system OFF.
- There is an Anti-Lock Brake system malfunction or Traction Control system malfunction.
- The system has been deactivated to prevent damage to the brake system due to overheated brake temperatures.

NOTE: Extended heavy use of Traction Control may cause the system to deactivate and turn on the Traction Control indicator. This is to prevent overheating of the brake system and is a normal condition. The system will remain disabled for about 4 minutes until the brakes have cooled. The system will automatically reactivate and turn off the Traction Control indicator.

19. Transmission Temperature Indicator

This light indicates that there is excessive transmission fluid temperature that might occur with severe usage such as trailer towing. If this light comes on, stop the vehicle and run the engine at idle or faster, with the transmission in NEUTRAL until the light goes off.

20. Electronic Throttle Control (ETC) Light 5.7L Engines Only



This light informs you of a problem with the Electronic Throttle Control system. If a problem is detected the light will come on while the

engine is running. If the light remains lit with the engine running your vehicle will usually be drivable, however, see your dealer for service as soon as possible. If the light is flashing when the engine is running, immediate service is required and you may experience reduced performance, an elevated/rough idle or engine stall and your vehicle may require towing. The light will come on when the ignition is first turned on and remain on briefly as a bulb check. If the light does not come on during starting, have the system checked by an authorized dealer.

21. Door Ajar

The Door Ajar light will illuminate when the ignition is ON and any one of the passenger doors are opened.

NOTE: A chime will sound if the vehicle is rolling and a door has been opened.

22. BRAKE System Warning Light

This light will light when the ignition key is turned to the ON position and will remain on for a few seconds. If the

light stays on, it may be an indication that the parking brake has not been released, or there is a low brake fluid level. If the light remains on when the parking brake has been disengaged, and the fluid level is at the full mark on the master cylinder reservoir, it indicates a possible brake hydraulic system malfunction. In this case, the light will remain on until the condition has been corrected. If the parking brake is applied, the light will flash when the gear position is out of park for automatic transmissions.

If brake failure is indicated, immediate repair is necessary. Operating the vehicle in this condition is dangerous!

23. TOW/HAUL

The TOW/HAUL button is located at the end of the gear shift lever. This light will illuminate when the TOW/HAUL button has been selected.

24. Malfunction Indicator Light



This light is part of an onboard diagnostic system which monitors the emissions and engine control system. If the vehicle is ready for emissions testing the light will come on when the ignition is first turned on and remain on, as a bulb check, until the engine is started. If the vehicle is not ready for emissions testing the light will come on when the ignition is first turned on and remain on for 15 seconds, then blink for 5 seconds, and remain on until the vehicle is started. If the bulb does not come on during starting, have the condition investigated promptly.

If this light comes on and remains on while driving, it suggests a potential engine control problem and the need for system service.

Although your vehicle will usually be drivable and not need towing, see your dealer for service as soon as possible.

CAUTION!

Prolonged driving with the MIL on could cause damage to the engine control system. It also could affect fuel economy and driveability.

If the MIL is flashing, severe catalytic converter damage and power loss will soon occur. Immediate service is required.

25. Airbag Indicator

The indicator lights and remains lit for 6 to 8 seconds when the ignition is first turned ON. If the light does not come on when the ignition is first turned on, or the light stays on or comes on while driving, have the airbag system checked by an authorized dealer.

26. Low Washer Fluid Indicator

This light comes on when the washer fluid level falls below approximately 1/4 full. The light will remain on until fluid is added and ignition switch is cycled.

27. Cruise Light

This indicator lights when the electronic speed control system is turned on.

28. Odometer/Trip Odometer

The odometer shows the total distance the vehicle has been driven.

U.S. federal regulations require that upon transfer of vehicle ownership, the seller certify to the purchaser the correct mileage that the vehicle has been driven. Therefore, if the odometer reading is changed during repair or replacement, be sure to keep a record of the reading before and after the service so that the correct mileage can be determined.

The trip odometer shows individual trip mileage. To toggle between the odometer and the trip odometer, press the Odometer/Trip Odometer Button.

29. Odometer/Trip Odometer Button

Press this button to toggle between the odometer and the trip odometer display. Holding the button in resets the trip odometer reading.

RADIO RECEPTION INFORMATION

AM Reception

AM radio signals usually travel longer distances than FM signals, especially at night. These longer distance AM signals can cause AM stations to interfere with one another. Noise from storms and power lines can also interfere with AM reception. Reducing the treble can reduce some of the noise.

FM Reception

FM Stereo signals produce better sound quality than AM signals. However, FM signals will only travel approximately 10 to 40 miles (16 to 64 km). Tall structures or hills can cause interference with FM signals causing the sound to cut out.

ELECTRONIC DIGITAL CLOCK

The clock and radio each use the display panel built into the radio. A digital readout shows the frequency and/or time in hours and minutes (depending on your radio model) whenever the ignition switch is in the "ON" or "ACC" position.

When the ignition switch is in the "OFF" position, or when the radio frequency is being displayed, time keeping is accurately maintained.

On the RAQ radio the time button alternates the location of the time and frequency on the display. On the REF only one of the two, time or frequency is displayed at a time.

Clock Setting Procedure

1. Press and hold the time button until the hours blink.
2. Adjust the hours by turning the right side Tune / Audio control.
3. After the hours are adjusted, press the right side Tune / Audio control to set the minutes.
4. Adjust the minutes using the right side Tune / Audio control.
5. To exit, press any button/knob or wait approximately 5 seconds.

SALES CODE REF — AM/FM/CD (SINGLE DISC) RADIO WITH OPTIONAL HANDS FREE PHONE CAPABILITY

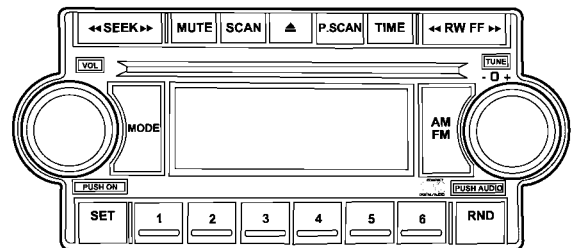

Operating Instructions - Radio Mode

NOTE: The ignition switch must be in the ON or ACC position to operate the radio.

Power Switch/Volume Control (Rotary)

Press the ON/VOL control to turn the radio ON. Press the ON/VOL a second time to turn OFF the radio.

Electronic Volume Control

The electronic volume control turns continuously (360 degrees) in either direction without stopping. Turning the volume control to the right increases the volume and to the left decreases it.

When the audio system is turned on, the sound will be set at the same volume level as last played.

For your convenience, the volume can be turned down, but not up, when the audio system is off and the ignition is ON.

Mode Button (Radio Mode)

Press the mode button repeatedly to select between the CD player or Satellite Radio (if equipped).

SEEK Button (Radio Mode)

Press and release the SEEK button to search for the next listenable station in either AM/FM or Satellite (if equipped) mode. Press the right side of the button to seek up and the left side to seek down. The radio will remain tuned to the new station until you make another selection. Holding the button will bypass stations without stopping until you release it.

MUTE Button (Radio Mode)

Press the MUTE button to cancel the sound from the speakers. "MUTE" will be displayed. Press the MUTE button a second time and the sound from the speakers will return. Rotating the volume control, turning the radio ON /OFF, or turning ON/OFF the ignition, will cancel the MUTE feature.

NOTE: In Hands Free Phone (if equipped) mode, the MUTE button mutes the microphone.

SCAN Button (Radio Mode)

Pressing the SCAN button causes the tuner to search for the next listenable station, in either AM, FM or Satellite (if equipped) frequencies, pausing for 5 seconds at each listenable station before continuing to the next. To stop the search, press SCAN a second time.

PSCAN Button (Radio Mode)

Pressing the PSCAN button, causes the tuner to scan through preset stations, in either AM, FM or Satellite (if equipped) frequencies, pausing for 5 seconds at each preset station before continuing to the next. To stop the search, press PSCAN a second time.

RW/FF (Radio Mode)

Pressing the rewind/fast forward button causes the tuner to search for the next frequency in the direction of the arrows. This feature operates in either AM, FM or Satellite (if equipped) frequencies.

TUNE Control (Radio Mode)

Turn the right side rotary control to increase or decrease the frequency.

AM/FM Button (Radio Mode)

Press the button to select AM or FM Modes.

Setting the Tone, Balance, and Fade

Press the rotary TUNE control and BASS will display. Turn the TUNE control to the right or left to increase or decrease the Bass tones.

Press the rotary TUNE control a second time and MID will display. Turn the TUNE control to the right or left to increase or decrease the Mid Range tones.

Press the rotary TUNE control a third time and TREBLE will display. Turn the TUNE control to the right or left to increase or decrease the Treble tones.

Press the rotary TUNE control a fourth time and BAL will display. Turn the TUNE control to the right or left to adjust the sound level from the right or left side speakers.

Press the rotary TUNE control a fifth time and FADE will display. Turn the TUNE control to the right or left to adjust the sound level between the front and rear speakers.

Press the tune control again or wait 5 seconds and the radio will return to normal display.

SET Button (Radio Mode) To SET The Push-Button Memory

When you are receiving a station that you wish to commit to push-button memory, press the SET button. The symbol SET 1 will now show in the display window.

Select the button (1-6) you wish to lock onto this station and press and release that button. If a button is not selected within 5 seconds after pressing the SET button, the station will continue to play but will not be stored into push-button memory.

You may add a second station to each push-button by repeating the above procedure with this exception: Press the SET button twice and SET 2 will show in the display window. Each button can be set for SET 1 and SET 2 in both AM and FM. This allows a total of 12 AM, 12 FM and 12 Satellite (if equipped) stations to be stored into push-button memory. The stations stored in SET 2 memory can be selected by pressing the push-button twice.

Every time a preset button is used a corresponding button number will be displayed.

Preset Buttons 1 - 6 (Radio Mode)

These buttons tune the Radio to the stations that you commit to push-button memory {12 AM, 12 FM, and 12 Satellite (if equipped) stations}.

Operation Instructions - CD Mode

NOTE: The ignition switch must be in the ON or ACC position to operate the radio.

Inserting The Compact Disc (Single CD Player)

Gently insert one CD into the CD player with the CD label facing up. The CD will automatically be pulled into the CD Player and the CD icon will illuminate on the radio display.

If the volume control is ON, the unit will switch to CD mode and begin to play. The display will show the track number and play time in minutes and seconds. Play will begin at the start of track one.

NOTE:

- You may insert or eject a disc with the radio or ignition switch OFF.
- If you insert a disc with the ignition ON and the radio OFF, the CD will automatically be pulled into the CD Player and the display will show the time of day.

SEEK Button (CD Mode)

Press the right side of the SEEK button for the next track on the CD. Press the left side of the button to return to the beginning of the current track, or return to the beginning of the previous track if the CD is within the first 10 seconds of the current selection.

MUTE Button ((CD Mode)

Press the MUTE button to cancel the sound from the speakers. "MUTE" will be displayed. Press the MUTE button a second time and the sound from the speakers will return. Rotating the volume control or turning OFF the ignition will also return the sound from the speakers.

SCAN Button (CD Mode)

Press this button to play the first 10 seconds of each track. To stop the scan function, press the button a second time.

EJECT Button (CD Mode)

Press this button and the disc will unload and move to the entrance for easy removal. The unit will switch to the last selected mode.

If you do not remove the disc within 15 seconds, it will be reloaded. The radio mode will continue to appear.

TIME Button (CD Mode)

Press this button to change the display from elapsed CD playing time to time of day.

RW/FF (CD Mode)

Press and hold the FF (Fast Forward) and the CD player will begin to fast forward until FF is released. The RW (Reverse) button works in a similar manner.

NOTE: RND Button (Random Play Button) (CD Mode)

Press this button while the CD is playing to activate Random Play. This feature plays the selections on the compact disc in random order to provide an interesting change of pace.

Press the SEEK button to move to the next randomly selected track.

Press and hold the FF button to fast forward through the tracks. Release the FF button to stop the fast forward feature. If the RW button is pressed, the current track will reverse to the beginning of the track and begin playing.

Press the RDN button a second time to stop Random Play.

Operating Instructions - Hands Free Phone — If Equipped

Refer to the HANDS FREE PHONE (UConnect™) section of the Owner's Manual.

SALES CODE RAQ – AM/FM/CD (6-DISC) RADIO WITH OPTIONAL SATELLITE RADIO, HANDS FREE PHONE, AND VIDEO CAPABILITIES

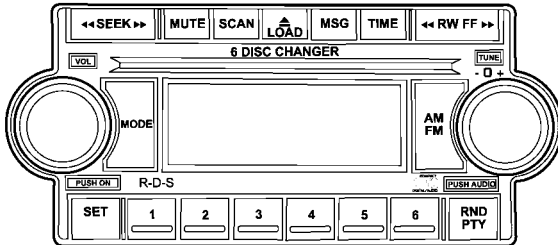

8118786d

Operating Instructions - Radio Mode

NOTE: The ignition switch must be in the ON or ACC position to operate the radio.

Power Switch/Volume Control (Rotary)

Press the ON/VOL control to turn the radio ON. Press the ON/VOL a second time to turn OFF the radio.

Electronic Volume Control

The electronic volume control turns continuously (360 degrees) in either direction without stopping. Turning the volume control to the right increases the volume and to the left decreases it.

When the audio system is turned on, the sound will be set at the same volume level as last played.

For your convenience, the volume can be turned down, but not up, when the audio system is off and the ignition is ON.

Mode Button (Radio Mode)

Press the mode button repeatedly to select between the Radio, CD player, Hands Free Phone, Satellite, or Vehicle Entertainment System (VES) (if equipped).

SEEK Button (Radio Mode)

Press and release the SEEK button to search for the next station in either AM/FM or Satellite (if equipped) mode. Press the right side of the button to seek up and the left side to seek down. The radio will remain tuned to the new station until you make another selection. Holding the button will bypass stations without stopping until you release it.

MUTE Button (Radio Mode)

Press the MUTE button to cancel the sound from the speakers. "MUTE" will be displayed. Press the MUTE button a second time and the sound from the speakers will return. Rotating the volume control or turning OFF the ignition will also return the sound from the speakers

NOTE: In Hands Free Phone (if equipped) mode, the MUTE button mutes the microphone.

SCAN Button (Radio Mode)

Pressing the SCAN button causes the tuner to search for the next station, in either AM, FM or Satellite (if equipped) frequencies, pausing for 5 seconds at each listenable station before continuing to the next. Pressing the AM/FM button continues the search in the alternate frequency band. To stop the search, press SCAN a second time.

MSG Button (Radio Mode)

Press the MSG button for an RBDS station (one with call letters displayed). The radio will return a Radio Text message broadcast from an FM station (FM mode only).

RW/FF (Radio Mode)

Pressing the rewind/fast forward button causes the tuner to search for the next frequency in the direction of the arrows. This feature operates in either AM, FM or Satellite (if equipped) frequencies.

TUNE Control (Radio Mode)

Turn the right side rotary control to increase or decrease the frequency.

AM/FM Button (Radio Mode)

Press the button to select AM or FM Modes.

Setting the Tone, Balance, and Fade

Press the rotary TUNE control and BASS will display. Turn the TUNE control to the right or left to increase or decrease the Bass tones.

Press the rotary TUNE control a second time and MID will display. Turn the TUNE control to the right or left to increase or decrease the Mid Range tones.

Press the rotary TUNE control a third time and TREBLE will display. Turn the TUNE control to the right or left to increase or decrease the Treble tones.

Press the rotary TUNE control a fourth time and BAL will display. Turn the TUNE control to the right or left to adjust the sound level from the right or left side speakers.

Press the rotary TUNE control a fifth time and FADE will display. Turn the TUNE control to the right or left to adjust the sound level between the front and rear speakers.

Press the rotary TUNE control again to exit setting tone, balance and fade.

RDN/PTY Button (Radio Mode)

Pressing this button once will turn on the PTY mode for 5 seconds. If no action is taken during the 5 second time out the PTY icon will turn off. Pressing the PTY button

within 5 seconds will allow the program format type to be selected. Many radio stations do not currently broadcast PTY information.

Toggle the PTY button to select the following format types:

Program Type	16 Digit-Character Display
No program type or undefined	None
News	News
Information	Information
Sports	Sports
Talk	Talk
Rock	Rock
Classic Rock	Classic_Rock
Adult Hits	Adult_Hits
Soft Rock	Soft_Rock

Top 40	Top_40
Country	Country
Oldies	Oldies
Soft	Soft
Nostalgia	Nostalgia
Jazz	Jazz
Classical	Classical
Rhythm and Blues	Rhythm_and_Blues
Soft Rhythm and Blues	Soft_R_&_B
Foreign Language	Foreign_Language
Religious Music	Religious_Music
Religious Talk	Religious_Talk
Personality	Personality
Public	Public
College	College
Unassigned	
Weather	Weather

By pressing the SEEK button when the PTY icon is displayed, the radio will be tuned to the next frequency station with the same selected PTY name. The PTY function only operates when in the FM mode.

If a preset button is activated while in the PTY (Program Type) mode, the PTY mode will be exited and the radio will tune to the preset station.

Buttons 1 - 6 (Radio Mode)

These buttons tune the Radio to the stations that you commit to push-button memory {12AM, 12 FM, and 12 Satellite (if equipped) stations}.

Operation Instructions - (CD MODE For CD Audio Play)

NOTE: The ignition switch must be in the ON or ACC position to operate the radio.

NOTE: Note: This Radio is capable of playing compact discs (CD), recordable compact discs (CD-R), rewritable

compact discs (CD-RW) compact discs with MP3 tracks and multisession compact discs with CD and MP3 tracks.

Inserting Compact Disc(s)

CAUTION!

This CD player will accept 4 3/4 inch (12 cm) discs only. The use of other sized discs may damage the CD player mechanism.

4

You may eject a disc with the radio OFF.

If you insert a disc with the ignition ON and the radio OFF, the display will show the time of day. If you insert a disc with the ignition OFF, the display will show the time of day for about 5 seconds, then go out.

If you insert a disc with the ignition ON and the radio ON, the unit will switch from radio to CD mode and

begin to play when you insert the disc. The display will show the disc number, the track number, and index time in minutes and seconds. Play will begin at the start of track 1.

SEEK Button (CD MODE For CD Audio Play)

Press the right side of the SEEK button for the next selection on the CD. Press the left side of the button to return to the beginning of the current selection, or return to the beginning of the previous selection if the CD is within the first 10 seconds of the current selection.

MUTE Button (CD MODE For CD Audio Play)

Press the MUTE button to cancel the sound from the speakers. "MUTE" will be displayed. Press the MUTE button a second time and the sound from the speakers will return. Rotating the volume control or turning OFF the ignition will also return the sound from the speakers.

SCAN Button (CD MODE For CD Audio Play)

Press the Scan button to scan through each track on the CD currently playing.

LOAD/EJECT Button (CD Mode For CD Audio Play)

LOAD/ EJECT - Load



Press the LOAD/ EJECT button and the push-button with the corresponding number where the CD is being loaded. The radio will display PLEASE WAIT and prompt when to INSERT DISC. After the radio displays "LOAD DISC" insert the CD into the player.

Radio display will show "LOADING DISC" when the disc is loading.

LOAD / EJECT - Eject

Press the LOAD/ EJECT button and the push-button with the corresponding number where the CD was loaded and the disc will unload and move to the entrance for easy removal.

Radio display will show "EJECTING DISC" when the disc is being ejected and prompt the user to remove the disc.

If you have ejected a disc and have not removed it within 15 seconds, it will be reloaded. If the CD is not removed, the radio will continue to play the non-removed CD. If the CD is removed and there are other CD's in the radio, the radio will play the next CD. If the CD is removed and there are no other CD's in the radio, the radio will remain in CD mode and display "NO DISC LOADED". The disc can be ejected with the radio and ignition OFF.

TIME Button (CD MODE For CD Audio Play)

Press this button to change the display from a large CD playing time display and small clock time display to a large clock time display and small CD playing time display.

RW/FF (CD MODE For CD Audio Play)

Press FF (Fast Forward) once and the CD player will begin to fast forward until FF is pressed again or RW or another CD button is pressed. The RW (Reverse) button works in a similar manner.

TUNE Control (CD MODE For CD Audio Play)

Pressing the TUNE control allows the setting of the Tone, Fade, and Balance. See Radio Mode.

AM/FM Button (CD MODE For CD Audio Play)

Switches the Radio to the Radio mode.

RND/PTY Button (Random Play Button) (CD MODE For CD Audio Play)

Press this button while the CD is playing to activate Random Play. This feature plays the selections on the compact disc in random order to provide an interesting change of pace.

Press the SEEK button to move to the next randomly selected track.

Press and hold the FF button to fast forward through the tracks. Release the FF button to stop the fast forward feature. If the RW button is pressed, the current track will reverse to the beginning of the track and begin playing.

Press the RDN button a second time to stop Random Play.

BUTTONS 1 - 6 (CD MODE For CD Audio Play)

Selects disc positions 1 - 6 for Play/Load/Eject.

Notes On Playing MP3 Files

The radio can play MP3 files, however, acceptable MP3 file recording media and formats are limited. When writing MP3 files, pay attention to the following restrictions.

Supported media (disc types)

The MP3 file recording media supported by the radio are CD-ROM, CD-R and CD-RW.

Supported medium formats (file systems)

The medium formats supported by the radio are ISO 9660 Level 1 and Level 2 and includes the Joliet extension. When reading discs recorded using formats other than ISO 9660 Level 1 and Level 2, the radio may fail to read files properly and may be unable to play the file normally. UDF and Apple HFS formats are not supported.

The radio uses the following limits for file systems:

- Maximum number of directory levels: 15

- Maximum number of files: 255
- Maximum number of folders: 100
- Maximum number of characters in file/folder names:
 - Level 1: 12 (including a separator "." and a 3-character extension)
 - Level 2: 31 (including a separator "." and a 3-character extension)

Multisession disc formats are supported by the radio. Multisession discs may contain combinations of normal CD audio tracks and computer files (including MP3 files). Discs created with an option such as "keep disc open after writing" are most likely multisession discs. The use of multisession for CD audio or MP3 playback may result in longer disc loading times.

Supported MP3 file formats

The radio will recognize only files with the *.mp3 extension as MP3 files. Non-MP3 files named with the *.mp3 extension may cause playback problems. The radio is designed to recognize the file as an invalid MP3 and will not play the file.

When using the MP3 encoder to compress audio data to an MP3 file, the bit rate and sampling frequencies in the following table are supported. In addition, variable bit rates (VBR) are also supported. The majority of MP3 files use a 44.1 kHz sampling rate and a 192, 160, 128, 96 or VBR bit rates.

MPEG Specification	Sampling Frequency (kHz)	Bit rate (kbps)
MPEG-1 Audio Layer 3	48, 44.1, 32	320, 256, 224, 192, 160, 128, 112, 96, 80, 64, 56, 48, 40, 32
MPEG-2 Audio Layer 3	24, 22.05, 16	160, 128, 144, 112, 96, 80, 64, 56, 48, 40, 32, 24, 16, 8

ID3 Tag information for artist, song title and album title are supported for version 1 ID3 tags. ID3 version 2 is not supported by the radios.

Playlist files are not supported. MP3 Pro files are not supported.

Playback of MP3 files

When a medium containing MP3 data is loaded, the radio checks all files on the medium. If the medium contains a lot of folders or files, the radio will take more time to start playing the MP3 files.

Loading times for playback of MP3 files may be affected by the following:

- Media - CD-RW media may take longer to load than CD-R media
- Medium formats - Multisession discs may take longer to load than non-multisession discs
- Number of files and folders - Loading times will increase with more files and folders

To increase the speed of disc loading, it is recommended to use CD-R media and single-session discs. To create a single-session disc, enable the Disc at Once option before writing to the disc.

Operation Instructions - (CD Mode For MP3 Audio Play)**SEEK Button (CD Mode For MP3 Play)**

Pressing the right side of the SEEK button plays the next MP3 File. Pressing the left side of the SEEK button plays the beginning of the MP3 file. Pressing the button within the first ten seconds plays the previous file.

LOAD/EJECT Button (CD Mode For MP3 Play)**LOAD/ EJECT - Load**

Press the LOAD/ EJECT button and the push-button with the corresponding number where the CD is being loaded. The radio will display PLEASE WAIT and prompt when to INSERT DISC. After the radio displays "LOAD DISC" insert the CD into the player.

Radio display will show "LOADING DISC" when the disc is loading.

LOAD / EJECT - Eject

Press the LOAD/ EJECT button and the push-button with the corresponding number where the CD was loaded and the disc will unload and move to the entrance for easy removal.

Radio display will show "EJECTING DISC" when the disc is being ejected and prompt the user to remove the disc.

If you have ejected a disc and have not removed it within 15 seconds, it will be reloaded. If the CD is not removed, the radio will continue to play the non-removed CD. If the CD is removed and there are other CD's in the radio, the radio will play the next CD. If the CD is removed and there are no other CD's in the radio, the radio will remain in CD mode and display "NO DISC LOADED."

MSG Button (CD Mode For MP3 Play)

Press and MSG button while playing MP3 disc. The radio scrolls through the following TAG information: Song Title, Artist, File Name, and Folder Name (if available).

Press the MSG button once more to return to "elapsed time" priority mode.

Press and hold the MSG button while in the message display priority mode or elapsed time display priority mode will display the song title for each file.

RW/FF (CD Mode For MP3 Play)

Press the FF side of the button to move forward through the MP3 selection.

TUNE Control (CD Mode For MP3 Play)

Pressing the TUNE Control allows the adjustment of Tone, Balance, and Fade.

AM/FM Button (CD Mode For MP3 Play)

Switches back to Radio mode.

RND/ PTY Button (CD Mode For MP3 Play)

Pressing this button plays files randomly.

SET/DIR Button (CD Mode For MP3 Play)

Press the SET/DIR Button to display folders, when playing an MP3 discs that have a file/folder structure. Turn the TUNE control to display available folders or move through available folders. Press the TUNE control to select a folder.

Buttons 1 - 6 (CD Mode For MP3 Play)

Selects disc positions 1 - 6 for Play/Load/Eject.

Operating Instructions - Hands Free Phone (If Equipped)

Refer to Hands Free Phone section of the Owner's Manual.

Operating Instructions - Satellite Radio Mode (If Equipped)

Refer to the Satellite Radio section of the Owner's Manual.

Operating Instructions - Video Entertainment System (VES®) (If Equipped)

Refer to separate Video Entertainment System (VES®) Guide.

SATELLITE RADIO — IF EQUIPPED

Satellite radio uses direct satellite to receive broadcasting technology to provide clear digital sound, coast to coast. The subscription service provider is Sirius™ Satellite Radio. This service offers up to 100 channels of music, sports, news, entertainment, and programming for children, directly from its satellites and broadcasting studios.

System Activation

To activate your Sirius Satellite Radio service, call the toll-free number 888-539-7474, or visit the Sirius web site at www.sirius.com. Please have the following information available when activating your system:

1. The Electronic Serial Number/Sirius Identification Number (ESN/SID).

2. Credit card information.

3. Your Vehicle Identification Number.

Electronic Serial Number/Sirius Identification Number (ENS/SID)

The Electronic Serial Number/Sirius Identification Number is needed to activate your Sirius Satellite Radio system. To access the ESN/SID, refer to the following steps:

ESN/SID Access With REF Radios

With the ignition switch in the ACCESSORY position and the radio OFF, press the Eject or CD Eject (depending on the radio type) and Time buttons simultaneously for 3 seconds. The first four digits of the twelve-digit ESN/SID number will be displayed. Press the SEEK UP button to display the next four digits. Continue to press the SEEK UP button until all twelve ESN/SID digits have been displayed. The SEEK DOWN will page down until the first four digits are displayed. The radio will exit the

ESN/SID mode when any other button is pushed, the ignition is turned OFF, or 5 minutes has passed since any button was pushed.

ESN/SID Access With RAQ Radios

With the ignition switch in the ACCESSORY position and the radio OFF, press the CD Eject and TIME buttons simultaneously for 3 seconds. All twelve ESN/SID numbers will be displayed. The radio will exit the ESN/SID mode when any other button is pushed, the ignition is turned OFF, or 5 minutes has passed since any button was pushed.

Selecting Satellite Mode in REF Radios

Press the MODE button repeatedly until "S A" appears in the display. A CD may remain in the radio while in the Satellite radio mode.

Selecting Satellite Mode in RAQ Radios

Press the MODE button repeatedly until the word "SIRIUS" appears in the display. These radios will also display the following:

- After 3 seconds, the current channel name and channel number will be displayed for 5 seconds.
- The current program type and channel number will then be displayed for 5 seconds.
- The current channel number will then be displayed until an action occurs.

A CD may remain in the radio while in the Satellite radio mode.

Selecting a Channel

Press and release the SEEK or TUNE buttons to search for the next channel. Press the top of the button to search up and the bottom of the button to search down. Holding the TUNE button causes the radio to bypass channels until the button is released.

Press and release the SCAN button (if equipped) to automatically change channels every 7 seconds. The radio will pause on each channel for 7 seconds before moving on to the next channel. The word "SCAN" will appear in the display between each channel change. Press the SCAN button a second time to stop the search.

NOTE: Channels that may contain objectionable content can be blocked. Contact Sirius Customer Care at 888-539-7474 to discuss options for channel blocking or unblocking. Please have your ESN/SID information available.

Storing and Selecting Pre-Set Channels

In addition to the 10 AM and 10 FM pre-set stations, you may also commit 10 satellite stations to push button memory. These satellite channel pre-set stations will not erase any AM or FM pre-set memory stations. Follow the memory pre-set procedures that apply to your radio.

Using the PTY (Program Type) Button (if equipped)

Follow the PTY button instructions that apply to your radio.

PTY Button "SCAN"

When the desired program type is obtained, press the "SCAN" button within five seconds. The radio will play 7 seconds of the selected channel before moving to the next channel of the selected program type. Press the "SCAN" button a second time to stop the search.

NOTE: Pressing the "SEEK" or "SCAN" button while performing a music type scan will change the channel by

one and stop the search. Pressing a pre-set memory button during a music type scan, will call up the memory channel and stop the search.

PTY Button "SEEK"

When the desired program is obtained, press the "SEEK" button within five seconds. The channel will change to the next channel that matches the program type selected.

Satellite Antenna

To ensure optimum reception, do not place items on the roof around the rooftop antenna location. Metal objects placed within the line of sight of the antenna will cause decreased performance. Larger luggage items should be placed as far forward as possible. Do not place items directly on or above the antenna.

Reception Quality

Satellite reception may be interrupted due to one of the following reasons.

- The vehicle is parked in an underground parking structure or under a physical obstacle.
- Dense tree coverage may interrupt reception in the form of short audio mutes.
- Driving under wide bridges or along tall buildings can cause intermittent reception.
- Placing objects over or too close to the antenna can cause signal blockage.

REMOTE SOUND SYSTEM CONTROLS — IF EQUIPPED

The remote sound system controls are located on the rear surface of the steering wheel. Reach behind the wheel to access the switches.

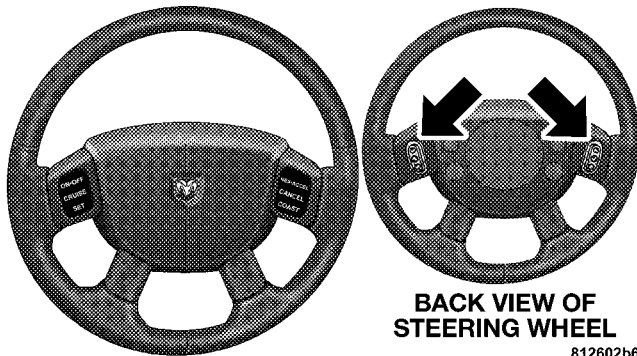

The right hand control is a rocker type switch with a push button in the center. Pressing the top of the switch will increase the volume and pressing the bottom of the switch will decrease the volume.

The button located in the center of the right hand control will switch modes to Radio or CD.

The left hand control is a rocker type switch with a push button in the center. The function of the left hand control is different depending on which mode you are in.

The following describes the left hand control operation in each mode.

Radio Operation

Pressing the top of the switch will SEEK up for the next listenable station and pressing the bottom of the switch will SEEK down for the next listenable station.

The button located in the center of the left hand control will tune to the next pre-set station that you have programmed in the radio pre-set push-buttons.

CD Player

Pressing the top of the switch once will go to the next track on the CD. Pressing the bottom of the switch once will go to the beginning of the current track or to the beginning of the previous track if it is within one second after the current track begins to play.

If you press the switch up or down twice it plays the second track, three times, it will play the third, etc.

The button in the center of the left hand switch changes CD's on the 6-Disc in-dash CD changer radio. This button does not function for all other radios.

COMPACT DISC MAINTENANCE

To keep the compact discs in good condition, take the following precautions:

1. Handle the disc by its edge; avoid touching the surface.
2. If the disc is stained, clean the surface with a soft cloth, wiping from center to edge.
3. Do not apply paper or tape to the disc; avoid scratching the disc.
4. Do not use solvents such as benzine, thinner, cleaners, or antistatic sprays.
5. Store the disc in its case after playing.
6. Do not expose the disc to direct sunlight.
7. Do not store the disc where temperatures may become too high.

NOTE: If you experience difficulty in playing a particular disc, it may be damaged (i.e. scratched, reflective coating removed, a hair, moisture or dew on the disc) oversized, or have theft protection encoding. Try a known good disc before considering disc player service.

RADIO OPERATION AND CELLULAR PHONES

Under certain conditions, the cellular phone being On in your vehicle can cause erratic or noisy performance from your radio. This condition may be lessened or eliminated by relocating the cellular phone antenna. This condition is not harmful to the radio. If your radio performance does not satisfactorily “clear” by the repositioning of the antenna, it is recommended that the radio volume be turned down or off during cellular phone operation.

CLIMATE CONTROLS

Manual Control

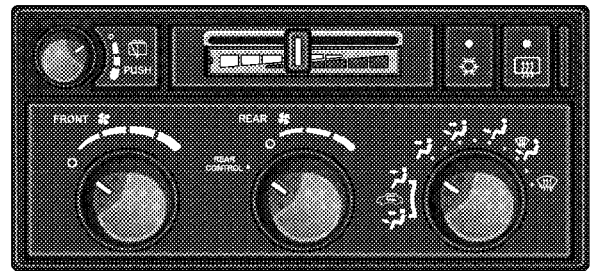

811a5530

The Air Conditioning and Heating System is designed to make you comfortable in all types of weather. The following describes its operation:

Air Conditioning Operation



To turn the air conditioning On or Off perform the following steps:

- Position the mode control button to the desired airflow setting.
- Set the front blower control to any desired speed.
- Press the Snowflake (A/C) button which is located to the right of the temperature control slide. An indicator light on the Snowflake (A/C) button shows that the air conditioning is On.
- Press the Snowflake (A/C) button a second time to turn the air conditioning Off.

NOTE: The compressor will not engage until the engine has been running for several seconds. Slight changes in

engine speed or power may be noticed when the compressor is on. This is a normal occurrence since the compressor will cycle on and off to maintain comfort and improve fuel economy.

Front Blower Control

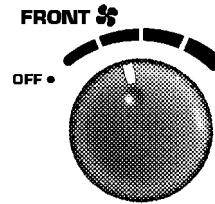

80a01400

in recirculation mode.

The Front Blower controls the amount of air delivered to the passenger compartment. There are four blower speeds. The fan speed increases as you move the control clockwise. When the front blower control is turned to OFF, the blower will be turned off and the system will be positioned

Front Mode Control



811b8660

The mode control allows you to choose from several patterns of air distribution.

NOTE: To improve your selection choices, the system allows you to operate at intermediate positions between the major modes. These intermediate positions are identified by the small dots and give an even blend of both modes.

Recirculation Mode (Panel or Bi-Level)

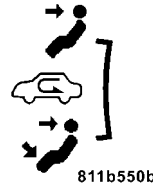

811b550b

Select either the Panel or Bi-Level mode positions when the outside air contains smoke, odors, high humidity, or if rapid cooling of the interior is desired. This feature allows for recirculation of interior air only. Air flows through the panel outlets or panel and

floor outlets in these modes.

Panel

➔ Outside air flows through the outlets located in the instrument panel. These outlets can be adjusted to direct the airflow.

Bi-Level

➔ Air flows through the outlets located in the instrument panel and those located on the floor.

NOTE: There is a difference in temperature between the upper and lower outlets for added comfort. The warmer air goes to the floor outlets. This feature gives improved comfort during sunny but cool conditions.

Heat (Floor)

 Outside air flows primarily through the floor outlets located under the instrument panel. A small amount of air is directed through the defrost and side window demister outlets.

Mix

 Outside air flows in equal proportions through the floor and defroster outlet.

Defrost

 Outside air is primarily directed to the windshield through the defroster outlet located at the base of the windshield and side window demister outlets.

NOTE: The air conditioning compressor operates in both Mix and Defrost or a blend of these modes, even if the A/C button has not been pressed. This dehumidifies the air to help dry the windshield.

Temperature Control

The temperature of the air is controlled by a slide located on the top center of the control panel. Move the slide left or right to change the temperature. The blue area of the scale indicates cooler temperatures while the red area indicates warmer temperatures.

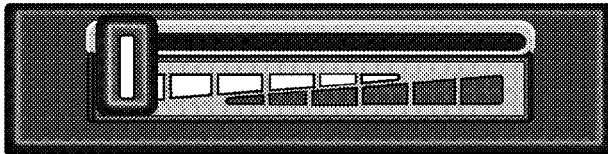

81228299

Rear Temperature Control — If Equipped

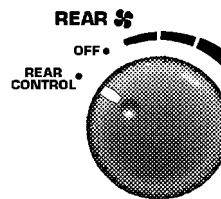

80a01401

Rotating this knob left to the “REAR CONTROL” position allows the passengers in the second and third row seats to control the blower speed and temperature by means of the rear control located in the rear of the center floor console as described under “Rear Zone Control.” Rotating this knob to the “OFF” position, turns off the rear climate controls. Rotating this knob to the right of the “OFF” position allows the Driver and front passenger to control the rear blower speed, and the rear temperature using the front temperature slide. The mode, front or rear, is always controlled by the front mode control. For example: Panel

mode on the front control will give you air from the outlets in the headliner in the rear. Floor mode in the front will give you floor in the rear.

Rear Window Defrosting and Rear Window Washer/Wiper

See the “Rear Window Features” section of this book.

Automatic Temperature Control (ATC) — If Equipped

The control can be turned on by pressing the POWER button. When the control is turned on, it will be in the last mode prior to being turned off. Pressing the POWER button again will turn off the control. The control can also be turned on by pressing any button and it will display the corresponding operating mode for that button.



811a5697

Automatic Control

The ATC system can maintain a steady comfort level in various weather conditions with a simple operation:

- Select your desired temperature setting by pressing the + or - side of the TEMP rocker switch.

The ATC system uses an infrared sensor located in the overhead console to measure the temperature of the driver. Based on the sensor input, the system will automatically control comfort by varying the temperature, fan speed, and mode. This maintains a comfortable temperature, even under changing conditions. It is important that the infrared sensor is kept clean and that objects are not blocking the sensor. It is also important that objects are not used that may scratch or damage it in any way.

Level Of Automatic Control

72°F (22°C) is the recommended setting for maximum comfort for the average person, however, this may vary.

NOTE: The temperature setting can be adjusted at any time without affecting automatic control operation. It is not necessary to move the temperature setting for cold or hot vehicles. The system automatically adjusts the temperature, mode and fan speed to provide comfort as quickly as possible.

NOTE: In cold weather, the fan will not turn on in AUTO mode until the engine coolant has warmed up sufficiently. This is indicated by the WARM UP DELAY message on the display.

NOTE: The temperature can be displayed in U.S. or Metric by selecting the US/M customer programmable feature. Refer to the "Overhead Console-Customer Programmable Features." The mode will also be shown in the display and will change as required during automatic operation.

NOTE: The system can be put into recirculate mode without affecting ATC operation. This will prevent outside air from entering the vehicle. Use this mode to temporarily block out any outside odors, smoke, or dust.

Manual Control (ATC)

You also may choose to customize your comfort by selecting the fan speed and mode manually. Pressing the fan speed button or any mode button places the system into manual operation.

While in manual operation there are six fan speeds available and the choice of any mode. The airflow temperature is adjusted automatically to maintain the desired comfort level. You can adjust the temperature by pressing the + or - TEMP rocker switch.

FAN Control

 Use this button to regulate the amount of air delivered through the system in any mode you select. Press the + or - side of the button to increase or decrease fan speed.

Air Conditioning Operation

 Press this button to turn on the air conditioning compressor. A snowflake symbol in the display

shows that the compressor is on. Compressor operation is automatic when you press the AUTO button and no snowflake is shown.

The compressor can operate at any temperature above 32°F (0°C).

NOTE: The compressor will not engage until the engine has been running for several seconds. Slight changes in engine speed or power may be noticed when the compressor is on. This is a normal occurrence since the compressor will cycle on and off to maintain comfort and improve fuel economy.

Recirculate Button

Press this button to recirculate the air inside the vehicle. Outside air is prevented from entering the vehicle. Use this mode to temporarily block out any outside odors, smoke, dust or when rapid cooling of the interior is required.

Manual control of Recirculation is possible only in Panel, Floor, and Bi-Level modes. It will not operate in Mix, or Defrost modes. The recirculation symbol will flash three times indicating recirculation is not available in these modes.

NOTE: If the interior of the windows begin to fog, press the recirculate button to return to outside air. Some conditions will cause captured interior air to fog windows when in recirculate mode.

Panel

 Outside air flows through the outlets located in the instrument panel. These outlets can be adjusted to direct the airflow.

Floor (Heat)

 Outside air flows primarily through the floor outlets located under the instrument panel. A small amount of air is directed through the defrost and side window demister outlets.

Mix

 Outside air flows in equal proportions through the floor and defroster outlets.

Bi-Level

 Air flows through the outlets located in the instrument panel and those located on the floor.

NOTE: There is a difference in temperature between the upper and lower outlets for added comfort. The warmer air goes to the floor outlets. This feature gives improved comfort during sunny but cool conditions.

Defrost

 Outside air is primarily directed to the windshield through the defroster outlets located at the base of the windshield and side window demist outlets.

NOTE: The air conditioning compressor operates in both Mix and Defrost or a blend of these modes, even if

the A/C snowflake button has not been pressed. This dehumidifies the air to help dry the windshield.

Rear Temperature Control (ATC)

The "REAR FUNCTIONS" button cycles through the following modes:

Rear Control from Front

This allows the driver or passenger to control the rear blower speeds using the FAN +/- rocker switch and the rear temperature using the TEMP +/- rocker switch. While in this mode, pressing the POWER button will turn the rear system off. Pressing the POWER, TEMP or FAN buttons will turn the rear system back on.

NOTE: The display will show a "REAR" fan speed graph and a "REAR" temperature graph.

CONTROL IN REAR

This allows the passengers in the second row seats to control the blower speed and temperature by means of

the rear control located in the rear of the center floor console as described under the "Rear Zone Climate Control."

NOTE: The display will show "CONTROL IN REAR."

REAR OFF

This turns the rear system off. The control will return to the front system display after approximately 5 seconds if no buttons are pushed while in one of the rear system displays. You may also return to the front system display sooner by pushing any button except the POWER, REAR, TEMP or FAN buttons.

NOTE: The display will show "REAR OFF."

Rear Window Defrosting and Rear Window Washer/Wiper

See the "Rear Window Features" section of this book.

Rear Zone Climate Control — If Equipped

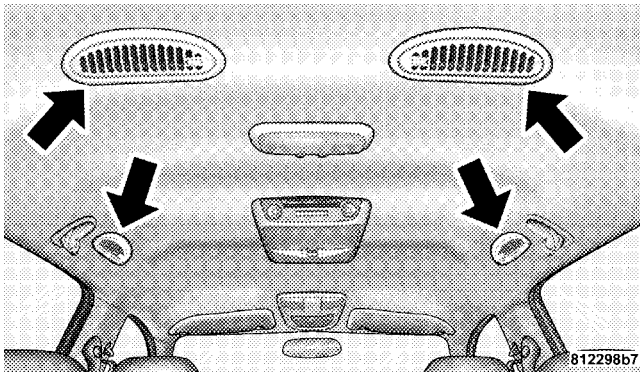

Headliner air comes from the outlets in the headliner. Each of these outlets can be individually adjusted to direct the flow of air. Moving the air vane knobs on the outlets to one side will shut off the airflow.

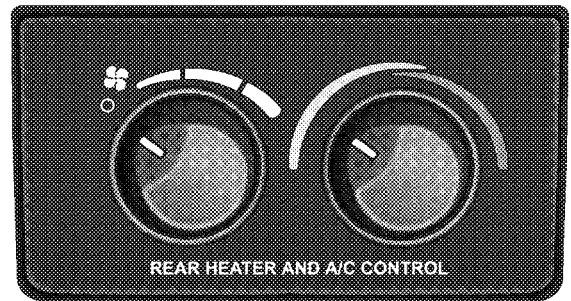

811aa87d

The rear compartment control uses two rotary knobs: one for the temperature control and the other for the fan speed control. The mode for the rear air conditioning and heating system is always controlled by the front control unit. Fan and temperature can be controlled from the front control unit or the rear control unit.

Rear Rotary Blower Control

The second row seat occupants have control of the rear blower speed, only when the front control unit is in the “REAR CONTROL” position.

The rear blower switch has an “Off” position and a range of blower speeds. Rotating the rear blower control clockwise will increase the blower speed.

Rear Rotary Temperature Control

The second row seat occupants have control of the rear temperature control, only when the front control unit is in the “REAR CONTROL” position.

To change the temperature in the rear of the vehicle, rotate the temperature control knob to the right or left. The blue area indicates cooler temperatures while the red area indicates warmer temperatures.

NOTE: For best operation, make sure that ventilation grilles located in the rear storage area are not obstructed by stowed articles.

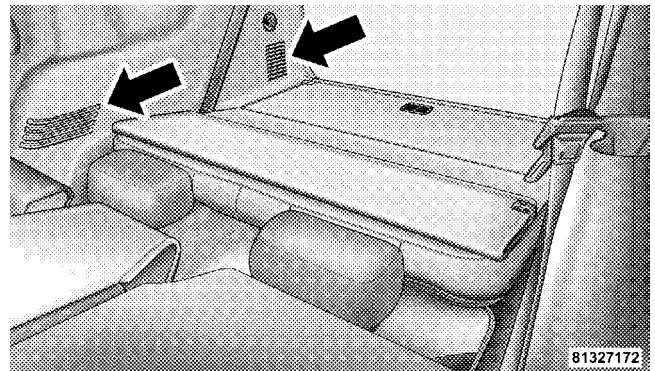

Front Unit to Rear Unit Chart

If the Front Control is selected	Rear Airflow will come from
Panel	Headliner
Bi-Level	Headliner
• Between Bi-Level Floor	Bi-Level
Floor	Floor
Mix	Floor
Defrost	Floor

Operating Tips**Fast Cooldown**

For a fast cooldown, set the blower fan to the highest setting, set the mode control to the panel fresh position, press the snowflake button to turn on the air conditioning, and drive with the windows open for the first few minutes. Once the hot air has been expelled, close the windows and set the mode selector to the Recirculation

panel or Recirculation Bi-level position. When a comfortable condition has been reached, choose a mode position and adjust the temperature control and blower speed as necessary to maintain comfort. For high humidity conditions it may be necessary to remain in the Recirculation mode to maintain comfort.

Window Fogging

Windows will fog on the inside when the humidity inside the vehicle is high. This often occurs in mild or cool temperatures when it's rainy or humid. In most cases turning on the Air-conditioning (pressing the snowflake button) will clear the fog. Adjust the temperature control, air direction and blower speed to maintain comfort.

As the temperature gets colder it may be necessary to direct air onto the windshield by using MIX Mode position on the control. Adjust the temperature control

and blower speed to maintain comfort. Interior fogging on the windshield can be quickly removed by selecting the defrost mode.

Regular cleaning of the inside of the windows with a non-filming cleaning solution (vinegar and water works very well) will help prevent contaminants (cigarette smoke, perfumes, etc.) from sticking to the windows. Contaminates increase the rate of window fogging.

Summer Operation











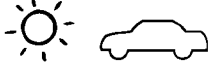













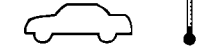

Air conditioned vehicles must be protected with a high quality antifreeze coolant during summer to provide proper corrosion protection and to raise the boiling point of the coolant for protection against overheating. A 50 % concentration is recommended.

When using the air conditioner in extremely heavy traffic in hot weather especially when towing a trailer, additional engine cooling may be required. If this situation is encountered, operate the transmission in a lower gear. When stopped in heavy traffic, it may be necessary to shift into NEUTRAL and press the accelerator slightly for fast idle operation.

Winter Operation

When operating the system during the winter months, make sure the air intake, located directly in front of the windshield, is free of ice, slush, snow, or other obstructions.

Operating Tips Chart

WEATHER	CONTROL SETTINGS
<p>HOT WEATHER AND VEHICLE INTERIOR IS VERY HOT</p> 	<p>Start the vehicle, open the windows and turn the blower control to the high position. Set Mode control at  or . Set temperature control to full cold and press the  button on. After the hot air has been expelled, close the windows and set the mode control to the  setting at either  or , or press the  button (if equipped). Once comfortable, choose a mode position and adjust temperature control and blower speed as necessary for comfort.</p>
<p>WARM WEATHER</p> 	<p>If sunny, set the Mode control at  and press the  button on. If cloudy or dark, set the Mode control at . No  is necessary.</p>
<p>COOL OR COLD HUMID CONDITIONS</p> 	<p>If sunny, set the Mode control at  or , then press the  button on. If cloudy or dark set the Mode control at . No  is necessary.</p>
<p>COLD DRY CONDITIONS</p> 	<p>In cloudy or dark weather set the Mode control at . If sunny, set the Mode control at  or , and for snowy or very cold weather requiring extra heat to the windshield, use .</p>
<p>WINDOW FOGGING</p>	<p>In most cases turning on the Air-Conditioning (press the  button) will clear the fog, then adjust temperature control, air direction and blower speed to maintain comfort. As it gets colder it may be necessary to direct air onto the windshield. If so, set the Mode control at  or  and adjust temperature control and blower speed to maintain comfort. Higher blower speeds will reduce fogging.</p>

812d6363

REAR WINDOW FEATURES

Rear Window Wiper/Washer

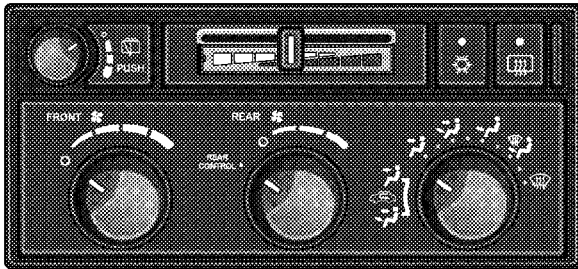

811a5530



811a5697



A rotating switch located on the climate control panel turns the rear wiper On or Off. Pressing the rotating switch inward activates the rear window washer. Rotating the switch will enable one of five intermittent delay times for the rear wiper. The delay times range from 20 to 1 second.

If the rear wiper is operating when the ignition is turned off, the wiper will automatically return to the “Park” position. When the vehicle is restarted, the wiper will resume operation.

Rear Window Defrosting



A push-button type switch is located in the climate control panel. Press the switch and the rear window defroster and electric remote control heated mirrors (if equipped) will turn On. An amber indicator on the push-button will light when the defroster is turned On. An symbol will be displayed when the defroster is turned on with an ATC control. Push again to turn Off prior to time-out. The defroster will automatically turn Off after fifteen minutes. For ten more minutes of operation, push the button again. To prevent excessive battery drain, use the defroster only when the engine is operating.

CAUTION!

Use care when washing the inside of the rear window to prevent damage to heating elements. Use a soft cloth and a mild washing solution, wiping parallel to the heating elements. Also, keep all objects a safe distance from the window to prevent damaging the heating elements.

STARTING AND OPERATING

CONTENTS

■ Starting Procedures	200	□ Shifting Procedure - NV 144 Transfer Case . . .	210
□ Automatic Transmission	200	□ NV 244 Generation II Transfer Case Operating Information / Precautions	211
□ Normal Starting	201	□ Shifting Procedure - NV 244 Generation II Transfer Case	215
□ Engine Block Heater — If Equipped	202	■ Parking Brake	217
■ Automatic Transmission	203	■ Brake System	218
□ Automatic Transmission	203	□ Four-Wheel Anti-Lock Brake System (ABS) . . .	218
■ Four-Wheel Drive Operation	208	■ Power Steering	220
□ NV 144 Transfer Case Operating Information/Precautions	208	■ Rocking The Vehicle	221

■ Tire Safety Information	221	□ Alignment And Balance	238
□ Tire Markings	221	■ Supplemental Tire Pressure Information	239
□ Tire Identification Number (TIN)	225	■ Tire Chains	239
□ Tire Loading And Tire Pressure	226	■ Snow Tires	240
■ Tires—General Information	230	■ Tire Rotation Recommendations	241
□ Tire Pressure	230	■ Fuel Requirements	242
□ Tire Inflation Pressures	231	□ Reformulated Gasoline	243
□ Radial-Ply Tires	234	□ Gasoline/Oxygenate Blends	243
□ Compact Spare Tire — If Equipped	234	□ MMT In Gasoline	244
□ Limited Use Spare — If Equipped	235	□ Sulfur In Gasoline	244
□ Tire Spinning	236	□ Materials Added To Fuel	245
□ Tread Wear Indicators	236	□ Adding Fuel	245
□ Replacement Tires	237	□ Fuel System Cautions	247

□ Carbon Monoxide Warnings	248	□ Trailer Towing Requirements	258
■ Catalytic Converter	249	□ Trailer Tow Wiring	259
■ Vehicle Loading	250	□ Cooling System Tips—Trailer Towing	260
□ Certification Label	250	■ Snowplow	261
□ Curb Weight	252	□ Dodge Durango Models	261
□ Loading	252	■ Recreational Towing (Behind Motorhome, Etc.) Of 4X4 Vehicles	262
■ Trailer Towing	254	□ Shifting Into Neutral (N)	263
□ Definitions	254	□ Shifting Out Of Neutral (N)	265
□ Trailer And Tongue Weight	256	■ Traction	267
□ Gross Combined Vehicle Weight Rating (GCWR)	257	■ Equipment Identification Plate	267
□ Trailer Towing—Hitches	257		
□ Trailer Towing Information (Maximum Trailer Weight Ratings)	258		

STARTING PROCEDURES

The starter should not be operated for more than 15-second intervals. Waiting a few seconds between such intervals will protect the starter from overheating.

Automatic Transmission

Start the engine with the selector lever in NEUTRAL or PARK position. Apply the brake before shifting to any driving range.

WARNING!

Do not attempt to push or tow your vehicle to get it started. Vehicles equipped with an automatic transmission cannot be started this way. Unburned fuel could enter the catalytic converter and once the engine has started, ignite and damage the converter and vehicle. If the vehicle has a discharged battery, booster cables may be used to obtain a start from a booster battery or the battery in another vehicle. This type of start can be dangerous if done improperly. See section 6 of this manual for the proper jump starting procedures and follow them carefully.

Normal Starting

Normal Starting of either a warm or cold engine is obtained without pumping or depressing the accelerator pedal. Turn the key to the START position and release when the engine starts. If the engine fails to start within 10 seconds, turn the key to the OFF position, wait 5 seconds, then repeat the starting procedure.

If Engine Fails To Start

If the engine fails to start after you have followed the Normal Starting procedure, it may be flooded. Push the accelerator pedal all the way to the floor and hold it there while cranking the engine. This should clear any excess fuel in case the engine is flooded.

CAUTION!

To prevent damage to the starter, do not crank the engine for more than 15 seconds at a time. Wait 10 to 15 seconds before trying again.

If the engine has been flooded, it may start to run, but not have enough power to continue running when the key is released. If this occurs, continue cranking with the accelerator pedal pushed all the way to the floor. Release the accelerator pedal and the key once the engine is running smoothly.

If the engine shows no sign of starting after two 15 second periods of cranking with the accelerator pedal held to the floor, the Normal Starting procedure should be repeated.

WARNING!

Never pour fuel or other flammable liquid into the throttle body air inlet opening in an attempt to start the vehicle. This could result in flash fire causing serious personal injury.

After Starting

The idle speed is automatically controlled on fuel injected engines and will decrease as the engine warms up.

CAUTION!

Long periods of engine idling can cause excessive exhaust temperatures which can damage your vehicle. Do not leave your vehicle unattended with the engine running.

WARNING!

Do not leave children or animals inside parked vehicles in hot weather. Interior heat build up may cause serious injury or death.

Engine Block Heater — If Equipped

The engine block heater warms engine coolant and permits quicker starts in cold weather. Connect the cord to a standard 110-115 volt AC electrical outlet with a grounded, three wire extension cord.

The 3.7L/4.7L engine block heater cord is located at the front of the engine compartment near the radiator cap. The 5.7L engine block heater cord is located on the left side of the engine compartment and rearward of the power distribution center.

WARNING!

Remember to disconnect the cord before driving. Damage to the 110-115 volt electrical cord could cause electrocution.

AUTOMATIC TRANSMISSION**Automatic Transmission**

The electronic PRNDL on the instrument cluster indicates the transmission gear selected. The selector lever is mounted on the right side of the steering column. To drive, move the selector lever from Park or Neutral to the desired drive position. Pull selector lever toward you when shifting into Reverse, Second, First or Park, or when shifting out of Park.

Brake/Transmission Interlock System

This system prevents you from moving the gear shift out of Park and into any gear unless the brake pedal is pressed. This system is active only while the ignition switch is in the ON position. Always depress the **brake pedal first**, before moving the gear selector out of PARK.

Gear Ranges

DO NOT race the engine when shifting from Park or Neutral position into another gear range.

“P” Park

Supplements parking brake by locking the transmission. Engine can be started in this range. Never use Park while vehicle is in motion. Apply parking brake when leaving vehicle in this range. Always apply parking brake first, then place selector in Park position.

WARNING!

Your vehicle could move and injure you and others if it is not completely in P (Park). Check by trying to move the gearshift lever back and forth without first pulling the lever toward you, after you have set it in P (Park). Make sure it is in Park before leaving the vehicle.

WARNING!

Never use Park position on an automatic transmission as a substitute for the parking brake. Always apply parking brake fully when parked to guard against vehicle movement and possible injury or damage.

WARNING!

It is dangerous to shift the selector lever out of “P” or “N” if the engine speed is higher than idle speed. If your foot is not firmly on the brake pedal, the vehicle could accelerate quickly forward or in reverse. You could lose control of the vehicle and hit someone or something. Only shift into gear when the engine is idling normally and when your right foot is firmly on the brake pedal.

“R” Reverse

Use this range only after the vehicle has come to a complete stop.

“N” Neutral

Shift to Neutral when vehicle is standing for prolonged periods with engine running. Engine may be started in this range. Set the parking brake if you must leave the vehicle.

“D” Drive

For most city and highway driving.

“2” Second

For driving slowly in heavy city traffic or on mountain roads where more precise speed control is desirable. Use it also when climbing long grades, and for engine braking when descending moderately steep grades. To prevent excessive engine speed do not exceed 45 miles per hour (72 km/h) in this range.

“1” First

For driving up very steep hills and for engine braking at low speeds 25 mph (40 km/h) or less when going down hill. To prevent excessive engine speed do not exceed 25 mph (40 km/h) in this range.

Overdrive Operation

The overdrive automatic transmission contains an electronically controlled fourth and fifth (if equipped) speed (Overdrive). The transmission will automatically shift from Drive to Overdrive if the following conditions are present:

- the transmission selector is in Drive;
- the engine coolant has reached normal operating temperature;
- vehicle speed is above approximately 30 mph (48 km/h);
- the “TOW/HAUL” switch has not been activated;

- transmission has reached normal operating temperature.

NOTE: If the vehicle is started in extremely cold temperatures, the transmission may not shift into Overdrive and will automatically select the most desirable gear for operation at this temperature. Normal operation will resume when the transmission fluid temperature has risen to a suitable level. Refer also to the Note under torque converter clutch, later in this section.

If the transmission temperature gets extremely hot, the transmission will automatically select the most desirable gear for operation at this temperature. If the transmission temperature becomes hot enough the TRANS TEMP light may illuminate and the transmission may downshift out of Overdrive until the transmission cools down. After cooldown, the transmission will resume normal operation.

The transmission will downshift from Overdrive to Drive if the accelerator pedal is fully depressed at vehicle speeds above approximately 35 mph (56 km/h).

When To Use “TOW/HAUL” Mode

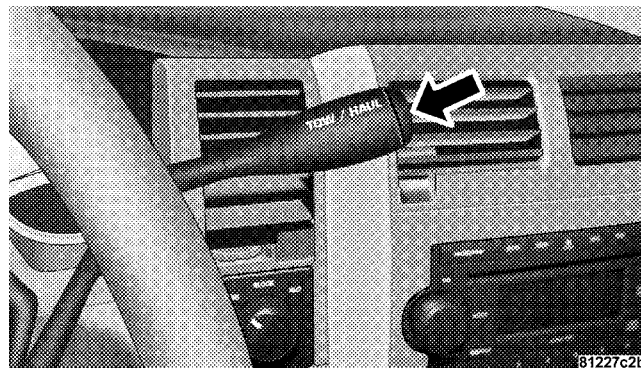

When driving in hilly areas, towing a trailer, carrying a heavy load, etc., and frequent transmission shifting occurs, press the “TOW/HAUL” button. This will improve

performance and reduce the potential for transmission overheating or failure due to excessive shifting. When operating in "TOW/HAUL" mode, 5th gear (if equipped) is disabled and 2-3 and 3-4 shift patterns are modified. Shifts into Overdrive (4th gear) are allowed during steady cruise (for improved fuel economy) and automatic closed-throttle downshifts to 3rd gear (for improved braking) will occur during steady braking.

The "TOW/HAUL" light will illuminate in the instrument cluster to indicate when the switch has been activated. Pressing the switch a second time restores normal operation. If the "TOW/HAUL" mode is desired, the button must be pressed each time the engine is started.

Torque Converter Clutch

A feature designed to improve fuel economy is included in all automatic transmissions. A clutch within the torque converter engages automatically at a calibrated speed at

light throttle. It engages at higher speeds under heavier acceleration. This may result in a slightly different feeling or response during normal operation in high gear. When the vehicle speed drops below a calibrated speed, or during acceleration, the clutch automatically and smoothly disengages. The feature is operational in Overdrive and in Drive.

NOTE: The torque converter clutch will not engage until the transmission fluid and engine coolant are warm [usually after 1-3 miles (1.6 - 4.8 km) of driving]. Because the engine speed is higher when the torque converter clutch is not engaged, it may seem as if the transmission is not shifting into Overdrive when cold. This is normal. Pressing the "TOW/HAUL" button, when the transmission is sufficiently warm, will demonstrate that the transmission is able to shift into and out of Overdrive.

NOTE: If the vehicle has not been driven in several days, the first few seconds of operation after shifting the

transmission into gear may seem sluggish. This is due to the fluid partially draining from the torque converter into the transmission. This condition is normal and will not cause damage to the transmission. The torque converter will refill within five seconds of shifting from Park into any other gear position.

FOUR-WHEEL DRIVE OPERATION

NV 144 Transfer Case Operating Information/Precautions

The NV 144 is an electric shift transfer case and is operated by the Four-Wheel-Drive (4WD) Control Switch, which is located on the instrument panel.

The NV 144 transfer case provides 2 mode positions: All-Wheel Drive (AWD) and 4-Wheel-Drive LOCK.

The NV 144 transfer case is designed to be driven in for AWD for normal street and highway conditions (all road surfaces roads).

When additional traction is required, the transfer case 4LOCK position can be used to lock the front and rear driveshafts together and force the front and rear wheels to rotate at the same speed. This is accomplished by rotating the 4WD Control Switch to the 4LOCK position - see Shifting Procedure section for specific shifting instructions. The 4LOCK position is designed for loose, slippery road surfaces only. Driving in the 4LOCK position on dry hard surfaced roads may cause increased tire wear and damage to the driveline components.

Transfer Case Position Indicator Lights

Transfer case position indicator lights are located on the instrument cluster, and indicate the current and desired transfer case selection. If there are no indicator lights on or flashing the transfer case position is All-Wheel Drive (AWD).

The "SVC 4WD" warning light monitors the electric shift 4WD system. If this light remains on after engine start up

or illuminates during driving, it means that the 4WD system is not functioning properly and that service is required.

WARNING!

Always engage the parking brake when powering down the vehicle if the "Service 4WD" light is illuminated. Not engaging the parking brake may allow the vehicle to roll which may cause personal injury.

NOTE: Do not attempt to make a shift while only the front or rear wheels are spinning. The NV 144 transfer case is not equipped with a synchronizer and therefore the front and rear driveshaft speeds must be equal for the shift to take place. Shifting while only the front or rear wheels are spinning can cause damage to the transfer case.

Proper operation of four-wheel-drive vehicles depends on tires of equal size, type and circumference on each wheel. Any difference in tire size can cause damage to the transfer case.

Because four-wheel-drive provides improved traction, there is a tendency to exceed safe turning and stopping speeds. Do not go faster than road conditions permit.

For additional information on the appropriate use of each transfer case mode position see the information below:

5

AWD

Normal All-Wheel-Drive High Range - Employs inter-axle differential. Allows front and rear wheels to rotate at different speeds. All road surfaces.

4LOCK

Four-Wheel-Drive LOCK - Locks the front and rear driveshafts together. Forces the front and rear wheels to rotate at the same speed. Additional traction for loose, slippery road surfaces only.

Shifting Procedure - NV 144 Transfer Case

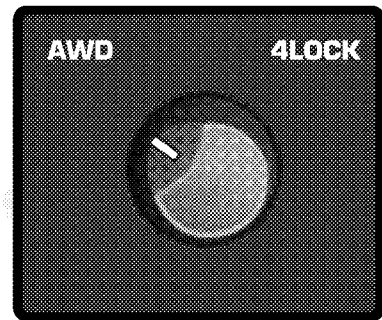

8122be8d

AWD to 4LOCK or 4LOCK to AWD

With the key ON and the engine either OFF or RUNNING, rotate the transfer case switch, located on the instrument panel to the desired position.

NOTE: Delayed shifting out of 4LOCK may be experienced due to uneven tire wear, low tire pressure, or excessive vehicle loading.

NOTE: If any of the requirements to select a new transfer case position have not been met, the transfer case will not shift. The indicator light will flash and the current transfer case position will be maintained. To retry a selection, turn the control knob back to the current position, wait five (5) seconds, and retry the shift.

NOTE: The 4x4 system will not allow shifts between 2WD/AWD if the rear wheels are spinning (no traction). In this situation the position indicator light will continue to flash. At this time, reduce speed and stop spinning the wheels to complete the shift. There may be a delay up to 13 seconds for the shift to complete after the wheels have stopped spinning.

NOTE: The ignition key must be ON for a shift to take place and for the position indicator lights to be operable.

If the key is not ON then the shift will not take place and no position indicator lights will be on or flashing.

NV 244 Generation II Transfer Case Operating Information / Precautions

The NV 244 Generation II is an electric shift transfer case and is operated by the 4WD Control Switch, which is located on the instrument panel.

The NV 244 Generation II transfer case provides 4 mode positions - Normal all-wheel-drive high range, four-wheel-drive LOCK, four-wheel-drive low range, and neutral.

This transfer case is equipped with an inter-axle differential that allows driving the vehicle in the normal all-wheel-drive position (AWD) at all times on any given road surface, including dry hard surfaced roads. The AWD mode allows the front and rear wheels to rotate at different speeds. This eliminates driveline binding and component wear normally associated with driving the

vehicle in the 4LOCK position on dry hard surfaced roads. This feature provides the safety, security, and convenience of operating in all-wheel drive at all times regardless of road conditions.

When additional traction is required, the 4LOCK and 4LO positions can be used to lock the front and rear driveshafts together through the transfer case inter-axle differential and force the front and rear wheels to rotate at the same speed. This is accomplished by rotating the 4WD Control Switch to these positions. The 4LOCK and 4LO positions are intended for loose, slippery road surfaces only. Driving in the 4LOCK and 4LO positions on dry hard surfaced roads may cause increased tire wear and damage to the driveline components.

The transfer case Neutral (N) position is selected by depressing the recessed button located on the lower left hand corner of the 4WD Control Switch.

NOTE: The transfer case Neutral (N) position is to be used for recreational towing only. See Recreational Towing section for specific procedures on shifting into and out of Neutral (N).

Transfer Case Position Indicator Lights

Transfer case position indicator lights are located on the instrument cluster. If there are no indicator lights on or flashing the transfer case position is All-Wheel Drive (AWD) and indicate the current and desired transfer case selection (4HI ⇌ 4LOCK).

The “SVC 4WD” warning light monitors the electric shift 4WD system. If this light remains on after engine start up or illuminates during driving, it means that the 4WD system is not functioning properly and that service is required.

WARNING!

Always engage the parking brake when powering down the vehicle if the "Service 4WD" light is illuminated. Not engaging the parking brake may allow the vehicle to roll which may cause personal injury.

NOTE: Do not attempt to make a shift while only the front or rear wheels are spinning. The NV 244 Generation II transfer case is not equipped with a synchronizer and therefore the front and rear driveshaft speeds must be equal for the shift to take place. Shifting while only the front or rear wheels are spinning can cause damage to the transfer case.

When operating your vehicle in 4LO, the engine speed is approximately three times that of the AWD or 4LOCK positions at a given road speed. Take care not to over-speed the engine and do not exceed 40 km/h (25 mph).

Proper operation of four-wheel-drive vehicles depends on tires of equal size, type and circumference on each wheel. Any difference in tire size can cause damage to the transfer case.

Because four-wheel drive provides improved traction, there is a tendency to exceed safe turning and stopping speeds. Do not go faster than road conditions permit.

WARNING!

You or others could be injured if you leave the vehicle unattended with the transfer case in the Neutral (N) position without first fully engaging the parking brake. The transfer case Neutral (N) position disengages both the front and rear driveshafts from the powertrain and will allow the vehicle to move regardless of the transmission position. The parking brake should always be applied when the driver is not in the vehicle.

For additional information on the appropriate use of each transfer case mode position see the information below:

AWD

Normal All-Wheel-Drive High Range - Employs inter-axle differential. Allows front and rear wheels to rotate at different speeds. All road surfaces.

4LOCK

Four-Wheel-Drive LOCK - Locks the transfer case inter-axle differential. Forces front and rear wheels to rotate at the same speed. Additional traction for loose, slippery road surfaces only.

4LO

Four-Wheel-Drive Low Range - Low speed 4 wheel drive. Locks the transfer case inter-axle differential. Forces the front and rear wheels to rotate at the same speed. Additional traction and maximum pulling power for loose, slippery road surfaces only. Do not exceed 25 mph (40 km/h).

N

Neutral - Disengages both the front and rear driveshafts from the powertrain. To be used for flat towing behind another vehicle. See Recreational Towing for more information.

Shifting Procedure - NV 244 Generation II Transfer Case

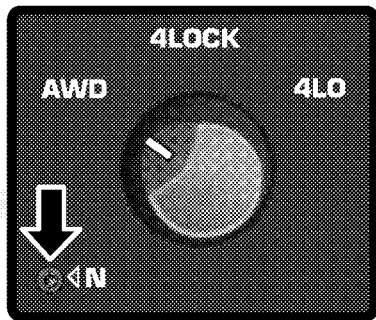

8122be91

NOTE: The 4x4 system will not allow shifts between AWD/ 4LOCK if the rear wheels are spinning (no traction). In this situation a position indicator light will flash and the original position indicator light will remain ON. At this time, reduce speed and stop spinning the

wheels to complete the shift. There may be a delay up to 13 seconds for the shift to complete after the wheels have stopped spinning.

NOTE: Delayed shifting out of the 4LOCK position may be experienced due to uneven tire wear, low tire pressure, or excessive loading.

NOTE: When shifting into or out of 4LO some gear noise may be heard. This noise is normal and is not detrimental to the vehicle or occupants.

Shifting can be performed with the vehicle rolling 2 to 3 mph (3 to 5 km/h) or completely stopped. USE EITHER OF THE FOLLOWING PROCEDURES:

Preferred Procedure

1. With the engine RUNNING, slow vehicle to 2 to 3 mph (3 to 5 km/h).
2. Shift the transmission into NEUTRAL.

3. While still rolling, rotate the transfer case control switch to the desired position.
4. After the position indicator light has stopped flashing, shift the transmission back into gear.

Alternate Procedure

1. Bring the vehicle to complete stop.
2. With the key ON and the engine either OFF or RUNNING, shift the transmission into NEUTRAL.
3. Rotate the transfer case control switch to the desired position.

4. After the position indicator light has stopped flashing, shift the transmission back into gear.

NOTE: The ignition key must be ON for a shift to take place and for the position indicator lights to be operable. If the key is not ON then the shift will not take place and no position indicator lights will be on or flashing.

NOTE: If any of the requirements to select a new transfer case position have not been met, the transfer case will not shift. The indicator light will flash and the current transfer case position will be maintained. To retry the selection, turn the control knob back to the current position, wait five (5) seconds, and retry the shift.

PARKING BRAKE

The foot operated parking brake is positioned below the lower left corner of the instrument panel. To release the parking brake, pull the parking brake release handle.

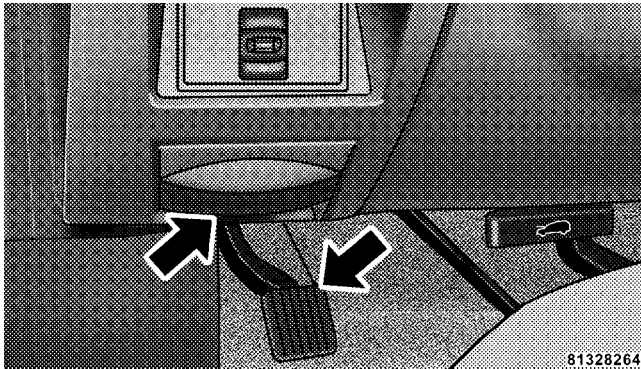

Be sure the parking brake is firmly set when parked and the gear-shift lever is in PARK position. When parking on a hill you should apply the Parking Brake before placing the gear shift lever in PARK; otherwise the load on the transmission locking mechanism may make it difficult to move the selector out of PARK.

NOTE: The instrument cluster brake warning light indicates only that the parking brake is applied. You must be sure the parking brake is fully applied before leaving the vehicle.

When parking on a hill, turn the front wheels toward the curb on a downhill grade and away from the curb on an uphill grade.

The parking brake should be applied whenever the driver is not in the vehicle.

WARNING!

- Always fully apply the parking brake when leaving your vehicle, or vehicle may roll and cause damage or injury. Also be certain to leave an automatic transmission in Park. Failure to do so may cause the vehicle to roll and cause damage or injury.
- Be sure the parking brake is fully disengaged before driving, failure to do so can lead to brake failure and an accident.
- Leaving children in a vehicle unattended is dangerous for a number of reasons. A child or others could be injured. Children should be warned not to touch the parking brake or the gear selector lever. Don't leave the key in the ignition. A child could operate power windows, other controls, or move the vehicle.

BRAKE SYSTEM

In the event power assist is lost for any reason, (for example, repeated brake applications with the engine off), the brakes will still function. The effort required to brake the vehicle will be significantly increased over that required with the power system operating.

If either the front or rear hydraulic systems lose normal capability, the remaining system will still function with some loss of braking effectiveness. This will be evident by increased pedal travel during application, greater pedal force required to slow or stop, and activation of the Brake Warning Lamp and the ABS Lamp during brake use.

Four-Wheel Anti-Lock Brake System (ABS)

This Anti-Lock Brake System is designed to aid the driver in maintaining vehicle control under adverse braking conditions. The system operates with a separate computer to modulate hydraulic pressure to prevent wheel lockup and help avoid skidding on slippery surfaces.

The system's pump motor runs during an ABS stop to provide regulated hydraulic pressure. The pump motor makes a low humming noise during operation, which is normal.

The Anti-Lock Brake system includes an amber (ABS) warning light. When the light is illuminated, the Anti-Lock Brake system is not functioning. The system reverts to standard non-anti-lock brakes. Turning the ignition Off and On again may reset the Anti-Lock Brake system if the fault detected was only momentary.

WARNING!

Anti-Lock Brake Systems contain sophisticated electronic equipment. It may be susceptible to interference caused by improperly installed or high output radio transmitting equipment. This interference can cause possible loss of anti-lock braking capability. Installation of such equipment should be done by qualified professionals.

5

WARNING!

Pumping of the Anti-Lock Brakes will diminish their effectiveness and may lead to an accident. Pumping makes the stopping distance longer. Just press firmly on your brake pedal when you need to slow down or stop.

WARNING!

- **Anti-lock system (ABS) cannot prevent the natural laws of physics from acting on the vehicle, nor can it increase braking or steering efficiency beyond that afforded by the condition of the vehicle brakes and tires or the traction afforded.**
- **The ABS cannot prevent accidents, including those resulting from excessive speed in turns, following another vehicle too closely, or hydroplaning. Only a safe, attentive, and skillful driver can prevent accidents.**
- **The capabilities of an ABS equipped vehicle must never be exploited in a reckless or dangerous manner which could jeopardize the user's safety or the safety of others.**

When you are in a severe braking condition involving use of the Anti-lock Brake system, you will experience some pedal drop as the vehicle comes to a stop. This is the result of the system reverting to the base brake system.

Engagement of the Anti-lock Brake System may be accompanied by a pulsing sensation. You may also hear a clicking noise. These occurrences are normal, and indicate that the system is functioning properly.

POWER STEERING

Your power steering system will provide mechanical steering capability if power assist is lost.

If for any reason the hydraulic pressure is interrupted, it will still be possible to steer your vehicle. Under these conditions you will experience an increase in steering effort and a noticeable amount of "free play" in the steering wheel.

ROCKING THE VEHICLE

If vehicle becomes stuck in snow, sand, or mud, it can often be moved by a rocking motion. Move the gear selector rhythmically between FIRST and REVERSE, while applying slight pressure to the accelerator.

The least amount of accelerator pedal pressure to maintain the rocking motion without spinning the wheels or racing the engine is most effective. Allow the engine to idle with the transmission selector in NEUTRAL for at least one minute after every five rocking-motion cycles. This will minimize overheating and reduce the risk of transmission failure during prolonged efforts to free a stuck vehicle.

TIRE SAFETY INFORMATION

Tire Markings

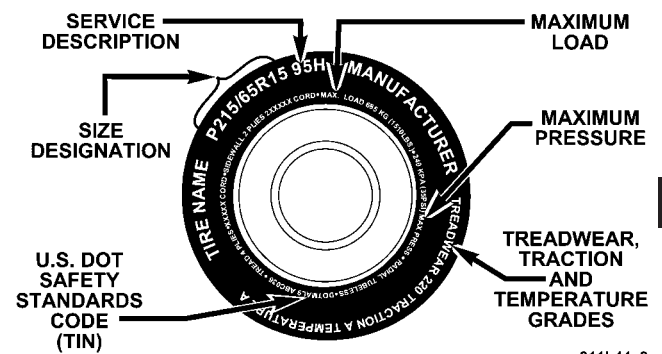

811b44e8

NOTE:

- P(Passenger)-Metric tire sizing is based on U.S. design standards. P-Metric tires have the letter "P" molded into the sidewall preceding the size designation. Example: P215/65R15 95H.

- European Metric tire sizing is based on European design standards. Tires designed to this standard have the tire size molded into the sidewall beginning with the section width. The letter "P" is absent from this tire size designation. Example: 215/65R15 96H
- LT(Light Truck)-Metric tire sizing is based on U.S. design standards. The size designation for LT-Metric tires is the same as for P-Metric tires except for the letters "LT" that are molded into the sidewall preceding the size designation. Example: LT235/85R16.
- Temporary Spare tires are high pressure compact spares designed for temporary emergency use only. Tires designed to this standard have the letter "T" molded into the sidewall preceding the size designation. Example: T145/80D18 103M.
- High Flotation tire sizing is based on U.S. design standards and begins with the tire diameter molded into the sidewall. Example: 31x10.5 R15 LT.

Tire Sizing Chart

EXAMPLE:	
Size Designation:	
P = Passenger car tire size based on U.S. design standards	
"...blank..." = Passenger car tire based on European design standards	
LT = Light Truck tire based on U.S. design standards	
T = Temporary Spare tire	
31 = Overall Diameter in Inches (in)	
215 = Section Width in Millimeters (mm)	
65 = Aspect Ratio in Percent (%)	
	—Ratio of section height to section width of tire.
10.5 = Section Width in Inches (in)	
R = Construction Code	
	—"R" means Radial Construction.
	—"D" means Diagonal or Bias Construction.
15 = Rim Diameter in Inches (in)	

EXAMPLE:	
Service Description:	
95 = Load Index	—A numerical code associated with the maximum load a tire can carry.
H = Speed Symbol	—A symbol indicating the range of speeds at which a tire can carry a load corresponding to its load index under certain operating conditions. —The maximum speed corresponding to the Speed Symbol should only be achieved under specified operating conditions. (ie. tire pressure, vehicle loading, road conditions and posted speed limits).
Load Identification:	
"...blank..." = Absence of any text on sidewall of the tire indicates a Standard Load (SL) Tire	
Extra Load (XL) = Extra Load (or Reinforced) Tire	
Light Load = Light Load Tire	
C,D,E = Load range associated with the maximum load a tire can carry at a specified pressure	
Maximum Load — Maximum Load indicates the maximum load this tire is designed to carry.	
Maximum Pressure — Maximum Pressure indicates the maximum permissible cold tire inflation pressure for this tire.	

Tire Identification Number (TIN)

The TIN may be found on one or both sides of the tire however the date code may only be on one side. Tires with white sidewalls will have the full TIN including date code located on the white sidewall side of the tire.

Look for the TIN on the outboard side of black sidewall tires as mounted on the vehicle. If the TIN is not found on the outboard side then you will find it on the inboard side of the tire.

EXAMPLE:
DOT MA L9 ABCD 0301
DOT = Department of Transportation —This symbol certifies that the tire is in compliance with the U.S. Department of Transportation tire safety standards, and is approved for highway use.
MA = Code representing the tire manufacturing location.(2 digits)
L9 = Code representing the tire size.(2 digits)
ABCD = Code used by tire manufacturer.(1 to 4 digits)
03 = Number representing the week in which the tire was manufactured.(2 digits) —03 means the 3rd week.
01 = Number representing the year in which the tire was manufactured.(2 digits) —01 means the year 2001. —Prior to July 2000, tire manufacturers were only required to have 1 number to represent the year in which the tire was manufactured. Example: 031 could represent the 3rd week of 1981 or 1991.

Tire Loading and Tire Pressure

Tire Placard Location

NOTE: Some vehicles have a “Tire and Loading Information” placard located on the driver’s side “B” pillar.

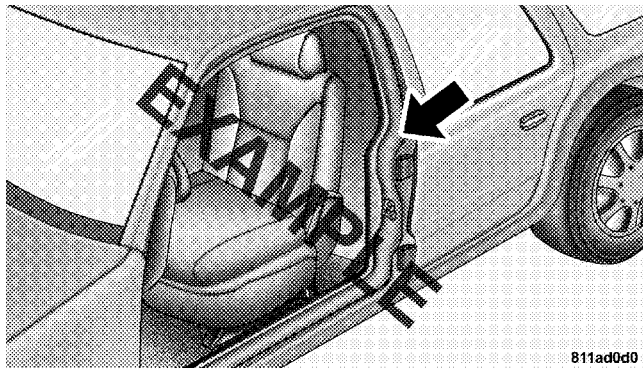

Tire and Loading Information Placard

TIRE AND LOADING INFORMATION			
SEATING CAPACITY - TOTAL 5 FRONT 2 REAR 3			
THE COMBINED WEIGHT OF OCCUPANTS AND CARGO SHOULD NEVER EXCEED XXX KG OR XXX LBS.			
TIRE	FRONT	REAR	SPARE
ORIGINAL TIRE SIZE	P195/70R14	P195/70R14	T125/70D15
COLD TIRE INFLATION PRESSURE	200kPa, 29PSI	200kPa, 29PSI	420kPa, 60PSI
SEE OWNER'S MANUAL FOR ADDITIONAL INFORMATION			4N109268

811b5a9a

This placard tells you important information about the,

- 1) number of people that can be carried in the vehicle
- 2) the total weight your vehicle can carry
- 3) the tire size designed for your vehicle
- 4) the cold tire inflation pressures for the front, rear and spare tires.

Loading

The vehicle maximum load on the tire must not exceed the load carrying capacity of the tire on your vehicle. You will not exceed the tire's load carrying capacity if you adhere to the loading conditions, tire size and cold tire inflation pressures specified on the Tire and Loading Information placard and the Vehicle Loading section of this manual.

NOTE: Under a maximum loaded vehicle condition, gross axle weight ratings (GAWR's) for the front and rear axles must not be exceeded. For further information on GAWR's, vehicle loading and trailer towing, see the Vehicle Loading section of this manual.

To determine the maximum loading conditions of your vehicle, locate the statement "The combined weight of occupants and cargo should never exceed XXX kg or XXX lbs." on the Tire and Loading Information placard. The

combined weight of occupants, cargo/luggage and trailer tongue weight (if applicable) should never exceed the weight referenced here.

Steps for Determining Correct Load Limit

1. Locate the statement "The combined weight of occupants and cargo should never exceed XXX pounds" on your vehicle's placard.
2. Determine the combined weight of the driver and passengers that will be riding in your vehicle.
3. Subtract the combined weight of the driver and passengers from XXX kilograms or XXX pounds.
4. The resulting figure equals the available amount of cargo and luggage load capacity. For example, if "XXX" amount equals 1400 lbs. and there will be five 150 lb. passengers in your vehicle, the amount of available cargo and luggage load capacity is 650 lb. (1400-750 (5 x 150) = 650 lb.)

5. Determine the combined weight of luggage and cargo being loaded on the vehicle. That weight may not safely exceed the available cargo and luggage load capacity calculated in step 4.

6. If your vehicle will be towing a trailer, load from your trailer will be transferred to your vehicle. Consult this manual to determine how this reduces the available cargo and luggage load capacity of your vehicle.

NOTE: The following table shows examples on how to calculate total load, cargo/luggage and towing capacities

of your vehicle with varying seating configurations and number and size of occupants. This table is for illustration purposes only and may not be accurate for the seating and load carry capacity of your vehicle.

NOTE: For the following example the combined weight of occupants and cargo should never exceed 865 lbs. (392 Kg).

Occupants			Combined weight of occupants and cargo from Tire Placard	MINUS	Combined Occupant's weight	=	AVAILABLE Cargo/Luggage and Trailer Tongue Weight
TOTAL	FRONT	REAR					
EXAMPLE 1			865 lbs	minus	Occupant 1: 200 lbs Occupant 2: 130 lbs Occupant 3: 160 lbs Occupant 4: 100 lbs Occupant 5: 80 lbs TOTAL WEIGHT: 670 lbs	=	195 lbs
5	2	3					
EXAMPLE 2			865 lbs	minus	Occupant 1: 210 lbs Occupant 2: 180 lbs Occupant 3: 150 lbs TOTAL WEIGHT: 540 lbs	=	325 lbs
3	2	1					
EXAMPLE 3			865 lbs	minus	Occupant 1: 200 lbs Occupant 2: 200 lbs TOTAL WEIGHT: 400 lbs	=	465 lbs
2	2	0					

811a4d11

WARNING!

Overloading of your tire is dangerous. Overloading can cause tire failure, affect vehicle handling, and increase your stopping distance. Use tires of the recommended load capacity for your vehicle. Never overload them.

TIRES—GENERAL INFORMATION**Tire Pressure**

Proper tire inflation pressure is essential to the safe and satisfactory operation of your vehicle. Three primary areas are affected by improper tire pressure:

1. Safety—**WARNING!**

Improperly inflated tires are dangerous and can cause accidents.

- Under inflation increases tire flexing and can result in tire failure.
- Over inflation reduces a tire's ability to cushion shock. Objects on the road and chuck holes can cause damage that results in tire failure.
- Unequal tire pressures can cause steering problems. You could lose control of your vehicle.
- Over inflated or under inflated tires can affect vehicle handling and can fail suddenly, resulting in loss of vehicle control.
- Unequal tire pressures from one side of the vehicle to the other can cause the vehicle to drift to the right or left.

Always drive with each tire inflated to the recommended cold tire inflation pressure.

2. *Economy*—

Improper inflation pressures can cause uneven wear patterns to develop across the tire tread. These abnormal wear patterns will reduce tread life resulting in a need for earlier tire replacement. Underinflation also increases tire rolling resistance and results in higher fuel consumption.

3. *Ride Comfort and Vehicle Stability*—

Proper tire inflation contributes to a comfortable ride. Overinflation produces a jarring and uncomfortable ride.

Tire Inflation Pressures

The proper cold tire inflation pressure for passenger cars is listed on either the face of the driver's door or the driver's side "B" pillar. For vehicles other than passenger cars, the cold tire inflation pressures are listed on either the "B" pillar, the Certification Label or in the Tire Inflation Pressures brochure in the glove compartment.

Some vehicles may have Supplemental Tire Pressure Information for vehicle loads that are less than the

maximum loaded vehicle condition. These pressure conditions will be found in the "Supplemental Tire Pressure Information" section of this manual.

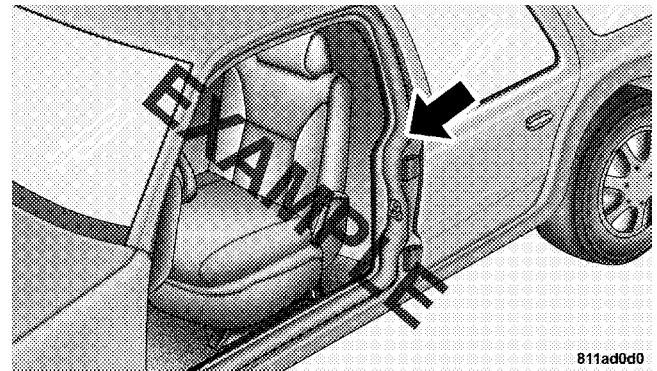

"B" PILLAR

The pressure should be checked and adjusted as well as inspecting for signs of tire wear or visible damage at least once a month. Use a good quality pocket-type gauge to

check tire pressure. Do not make a visual judgement when determining proper inflation. Radial tires may look properly inflated even when they are underinflated.

CAUTION!

After inspecting or adjusting the tire pressure always reinstall the valve stem cap—if equipped. This will prevent moisture and dirt from entering the valve stem, which could damage the valve stem.

Inflation pressures specified on the placard are always “cold tire inflation pressure”. Cold tire inflation pressure is defined as the tire pressure after the vehicle has not been driven for at least 3 hours, or driven less than 1 mile (1 km) after a 3 hour period. The cold tire inflation pressure must not exceed the maximum inflation pressure molded into the tire side wall.

Check tire pressures more often if subject to a wide range of outdoor temperatures, as tire pressures vary with temperature changes.

Tire pressures change by approximately 1 psi (7 kPa) per 12° F (7° C) of air temperature change. Keep this in mind when checking tire pressure inside a garage especially in the winter.

Example: If garage temperature = 68° F (20° C) and the outside temperature = 32° F (0° C) then the cold tire inflation pressure should be increased by 3 psi (21 kPa), which equals 1 psi (7 kPa) for every 12° F (7° C) for this outside temperature condition.

Tire pressure may increase from 2 to 6 psi (13 to 40 kPa) during operation. DO NOT reduce this normal pressure build up or your tire pressure will be too low.

Tire Pressures for High Speed Operation

The manufacturer advocates driving at safe speeds within posted speed limits. Where speed limits or conditions are such that the vehicle can be driven at high speeds, maintaining correct tire inflation pressure is very important. Increased tire pressure and reduced vehicle loading may be required for high speed vehicle operation. Refer to original equipment or an authorized tire dealer for recommended safe operating speeds, loading and cold tire inflation pressures.

WARNING!

High speed driving with your vehicle under maximum load is dangerous. The added strain on your tires could cause them to fail. You could have a serious accident. Don't drive a vehicle loaded to the maximum capacity at continuous speeds above 75 mph (120 km/h).

Radial-Ply Tires

WARNING!

Combining radial ply tires with other types of tires on your vehicle will cause your vehicle to handle poorly. The instability could cause an accident. Always use radial ply tires in sets of four (or 6, in case of trucks with dual rear wheels). Never combine them with other types of tires.

Cuts and punctures in radial tires are repairable only in the tread area because of sidewall flexing. Consult your authorized tire dealer for radial tire repairs.

Compact Spare Tire — If Equipped

The compact spare is for temporary emergency use with radial tires. It is engineered to be used on your style vehicle only. Since this tire has limited tread life, the original tire should be repaired (or replaced) and reinstalled at the first opportunity.

WARNING!

Temporary use spare tires are for emergency use only. With these tires, do not drive more than 50 mph (80 km/h). Temporary-use spare tires have limited tread life. When two or more tread wear indicators appear in adjacent grooves, the temporary use spare tire needs to be replaced. Be sure to follow the warnings which apply to your spare. Failure to do so could result in spare tire failure and loss of vehicle control.

Do not install a wheel cover or attempt to mount a conventional tire on the compact spare wheel, since the wheel is designed specifically for the compact spare.

Do not install more than one compact spare tire/wheel on the vehicle at any given time.

CAUTION!

Because of the reduced ground clearance, do not take your vehicle through an automatic car wash with the compact spare installed. Damage to the vehicle may result.

Limited Use Spare — If Equipped

The limited use spare tire is for temporary emergency use on your vehicle. This tire is identified by a limited use spare tire warning label located on the limited use spare tire and wheel assembly. This tire may look like the original equipped tire on the front or rear axle of your vehicle, but it is not. Installation of this limited use spare tire affects vehicle handling. Since it is not the same tire, replace (or repair) the original tire and reinstall on vehicle at the first opportunity.

WARNING!

The limited use spare tires are for emergency use only. Installation of this limited use spare tire affects vehicle handling. With this tire, do not drive more than 60 mph (100 km/h). Keep inflated to the cold tire inflation pressure listed on either your tire placard or limited use spare tire and wheel assembly. Replace (or repair) the original tire at the first opportunity and reinstall it on your vehicle. Failure to do so could result in loss of vehicle control.

Tire Spinning

When stuck in mud, sand, snow, or ice conditions, do not spin your vehicle's wheels above 35 mph (55 km/h).

See the paragraph on Freeing A Stuck Vehicle in Section 6 of this manual.

WARNING!

Fast spinning tires can be dangerous. Forces generated by excessive wheel speeds may cause tire damage or failure. A tire could explode and injure someone. Do not spin your vehicle's wheels faster than 35 mph (55 km/h) when you are stuck. And don't let anyone near a spinning wheel, no matter what the speed.

Tread Wear Indicators

Tread wear indicators are in the original equipment tires to help you in determining when your tires should be replaced.

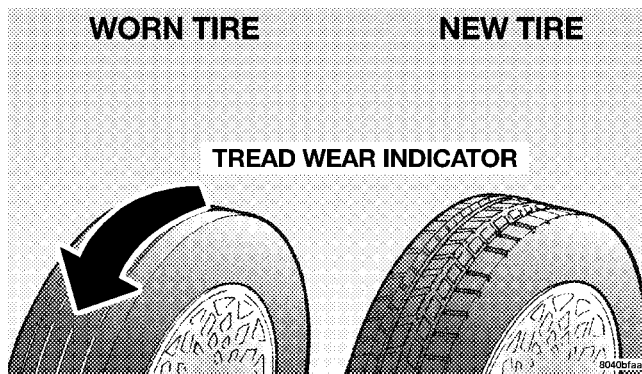

These indicators are molded into the bottom of the tread grooves and will appear as bands when the tread depth becomes 1/16 inch (2 mm). When the indicators appear in 2 or more adjacent grooves, the tire should be replaced.

Many states have laws requiring tire replacement at this point.

Replacement Tires

The tires on your new vehicle provide a balance of many characteristics. They should be inspected regularly for wear and correct cold tire inflation pressure. The manufacturer strongly recommends that you use tires equivalent to the originals in size, quality and performance when replacement is needed (see the paragraph on tread wear indicators). Refer to the Tire and Loading Information placard for the size designation of your tire. The service description and load identification will be found on the original equipment tire. Failure to use equivalent replacement tires may adversely affect the safety, handling, and ride of your vehicle. We recommend that you contact your original equipment or an authorized tire dealer with any questions you may have on tire specifications or capability.

WARNING!

- Do not use a tire, wheel size or rating other than that specified for your vehicle. Some combinations of unapproved tires and wheels may change suspension dimensions and performance characteristics, resulting in changes to steering, handling, and braking of your vehicle. This can cause unpredictable handling and stress to steering and suspension components. You could lose control and have an accident resulting in serious injury or death. Use only the tire and wheel sizes with load ratings approved for your vehicle.
- Never use a tire with a smaller load index or capacity, other than what was originally equipped on your vehicle. Using a tire with a smaller load index could result in tire overloading and failure. You could lose control and have an accident.
- Failure to equip your vehicle with tires having adequate speed capability can result in sudden tire failure and loss of vehicle control.

CAUTION!

Replacing original tires with tires of a different size may result in false speedometer and odometer readings.

Alignment And Balance

Poor suspension alignment may result in:

- Fast tire wear.
- Uneven tire wear, such as feathering and one-sided wear.
- Vehicle pull to right or left.

Tires may also cause the vehicle to pull to the left or right. Alignment will not correct this condition. See your dealer for proper diagnosis.

Improper alignment will not cause vehicle vibration. Vibration may be a result of tire and wheel out-of-balance. Proper balancing will reduce vibration and avoid tire cupping and spotty wear.

SUPPLEMENTAL TIRE PRESSURE INFORMATION

A light load vehicle condition is defined as two passengers {150 lbs (68 kg) each} plus 200 lbs (91kg) of cargo. Cold tire inflation pressures for a lightly loaded vehicle will be found on a "Supplemental Tire Pressure Inflation" label located on the face of the driver's door or in the Tire Information Pressures pamphlet in the glove box.

TIRE CHAINS

Use "Class S" chains on Durango, or other traction aids that meet SAE Type "S" specifications.

NOTE: Chains must be the proper size for the vehicle, as recommended by the chain manufacturer.

CAUTION!

To avoid damage to your vehicle, tires or chains, observe the following precautions:

- Because of limited chain clearance between tires and other suspension components, it is important that only chains in good condition are used. Broken chains can cause serious vehicle damage. Stop the vehicle immediately if noise occurs that could suggest chain breakage. Remove the damaged parts of the chain before further use.
- Install chains as tightly as possible and then retighten after driving about 1/2 mile (0.8 km).
- Do not exceed 45 mph (72 km/h).
- Drive cautiously and avoid severe turns and large bumps, especially with a loaded vehicle.
- Do not install tire chains on front wheels of 4x2 vehicles.
- Do not drive for a prolonged period on dry pavement.
- Observe the tire chain manufacturer's instructions on method of installation, operating speed, and conditions for usage. Always use the lower suggested operating speed of the chain manufacturer if different than the speed recommended by the manufacturer.

These cautions apply to all chain traction devices, including link and cable (radial) chains.

Tire chain use is permitted only on the rear tires of Durango trucks.

NOTE: The use of class “S” chains is permitted on Durangos with P245/70R17 tires.

CAUTION!

Do not use tire chains on 4x4 Durango trucks equipped with P265/65R17 tires. There may not be adequate clearance for the chains and you are risking structural or body damage to your vehicle. Do not use tire chains on the 4X2 front wheels of Durango models. There may not be adequate clearance for the chains and you are risking structural or body damage to your vehicle.

SNOW TIRES

Snow tires should be of the same size and type construction as the front tires. Consult the manufacturer of the snow tire to determine any maximum vehicle speed requirement associated with the tire. These tires should always be operated at the vehicle maximum capacity inflation pressures under any load condition.

While studded tires improve performance on ice, skid and traction capability on wet or dry surfaces may be poorer than that of non-studded tires. Some states prohibit studded tires; therefore, local laws should be checked before using these tire types.

TIRE ROTATION RECOMMENDATIONS

Tires on the front and rear axles of vehicles operate at different loads and perform different steering, driving, and braking functions. For these reasons, they wear at unequal rates and tend to develop irregular wear patterns. These effects can be reduced by timely rotation of tires. The benefits of rotation are especially worthwhile with aggressive tread designs such as those on all season type tires. Rotation will increase tread life, help to maintain mud, snow and wet traction levels, and contribute to a smooth, quiet ride.

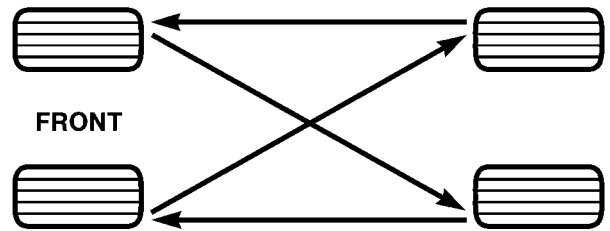

8031e864

Follow the recommended tire rotation frequency for your type of driving found in the “Maintenance Schedules” Section of this manual. More frequent rotation is permissible if desired. The reasons for any rapid or unusual wear should be corrected prior to rotation being performed.

FUEL REQUIREMENTS

**All Engines
Except 5.7L**

All engines (except 5.7L engines) are designed to meet all emissions regulations and provide excellent fuel economy and performance when using high quality unleaded "regular" gasoline having an octane rating of 87. The routine use of premium gasoline is not recommended. Under normal conditions the use of premium fuel will not provide a benefit over high quality regular gasolines and in some circumstances may result in poorer performance.



5.7L Engines

The 5.7L engine is designed to meet all emissions regulations and provide satisfactory fuel economy and performance when using high quality unleaded gasoline having an octane range of 87 to 89. The manufacturer recommends the use of 89 octane for optimum performance. The routine use

of premium gasoline is not recommended. The use of premium gasoline will provide no benefit over high quality regular and mid-grade gasolines, and in some circumstances may result in poorer performance.

Light spark knock at low engine speeds is not harmful to your engine. However, continued heavy spark knock at high speeds can cause damage and immediate service is required. Engine damage resulting from operation with a heavy spark knock may not be covered by the new vehicle warranty.

Poor quality gasoline can cause problems such as hard starting, stalling and hesitations. If you experience these symptoms, try another brand of "regular" gasoline before considering service for the vehicle.

Over 40 auto manufacturers world-wide have issued and endorsed consistent gasoline specifications (the Worldwide Fuel Charter, WWFC) to define fuel properties necessary to deliver enhanced emissions, performance

and durability for your vehicle. We recommend the use of gasolines that meet the WWFC specifications if they are available.

Reformulated Gasoline

Many areas of the country require the use of cleaner burning gasoline referred to as “Reformulated Gasoline.” Reformulated gasolines contain oxygenates, and are specifically blended to reduce vehicle emissions and improve air quality.

We strongly support the use of reformulated gasolines. Properly blended reformulated gasolines will provide excellent performance and durability for the engine and fuel system components.

Gasoline/Oxygenate Blends

Some fuel suppliers blend unleaded gasoline with oxygenates such as 10% ethanol, MTBE and ETBE. Oxygenates are required in some areas of the country during the winter months to reduce carbon monoxide emissions. Fuels blended with these oxygenates may be used in your vehicle.

CAUTION!

DO NOT use gasolines containing METHANOL. Gasoline containing methanol may damage critical fuel system components.

MMT In Gasoline

MMT is a manganese-containing metallic additive that is blended into some gasoline to increase octane. Gasolines blended with MMT provide no performance advantage beyond gasolines of the same octane number without MMT. Gasolines blended with MMT reduce spark plug life and reduce emission system performance. We recommend that gasolines free of MMT be used in your vehicle. The MMT content of gasoline may not be indicated on the gasoline pump; therefore, you should ask your gasoline retailer whether or not his/her gasoline contains MMT.

It is even more important to look for gasolines without MMT in Canada because MMT can be used at levels higher than allowed in the United States. MMT is prohibited in Federal and California reformulated gasolines.

Sulfur In Gasoline

If you live in the northeast United States, your vehicle may have been designed to meet California low emission standards with Cleaner-Burning California reformulated gasoline with low sulfur. If such fuels are not available in states adopting California emission standards, your vehicles will operate satisfactorily on fuels meeting federal specifications, but emission control system performance may be adversely affected. Gasoline sold outside of California is permitted to have higher sulfur levels which may affect the performance of the vehicle's catalytic converter. This may cause the Check Engine or Service Engine Soon light to illuminate. We recommend that you try a different brand of unleaded gasoline having lower sulfur to determine if the problem is fuel related prior to returning your vehicle to an authorized dealer for service.

CAUTION!

If the Check Engine or Service Engine Soon light is flashing, immediate service is required; see onboard diagnostics system section.

Materials Added To Fuel

All gasolines sold in the United States are required to contain effective detergent additives. Use of additional detergents or other additives is not needed under normal conditions and would result in unnecessary cost. Therefore, you should not have to add anything to the fuel.

ADDING FUEL

NOTE: If fuel is poured from a portable container, the container should have a flexible nozzle long enough to extend into the fuel filler tube.

CAUTION!

To avoid fuel spillage and overfilling, do not “top off” the fuel tank after filling.

NOTE: When the fuel nozzle “clicks” or shuts off, the fuel tank is full.

NOTE: Tighten the gas cap until you hear a “clicking” sound. This is an indication that the gas cap is properly tightened. Make sure that the gas cap is tightened each time the vehicle is refueled.

WARNING!

A fire may result if gasoline is pumped into a portable container that is inside of a vehicle or on a truck bed. You could be burned. Always place gas containers on the ground while filling.

CAUTION!

Damage to the fuel system or emission control system could result from using an improper fuel tank filler tube cap (gas cap). A poorly fitting cap could let impurities into the fuel system.

Fuel Filler Cap (Gas Cap)

The gas cap is behind the fuel filler door. If the gas cap is lost or damaged, be sure the replacement cap is for use with this vehicle.

WARNING!

- Remove the fuel tank filler tube cap (gas cap) slowly to prevent fuel spray from the filler neck which may cause injury.
- The volatility of some gasolines may cause a buildup of pressure in the fuel tank that may increase while you drive. This pressure can result in a spray of gasoline and/or vapors when the cap is removed from a hot vehicle. Removing the cap slowly allows the pressure to vent and prevents fuel spray.
- Never allow any lit smoking materials near the vehicles while removing the cap or filling the tank.
- Never add fuel to the vehicle when the engine is running.

Fuel System Cautions**CAUTION!**

Follow these guidelines to maintain your vehicle's performance:

- The use of leaded gas is prohibited by Federal law. Using leaded gasoline can impair engine performance, damage the emission control system, and could result in loss of warranty coverage.
- An out-of-tune engine, or certain fuel or ignition malfunctions, can cause the catalytic converter to overheat. If you notice a pungent burning odor or some light smoke, your engine may be out of tune or malfunctioning and may require immediate service. Contact your dealer for service assistance.

- When pulling a heavy load or driving a fully loaded vehicle when the humidity is low and the temperature is high, use a premium unleaded fuel to help prevent spark knock. If spark knock persists, lighten the load, or engine piston damage may result.
- The use of fuel additives which are now being sold as octane enhancers is not recommended. Many of these products contain high concentrations of methanol. Fuel system damage or vehicle performance problems resulting from the use of such fuels or additives is not the responsibility of the manufacturer and may not be covered under the New Vehicle Warranty.

NOTE: Intentional tampering with emissions control systems can result in civil penalties being assessed against you.

Carbon Monoxide Warnings

WARNING!
Carbon monoxide (CO) in exhaust gases is deadly. Follow the precautions below to prevent carbon monoxide poisoning:

- Do not inhale exhaust gases. They contain carbon monoxide, a colorless and odorless gas which can kill. Never run the engine in a closed area, such as a garage, and never sit in a parked vehicle with the engine running for an extended period. If the vehicle is stopped in an open area with the engine running for more than a short period, adjust the ventilation system to force fresh, outside air into the vehicle.
- Guard against carbon monoxide with proper maintenance. Have the exhaust system inspected every time

the vehicle is raised. Have any abnormal conditions repaired promptly. Until repaired, drive with all side windows fully open.

- Keep the liftgate closed when driving your vehicle to prevent carbon monoxide and other poisonous exhaust gases from entering the vehicle.

CATALYTIC CONVERTER

The catalytic converter requires the use of unleaded fuel only. Leaded gasoline will destroy the effectiveness of the catalyst as an emission control device. Under normal operating conditions, the catalytic converter will not require maintenance. However, you must keep the engine maintained to assure proper operation and prevent possible damage.

NOTE: Intentional tampering with emissions control systems can result in civil penalties being assessed against you.

CAUTION!

Damage to the catalytic converter can result if your vehicle is not kept in proper operating condition. In the event of engine malfunction, particularly involving engine misfire or other apparent loss of performance, have your vehicle serviced promptly. Continued operation of your vehicle with a severe malfunction could cause the converter to overheat, resulting in possible damage to the converter and vehicle.

As with any vehicle, do not park or operate this vehicle in areas where combustible materials such as grass or leaves can come in contact with a hot exhaust system.

A scorching odor may be detected if you continue to run a malfunctioning engine. The odor may indicate severe and abnormal catalyst overheating. If this occurs, the

vehicle should be stopped, the engine shut off and the vehicle allowed to cool. Service, including a tune-up to manufacturer's specifications should be obtained immediately.

To minimize the possibility of catalyst damage:

- Do not try to start the engine by pushing or towing the vehicle.
- Do not idle the engine with any spark plug wires disconnected or removed.
- Do not idle the engine for prolonged periods during very rough idle or malfunctioning operating conditions.
- Do not allow vehicle to run out of fuel.

VEHICLE LOADING

Certification Label

As required by National Highway Traffic Safety Administration Regulations, your vehicle has a certification label affixed to the driver's side door.

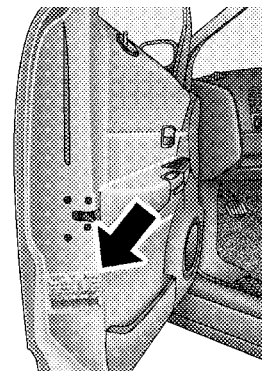

8120c1d2

This label contains the month and year of manufacture, Gross Vehicle Weight Rating (GVWR), Gross Axle Weight

Rating (GAWR) front and rear, and Vehicle Identification Number (VIN). A Month-Day-Hour (MDH) number is included on this label and shows the Month, Day, and Hour of manufacture. The bar code that appears on the bottom of the label is your Vehicle Identification Number (VIN).

Gross Vehicle Weight Rating (GVWR)

The GVWR is the total permissible weight of your vehicle including driver, passengers, vehicle, options, and cargo. The label also specifies maximum capacities of front and rear axle systems. Total load must be limited so that GVWR is not exceeded.

Payload

The payload of a vehicle is defined as the allowable load weight a truck can carry including the weight of the driver, all passengers, options, and cargo.

Gross Axle Weight Rating (GAWR)

The GAWR is the maximum permissible load on the front and rear axles. The load must be distributed in the cargo area so that the GAWR of each axle is not exceeded.

Each axle GAWR is determined by the component in the system with the lowest load carrying capacity (axle, springs, tires, or wheels).

Heavier axles or suspension components sometimes specified by purchasers for increased durability do not necessarily increase the vehicle's GVWR.

Tire Size

This is the minimum allowable tire size for your vehicle. Replacement tires must be equal to the load capacity of this tire size.

Rim Size

This is the rim size that is appropriate for the tire size listed.

Inflation Pressure (Cold)

This is the cold tire inflation pressure for your vehicle for all loading conditions up to full GAWR.

Curb Weight

The curb weight of a vehicle is defined as the total weight of the vehicle with all fluids, including vehicle fuel, at full capacity conditions, and with no occupants or cargo loaded into the vehicle. The front and rear curb weight values are determined by weighing your vehicle on a commercial scale before any occupants or cargo are added.

Loading

The actual total weight and the weight of the front and rear of your vehicle at the ground can best be determined by weighing it when it is loaded and ready for operation.

The entire vehicle should first be weighed on a commercial scale to insure that the GVWR has not been exceeded. The weight on the front and rear of the vehicle should

then be determined separately to be sure that the load is properly distributed over front and rear axle. Weighing the vehicle may show that the GAWR of either the front or rear axles has been exceeded but the total load is within the specified GVWR. If so, weight must be shifted from front to rear or rear to front as appropriate until the specified weight limitations are met.

Store heavier items down low and be sure that the weight is distributed equally. Stow all loose items securely before driving.

Improper weight distribution can have an adverse effect on the way your vehicle steers and handles and the way the brakes operate.

WARNING!

Do not load your vehicle any heavier than the GVWR or the maximum front and rear GAWR. If you do, parts on your vehicle can break, or it can change the way your vehicle handles. This could cause you to lose control. Also, overloading can shorten the life of your vehicle.

A loaded vehicle is shown in the following example. Note that neither GVWR nor GAWR capabilities are exceeded. Overloading can cause potential safety hazards and shorten service life.

NOTE: The weights shown in this chart are not the weights for your vehicle. Also, the amount of load added to both the front and rear axles can be computed

after the vehicle has been weighed both in its "curb weight" condition, and in its "loaded and ready for operation" condition.

Gross Vehicle Weight Rating (GVWR) 6500 LBS.

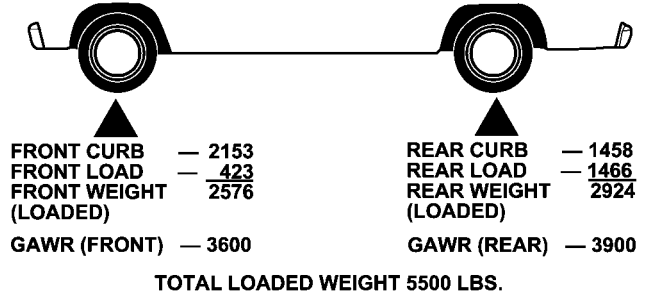

TOTAL LOADED WEIGHT 5500 LBS.

TRAILER TOWING

To maintain warranty coverage, follow the requirements and recommendations in this manual concerning vehicles used for trailer towing.

Definitions

The following trailer towing related terminology definitions will assist in understanding the subsequent sections:

GROSS COMBINATION WEIGHT RATING (GCWR)

is the total permissible weight of your vehicle and trailer when weighed in combination. (Note that GCWR ratings include a 68 kg (150 lb.) allowance for the presence of a driver.) Tongue Weight (of a trailer) is the weight placed on a vehicle's trailer hitch by the trailer.

GROSS TRAILER WEIGHT (GTW) is the weight of the trailer plus the weight of all cargo, consumables and equipment (permanent or temporary) loaded in or on the trailer in its "loaded and ready for operation" condition.

TRAILER SWAY CONTROL is a telescoping link that can be installed between the hitch receiver and the trailer tongue that typically provides adjustable friction associated with the telescoping motion to dampen any unwanted trailer swaying motions while traveling.

CAUTION!

- **During the first 500 miles (805 km) your new vehicle is driven, do not tow a trailer. Doing so may damage your vehicle.**
- **When first towing a trailer, limit your speed to 50 mph (80 km/h) during the first 500 miles (805 km) of towing.**

Perform the maintenance listed in Section 8 of this manual. When towing a trailer, never exceed the GAWR, or GCWR, ratings.

Consider the following items when computing the weight on the rear axle:

- The tongue weight of the trailer.
- The weight of any other type of cargo or equipment put in or on your vehicle.

NOTE: Remember that everything put into or on the trailer adds to the load on your vehicle. Also, additional factory-installed options, or dealer-installed options, must be considered as part of the total load on your vehicle. Refer to the Certification label located at the driver's door for the Gross Vehicle Weight Rating.

WARNING!

Improper towing can lead to an injury accident. Follow these guidelines to make your trailer towing as safe as possible:

- Be sure the trailer is loaded heavier in front, with 60% to 65% of the weight in front of the axle(s). Loads balanced over the wheels or heavier in the rear can cause the trailer to sway **severely** side to side which will cause loss of control of vehicle and trailer. Failure to load trailers heavier in front is the cause of many trailer accidents.
- Do **not** interconnect the hydraulic brake system of your vehicle with that of the trailer. This could cause inadequate braking and possible personal injury.

- Trailer brakes are recommended for trailers over 1,000 lbs (454 kg) and required for trailers in excess of 2,000 lbs. (907 kg).
- Use an approved trailer harness and connector. If a hitch is ordered, the proper wiring will be provided.
- When hauling cargo or towing a trailer, do not overload your vehicle or trailer. Overloading can cause a loss of control, poor performance or damage to brakes, axle, engine, transmission, steering, suspension, chassis structure or tires.
- Make certain that the load is secured in the trailer and will not shift during travel. When trailering cargo that cannot be fully secured, dynamic load shifts can occur that may be difficult for the driver to control.
- All trailer hitches should be professionally installed on your vehicle.
- Safety chains must always be used between your vehicle and trailer.
- Connect trailer lighting and brakes using factory harnesses only. Do not cut or splice any wiring to the brake circuits.

Trailer and Tongue Weight

Gross Trailer Weight (GTW) means the maximum allowable weight of the trailer plus the weight of all cargo and equipment loaded on the trailer when in actual underway towing condition. The recommended way to measure GTW is to put your fully loaded trailer on a vehicle scale. The entire weight of the trailer must be supported by the scale.

Tongue Weight is the weight placed on the vehicle's trailer hitch by the trailer. Always load a trailer with 60% to 65% of the weight in the front of the trailer. This places 10% to 15% of the GTW on the tow hitch of your vehicle.

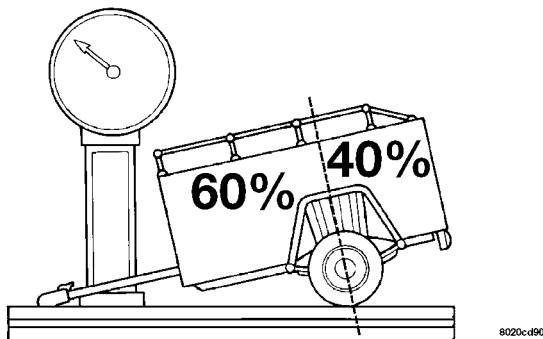

Trailer sway control and equalizing hitch are required for tongue weights above 350 lbs. (159 kg).

Also, there are maximum tongue weight ratings that are not to be exceeded, as follows:

- Class IV (the receiver hitch type) 1200 lbs (544 kg)

Gross Combined Vehicle Weight Rating (GCWR)

The Gross Combined Vehicle Weight Rating (GCWR) is the **MAXIMUM** allowable weight of the towing vehicle, including passengers and cargo, and the weight of the loaded trailer. Calculate the maximum trailer weight (MTW) by subtracting the towing vehicle's weight, including passengers, and cargo from GCWR.

Trailer Towing—Hitches:

With a Class IV Hitch, you can tow a trailer with a Gross Trailer Weight of up to 8,900 lbs. (4037 kg.) depending on your vehicle equipment. The Trailer Tow Package includes the platform hitch receiver, and a 7 lead wiring harness mounted on the hitch. Tongue weight must be equal to at least 10% of GTW, but no more than 15% of GTW.

NOTE: When towing a trailer, the following requirements must be adhered to:

- GCWR must not be exceeded

- **Total weight must be distributed between the tow vehicle and the trailer such that the following four (4) ratings are not exceeded:**

1. GVWR
2. GTW
3. **Tongue weight rating for the trailer hitch utilized (This requirement may limit the ability to always achieve the 10% to 15% range of tongue weight as a percentage of total trailer weight.)**
4. GAWR ratings

Trailer Towing Information (Maximum Trailer Weight Ratings)

"Trailer Towing Guide"

NOTE: For trailer towing information (maximum trailer weight ratings) refer to the following website address: [http:// www.dodge.com/towing](http://www.dodge.com/towing).

In Canada, refer to the following website address: [http:// www.dodge.ca](http://www.dodge.ca).

Trailer Towing Requirements

All Dodge Durango trucks are intended to tow trailers up to 2,000 lbs. (907 kg) without added equipment or alterations to standard equipment. Your vehicle may be factory equipped for safe towing of trailers over 2,000 lbs. (907 kg) with the trailer tow package. The electrical part of this package includes an instruction sheet and wiring pigtail for an aftermarket electric trailer brake controller. These items are stored in the glove box.

If you regularly pull a trailer, regardless of the trailer size, stop and turn signals on the trailer are recommended for motoring safety.

When the additional trailer lighting is connected to the vehicle, the flasher does not provide an indication of

outside lamp/bulb failure. Therefore, an occasional visual check around the vehicle is recommended. Once the trailer is removed the above indication will return to the vehicle.

WARNING!

The direct connection of hydraulic brake lines from vehicle brake system to trailer system is not acceptable. The extra load may cause brake failure and you may be injured.

All Durango models are equipped with an Anti-Lock Brake System and require an electrically actuated electric brake controller. A blue colored connector for electric brake hookup is located under the instrument panel above the brake pedal.

Heavy trailer towing also may require breakaway electric trailer brakes, anti-sway devices or equalizing hitches for safe operation. Such devices are commonly required by state law.

Trailer Tow Wiring

The Trailer Tow Package includes a 4 and 7 pin wiring harness located at the rear underbody of the vehicle.

NOTE: Connect trailer lighting and brakes using factory harnesses only. Do not cut or splice wiring to the brake circuits.

The electrical connections are all complete to the vehicle but you must mate the harness to a trailer connector. Refer to the following illustrations.

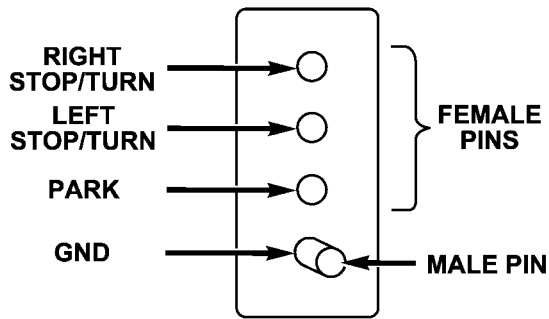

4 - Pin Connector

813262be

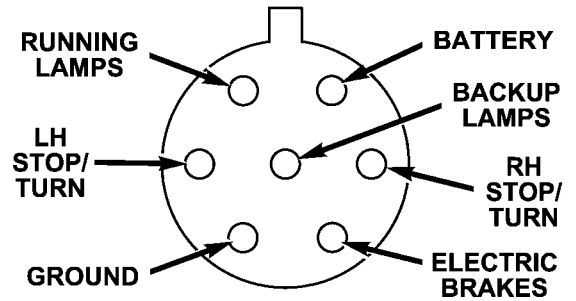

812634c6

7 - Pin Connector

Cooling System Tips—Trailer Towing

To reduce potential for engine and transmission overheating, take the following actions:

- **City Driving**

When stopped for short periods of time, put transmission in neutral and increase engine idle speed.

- **Highway Driving**

Reduce speed.

- **Air Conditioning**

Turn off temporarily.

- See Cooling System Operating information in the Maintenance section of this manual for more information.

To reduce potential for automatic transmission overheating, turn the "TOW/HAUL" feature on when driving in hilly areas or shift the transmission to Drive position 2 on more severe grades. Move the shift lever to the next lower position to eliminate excessive transmission shifting. This action will also reduce the possibility of transmission overheating and provide better engine braking.

SNOWPLOW

Dodge Durango Models

NOTE: Do not use Dodge Durango Models for snowplow applications.

WARNING!
<p>Snowplows, winches, and other aftermarket equipment should not be added to the front end of your vehicle. The airbag crash sensors may be affected by the change in the front end structure. The airbags could deploy unexpectedly or could fail to deploy during a collision resulting in serious injury or death.</p>

CAUTION!

Using this vehicle for snowplow applications can cause damage to the vehicle.

WARNING!

Attaching a snowplow to this vehicle could adversely affect performance of the airbag system in an accident. Do not expect that the airbag will perform as described earlier in this manual

RECREATIONAL TOWING (BEHIND MOTORHOME, ETC.) OF 4X4 VEHICLES

WARNING!

You or others could be injured if you leave the vehicle unattended with the transfer case in the Neutral (N) position without first fully engaging the parking brake. The transfer case Neutral (N) position disengages both the front and rear driveshafts from the powertrain and will allow the vehicle to move despite the transmission position. The parking brake should always be applied when the driver is not in the vehicle.

CAUTION!

Internal damage to the transfer case will occur if a front or rear wheel lift is used when recreational towing.

NOTE: The NV 244 Generation II transfer case must be shifted into Neutral (N) for recreational towing. The Neutral (N) selection button is located on the lower left hand corner of the 4WD Control Switch. Shifts into and out of transfer case Neutral (N) can take place with the selector switch in any mode position.

Shifting into Neutral (N)

Use the following procedure to prepare your vehicle for recreational towing.

CAUTION!

It is necessary to follow these steps to be certain that the transfer case is fully in Neutral (N) before recreational towing to prevent damage to internal parts.

1. Bring vehicle to a complete stop.
2. Shut engine OFF.
3. Place ignition key in the ON position.
4. Depress brake pedal.
5. Shift automatic transmission to Neutral (N).
6. Using the point of a ballpoint pen or similar object, depress the recessed transfer case Neutral (N) button for 4 seconds.

7. After shift is completed and the Neutral (N) light comes on release Neutral (N) button.
8. Start engine.
9. Shift automatic transmission into Reverse (R).
10. Release brake pedal for five seconds and ensure that there is no vehicle movement.
11. Repeat steps 9 and 10 with the transmission in Drive (D).
12. Shut engine OFF and place ignition key to the unlocked OFF position.
13. Shift automatic transmission into Park (P).
14. Attach vehicle to tow vehicle with tow bar.

NOTE: Items 1 through 5 are requirements that must be met prior to depressing the Neutral (N) selection button, and must continue to be met until the 4 seconds elapses and the shift has been completed.

If any of these requirements (with the exception of 3 - Key ON) are not met prior to depressing the Neutral (N) button or are no longer met during the 4 second timer, then the Neutral (N) indicator light will flash continuously until all requirements are met or until the Neutral (N) button is released.

NOTE: The ignition key must be ON for a shift to take place and for the position indicator lights to be operable. If the key is not ON, the shift will not take place and no position indicator lights will be on or flashing.

CAUTION!

Damage to the transmission may occur if the transmission is shifted into Park (P) with the transfer case in Neutral (N) and the engine RUNNING. With the transfer case in Neutral (N) ensure that the engine is OFF prior to shifting the transmission into Park (P)

Shifting OUT of Neutral (N)

Use the following procedure to prepare your vehicle for normal usage.

1. Bring vehicle to a complete stop.
2. Shut engine OFF.
3. Place ignition key in the ON position.
4. Depress brake pedal.
5. Shift automatic transmission to Neutral (N).

6. Using the point of a ballpoint pen or similar object, depress the recessed transfer case Neutral (N) button for 1 second.

7. After the Neutral (N) indicator light turns off release the Neutral (N) button.

8. After the Neutral (N) button has been released the transfer case will shift to the position identified by the selector switch.

9. Shift automatic transmission into Drive (D).

NOTE: Items 1 through 5 are requirements that must be met prior to depressing the Neutral (N) selection button, and must continue to be met until 1 second elapses and the shift has been completed.

If any of these requirements are not met prior to depressing the Neutral (N) button or are no longer met during

the 1 second time, then all of the position indicator lights will flash continuously until all requirements are met or until the Neutral (N) button is released.

NOTE: The ignition key must be ON for a shift to take place and for the position indicator lights to be operable. If the key is not On, the shift will not take place and no position indicator lights will be on or flashing.

NOTE: Flashing neutral (N) position indicator light indicates that shift requirements have not been met.

CAUTION!

- **Do not use a bumper mounted clamp-on tow bar on your vehicle. The bumper face bar will be damaged.**
- **Do not disconnect the rear driveshaft because fluid will leak from the transfer case and damage internal parts.**

TRACTION

When driving on wet or slushy roads, it is possible for a wedge of water to build up between the tire and road surface. This is known as hydroplaning and may cause partial or complete loss of vehicle control and stopping ability. To reduce this possibility, the following precautions should be observed:

1. Slow down during rainstorms or when roads are slushy.
2. Slow down if road has standing water or puddles.
3. Replace tires when tread wear indicators first become visible.
4. Keep tires properly inflated.
5. Maintain sufficient distance between your vehicle and the car in front to avoid a collision in a sudden stop.

EQUIPMENT IDENTIFICATION PLATE

The equipment Identification Plate is located on the hood inner surface.

The following information about your vehicle is displayed on this plate: Model, Wheelbase, Vehicle Identification Number, Truck Order Number, and code numbers with descriptions of all production and special equipment on the truck as shipped from the factory.

NOTE: Always refer to the Equipment Identification Plate When Ordering Parts.

WHAT TO DO IN EMERGENCIES

CONTENTS

■ Hazard Warning Flasher	270	□ Tire Changing Procedure	275
■ Adding Fuel	270	■ Jump Starting	280
■ Changing A Flat Tire	272	■ Towing A Disabled Vehicle	282
□ Jack Location	272	□ Four-Wheel Drive Vehicles	282
□ Removing The Spare Tire	273	□ Two-Wheel Drive Vehicles	282

HAZARD WARNING FLASHER

The flasher switch is on the top of the steering column, just behind the steering wheel. Press the flasher switch and all front and rear directional signals will flash intermittently.

Press the switch a second time to turn off the emergency flashers.

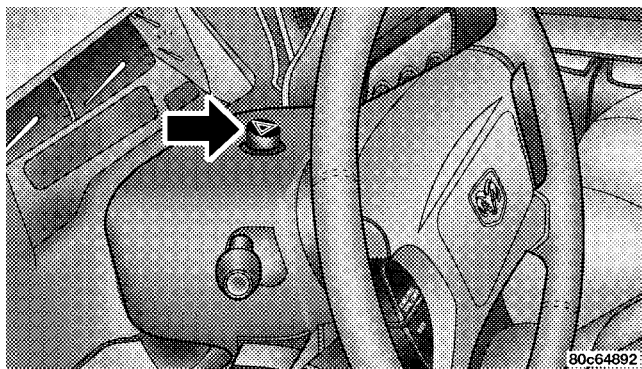

This is an emergency warning system and should not be used when the vehicle is in motion. Use it when your vehicle is disabled and is creating a safety hazard for other motorists.

If it is necessary to leave the vehicle to go for service, the flasher system will continue to operate with the ignition key removed and the vehicle locked.

ADDING FUEL

If using a portable fuel container, it should have a flexible nozzle long enough to reach past the restriction in the fuel filler tube.

WARNING!

A fire may result if gasoline is pumped into a portable container that is in a vehicle or on a truck bed. You could be burned. Always place gas containers on the ground while filling.

WARNING!

Remove the gas cap slowly to prevent fuel spray from the filler neck which may cause injury.

The volatility of present gasolines may cause a build up of pressure in the fuel tank that may increase while you drive. This pressure can result in a spray of gasoline and/or vapors when you remove the cap from a hot vehicle. Removing the cap slowly allows the pressure to vent and prevents fuel spray.

Never allow any lit smoking materials near the vehicles while removing the cap or filling the tank.

Never add fuel to the vehicle when the engine is running.

CHANGING A FLAT TIRE

Jack Location

In the Durango, the scissor jack and tire changing tools are stowed under the second row seat.

The jack is secured in place with a winged stud and a fixed stud. It is very important to secure the jack tightly in place by engaging the slot in the base to the fixed stud under the middle seat. The winged stud inserts through the eyelet in the end of the jack's worm screw.

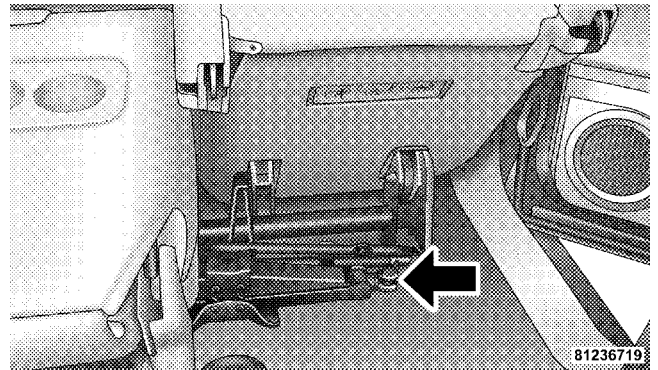

WARNING!

The jack is designed as a tool for changing tires only. The jack should not be used to lift the vehicle for service purposes, unless suitable supports are placed under the vehicle as a safety measure. The vehicle should be jacked on a firm level surface only. Avoid ice or slippery areas.

Removing The Spare Tire

The spare tire on the Dodge Durango is located underneath the vehicle in the rear.

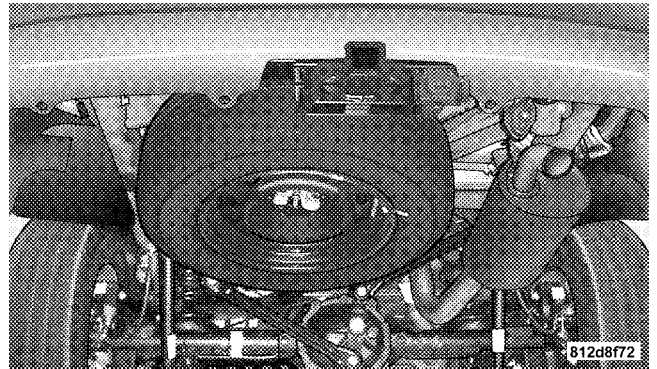

Remove the spare tire before attempting to jack the truck.

1. Remove the rubber plug from the floor in the cargo area.

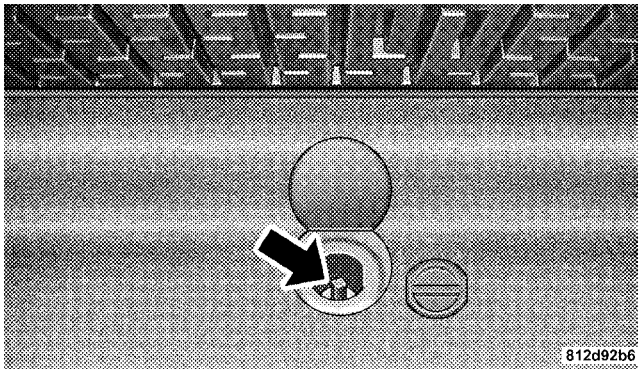

2. Engage the jack wrench extension to the spare tire winch through the hole in the floor.

3. Turn the wrench counterclockwise to lower the spare tire. Continue to turn the wrench until the spare tire can be pulled out from under the vehicle.

It is recommended that you stow the flat or spare to avoid tangling the loose cable.

CAUTION!

The winch mechanism is designed for use with the jack extension tube only. Use of an air wrench or other power tools is not recommended and can damage the winch.

Tire Changing Procedure

WARNING!

Getting under a jacked-up vehicle is dangerous. The vehicle could slip off the jack and fall on you. You could be crushed. Never get any part of your body under a vehicle that is on a jack. Never start or run the engine while the vehicle is on a jack. If you need to get under a raised vehicle, take it to a service center where it can be raised on a lift.

Do not raise this vehicle using a bumper jack. The scissor jack is designed as a tool for changing tires on this vehicle only. It is not recommended that the jack be used for service purposes or to lift more than one wheel at a time.

Preparations

Park the vehicle on a firm level surface, avoiding ice or slippery areas. Set the parking brake and place the gear selector in PARK (automatic transmission). On Four Wheel Drive vehicles, shift the transfer case to the "4L" position.

WARNING!

Do not attempt to change a tire on the side of the vehicle close to moving traffic. Pull far enough off the road to avoid the danger of being hit when operating the jack or changing the wheel.

- Turn on the Hazard Warning Flasher.

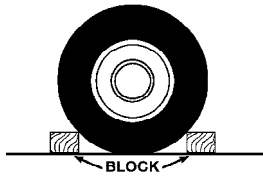

- Block both the front and rear of the wheel diagonally opposite the jacking position. For example, if the right front wheel is being changed, block the left rear wheel.

- Passengers should not remain in the vehicle when the vehicle is being jacked.

Instructions

1. Remove the spare wheel, jack, and tools from storage.
2. Remove wheel center cap using the spade end of the wheel wrench.
3. Using the wheel wrench, loosen, but do not remove, the wheel nuts by turning them counterclockwise one turn while the wheel is still on the ground.

4. When changing a front wheel, place the jack under the frame rail behind the wheel. Locate the jack as far forward as possible on the straight part of the frame (prior to inboard transition. Operate the jack using the jack drive tube and the wheel wrench - the tube extension, may be used but is not required.

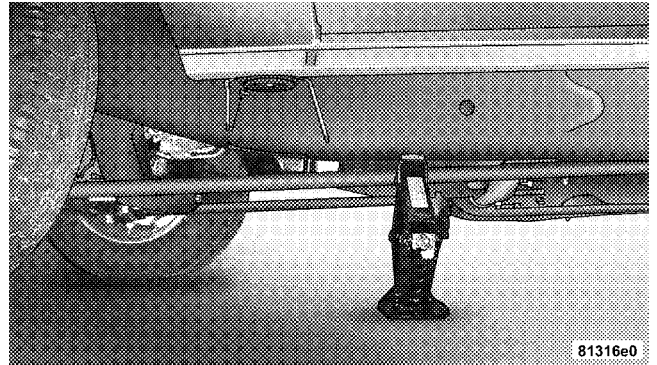

Front Jacking Location

When changing a rear wheel, assemble the jack drive tube to the jack and connect the drive tube to the extension tube. Place the jack under the axle as close to the tire as possible with the drive tubes extending to the rear. Connect the jack tube extension and wheel wrench.

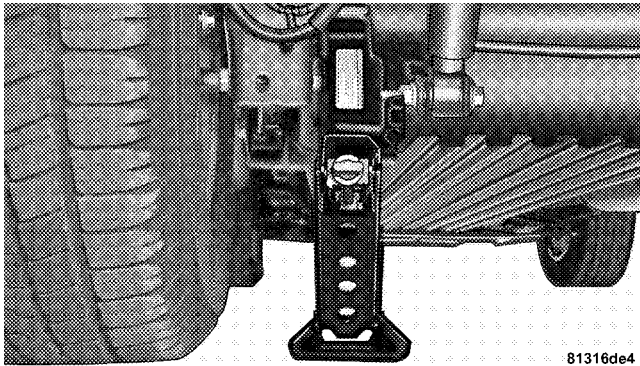

Rear Left Jacking Location

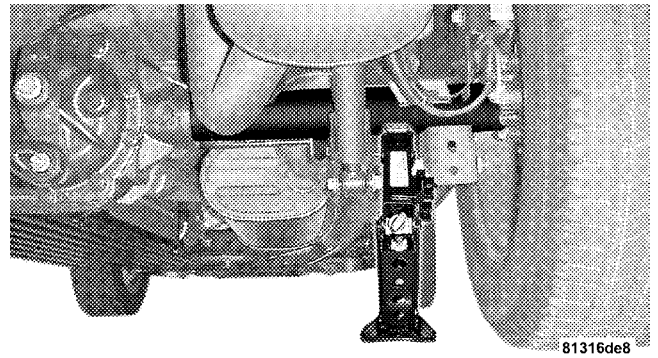

Rear Right Jacking Location

Before raising the wheel off the ground, make sure that the jack will not damage surrounding truck parts and adjust the jack position as required.

5. By rotating the wheel wrench clockwise, raise the vehicle until the wheel just clears the surface.

WARNING!

Raising the vehicle higher than necessary can make the vehicle unstable and cause an accident. It could slip off the jack and hurt someone near it. Raise the vehicle only enough to remove the tire.

6. Remove the wheel nuts and pull the wheel off. Install the spare wheel and wheel nuts with the cone shaped end of the nuts toward the wheel. Lightly tighten the nuts. To avoid risk of forcing the vehicle off the jack, do not fully tighten the nuts until the vehicle has been lowered.

NOTE: Do not oil wheel studs. For chrome wheels, do not substitute with chrome plated wheel nuts.

7. Using the wheel wrench, finish tightening the nuts in a crisscross pattern. Correct nut tightness is 85-115 ft. lbs. (115-155 N·m) torque. If in doubt about the correct tightness, have them checked with a torque wrench by your dealer or at a service station.

WARNING!

A loose tire or jack thrown forward in a collision or hard stop could injure someone in the vehicle. Always stow the jack, tools and the extra tire and wheel in the places provided.

8. Install wheel center cap and remove wheel blocks. Do not install chrome or aluminum wheel center caps on the spare wheel. This may result in cap damage.

9. Lower the jack to its fully closed position. Stow the replaced tire, jack, and tools as previously described.

10. Adjust the tire pressure when possible.

NOTE: Do not oil wheel studs. For chrome wheels, do not substitute with chrome plated wheel nuts.

WARNING!

Carefully follow these tire changing warnings to help prevent personal injury or damage to your vehicle:

- Always park on a firm, level surface as far from the edge of the roadway as possible before raising the vehicle.
- Block the wheel diagonally opposite the wheel to be raised.
- Apply the parking brake firmly before jacking.
- Never start the engine with the vehicle on a jack.
- Do not let anyone sit in the vehicle when it is on a jack.
- Do not get under the vehicle when it is on a jack.
- Only use the jack in the positions indicated.
- If working on or near a roadway, be extremely careful of motor traffic.
- To assure that spare tires, flat or inflated are securely stowed, spares must be stowed with the valve stem facing the ground.

To Stow The Flat Or Spare

Turn the wheel so that the valve stem is down. Slide the wheel retainer through the center of the wheel and position it properly across the wheel opening.

For convenience in checking the spare tire inflation, stow with the valve stem toward the rear of the vehicle.

Rotate the winch mechanism until the wheel is drawn into place against the underside of the vehicle. Continue to rotate until you feel the winch mechanism slip or click 2 times. It cannot be overtightened. Push against the tire several times to be sure it is firmly in place.

JUMP STARTING**WARNING!**

- **Battery fluid is a corrosive acid solution; do not allow battery fluid to contact eyes, skin or clothing. Don't lean over battery when attaching clamps or allow the clamps to touch each other. If acid splashes in eyes or on skin, flush the contaminated area immediately with large quantities of water.**
- **A battery generates hydrogen gas which is flammable and explosive. Keep flame or spark away from the vent holes. Do not use a booster battery or any other booster source with an output that exceeds 12 volts.**

Check the Battery Test Indicator (if equipped). If a light or bright colored dot is visible in the indicator (if equipped), DO NOT jump-start the battery.

If the indicator (if equipped) is dark or shows a green dot, proceed as follows:

1. Wear eye protection and remove all metal jewelry such as watch bands or bracelets which might make an unintended electrical contact.
2. Park the booster vehicle within cable reach but without letting the vehicles touch. Set the parking brake, place the automatic transmission in PARK and turn the ignition OFF on both vehicles.
3. Turn OFF heater, radio and all unnecessary electrical loads.

4. Connect one end of a jumper cable to the positive terminal of the booster battery. Connect the other end of the same cable to the positive terminal of the discharged battery.

WARNING!

Do not permit vehicles to touch each other as this could establish a ground connection and personal injury could result.

5. Connect the other cable, first to the negative terminal of the booster battery and then to the engine of the vehicle with the discharged battery. Make sure you have a good contact on the engine.

WARNING!

Do not connect the cable to the negative post of the discharge battery. The resulting electrical spark could cause the battery to explode.

During cold weather when temperatures are below freezing point, electrolyte in a discharged battery may freeze. Do not attempt jump starting because the battery could rupture or explode. The battery temperature must be brought up above freezing point before attempting jump start.

6. Start the engine in the vehicle which has the booster battery, let the engine idle a few minutes, then start the engine in the vehicle with the discharged battery.

7. When removing the jumper cables, reverse the above sequence exactly. Be careful of the moving belts and fan.

WARNING!

Any procedure other than above could result in:

- 1. Personal injury caused by electrolyte squirting out the battery vent;**
- 2. Personal injury or property damage due to battery explosion;**
- 3. Damage to charging system of booster vehicle or of immobilized vehicle.**

TOWING A DISABLED VEHICLE

Proper towing or lifting equipment is required to prevent damage to your vehicle. Use of safety chains is recommended. **Attach towing device to main structural members of the vehicle — not to bumpers or associated brackets. State and local laws applying to vehicles under tow must be observed.**

Four-Wheel Drive Vehicles

The manufacturer recommends towing with all wheels off the ground. Acceptable methods are to tow the vehicle on a flatbed or with one end of the vehicle raised and the opposite end on a towing dolly.

Two-Wheel Drive Vehicles

Provided that the transmission is operable, tow with the transmission in Neutral and the ignition key in the OFF position along with the front wheels raised and the rear wheels on the ground. The speed must not exceed 30 mph (50 km/h) and the distance must not exceed 15 miles (25 km).

If the vehicle is to be towed more than 15 miles (25 km), it must be towed on a flatbed, or with the rear wheels raised and the front wheels on the ground, or with the front end raised and the rear wheels on a towing dolly.

MAINTAINING YOUR VEHICLE

CONTENTS

■ Engine Compartment 3.7L V6	286	□ Engine Oil	292
■ Engine Compartment 4.7L V-8	287	□ Engine Oil Filter	297
■ Engine Compartment 5.7L HEMI V-8	288	□ Drive Belts — Check Condition And Tension . .	297
■ Onboard Diagnostic System — OBD II	289	□ Spark Plugs	297
■ Emissions Inspection And Maintenance Programs	290	□ Ignition Cables	298
■ Replacement Parts	291	□ Engine Air Cleaner Filter	298
■ Dealer Service	291	□ Engine Fuel Filter	299
■ Maintenance Procedures	292	□ Catalytic Converter	299
		□ Maintenance-Free Battery	300

- Air Conditioner Maintenance 302
- Power Steering — Fluid Check 303
- Front Suspension Ball Joints 304
- Drive Shaft Constant Velocity Joints 304
- Body Lubrication 304
- Windshield Wiper Blades 305
- Windshield Washers 305
- Exhaust System 306
- Cooling System 306
- Emission Related Components 311
- Brake System 313
- Automatic Transmission 315
- Transfer Case 319
- Axles 319
- Selection Of Lubricating Grease 320
- Appearance Care And Protection From Corrosion 321
- Power Distribution Center (Fuse/Relay) 325
- Fuse Block 325
- Vehicle Storage 326
- Replacement Light Bulbs 327
- Bulb Replacement 327
 - Headlights/Parking/Turn Signal 327
 - Rear Side Marker, Tail Lights, Turn Signals And Backup Lights — Replacement 329
 - License Lights 333
 - Center High-Mounted Stoplight 334

□ Fog Lights	335	□ Engine	337
■ Fluids And Capacities	335	□ Chassis	338
■ Recommended Fluids, Lubricants And Genuine Parts	337		

ENGINE COMPARTMENT 3.7L V6

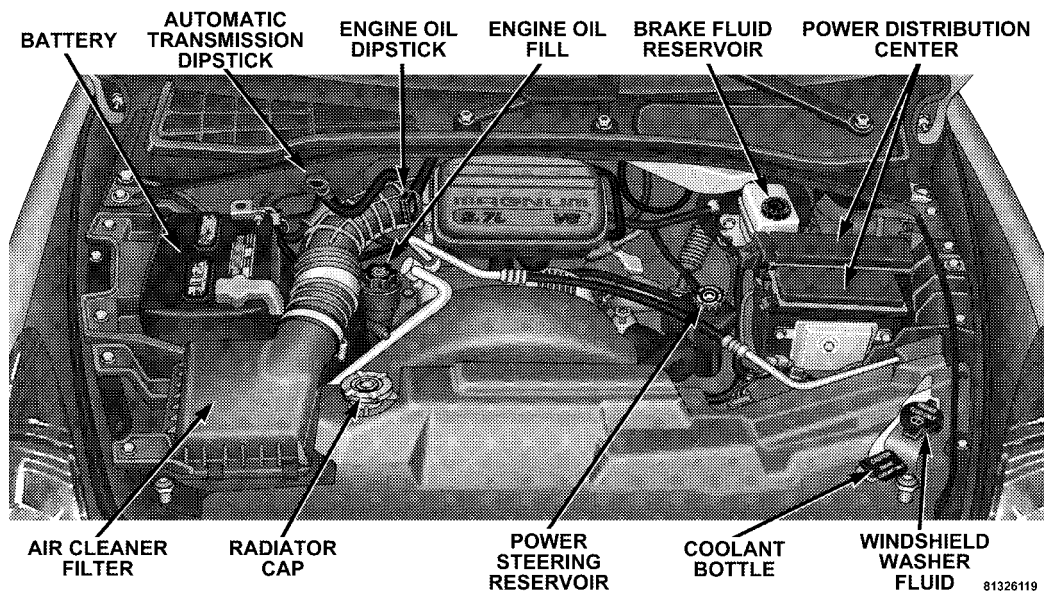

ENGINE COMPARTMENT 4.7L V-8

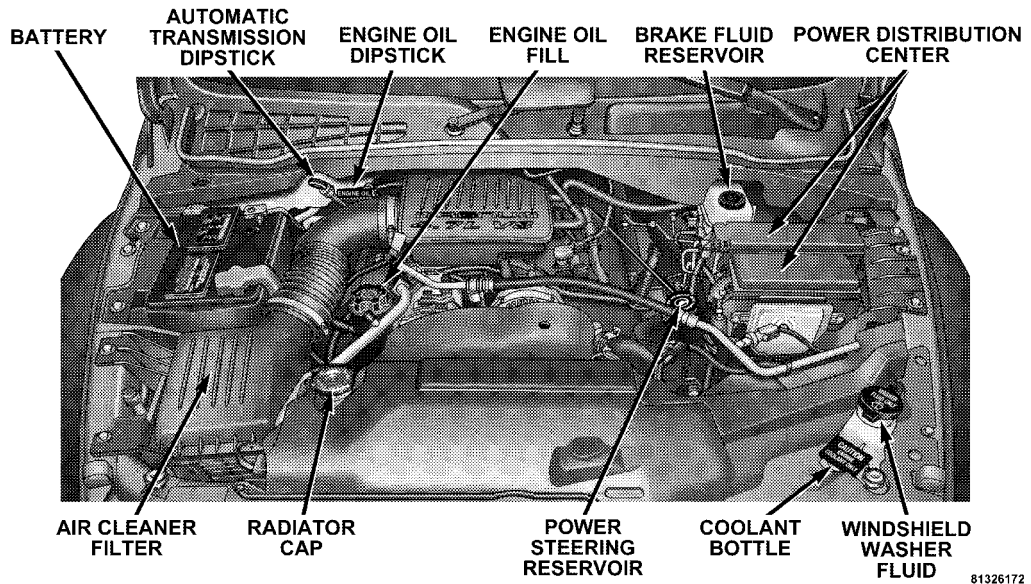

81326172

ENGINE COMPARTMENT 5.7L HEMI V-8

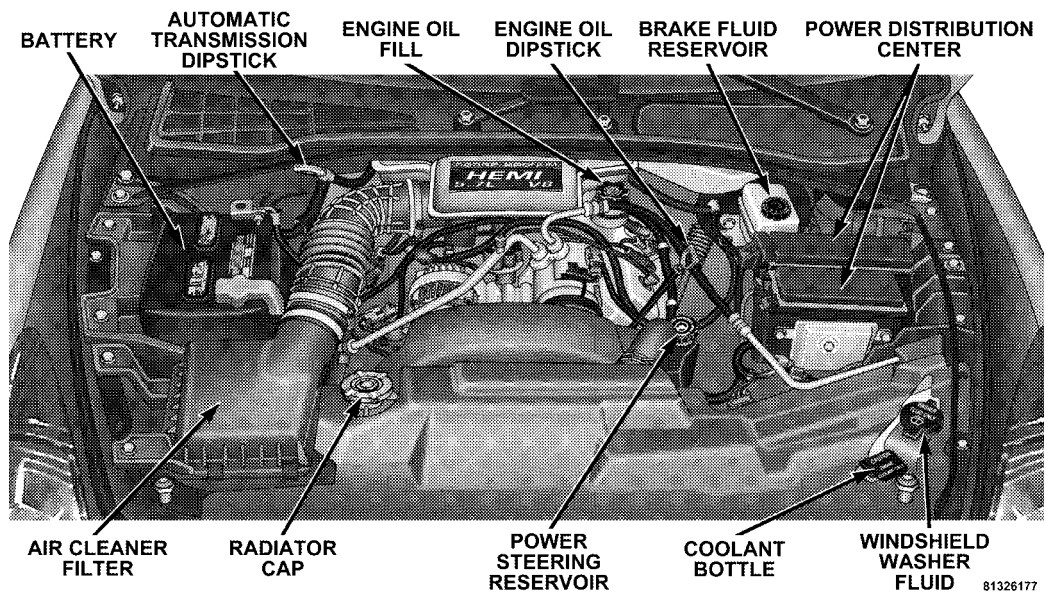

ONBOARD DIAGNOSTIC SYSTEM — OBD II

Your vehicle is equipped with a sophisticated onboard diagnostic system called OBD II. This system monitors the performance of the emissions, engine, and automatic transmission control systems. When these systems are operating properly, your vehicle will provide excellent performance and fuel economy, as well as engine emissions well within current government regulations.

If any of these systems require service, the OBD II system will turn on the “Malfunction Indicator Light.” It will also store diagnostic codes and other information to assist your service technician in making repairs. Although your vehicle will usually be drivable and not need towing, see your dealer for service as soon as possible.

CAUTION!

- **Prolonged driving with the “Malfunction Indicator Light” on could cause further damage to the emission control system. It could also affect fuel economy and driveability. The vehicle must be serviced before any emissions tests can be performed.**
- **If the “Malfunction Indicator Light” is flashing while the engine is running, severe catalytic converter damage and power loss will soon occur. Immediate service is required.**

EMISSIONS INSPECTION AND MAINTENANCE PROGRAMS

In some localities, it may be a legal requirement to pass an inspection of your vehicle's emissions control system. Failure to pass could prevent vehicle registration.

 For states which have an I/M (Inspection and Maintenance) requirement, this check verifies the following: the MIL (Malfunction Indicator Lamp) is functioning and is not on when the engine is running, and that the OBD (On Board Diagnostic) system is ready for testing.

Normally, the OBD system will be ready. The OBD system may **not** be ready if your vehicle was recently serviced, if you recently had a dead battery, or a battery replacement. If the OBD system should be determined not ready for the I/M test, your vehicle may fail the test.

Your vehicle has a simple ignition key actuated test which you can use prior to going to the test station. To check if your vehicle's OBD system is ready, you must do the following:

1. Insert your ignition key into the ignition switch.
2. Turn the ignition to the ON position, but do not crank or start the engine.
3. If you crank or start the engine, you will have to start this test over.
4. As soon as you turn your key to the ON position, you will see your MIL symbol come on as part of a normal bulb check.
5. Approximately 15 seconds later, one of two things will happen:
 - a. The MIL light will blink for approximately 5 seconds and then remain on until the first engine crank or

the key is turned off. This means that your vehicle's OBD system is **not ready** and you should **not** proceed to the I/M station.

b. The MIL light will remain fully illuminated until the first engine crank or the key is turned off. This means that your vehicle's OBD system is **ready** and you can proceed to the I/M station.

If your OBD system is **not ready**, you should see your dealer or repair facility. If your vehicle was recently serviced or had a battery failure or replacement, you may need to do nothing more than drive your vehicle as you normally would in order for your OBD system to update. A recheck with the above test routine may then indicate that the system is now ready.

Regardless of whether your vehicle's OBD system is ready or not ready, if the MIL symbol is illuminated during normal vehicle operation, you should have your

vehicle serviced before going to the I/M station. The I/M station can fail your vehicle because the MIL symbol is on with the engine running.

REPLACEMENT PARTS

Use of genuine Mopar® parts for normal/scheduled maintenance and repairs is highly recommended to insure the designed performance. Damage or failures caused by the use of non-Mopar® parts for maintenance and repairs will not be covered by the manufacturer's warranty.

DEALER SERVICE

Your dealer has the qualified service personnel, special tools and equipment to perform all service operations in an expert manner. Service manuals are available which include detailed service information for your vehicle. Refer to these manuals before attempting any procedure yourself.

NOTE: Intentional tampering with emissions control systems can result in civil penalties being assessed against you.

WARNING!

You can be badly injured working on or around a motor vehicle. Do only that service work for which you have the knowledge and the proper equipment. If you have any doubt about your ability to perform a service job, take your vehicle to a competent mechanic.

MAINTENANCE PROCEDURES

The pages that follow contain the **required** maintenance services determined by the engineers who designed your vehicle.

Besides the maintenance items for which there are fixed maintenance intervals, there are other items that should operate satisfactorily without periodic maintenance. However, if a malfunction of these items does occur, it could adversely affect the engine or vehicle performance. These items should be inspected if a malfunction is observed or suspected.

Engine Oil

Checking Engine Oil Level

To assure proper lubrication of your vehicle's engine, the engine oil must be maintained at the correct level. The best time to check the engine oil level is about 5 minutes after a fully warmed up engine is shut off or before starting the engine after it has sat overnight.

1. Position the vehicle on a level surface.
2. Turn Off the engine and allow approximately 5 minutes for the oil to settle to the bottom of the crankcase.
3. Remove the engine oil level indicator (dipstick).
4. Wipe the engine oil level indicator (dipstick) clean.
5. Install the engine oil level indicator (dipstick) and make sure it is seated in the tube.
6. Remove the engine oil level indicator (dipstick), keeping the handle above the tip, and read the oil level on the engine oil level indicator (dipstick).
7. Add oil only if the level is below the "SAFE" range (at or below the "ADD" mark) on the engine oil level indicator (dipstick). Adding one quart of oil when the reading is at the ADD mark will result in a SAFE reading on these engines.

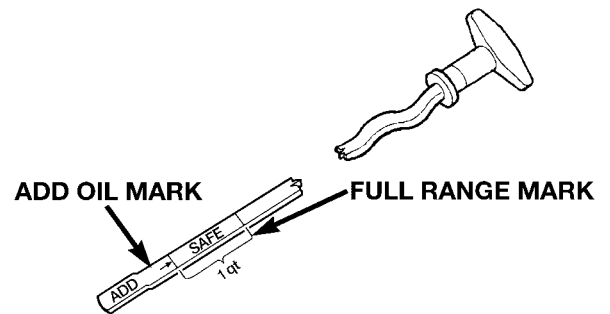

80c0715e

CAUTION!

Overfilling or underfilling the crankcase will cause oil aeration or loss of oil pressure. This could damage your engine.

Frequency Of Oil Change

Road conditions and your style of driving affect the interval at which your oil should be changed. Check the following to determine if ANY apply to you:

- Day or night temperatures are below 32°F (0°C).
- Stop and Go driving.
- Extensive engine idling.
- Driving in dusty conditions.
- Short trips of less than 10 miles (16.2 km).
- More than 50% of your driving is at sustained high speeds during hot weather, above 90°F (32°C).
- Trailer towing, Taxi, Police or delivery service (commercial service).
- Off-Road or desert operation.

- **If equipped for and operating with E-85 (ethanol) fuel.**

NOTE: If ANY of these apply to you then change your engine oil every 3,000 miles (5 000 km) or 3 months, whichever comes first and follow schedule "B" of the "Maintenance Schedules" section of this manual.

If none of these apply to you, then change your engine oil at every interval shown on schedule "A" of the "Maintenance Schedules" section of this manual.

4x4 Models, If Used Primarily For Off-Road Operation
Every 50 hours of use.

Dusty Conditions

Driving through dust-laden air increases the problems of keeping abrasive materials out of the engine. Under these conditions, special attention should be given to the engine air cleaner and the crankcase inlet air cleaner. The crankcase ventilation system should also be checked

periodically. Make sure that these units are always clean. This will tend to reduce to a minimum the amount of abrasive material that may enter the engine.

Engine Oil Selection

For best performance and maximum protection under all types of operating conditions, the manufacture only recommends engine oils that are API certified and meet the requirements of DaimlerChrysler Material Standard MS-6395. Use Mopar or an equivalent oil meeting the specification MS-6395.

Engine Oil Identification (API) Symbol

There is a symbol to aid you in selecting the proper engine oil.



This symbol means that the oil has been certified by the American Petroleum Institute (API). The manufacture only recommends API Certified engine oils that meet the requirements of DaimlerChrysler Material Standard MS-6395. Use Mopar or an equivalent oil meeting the specifi-

cation MS-6395.

Engine Oil Viscosity Chart

The proper SAE viscosity grade of engine oil should be selected based on the following recommendation and be within the operating temperature shown in the recommended SAE viscosity chart.

- SAE 5W-30 is the preferred oil for Dodge Trucks with 3.7L/4.7L/5.7L engines. Synthetic engine oils may be

used provided that the oil quality requirements described above are met and the recommended maintenance intervals for oil and filter changes are followed.

- Lubricants which do not have both the engine oil certification mark or current service symbol and the correct viscosity grade number should not be used.

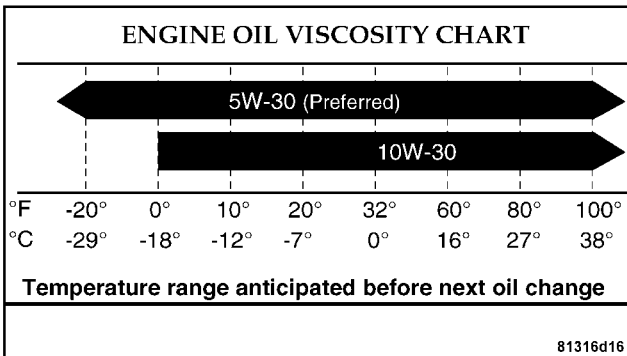

Preferred Viscosity for 3.7L/4.7L/5.7L Engines

Synthetic Engine Oils

There are a number of engine oils being promoted as either synthetic or semi-synthetic. If you chose to use such a product, use **only** those oils that meet the American Petroleum Institute (API) and SAE viscosity standard. Follow the service schedule that describes your driving type.

Materials Added to Engine Oils

The manufacture strongly recommends against the addition of any additives (other than leak detection dyes) to the engine oil. Engine oil is an engineered product and it's performance may be impaired by supplemental additives.

Disposing of Used Engine Oil And Oil Filters

Care should be taken in disposing of used engine oil and oil filters from your vehicle. Used oil and oil filters, indiscriminately discarded, can present a problem to the environment. Contact your dealer, service station, or

governmental agency for advice on how and where used oil and oil filters can be safely discarded in your area.

Engine Oil Filter

The engine oil filter should be replaced at every engine oil change.

Engine Oil Filter Selection

The manufacturer's engines have a full-flow type oil filter. Use a filter of this type for replacement. The quality of replacement filters varies considerably. Only high quality filters should be used to assure most efficient service. Mopar® Engine Oil Filters are a high quality oil filter and are recommended.

Drive Belts — Check Condition and Tension

At the mileage indicated in the maintenance schedule, all belts should be checked for condition and proper tension. Improper belt tension can cause belt slippage and failure.

Belts should be inspected for evidence of cuts, cracks, or glazing, and replaced if there is indication of damage which could result in belt failure. If adjustment is required, see your authorized dealer for service. Low generator belt tension can cause battery failure. A special tool is required to properly measure tension and to restore belt tension to factory specifications.

Also check belt routing to make sure there is no interference between the belts and other engine components.

Spark Plugs

Spark plugs must fire properly to assure proper engine performance and emission control. The plugs installed in your vehicle should operate satisfactorily in normal service for the mileage indicated in the Maintenance Chart. New plugs should be installed at this mileage. The entire set should be replaced if there is any malfunction

due to a faulty spark plug. Check the Vehicle Emissions Control Information label for the proper type of spark plug for your vehicle.

CAUTION!

When replacing plugs, do not overtighten. You could damage them and cause them to leak.

Ignition Cables

Replace the ignition cables (5.7L engines only) at the mileage interval shown in the maintenance charts.

Engine Air Cleaner Filter

Under normal driving conditions, replace the air filter at the intervals shown on Schedule "A". If, however, you

drive the vehicle frequently under dusty or severe conditions, the filter element should be inspected periodically and replaced if necessary at the intervals shown on Schedule "B".

WARNING!

The air cleaner can provide a measure of protection in the case of engine backfire. Do not remove the air cleaner unless such removal is necessary for repair or maintenance. Make sure that no one is near the engine compartment before starting the vehicle with the air cleaner removed. Failure to do so can result in serious personal injury.

Engine Fuel Filter

A plugged fuel filter can cause stalling, limit the speed at which a vehicle can be driven or cause hard starting. Should an excessive amount of dirt accumulate in the fuel tank, frequent filter replacement may be necessary.

Catalytic Converter

The catalytic converter requires the use of unleaded fuel only. Leaded gasoline will destroy the effectiveness of the catalyst as an emission control device.

Under normal operating conditions, the catalytic converter will not require maintenance. However, it is important to keep the engine properly tuned to assure proper catalyst operation and prevent possible catalyst damage.

CAUTION!

Damage to the catalytic converter can result if your vehicle is not kept in proper operating condition. In the event of engine malfunction, particularly involving engine misfire or other apparent loss of performance, have your vehicle serviced promptly. Continued operation of your vehicle with a severe malfunction could cause the converter to overheat, resulting in possible damage to the converter and the vehicle.

NOTE: Intentional tampering with emissions control systems can result in civil penalties being assessed against you.

WARNING!

A hot exhaust system can start a fire if you park over materials that can burn. Such materials might be grass or leaves coming into contact with your exhaust system. Do not park or operate your vehicle in areas where your exhaust system can contact anything that can burn.



In unusual situations involving grossly malfunctioning engine operation, a scorching odor may indicate severe and abnormal catalyst overheating. If this occurs, the vehicle should be stopped, the engine shut off and the vehicle allowed to cool. Thereafter, service, including a tune-up to manufacturer's specifications, should be obtained immediately.

To minimize the possibility of catalyst damage:

- Do not shut off the engine or interrupt the ignition when the transmission is in gear and the vehicle is in motion.
- Do not try to start engine by pushing or towing the vehicle.
- Do not idle the engine with any spark plug wires disconnected or removed, such as when diagnostic testing, or for prolonged periods during very rough idling or malfunctioning operating conditions.

Maintenance-Free Battery

All Dodge trucks are equipped with maintenance-free batteries. You will never have to add water, nor is periodic maintenance required.

WARNING!		
<p>Battery posts, terminals, and related accessories contain lead and lead compounds. Always wash hands after handling the battery.</p>		
BATTERY CONDITION INDICATOR		<p>DARKENED INDICATOR WITH GREEN DOT</p> <ul style="list-style-type: none"> • BATTERY CHARGE OK • FLUID LEVEL OK
		<p>DARKENED INDICATOR NO GREEN DOT</p> <ul style="list-style-type: none"> • BATTERY CHARGE LOW • FLUID LEVEL OK
		<p>YELLOW OR BRIGHT INDICATOR</p> <ul style="list-style-type: none"> • BATTERY CHARGE UNKNOWN • FLUID LEVEL LOW <p>(CHARGE MAY STILL BE SUFFICIENT TO START YOUR CAR)</p>

8000cbce

To determine the battery charge, check the battery test indicator (if equipped) on top of the battery. Refer to the illustration.

CAUTION!
<p>It is essential when replacing the cables on the battery that the positive cable is attached to the positive post and the negative cable is attached to the negative post. Battery posts are marked (+) positive and negative (-) and identified on the battery case. Also, if a “fast charger” is used while battery is in the vehicle, disconnect both vehicle battery cables before connecting the charger to battery. Do not use a “fast charger” to provide starting voltage.</p>

Air Conditioner Maintenance

For best possible performance, your air conditioner should be checked and serviced by an Authorized Dealer at the start of each warm season. This service should include cleaning of the condenser fins and a performance test. Drive belt tension should also be checked at this time.

WARNING!

- **Use only refrigerants and compressor lubricants approved by the manufacturer for your air conditioning system. Some unapproved refrigerants are flammable and can explode, injuring you. Other unapproved refrigerants or lubricants can cause the system to fail, requiring costly repairs.**
- **The air conditioning system contains refrigerant under high pressure. To avoid risk of personal injury or damage to the system, adding refrigerant or any repair requiring lines to be disconnected should be done by an experienced repairman.**

Refrigerant Recovery and Recycling

R-134a Air Conditioning Refrigerant is a hydrofluorocarbon (HFC) that is endorsed by the Environmental Protection Agency and is an ozone-saving product. However, the manufacturer recommends that air conditioning service be performed by dealers or other service facilities using recovery and recycling equipment.

NOTE: Air Conditioning systems found to be contaminated with A/C System Sealers, Stop Leak Products, Seal Conditioners, Compressor Oil, or Refrigerants not approved by the manufacturer, voids the warranty for the Air Conditioning system.

Power Steering — Fluid Check

Checking the power steering fluid level at a defined service interval is not required. The fluid should only be checked if a leak is suspected, abnormal noises are

apparent, and/or the system is not functioning as anticipated. Coordinate inspection efforts through a certified DaimlerChrysler Dealership."

WARNING!

Fluid level should be checked on a level surface and with the engine off to prevent injury from moving parts and to insure accurate fluid level reading. Do not overfill. Use only manufacturers recommended power steering fluid.

If necessary, add fluid to restore to the proper indicated level. With a clean cloth, wipe any spilled fluid from all surfaces. Refer to Recommended Fluids, Lubricants, and Genuine Parts for correct fluid type.

Front Suspension Ball Joints

The ball joints and seals should be inspected whenever the vehicle is serviced for other reasons. Damaged seals should be replaced to prevent leakage or contamination of the grease.

Drive Shaft Constant Velocity Joints

All four wheel drive models are equipped with four constant velocity joints. Periodic lubrication of these joints is not required. However, the joint boot should be inspected for external leakage or damage periodically. If external leakage or damage is evident, the joint boot and grease should be replaced immediately. Continued operation could result in failure of the joint due to water and dirt contamination of the grease. This would require complete replacement of the joint assembly. Refer to the Service Manual for the detailed replacement procedure.

Body Lubrication

Locks and all body pivot points, including such items as seat tracks, doors, liftgate and hood hinges, should be lubricated periodically to assure quiet, easy operation and to protect against rust and wear. Prior to the application of any lubricant, the parts concerned should be wiped clean to remove dust and grit; after lubricating excess oil and grease should be removed. Particular attention should also be given to hood latching components to insure proper function. When performing other underhood services, the hood latch, release mechanism and safety catch should be cleaned and lubricated.

The external lock cylinders should be lubricated twice a year, preferably in the fall and spring. Apply a small amount of a high quality lubricant such as Mopar® Lock Cylinder Lubricant directly into the lock cylinder.

Windshield Wiper Blades

The rubber edges of the wiper blades and the windshield should be cleaned periodically with a sponge or soft cloth and a mild nonabrasive cleaner. This will remove accumulations of salt or road film.

Operation of the wipers on dry glass for long periods may cause deterioration of the wiper blades. Always use washer fluid when using the wipers to remove salt or dirt from a dry windshield.

Avoid using the wiper blades to remove frost or ice from the windshield. Keep the blade rubber out of contact with petroleum products such as engine oil, gasoline, etc.

Windshield Washers

The fluid reservoir should be checked for fluid level at regular intervals. When freezing weather is anticipated, flush out the water in the reservoir by operating the

system. Fill the reservoir with windshield washer anti-freeze (not radiator antifreeze), and operate the system for a few seconds to flush out the residual water.

To prevent freeze-up of your windshield washer system in cold weather, select a solution or mixture that meets or exceeds the temperature range of your climate. This rating information can be found on most washer fluid containers.

WARNING!

Commercially available windshield washer solvents are flammable. They could ignite and burn you. Care must be exercised when filling or working around the washer solution.

After the engine has warmed, operate the defroster for a few minutes to reduce the possibility of smearing or

freezing the fluid on the cold windshield. Mopar® All Weather Windshield Washer Solution used with water as directed on the container, aids cleaning action, reduces freezing point to avoid line clogging, and is not harmful to paint or trim.

Exhaust System

The best protection against carbon monoxide entry into the vehicle body is a properly maintained engine exhaust system.

Whenever a change is noticed in the sound of the exhaust system, when exhaust fumes can be detected inside the vehicle, or when the underside or rear of the vehicle is damaged, have a competent mechanic inspect the complete exhaust system and adjacent body areas for broken, damaged, deteriorated, or mispositioned parts. Open seams or loose connections could permit exhaust fumes to seep into the passenger compartment. In addition,

inspect the exhaust system each time the vehicle is raised for lubrication or oil change. Replace as required.

WARNING!

Exhaust gases can injure or kill. They contain carbon monoxide (CO) which is colorless and odorless. Breathing it can make you unconscious and can eventually poison you. To avoid breathing CO, follow the preceding safety tips.

Cooling System

Inspection

Coolant protection checks should be made at every 12 months (before the onset of freezing weather, where applicable). If coolant is dirty or rusty in appearance, the system should be drained, flushed and refilled with fresh coolant. Check face of radiator for any accumulation of

bugs, leaves, etc. If dirty, clean the radiator core by gently spraying water from a garden hose at the back of the core.

Check the coolant bottle tubing for condition and tightness of connection at coolant bottle and radiator. Inspect the entire system for leaks.

With the engine at normal operating temperature (but not running), check the coolant pressure cap for proper vacuum sealing by draining a small amount of coolant from the radiator drain cock. If the cap is sealing properly, the coolant will begin to drain from the coolant bottle. Do not remove the pressure cap when the cooling system is hot.

WARNING!

You or others can be badly burned by hot coolant or steam from your radiator. If you see or hear steam coming from under the hood don't open the hood until the radiator has had time to cool. If you open the hood and see steam or hot coolant escaping from the radiator, don't touch anything. Get away quickly. Never try to open a pressure cap when the radiator is hot.

Cooling System Maintenance

At the intervals shown in the Maintenance Schedules section of this manual, the system should be drained, flushed and refilled. See your authorized dealer for proper cooling system maintenance.

Cooling System — Drain, Flush And Refill

If the solution is dirty and contains a considerable amount of sediment, it should be cleaned and flushed. See your authorized dealer for proper draining, flushing and refilling of your vehicle's cooling system.

Disposal of Used Engine Coolant

Used ethylene glycol based engine coolant is a regulated substance requiring proper disposal. Check with your local authorities to determine the disposal rules for your community. Do not store ethylene glycol based engine coolant in open containers or allow it to remain in puddles on the ground. Prevent ingestion by animals and children. If ingested by a child contact a physician immediately. Clean up any ground spills immediately.

Recommended Engine Coolant

This vehicle has been factory filled with an Ethylene Glycol based engine coolant with long life corrosion inhibitors (called HOAT, for Hybrid Organic Additive Technology). Follow the "Maintenance Schedule" for the recommended coolant change intervals. Refer to Recommended Fluids, Lubricants and Genuine Parts for correct fluid type.

CAUTION!

Mixing of coolants other than specified (non-HOAT), may result in engine damage that may not be covered under the new vehicle warranty, and decreased corrosion protection. If a non-HOAT coolant is introduced into the cooling system in an emergency, it should be replaced with the specified coolant as soon as possible.

Do not use plain water alone or alcohol base antifreeze products. Do not use additional rust inhibitors or antirust products, as they may not be compatible with the radiator coolant and may plug the radiator.

This vehicle has not been designed for use with Propylene Glycol based coolants. Use of Propylene Glycol based coolants is not recommended.

Adding Coolant

When adding coolant or refilling system, a 50% solution of ethylene glycol antifreeze coolant in water should be used. Higher concentrations (not to exceed 65%) are required if temperatures below -37°F (-38°C) are anticipated.

Use only high purity water such as distilled or deionized water when mixing the water/antifreeze solution. The use of lower quality water will reduce the amount of corrosion protection in the engine cooling system.

NOTE: It is the owner's responsibility to maintain the proper level of protection against freezing according to the temperatures occurring in the area where the vehicle is operated.

WARNING!

Never add coolant to the radiator when the engine is overheated. Do not loosen or remove pressure cap to cool overheated engine. The coolant is under pressure and severe scalding could result.

Coolant Pressure Cap

The coolant pressure cap must be fully tightened to prevent loss of coolant, and to insure that coolant will return to the radiator from the coolant coolant bottle.

The pressure cap should be inspected and cleaned if there is any accumulation of foreign material on the sealing surfaces.

WARNING!

The warning words "DO NOT OPEN HOT" on the coolant pressure cap are a safety precaution. Heat causes pressure to build up in the cooling system. To prevent scalding or injury, do not remove the pressure cap when the system is hot or under pressure.

Coolant Level

The coolant bottle system provides a quick visual method for determining that the coolant level is adequate. With the engine idling, and warmed to normal operating temperature, remove the cap from the bottle, remove the dipstick and wipe the excess coolant from it. Reinsert the dipstick and remove. Observe the dipstick checking the holes along the stem for coolant. Check the coolant level whenever the hood is raised.

The radiator normally remains completely full, so there is no need to remove the pressure cap except checking coolant freeze point or replacement with new antifreeze coolant. Your service attendant should be advised of this. When additional coolant is needed to maintain the proper level, it should be added to the coolant bottle. Do not overfill.

Points To Remember

- A. Do not overfill the coolant bottle.
- B. Check coolant freeze point in the radiator and in the coolant bottle. If antifreeze needs to be added, contents of coolant bottle also must be protected against freezing.
- C. If frequent coolant additions are required, or if the level in the coolant bottle does not drop when the engine cools, the cooling system should be pressure tested for leaks.
- D. Maintain a minimum coolant concentration of 50% ethylene glycol.
- E. Make sure that the radiator and coolant bottle overflow hoses are not kinked or obstructed.
- F. Keep the front of the radiator clean. If your vehicle is equipped with air conditioning, keep the front of the condenser clean also.
- G. The thermostat should not be changed for summer or winter operation. If replacement is ever necessary, install **ONLY** the correct type thermostat. Other designs may result in unsatisfactory cooling performance.

Emission Related Components

Fuel System Hoses And Vapor/Vacuum Harnesses

When the vehicle is serviced for scheduled maintenance, inspect surface of hoses and nylon tubing for evidence of heat and mechanical damage. Hard and brittle rubber, cracking, checking, tears, cuts, abrasions, and excessive

swelling suggest deterioration of the rubber. Particular attention should be given to examining hose surfaces nearest to high heat sources, such as the exhaust manifold.

Insure nylon tubing in these areas has not melted or collapsed.

Inspect all hose clamps and couplings to make sure they are secure and no leaks are present.

NOTE: Fluids such as oil, power steering fluid, and brake fluid are used during assembly plant operations to ease the assembly of hoses to couplings. Therefore, oil wetness at the hose-coupling area is not necessarily an indication of leakage. Actual dripping of hot fluid when systems are under pressure (during vehicle operation), should be noted before hose is replaced based on leakage.

You are urged to use only the manufacturer's specified hoses and clamps, or their equivalent in material and

specification, in any fuel system servicing. It is mandatory to replace all clamps that have been loosened or removed during service. Care should be taken in installing new clamps to insure they are properly torqued.

Positive Crankcase Ventilation (PCV) Valve

Proper operation of the crankcase ventilation system requires that the PCV valve be free of sticking or plugging because of deposits. Deposits can accumulate in the PCV valve and passage with increasing mileage. Have the PCV valve, hoses, and passages checked for proper operation at the intervals specified. If the valve is plugged or sticking, replace with a new valve – **Do not attempt to clean the oil PCV valve!** Check ventilating hose for indication of damage or plugging with deposits. Replace if necessary.

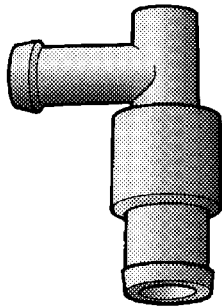

90244666

Brake System

Power Disc Brakes (Front)

Disc brakes do not require adjustment; however, several hard stops during the break-in period are recommended to seat the linings and wear off any foreign material.

Brake Master Cylinders

The fluid level in the master cylinders should be checked whenever the vehicle is serviced, or immediately if the brake system warning light is on. If necessary, add fluid to bring level to the full mark on the side of the reservoir of the brake master cylinder. Be sure to clean the top of the master cylinder area before removing the cap. With disc brakes, fluid level can be expected to fall as the brake pads wear. Brake fluid level should be checked when pads are replaced. If the brake fluid level is abnormally low, check system for leaks.

Refer to Recommended Fluids, Lubricants and Genuine Parts for correct fluid type.

WARNING!

Use of brake fluid that may have a lower initial boiling point, or is unidentified, as to specifications may result in sudden brake failure during hard prolonged braking. You could have an accident.

WARNING!

Overfilling the brake fluid reservoir can result in spilling brake fluid on hot engine parts and the brake fluid catching on fire.

Use only brake fluid that has been in a tightly closed container to avoid contamination from foreign matter or moisture.

CAUTION!

Do not allow a petroleum-base fluid to contaminate the brake fluid. Seal damage may result.

Brake Hoses

Inspection should be performed whenever the brake system is serviced or at intervals specified. Inspect hydraulic brake hoses for surface cracking, scuffing or worn spots. If there is any evidence of cracking, scuffing, or worn spots, the hose should be replaced immediately! Eventual deterioration of the hose can take place with possible burst failure.

WARNING!

Worn brake hoses can burst and cause brake failure. You could have an accident. If you see any sign of cracking, scuffing, or worn spots, have the brake hoses replaced immediately.

Automatic Transmission**Fluid Level Check - 3.7L Engine**

This fluid level should be checked when the engine is fully warmed up and the fluid in the transmission is heated to its normal operating temperature. Operation of the transmission with an improper fluid level will greatly reduce the life of the transmission and of the fluid. Check the fluid whenever the vehicle is serviced for other reasons.

NOTE: Whenever the fluid level is checked, especially on a vehicle used in severe service, the condition of the fluid should be noted. If the fluid is dark and has a strong odor, fluid should be changed.

A physical change in the fluid may be the result of overheating, resulting in fluid degradation. This is possible in severe service or if the vehicle is equipped with a non-factory installed air-conditioning unit.

To check the automatic transmission fluid level properly, the following procedure must be used:

1. The vehicle must be on level ground.
2. The engine should be running at curb idle speed for a minimum of 60 seconds.
3. Fully apply parking brake.
4. Place the gear selector briefly in each gear position ending with the lever in N (Neutral).

5. Remove the dipstick and feel if the fluid is hot or warm. Hot fluid is approximately 180°F (82°C), the normal operating temperature after the vehicle has been driven at least 15 miles (24 km). The fluid cannot be comfortably held between the finger tips. Warm is when fluid is between 85° and 125°F (29° and 52°C).

6. Wipe the dipstick clean and reinsert until seated. Remove dipstick and note reading.

- a. If the fluid is hot, the reading should be in the crosshatched area marked "OK".
- b. If the fluid is warm, the reading should be between the two holes.

If the fluid level is low, add sufficient fluid to bring to the proper level.

Fluid is added through the dipstick tube.

NOTE: To prevent dirt and water from entering the transmission after checking or replenishing fluid, make certain that the dipstick cap is properly reseated.

Fluid Level Check – 4.7L/5.7L Engine

Check the fluid level while the transmission is at normal operating temperature 180°F (82°C). This occurs after at least 15 miles (24 km) of driving. At normal operating temperature the fluid cannot be held comfortably between the fingertips.

To check the automatic transmission fluid level properly, the following procedure must be used:

1. Operate the engine at idle speed and normal operating temperature.
2. The vehicle must be on level ground.
3. Fully apply the parking brake and press the brake pedal.

4. Place the gear selector momentarily in each gear position ending with the lever in P (Park).
5. Remove the dipstick, wipe it clean and reinsert it until seated.
6. Remove the dipstick again and note the fluid level on both sides. The fluid level should be between the “HOT” (upper) reference holes on the dipstick at normal operating temperature. Verify that solid coating of oil is seen on both sides of the dipstick. If the fluid is low, add as required into the dipstick tube. **Do not overfill.** After adding any quantity of oil through the oil fill tube, wait a minimum of two (2) minutes for the oil to fully drain into the transmission before rechecking the fluid level.

NOTE: If it is necessary to check the transmission **below** the operating temperature, the fluid level should be between the two “COLD” (lower) holes on the dipstick with the fluid at approximately 70°F (21°C) (room temperature). If the fluid level is correctly established at

room temperature, it should be between the “HOT” (upper) reference holes when the transmission reaches 180°F (82°C). Remember it is best to check the level at the normal operating temperature.

CAUTION!

Be aware that if the fluid temperature is below 50°F (10°C) it may not register on the dipstick. Do not add fluid until the temperature is elevated enough to produce an accurate reading.

7. Check for leaks. Release parking brake.

To prevent dirt and water from entering the transmission after checking or replenishing fluid, make certain that the dipstick cap is properly reseated. It is normal for the

dipstick cap to spring back slightly from its fully seated position, as long as its seal remains engaged in the dipstick tube.

Automatic Transmission Fluid And Filter Change

To obtain best performance and long life for automatic transmissions, the manufacturer recommends that they be given regular maintenance service by an Authorized Dodge Dealer or Service Center. It is important that the transmission be adjusted periodically, the fluid maintained at the correct level, and that it be drained and refilled as specified.

Follow the proper Maintenance Schedule for your type of driving.

It is important that proper lubricant is used in the transmission. Refer to Recommended Fluids, Lubricants and Genuine Parts for correct fluid type. It is important that the transmission fluid be maintained at the prescribed level using the recommended fluid.

CAUTION!

Using a transmission fluid other than the manufacturers recommended fluid may cause deterioration in transmission shift quality and/or torque converter shudder. Using a transmission fluid other than the manufacturers recommended fluid will result in more frequent fluid and filter changes. Refer to Recommended Fluids, Lubricants and Genuine Parts for correct fluid type.

Special Additives

The manufacturer strongly recommends against the addition of any additives to the transmission. Exception to this policy is the use of special dyes to aid in detecting fluid leaks. The use of transmission sealers should be avoided, since they may adversely affect seals.

Transfer Case

Inspect the transfer case for fluid leaks. If a fluid leak is evident the transfer case fluid level may be low. Have the transfer case serviced immediately.

CAUTION!

Damage may result from operation of the vehicle with low transfer case fluid.

The transfer case fluid should be drained and refilled at the intervals specified.

Lubricant Selection

Refer to Recommended Fluids, Lubricants and Genuine Parts for correct fluid type.

Axles

Refer to Recommended Fluids, Lubricants and Genuine Parts for correct fluid type.

The manufacturer does not recommend regularly scheduled oil changes for axles in vehicles whose operation is classified as normal truck service.

NOTE: The presence of water in the gear lubricant will result in corrosion and possible failure of differential components. Operation of the vehicle in water, as may be encountered in some off-highway types of service, will require draining and refilling the axle to avoid damage.

Rear Axle

Rear Axle fluid levels should be 7/8" (22 mm) below the fill plug hole for 8 1/4" axles, and 1 5/8" (41 mm) below the fill plug hole for 9 1/4" axles.

Front Axle

Front Axle fluid level should be at the bottom of the filler hole plug.

Selection of Lubricating Grease

The National Lubricating Grease Institute (NLGI) has developed a symbol (Certification Mark) to aid the vehicle owner in the proper selection of grease for chassis components. This symbol, an example shown below, is located on the grease container and identifies the application and quality of the grease.



There are two groups identified, those for wheel bearings (Letter "G") and those for chassis (Letter "L") lubrication. Performance categories within these groups result in dual letter designations for each group. The letter designations shown in the example are the highest

quality level available and when combined as shown can be used for chassis lubrication. Use only those greases that have the NLGI symbol on the container along with the proper quality level for your application.

Appearance Care and Protection from Corrosion

Protection of Body and Paint from Corrosion

Vehicle body care requirements vary according to geographic locations and usage. Chemicals that make roads passable in snow and ice, and those that are sprayed on trees and road surfaces during other seasons, are highly corrosive to the metal in your vehicle. Outside parking, which exposes your vehicle to airborne contaminants, road surfaces on which the vehicle is operated, extreme hot or cold weather and other extreme conditions will have an adverse effect on paint, metal trim, and underbody protection.

The following maintenance recommendations will enable you to obtain maximum benefit from the corrosion resistance built into your vehicle.

What Causes Corrosion?

Corrosion is the result of deterioration or removal of paint and protective coatings from your vehicle.

The most common causes are:

- Road salt, dirt and moisture accumulation.
- Stone and gravel impact.
- Insects, tree sap and tar.
- Salt in the air near seacoast localities.
- Atmospheric fallout/industrial pollutants.

Washing

- Wash your vehicle regularly. Always wash your vehicle in the shade using a mild car wash soap, and rinse the panels completely with clear water.
- If insects, tar or other similar deposits have accumulated on your vehicle, wash it as soon as possible.
- Use Mopar® auto polish to remove road film and stains and to polish your vehicle. Take care never to scratch the paint.

- Avoid using abrasive compounds and power buffing that may diminish the gloss or thin out the paint finish.

CAUTION!

Do not use abrasive or strong cleaning materials such as steel wool or scouring powder, which will scratch metal and painted surfaces.

Special Care

- If you drive on salted or dusty roads or if you drive near the ocean, hose off the undercarriage at least once a month.
- It is important that the drain holes in the lower edges of the doors, rocker panels and liftgate be kept clear and open.
- If you detect any stone chips or scratches in the paint, touch them up immediately. The cost of such repairs is considered the responsibility of the owner.
- If your vehicle is damaged due to an accident or similar cause which destroys the paint and protective coating have your vehicle repaired as soon as possible. The cost of such repairs is considered the responsibility of the owner.
- All wheels and wheel trim, especially aluminum and chrome plated wheels should be cleaned regularly with mild soap and water to prevent corrosion. To remove heavy soil, select a nonabrasive, non-acidic cleaner. Do not use scouring pads, steel wool, a bristle brush or metal polishes. Only Mopar® cleaners are recommended. Do not use oven cleaner. Avoid automatic car washes that use acidic solutions or harsh brushes that may damage the wheels' protective finish.

- If you carry special cargo such as chemicals, fertilizers, de-icer salt, etc., be sure that such materials are well packaged and sealed.
- If a lot of driving is done on gravel roads, consider mud or stone shields behind each wheel.
- Use Mopar® touch up paint on scratches as soon as possible. Your dealer has touch up paint to match the color of your vehicle.

Interior Care

Use Mopar® Fabric Cleaner to clean fabric upholstery and carpeting.

Use Mopar® Vinyl Cleaner to clean vinyl upholstery and trim.

Mopar® Total Clean is specifically recommended for leather upholstery.

Your leather upholstery can be best preserved by regular cleaning with a damp soft cloth. Small particles of dirt can act as an abrasive and damage the leather upholstery and should be removed promptly with a damp cloth. Stubborn soils can be removed easily with a soft cloth and Mopar® Total Clean. Care should be taken to avoid soaking your leather upholstery with any liquid. Please do not use polishes, oils, cleaning fluids, solvents, detergents, or ammonia based cleaners to clean your leather upholstery. Application of a leather conditioner is not required to maintain the original condition.

WARNING!

Do not use volatile solvents for cleaning purposes. Many are potentially flammable, and if used in closed areas they may cause respiratory harm.

Glass Surfaces

All glass surfaces should be cleaned on a regular basis with any commercial household-type glass cleaner. Never use an abrasive type cleaner. Use caution when cleaning inside rear windows equipped with electric defrosters or windshields equipped with a windshield wiper de-icer. Do not use scrapers or other sharp instruments which may scratch the elements.

When cleaning the rear view mirror, spray cleaner on the towel or rag that you are using. Do not spray cleaner directly on the mirror.

Cleaning Plastic Instrument Cluster Lenses

The lenses in front of the instruments in this vehicle are molded in clear plastic. When cleaning the lenses, care must be taken to avoid scratching the plastic.

1. Clean with a wet soft rag. A mild soap solution may be used, but do not use high alcohol content or abrasive cleaners. If soap is used, wipe clean with a clean damp rag.

2. Dry with a soft tissue.

Seat Belt Maintenance

Do not bleach, dye or clean the belts with chemical solvents or abrasive cleaners. This will weaken the fabric. Sun damage will also weaken the fabric.

If the belts need cleaning, use a mild soap solution or lukewarm water. Do not remove the belts from the car to wash them.

Replace the belts if they appear frayed or worn or if the buckles do not work properly.

POWER DISTRIBUTION CENTER (FUSE/RELAY)

Your vehicle is equipped with two electrical power distribution centers located next to each other in the left side of the engine compartment.

These power distribution centers house new plug-in "Maxi" fuses which replace all the in-line fusible links previously used. The power distribution centers also contain "Mini" fuses and plug-in "ISO" relays. A label inside the latching cover of the Power Distribution Centers identifies each component for ease of replacement, if necessary. These fuses and relays can be obtained from your dealer.

FUSE BLOCK

The fuse block contains blade-type mini-fuses, relays, and circuit breakers for high-current circuits. It is located in the left kick panel. It is accessible through a snap-in cover.

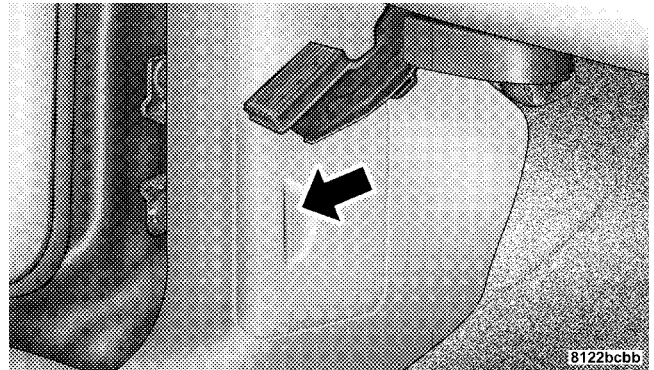

CAUTION!

When replacing a blown fuse, it is important to use only a fuse having the correct amperage rating. The use of a fuse with a rating other than indicated may result in a dangerous electrical system overload. If a properly rated fuse continues to blow, it suggests a problem in the circuit that must be corrected.

NOTE: If you are leaving your vehicle dormant for longer than 21 days you may want to take steps to protect your battery. You may do this by disconnecting the battery or by disconnecting the two ignition-off draw (I.O.D.) fuses located in the Auxiliary Power Distribution Center (PDC) located in the engine compartment. The I.O.D. cavities include a snap-in retainer that allows the fuse to be disconnected, without removing it from the fuse block. Pressing the I.O.D. fuse back into the cavity reconnects it.

VEHICLE STORAGE

If you are storing your vehicle for more than 21 days, we recommend that you take the following steps to minimize the drain on your vehicle's battery:

- Disconnect the Ignition-Off Draw fuse (I.O.D.) fuse located in the Power Distribution Center (PDC). The I.O.D. cavity includes a snap-in retainer that allows the fuse to be disconnected, without removing it from the fuse block.
- The transfer case should be placed in the 4HI mode and kept in this position to minimize the battery drain.
- As an alternative to the above steps you may disconnect the negative cable from the battery.

REPLACEMENT LIGHT BULBS

Dome Light	WL212-2
Liftgate Lamp	567
Overhead Console Lights	PLW214-2A
Reading Light	WL212-2
Visor Vanity Lights	Not Serviceable

LIGHT BULBS — Outside	Bulb No.
Headlight	H13
Front Park and Turn Sidemarker	3457AK
Front Auxilliary Park	194
Back-Up	3057
Center High Mounted Stoplight	921
Fog Lamp	9006LL
Rear Sidemarker	168
License Plate Light	168
Rear Tail, Stop, Turn Signal	3057

BULB REPLACEMENT

Headlights/Parking/Turn Signal

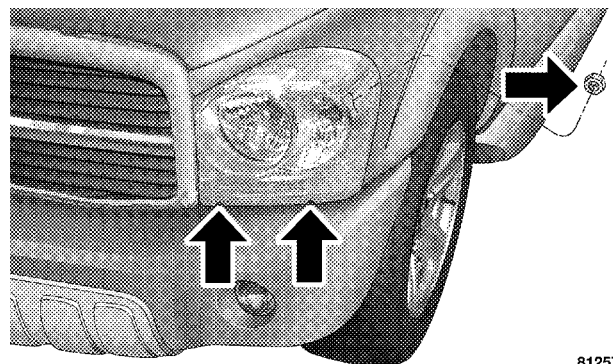

81257538

1. Remove the two bolts attaching the headlight to the inner fender panel.

2. Remove one nut that attaches the headlight to the inner fender panel. Access to the nut is possible by removing the fender panel access door which is located in the wheel liner.
3. Grasp the headlight and pull firmly to disengage the headlight from the fender panel.
4. While firmly holding the headlight in your hands disconnect all connectors by following the procedure described in step number 5 below.

5. Remove the bulb connector from the headlight making sure to pull and release the red tab on all connectors. Loosen the connector by pressing down on the black and/or green release which is located below or above the red tab. The green release is located above the red tab on the 9008, the black release is located above the 3457AK red tab, and the black release is located below the 194 red tab.

6. Remove and replace the bulb.

NOTE: These are Halogen bulbs. Take care not to touch the bulb with your fingers. Body oils from your fingers could cause excessive heat build-up which reduces bulb life.

Rear Side Marker, Tail Lights, Turn Signals And Backup Lights — Replacement

1. Remove the two push-pins from the tail light housing.

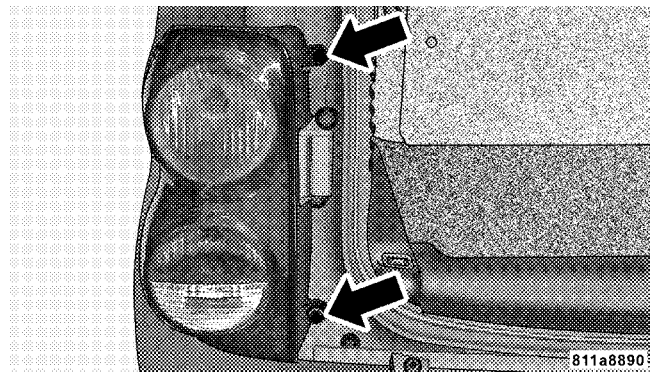
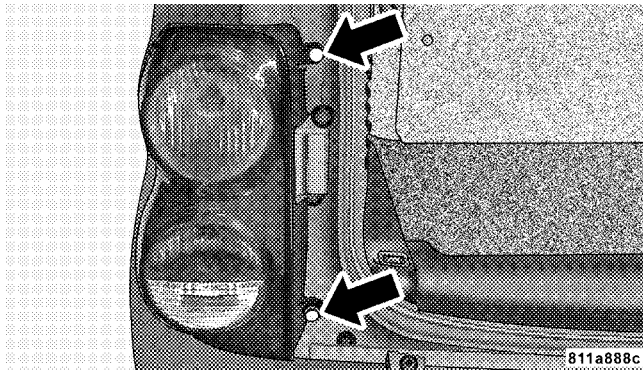

2. Rotate the light to the outboard side of the vehicle and remove.

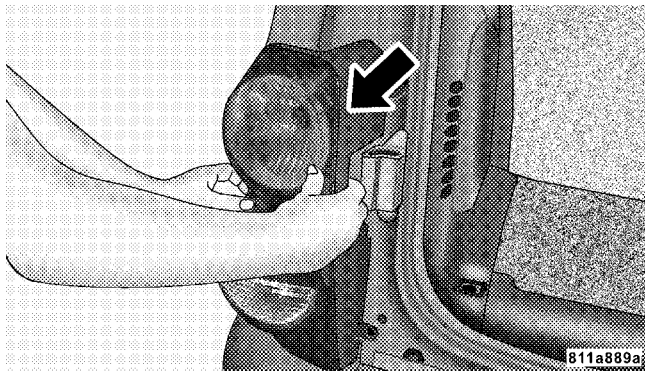

3. Unlock and remove electrical connector.

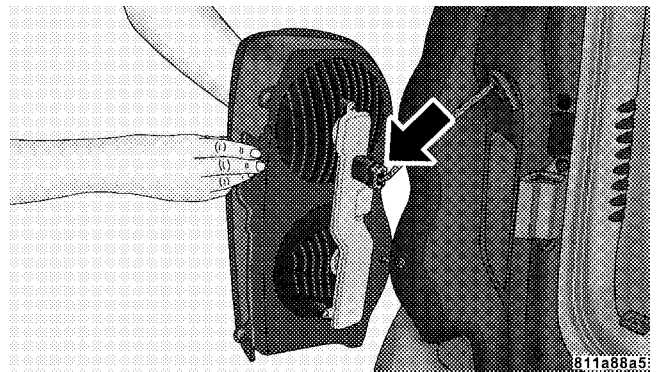

4. Remove the three screws holding the bulb strip to the back of the tail light lens.

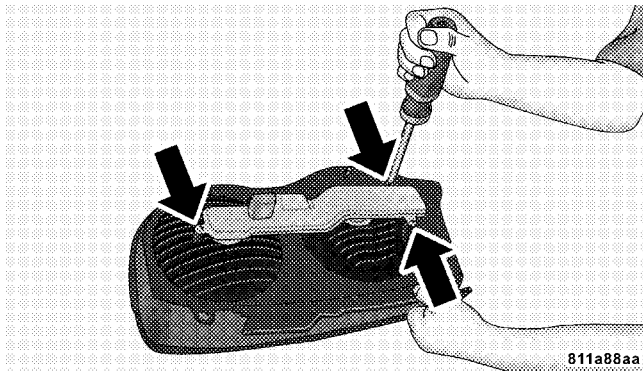

5. Remove the bulb strip from the tail light lens.

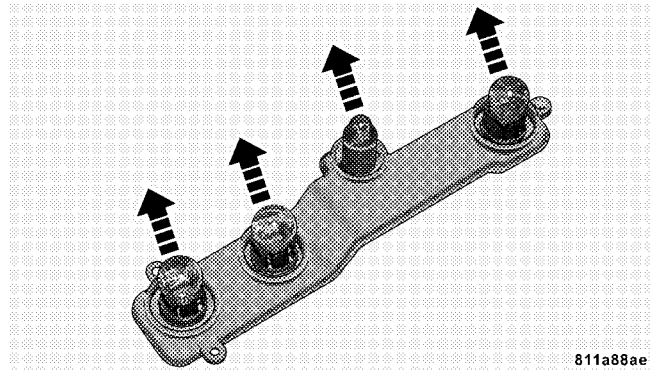

6. Remove bulbs from bulb strip by pulling the bulb straight out.

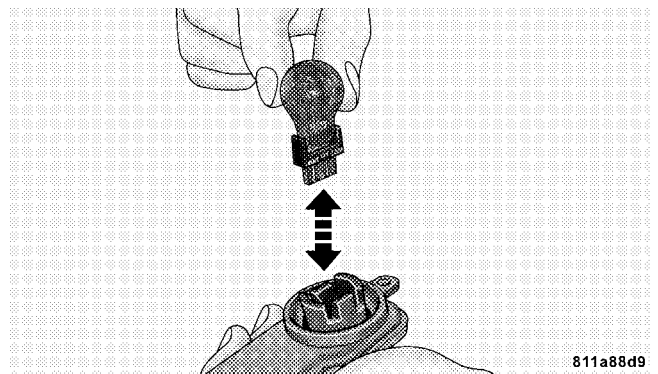
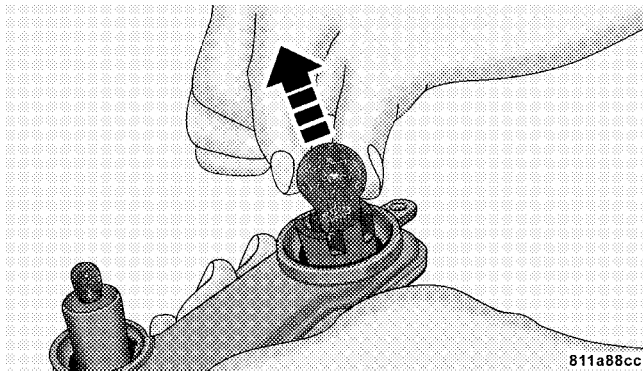

License Lights

1. Remove the two screws securing the lens to the liftgate.

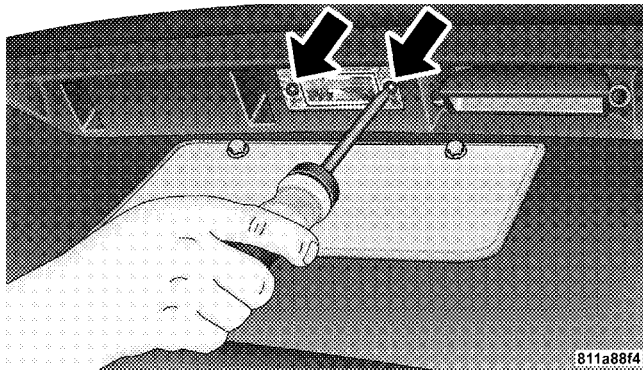

2. Rotate the socket 1/4 turn counterclockwise.

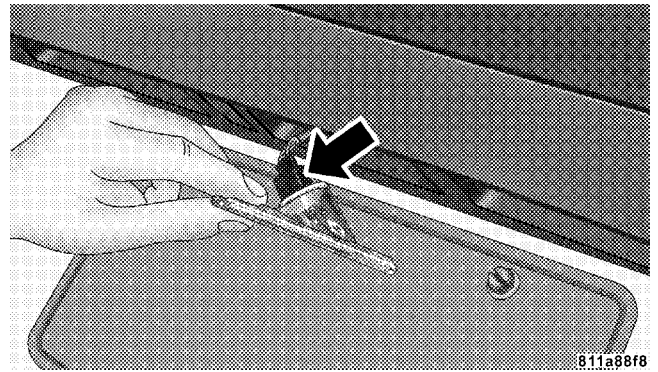

3. Pull bulb from socket.

Center High-Mounted Stoplight

1. Remove two screws securing stoplight housing assembly to the liftgate.

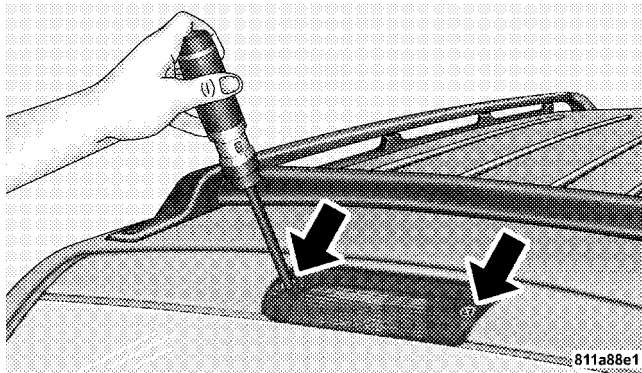

2. Turn socket 1/4 counterclockwise and free from housing.

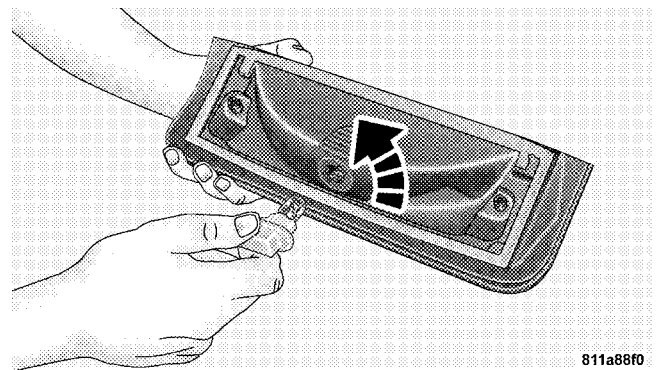

3. Pull bulb straight from socket to remove.

Fog Lights

1. Rotate bulb and connector 1/4 turn counterclockwise.
2. Pull bulb off of connector.

NOTE: For foglights ensure that the takeout push-fasteners are relocated back in their positions; one in the foglight molding and the other in the hydroform.

FLUIDS AND CAPACITIES

	U.S.	Metric
Fuel		
3.7L/4.7L, 87 Octane	27 Gal.	102L
5.7L, 89 Octane	27 Gal	102L
Engine Oil (with filter)		
3.7L, SAE 5W-30, API Certified	5 Qt.	4.7L
4.7L, SAE 5W-30, API Certified	6 Qt.	5.7L
5.7L, SAE 5W-30, API Certified	7 Qt.	6.6L
Cooling System (includes 2.1 Qts./2L for coolant bottle)		
3.7L without Rear Heat (Mopar® Antifreeze/Coolant 5 Year/100,000 Mile Formula)	13.5 Qt.	12.9L

	U.S.	Metric
3.7L with Rear Heat (Mopar® Antifreeze/Coolant 5 Year/100,000 Mile Formula)	14.5 Qt.	13.8L
4.7L without Rear Heat (Mopar® Antifreeze/Coolant 5 Year/100,000 Mile Formula)	13.1 Qt.	12.5L
4.7L with Rear Heat (Mopar® Antifreeze/Coolant 5 Year/100,000 Mile Formula)	14.2 Qt.	13.5L
5.7L without Rear Heat (Mopar® Antifreeze/Coolant 5 Year/100,000 Mile Formula)	NA	NA
5.7L with Rear Heat (Mopar® Antifreeze/Coolant 5 Year/100,000 Mile Formula)	16.6 Qt.	15.8L

NOTE: All fluid capacities are approximate capacities.

RECOMMENDED FLUIDS, LUBRICANTS AND GENUINE PARTS

Engine

Component	Fluids, Lubricants and Genuine Parts
Engine Coolant	Mopar® Antifreeze/Coolant 5 Year/100,000 Mile Formula HOAT (Hybrid Organic Additive Technology) P/N 5011764AB or equivalent.
Engine Oil	Use SAE 5W-30, API Certified, meeting material standard MS-6395.
Engine Oil Filter	Mopar® Engine Oil Filter, P/N 5281090 or equivalent.
Spark Plugs	Refer to the Vehicle Emission Control Information label in the engine compartment.
Fuel Selection 3.7L/4.7L	87 Octane, (R+M)/2 Method
Fuel Selection 5.7L	89 Octane, (R+M)/2 Method

Chassis

Component	Fluids, Lubricants and Genuine Parts.
Automatic Transmission	Mopar® ATF+4, Automatic Transmission Fluid.
Transfer Case	Mopar® ATF+4, Automatic Transmission Fluid.
Front Axle	SAE 75W-90 Multipurpose Type, GL-5 Gear Lubricant.
Rear Axle	SAE 75W-140 Synthetic Gear Lubricant.
Brake Master Cylinder	Mopar® DOT 3 and SAE J1703 should be used. If DOT 3 brake fluid is not available, then DOT 4 is acceptable. Use only recommended brake fluids.
Power Steering Reservoir	Mopar® ATF+4, Automatic Transmission Fluid.

MAINTENANCE SCHEDULES

CONTENTS

■ Emission Control System Maintenance	340	□ Schedule “B”	343
■ Emissions Testing	340	□ Schedule “A”	353
■ Maintenance Schedules	341		

EMISSION CONTROL SYSTEM MAINTENANCE

The “Scheduled” maintenance services, listed in **bold type** on the following pages must be done at the times or mileages specified to assure the continued proper functioning of the emission control system. These, and all other maintenance services included in this manual, should be done to provide best vehicle performance and reliability. More frequent maintenance may be needed for vehicles in severe operating conditions such as dusty areas and very short trip driving.

Inspection and service also should be done any time a malfunction is suspected.

NOTE: Maintenance, replacement, or repair of the emission control devices and systems on your vehicle may be performed by any automotive repair establishment or individual using any automotive part which has been certified pursuant to U.S. EPA or, in the State of California, California Air Resources Board regulations.

EMISSIONS TESTING

In some localities, it may be or will become a legal requirement to ensure that all emissions components and systems are functioning properly as a part of the test procedure. The test center accomplishes this by checking the On Board Diagnostic System (OBD) system with an electronic scan tool. If your vehicle has recently been serviced, the OBD system may have been reset to a “not ready” condition because the OBD system has not had sufficient time since the servicing to reconfirm that emissions components are operating properly. In most cases, a reasonable mix and amount of normal city and highway driving and at least one overnight-off period will be required to prepare your vehicle for this check; however your dealer has the equipment and procedures required to make certain that the OBD system of your vehicle is ready for the required testing.

MAINTENANCE SCHEDULES

There are two maintenance schedules that show the **required** service for your vehicle.

First is Schedule “**B**”. It is for vehicles that are operated under the conditions that are listed below and at the beginning of the schedule.

- Day or night temperatures are below 32° F (0° C).
- Stop and go driving.
- Extensive engine idling.
- Driving in dusty conditions.
- Short trips of less than 10 miles (16 km).
- More than 50% of your driving is at sustained high speeds during hot weather, above 90° F (32° C).
- Trailer towing.
- Taxi, police, or delivery service (commercial service).
- Off-road or desert operation.

- **If equipped for and operating with E-85 (ethanol) fuel.**

NOTE: If **ANY** of these apply to you then change your engine oil every 3,000 miles (5 000 km) or 3 months, whichever comes first and follow schedule “**B**” of the “Maintenance Schedules” section of this manual.

NOTE: Most vehicles are operated under the conditions listed for Schedule “**B**”.

Second is Schedule “**A**”. It is for vehicles that are not operated under any of the conditions listed under Schedule “**B**”.

Use the schedule that best describes your driving conditions. Where time and mileage are listed, follow the interval that occurs first.

NOTE: Under no circumstances should oil change intervals exceed 6000 miles (10 000 km) or 6 months whichever comes first.

CAUTION!

Failure to perform the required maintenance items may result in damage to the vehicle.

At Each Stop for Fuel

- Check the engine oil level about 5 minutes after a fully warmed engine is shut off. Checking the oil level while the vehicle is on level ground will improve the accuracy of the oil level reading. Add oil only when the level is at or below the ADD or MIN mark.
- Check the windshield washer solvent and add if required.

Once a Month

- Check tire pressure and look for unusual wear or damage.

- Inspect the battery and clean and tighten the terminals as required.
- Check the fluid levels of coolant reservoir, brake master cylinder, and transmission and add as needed.
- Check all lights and all other electrical items for correct operation.

At Each Oil Change

- Change the engine oil filter.
- Inspect the exhaust system.
- Inspect the brake hoses.
- Inspect the CV joints (if equipped) and front suspension components.
- Check the automatic transmission fluid level.
- Check the coolant level, hoses, and clamps.

Schedule "B"

Follow schedule "B" if you usually operate your vehicle under one or more of the following conditions.

- Day or night temperatures are below 32° F (0° C).
- Stop and go driving.
- Extensive engine idling.
- Driving in dusty conditions.
- Short trips of less than 10 miles (16 km).
- More than 50% of your driving is at sustained high speeds during hot weather, above 90° F (32° C).
- Trailer towing.
- Taxi, police, or delivery service (commercial service).
- Off-road or desert operation.
- **If equipped for and operating with E-85 (ethanol) fuel.**

NOTE: If ANY of these apply to you then change your engine oil every 3,000 miles (5 000 km) or 3 months, whichever comes first and follow schedule "B" of the "Maintenance Schedules" section of this manual.

344 SCHEDULE "B"

Miles (Kilometers)	3,000 (5 000)	6,000 (10 000)	9,000 (14 000)	12,000 (19 000)	15,000 (24 000)
Change engine oil and engine oil filter.	X	X	X	X	X
Rotate tires.		X		X	
Change rear axle fluid.					X
Change front axle fluid (4X4).					X
Inspect engine air cleaner filter, replace if necessary.					X

Miles (Kilometers)	18,000 (29 000)	21,000 (34 000)	24,000 (38 000)	27,000 (43 000)	30,000 (48 000)
Change engine oil and engine oil filter.	X	X	X	X	X
Rotate tires.	X		X		X
Change rear axle fluid.					X
Change front axle fluid (4X4).					X
Check transfer case fluid level (4X4).					X
Inspect brake linings.	X				
Inspect engine air cleaner filter, replace if necessary.					X
Replace spark plugs.					X
Inspect PCV valve, replace as necessary.*					X
Drain and refill automatic transmission fluid and change main sump filter (4.7L/5.7L only).					X

346 SCHEDULE "B"

Miles (Kilometers)	33,000 (53 000)	36,000 (58 000)	39, 000 (62 000)	42,000 (67 000)	45,000 (72 000)
Change engine oil and engine oil filter.	X	X	X	X	X
Rotate tires.		X		X	
Change rear axle fluid.					X
Change front axle fluid (4X4).					X
Inspect brake linings.		X			
Inspect engine air cleaner filter, replace if necessary.					X

Miles (Kilometers)	48,000 (77 000)	51,000 (82 000)	54,000 (86 000)	57,000 (91 000)	60,000 (96 000)
Change engine oil and engine oil filter.	X	X	X	X	X
Rotate tires.	X		X		X
Change rear axle fluid.					X
Change front axle fluid (4X4).					X
Inspect brake linings.			X		
Inspect engine air cleaner filter, replace if necessary.					X
Replace spark plugs.					X
Inspect PCV valve, replace as necessary.*					X
Inspect and replace ignition cables if necessary (5.7L only).					X
Inspect auto tension drive belt and replace if required.					X
Drain and refill automatic transmission fluid, change filter (3.7L). This applies only if your vehicle is used for police, taxi, fleet, or trailer towing.					X
Drain and refill automatic transmission fluid and change main sump filter (4.7L/5.7L only).					X
Inspect transfer case fluid (4X4).					X

348 SCHEDULE "B"

Miles (Kilometers)	63,000 (101 000)	66,000 (106 000)	69,000 (110 000)	72,000 (115 000)	75,000 (120 000)
Change engine oil and engine oil filter.	X	X	X	X	
Rotate tires.		X		X	
Change rear axle fluid.					X
Change front axle fluid (4X4).					X
Inspect brake linings.				X	
Inspect engine air cleaner filter, replace if necessary.					X
Inspect auto tension drive belt and replace if required.					X

Miles (Kilometers)	78,000 (125 000)	81,000 (130 000)	84,000 (134 000)	87,000 (139 000)	90,000 (144 000)
Change engine oil and engine oil filter.	X	X	X	X	X
Rotate tires.	X		X		X
Change rear axle fluid.					X
Change front axle fluid (4X4).					X
Check transfer case fluid level (4X4).					X
Inspect brake linings.					X
Inspect engine air cleaner filter, replace if necessary.					X
Replace spark plugs.					X
Inspect PCV valve, replace as necessary.*					X
Inspect auto tension drive belt and replace if required.					X
Drain and refill automatic transmission fluid and change main sump and cooler return filter (if equipped) (4.7L/5.7L only).					X

350 SCHEDULE "B"

Miles (Kilometers)	93,000 (149 000)	96,000 (154 000)	99,000 (158 000)	100,000 (160 000)	102,000 (163 000)
Change engine oil and engine oil filter.	X	X	X		X
Rotate tires.		X			X
Flush and replace engine coolant.					X
Change rear axle fluid.		X			
Change front axle fluid (4X4).		X			

Miles (Kilometers)	105,000 (168 000)	108,000 (173 000)	111,000 (178 000)	114,000 (182 000)	117,000 (187 000)	120,000 (192 000)
Change engine oil and engine oil filter.	X	X	X	X	X	X
Rotate tires.		X		X		X
Change rear axle fluid.	X					X
Change front axle fluid (4X4).	X					X
Inspect brake linings.		X				
Inspect engine air cleaner filter, replace if necessary.	X					X
Replace spark plugs.						X
Inspect and replace ignition cables if necessary (5.7L only).						X
Inspect PCV valve, replace as necessary.*						X
Inspect auto tension drive belt and replace if required.‡	X					X
Drain and refill transfer case fluid (4X4).						X

352 SCHEDULE "B"

Miles (Kilometers)	105,000 (168 000)	108,000 (173 000)	111,000 (178 000)	114,000 (182 000)	117,000 (187 000)	120,000 (192 000)
Drain and refill automatic transmission fluid, change filter (3.7L). This applies only if your vehicle is used for police, taxi, fleet, or trailer towing.						X
Drain and refill automatic transmission fluid and change main sump filter (4.7L/5.7L only).						X

* This maintenance is recommended by the manufacture to the owner but is not required to maintain the emissions warranty.

‡ This maintenance is not required if previously replaced.

Inspection and service should also be performed anytime a malfunction is observed or suspected. Retain all receipts.

Schedule "A"

Miles (Kilometers) [Months]	6,000 (10 000) [6]	12,000 (19 000) [12]	18,000 (29 000) [18]	24,000 (38 000) [24]	30,000 (48 000) [30]
Change engine oil and engine oil filter.	X	X	X	X	X
Rotate tires.	X	X	X	X	X
Check transfer case fluid level (4X4).					X
Inspect brake linings.			X		
Replace engine air cleaner filter.					X
Replace spark plugs.					X

354 SCHEDULE "A"

Miles (Kilometers) [Months]	36,000 (58 000) [36]	42,000 (67 000) [42]	48,000 (77 000) [48]	54,000 (84 000) [54]	60,000 (96 000) [60]	66,000 (106 000) [66]
Change engine oil and engine oil filter.	X	X	X	X	X	X
Rotate tires.	X	X	X	X	X	X
Check transfer case fluid level (4X4).					X	
Flush and replace engine coolant at 60 months, regardless of mileage.					X	
Inspect brake linings.	X			X		
Replace engine air cleaner filter.					X	
Replace spark plugs.					X	
Inspect PCV valve, replace as necessary. *					X	
Inspect and replace ignition cables if necessary (5.7L only).					X	
Inspect auto tension drive belt and replace if required.					X	

Miles (Kilometers) [Months]	72,000 (115 000) [72]	78,000 (125 000) [78]	84,000 (134 000) [84]	90,000 (144 000) [90]	96,000 (154 000) [96]	100,000 (160 000)
Change engine oil and engine oil filter.	X	X	X	X	X	
Rotate tires.	X	X	X	X	X	X
Check transfer case fluid level (4X4).				X		
Inspect brake linings.	X			X		
Replace engine air cleaner filter.				X		
Replace spark plugs.				X		
Inspect PCV valve, replace as necessary.*				X		
Inspect auto tension drive belt and replace if required.‡				X		
Drain and refill automatic transmission fluid and change sump and cooler return filter (if equipped) (4.7L/5.7L only).						X

356 SCHEDULE "A"

Miles (Kilometers) [Months]	102,000 (163 000) [102]	108,000 (173 000) [108]	114,000 (182 000) [114]	120,000 (192 000) [120]
Change engine oil and engine oil filter.	X	X	X	X
Rotate tires.	X	X	X	X
Drain and refill transfer case fluid (4X4).				X
Flush and replace engine coolant, if not done at 60 mos.	X			
Flush and replace engine coolant, if not done at 102,000 miles (163 000 km)				X
Inspect brake linings.		X		
Replace engine air cleaner filter.				X
Replace spark plugs.				X
Inspect PCV valve, replace as necessary.*				X

* This maintenance is recommended by the manufacturer to the owner but is not required to maintain the emissions warranty.

‡ This maintenance is not required if previously performed.

Inspection and service should also be performed anytime a malfunction is observed or suspected. Retain all receipts.

WARNING!

You can be badly injured working on or around a motor vehicle. Do only that service work for which you have the knowledge and the right equipment. If you have any doubt about your ability to perform a service job, take your vehicle to a competent mechanic.

IF YOU NEED CONSUMER ASSISTANCE

CONTENTS

■ Suggestions For Obtaining Service For Your Vehicle	360	■ Warranty Information	363
□ Prepare For The Appointment	360	■ Mopar® Parts	365
□ Prepare A List	360	■ Reporting Safety Defects	365
□ Be Reasonable With Requests	360	□ In Canada	365
■ If You Need Assistance	360	■ Publication Order Forms	366

SUGGESTIONS FOR OBTAINING SERVICE FOR YOUR VEHICLE**Prepare For The Appointment**

If you're having warranty work done, be sure to have the right papers with you. Take your warranty folder. All work to be performed may not be covered by the warranty, discuss additional charges with the service manager. Keep a maintenance log of your vehicle's service history. This can often provide a clue to the current problem.

Prepare A List

Make a written list of your vehicle's problems or the specific work you want done. If you've had an accident, or work done that is not on your maintenance log, let the service advisor know.

Be Reasonable With Requests

If you list a number of items, and you must have your vehicle by the end of the day, discuss the situation with the service advisor and list the items in order of priority. At many dealers you may obtain a rental vehicle at a minimal daily charge. If you need a rental, it is advisable to make these arrangements when you call for an appointment.

IF YOU NEED ASSISTANCE

The manufacturer and its dealers are vitally interested in your satisfaction. We want you to be happy with our products and services.

Your selling dealer is best equipped and most anxious to provide prompt resolution for any warranty issue or related matter that you may experience. The manufacturer's dealers have the facilities, factory-trained technicians, special tools, and the latest information to assure your vehicle is fixed correctly and in a timely manner.

The manufacturer has empowered its dealers to make warranty and repair decisions that ensure you are not inconvenienced. There is no need for you to wait for a decision from the manufacturer. If a special circumstance occurs that requires information from the manufacturer, we have asked the dealer's service management to make the contact on your behalf.

This is why you should always talk to your dealer's service manager first. Most matters can be resolved with this process.

- If for some reason you are still not satisfied, talk to the general manager or owner of the dealership. They want to know if you need assistance.
- If your dealership is unable to resolve the concern, you may contact the Manufacturer's Customer Center.

Any communication to the Manufacturer's Customer Center should include the following information:

- Owner's name and address
- Owner's telephone number (home and office)
- Dealership name
- Vehicle identification number
- Vehicle delivery date and mileage

DaimlerChrysler Motors Corporation Customer Center

P.O. Box 21-8004

Auburn Hills, MI 48321-8004

Phone: (800) 992-1997

DaimlerChrysler Canada Inc. Customer Center

P.O. Box 1621

Windsor, Ontario N9A 4H6

Phone —(800) 465-2001

In Mexico contact:

Av. Prolongacion Paseo de la Reforma, 1240
Sante Fe C.P. 05109
Mexico, D. F.
In Mexico (915) 729-1248 or 729-1240
Outside Mexico (525) 729-1248 or 729-1240

Customer Assistance For The Hearing Or Speech Impaired (TDD/TTY)

To assist customers who have hearing difficulties, the manufacturer has installed special TDD (Telecommunication Devices for the Deaf) equipment at its Customer Center. Any hearing or speech impaired customer who has access to a TDD or a conventional teletypewriter (TTY) in the United States can communicate with the manufacturer by dialing 1-800-380-CHRY.

Service Contract

You may have purchased a service contract for your vehicle to help protect you from the high cost of unexpected repairs after your manufacturer's new vehicle limited warranty expires. The manufacturer stands behind only the manufacturer's Service Contracts. If you purchased a manufacturer's Service Contract, you will receive Plan Provisions and an Owner Identification Card in the mail within three weeks of your vehicle delivery date. If you have any questions about your service contract, call the manufacturer's Service Contract National Customer Hotline at 1-800-521-9922.

The manufacturer will not stand behind any service contract that is not the manufacturer's Service Contract. It is not responsible for any service contract other than the manufacturer's Service Contract. If you purchased a service contract that is not a manufacturer's Service

Contract, and you require service after your manufacturer's new vehicle limited warranty expires, please refer to your contract documents, and contact the person listed in those documents.

We appreciate that you have made a major investment when you purchased your new vehicle. Your dealer has also made a major investment in facilities, tools, and training to assure that you are absolutely delighted with your ownership experience. You'll be pleased with their

sincere efforts to resolve any warranty issues or related concerns.

WARRANTY INFORMATION

See your manufacturer's Warranty Information Booklet for information on warranty coverage and transfer of warranty.

DESCRIPTION	1 Yr/ 12,000	2 Yr/ 24,000	3 Yr/ 36,000	3 Yr/ 50,000	3 Yr/ Unlmtd	5 Yr/ 100,000	7 Yr/ 70,000	8 Yr/ 80,000
Basic Limited Warranty Coverage								
Special Extended Warranty Coverage								
Powertrain Limited Warranty: (\$100 deductible)				1st Owner & 2nd Owner with Paid Powertrain Transfer				
				2nd Owner if Powertrain Not Transferred and 3rd (and After) Owners				
Anti-Corrosion Perforation Limited Warranty: All Panels								
Outer Panels								
Federal Emission Warranty:								
Federal Emission Warranty - Specified Components								
California Emission Warranty:								
California Emission Warranty - Specified Components								

NOTE: Vehicles used as a police vehicle, taxi, limousine, postal delivery vehicle, ambulance or rental vehicle are covered only under the 3 year/36,000 mile Basic Limited Warranty.

MOPAR® PARTS

Mopar® fluids, lubricants, parts, and accessories are available from your dealer. They will help you keep your vehicle operating at its best.

REPORTING SAFETY DEFECTS

In the 50 United States and Washington D.C.: If you believe that your vehicle has a defect which could cause a crash or cause injury or death, you should immediately inform the National Highway Traffic Safety Administration (NHTSA) in addition to notifying the manufacturer.

If NHTSA receives similar complaints, it may open an investigation, and if it finds that a safety defect exists in a group of vehicles, it may order a recall and remedy campaign. However, NHTSA cannot become involved in individual problems between you, your dealer, and the manufacturer.

To contact NHTSA, you may either call the Auto Safety Hotline toll free at 1-800-424-9393 (or 366-0123 in Washington DC area) or write to: NHTSA, U.S. Dept. of Transportation, Washington DC 20590. You can also obtain other information about motor vehicle safety from the Hotline.

In Canada:

If you believe that your vehicle has a safety defect, you should contact the Customer Service Department immediately. Canadian customers who wish to report a safety defect to the Canadian government should write to Transport Canada, Motor Vehicle Defect Investigations and Recalls, 2780 Sheffield Road, Ottawa, Ontario K1B 3V9.

PUBLICATION ORDER FORMS

To order the following manuals, you may use either the website or the phone numbers listed below. Visa, Mastercard, American Express, and Discover orders are accepted. If you prefer mailing your payment, please call for an order form.

NOTE: A street address is required when ordering manuals. (No P.O. Boxes).

- *Service Manuals.*

These comprehensive service manuals provide the information that students and professional technicians need in diagnosing/troubleshooting, problem solving, maintaining, servicing and repairing DaimlerChrysler Corporation vehicles. A complete working knowledge of the vehicle, system and/or components is written in straightforward language with illustrations, diagrams and charts.

- *Diagnostic Procedure Manuals.*

Filled with diagrams, charts and detailed illustrations, these practical manuals make it easy for students and technicians to find and fix problems on computer-controlled vehicle systems and features. They show exactly how to find and correct problems the first time, using step-by-step troubleshooting and driveability procedures, proven diagnostic tests and a complete list of all tools and equipment.

- *Owner's Manuals.*

These manuals have been prepared with the assistance of service and engineering specialists to acquaint you with specific Chrysler group vehicles. Included are starting, operating, emergency and maintenance procedures as well as specifications, capabilities and safety tips.

Call Toll Free at **1-800-890-4038 (U.S.)** or **1-800-387-1143 (Canada)**

Or

Visit us on the World Wide Web at:

www.techauthority.daimlerchrysler.com or
www.daimlerchrysler.ca/manuals

INDEX

Adding Engine Coolant (Antifreeze)	309	Anti-Lock Warning Light	149
Adding Fuel	245,270	Anti-Theft System	24,149
Air Cleaner, Engine	298	Appearance Care	321
Air Conditioner Maintenance	302	Arming Theft System	25
Air Conditioning	184	Auto Unlock	16
Air Conditioning Controls	184	Automatic Dimming Mirror	70,74
Air Conditioning Refrigerant	302,303	Automatic Door Locks	15
Air Conditioning System	179,302	Automatic Headlights	106
Air Filter	298	Automatic Temperature Control	184
Air Pressure, Tires	231,239	Automatic Transaxle	203
Airbag	38,153	Automatic Transmission	200,203,315
Airbag Light	50	Adding Fluid	316,317
Alarm	24,149	Fluid and Filter Changes	318
Alarm, Panic	21	Fluid Level Check	315,316
Alignment and Balance	238	Fluid Type	318,338
Alterations/Modifications, Vehicle	6	Gear Ranges	203
Antenna, Satellite Radio	176	Special Additives	318
Antifreeze (Engine Coolant)	308,335	Torque Converter	207
Anti-Lock Brake System	218	Axle Fluid	338

Axle Lubrication	319	Master Cylinder	313
Ball Joints	304	Parking	217
Battery	300	Warning Light	149,151
Charging	280	Brakes	218
Emergency Starting	280	Brake/Transmission Interlock	203
Gas Caution	280	Break-In Recommendations, New Vehicle	62
Keyless Transmitter Replacement	24	Bulb Replacement	327
Saving Feature	105	Bulbs, Light	327
Belts, Drive	297	Calibration, Compass	124
Belts, Seat	29	Capacities, Fluid	335
Body Mechanism Lubrication	304	Caps, Filler	
B-Pillar Location	226	Power Steering	303
Brake Fluid	338	Car Washes	321
Brake System	218,313	Carbon Monoxide Warning	248
Anti-Lock	218	Cargo	250
Disc Brakes	313	Catalytic Converter	249,299
Fluid Check	313	CD Player	155,161
Hoses	314	Cellular Phone	74,179

Center High Mounted Stop Light	334	Console, Overhead	119
Certification Label	250	Contract, Service	362
Changing A Flat Tire	272	Converter, Catalytic	249
Charging	280	Coolant	310
Chart, Tire Sizing	223	Coolant Pressure Cap	310
Child Restraint	50,51,61	Cooling System	306
Child Restraint Tether Anchors	54,60	Adding Coolant (Antifreeze)	309
Child Restraint with Automatic Belts	35	Coolant Capacity	335
Child Seat	55	Coolant Level	310
Circuit Breakers	325	Disposal of Used Coolant	308
Climate Control	179	Drain, Flush, and Refill	308
Clock	154	Inspection	306
Compact Disc Maintenance	178	Points to Remember	311
Compact Spare Tire	234	Radiator Cap	310
Compass	124	Selection of Coolant	308,335,337
Compass Calibration	124	Temperature Gauge	146
Compass Variance	125	Cruise Control	116
Computer, Trip/Travel	120	Cup Holder	138
Console, Floor	137	Customer Assistance	360

Daytime Running Lights	107	Drive Shaft Universal Joints	304
Dealer Service	291	Electric Remote Mirrors	72
Defroster, Rear Window	195	Electrical Power Outlets	135
Defroster, Windshield	63,182,187	Electronic Speed Control	116
Delay Wipers	110	Emergency, In Case of	
Diagnostic System, Onboard	289	Freeing Vehicle When Stuck	221
Dimmer Switch, Headlight	147	Jacking	275
Dipsticks		Overheating	310
Automatic Transmission	316	Towing	282
Oil (Engine)	292	Emission Control System Maintenance	340
Power Steering	303	Emission Related Components	311
Disarming, Theft System	25	Engine	
Disc Brakes	313	Air Cleaner	298
Disposal		Block Heater	202
Used Coolant	308	Break-In Recommendations	62
Door Ajar Light	151	Compartment	287,288
Door Locks	13	Coolant	308,337
Door Opener, Garage	126	Cooling	306
Drive Belts	297		

Exhaust Gas Caution	62,248	Filters	
Fails to Start	201	Air Cleaner	298
Flooded, Starting	201	Engine Fuel	299
Fuel Requirements	335	Engine Oil	297,337
Jump Starting	280	Engine Oil Disposal	296
Oil	292,335,337	Flashers	
Oil Selection	335	Hazard Warning	270
Oil Synthetic	296	Turn Signal	108,146,329
Overheating	310	Flat Tire Stowage	273,279
Starting	200	Flooded Engine Starting	201
Temperature Gauge	146	Floor Console	137
Engine Oil Viscosity Chart	295	Fluid, Brake	338
Entry System, Illuminated	13	Fluid Capacities	335
Equipment Identification Plate	267	Fluid Level Checks	
Ethylene Glycol Antifreeze	308	Automatic Transmission	316
Exhaust Gas Caution	62,248,306	Brake	313
Exhaust System	62,306	Cooling System	306
Extender, Seat Belt	37	Engine Oil	292
Exterior Lighting	106	Power Steering	303

Transfer Case	319	Gas Cap	246
Fog Lights	107,335	Gas Gauge	146
Folding Rear Seat	91,93	Gasoline	242
Four Wheel Drive	208	Gasoline, Reformulated	243
Operation	208	Gauges	
Four-Way Hazard Flasher	270	Coolant Temperature	146
Freeing A Stuck Vehicle	221	Fuel	146
Front Axle	320	Odometer	153
Fuel	242	Speedometer	148
Adding	245	Tachometer	149
Filter	299	Gear Ranges	203
Gauge	146	Glass Cleaning	324
Octane Rating	242,337	Grease	320
Requirements	242,335	Gross Axle Weight Rating	251
Tank Capacity	335	Gross Cargo Weight	250
Fueling	245	GVWR	251,253
Fuses	325	Hands-Free Phone	74
Garage Door Opener	126	Hazard Warning Flasher	270

Headlights	327	Ignition	12
Delay	106	Key	9
High Beam	109	Lock	12
High Beam/Low Beam Select Switch	109	Illuminated Entry	13
Lights On Reminder	107	Infant Restraint	50,51
Passing	109	Inflation Pressure Tires	239
Replacing	327	Inside Rearview Mirror	70
Heated Mirrors	73	Instrument Cluster	146
Heated Seats	90	Instrument Panel and Controls	144
Heater	179,184	Instrument Panel Lens Cleaning	324
Heater, Engine Block	202	Interior Appearance Care	323
High Beam Indicator	147	Interior Lighting	104
High Beam/Low Beam Select Switch	109	Interior Lights	104
Hitches		Intermittent Wipers	110
Trailer Towing	257	Introduction	4
Homelink Transmitter	126		
Hood Release	102	Jack Operation	272,275
Hoses	311	Jacking Instructions	276

Key, Replacement	10	Courtesy/Reading	120
Key, Sentry	9	Cruise	153
Key-In Reminder	9	Daytime Running	107
Keyless Entry System	19	Door Ajar	151
Keys	9	Fog	107,147,335
Knee Bolster	38	Hazard Warning Flasher	270
Lane Change and Turn Signals	108,146,329	Headlights	106
Lap/Shoulder Belts	29,34	High Beam	109
LATCH (Lower Anchors and Tether for Children)	54	High Beam/Low Beam Select	109
Liftgate	26	Instrument Cluster	106,146
Lights	64,103	Interior	104,120
Airbag	50,153	License	333
Anti-Lock Warning	149	Lights On Reminder	107
Automatic Headlights	106	Low Fuel	146,147
Back-Up	329	Malfunction Indicator	152
Brake Warning	151	Park	106
Bulb Replacement	327	Passing	109
Center Mounted Stop	334	Seat Belt Reminder	147
		Service	327

Turn Signal	108,329	Lumbar Support	88
Warning (Instrument Cluster Description)	146	Maintenance Free Battery	300
Washer Fluid	153	Maintenance Procedures	292
Loading Vehicle	250	Maintenance Schedule	341
Tires	226	Schedule "A"	353
Locks	13	Schedule "B"	343
Auto Unlock	16	Malfunction Indicator Light	152,290
Automatic Door	15	Manual, Service	366
Child Protection	17	Manual Transmission	
Door	13	Lubricant Selection	338
Ignition	12	Map/Reading Lights	120
Keys	9	Memory Seat	97
Power Door	14	Mirrors	70
Steering Wheel	12	Automatic Dimming	70,74
Lower Anchors and Tether for CHildren (LATCH)	54	Electric Powered	72
Lubricating Oil	320	Heated	73
Lubrication, Body	304	Memory	97
Lug Nuts	278	Outside	71
Luggage Carrier	139		

Rearview	70	Materials Added to	296
Vanity	73	Recommendation	295,335
Modifications/Alterations, Vehicle	6	Synthetic	296
Mopar Parts	291,365	Viscosity	295,335
Multi-Function Control Lever	108	Onboard Diagnostic System	289,290
New Vehicle Break-In Period	62	Opener, Garage Door	126
Occupant Classification System	42	Outside Rearview Mirrors	71
Occupant Restraints	28	Overdrive	149,205
Octane Rating, Gasoline	242	Overdrive OFF Switch	205
Oil, Engine	292,337	Overhead Console	119,120
Capacity	335	Overhead Travel Information Center	120
Change Interval	294	Overheating, Engine	148,310
Dipstick	292	Owner's Manual	366
Disposal	296	Panic Alarm	21
Filter	297,337	Parking Brake	217
Filter Disposal	296	Parking On Hill	217
Identification Logo	295	Passing Light	109
		Pedals, Adjustable	114

Pets	61	Pretensioners	
Pets, Transporting	61	Seat Belts	35
Phone, Cellular	74	Programmable Electronic Features	128,132
Phone, Hands-Free	74	Programming Transmitters	22,128,132
Placard, Tire and Loading Information	226	Radial Ply Tires	234
Positive Crankcase Valve	312	Radiator Cap	310
Power		Radio	155,161
Brakes	313	Radio Broadcast Signals	154
Distribution Center	325	Radio Operation	155,161,179
Door Locks	13,14	Radio Reception	154
Mirrors	72	Radio, Satellite	173
Outlet	135	Rear Axle	319
Steering	220,303	Rear Window Defroster	195
Sunroof	133	Rear Window Features	194
Windows	27	Rear Wiper/Washer	194
Power Steering Fluid	338	Rearview Mirrors	70
Pregnant Women and Seat Belts	37	Reception, Radio	154
Preparation for Jacking	275		

Reclining Front Seats	87	Roof Type Carrier	139
Recommended Fluids, Lubricants and Genuine Parts	337	Rotation, Tires	241
Recreational Towing	262	Safety Checks Inside Vehicle	63
Shifting into Transfer Case Neutral (N)	263	Safety Checks Outside Vehicle	64
Shifting out of Transfer Case Neutral (N)	265	Safety Defects, Reporting	365
Reformulated Gasoline	243	Safety Information, Tire	221
Refrigerant	303	Safety Tips	62
Release, Hood	102	Satellite Radio	173
Reminder, Seat Belt	35	Satellite Radio Antenna	176
Remote Keyless Entry	19	Schedule, Maintenance	341
Remote Sound System Controls	177	Seat Belt Maintenance	324
Replacement Keys	10	Seat Belt Reminder	35
Replacement Parts	291	Seat Belts	28,29
Replacement Tires	237	And Pregnant Women	37
Reporting Safety Defects	365	Child Restraint	50,61
Restraints, Child	50,55	Extender	37
Restraints, Occupant	28	Front Seat	29
Rocking Vehicle When Stuck	221	Inspection	63

Pretensioners	35	Shifting	
Reminder	147	Automatic Transmission	203
Seats	86	Transfer Case	208
Adjustment	86	Transfer Case, Shifting into Transfer	
Heated	90	Case Neutral (N)	263
Lumbar Support	88	Transfer Case, Shifting out of Transfer	
Memory	97	Case Neutral (N)	265
Reclining	87	Shoulder Belt Upper Anchorage	34
Security Alarm	24,149	Shoulder Belts	29
Selection of Coolant	337	Signals, Turn	108,146,329
Selection of Oil	295	Snow Chains	239
Sentry Key	9	Snow Plow	261
Sentry Key Programming	11	Snow Tires	240
Service and Maintenance	292,340,341	Spare Tire	234,235
Service Assistance	360	Spark Plugs	297
Service Contract	362	Speed Control	116
Service Manuals	366	Speedometer	148
Setting the Clock	155	Starting	200
		Automatic Transmission	200

Emergency (Jump Starting)	280	Temperature Gauge, Engine Coolant	146
Engine Block Heater	202	Tether Anchor, Child Restraint	54
Engine Fails to Start	201	Theft System Arming	25
Starting Procedures	200	Theft System Disarming	25
Steering		Thermostat	311
Column Controls	108	Tilt Steering Column	113
Column Lock	12	Tire and Loading Information Placard	226,239
Power	220,303	Tire Identification Number (TIN)	225
Wheel, Tilt	113	Tire Markings	221
Steering Wheel Mounted Sound System		Tire Safety Information	221
Controls	177	Tires	64,230
Storage, Vehicle	326	Air Pressure	230
Stuck, Freeing	221	Alignment	238
Sun Roof	133	Chains	239
Supplemental Tire Pressure Information	239	Changing	272
Synthetic Engine Oil	296	Compact Spare	234
		General Information	230
Tachometer	149	High Speed	233
Taillights	329	Inflation Pressures	231

Jacking	275	Weight	258
Load Capacity	226,227	Traction	267
Radial	234	Traction Control	112,150
Replacement	237	Traction Control Switch	112
Rotation	241	Trailer Towing	254
Safety	221,230	Cooling System Tips	260
Sizes	223	Hitches	257
Snow Tires	240	Minimum Requirements	258
Spare Tire	273	Trailer and Tongue Weight	256
Spinning	236	Wiring	259
Tread Wear Indicators	236	Trailer Towing Guide	258
Wheel Mounting	275	Trailer Weight	258
Wheel Nut Torque	278	Transaxle	203
Tongue Weight/Trailer Weight	256	Automatic	203
Torque Converter Clutch	207	Operation	203
Towing	254	Transfer Case	319
Disabled Vehicle	282	Fluid	338
Guide	258	Transmission	203,315
Recreational	262	Automatic	203,315

Filter	318	Vehicle Loading	227,250
Fluid	318,338	Vehicle Modifications/Alterations	6
Maintenance	315	Vehicle Storage	326
Transmitter Battery Service	24	Warning Lights (Instrument Cluster Description)	146
Transmitter, Garage Door Opener	126	Warnings and Cautions	5
Transmitter Programming	22	Warranty Information	363
Tread Wear Indicators	236	Washers, Windshield	111
Trip Computer	120	Washing Vehicle	321
Trip Odometer	153	Weight Load Carrying	250
Trip Odometer Reset Button	154	Wheel Alignment and Balance	238
Turn Signals	108,146,329	Wheel and Wheel Trim	322
Universal Transmitter	126	Wheel Changing	272
Unlock, Auto	16	Wheel Mounting	275
Vacuum/Vapor Harnesses	311	Wheel Nut Torque	278
Vanity Mirrors	73	Wind Buffeting	134
Variance, Compass	125	Window Fogging	191
Vehicle Identification Number	5	Windows	27
		Power	27

386 INDEX

Windshield Defroster	63,182,187	Wiper Blade Replacement	305
Windshield Washers	110,111,305	Wiper, Rear	194
Fluid	110,305	Wipers, Intermittent	110
Windshield Wiper Blades	305	Wrecker Towing	282
Windshield Wipers	110		