

TABLE OF CONTENTS

SECTION		PAGE
1	INTRODUCTION	3
2	THINGS TO KNOW BEFORE STARTING YOUR VEHICLE	7
3	UNDERSTANDING THE FEATURES OF YOUR VEHICLE	55
4	INSTRUMENT PANEL AND CONTROLS	93
5	STARTING AND OPERATING	141
6	WHAT TO DO IN EMERGENCIES	207
7	MAINTAINING YOUR VEHICLE	219
8	MAINTENANCE SCHEDULES	261
9	IF YOU NEED CONSUMER ASSISTANCE	279
10	INDEX	287

INTRODUCTION

CONTENTS

■ Introduction	4	■ Vehicle Identification Number	5
■ How To Use This Manual	4	■ Vehicle Modifications / Alterations	5
■ Warnings And Cautions	5		

INTRODUCTION

This manual has been prepared with the assistance of service and engineering specialists to acquaint you with the operation and maintenance of your new vehicle. It is supplemented by a Warranty Information Booklet and various customer oriented documents. You are urged to read these publications carefully. Following the instructions and recommendations in this manual will help assure safe and enjoyable operation of your vehicle.

NOTE: After you read the manual, it should be stored in the vehicle for convenient reference and remain with the vehicle when sold, so that the new owner will be aware of all safety warnings.

When it comes to service, remember that your dealer knows your vehicle best, has the factory-trained technicians and genuine Mopar® parts, and is interested in your satisfaction.

WARNING!

Engine exhaust, some of its constituents, and certain vehicle components contain or emit chemicals known to the State of California to cause cancer and birth defects or other reproductive harm. In addition, certain fluids contained in vehicles and certain products of component wear contain or emit chemicals known to the State of California to cause cancer and birth defects or other reproductive harm.

HOW TO USE THIS MANUAL

Consult the table of contents to determine which section contains the information you desire.

The detailed index, at the rear of this manual, contains a complete listing of all subjects.

WARNINGS AND CAUTIONS

This manual contains **WARNINGS** against operating procedures which could result in an accident or bodily injury. It also contains **CAUTIONS** against procedures which could result in damage to your vehicle. If you do not read this entire manual you may miss important information. Observe all Warnings and Cautions.

VEHICLE IDENTIFICATION NUMBER

The vehicle identification number (VIN) is found on a stamped plate located on the left front corner of the instrument panel pad, visible from outside of the vehicle through the windshield. This number also appears on the Automobile Information Disclosure Label affixed to a window on your vehicle. Save this label for a convenient record of your vehicle identification number and optional equipment.

NOTE: It is illegal to remove the VIN plate.

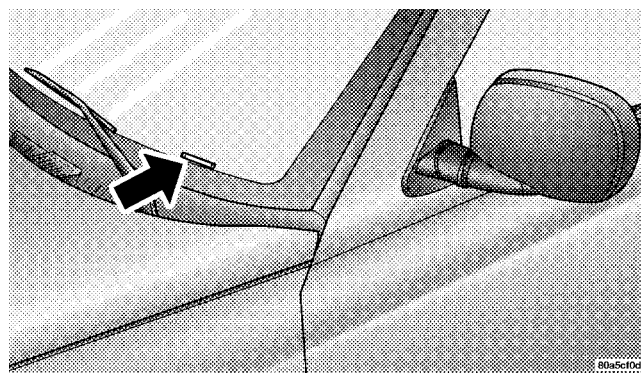
**VEHICLE MODIFICATIONS / ALTERATIONS****WARNING!**

Any modifications or alterations to this vehicle could seriously affect its roadworthiness and safety and may lead to an accident resulting in serious injury or death.

THINGS TO KNOW BEFORE STARTING YOUR VEHICLE

CONTENTS

■ A Word About Your Keys	9	□ Child Protection Door Lock	16
□ Key-In-Ignition Reminder	9	■ Remote Keyless Entry — If Equipped	17
□ Sentry Key — If Equipped	9	□ To Unlock The Doors (Four Door Vehicles)	17
■ Ignition And Steering Lock — If Equipped	11	□ To Lock The Doors	18
□ Manual Transmissions	11	□ Using The Panic Alarm	19
□ Automatic Transmissions	12	□ Programming Additional Transmitters	19
■ Illuminated Entry	12	□ General Information	20
□ Vehicles Equipped With Power Door Locks	12	□ Transmitter Battery Service	21
■ Door Locks	13	■ Security Alarm System — If Equipped	21
□ Manual Locks	13	□ To Set The Alarm	21
□ Power Door Locks — If Equipped	14	□ To Disarm The System	22

8 THINGS TO KNOW BEFORE STARTING YOUR VEHICLE

■ Windows22	□ Seat Belt Extender31
□ Power Windows — If Equipped22	□ Driver And Right Front Passenger Supplemental Restraint System—Airbag31
□ Sliding Rear Window—If Equipped23	□ Child Restraint38
□ Club Cab Vented Quarter Window24	■ Engine Break-In Recommendations52
□ Wind Buffeting24	■ Safety Tips53
■ Occupant Restraints24	□ Exhaust System53
□ Lap/Shoulder Belts25	□ Safety Checks You Should Make Inside The Vehicle54
□ Adjustable Upper Shoulder Belt Anchorage29	□ Safety Checks You Should Make Outside The Vehicle54
□ Seat Belt Pretensioners—Quad Cab Only29		
□ Front Lap Belts30		
□ Seat Belts And Pregnant Women30		

A WORD ABOUT YOUR KEYS

The double sided keys may be inserted into the locks with either side up. The keys for your new vehicle are enclosed in a plastic bag with a bar code label affixed to the front. The bar code can be used to order duplicate keys from your dealer or a locksmith. If you received your keys without the bag, ask your dealer to give you the number.

Key-In-Ignition Reminder

If you open the driver's door when the key is in the ignition lock, a continuous chime will sound to remind you to remove the key.

CAUTION!

An unlocked vehicle is an invitation to thieves. Always remove the key from the ignition and lock all the doors when leaving the vehicle unattended.

SENTRY KEY — IF EQUIPPED

With this system, an electronically coded ignition key sends a signal to the vehicle electronics. If the electronics recognizes the signal, the vehicle will start and continue to run. If the system does not recognize the signal, the vehicle will start and run for 2 seconds, then shut off. After six unsuccessful attempts at starting, the system will shut down until the correct key is used.

NOTE: The Sentry Key Immobilizer System is not compatible with remote starting systems. Use of these systems may result in vehicle starting problems and a loss of security protection. Additional Sentry Keys or Mobil Speed-pass™ devices held against or immediately adjacent to the ignition key when starting the engine may cause vehicle starting problems. If a problem occurs, remove the Sentry Key from the key-ring and attempt to start the vehicle again. Pagers, cell phones, walkman, etc. will have no effect on this system.

The "Security Light" will illuminate for about 3 seconds when the ignition switch is first turned to the ON position. If the vehicle electronics do not receive a valid signal from the ignition key, the "Security Light" will flash

continuously to signal that the vehicle has been immobilized. If the "Security Light" remains on during vehicle operation, it indicates a fault in the system electronics. If this option was ordered, all of the keys provided with your new vehicle have been programmed to the vehicle electronics.

Replacement Keys

NOTE: Only keys that have been programmed to the vehicle electronics can be used to start the vehicle. Once a Sentry Key has been programmed to a vehicle, it cannot be programmed to any other vehicle.

At the time of purchase, the original owner is provided with a four digit PIN number. This number is required for dealer replacement of keys. Duplication of keys may be performed at an authorized dealer or by using the Customer Key Programming procedure. This procedure consists of programming a blank key to the vehicle electronics. A blank key is one which has never been programmed and needs to be cut.

NOTE: When having the Sentry Key System serviced, bring all vehicle keys to the dealer.

Customer Key Programming

You can program new keys to the system if you have two valid keys by doing the following:

1. Insert the first valid key into the ignition and turn the ignition to the ON position for at least 3 seconds but no longer than 15 seconds. Turn the ignition back to the OFF position and remove the first key.
2. Insert the second valid key and switch the ignition to the ON position within 15 seconds. After 10 seconds, a chime will sound and the "Security Light" will begin to flash. Turn the ignition back to the OFF position and remove the second key.
3. Insert a blank Sentry Key into the ignition and switch the ignition to the ON position within 60 seconds of having removed the second key. After 10 seconds, a single chime will sound. The "Security Light" will stop flashing, then turn on for 3 seconds; then turn off.

The new Sentry Key has been programmed. Repeat this process to program up to a total of 8 keys.

General Information

This device complies with part 15 of FCC rules and with RS-210 of Industry Canada. Operation is subject to the following conditions:

1. This device may not cause harmful interference.
2. This device must accept any interference that may be received including interference that may cause undesired operation.

NOTE: Changes or modifications not expressly approved by the party responsible for compliance could void the user's authority to operate the equipment.

IGNITION AND STEERING LOCK — IF EQUIPPED

Manual Transmissions

Depress and hold the release button located between the ignition switch and the instrument panel. Turn the ignition key to LOCK and remove the key.

2

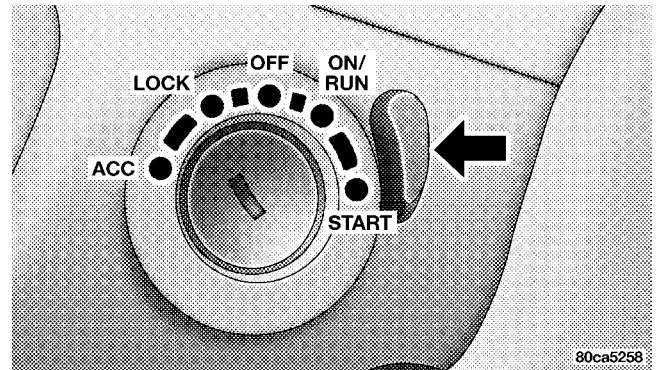

Manual Transmissions

Automatic Transmissions

In the LOCK position, the steering and ignition systems are locked to provide antitheft protection for your vehicle. It may be difficult to turn the key from the LOCK position when starting your vehicle. Move the steering wheel left and right while turning the key until it turns easily. The key can be inserted or withdrawn only in the LOCK position. Push in on the key in the ignition lock cylinder to rotate to the LOCK position.

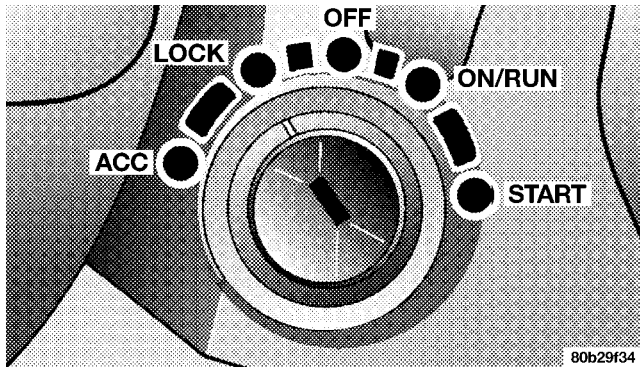

Automatic Transmissions

NOTE: On vehicles equipped with an automatic transmission, the key cannot be turned to LOCK until the selector is in the PARK position. Do not attempt to pull the shift lever out of PARK after the key is in the LOCK position.

ILLUMINATED ENTRY

Vehicles Equipped With Power Door Locks

All interior lights will illuminate in the vehicle when the doors are unlocked using the key fob, when any door is opened or, if equipped with security, when the door key cylinder is turned to the unlock position. Vehicles equipped with a cargo lamp will turn the cargo lamp on for 30 seconds when the doors are unlocked using the key fob.

The interior lights will remain on for 30 seconds after the last door is closed, or until all doors are closed and either the ignition is turned to the ON position or a key fob LOCK button is pressed.

There is also a battery saver feature that will turn the interior lights off after 15 minutes if the ignition is OFF and a door is left open or the dimmer control is in the interior lights ON position or cargo light ON position.

DOOR LOCKS

Manual Locks

Front doors may be locked, sliding the lock knob rearward. When the orange indicator is visible the lock knob is in the unlocked position.

Both doors may be opened with the inside door handle without sliding the lock knob forward. Doors locked before closing will remain locked when closed.

The ignition key will unlock all the locks on your vehicle.

WARNING!

For personal security and safety in the event of an accident, lock the vehicle doors when you drive as well as when you park and leave the vehicle.

2

WARNING!

When leaving the vehicle always remove the key from the ignition lock, and lock your vehicle. Do not leave children unattended in the vehicle, or with access to an unlocked vehicle. Unsupervised use of vehicle equipment may cause severe personal injuries and death.

Power Door Locks — If Equipped

Vehicles equipped with power door locks can be locked or unlocked from inside by either the use of the door lock switches located on the front doors or by pressing the LOCK or UNLOCK buttons on the Remote Keyless Entry key fob.

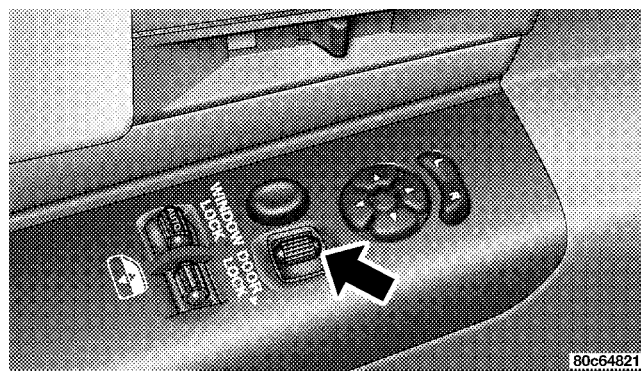
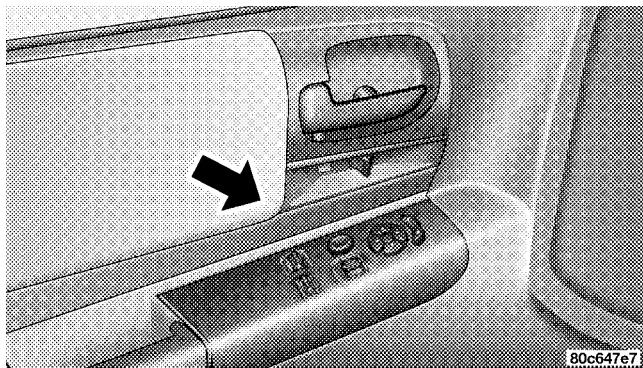

As a safety feature the doors will not lock when using the door lock switches during the following conditions:

1. The driver's door is open while the key is in the ignition.
2. The driver's door is open while the headlight switch is ON.

Central Locking — If Equipped

Vehicles with security will have a feature called "Central Locking." When the key is placed in the door cylinder and turned to the "Unlock" position, the security will be disarmed, the illuminated entry will be turned on and that door will be mechanically unlocked. If the key is once again turned to the unlock position within 5 seconds of the first unlock, the remaining doors will unlock. If the key is turned to the "Lock" position while all doors are closed, illuminated entry will be canceled, security will begin arming, and all doors will lock.

Automatic Door Locks

If this feature is enabled, your door locks will lock automatically when the vehicle's speed exceeds 15 mph (24 km/h).

This feature is enabled when your vehicle is shipped from the assembly plant and can be disabled by using the following procedure:

1. Enter your vehicle and close all doors.
2. Fasten your seat belt (Fastening the seat belt will cancel any chiming that may confuse you during this programming procedure).
3. Place the key into the ignition.
4. Within 10 seconds cycle the key from the OFF position to the ON position four times; ending in the OFF position (**Do not start the engine**).
5. Within 30 seconds, press the driver's door lock switch in the LOCK direction.
6. A single chime will be heard to indicate the feature has been disabled.
7. To reactivate this feature, repeat the above steps.
8. If a chime is not heard, program mode was canceled before the feature could be disabled. If necessary, repeat the above procedure.

Child Protection Door Lock

To provide a safer environment for small children riding in the rear seats, the rear doors are equipped with a child protection door lock system.

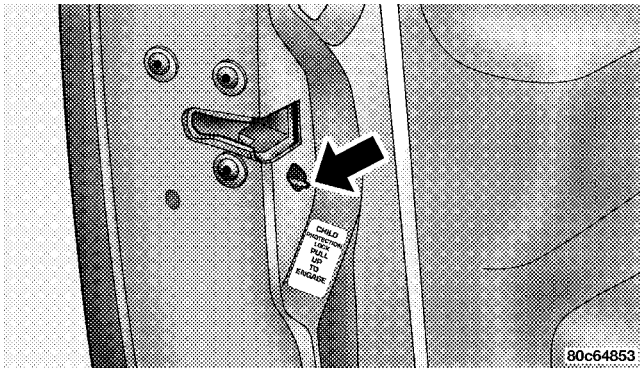

80c64854

This label is located near the lock lever.

WARNING!

Avoid trapping anyone in the vehicle in a collision. Remember that the rear doors can only be opened from the outside when the child protection locks are engaged.

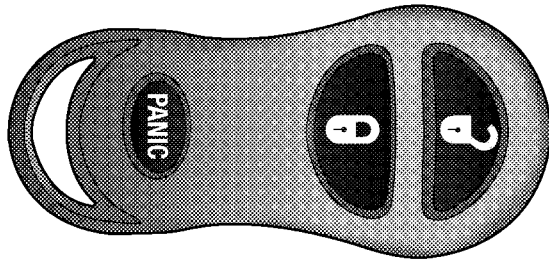
REMOTE KEYLESS ENTRY — IF EQUIPPED

80b6f052

This system allows you to lock or unlock the doors from distances up to about 23 feet (7 meters) using a hand held radio transmitter. The transmitter need not be pointed at the vehicle to activate the system.

To unlock the doors (four door vehicles):

Press and release the UNLOCK button on the key fob once to unlock only the driver's door or twice to unlock all the doors. When the UNLOCK button is pressed, the

illuminated entry will initiate, the parking lights will flash on twice and if installed, the cargo lamp will turn on for 30 seconds.

The system can be programmed to unlock all the doors upon the first UNLOCK button press by using the following procedure:

1. Enter your vehicle and close all doors.
2. Fasten your seat belt. (Fastening the seat belt will cancel any chiming that may confuse you during this programming procedure).
3. Place the key into the ignition.
4. Within 10 seconds cycle the key from the OFF position to the ON position four times; ending in the ON position (**Do not start the engine**).
5. Within 30 seconds, press the driver's door lock switch in the UNLOCK direction.
6. A single chime will be heard to indicate the feature has been disabled.
7. To reactivate this feature, repeat the above steps.

18 THINGS TO KNOW BEFORE STARTING YOUR VEHICLE

8. If a chime is not heard, program mode was canceled before the feature could be disabled. If necessary, repeat the above procedure.

NOTE: All two-door vehicles will be shipped from the assembly plant with this feature disabled. If this feature is enabled on a two door vehicle, a single UNLOCK button press will initiate the illuminated entry only - none of the doors will unlock. If the UNLOCK button is pressed a second time within 4 seconds of the first, all doors will unlock.

To lock the doors:

Press and release the LOCK button on the transmitter to lock all doors. If the ignition is OFF, when the doors are locked, the parking lights will flash on once and the horn will chirp once.

The horn chirp feature will be shipped from the assembly plants activated. If desired this feature can be disabled by using the following procedure:

1. Enter your vehicle and close all doors.
2. Fasten your seat belt (Fastening the seat belt will cancel any chiming that may confuse you during this programming procedure).
3. Place the key into the ignition.
4. Turn the ignition to the ON position (**Do not start the engine**).
5. Press and hold the LOCK button on the key fob.
6. After holding the LOCK button for four seconds, also press the PANIC button within 6 seconds.
7. When a single chime is heard, release both buttons.
8. Turn the ignition OFF to test the horn chirp feature.
9. To reactivate this feature, repeat the above steps.
10. If a chime is not heard, program mode was canceled before the feature could be disabled. If necessary, repeat the above procedure.

Using the Panic Alarm

To activate the Panic mode while the ignition is OFF press and release the PANIC button on the transmitter once. When the Panic mode is activated, the interior lights will illuminate, the headlamps and parking lights will flash, and the horn will sound.

To cancel the Panic mode press and release the PANIC button on the transmitter a second time. Panic mode will automatically cancel after 3 minutes or if the vehicle is started and exceeds 15 mph (24 km/h). During the Panic Mode, the door locks and remote keyless entry systems will function normally. Panic mode will not disarm the security system on vehicles so equipped.

Programming Additional Transmitters

Vehicles with the keyless entry option will be shipped from the assembly plants with two key fob transmitters programmed only for that vehicle. A total of four fobs can be programmed for your vehicle. Additional fobs can be programmed to your vehicle through the use of a currently programmed fob.

NOTE: When entering program mode using that fob, all other programmed fobs will be erased and you will have to reprogram them for your vehicle.

Use the Following procedure to program additional key fobs:

1. Enter your vehicle and close all doors.
2. Fasten your seat belt (Fastening the seatbelt will cancel any chiming that may confuse you during this programming procedure).
3. Place the key into the ignition.
4. Turn the ignition to the ON position (**Do not start the engine**).
5. Press and hold the UNLOCK button on the key fob.
6. After holding the UNLOCK button for four seconds, also press the PANIC button within 6 seconds.
7. Release both buttons and a single chime will be heard. The chime is an indication that you have successfully entered program mode. All fobs that are to be programmed must be done so within 30 seconds of when the chime was heard.

20 THINGS TO KNOW BEFORE STARTING YOUR VEHICLE

8. Using the fob to be programmed, press and release both the LOCK and UNLOCK buttons, simultaneously.
9. A single chime will be heard.
10. Within four seconds of hearing the chime, press and release either the LOCK or UNLOCK button on the fob.
11. Repeat steps 8 through 10 to program up to two additional fobs.
12. Your vehicle will remain in program mode up to 30 seconds from when the original chime was heard. After 30 seconds, all programmed fobs function normally.

NOTE: If you do not have a programmed transmitter, contact your dealer for details.

General Information

This device complies with part 15 of FCC rules and with RS-210 of Industry Canada. Operation is subject to the following conditions:

1. This device may not cause harmful interference.
2. This device must accept any interference that may be received including interference that may cause undesired operation.

NOTE: Changes or modifications not expressly approved by the party responsible for compliance could void the user's authority to operate the equipment.

If your Keyless Entry Transmitter fails to operate from a normal distance, check for these two conditions.

1. Weak batteries in transmitter. The expected life of the batteries is from one to two years.
2. Closeness to a radio transmitter such as a radio station tower, airport transmitter, and some mobile or CB radios.

Transmitter Battery Service

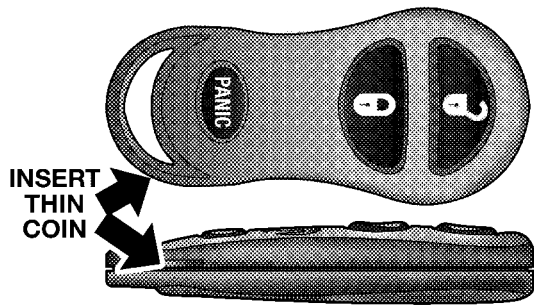

80b6f053

The recommended replacement battery is 2016.

NOTE: Do not touch the battery terminals that are on the back housing or the printed circuit board.

1. With transmitter buttons facing down, use a flat blade or dime to pry the two halves of the transmitter apart. Make sure not to damage the rubber gasket during removal.

2. Remove and replace the batteries. Avoid touching the new batteries with your fingers. Skin oils may cause battery deterioration. If you touch a battery, clean it with rubbing alcohol.

3. To reassemble the transmitter case snap the two halves together. Make sure there is an even gap between the two halves. Test transmitter operation.

SECURITY ALARM SYSTEM — IF EQUIPPED

This system monitors the vehicle doors and ignition for unauthorized operation. When the alarm is activated, the system provides both audible and visual signals. The horn will sound repeatedly for 3 minutes and the headlights and security light in the instrument cluster will flash for an additional 15 minutes. The engine will not run until the system is disarmed.

To Set the Alarm:

The alarm will set when you use the power door locks, turn the key in the door lock cylinder, or use the Keyless Entry transmitter to lock the doors. After all the doors are locked and closed the SECURITY light in the instrument cluster will flash rapidly to signal that the system is

22 THINGS TO KNOW BEFORE STARTING YOUR VEHICLE

arming. The security light in the instrument panel cluster will flash rapidly for about 15 seconds to indicate that the alarm is being set. After the alarm is set, the security light will flash at a slower rate to indicate that the system is armed.

NOTE: If the SECURITY light stays on continuously during vehicle operation, have the system checked by your dealer.

To Disarm the System:

Use the Keyless Entry transmitter or the key to turn the door locks to the unlock position. If something has triggered the system in your absence, the horn will sound three times when you unlock the doors. Check the vehicle for tampering.

The Security system will also disarm, if the vehicle is started with a programmed Sentry Key. If an unprogrammed Sentry Key is used to start a vehicle, the engine will run for 2 seconds and then the security alarm will be initiated. To exit alarming mode, press the RKE Unlock button, unlock the doors using the key cylinder, or start the vehicle with a programmed Sentry Key.

The Security Alarm System is designed to protect your vehicle; however, you can create conditions where the system will arm unexpectedly. If you remain in the vehicle and lock the doors with the transmitter, the alarm will sound when you pull the door handle to exit. You may also accidentally disarm the system by unlocking any door with the door key and then locking it. The door will be locked but the Security Alarm will not arm.

WINDOWS

Power Windows — IF Equipped

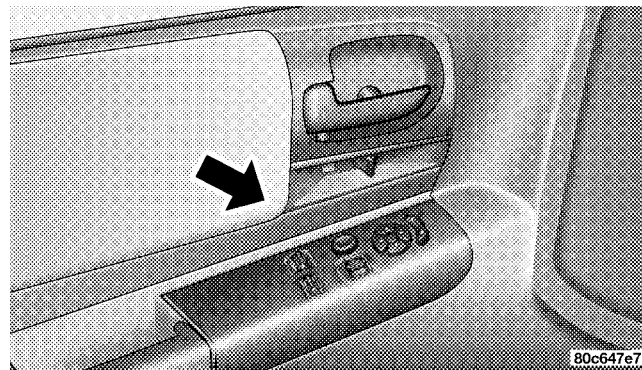

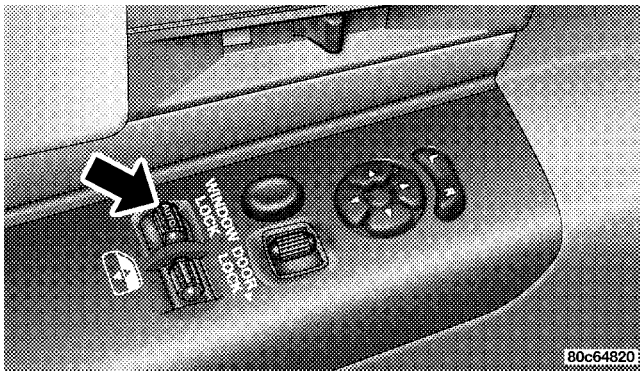

The control on the left front door panel has up-down switches that give you fingertip control of all power windows. There is a single opening and closing switch on the front passenger door for passenger window control and on the rear doors of Quad Cab models. The windows will operate only when the ignition switch is turned to the ON position.

Auto Down

The driver's window switch has an Auto Down feature. Press the window switch past the detent, release, and the window will go down automatically.

Window Lockout Switch

The window lockout switch on the driver's door allows you to disable the window control on the other doors. To disable the window controls on the other doors, press the window lock button. To enable the window controls, press the window control button again.

2

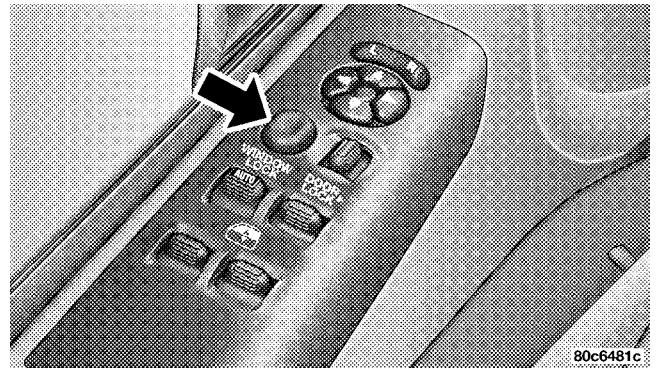

Sliding Rear Window—If Equipped

A locking device in the center of the window helps to prevent entry from the rear of the vehicle. Squeeze the lock to release the window.

Club Cab Vented Quarter Window

The Club Cab is equipped with rear quarter windows that open out. Pull the window latch toward you to unlock, and push out on the window. Press the latch straight to secure the window in an open position.

WIND BUFFETING

Wind buffeting can be described as the perception of pressure on the ears or a helicopter type sound in the ears. Your vehicle may exhibit wind buffeting with the windows down, or the sunroof (if so equipped) in certain open or partially open positions. This is a normal occurrence and can be minimized. If the buffeting occurs with the rear windows open, open the front and rear windows together to minimize the buffeting. If the buffeting occurs with the sunroof open, adjust the sunroof opening to minimize the buffeting.

OCCUPANT RESTRAINTS

Some of the most important safety features in your vehicle are the restraint systems. These include the front and rear seat belts for the driver and all passengers, and front airbags for both the driver and front passenger. If you will be carrying children too small for adult-size belts, your seat belts also can be used to hold infant and child restraint systems.

Please pay close attention to the information in this section. It tells you how to use your restraint system properly to keep you and your passengers as safe as possible.

WARNING!

In a collision, you and your passengers can suffer much greater injuries if you are not properly buckled up. You can strike the interior of your vehicle or other passengers, or you can be thrown out of the vehicle. Always be sure you and others in your vehicle are buckled up properly.

Buckle up even though you are an excellent driver, even on short trips. Someone on the road may be a poor driver and cause a collision that includes you. This can happen far away from home or on your own street.

Research has shown that seat belts save lives, and that they can reduce the seriousness of injuries in a collision. Some of the worst injuries happen when people are thrown from the vehicle. Seat belts reduce the possibility of ejection and the risk of injury caused by striking the inside of the vehicle. **Everyone** in a motor vehicle should be belted at all times.

Lap/Shoulder Belts

The outboard front and rear seats of your vehicle have combination lap/shoulder belts. The belt webbing retractor is designed to lock during very sudden stops or collisions. This feature allows the shoulder part of the belt to move freely with you under normal conditions. But in a collision, the belt will lock and reduce the risk of your striking the inside of the vehicle or being thrown out.

WARNING!

It is extremely dangerous to ride in a cargo area, inside or outside of a vehicle. In a collision, people riding in these areas are more likely to be seriously injured or killed.

Do not allow people to ride in any area of your vehicle that is not equipped with seats and seat belts.

Be sure everyone in your vehicle is in a seat and using a seat belt properly.

WARNING!

- **Wearing a seat belt incorrectly is dangerous.** Seat belts are designed to go around the large bones of your body. These are the strongest parts of your body and can take the forces of a collision the best. Wearing your belt in the wrong place could make your injuries in a collision much worse. You might suffer internal injuries, or you could even slide out of part of the belt. Follow these instructions to wear your seat belt safely and to keep your passengers safe, too.
- **Two people should never be belted into a single seat belt.** People belted together can crash into one another in an accident, hurting one another badly. Never use a lap/shoulder belt or a lap belt for more than one person, no matter what their size.

Lap/Shoulder Belt Operating Instructions

1. Enter the vehicle and close the door. Sit back and adjust the seat.

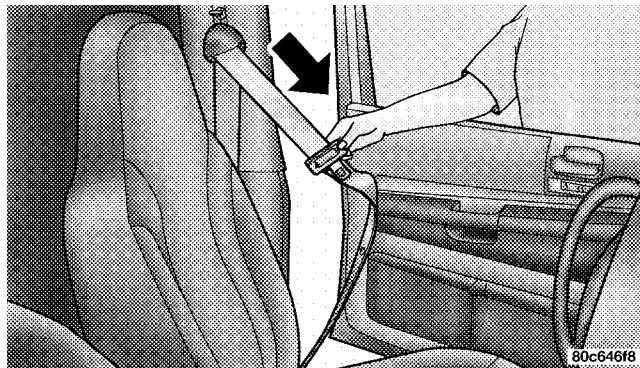

2. The seat belt latch plate is above the back of the front seat, next to your arm in the rear seat. Grasp the latch plate and pull out the belt. Slide the latch plate up the webbing as far as necessary to allow the belt to go around your lap.

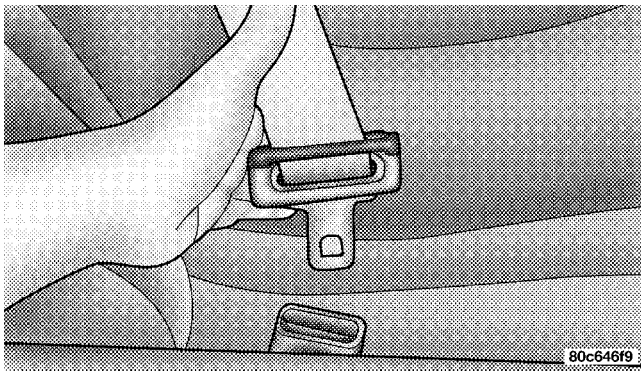

3. When the belt is long enough to fit, insert the latch plate into the buckle until you hear a “click.”

WARNING!

- A belt buckled into the wrong buckle will not protect you properly. The lap portion could ride too high on your body, possibly causing internal injuries. Always buckle your belt into the buckle nearest you.
- A belt that is too loose will not protect you as well. In a sudden stop you could move too far forward, increasing the possibility of injury. Wear your seat belt snugly.
- A belt that is worn under your arm is very dangerous. Your body could strike the inside surfaces of the vehicle in a collision, increasing head and neck injury. And a belt worn under the arm can cause internal injuries. Ribs aren't as strong as shoulder bones. Wear the belt over your shoulder so that your strongest bones will take the force in a collision.
- A shoulder belt placed behind will not protect you from injury during a collision. You are more likely to hit your head in a collision if you do not wear your shoulder belt. The lap and shoulder belt are meant to be used together.

4. Position the lap belt across your thighs, below your abdomen. To remove slack in the lap belt portion, pull up on the shoulder belt. To loosen the lap belt if it is too tight, tilt the latch plate and pull on the lap belt. A snug belt reduces the risk of sliding under the belt in a collision.

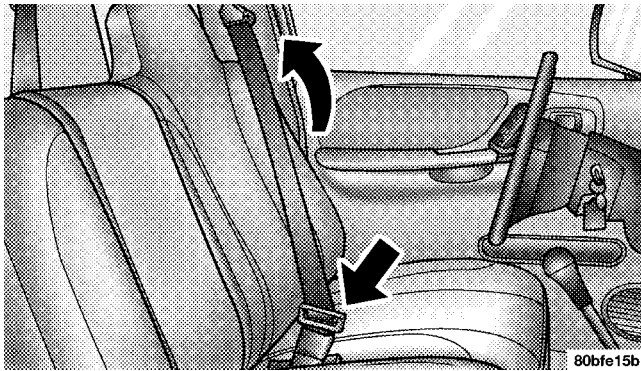

WARNING!

- A lap belt worn too high can increase the risk of internal injury in a collision. The belt forces won't be at the strong hip and pelvic bones, but across your abdomen. Always wear the lap belt as low as possible and keep it snug.
- A twisted belt can't do its job as well. In a collision it could even cut into you. Be sure the belt is straight. If you can't straighten a belt in your vehicle, take it to your dealer and have it fixed.

5. Position the shoulder belt on your chest so that it is comfortable and not resting on your neck. The retractor will withdraw any slack in the belt.

6. To release the belt, push the red button on the buckle. The belt will automatically retract to its stowed position. If necessary, slide the latch plate down the webbing to allow the belt to retract fully.

WARNING!

A frayed or torn belt could rip apart in a collision and leave you with no protection. Inspect the belt system periodically, checking for cuts, frays, or loose parts. Damaged parts must be replaced immediately. Do not disassemble or modify the system. Seat belt assemblies must be replaced after a collision if they have been damaged (bent retractor, torn webbing, etc.).

Adjustable Upper Shoulder Belt Anchorage

In the front row outboard seats, the shoulder belt can be adjusted upward or downward to help position the belt away from your neck. Lift the button located above the upper belt guide to release the anchorage, and then move it up or down to the position that serves you best.

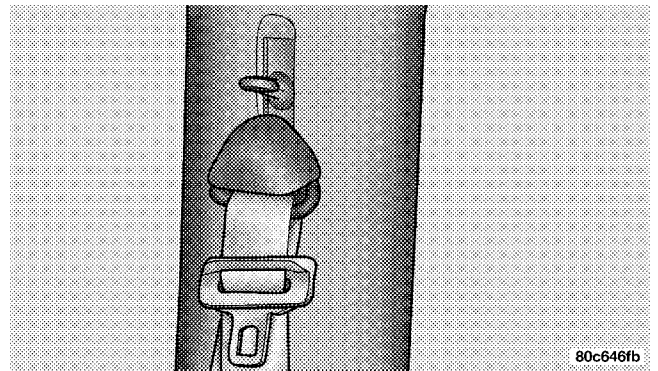

80c646fb

2

As a guide, if you are shorter than average, you will prefer a lower position, and if you are taller than average, you'll prefer a higher position. When you release the anchorage, try to move it up or down to make sure that it is locked in position.

Seat Belt Pretensioners—Quad Cab Only

The seat belts for both front seating positions are equipped with pretensioning devices that are designed to remove any slack from the seat belt systems in the event of a collision. These devices improve the performance of the seat belt by assuring that the belt is tight about the

occupant early in a collision. Pretensioners work for all size occupants, including those in child restraints.

NOTE: These devices are not a substitute for proper seat belt placement by the occupant. The seat belt still must be worn snugly and positioned properly.

The pretensioners are triggered by the airbag control module. Like the airbags, the pretensioners are single use items. After a collision that is severe enough to deploy the airbags and pretensioners, both must be replaced.

Front Lap Belts

The center seating positions have a lap belt only. To fasten the lap belt, slide the latch plate into the buckle until you hear a "click." To lengthen the lap belt, tilt the latch plate and pull. To remove slack, pull the loose end of the webbing. Wear the lap belt snug against the hips. Sit back and erect in the seat, then adjust the belt as tightly as is comfortable.

WARNING!

- A lap belt worn too loose or too high is dangerous.
- A belt worn too loose can allow you to slip down and under the belt in a collision.
- A belt that is too loose or too high will apply crash forces to the abdomen, not to the stronger hip bones. In either case, the risk of internal injuries is greater. Wear a lap belt low and snug.

Seat Belts and Pregnant Women

We recommend that pregnant women use seat belts throughout their pregnancies. Keeping the mother safe is the best way to keep the baby safe.

Pregnant women should wear the lap part of the belt across the thighs and as snug against the hips as possible. Keep the belt low so that it does not come across the abdomen. That way the strong bones of the hips will take the force if there is a collision.

Seat Belt Extender

If a seat belt is too short, even when fully extended, your dealer can provide you with a seat belt extender. This extender should be used only if the existing belt is not long enough. When it is not required, remove the extender and store it.

WARNING!

Using a seat belt extender when not needed can increase the risk of injury in a collision. Only use the seat belt extender when the lap belt is not long enough when it is worn low and snug, and in the recommended seating positions. Remove and store the extender when not needed.

Driver And Right Front Passenger Supplemental Restraint System—Airbag

This vehicle has front airbags for both the driver and front passenger as a supplement to the seat belt restraint systems. The driver's front airbag is mounted in the center of the steering wheel. The passenger's front airbag

is mounted in the instrument panel, above the glove compartment. The words SRS AIRBAG are embossed on the airbag covers.

These airbags are certified to the new Federal regulations that allow less forceful deployments.

2

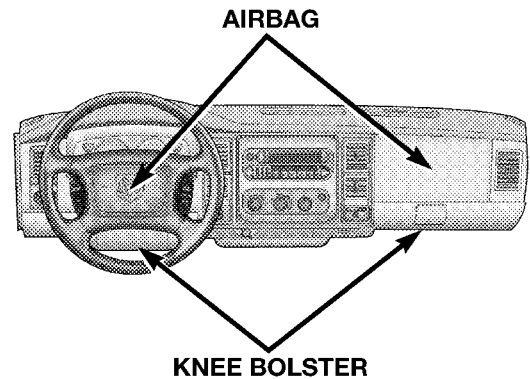

80c647df

WARNING!

Do not put anything on or around the front airbag covers or attempt to manually open them. You may damage the airbags and you could be injured because the airbags are not there to protect you. These protective covers for the airbag cushions are designed to open only when the airbags are inflating.

Airbags inflate in moderate to high speed impacts. Along with the seatbelts, front airbags work with the instrument panel knee bolsters to provide improved protection for the driver and front passenger.

The seat belts are designed to protect you in many types of collisions. The front airbags deploy in moderate to severe frontal collisions. But even in collisions where the airbags work, you need the seat belts to keep you in the right position for the airbags to protect you properly.

Here are some simple steps you can follow to minimize the risk of harm from a deploying airbag.

- Children 12 years and under should ride buckled up in a rear seat, if available.
- Infants in rear facing child restraints must **NEVER** ride in the front seat of a vehicle with a passenger front airbag **unless the airbag is turned off**. An airbag deployment could cause severe injury or death to infants in that position. See the passenger airbag on/off switch section.
- If your vehicle does not have a rear seat, see the Passenger Airbag On/Off Switch section.
- Children that are not big enough to properly wear the vehicle seat belt (see section on Child Restraints) should be secured in the rear seat in child restraints or belt-positioning booster seats. Older children who do not use child restraints or belt-positioning booster seats should ride properly buckled up in the rear seat. Never allow children to slide the shoulder belt behind them or under their arm.
- All occupants should use their seat belts properly.

- The driver and front passenger seats should be moved back as far as practical to allow the airbag room to inflate.

WARNING!
<ul style="list-style-type: none"> • Relying on the airbags alone could lead to more severe injuries in a collision. The airbags work with your seat belt to restrain you properly. In some collisions the airbags won't deploy at all. Always wear your seat belts even though you have airbags. • Being too close to the steering wheel or instrument panel during airbag deployment could cause serious injury. Airbags need room to inflate. Sit back, comfortably extending your arms to reach the steering wheel or instrument panel.

- AIRBAG Readiness Light
- Driver Airbag
- Passenger Airbag
- Steering Wheel and Column
- Instrument Panel
- Airbag Control Module bullet (with integrated crash sensor)
- Interconnecting Wiring
- Knee Impact Bolsters
- Passenger Side Frontal Airbag ON/OFF Switch

How The Airbag System Works

- The airbag control module determines if a frontal collision is severe enough to require the airbags to inflate.
- The airbag control module will not detect side, roll over, or rear collisions.

Airbag System Components

The airbag system consists of the following:

- Airbag Control Module

34 THINGS TO KNOW BEFORE STARTING YOUR VEHICLE

- The airbag control module also monitors the readiness of the electronic parts of the system whenever the ignition switch is in the START or RUN positions. These include all of the items listed above except the knee bolsters, the instrument panel, and the steering wheel and column. If the key is in the "off" position, in the ACC position, or not in the ignition, the airbags are not on and will not inflate.
- The airbag control module also turns on the AIRBAG light in the instrument panel for 6 to 8 seconds when the ignition is first turned on, then turns the light off. If it detects a malfunction in any part of the system, it turns on the light either momentarily or continuously.
- When the airbag control module detects a collision requiring the airbags, it signals the inflator units. A large quantity of nontoxic gas is generated to inflate the airbags. The airbag covers separate and fold out of the way as the airbags inflate to their full size. The airbags fully inflate in milliseconds. This is only about half of the time it takes you to blink your eyes. The airbags then quickly deflate while helping to restrain the driver and front passenger. The driver's front airbag gas is vented through the airbag material towards the instrument panel. The passenger's front airbag gas is vented through vent holes in the sides of the airbag. In this way the airbags do not interfere with your control of the vehicle.

WARNING!

Ignoring the AIRBAG light in your instrument panel could mean you won't have the airbags to protect you in a collision. If the light does not come on, stays on after you start the vehicle, or if it comes on as you drive, have the airbag system checked right away.

- The knee impact bolsters help protect the knees and position you for the best interaction with the front airbag.

Passenger Airbag On/Off Switch – If Equipped

The passenger front airbag is to be turned off only if the passenger:

- is an infant (less than 1 year old) who must ride in the front seat because there is no rear seat, because the rear

seat is too small for a rear-facing infant restraint or because the infant has a medical condition which makes it necessary for the driver to be able to see the infant,

- is a child, age 1 to 12 who must ride in the front seat because there is no rear seat, because there is no rear seat position available, or because the child has a medical condition which makes it necessary for the driver to be able to see the child,
- has a medical condition which makes passenger airbag inflation (deployment) a greater risk for the passenger than the risk of hitting the dashboard (instrument panel) or windshield in a crash.

WARNING!

Whenever an airbag is turned off, even a lap/shoulder belted passenger may hit their head, neck, or chest on the dashboard (instrument panel) or windshield in a crash. This may result in serious injury or death.

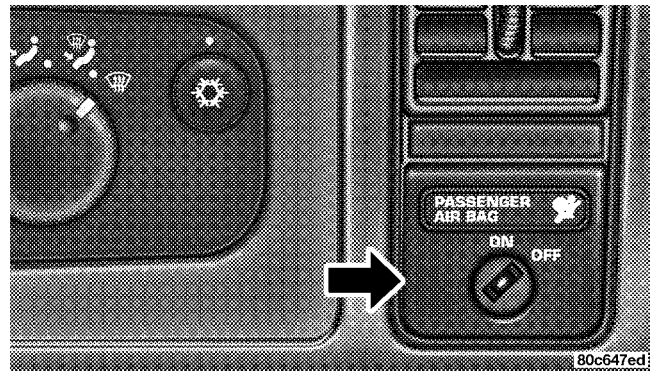

2

NOTE: The Passenger Airbag On/Off Switch is not available in the Quad Cab.

To Shut Off the Passenger Airbag

Place the ignition key in the Passenger Airbag On/Off Switch, push the key in and turn clockwise, and remove the key from the switch. This will shut off the passenger side airbag. The "Off" light near the switch will illuminate when the ignition switch is turned to the ON position.

To Turn On the Passenger Airbag

Place the ignition key in the Passenger Airbag On/Off Switch, push the key in and turn counterclockwise, and remove the key from the switch. This will turn on the passenger airbag. The “Off” light near the switch will be off when the ignition switch is turned to the ON position.

If A Deployment Occurs

The airbag system is designed to deploy when the air bag control module detects a moderate-to-severe frontal collision, and then immediately to deflate.

NOTE: A frontal collision that is not severe enough to need airbag protection will not activate the system. This does not mean something is wrong with the airbag system.

If you do have a collision which deploys the airbags, any or all of the following may occur:

- The nylon airbag material may sometimes cause abrasions and/or skin reddening to the driver and front passenger as the airbags deploy and unfold. The abrasions are similar to friction rope burns or those you might get sliding along a carpet or gymnasium

floor. They are not caused by contact with chemicals. They are not permanent and normally heal quickly. However, if you haven't healed significantly within a few days, or if you have any blistering, see your doctor immediately.

- As the airbags deflate you may see some smoke-like particles. The particles are a normal by-product of the process that generates the nontoxic gas used for airbag inflation. These airborne particles may irritate the skin, eyes, nose, or throat. If you have skin or eye irritation, rinse the area with cool water. For nose or throat irritation, move to fresh air. If the irritation continues, see your doctor. If these particles settle on your clothing, follow the garment manufacturers instructions for cleaning.
- It is not advisable to drive your vehicle after the airbags have deployed. If you are involved in another collision, the airbags will not be in place to protect you.

WARNING!

Deployed airbags can't protect you in another collision. Have the airbags replaced by an authorized dealer as soon as possible.

Enhanced Accident Response System

If the airbags deploy after an impact and the electrical system remains functional, vehicles equipped with power door locks will unlock automatically. In addition, approximately 10 seconds after the vehicle has stopped moving, the interior lights will light until the ignition switch is turned off.

Maintaining Your Airbag Systems

WARNING!

- Modifications to any part of the airbag system could cause it to fail when you need it. You could be injured because the airbags are not there to protect you. Do not modify the components or wiring, including adding any kind of badges or stickers to the steering wheel hub trim cover or the upper right side of the instrument panel. Do not modify the front bumper, vehicle body structure, or frame.
- You need proper knee impact protection in a collision. Do not mount or locate any aftermarket equipment on or behind the knee bolster.
- It is dangerous to try to repair any part of the airbag system yourself. Be sure to tell anyone who works on your vehicle that it has airbags.

Airbag Light

You will want to have the airbags ready to inflate for your protection in an impact. While the airbag system is designed to be maintenance free, if any of the following occurs, have an authorized dealer service the system promptly:

- The airbag light does not come on or flickers during the 6 to 8 seconds when the ignition switch is first turned on.
- The light remains on or flickers after the 6 to 8 second interval.
- The light flickers or comes on and remains on while driving.

NOTE: If the speedometer, tachometer or any engine related gauges are not working, the airbag control module may also be disabled. The airbags may not be ready to inflate for your protection. Promptly check fuse numbers 18 and 19 in the fuse block. See your dealer if the fuse is good.

Child Restraint

Everyone in your vehicle needs to be buckled up all the time — babies and children, too. Every state in the United States and all Canadian provinces require that small children ride in proper restraint systems. This is the law, and you can be prosecuted for ignoring it.

Children 12 years and under should ride properly buckled up in a rear seat, if available. According to crash statistics, children are safer when properly restrained in the rear seats rather than in the front.

WARNING!

In a collision, an unrestrained child, even a tiny baby, can become a missile inside the vehicle. The force required to hold even an infant on your lap can become so great that you could not hold the child, no matter how strong you are. The child and others could be badly injured. Any child riding in your vehicle should be in a proper restraint for the child's size.

Infants and Small Children

There are different sizes and types of restraints for children from newborn size to the child almost large enough for the adult seat belt. Use the restraint that is correct for your child:

- Safety experts recommend that children ride rearward-facing in the vehicle until they are at least one year old and weigh at least 20 lbs (9 kg). Two types of child restraints can be used rearward-facing: infant carriers and "convertible" child seats. Both types of child restraints are held in the vehicle by the lap/shoulder belt.
- The infant carrier is only used rearward-facing in the vehicle. It is recommended for children who weigh up to about 20 lbs (9 kg). "Convertible" child seats can be used either rearward-facing or forward-facing in the vehicle. Convertible child seats often have a higher weight limit in the rearward-facing direction than infant carriers do, so they can be used rearward-facing by children who weigh more than 20 lbs (9 kg) but are less than one year old.
- Rearward-facing child seats must **NEVER** be used in the front seat of a vehicle with a front passenger airbag unless the airbag is turned off. An airbag deployment could cause severe injury or death to infants in this position.
- Children who weigh more than 20 lbs. (9 kg) and who are older than one year can ride forward-facing in the vehicle. Forward-facing child seats and convertible child seats used in the forward-facing direction are for children who weigh 20 to 40 lbs (9 to 18 kg) and who are older than one year. These child seats are also held in the vehicle by the lap/shoulder belt.
- The belt-positioning booster seat is for children weighing more than 40 lbs (18 kg), but who are still too small to fit the vehicle's seat belts properly. If the child cannot sit with knees bent over the vehicle's seat cushion while the child's back is against the seat back, they should use a belt-positioning-booster seat. The child and booster seat are held in the vehicle by the lap/shoulder belt. (Some booster seats are equipped

with a front shield and are held in the vehicle by the lap portion.) For further information refer to www.seatcheck.org.

WARNING!

- **Improper installation can lead to failure of an infant or child restraint. It could come loose in a collision. The child could be badly injured or killed. Follow the manufacturers directions exactly when installing an infant or child restraint.**
- **A rearward facing child restraint should only be used in a rear seat, or in the front seat if the passenger's front airbag is Off. If the airbag is left On, a rearward facing child restraint in the front seat may be struck by a deploying passenger airbag which may cause severe or fatal injury to the infant.**

Here are some tips for getting the most out of your child restraint:

- Before buying any restraint system, make sure that it has a label certifying that it meets all applicable Safety Standards. We also recommend that you make sure that you can install the child restraint in the vehicle where you will use it before you buy it.
- The restraint must be appropriate for your child's weight and height. Check the label on the restraint for weight and height limits.
- Carefully follow the instructions that come with the restraint. If you install the restraint improperly, it may not work when you need it.
- The passenger seat belts are equipped with cinching latch plates, which are designed to keep the lap portion tight around the child restraint so that it is not necessary to use a locking clip. Pulling up on the shoulder portion of the lap/shoulder belt will tighten the belt. The cinching latch plate will keep the belt tight, however, any seat belt system will loosen with time, so check the belt occasionally and pull it tight if necessary.

- In the rear seat, you may have trouble tightening the lap/shoulder belt on the child restraint because the buckle or latch plate is too close to the belt path opening on the restraint. Disconnect the latch plate from the buckle and twist the short buckle-end belt several times to shorten it. Insert the latch plate into the buckle with the release button facing out.
- If the belt still can't be tightened, or if pulling and pushing on the restraint loosens the belt, disconnect the latch plate from the buckle, turn the buckle around, and insert the latch plate into the buckle again. If you still can't make the child restraint secure, try a different seating position.
- Buckle the child into the seat according to the child restraint manufacturers directions.
- When your child restraint is not in use, secure it in the vehicle with the seat belt or remove it from the vehicle. Do not leave it loose in the vehicle. In a sudden stop or collision, it could strike the occupants or seat backs and cause serious personal injury.

WARNING!

Improper installation can lead to failure of an infant or child restraint. It could come loose in a collision. The child could be badly injured or killed. Follow the manufacturers directions exactly when installing an infant or child restraint.

Lower Anchors and Tether for Children (LATCH)

Each vehicle is equipped with the child restraint anchorage system called LATCH, which stands for Lower Anchors and Tether for Children. LATCH child restraint anchorage systems are installed in the Standard Cab passenger seat position, the Club Cab front passenger and rear outboard right side positions and the Quad Cab rear seat outboard positions and also feature tether strap anchorages, which must be used, located behind the seatback (refer to Child Restraint Tether Anchor later in this section).

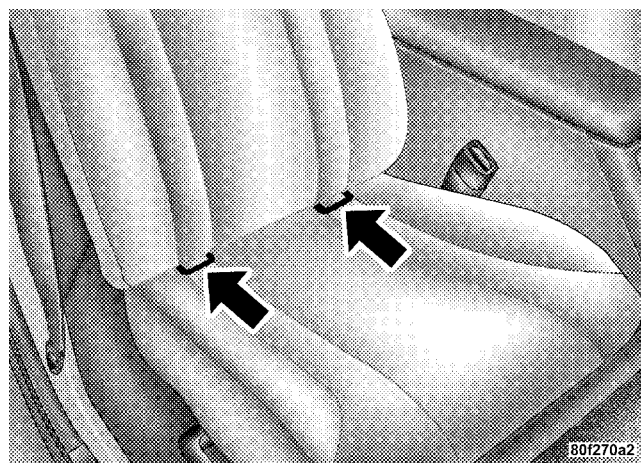

Standard and Club Cab Front Seat

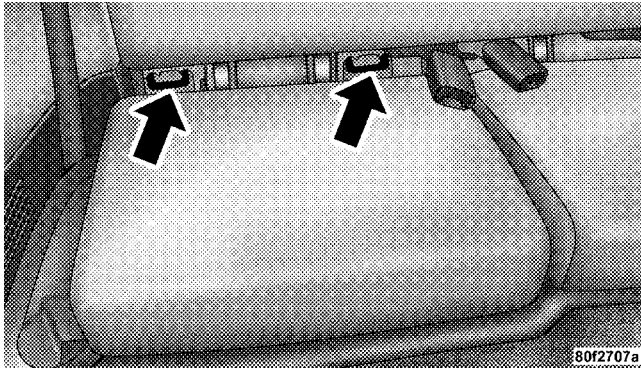

Club Cab Rear Right Seat

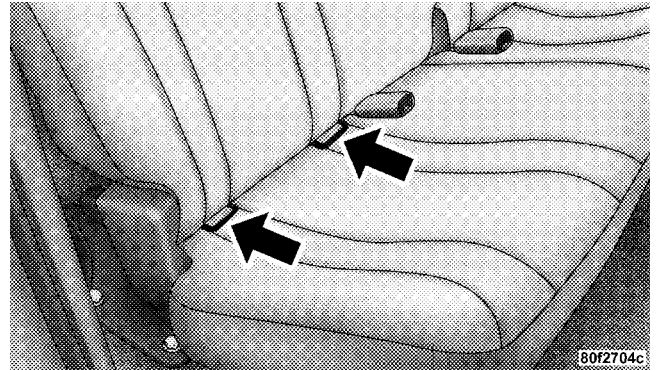

Quad Cab Rear Right Seat

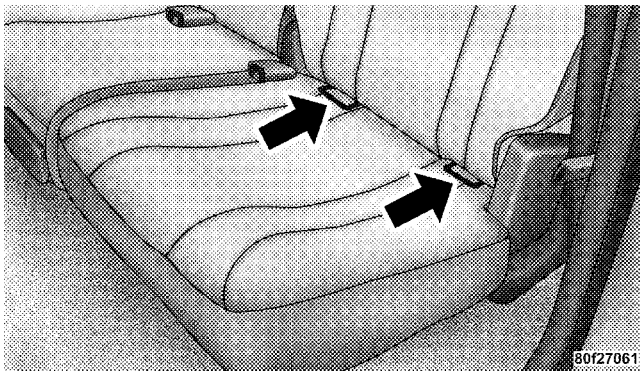

Quad Cab Rear Left Seat

NOTE: For children riding in the front seat of a Standard Cab model refer to the “Passenger Airbag On/Off Switch” located in this section.

Child restraint systems having attachments designed to connect to the lower anchorages are now available. Child restraints having tether straps and hooks for connection to the seatback tether anchorage have been available for some time. In fact, many child restraint manufacturers will provide add-on tether strap kits for some of their older products.

Because the lower anchorages are to be introduced to passenger carrying vehicles over a period of years, child restraint systems having attachments for those anchorages will continue to have features for installation in vehicles using the lap or lap/shoulder belt. They will also have tether straps, and you are urged to take advantage of all of the available attachments provided with your child restraint in any vehicle.

NOTE: If your child restraint seat is not LATCH compatible, install the restraint using the vehicle seat belting.

Installing the Child Restraint System

WARNING!

Do not install child restraint systems equipped with LATCH attachments in the center position of a Quad Cab model rear seat. The LATCH anchorages in this seat are designed for the two outboard seating positions only. A child may be placed in the rear center seating position of a Quad Cab model using the seat belt and child tether anchorage. Failure to follow this may result in serious or fatal injury.

We urge that you carefully follow the directions of the manufacturer when installing your child restraint. Many, but not all, restraint systems will be equipped with separate straps on each side, with each having a hook or connector and a means for adjusting the tension in the strap. Forward-facing toddler restraints and some rearward-facing infant restraints will also be equipped with a tether strap, a hook and means for adjusting the tension in the strap.

In general, you will first loosen the adjusters on the lower straps and tether straps so that you can more easily attach the hook or connector to the lower anchorages and tether anchorages. Then tighten all three straps as you push the child restraint rearward and downward into the seat.

Not all child restraint systems will be installed as we have described here. Again, carefully follow the instructions that come with the child restraint system.

WARNING!

Improper installation of a child restraint to the LATCH anchorages can lead to failure of an infant or child restraint. The child could be badly injured or killed. Follow the manufacturers directions exactly when installing an infant or child restraint.

Child Restraint Tether Anchor

Regular Cab models have two tether anchorages, one behind each passenger seating position (front center and right seat positions). Club Cab and Quad Cab models have three anchorages, one behind each of the rear seat positions (rear left, center, and right seat positions).

WARNING!

With a child restraint installed in the rear driver or passenger side locations, use care when adjusting the front seat(s) rearward, to avoid the front seat back coming in contact with the belted child directly behind the seat. The child could be injured.

WARNING!

Improper installation can lead to failure of an infant or child restraint. It could come loose in a collision. The child could be seriously injured or killed. Make sure the child restraint tether strap is always routed through the proper anchor strap inner loop.

Tether Straps at the Front Passenger's Seat (Regular Cab With All Seats)

1. Route the child restraint tether strap up and over the passenger seat back.
2. Thread the tether strap through the anchor strap inner loop (loop with metal ring), located directly behind the passenger's seat.
3. Route the tether strap across to the anchor strap installed in the center, and attach the tether strap hook to the anchor strap metal ring.

4. Remove the slack in the tether strap so that both anchor straps are pulled tight.

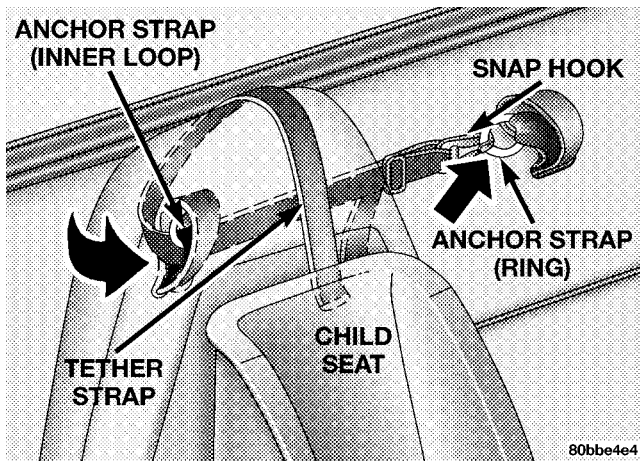

Regular Cab With All Seats

Tether Straps at the Front Center Seat (Regular Cab With Any Bench Seat)

1. Route the child restraint tether strap up and over the center seat back.
2. Thread the tether strap through the anchor strap inner loop (loop with metal ring), located directly behind the center seat.
3. Route the tether strap across to the anchor strap installed directly behind the passenger's seat location, and attach the tether strap hook to the anchor strap metal ring.

4. Remove the slack in the tether strap so that both anchor straps are pulled tight.

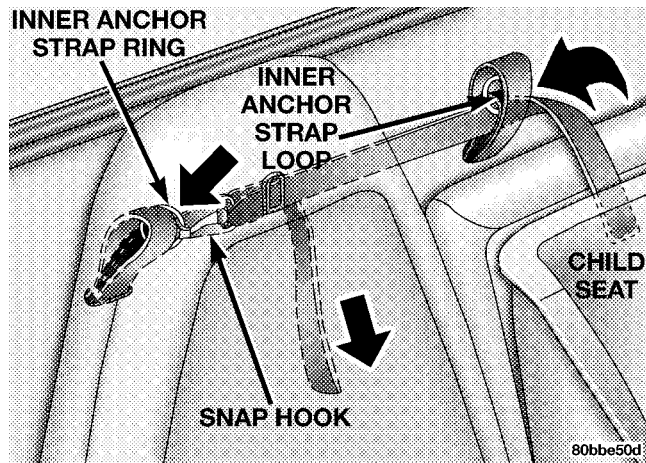

**Regular Cab With Any Bench Seat
Tether Strap at the Front Passenger Seat (Club Cab)**

1. Route the child restraint tether strap up and over the front passenger seat back.
2. Connect the tether strap to the lower anchorage.

3. Remove the slack in the tether strap so that it is pulled tight.

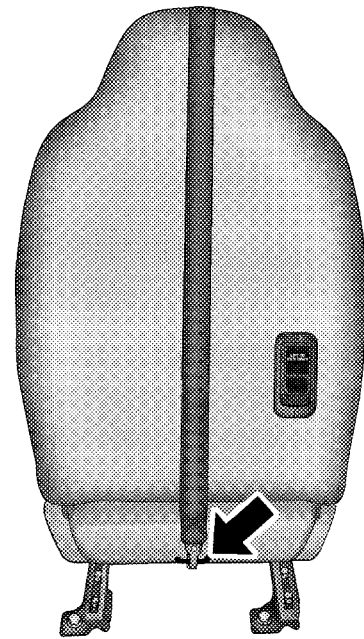

Club Cab Front Passenger Seat

Tether Straps at the Rear Passenger Seat (Club Cab and Quad Cab Rear Seats)

1. Route the child restraint tether strap through the anchor strap inner loop (loop with metal ring attached), located directly behind the child restraint.
2. Route the tether strap across to the next nearest installed anchor strap, and attach the tether strap hook to the anchor strap metal ring.
3. Remove the slack in the tether strap so that both anchor straps are pulled tight.

NOTE: Every Club Cab model has a cab-back panel with a flip-down door (padded bolster). The symbol below is located on this door.

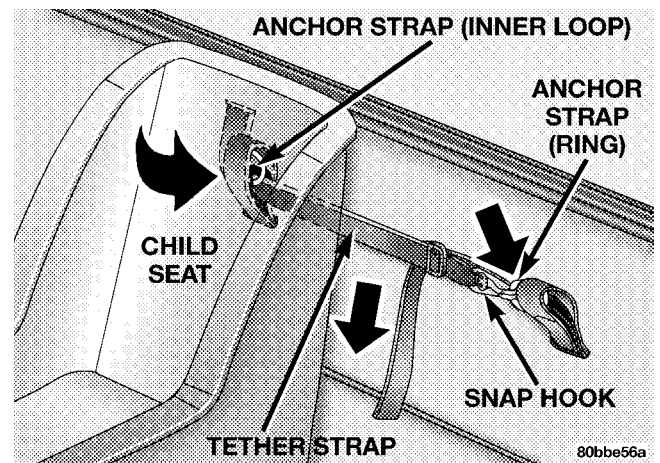

Club/Quad Cab Rear Seat

Multiple Child Restraint Installation Sequence

1. Thread the child restraint tether strap hook through the inner loop, located directly behind the child restraint.
2. After following step 1 for either of the two outer seats, route the tether strap hook to the metal ring on the inner loop behind the center seat and attach the hook to the metal ring.

3. After following step 1 for the center child restraint, route the tether strap hook to the metal ring on the inner loop, located behind the passenger's seat. Attach the tether strap hook to the metal ring

NOTE: Two Anchors must be used for either of the three seating positions.

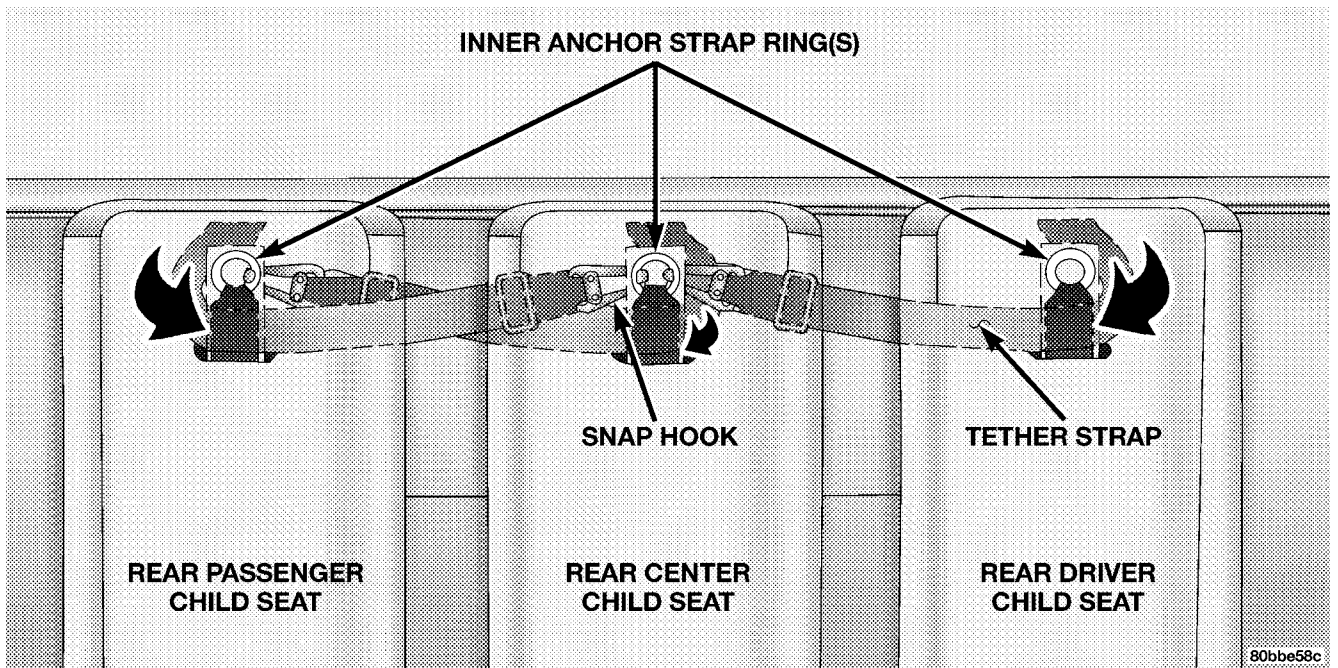

Multiple Child Restraint

80bbe58c

WARNING!

An incorrectly anchored tether strap could lead to seat failure and injury to the child. In a collision, the seat could come loose and allow the child to crash into the inside of the vehicle or other passengers, or even be thrown from the vehicle. Use only the anchor positions directly behind the child restraint to secure a child restraint top tether strap. See your dealer for help if necessary.

Children Too Large for Booster Seats

Children who are large enough to wear the shoulder belt comfortably, and whose legs are long enough to bend over the front of the seat when their back is against the seat back should use the lap/shoulder belt in a rear seat.

- Make sure that the child is upright in the seat.
- The lap portion should be low on the hips and as snug as possible.
- Check belt fit periodically. A child's squirming or slouching can move the belt out of position.

If the shoulder belt contacts the face or neck, move the child closer to the center of the vehicle. If this doesn't help, move the child to the center rear seating position and use the lap belt. Never allow a child to put the shoulder belt under an arm or behind their back.

ENGINE BREAK-IN RECOMMENDATIONS

A long break-in period is not required for the engine in your new vehicle. Drive moderately during the first 300 miles (500 km). After the initial 60 miles (100 km), speeds up to 50 or 55 mph (80 or 90 km/h) are desirable. While cruising, brief full-throttle acceleration, within the limits of local traffic laws, contributes to a good break-in.

Avoid wide open throttle acceleration in low gear.

The engine oil installed in the engine at the factory is a high-quality, energy-conserving type lubricant. Oil changes should be consistent with anticipated climate conditions under which vehicle operations will occur. The recommended viscosity and quality grades are shown in Section 7.

NON-DETERGENT OR STRAIGHT MINERAL OILS MUST NEVER BE USED.

A new engine may consume some oil during its first few thousand miles of operation. This is a normal part of the break-in and is not an indication of difficulty.

SAFETY TIPS

Exhaust System

WARNING!

Exhaust gases contain carbon monoxide, an extremely toxic gas that by itself is colorless and odorless. To avoid inhaling these gases, the following precautions should be observed:

- Do not run the engine in a closed garage or in confined areas any longer than needed to move your vehicle in or out of the area.
- It may be necessary to sit in a parked vehicle with the engine running for more than a short period. If so, adjust your climate control system to force outside air into the vehicle. Set the blower at high speed and the controls in any position except OFF or RECIRC.

- The best protection against carbon monoxide entry into the vehicle body is a properly maintained engine exhaust system.

Be aware of changes in the sound of the exhaust system; exhaust fumes detected inside the vehicle; or damage to the underside or rear of the vehicle. Have a competent mechanic inspect the complete exhaust system and adjacent body areas for broken, damaged, deteriorated or mispositioned parts. Open seams or loose connections could permit exhaust fumes to seep into the passenger compartment. In addition, inspect the exhaust system each time the vehicle is raised for lubrication or oil change. Replace or adjust as required.

Safety Checks You Should Make Inside The Vehicle

Seat Belts

Inspect the belt system periodically, checking for cuts, frays and loose parts. Damaged parts must be replaced immediately. Do not disassemble or modify the system.

Seat belt assemblies must be replaced after an accident if they have been damaged (bent retractor, torn webbing, etc.). If there is any question regarding belt or retractor condition, replace the belt.

Defrosters

Check operation by selecting the defrost mode and place the blower control on high speed. You can feel the air directed against the windshield.

Safety Checks You Should Make Outside The Vehicle:

Tires

Examine tires for tread wear or uneven wear patterns. Check for stones, nails, glass or other objects lodged in the tread.

Inspect for tread cuts or sidewall cracks. Check wheel nuts for tightness and tires for proper pressure.

Lights

Have someone observe the operation of exterior lights as you turn them on. Check turn signal and high beam indicator lights on the instrument panel.

Door Latches

Check for positive closing, latching and locking.

Fluid Leaks

Check the area under vehicle after overnight parking for fuel, water, oil, or other fluid leaks. Also, if gasoline fumes are detected, the cause should be located and corrected.

UNDERSTANDING THE FEATURES OF YOUR VEHICLE

CONTENTS

■ Mirrors58	□ Lumbar Support Adjustment — Power Seats Only63
□ Inside Day/Night Mirror58	□ Seatback Releases — Bench Seat63
□ Automatic Dimming Mirror— If Equipped59	□ Seatback Releases—Bucket And Split Bench64
□ Outside Mirrors59	□ Club Cab Easy Entry System64
□ Exterior Mirrors Folding Feature59	□ Club Cab/Quad Cab Rear Seat65
□ Electric Remote-Control Mirrors60	■ To Open And Close The Hood66
□ Heated Mirrors — If Equipped61	■ Lights67
■ Seats61	□ Interior Lights67
□ Seat Adjustment61	□ Battery Saver68
□ Reclining Seats62	□ Headlamp Delay68
□ 6 - Way Power Seat Adjuster — Driver's Side Only63	□ Headlights, Parking Lights, Panel Lights68

56 UNDERSTANDING THE FEATURES OF YOUR VEHICLE

□ Daytime Running Lights (Canada Only)69	□ To Vary The Speed Setting75
□ Lights-On Reminder69	□ To Accelerate For Passing75
□ Fog Lights — If Equipped69	■ Overhead Console76
□ Cargo Light — If Equipped70	□ Courtesy/Reading Lights76
■ Multifunction Control Lever70	■ Compass/Temperature Mini-Trip Computer77
□ Turn Signals70	□ US/M Button77
□ Passing Light70	□ Reset Button77
□ High Beam / Low Beam Select Switch71	□ Global Reset77
□ Windshield Wipers71	□ Step Button78
□ Windshield Washers72	□ Average Fuel Economy (AVG ECO)78
■ Tilt Steering Column — If Equipped73	□ Distance To Empty (DTE)78
■ Electronic Speed Control — If Equipped74	□ Trip Odometer (ODO)78
□ To Activate74	□ Elapsed Time (ET)78
□ To Set At A Desired Speed74	□ C/T Button79
□ To Deactivate74	□ Compass/Temperature Display79
□ To Resume Speed75	□ Automatic Compass Calibration79

UNDERSTANDING THE FEATURES OF YOUR VEHICLE 57

□ Manual Compass Calibration80	■ Floor Console — If Equipped88
□ Outside Temperature81	□ Floor Console Features88
■ Garage Door Opener81	■ Center Storage Compartment — If Equipped . .	.89
□ Programming Homelink82	■ Cup Holders89
□ Canadian Programming/Gate Programming . .	.84	■ Tailgate90
□ Using Homelink85	■ Slide-In Campers90
□ Erasing Homelink Buttons85	□ Camper Applications90
□ Reprogramming a Single Homelink Button85	□ General Information91
□ Security85	□ Carbon Monoxide Warning Vehicles Equipped With A Cap Or Slide-In Campers91
■ Electrical Power Outlets — If Equipped86		
□ Electrical Outlet Use With Engine Off87		

MIRRORS

Inside Day/Night Mirror

The mirror should be adjusted to center on the view through the rear window. A two-point pivot system allows for horizontal and vertical adjustment of the mirror.

Annoying headlight glare can be reduced by moving the small control under the mirror to the night position (toward rear of truck). The mirror should be adjusted while set in the day position (toward windshield).

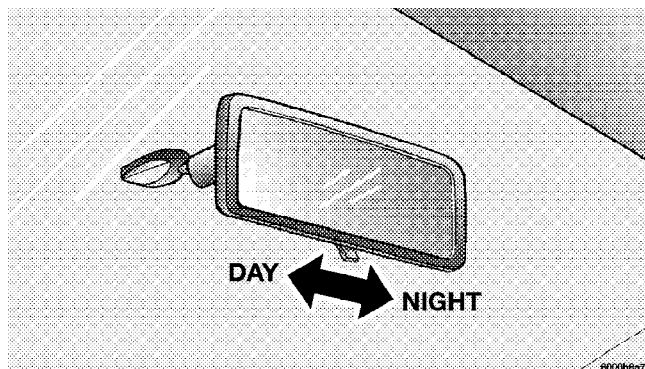

Automatic Dimming Mirror— If Equipped

This mirror will automatically adjust for annoying headlight glare from vehicles behind you. You can turn the feature on or off by pressing the button at the base of the mirror. A light in the button will indicate when the dimming feature is activated.

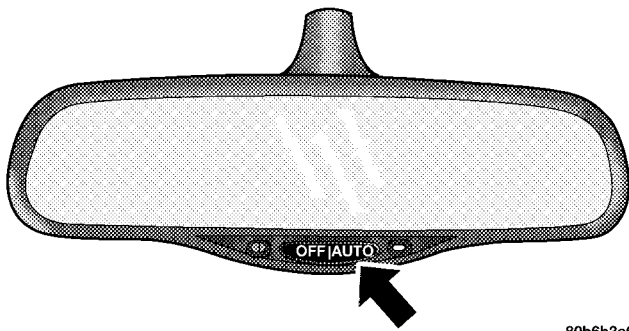
**CAUTION!**

To avoid damage to the mirror during cleaning, never spray any cleaning solution directly onto the mirror. Apply the solution onto a clean cloth and wipe the mirror clean.

3

Outside Mirrors

To receive maximum benefit, adjust the outside mirror(s) to center on the adjacent lane of traffic with a slight overlap of the view obtained on the inside mirror.

Exterior Mirrors Folding Feature

Folding exterior mirrors are hinged and may be moved either forward or rearward to resist damage. The hinges have three detent positions; full forward, full rearward, and normal.

Electric Remote-Control Mirrors

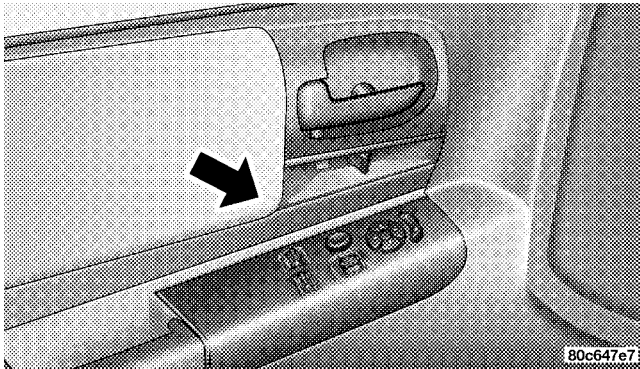

The controls for the power mirrors are located on the driver's door trim panel.

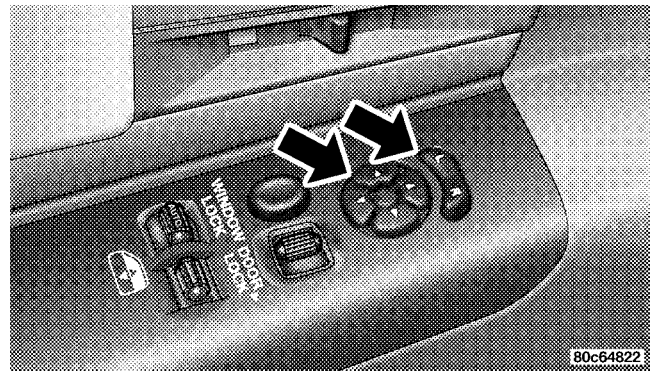

Set the top switch to the left or right for the left or right mirror, and set it to the center off position to prevent accidentally moving a mirror when you are finished adjusting the mirror. To adjust a mirror, select left or right with the top switch, and press one of the four arrows for the direction you want the mirror to move.

WARNING!

Vehicles and other objects seen in the right side convex mirror will look smaller and farther away than they really are. Relying too much on your right side mirror could cause you to collide with another vehicle or other object. Use your inside mirror when judging the size or distance of a vehicle seen in the right side mirror.

Heated Mirrors — If Equipped

Heated mirrors are automatically activated when you depress the rear window defroster switch located on the instrument panel. The light will illuminate to indicate that the heating elements are ON. Turning OFF the ignition will deactivate the heated mirrors.

SEATS**Seat Adjustment**

The adjusting lever is at the front of the seat, near the floor. Lift the lever and move the seat to the desired position.

Using body pressure, move forward and rearward on the seat to be sure the seat adjusters have latched.

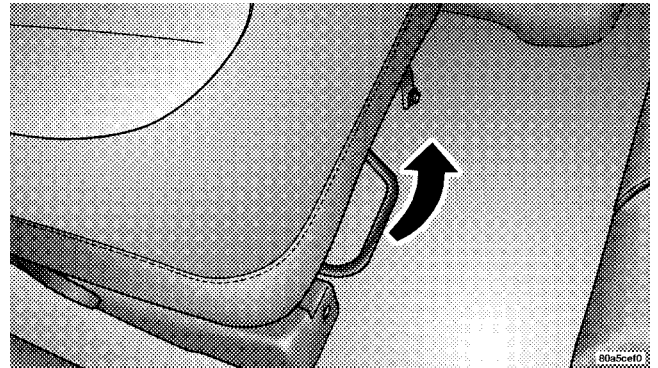

WARNING!

Adjusting a seat while the vehicle is moving is dangerous. The sudden movement of the seat could cause you to lose control. The seat belt might not be properly adjusted and you could be injured. Adjust any seat only while the vehicle is parked.

Reclining Seats

Both the bucket seats and the split-bench seats are equipped with recliners. The reclining mechanism is operated by a control located on the outboard side of the seat. To recline, lean forward slightly before lifting the lever, then push back to the desired angle and release the lever. Lean forward and lift the lever to return the seatback to its normal position.

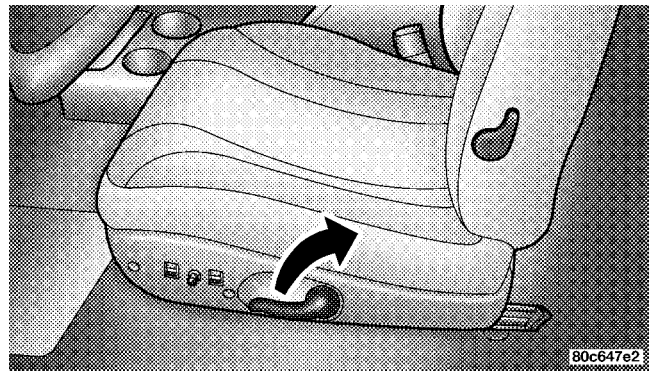
**WARNING!**

Do not ride with the seatback reclined so that the shoulder belt is no longer resting against your chest. In a collision you could slide under the seat belt and be seriously or even fatally injured. Use the recliner only when the vehicle is parked.

6 - Way Power Seat Adjuster — Driver’s Side Only

The 6-way power seat adjuster switch is on the outboard side of the driver’s seat. Use this switch to move the seat up or down, forward or rearward, recline or tilt.

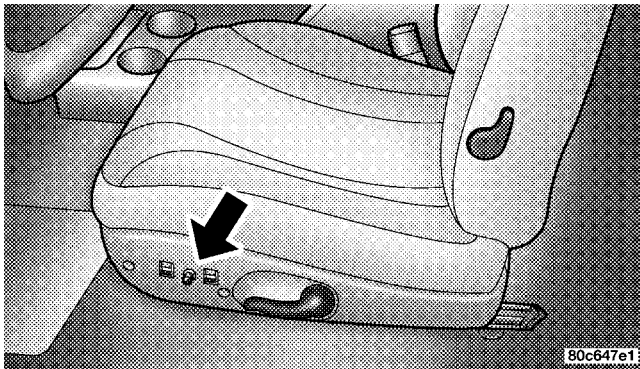

Lumbar Support Adjustment — Power Seats Only

Vehicles equipped with the power bucket seat or the 40/20/40 split bench power are equipped with an adjustable lumbar support on the driver’s seat. Rotating the lever on the left side of the driver’s seatback increases or decreases the lumbar support.

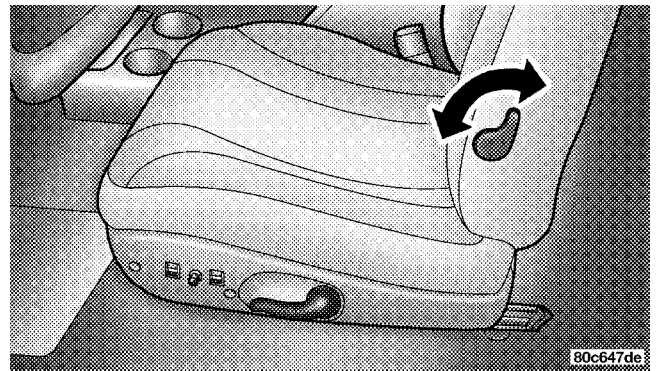

Seatback Releases — Bench Seat

The seatback is equipped with inertia latching mechanisms that automatically lock and prevent the seatback from folding forward during periods of high deceleration, such as hard braking.

This type of latch mechanism eliminates the need to actuate a release lever to fold the seat forward. In some situations, such as when parked on a steep hill, the inertia latch may lock and manual release of the lock will be necessary.

Seatback Releases—Bucket And Split Bench

Both seats have a position latch release. To release the seatback if you are on the outside of the vehicle, lift up on the recliner lever located on the outboard side of the seat. From the rear seat, lift the lever located on the rear of the seatback.

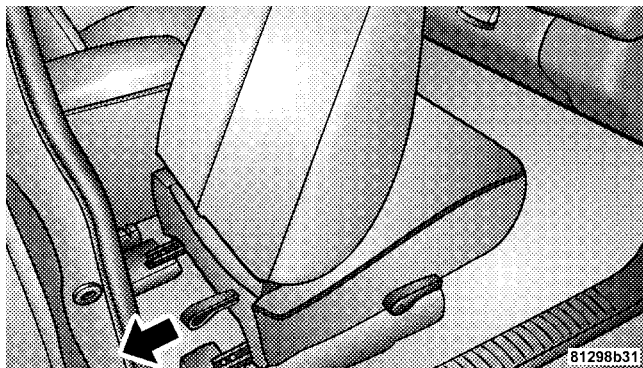
Club Cab Easy Entry System

To allow easier access to the rear seat, the front passenger seat will move to its full forward position when the seatback is folded down. To fold the seatback forward if you are on the outside of the vehicle, lift up on the

recliner lever located on the outboard side of the seat. From the rear seat, pull the cloth pull-tab located on the rear or the seat cushion rearward until the latch releases, and then push the seat forward. The seat will lock in place when the back is returned to an upright position and will need to be reset. However, the seat may be slid rearward before returning the seatback to the upright position to minimize the amount of readjustment required.

NOTE: Power seats are available with the Club or Quad Cab models only.

CAUTION!

When operating the folding front seat, use care in repositioning seat to its normal position. This will prevent shoulder belt harness from being caught behind seat or tangled in the seatback latching mechanism.

WARNING!

It is extremely dangerous to ride in a cargo area, inside or outside of a vehicle. In a collision, people riding in these areas are more likely to be seriously injured or killed.

Do not allow people to ride in any area of your vehicle that is not equipped with seats and seat belts.

Be sure everyone in your vehicle is in a seat and using a seat belt properly.

Club Cab/Quad Cab Rear Seat

More cargo space is available by lifting up on the rear seat cushion.

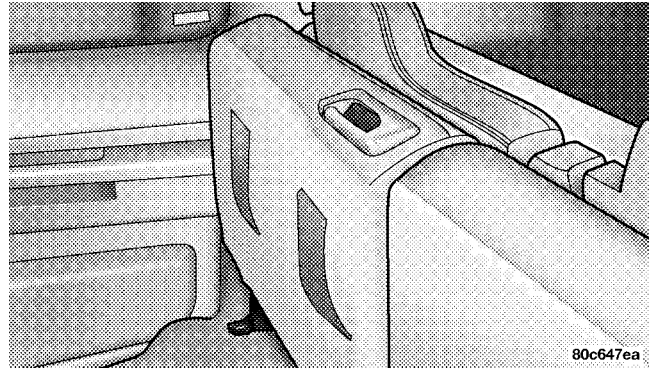

The Club Cab/Quad Cab rear seat is a 60/40 split cushion and full back. Either cushion can be raised independently.

TO OPEN AND CLOSE THE HOOD

To open the hood, two latches must be released. First pull the hood release lever located under the left side of the instrument panel.

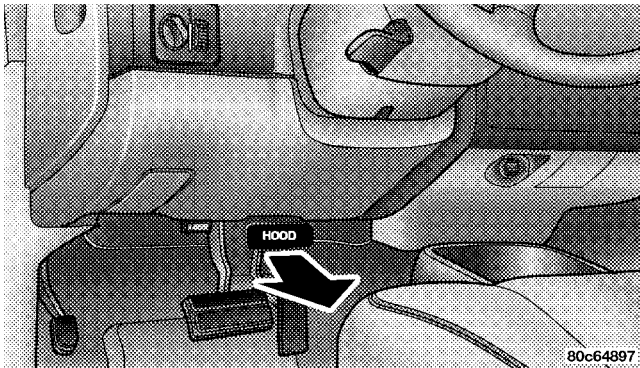

Second, locate the hood safety latch lever between the front grille openings to the left of center. Push this lever to the right to release the hood.

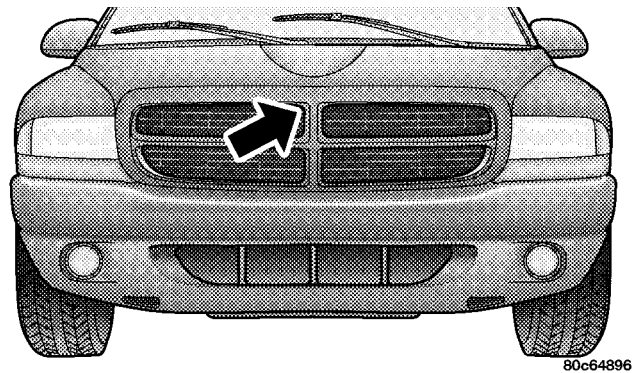

To prevent possible damage, do not slam the hood to close it. Use a firm downward push at the center of the hood to ensure that both latches engage. Never drive your vehicle unless the hood is fully closed, with both latches engaged.

WARNING!

If the hood is not fully latched, it could fly up when the vehicle is moving and block your forward vision. Be sure all hood latches are fully latched before driving.

LIGHTS

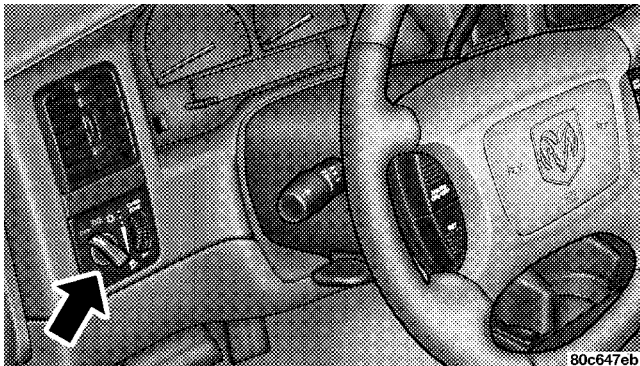

Interior Lights

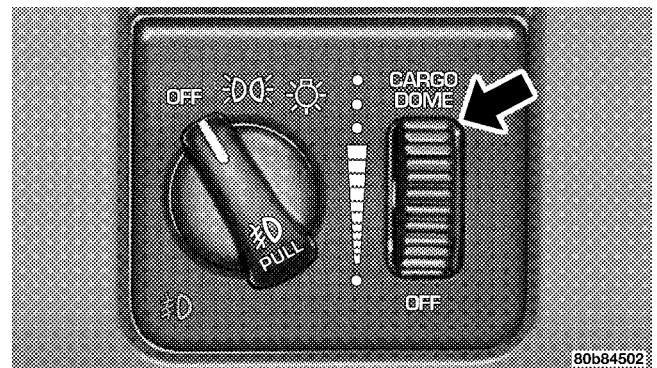

3

Courtesy and dome lights are turned on when the front doors are opened, when the dimmer control (rotating wheel on the right side of the switch) is rotated to the second upward detent position, or if equipped, when the UNLOCK button is pressed on the key fob. Rotating the dimmer control to the optional fully upward position will turn on the cargo light located on the back of the cab. When a door is open and the interior lights are on, rotating the dimmer control all the way down to the OFF detent will cause all the interior lights to go out. This is

also known as the "Party" mode because it allows the doors to stay open for extended periods of time without discharging the vehicle's battery.

The brightness of the instrument panel lighting can be regulated by rotating the dimmer control up (brighter) or down (dimmer). When the headlights are ON you can supplement the brightness of the odometer, trip odometer, radio and overhead console by rotating the control up until you hear a click. This feature is termed the "Parade" mode and is useful when headlights are required during the day.

Club Cab/Quad Cab models may have an optional switched dome lamp that may be operated by pressing the lens.

Battery Saver

To protect the life of your vehicle's battery, Load Shedding is provided for both the interior and exterior lights.

If the ignition is off and any door is left ajar for 15 minutes or the dimmer control is rotated upwards for 15 minutes, the interior lights will automatically turn off.

If the headlamps remain on while the ignition is cycled off, the exterior lights will automatically turn off after 5 minutes. If the headlamps are turned on and left on for 15 minutes while the ignition is off, the exterior lights will automatically turn off.

NOTE: Battery Saver mode is cancelled if the ignition is ON.

Headlamp Delay

To aid in your exit, your vehicle is equipped with a headlamp delay that will leave the headlamps on for 60 seconds. This delay is initiated when the ignition is turned OFF while the headlamp switch is on, and then the headlamp switch is cycled off. The headlamps will remain on for 60 seconds. Headlamp delay can be cancelled by either turning the headlamp switch ON then OFF or by turning the ignition ON.

Headlights, Parking Lights, Panel Lights



When the headlight switch is rotated to the first position, the parking lights, taillights, side marker lights, license plate light and instrument panel lights are all turned on. The headlights will turn ON when the switch is rotated to the second position.

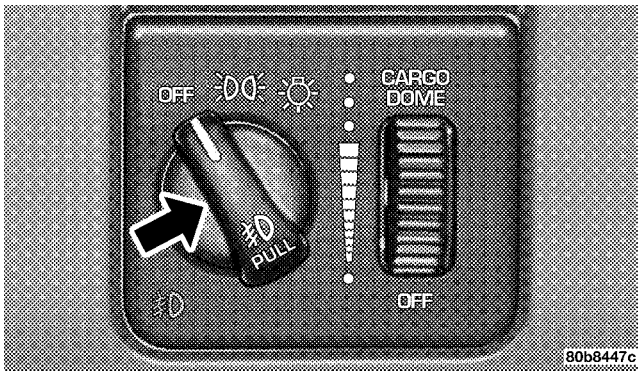

Your vehicle is equipped with plastic headlight lenses that are lighter and less susceptible to stone breakage than glass headlights.

Plastic is not as scratch resistant as glass and therefore different lens cleaning procedures must be followed.

To minimize the possibility of scratching the lenses and reducing light output, avoid wiping with a dry cloth. To remove road dirt, wash with a mild soap solution followed by rinsing.

Do not use abrasive cleaning components, solvents, steel wool or other abrasive materials to clean the lenses.

Daytime Running Lights (Canada Only)

The headlights on your vehicle will illuminate when the engine is started. This provides a constant "Lights ON" condition until the ignition is turned OFF. The lights illuminate at less than 50% of normal intensity. If the parking brake is applied the Daytime Running Lights will turn off.

Lights-on Reminder

If the headlights, parking lights, courtesy lights or cargo lights are left on, after the ignition is turned off, a chime will sound when the driver's door is opened.

Fog Lights — If Equipped

The foglights are turned ON by placing the headlight rotary control in the parking light or headlight position and pulling out the headlight rotary control. The fog lights will operate only when the parking lights are ON or when the vehicle headlights are ON low beam. An indicator light located left of the switch will illuminate when the fog lights are on. The fog lights will turn off

when the switch is pressed in, when the headlight switch is rotated to the OFF position or the high beam is selected.

CARGO Light — If Equipped

The cargo lights are turned on by rotating the dimmer control to the optional fully upward position. The interior lights will also turn on when the cargo lights are on. The cargo lights will also turn on for 30 seconds when a key fob Unlock is pressed, as part of the illuminated entry feature.

MULTIFUNCTION CONTROL LEVER

The multifunction control lever is located on the left side of the steering column.

Turn Signals

Move the lever up or down to signal a right-hand or left-hand turn.

The arrow on either side of the instrument cluster flashes to indicate the direction of the turn, and proper operation of the front and rear turn signal lights. If either indicator flashes at a faster rate, check for a defective outside light

bulb. If an indicator fails to light when the lever is moved, it would suggest that the fuse or indicator bulb is defective.

You can signal a lane change by moving the lever partially up or down.

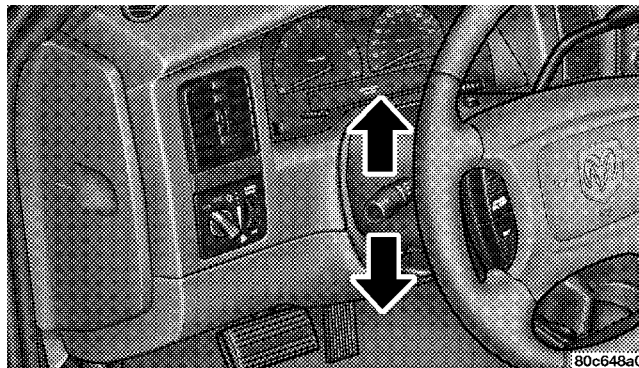

Passing Light

You can signal another vehicle with your headlights by partially pulling the multifunction lever toward the steering wheel. This will cause the high beam headlights to turn on until the lever is released.

High Beam / Low Beam Select Switch

Pull the multifunction control lever fully toward the steering wheel to switch the headlights from HIGH or LOW beam.

Windshield Wipers

The wipers and washers are operated by a switch in the multifunction control lever. Turn the end of the handle to select the desired wiper speed.

NOTE: In cold weather, always turn off the wiper switch and allow the wipers to return to the park position before turning off the engine. If the wiper switch is left on and the wipers freeze to the windshield, damage to the wiper motor may occur when the vehicle is restarted.

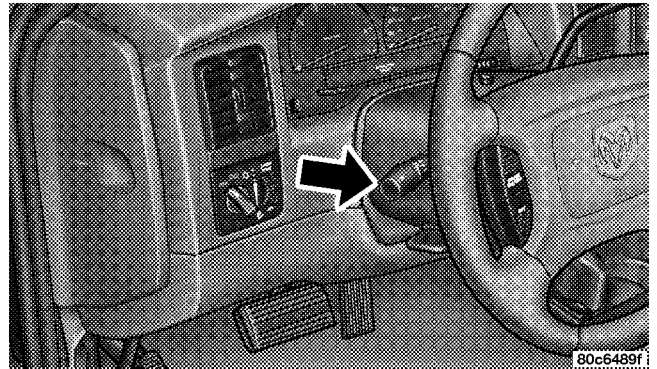
Intermittent Wiper System

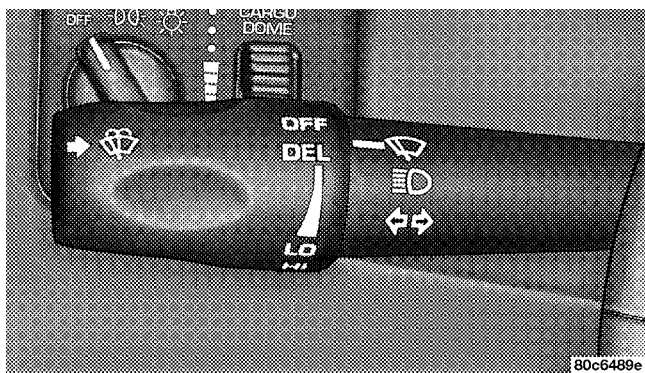

The intermittent feature of this system was designed for use when weather conditions make a single wiping cycle, with a variable pause between cycles, desirable. For maximum delay between cycles, rotate the control knob into the upper end of the delay range.

The delay interval decreases as you rotate the knob until it enters the LO continual speed position. The delay can be regulated from a maximum of about 15 seconds between cycles, to a cycle every 2 seconds.

WARNING!

Sudden loss of visibility through the windshield could lead to an accident. You might not see other vehicles or other obstacles. To avoid sudden icing of the windshield during freezing weather, warm the windshield with defroster before and during windshield washer use.

Speed-Sensitive Intermittent Wipe — If Equipped

For vehicles equipped with Speed-Sensitive Intermittent Wipe, if the vehicle is moving at a speed of less than 10 mph (16 km/h), the delay time between wipes will be doubled, resulting in a longer time between wipes (1–36 seconds).

Windshield Washers

To use the washer, push in on the knob on the end of the multifunction control lever and hold while spray is desired. If the knob is depressed while in the delay range, the wiper will operate for several seconds after the knob is released. It will then resume the intermittent interval

previously selected. If the knob is pushed while in the OFF position, the wiper will wipe approximately three wipes, after the wash knob is released.

To prevent freeze-up of your windshield washer system in cold weather, select a solution or mixture that meets or exceeds the temperature range of your climate. This rating information can be found on most washer fluid containers.

TILT STEERING COLUMN — IF EQUIPPED

To tilt the column, push down on the lever below the turn signal control and move the wheel up or down, as desired. Push the level back up to lock the column firmly in place.

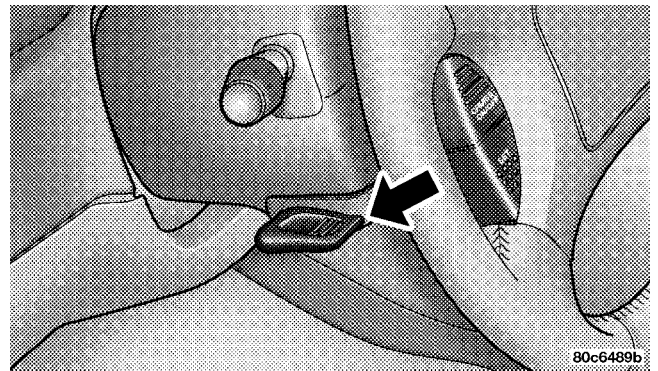

WARNING!

Tilting the steering column while the vehicle is moving is dangerous. Without a stable steering column, you could lose control of the vehicle and have an accident. Adjust the column only while the vehicle is stopped. Be sure it is locked before driving.

ELECTRONIC SPEED CONTROL — IF EQUIPPED

When engaged, this device takes over accelerator operation at speeds greater than 35 mph (56 km/h). The controls are mounted on the steering wheel.

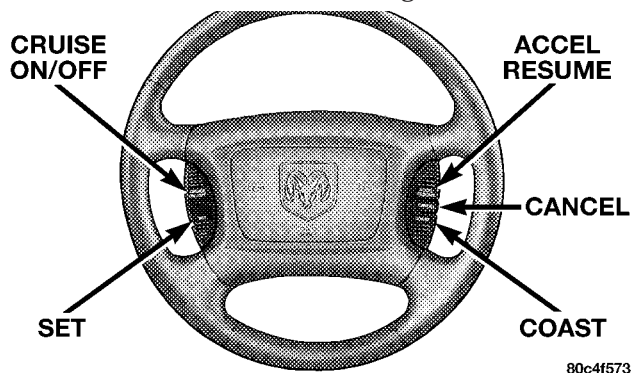

80c4f573

To Activate

Push the ON/OFF button to the ON position. An indicator light in the instrument cluster illuminates when the system is on.

To Set At A Desired Speed

When the vehicle has reached the desired speed, press and release the SET button. Release the accelerator and the vehicle will operate at the selected speed.

To Deactivate

A soft tap on the brake pedal, normal braking, clutch pressure while slowing the vehicle, or pressing the CANCEL button will deactivate speed control without erasing the memory. Pushing the ON/OFF button to the OFF position or turning off the ignition erases the memory.

WARNING!

Leaving the Speed Control ON when not in use is dangerous. You could accidentally set the system to cause it to go faster than you want. You could lose control and have an accident. Always leave the system OFF when you aren't using it.

To Resume Speed

To resume a previously set speed, push and release the RESUME button. Resume can be used at any speed above 50 km/h (30 mph).

To Vary The Speed Setting

When the speed control is on, speed can be increased by pressing and holding the ACCEL button. When the button is released, a new set speed will be established.

Tapping the ACCEL button once will result in a 2 mph (3.2 km/h) speed increase. Each time the button is tapped, speed increases so that tapping the button three times will increase speed by 6 mph (9.6 km/h), etc.

Tapping the COAST button once will result in a 1 mph (1.6 km/h) speed decrease. Each time the button is tapped, speed will decrease. For example, tapping the button 3 times will decrease the speed by 3 mph (4.8 km/h), etc.

To decrease speed while the speed control is on, press and hold the COAST button. Release the button when the desired speed is reached, and the new speed will be set.

To Accelerate For Passing

Depress the accelerator as you would normally. When the pedal is released, the vehicle will return to the set speed.

NOTE: When driving uphill, at elevations above 2,000 feet (610 Meters), or when the vehicle is heavily loaded (especially when towing) the vehicle may slow below the SET speed. If the vehicle speed drops below 30 mph (48 km/h), the speed control will automatically disengage. If this happens, you can push down on the accelerator pedal to maintain the desired speed.

Vehicles equipped with a 5-speed manual transmission should be operated in 4th gear under the above conditions.

Vehicles equipped with a 4-speed automatic transmission may exhibit several 4-3 downshifts under the above conditions. To reduce the frequency of the downshifts and to improve vehicle performance, it is advisable to lock out overdrive by pressing the O/D OFF button located at the end of the gear shifter.

WARNING!

Speed Control can be dangerous where the system can't maintain a constant speed. Your vehicle could go too fast for the conditions, and you could lose control. An accident could be the result. Don't use Speed Control in heavy traffic or on roads that are winding, icy, snow-covered, or slippery.

- Courtesy Lights
- Garage Door Opener — If Equipped
- Mini-Trip Computer — If Equipped

Courtesy/Reading Lights

Near the front of the console are two courtesy/reading lights.

Both lights illuminate as courtesy lights when a door is opened, when the dimmer control is rotated to the courtesy light position (fully upward position), or when the UNLOCK button is pressed on the Remote Keyless Entry transmitter, if so equipped. These lights are also operated individually as reading lights by pressing the recessed area of the corresponding lens.

NOTE: The courtesy/reading lights will remain on until the switch is pressed a second time, so be sure they have been turned off before leaving the vehicle.

OVERHEAD CONSOLE

The overhead console has the following features:

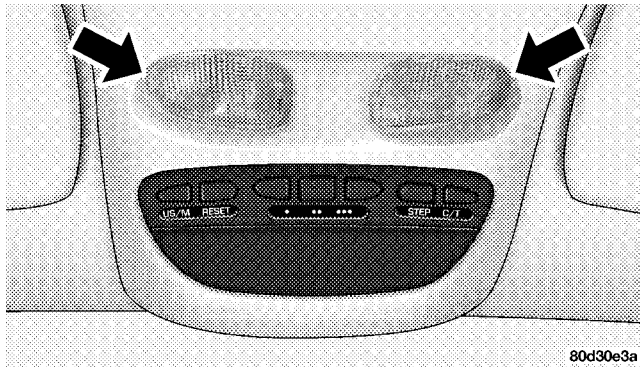

COMPASS/TEMPERATURE MINI-TRIP COMPUTER

This feature allows you to choose between a compass/temperature display and one of five trip conditions being monitored.

US/M Button

Use this button to change the display from U.S. to metric measurement units.

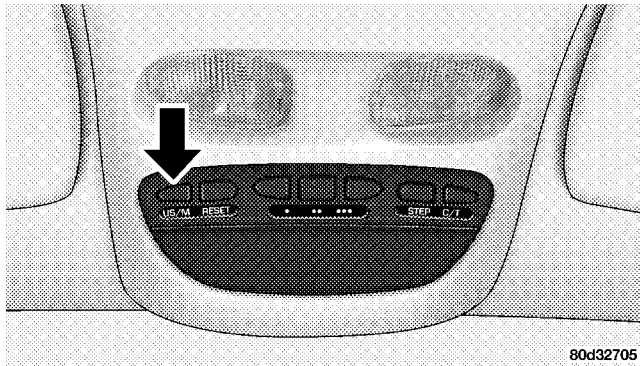

80d32705

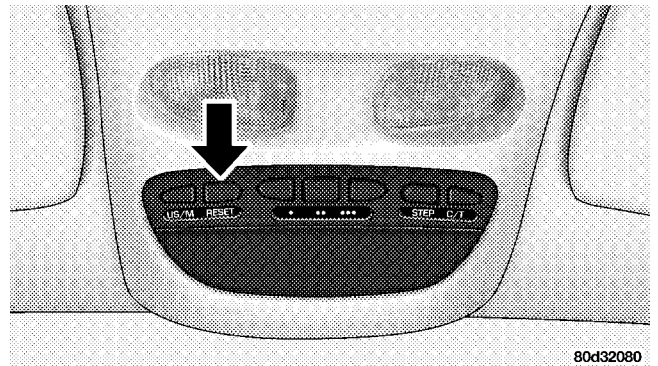
RESET Button

80d32080

Use this button to reset the following displays to zero:
 Average Fuel Economy
 Trip Odometer
 Elapsed time.

Global Reset

If the RESET button is pressed twice within 3 seconds while in any of the 3 resettable displays, the Global Reset will reset all 3 displays.

Step Button

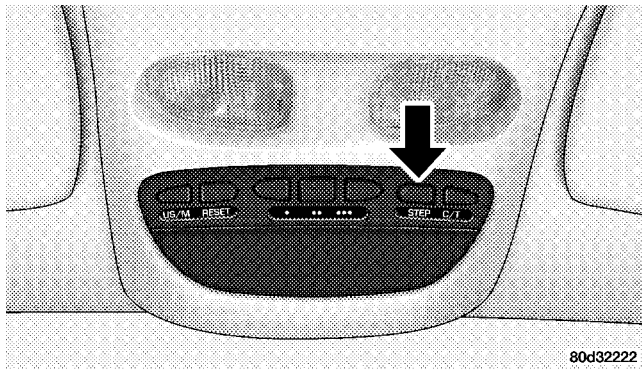

Use this button to choose or cycle through the four trip conditions.

Average Fuel Economy (AVG ECO)

This display shows the average fuel economy since the last reset.

Distance To Empty (DTE)

This display shows the estimated distance that can be traveled with the fuel remaining in the tank. The distance is calculated by multiplying the amount of fuel remaining by the projected fuel economy. The distance predicted will change every few seconds to a higher or lower number as these factors change. The DTE will read zero when the fuel gauge reads "E."

This display cannot be reset.

Trip Odometer (ODO)

This display shows the distance traveled since the last reset.

Elapsed Time (ET)

This display shows the accumulated ignition ON time since the last reset.

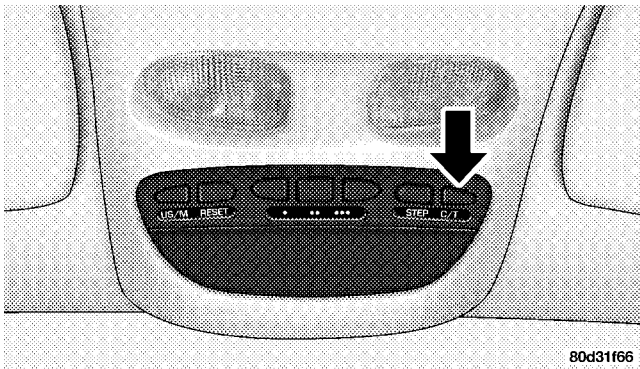
C/T Button

Use this button to select a readout of the outside temperature and one of eight compass headings that indicate the direction in which the vehicle is facing.

Compass/Temperature Display

This display provides the outside temperature and one of eight compass readings to indicate the direction the vehicle is facing.

WARNING!

Even if the display still reads a few degrees above 32°F (0°C), the road surface may be icy, particularly in woods or on bridges. Drive carefully under such conditions to prevent an accident and possible personal injury or property damage.

3

Automatic Compass Calibration

The self calibrating feature of the compass eliminates the need to calibrate the compass for normal conditions. During a short initial period, the compass may appear erratic and the CAL symbol will appear on the display. The CAL symbol may also appear after the vehicle is subjected to a high level of magnetism. While completing three 360° turns at about 5 mph (8 km/h) in an area free from large metal or metallic objects, the CAL symbol will turn off and the compass will function normally.

Manual Compass Calibration

If the compass appears erratic and the CAL light does not appear, you must calibrate the compass. Find an open area away from large metal objects. With the ignition ON and the compass/temperature displayed, press and hold the RESET button until the CAL symbol appears (about 10 seconds). Drive slowly, about 5 mph (8 km/h), in 3 complete 360° circles. The CAL light will turn off and the compass will be calibrated.

Variance is the difference between magnetic North and geographic North. For proper compass function, the correct variance zone must be set. Refer to the variance map for the correct variance zone. To check the variance zone, the ignition must be on and the compass/temperature displayed. Press and hold the RESET button for about 5 seconds until VAR appears in the display. The number displayed is the variance zone used by the compass. To change the zone, press the STEP button to scroll through numbers 1 through 15. Press the RESET button after selecting the proper zone to return to the normal compass/temperature display.

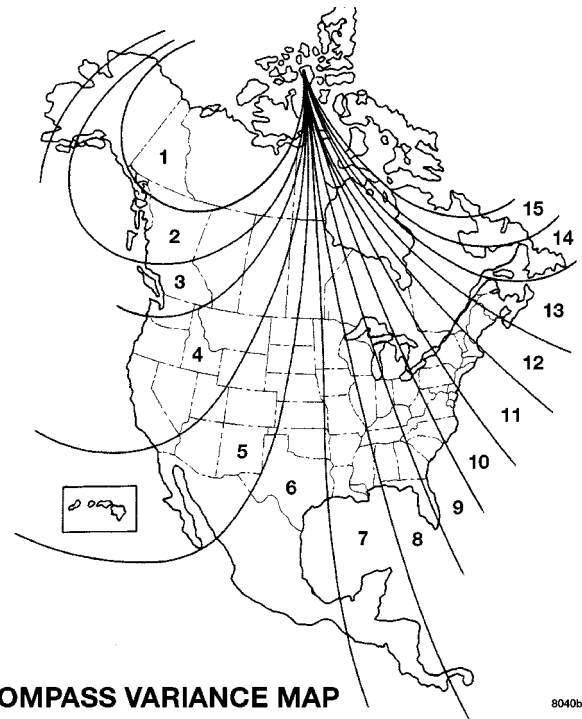

Outside Temperature

Because engine temperature can increase the displayed temperature, temperature readings are slowly updated when vehicle speed is below 20 mph (30 km/h).

GARAGE DOOR OPENER

The HomeLink® Universal Transceiver replaces up to three remote controls (hand held transmitters) that operate devices such as garage door openers, motorized gates, or home lighting. It triggers these devices at the push of a button. The Universal Transceiver operates off your vehicle's battery and charging system; no batteries are needed.

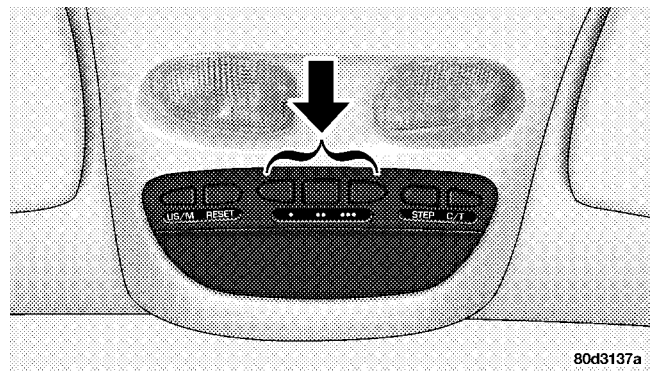

For additional information on HomeLink®, call 1-800-355-3515, or on the internet at www.homelink.com.

WARNING!

A moving garage door can cause injury to people and pets in the path of the door. People or pets could be seriously or fatally injured. Only use this transceiver with a garage door opener that has a “stop and reverse” feature as required by federal safety standards. This includes most garage door opener models manufactured after 1982. Do not use a garage door opener without these safety features it could cause injury or death. Call toll-free 1-800-355-3515 or, on the Internet at www.homelink.com for safety information or assistance.

Programming HomeLink

NOTE: When programming a garage door opener, it is advised to park outside the garage. It is also recommended that a new battery be placed in the hand-held transmitter of the device being programmed to HomeLink for quicker training and accurate transmission of the radio-frequency signal.

1. Press and hold the two outer HomeLink buttons, and release only when the indicator light begins to flash (after 20 seconds). **Do not** hold the buttons for longer than 30 seconds and **do not** repeat step one to program a second and/or third hand-held transmitter to the remaining two HomeLink buttons.

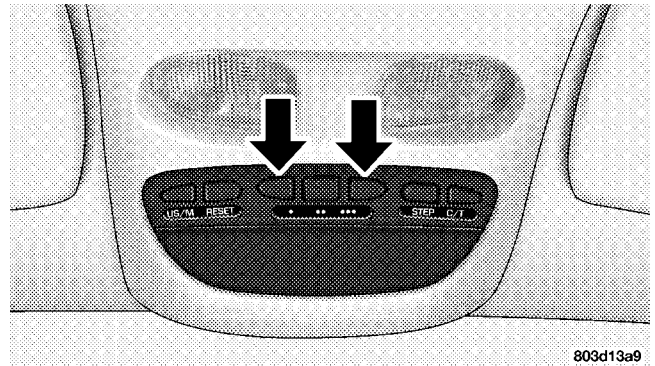

WARNING!

Vehicle exhaust contains carbon monoxide, a dangerous gas. Do not run the vehicle's exhaust while training the transceiver. Exhaust gas can cause serious injury or death.

WARNING!

Your motorized door or gate will open and close while you are training the Universal Transceiver. Do not train the transceiver if people or pets are in the path of the door or gate. A moving door or gate can cause serious injury or death to people and pets or damage to objects.

2. Position the end of your hand-held transmitter 1-3 inches (3-8 cm) away from the HomeLink buttons while keeping the indicator light in view.

3. Simultaneously press and hold both the HomeLink button that you want to train and the hand-held transmitter buttons. **Do not release the buttons until step 4 has been completed.**

NOTE: Some gate operators and garage door openers may require you to replace this Programming Step 3 with procedures noted in the "Gate Operator/Canadian Programming" section.

4. The HomeLink indicator light will flash slowly and then rapidly after HomeLink successfully receives the frequency signal from the hand-held transmitter. Release both buttons after the indicator light changes from the slow to the rapid flash.

5. Press and hold the just trained HomeLink button and observe the indicator light. If the indicator light **stays on constantly, programming is complete** and your device should activate when the HomeLink button is pressed and released.

NOTE: To program the remaining two HomeLink buttons, begin with "Programming" **step two. Do not repeat step one.**

If the indicator light blinks **rapidly for two seconds and then turns to a constant light**, continue with "Programming" steps 6-8 to complete the programming of a rolling code equipped device (most commonly a garage door opener).

6. At the garage door opener receiver (motor-head unit) in the garage, locate the "learn" or "smart" button. This can usually be found where the hanging antenna wire is attached to the motor-head unit.

7. Firmly press and release the "learn" or "smart" button. (The name and color of the button may vary by manufacturer.)

NOTE: There are 30 seconds in which to initiate step eight.

8. Return to the vehicle and firmly **press, hold for two seconds and release** the programmed HomeLink button. Repeat the "press/hold/release" sequence a second time, and, depending on the brand of the garage door opener (or other rolling code equipped device), repeat this sequence a third time to complete the programming.

HomeLink should now activate your rolling code equipped device.

NOTE: To program the remaining two HomeLink buttons, begin with "Programming" **step two. Do not repeat step one.** For questions or comments, please contact HomeLink at www.homelink.com or 1-800-355-3515.

Canadian Programming/Gate Programming

Canadian radio-frequency laws require transmitter signals to "time-out" (or quit) after several seconds of transmission which may not be long enough for HomeLink to pick up the signal during programming. Similar to this Canadian law, some U.S. gate operators are designed to "time-out" in the same manner.

If you live in Canada or you are having difficulties programming a gate operator by using the "Programming" procedures (regardless of where you live), **replace "Programming HomeLink" step 3** with the following:

NOTE: If programming a garage door opener or gate operator, it is advised to unplug the device during the "cycling" process to prevent possible overheating.

3. Continue to press and hold the HomeLink button while you **press and release every two seconds** ("cycle") your hand-held transmitter until the frequency signal has successfully been accepted by HomeLink. (The indicator light will flash slowly and then rapidly.) Proceed with "Programming" step four to complete.

Using HomeLink

To operate, simply press and release the programmed HomeLink button. Activation will now occur for the trained device (i.e. garage door opener, gate operator, security system, entry door lock, home/office lighting, etc.). For convenience, the hand-held transmitter of the device may also be used at any time. In the event that there are still programming difficulties or questions, contact HomeLink at: www.homelink.com or 1-800-355-3515.

Erasing HomeLink Buttons

To erase programming from the three buttons (individual buttons cannot be erased but can be "reprogrammed" - note below), follow the step noted:

- Press and hold the two outer HomeLink buttons until the indicator light begins to flash-after 20 seconds.

Release both buttons. Do not hold for longer than 30 seconds. HomeLink is now in the train (or learning) mode and can be programmed at any time beginning with "Programming" - step 2.

Reprogramming a Single HomeLink Button

To program a device to HomeLink using a HomeLink button previously trained, follow these steps:

1. Press and hold the desired HomeLink button. **Do NOT** release the button.
2. The indicator light will begin to flash after 20 seconds. Without releasing the HomeLink button, proceed with "Programming" step 2

For questions or comments, contact HomeLink at: www.homelink.com or 1-800-355-3515.

Security

If you sell your vehicle, be sure to erase the frequencies.

To erase all of the previously trained frequencies, hold down both outside buttons until the green light begins to flash.

This device complies with part 15 of FCC rules and with RSS-210 of Industry Canada. Operation is subject to the following conditions:

- This device may not cause harmful interference.
- This device must accept any interference that may be received including interference that may cause undesired operation.

NOTE: Changes or modifications not expressly approved by the party responsible for compliance could void the user's authority to operate the equipment.

HomeLink® is a trademark owned by Johnson Controls, Inc.

ELECTRICAL POWER OUTLETS — IF EQUIPPED

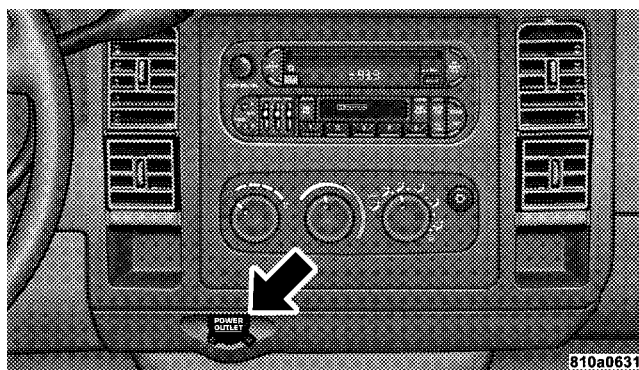

The optional auxiliary power outlet can provide up to 15 Amps of current for accessories designed for use with the standard power outlet adapter. The outlet is located in the lower portion of the instrument panel. It is covered by a snap on a plastic cap when not in use. As a safety precaution, this outlet only operates with the ignition switch ON. When the optional Cigar Lighter heating element is used, it heats when pushed in and pops out

automatically when ready for use. **To preserve the heating element, do not hold the lighter in the heating position.**

All accessories connected to this outlet should be removed or turned OFF when the vehicle is not in use to protect the battery against discharge.

Electrical Outlet Use With Engine OFF

CAUTION!

- Many accessories that can be plugged in draw power from the vehicle's battery, even when not in use (i.e. cellular phones, etc.). Eventually, if plugged in long enough, the vehicle's battery will discharge sufficiently to degrade battery life and/or prevent engine starting.
- Accessories that draw higher power (i.e. coolers, vacuum cleaners, lights, etc.), will discharge the battery even more quickly. Only use these intermittently and with greater caution.
- After the use of high power draw accessories, or long periods of the vehicle not being started (with accessories still plugged in), the vehicle must be driven a sufficient length of time to allow the generator to recharge the vehicle's battery.

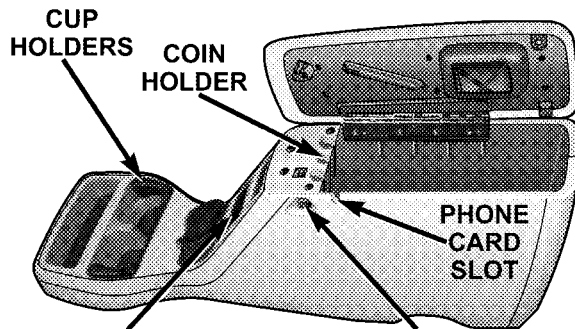
FLOOR CONSOLE — IF EQUIPPED**Floor Console Features****PHONE STORAGE BIN CONSOLE RELEASE** 810ba75a

The Floor Console, available with bucket seats, has the following features:

- Miscellaneous storage compartments
- Adjustable cup holders - with Automatic Transmission only
- Portable phone storage bin
- Portable phone cord routing

- Power Outlet inside storage compartment
- Storage compartment lamp
- Side open armrest lid
- Tissue holder & pen holder

Storage Compartments

Some miscellaneous storage compartments and cup holders have rubber mats at the bottom, the mats are both removable and dishwasher safe for cleaning purposes. Various storage compartments provide versatile and useful storage. A coin holder is also provided inside the console storage compartment.

Cup Holders

The cup holders fit a wide variety of cup and bottle sizes. To use the adjustable cup holders (only in automatic transmission vehicles) place your beverage in the cup holder well, then adjust the movable arms to tightly hold the beverage.

Power Outlet and Portable Phone Storage

The console is equipped with a power outlet, portable phone storage bin, and phone cord routing. The phone

storage bin can be used when ease access to the phone is needed. Also the power outlet inside console compartment can be used to power up the phone while it is being stored in the bin. To use plug in the portable power recharge cord and place the cord along the slot provided in the left side of the console. Close the console armrest lid and plug the power cord into the phone while resting the phone in the bin. The power outlet may be used for any portable item with a standard 12 volt power plug.

Storage compartment lamp

A storage compartment lamp illuminates the console storage compartment when the armrest lid is opened, and turns off when the armrest lid is closed or when the lamp plunger has been pressed.

Side Open Armrest Lid

Pressing the button on the left side of the console opens the console armrest lid. The armrest lid will remain open and the lamp will remain illuminated until armrest lid is closed manually by pressing the lid back into place. A penholder is provided on the inside of the armrest lid. A tissue holder is also provided on the inside of the armrest lid, which holds a pocket size soft pack of tissue.

CENTER STORAGE COMPARTMENT — IF EQUIPPED

The center portion of the seat folds down to provide an armrest with unique storage compartments under the lid. Push the button on the armrest to raise the lid. Compartments include a holder which will accommodate five compact disks with finger notches for easier access, a pencil tray, a coin holder, and a large open area for miscellaneous items.

CUP HOLDERS

If your vehicle has bucket seats with a center console, there are three cup holders located on the console. Refer to the section on floor console.

A removable pull-out two-cavity cup holder is available on all Quad Cab rear seats. It is stored in the front of the seat cushion and has two-way adjustable arms accommodating a wide range of cup sizes. A push-button latch on the dishwasher-safe cup holder releases it from its receptacle.

When using your Quad Cab rear seat cup holder make sure that you pull the cup holder out fully to engage the cup holder arms.

TAILGATE

To simplify mounting of a camper unit with an overhang, the tailgate can be removed quickly. Follow these steps:

1. Open the tailgate to a 45° angle.
2. Unclip and remove the cables from the box while maintaining a 45° angle.

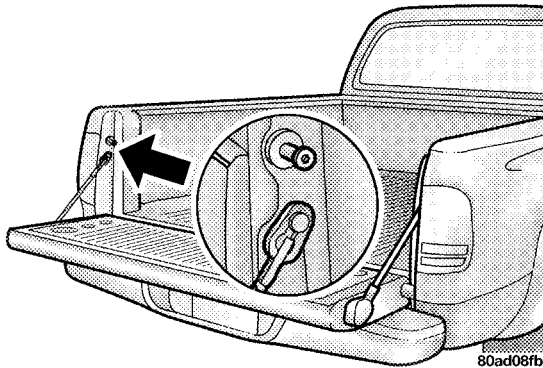

3. Lift the tailgate off of the pivot on the passenger side by pulling upward and rearward at the same time.
4. Slide the tailgate to the passenger side while making sure clearance from the box and taillight is maintained.

To reinstall the tailgate, do the following:

1. Slide the tailgate onto the driver's side pivot.
2. Hold the tailgate at a 45° angle and insert it into the passenger side pivot.
3. Clip the cables to the box.

SLIDE-IN CAMPERS

Camper Applications

Certain truck models are not recommended for slide-in campers. To determine if your vehicle is excluded, please refer to the Consumer Information Truck-Camper Loading document located in your Owner's Manual packet or available from your dealer. For safety reasons, follow all instructions on this important document.

General Information

The Manufacturer's Warranty does not apply to body modifications and special equipment, such as a camper unit, heaters, stoves, refrigerators, etc., supplied by manufacturers other than the manufacturer. For warranty coverage and service on these items, contact the applicable manufacturer.

To mount a camper unit with an overhang, the tailgate can be removed. Unlatch tailgate and remove support cables from the retainer pins. Raise right side of tailgate until the lower right side pivot clears the hanger bracket. Then slide the tailgate to the right to remove.

Carbon Monoxide Warning Vehicles Equipped With A Cap or Slide-In Campers

To avoid inhaling carbon monoxide, which is deadly, the exhaust system on vehicles equipped with "Cap or Slide-In Campers" should extend beyond the overhanging camper compartment and be free of leaks.

INSTRUMENT PANEL AND CONTROLS

CONTENTS

■ Instruments And Controls96	□ Tuning	106
■ Four Gauge Instrument Cluster97	□ PTY (Program Type) Button	106
■ Six Gauge Instrument Cluster98	□ Balance	108
■ Instrument Cluster Description99	□ Fade	108
■ Electronic Digital Clock	105	□ Tone Control	108
□ Clock Setting Procedure	105	□ AM/FM Selection	108
■ Sales Code RAZ—AM/ FM Stereo Radio With Cassette Tape Player, CD Player And CD Changer Controls — If Equipped	106	□ Scan Button	108
□ Operating Instructions — Radio	106	□ To Set The Radio Push-Button Memory	108
□ Power Switch, Volume Control	106	□ To Change From Clock To Radio Mode	109
□ Seek Button (Radio Mode)	106	□ Operating Instructions — Tape Player	109
		□ Seek Button	109

94 INSTRUMENT PANEL AND CONTROLS

□ Fast Forward (FF)	109	□ Time Button	112
□ Rewind (RW)	109	□ Scan Button	112
□ Tape Eject	110	□ CD Changer Control Capability — If Equipped	113
□ Scan Button	110	■ Sales Code RBK—AM/ FM Stereo Radio With CD Player And CD Changer Controls . . .	114
□ Changing Tape Direction	110	□ Radio Operation	114
□ Metal Tape Selection	110	□ CD Player Operation	116
□ Pinch Roller Release	110	□ CD Changer Control Capability — If Equipped	117
□ Noise Reduction	110	□ Radio Display Messages	119
□ Operating Instructions — CD Player	110	■ Sales Code RBB—AM/FM Stereo Radio With Cassette Tape Player And CD Changer Capability	119
□ Inserting The Compact Disc	111	□ Operating Instructions	119
□ Seek Button	111	□ Power Button	120
□ EJT CD (Eject) Button	111	□ Electronic Volume Control	120
□ FF/Tune/RW	112		
□ Program Button 4 (Random Play)	112		
□ Mode	112		
□ Tape CD Button	112		

□ Seek	120	■ Remote Sound System Controls — If Equipped	130
□ Tune	120	□ Radio Operation	130
□ To Set The Push-Button Memory	120	□ Tape Player	131
□ Balance	121	□ CD Player	131
□ Fade	121	■ Cassette Tape And Player Maintenance	131
□ Bass And Treble Tone Control	121	■ Compact Disc Maintenance	132
□ AM/FM Selection	121	■ Radio Operation And Cellular Phones	132
□ Mode Button	121	■ Climate Controls	133
□ Cassette Player Features	121	□ Heater Only	133
□ CD Changer Control Capability — If Equipped	122	□ Air Conditioning	134
□ Radio Display Messages	124	□ Operating Tips	137
■ Sales Code RBQ—AM/FM Stereo Radio With 6 - Disc CD Changer	124	□ Operation Tips Chart	139
□ Radio Operation	124	■ Rear Window Defroster – Quad-Cab Only	140
□ CD Player Operation	126		

INSTRUMENTS AND CONTROLS

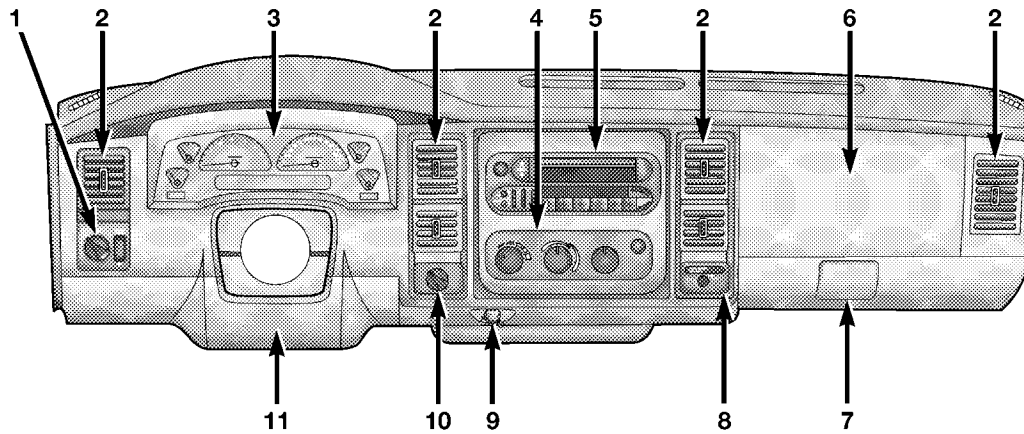

- 1. Headlight Switch
- 2. Air Outlets
- 3. Instrument Cluster
- 4. Climate Controls

- 5. Radio
- 6. Passenger Airbag
- 7. Glove Box
- 8. Passenger Airbag On/Off Switch

- 9. Auxiliary Power Outlet (Or Optional Cigar Lighter Receptacle)
- 10. Transfer Case Switch
- 11. Knee Bolster

FOUR GAUGE INSTRUMENT CLUSTER

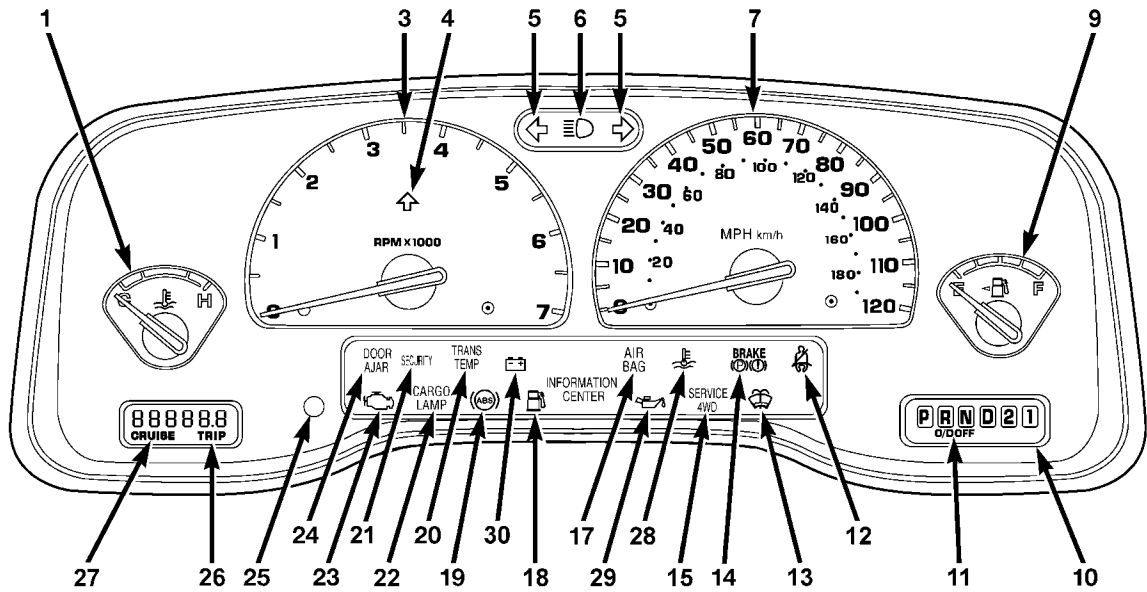

SIX GAUGE INSTRUMENT CLUSTER

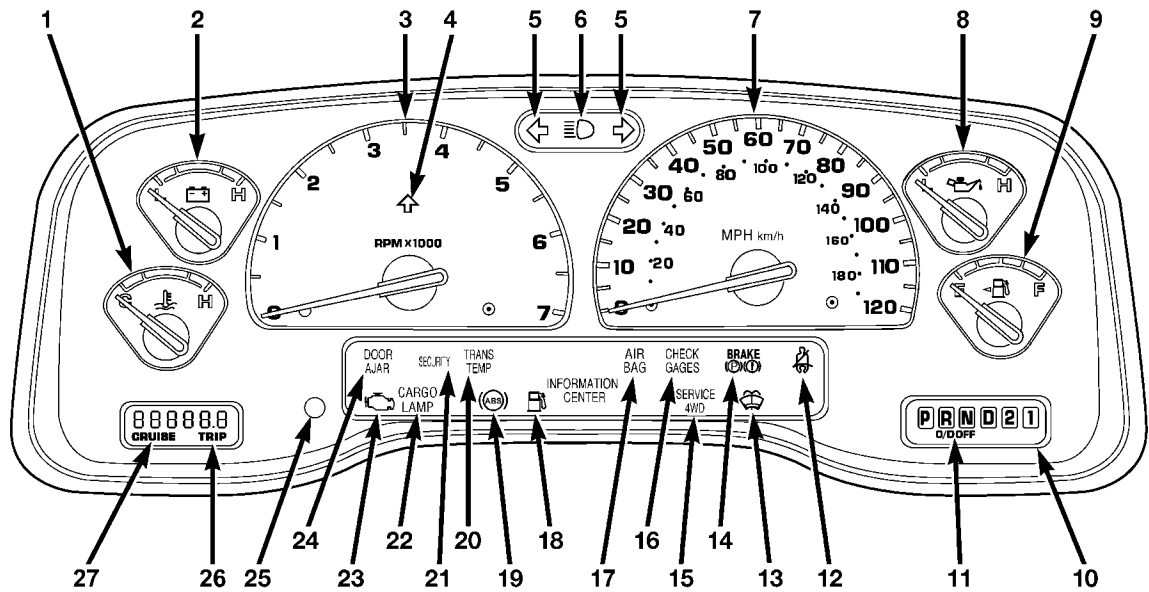

INSTRUMENT CLUSTER DESCRIPTION**1. Engine Coolant Temperature Gage**

The temperature gage indicates engine coolant temperature. Any reading within the normal range indicates that the cooling system is operating satisfactorily. The gage needle in V6 and V8 engines will likely indicate a high temperature when driving in hot weather, up mountain grades, in heavy traffic, or when towing a trailer. If the needle rises to 260° (hot mark), stop the vehicle, shift into N (Neutral) and elevate engine speed for 2-3 minutes. If the temperature reading does not return to normal, seek authorized service immediately.

CAUTION!

Do not leave your vehicle unattended with the engine running as you would not be able to react to the temperature indicator if the engine overheats.

The gage pointer will remain near its last reading when the engine is turned off. It will return to a true reading when the engine is restarted.

2. Voltage Gage – If Equipped

When the engine is running, the gage will indicate the electrical system voltage. During normal electrical load, the pointer will remain near the center of the scale. If the pointer moves to either the high or low sections, and remains there during normal driving, the electrical system should be serviced.

3. Tachometer

This gage measures engine revolutions per minute (rpm x 1000).

4. Shift Indicator Light

A small triangle lights to signal the most economical shift point for vehicles equipped with a manual transmission. See the Manual Transmission Operating description in section 5 of this manual for details.

5. Turn Signal Indicators

When a turn signal is activated, a right-pointing or left-pointing arrow lights up and flashes to indicate the

direction of the turn. These indicators also indicate proper operation of the front and rear turn signal lights. If either indicator flashes at a faster rate than normal, check for a defective bulb. If either indicator fails to light up when the lever is moved, check for a defective fuse or turn signal bulb. A continuous low chime is activated when the left/right turn signal is left on with the engine RPM vehicle speed greater than 15 mph (24 km/h) for more than 1 mi. (1.6 km)

6. High Beam Indicator

 This light indicates that headlights are on high beam.

7. Speedometer

This gage shows vehicle speed in miles per hour and kilometers per hour.

8. Oil Pressure Gage – If Equipped

 This gage indicates engine oil pressure. Any reading within the normal range indicates that the engine oil system is operating satisfactorily. A continuous high or low reading under normal operating conditions may indicate a lubrication system malfunction. Immediate service should be obtained. The

oil gage does not indicate the amount of oil in the engine. See section 7 for the oil level checking procedure.

9. Fuel Gage

 This gage shows the level of fuel in tank when the ignition switch is in the ON position.

10. Gear Selector

The electronic gear selector display is self-contained within the instrument cluster. It displays the position of the automatic transmission shift lever, and the relation of each position to all other positions. For a good signal the display will place a box around the selected transmission range (PRND21). If the PRNDL displays only the characters PRND21 (no boxes) or PRND21 with all boxes on, have the system checked by an authorized dealer.

11. O/D (Overdrive) OFF Indicator (Automatic Transmissions Only)

This light will illuminate when the overdrive off button has been selected.

12. Seat Belt Reminder Light

This light comes on for several seconds after the ignition is turned ON as a reminder to “buckle up.” This light will remain on as long as the seat belt remains unbuckled. If this light flashes, it indicates a fault in the airbag system. Have the system checked by an authorized dealer.

13. Low Washer Fluid Indicator

This light comes on when the washer fluid level falls below approximately 1/4 full. The light will remain on until fluid is added and ignition switch is cycled.

14. Brake System Warning Light

This light will light when the ignition key is turned to the ON position and will remain on for a few seconds. If the light stays on, it may be an indication that the parking brake has not been released, or there is a low brake fluid level. If the light remains on when the parking brake has been disengaged, and the fluid level is at the full mark on the master cylinder reservoir, it indicates a possible brake hydraulic system malfunction. In this case, the light will remain on until the cause is corrected. If the parking brake is applied, the light will flash when the gear

position is out of park for automatic transmissions, or the engine RPM is greater than 0 for manual transmissions.

If brake failure is indicated, immediate repair is necessary. **Operating the vehicle in this condition is dangerous!**

15. SERVICE 4WD Indicator

This light monitors the electric shift 4WD system. This light will come on when the ignition key is turned to the ON position and will stay on for 2 seconds. If the light stays on or comes on during driving, it means that the 4WD system is not functioning properly and that service is required.

16. Check Gages

CHECK GAGES This light illuminates when the Voltmeter, Engine Oil Pressure or Engine Coolant Temperature gages indicate a reading either too high or too low. Examine the gages carefully, and follow the instructions above for each indicated problem.

NOTE: When the ignition switch is turned to OFF, the Fuel Gage, Voltmeter, Oil Pressure and Engine Coolant

Temperature gages may not show accurate readings. When the engine is not running, turn the ignition switch to ON to obtain accurate readings.

17. Airbag Indicator

AIR BAG The indicator lights and remains lit for 6 to 8 seconds when the ignition is first turned ON. If the light does not come on when the ignition is first turned on, or the light stays on or comes on while driving, have the airbag system checked by an authorized dealer.

18. Low Fuel Warning Light



This indicator lights when the fuel gauge reads 1/8 of a tank or less.

19. ABS Warning Light



This light monitors the Anti-Lock Brake System which is described elsewhere in this manual. This light will come on when the ignition key is turned to the ON position and may stay on for 5 seconds. If this light remains on or comes on during driving, it indicates that the anti-lock

portion of the brake system is not functioning and that service is required. See your authorized dealer immediately.

20. Transmission Oil Temperature Warning Light



This light indicates that there is excessive transmission fluid temperature that might occur with severe usage such as trailer towing. If this light comes on, stop the vehicle and run the engine at idle or faster, with the transmission in NEUTRAL until the light goes off.

21. Security

The light will flash rapidly for approximately 15 seconds when the vehicle theft alarm is arming. The light will flash at a slower rate after the alarm is set. The security light will also come on for about three seconds when the ignition is first turned ON.

22. Cargo Lamp

The Cargo Lamp light will illuminate when the Cargo Lamp is activated from the Head Lamp switch.

23. *Malfunction Indicator Light*



This light is part of an onboard diagnostic system which monitors the emissions and engine control system. If the vehicle is ready for emissions testing the light will come on when the ignition is first turned on and remain on, as a bulb check, until the engine is started. If the vehicle is not ready for emissions testing the light will come on when the ignition is first turned on and remain on for 15 seconds, then blink for 5 seconds, and remain on until the vehicle is started. If the bulb does not come on during starting, have the condition investigated promptly.

If this light comes on and remains on while driving, it suggests a potential engine control problem and the need for system service.

Although your vehicle will usually be drivable and not need towing, see your dealer for service as soon as possible.

CAUTION!

Prolonged driving with the MIL on could cause damage to the engine control system. It also could affect fuel economy and driveability.

If the MIL is flashing, severe catalytic converter damage and power loss will soon occur. Immediate service is required.

4

24. *Door Ajar*

**DOOR
AJAR**

The Door Ajar light will illuminate when the ignition is ON and either one of the passenger doors is opened.

25. *Odometer/Trip Odometer Button*

Press this button to toggle between the odometer and the trip odometer display. Holding the button in resets the trip odometer reading.

26. *Odometer/Trip Odometer*

The odometer shows the total distance the vehicle has been driven.

U.S. federal regulations require that upon transfer of vehicle ownership, the seller certify to the purchaser the correct mileage that the vehicle has been driven. Therefore, if the odometer reading is changed during repair or replacement, be sure to keep a record of the reading before and after the service so that the correct mileage can be determined.

The trip odometer shows individual trip mileage. To toggle between the odometer and the trip odometer, press the Odometer/Trip Odometer Button.

27. Cruise Light

This indicator lights when the electronic speed control system is turned on.

28. Coolant Temperature Light (Clusters Without A Gauge)



This light warns of an overheated engine condition. For a bulb check, this light will come on momentarily when the ignition is turned On. If the light turns on while driving, stop the vehicle and shut off the engine as soon as possible.

CAUTION!

Driving with a hot engine cooling system could damage your vehicle. If the temperature light is on, pull over and stop the vehicle. Idle the vehicle with the air conditioner turned off until the light turns off. If the light remains on, turn the engine off immediately, and call for service.

WARNING!

A hot engine cooling system is dangerous. You or others could be badly burned by steam or boiling coolant. You may want to call a service center if your vehicle overheats. If you decide to look under the hood yourself, see Section 7 of this manual. Follow the warnings under the Cooling System Pressure Cap paragraph.

29. Engine Oil Pressure Indicator Light (Clusters Without A Gauge)

 This light indicates that the engine oil pressure has become too low. For a bulb check, this light will come on momentarily when the ignition is turned On. If the light turns on while driving, stop the vehicle and shut off the engine as soon as possible. Immediate service should be obtained.

30. Voltage Light (Clusters Without A Gauge)

 This light monitors the electrical system voltage. The light should turn on momentarily as the engine is started. If the light stays on or turns on while driving, it indicates a problem with the charging system. Immediate service should be obtained.

ELECTRONIC DIGITAL CLOCK

The clock and radio each use the display panel built into the radio. A digital readout shows the time in hours and minutes whenever the ignition switch is in the “ON” or “ACC” position.

When the ignition switch is in the “OFF” position, or when the radio frequency is being displayed, time keeping is accurately maintained.

Clock Setting Procedure

1. Turn the ignition switch to the “ON” or “ACC” position. Using the point of a ballpoint pen or similar object, press either the “H” (Hour) or “M” (Minute) buttons on the radio. The display will show the time.
2. Press the “H” button to set hours or the “M” button to set minutes. The time setting will increase each time you press a button.

**SALES CODE RAZ—AM/ FM STEREO RADIO
WITH CASSETTE TAPE PLAYER, CD PLAYER
AND CD CHANGER CONTROLS — IF EQUIPPED**

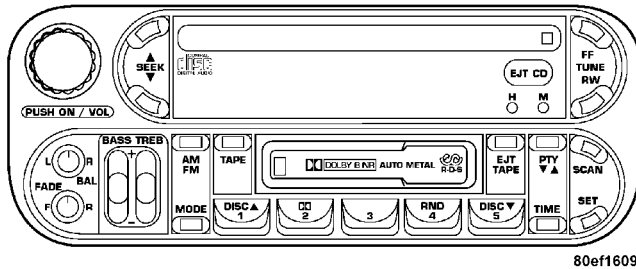

Operating Instructions — Radio

NOTE: Power to operate the radio is controlled by the ignition switch. It must be in the ON or ACC position to operate the radio.

Power Switch, Volume Control

Press the ON/VOL control to turn the radio on. Turn the volume control clockwise to increase the volume. The volume will be displayed and continuously updated while the button is pressed.

Seek Button (Radio Mode)

Press and release the Seek button to search for the next station in either the AM or FM mode. Press the top of the button to seek up and the bottom to seek down. Holding the button will bypass stations until you release the button.

Tuning

Press the TUNE control up or down to increase or decrease the frequency. If you press and hold the button, the radio will continue to tune until you release the button. The frequency will be displayed and continuously updated while the button is pressed.

PTY (Program Type) Button

Pressing this button once will turn on the PTY mode for 5 seconds. If no action is taken during the 5 second time out the PTY icon will turn off. Pressing the PTY button within 5 seconds will allow the program format type to be selected. Many radio stations do not currently broadcast PTY information.

Toggle the PTY button to select the following format types:

Program Type	Radio Display
Adult Hits	Adlt Hit
Classical	Classicl
Classic Rock	Cls Rock
College	College
Country	Country
Information	Inform
Jazz	Jazz
Foreign Language	Language
News	News
Nostalgia	Nostalga
Oldies	Oldies
Personality	Persnlty
Public	Public
Rhythm and Blues	R & B
Religious Music	Rel Musc
Religious Talk	Rel Talk
Rock	Rock

Program Type	Radio Display
Soft	Soft
Soft Rock	Soft Rck
Soft Rhythm and Blues	Soft R&B
Sports	Sports
Talk	Talk
Top 40	Top 40
Weather	Weather

By pressing the SEEK button when the PTY icon is displayed, the radio will be tuned to the next frequency station with the same selected PTY name. The PTY function only operates when in the FM mode.

The radio display will flash "SEEK" and the selected PTY program type when searching for the next PTY station. If no station is found with the selected PTY program type, the radio will return to the last preset station.

If a preset button is activated while in the PTY (Program Type) mode, the PTY mode will be exited and the radio will tune to the preset station.

Pressing PTY, then SCAN will scan the FM Band and stop at all RDS stations. Each RDS station will be played for a 5 second scan once around the FM Band and stop at the last station. The PTY icon will then turn off.

Balance

The Balance control adjusts the left-to-right speaker balance. Push in the button and it will pop out. Adjust the balance and push the button back in. The balance will be displayed and continuously updated while the button is turned.

Fade

The Fade control provides for balance between the front and rear speakers. Push in the button and it will pop out. Adjust the balance and push the button back in. The fade will be displayed and continuously updated while the button is turned.

Tone Control

Slide the Bass and/or Treble controls up or down to adjust the sound for the desired tone. The treble, and bass will be displayed and continuously updated while the slide is moved.

AM/FM Selection

Press the AM/FM button to change from AM to FM. The operating mode will be displayed next to the station frequency. The display will show ST when a stereo station is received.

Scan Button

Pressing the SCAN button causes the tuner to search for the next station, in either AM or FM, pausing for 5 seconds at each listenable station before continuing to the next.

Pressing the AM/FM button continues the search in the alternate frequency band.

To stop the search, press SCAN a second time.

To Set The Radio Push-button Memory

When you are receiving a station that you wish to commit to push-button memory, press the SET button. SET 1 will show in the display window. Select the push-button you wish to lock onto this station and press and release that button. If a station is not selected within

5 seconds after pressing the SET button, the station will continue to play but will not be locked into push-button memory.

You may add a second station to each push-button by repeating the above procedure with this exception: Press the SET button twice and SET 2 will show in the display window. Each button can be set for SET 1 and SET 2 in both AM and FM. This allows a total of 10 AM and 10 FM stations to be locked into memory. You can recall the stations stored in SET 2 memory by pressing the push-button twice.

To Change From Clock To Radio Mode

Press the Time button to change the display between radio frequency and time.

Operating Instructions — Tape Player

Insert the cassette with the exposed tape side toward the right and the mechanical action of the player will gently pull the cassette into the play position.

NOTE: When subjected to extremely cold temperatures, the tape mechanism may require a few minutes to warm up for proper operation. Sometimes poor playback may

be experienced due to a defective cassette tape. Clean and demagnetize the tape heads at least twice a year.

Seek Button

Press the SEEK button up for the next selection on the tape and down to return to the beginning of the current selection.

Press the SEEK button up or down to move the track number to skip forward or backward 1 to 6 selections. Press the SEEK button once to move 1 selection, twice to move 2 selections, etc.

Fast Forward (FF)

Press the FF button up momentarily to advance the tape in the direction that it is playing. The tape will advance until the button is pressed again or the end of the tape is reached. At the end of the tape, the tape will play in the opposite direction.

Rewind (RW)

Press the RW button momentarily to reverse the tape direction. The tape will reverse until the button is pressed again or until the end of the tape is reached. At the end of the tape, the tape will play in the opposite direction.

Tape Eject

Press the EJT Tape button and the cassette will disengage and eject from the radio.

Scan Button

Press this button to play 10 seconds of each selection. Press the scan button a second time to cancel the feature.

Changing Tape Direction

If you wish to change the direction of tape travel (side being played), press the PTY button. The lighted arrow in the display window will show the new direction.

Metal Tape Selection

If a standard metal tape is inserted into the player, the player will automatically select the correct equalization and the 70 symbol will appear in the display window.

Pinch Roller Release

If ignition power or the radio ON/OFF switch are turned off, the pinch roller will automatically retract to protect the tape from any damage. When power is restored to the tape player, the pinch roller will automatically reengage and the tape will resume play.

Noise Reduction

The Dolby Noise Reduction System* is on whenever the tape player is on, but may be switched off.

To turn off the Dolby Noise reduction System: Press the Dolby button (button 2) after you insert the tape. The NR light in the display will go off when the Dolby System is off. The Dolby System is automatically reactivated each time a tape is inserted.

* "Dolby" noise reduction manufactured under license from Dolby Laboratories Licensing Corporation. Dolby and the double-D symbol are trademarks of Dolby Laboratories Licensing Corporation.

Operating Instructions — CD Player

NOTE: The ignition switch must be in the ON or ACC position and the volume control ON before the CD player will operate.

CAUTION!

This CD player will accept 4 ¾ inch (12 cm) discs only. The use of other sized discs may damage the CD player mechanism.

Inserting The Compact Disc

The CD player contained within the radio is not a multi-disc changer, and will only accept one CD. Gently insert one CD into the CD player with the CD label facing up. The CD will automatically be pulled into the CD Player.

If the volume control is ON, the unit will switch from radio to CD mode and begin to play. The display will show the track number and index time in minutes and seconds. Play will begin at the start of track one.

NOTE:

- You may eject a disc with the radio OFF. The ignition switch must be in the ON or ACC position to insert a disc with the radio OFF.

- If you insert a disc with the ignition ON and the radio OFF, the CD will automatically be pulled into the CD Player and the display will show the time of day. If you insert a disc with the ignition OFF, the display will show the time of day for about 5 seconds, then go out.

Seek Button

Press the top of the SEEK button for the next selection on the CD. Press the bottom of the button to return to the beginning of the current selection, or return to the beginning of the previous selection if the CD is within the first 10 seconds of the current selection.

EJT CD (Eject) Button

Press this button and the disc will unload and move to the entrance for easy removal. The unit will switch to the radio mode.

If you do not remove the disc within 15 seconds, it will be reloaded. The radio mode will continue to appear.

The disc can be ejected with the radio OFF.

FF/TUNE/RW

Press FF (Fast Forward) and the CD player will begin to fast forward until FF is released. The RW (Reverse) button works in a similar manner.

Program Button 4 (Random Play)

Press this button while the CD is playing to activate Random Play. This feature plays the tracks on the selected disc in random order to provide an interesting change of pace.

Press the SEEK button to move to the next randomly selected track.

Press TUNE FF to fast forward through the tracks. Press the FF button a second time to stop the fast forward feature. If TUNE RW is pressed, the current track will reverse to the beginning of the track and begin playing.

Press button 4 a second time to stop Random Play.

MODE

Press the MODE button to select between the tape player, CD player, or satellite radio (if equipped).

To select Satellite Radio (if equipped), press the MODE button until the word SIRIUS appears. The following will be displayed in this order: After three seconds, the current channel name and number will be displayed for five seconds. The current program type and channel number will then be displayed for five seconds. The current channel name and number will then be displayed until an action occurs. A CD or tape may remain in the player while in the Satellite Radio mode.

Tape CD Button

Press this button to select between CD player and Tape player.

Time Button

Press this button to change the display from elapsed CD playing time to time of day.

Scan Button

Press this button to play the first 10 seconds of each track. To stop the scan function, press the button a second time.

CD Changer Control Capability — If Equipped

This radio is compatible with a remote mounted CD changer available through Mopar Accessories. The following instructions are for the radio controls that operate this CD changer.

Mode Button

To activate the CD changer, press the MODE button until CD information appears on the display.

Push-Button

While the CD changer is playing, press the NUMBER 1 push-button or the NUMBER 5 push-button to select a disc numbered higher or lower than the one currently being played.

Seek Button

Press the SEEK up or down to select another track on the same disc. A SEEK symbol will appear on the display.

Fast Forward And Rewind Buttons

Press and hold the FF button for fast forward. Press and hold the RW button for fast reverse.

The audio output can be heard when fast forward and fast reverse are activated.

Random Play (RND)

Press the Random button to play the tracks on the selected disc in random order for an interesting change of pace.

Random can be cancelled by pressing the button a second time or by ejecting the CD from the changer.

CD Diagnostic Indicators

When driving over a very rough road, the CD player may skip momentarily. Skipping will not damage the disc or the player, and play will resume automatically.

As a safeguard and to protect your CD player, one of the following warning symbols may appear on your display.

A CD HOT symbol indicates the player is too hot.

CD HOT will pause the operation. Play can be resumed when the operating temperature is corrected or another MODE is selected.

An ERR symbol will appear on the display if the laser is unable to read the Disc data for the following reasons:

- Excessive vibration

- Disc inserted upside down
- Damaged disc
- Water condensation on optics

SALES CODE RBK—AM/ FM STEREO RADIO WITH CD PLAYER AND CD CHANGER CONTROLS

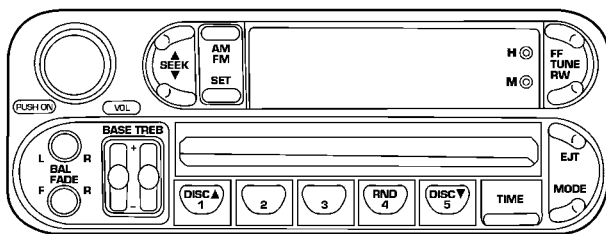

80e571f6

Radio Operation

Power/Volume Control

Press the ON/VOL control to turn the radio on. Turn the volume control clockwise to increase the volume.

NOTE: Power to operate the radio is supplied through the ignition switch. It must be in the ON or ACC position to operate the radio.

Seek

Press and release the SEEK button to search for the next station in either the AM or FM mode. Press the top of the button to seek up and the bottom to seek down. The radio will remain tuned to the new station until you make another selection. Holding the button in will bypass stations without stopping until you release it.

Tune

Press the TUNE control up or down to increase or decrease the frequency. If you press and hold the button, the radio will continue to tune until you release the button. The frequency will be displayed and continuously updated while the button is pressed.

Balance

The Balance control adjusts the left-to-right speaker balance. Press the BAL button in and it will pop out. Adjust the balance and push the button back in.

Fade

The Fade control provides for balance between the front and rear speakers. Press the FADE button in and it will pop out. Adjust the balance and push the button back in.

Bass and Treble Tone Control

The tone controls consist of 2 separate bands. The bass band is on the left, and the treble band is on the right. Each band is adjusted by a slider control with a detent at the mid-position. Moving the control up or down increases or decreases amplification of that band. The mid position provides a balanced output.

AM/FM Selection

Press the AM/FM button to change from AM to FM. The operating mode will be displayed next to the station frequency. The display will show ST when a stereo station is received.

To Set The Radio Push-Button Memory

When you are receiving a station that you wish to commit to push-button memory, press the SET button. SET 1 will show in the display window. Select the "1-5" button you wish to lock onto this station and press and release that button. If a button is not selected within 5 seconds after pressing the SET button, the station will continue to play but will not be locked into push-button memory.

You may add a second station to each push-button by repeating the above procedure with this exception: Press the SET button twice and SET 2 will show in the display window. Each button can be set for SET 1 and SET 2 in both AM and FM. This allows a total of 10 AM and 10 FM stations to be locked into push-button memory. The stations stored in SET 2 memory can be selected by pressing the push-button twice. Every time a preset button is used a corresponding button number will be displayed.

Time

Press the TIME button to change the display between radio frequency and time.

General Information

This radio complies with Part 15 of FCC rules and with RSS-210 of Industry Canada. Operation is subject to the following conditions:

1. This device may not cause harmful interference,
2. This device must accept any interference received, including interference that may cause undesired operation.

NOTE: Changes or modifications not expressly approved by the party responsible for compliance could void the user's authority to operate the equipment.

CD Player Operation

NOTE: The ignition switch must be in the ON or ACC position and the volume control ON before the CD player will operate.

Inserting The Compact Disc**CAUTION!**

This CD player will accept 4 ¾ inch (12 cm) discs only. The use of other sized discs may damage the CD player mechanism.

You may either insert or eject a disc with the radio OFF.

If you insert a disc with the ignition ON and the radio OFF, the display will show the time of day.

If the power is ON, the unit will switch from radio to CD mode and begin to play when you insert the disc. The display will show the track number and index time in minutes and seconds. Play will begin at the start of track one.

Seek

Press the top of the SEEK button for the next selection on the CD. Press the bottom of the button to return to the

beginning of the current selection, or return to the beginning of the previous selection if the CD is within the first second of the current selection.

EJT — Eject

Press the EJT button and the disc will unload and move to the entrance for easy removal. The unit will switch to the radio mode.

If you do not remove the disc within 15 seconds, it will be reloaded. The unit will continue in radio mode.

The disc can be ejected with the radio and ignition OFF.

FF/TUNE/RW

Press FF (Fast Forward) and the CD player will begin to fast forward until FF is released. The RW (Reverse) button works in a similar manner.

Random Play — RND/Program Button 4

Press the RND (button 4) button while the CD is playing to activate Random Play. This feature plays the tracks on the selected disc in random order to provide an interesting change of pace.

Press the SEEK button to move to the next randomly selected track.

Press the RND (button 4) button a second time to stop Random Play.

Mode

Press the MODE button repeatedly to select between the CD player, the optional remote CD changer and the Satellite Radio (if equipped). When Satellite Radio (if equipped) is selected "SA" will appear in your radio display.

A CD or tape may remain in the player while in the Satellite mode.

Time

Press the TIME button to change the display from elapsed CD playing time to time of day.

CD Changer Control Capability — If Equipped

This radio is compatible with a remote mounted CD changer available through Mopar Accessories. The following instructions are for the radio controls that operate this CD changer.

Mode Button

To activate the CD changer, press the MODE button until CD information appears on the display.

Push-Button

While the CD changer is playing, press the NUMBER 1 push-button or the NUMBER 5 push-button to select a disc numbered higher or lower than the one currently being played.

Seek Button

Press the SEEK up or down to select another track on the same disc. A SEEK symbol will appear on the display.

Fast Forward And Rewind Buttons

Press and hold the FF button for fast forward. Press and hold the RW button for fast reverse.

The audio output can be heard when fast forward and fast reverse are activated.

Random Play (RND)

Press the Random button to play the tracks on the selected disc in random order for an interesting change of pace.

Random can be cancelled by pressing the button a second time or by ejecting the CD from the changer.

CD Diagnostic Indicators

When driving over a very rough road, the CD player may skip momentarily. Skipping will not damage the disc or the player, and play will resume automatically.

As a safeguard and to protect your CD player, one of the following warning symbols may appear on your display.

A CD HOT symbol indicates the player is too hot.

CD HOT will pause the operation. Play can be resumed when the operating temperature is corrected or another MODE is selected.

An ERR symbol will appear on the display if the laser is unable to read the Disc data for the following reasons:

- Excessive vibration
- Disc inserted upside down
- Damaged disc
- Water condensation on optics

Radio Display Messages

Your radio has been designed to display certain messages when a problem is detected with the CD player.

DISPLAY	EXPLANATION	WHAT TO DO
E-01	Deadlock problem	See your dealer for service
E-02	Disc eject problem	See your dealer for service
E-06	Elevator problem	See your dealer for service
E-07	Magazine eject problem	Check that magazine is OK- if not see your dealer for service
	No discs in magazine. Load discs in magazine.	
	Player overheating. Allow to cool down.	

805c2ab6

SALES CODE RBB—AM/FM STEREO RADIO WITH CASSETTE TAPE PLAYER AND CD CHANGER CAPABILITY

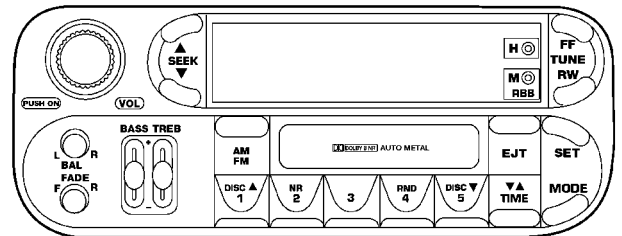

80ef1613

Operating Instructions

NOTE: Power to operate the radio is supplied through the ignition switch. It must be in the ON or ACC position to operate the radio.

NOTE: When first learning the control functions, the user should set the controls as shown in the following list.

- Tone Controls...As illustrated.
- Speaker Control...Centered.

Power Button

The volume control/power button pops out when pressed, this turns the sound system ON in the mode last used. Pushing the button back in turns the sound system OFF.

Electronic Volume Control

The electronic volume control turns continuously (360 degrees) in either direction without stopping. Turning the volume control to the right increases the volume and to the left decreases it.

When the audio system is turned on, the sound will be set at the same volume level as last played.

For your convenience, the volume can be turned down, but not up, when the audio system is off and the ignition is ON.

Seek

Press and release the SEEK button to search for the next station in either the AM or FM mode. Press the top of the button to seek up and the bottom to seek down. The radio will remain tuned to the new station until you

make another selection. Holding the button will bypass stations without stopping until you release it.

Tune

Press the TUNE control up or down to increase or decrease the frequency. If the button is pushed and held, the radio will continue to tune until the button is released. The frequency will be displayed and continuously updated while the button is pushed.

To Set The Push-Button Memory

When you are receiving a station that you wish to commit to push-button memory, press the SET button. The symbol SET 1 will now show in the display window. Select the "1-5" button you wish to lock onto this station and press and release that button. If a button is not selected within 5 seconds after pressing the SET button, the station will continue to play but will not be locked into push-button memory.

You may add a second station to each push-button by repeating the above procedure with this exception: Press the SET button twice and SET 2 will show in the display window. Each button can be set for SET 1 and SET 2 in both AM and FM. This allows a total of 10 AM and 10 FM

stations to be locked into push-button memory. The stations stored in SET 2 memory can be selected by pressing the push-button twice.

Every time a preset button is used a corresponding button number will be displayed.

Balance

The balance control adjusts the left-to-right speaker balance. Press the BAL button in and it will pop out. Adjust the balance and push the button back in.

Fade

The fade control provides for balance between the front and rear speakers. Press the FADE button in and it will pop out. Adjust the balance and push the button back in.

Bass and Treble Tone Control

The tone controls consist of 2 separate bands. The bass band is on the left, and the treble band is on the right. Each band is adjusted by a slider control with a detent at the mid-position. Moving the control up or down increases or decreases amplification of that band. The mid position provides a balanced output.

AM/FM Selection

Press the AM/FM button to change from AM to FM. The operating mode will be displayed next to the station frequency. The display will show ST when a stereo station is received in the FM mode.

Mode Button

Press the MODE button to select between the cassette tape player, CD changer, or the Satellite Radio (if equipped). When the Satellite Radio (if equipped) is selected "SA" will appear in your radio display.

A CD or tape may remain in the player while in the Satellite or radio mode.

Cassette Player Features

With ignition OFF and the sound system OFF, you can eject the tape cassette by pushing the EJECT button.

You can turn the tape player ON by inserting a cassette or activating the MODE button (with a cassette in the radio), but only when the ignition and radio are on.

Each time a cassette is inserted the tape player will begin playing on the side of the cassette that is facing up in the player.

Music Search

Pressing the SEEK button while playing a tape will start the Music Search mode. Press the SEEK button up for the next selection on the tape and down to return to the beginning of the current selection, or return to the beginning of the previous selection if the tape is within the first 5 seconds of the current selection.

The SEEK symbol appears on the display when Music Search is in operation. Music Search shuts off automatically when a selection has been located.

Selective Music Search

Press the SEEK button up or down to move the track number to skip forward or backward 1 to 7 selections. Press the SEEK button once to move 1 selection, twice to move 2 selections, etc.

Fast Forward And Rewind Buttons

Pressing the TUNE button up or down momentarily activates Fast Forward or Rewind and makes the directional arrows appear on the display.

To stop Fast Forward or Rewind, press the TUNE button again.

Time Button

Press the time button to toggle between station frequency and time of day.

Pressing this button while playing a cassette tape will change the side of the tape being played.

NR (Noise Reduction)

Pushing the Number 2 Pre-set button when a tape is playing deactivates the Dolby Noise Reduction System*. When Dolby is ON, the NR symbol appears on the display. Each time a tape is inserted the Dolby will turn ON.

* "Dolby" noise reduction manufactured under license from Dolby Laboratories Licensing Corporation. Dolby and the double-D symbol are trademarks of Dolby Laboratories Licensing Corporation.

CD Changer Control Capability — If Equipped

This radio is compatible with a remote mounted CD changer available through Mopar Accessories. The following instructions are for the radio controls that operate this CD changer.

Mode Button

To activate the CD changer, press the MODE button until CD information appears on the display.

Push-Button

While the CD changer is playing, press the NUMBER 1 push-button or the NUMBER 5 push-button to select a disc numbered higher or lower than the one currently being played.

Seek Button

Press the SEEK up or down to select another track on the same disc. A SEEK symbol will appear on the display.

Fast Forward And Rewind Buttons

Press and hold the FF button for fast forward. Press and hold the RW button for fast reverse.

The audio output can be heard when fast forward and fast reverse are activated.

Random Play (RND)

Press the Random button to play the tracks on the selected disc in random order for an interesting change of pace.

Random can be cancelled by pressing the button a second time or by ejecting the CD from the changer.

CD Diagnostic Indicators

When driving over a very rough road, the CD player may skip momentarily. Skipping will not damage the disc or the player, and play will resume automatically.

As a safeguard and to protect your CD player, one of the following warning symbols may appear on your display.

A CD HOT symbol indicates the player is too hot.

CD HOT will pause the operation. Play can be resumed when the operating temperature is corrected or another MODE is selected.

An ERR symbol will appear on the display if the laser is unable to read the Disc data for the following reasons:

- Excessive vibration
- Disc inserted upside down
- Damaged disc
- Water condensation on optics

Radio Display Messages

Your radio has been designed to display certain messages when a problem is detected with the CD player.

DISPLAY	EXPLANATION	WHAT TO DO
E-01	Deadlock problem	See your dealer for service
E-02	Disc eject problem	See your dealer for service
E-06	Elevator problem	See your dealer for service
E-07	Magazine eject problem	Check that magazine is OK- if not see your dealer for service
	No discs in magazine. Load discs in magazine.	
	Player overheating. Allow to cool down.	

SALES CODE RBQ—AM/FM STEREO RADIO WITH 6 - DISC CD CHANGER

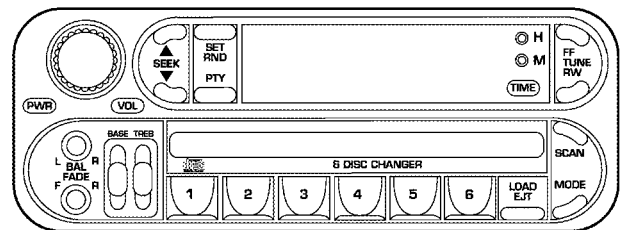

80f1ee0e

Radio Operation

Power/Volume Control

Press the PWR/VOL control to turn the radio on. Turn the volume control clockwise to increase the volume.

NOTE: Power to operate the radio is controlled by the ignition switch. It must be in the ON or ACC position to operate the radio.

Mode

Press the MODE button repeatedly to select between AM, FM, the CD changer and Sirius Satellite Radio™ (if equipped). The display will show ST when a stereo station is received.

To select Sirius Satellite Radio™ (if equipped), press the MODE button until the word SIRIUS appears. The following will be displayed in this order: After three seconds, the current channel name and number will be displayed for five seconds. The current program type and channel number will then be displayed for five seconds. The current channel name and number will then be displayed until an action occurs. CD's may remain in the player while in the Satellite Radio mode.

Seek

Press and release the SEEK button to search for the next station in either the AM or FM mode. Press the top of the button to seek up and the bottom to seek down. The radio will remain tuned to the new station until you make another selection. Holding the button in will bypass stations without stopping until you release it.

Tune

Press the TUNE control up or down to increase or decrease the frequency. If the button is pressed and held, the radio will continue to tune until the button is released. The frequency will be displayed and continuously updated while the button is pressed.

Balance — BAL

The Balance control adjusts the left-to-right speaker balance. Press the BAL button in and it will pop out. Adjust the balance and push the button back in.

Fade

The Fade control provides for balance between the front and rear speakers. Press the FADE button in and it will pop out. Adjust the balance and push the button back in.

Tone Control

The tone controls affect the Bass and Treble frequency bands. Each is controlled by a slider control with a detent at the mid position. Moving a control up or down increases or decreases amplification of the band. The mid position provides a balanced output.

To Set The Radio Push-Button Memory

When you are receiving a station that you wish to commit to push-button memory, press the SET RND button. SET 1 will show in the display window. Select the "1-6" button you wish to lock onto this station and press and release that button. If a button is not selected within 5 seconds after pressing the SET RND button, the station will continue to play but will not be locked into push-button memory.

You may add a second station to each push-button by repeating the above procedure with this exception: Press the SET button twice and SET 2 will show in the display window. Each button can be set for SET 1 and SET 2 in both AM and FM. This allows a total of 12 AM and 12 FM stations to be locked into push-button memory. The stations stored in SET 2 memory can be selected by pressing the corresponding push-button twice. Every time a preset button is used, a corresponding button number will be displayed.

Time Button

Press the TIME button to change the display between radio frequency and time.

General Information

This radio complies with Part 15 of FCC rules and with RSS-210 of Industry Canada. Operation is subject to the following conditions:

1. This device may not cause harmful interference,
2. This device must accept any interference received, including interference that may cause undesired operation.

NOTE: Changes or modifications not expressly approved by the party responsible for compliance could void the user's authority to operate the equipment.

CD Player Operation

NOTE: The ignition switch must be in the ON or ACC position and the Power / Volume control pushed ON before the CD player will operate.

Inserting The Compact Disc

CAUTION!

This CD player will accept 4 ¾ inch (12 cm) discs only. The use of other sized discs may damage the CD player mechanism.

You may either insert or eject a disc with the radio OFF.

If you insert a disc with the ignition ON and the radio OFF, the display will show the time of day. If you insert a disc with the ignition OFF, the display will show the time of day for about 5 seconds, then go out.

If you insert a disc with the ignition ON and the radio ON, the unit will switch from radio to CD mode and begin to play when you insert the disc. The display will show the disc number, the track number, and index time in minutes and seconds. Play will begin at the start of track 1.

LOAD/ EJT — Load

Press the LOAD/ EJT button and the button with the corresponding number where the CD is being loaded. After the radio displays “load” insert the CD into the player.

Radio display will show “loading” when it is being loaded.

LOAD / EJT — Eject

Press the LOAD/ EJT button and the button with the corresponding number where the CD was loaded and the disc will unload and move to the entrance for easy removal.

Radio display will show “ejecting” when it is being ejected.

If you have ejected a disc and have not removed it within 15 seconds, it will be reloaded. If the CD is not removed, the radio will continue to play the non-removed CD. If the CD is removed and there are other CD's in the radio, the radio will play the next CD. If the CD is removed and there are no other CD's in the radio, the radio will return to the last selected AM or FM mode.

The disc can be ejected with the radio and ignition OFF.

Seek

Press the top of the SEEK button for the next selection on the CD. Press the bottom of the button to return to the beginning of the current selection, or return to the beginning of the previous selection if the CD is within the first second of the current selection.

Scan

Press the Scan button to scan through each track on the CD currently playing.

FF/TUNE/RW

Press FF (Fast Forward) and the CD player will begin to fast forward until FF is released. The RW (Reverse) button works in a similar manner.

Random Play — SET / RND

Press the RND button while the CD is playing to activate Random Play. This feature plays the tracks on the disc in random order to provide an interesting change of pace.

Press the SEEK button to move to the next randomly selected track.

Press TUNE FF to fast forward through the tracks. Press the FF button a second time to stop the fast forward feature. If TUNE RW is pressed, the current track will reverse to the beginning of the track and begin playing.

Press the SET / RND button a second time to stop Random Play.

PTY (Program Type) Button

Pressing this button once will turn on the PTY mode for 5 seconds. If no action is taken during the 5 second time out the PTY icon will turn off. Pressing the PTY button within 5 seconds will allow the program format type to be selected. Many radio stations do not currently broadcast PTY information.

Toggle the PTY button to select the following format types:

Program Type	Radio Display
Adult Hits	Adlt Hit
Classical	Classicl
Classic Rock	Cls Rock
College	College
Country	Country

Program Type	Radio Display
Emergency	ALERT!
Emergency Test	Test
Information	Inform
Jazz	Jazz
Foreign Language	Language
News	News
Nostalgia	Nostalgia
Oldies	Oldies
Personality	Persnlty
Public	Public
Rhythm and Blues	R & B
Religious Music	Rel Musc
Religious Talk	Rel Talk
Rock	Rock
Soft	Soft
Soft Rock	Soft Rck
Soft Rhythm and Blues	Soft R&B
Sports	Sports
Talk	Talk
Top 40	Top 40
Weather	Weather

By pressing the SEEK button when the PTY icon is displayed, the radio will be tuned to the next frequency station with the same selected PTY name. The PTY function only operates when in the FM mode.

The radio display will flash "SEEK" and the selected PTY program type when searching for the next PTY station. If no station is found with the selected PTY program type, the radio will return to the last station.

If a preset button is activated while in the PTY (Program Type) mode, the PTY mode will be exited and the radio will tune to the preset station.

By pressing the SCAN button when the PTY icon is displayed, the radio will stop at every PTY station on the band and list each corresponding program type in the radio display.

Time

Press the TIME button to change the display from elapsed CD playing time to time of day.

REMOTE SOUND SYSTEM CONTROLS — IF EQUIPPED

The remote sound system controls are located on the rear surface of the steering wheel. Reach behind the wheel to access the switches.

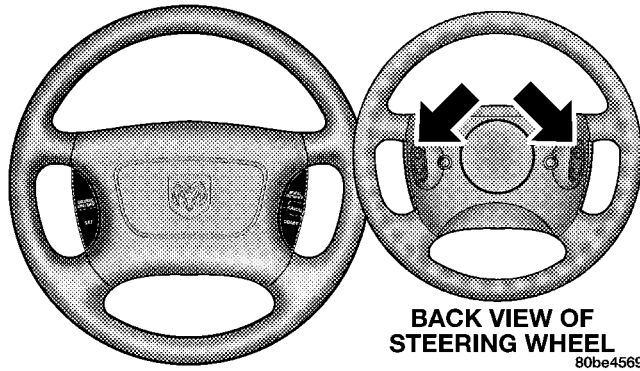

The right hand control is a rocker type switch with a push button in the center. Pressing the top of the switch will increase the volume and pressing the bottom of the switch will decrease the volume.

The button located in the center of the right hand control will switch modes to Radio, Tape, or CD.

The left hand control is a rocker type switch with a push button in the center. The function of the left hand control is different depending on which mode you are in.

The following describes the left hand control operation in each mode.

Radio Operation

Pressing the top of the switch will SEEK up for the next listenable station and pressing the bottom of the switch will SEEK down for the next listenable station.

The button located in the center of the left hand control will tune to the next pre-set station that you have programmed in the radio pre-set push-buttons.

Tape Player

Pressing the top of the switch once will go to the next selection on the cassette. Pressing the bottom of the switch once will go to the beginning of the current selection or to the beginning of the previous selection if it is within the first 5 seconds of the current selection.

If you press the switch up or down twice it plays the second selection, three times, it will play the third, etc.

The button in the center of the left hand switch has no function in this mode.

CD Player

Pressing the top of the switch once will go to the next track on the CD. Pressing the bottom of the switch once will go to the beginning of the current track or to the beginning of the previous track if it is within one second after the current track begins to play.

If you press the switch up or down twice it plays the second track, three times, it will play the third, etc.

The button in the center of the left hand switch changes CD's on the 6-Disc in-dash CD changer radio (RBQ). This button does not function for all other radios.

CASSETTE TAPE AND PLAYER MAINTENANCE

To keep the cassette tapes and player in good condition, take the following precautions:

1. Do not use cassette tapes longer than C-90; otherwise, sound quality and tape durability will be greatly diminished.
2. Keep the cassette tape in its case to protect from slackness and dust when it is not in use.
3. Keep the cassette tape away from direct sunlight, heat and magnetic fields such as the radio speakers.
4. Before inserting a tape, make sure that the label is adhering flatly to the cassette.
5. A loose tape should be corrected before use. To rewind a loose tape, insert the eraser end of a pencil into the tape drive gear and twist the pencil in the required directions.

Maintain your cassette tape player. The head and capstan shaft in the cassette player can pick up dirt or tape deposits each time a cassette is played. The result of deposits on the capstan shaft may cause the tape to wrap around and become lodged in the tape transport. The

other adverse condition is low or “muddy” sound from one or both channels, as if the treble tone control were turned all the way down. To prevent this, you should periodically clean the head with a commercially available WET cleaning cassette.

As preventive maintenance, clean the head about every 30 hours of use. If you wait until the head becomes very dirty (noticeably poor sound), it may not be possible to remove all deposits with a simple WET cleaning cassette.

COMPACT DISC MAINTENANCE

To keep the compact discs in good condition, take the following precautions:

1. Handle the disc by its edge; avoid touching the surface.
2. If the disc is stained, clean the surface with a soft cloth, wiping from center to edge.
3. Do not apply paper or tape to the disc; avoid scratching the disc.
4. Do not use solvents such as benzine, thinner, cleaners, or antistatic sprays.

5. Store the disc in its case after playing.

6. Do not expose the disc to direct sunlight.

7. Do not store the disc where temperatures may become too high.

NOTE: If you experience difficulty in playing a particular disc, it may be damaged (i.e. scratched, reflective coating removed, a hair, moisture or dew on the disc) oversized, or have theft protection encoding. Try a known good disc before considering disc player service.

RADIO OPERATION AND CELLULAR PHONES

Under certain conditions, the cellular phone being On in your vehicle can cause erratic or noisy performance from your radio. This condition may be lessened or eliminated by relocating the cellular phone antenna. This condition is not harmful to the radio. If your radio performance does not satisfactorily “clear” by the repositioning of the antenna, it is recommended that the radio volume be turned down or off during cellular phone operation.

CLIMATE CONTROLS

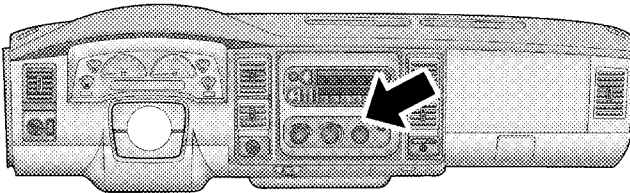

80c647e0

The controls for the heating and ventilation system in this vehicle consist of a series of rotary knobs. These comfort controls can be set to obtain desired interior conditions.

Heater Only

The mode control (located at the right of the control panel) can be set in any of the following positions:

NOTE: To improve your selection choices, the system allows you to operate at intermediate positions between the major modes. These intermediate positions are identified by the small dots.

Bi-Level

➤ Outside air flows through the outlets located in the instrument panel and at the floor.

Panel

➤ Outside air flows through the outlets located in the instrument panel.

Heat

➤ Outside air flows primarily through the floor outlets located under the instrument panel.

Mix

➤ Outside air flows in equal proportions through the floor and defroster outlets.

Defrost

➤ Outside air is primarily directed to the windshield through the defroster outlets located at the base of the windshield, and the demister outlets located at the edge of each side of the instrument panel.

Blower Control

☼ The rotary knob at the left of the control panel is the blower control. Turn the knob clockwise to one of the four positions to obtain the blower speed you desire.

Temperature Control

The rotary knob at the center of the control panel controls the temperature of the interior air. You can choose your degree of comfort by rotating the knob. The coldest temperature setting is to the extreme left (blue region) and the warmest setting is to the extreme right (red region) of the rotation.

Air Conditioning

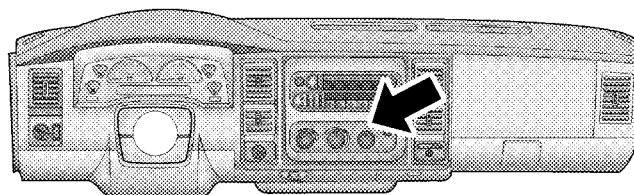

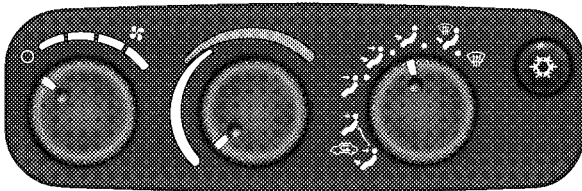

811b54c1

Air Conditioning Operation

To turn on the Air Conditioning, set the fan control at any speed and press the snowflake button located at the right of the control panel. Conditioned air will be directed through the outlets selected by the mode control. A light in the snowflake button shows that the air conditioning is on. Press the button a second time to turn the air conditioning off.

Slight changes in engine speed or power may be noticed when the air conditioning compressor is on. This is a

normal occurrence as the compressor will cycle on and off to maintain comfort and increase fuel economy.

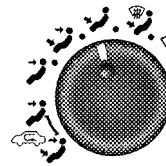

811b54d5

The mode control (at the right of the control panel) can be set in any of the following positions:

NOTE: To improve your selection choices, the system allows you to operate at intermediate positions between the major modes. These intermediate positions are identified by the small dots.

Recirculation Modes (Panel or Bi-Level)

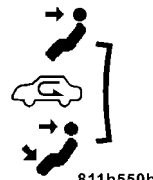

811b550b

Select the recirculation modes when the outside air contains smoke, odors, high humidity, or if rapid cooling is desired. This feature allows for recirculation of interior air only. Air flows through the panel outlets in this mode.

Panel

 Outside air flows through the outlets located in the instrument panel.

Bi-Level

 Outside air flows through the outlets located in the instrument panel and at the floor.

Floor

 Outside air flows primarily through the floor outlets located under the instrument panel.

Mix

 Outside air flows in equal proportions through the floor and defroster outlets.

Defrost

 Outside air is primarily directed to the windshield through the defroster outlets located at the base of the windshield, and the demister outlets located at the edge of each side of the instrument panel.

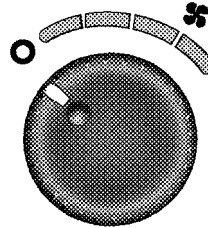
Blower Control

80a01359

The rotary knob on the left of the control panel is the blower control. Turn the knob clockwise to one of the four positions to obtain the blower speed you desire.

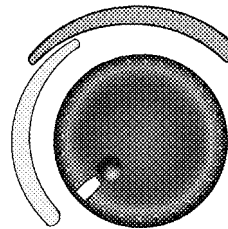
Temperature Control

80a0135a

The rotary knob at the center of the control panel controls the temperature of the interior air. You can choose your degree of comfort by rotating the knob. The coldest temperature setting is to the extreme left (blue region) and the warmest setting is to the extreme right (red region) of the rotation.

Circulation

The cab is designed with features to promote outside air circulation. There are grilles in the cab back panel. These are air exhausters that provide the means for regular exchange of cab air.

Side window demisters direct air flow specifically to the window glass to help prevent interior fogging of the glass. They are located in the extreme outside upper edges of the instrument panel. The demisters also provide extra air ducts for circulation. They are in operation whenever the Floor, Mix or Defrost modes are in use.

NOTE: When you turn off the engine you may hear a hissing sound from under the hood for a short period of time. This is a normal condition that occurs if the air conditioning system has been on. It is not an indication of a problem with the air conditioning system.

Operating Tips**Fast Cooldown**

For a fast cooldown, turn the blower fan rotary knob to the extreme right position, turn the mode control to the panel fresh position, press the snowflake button to turn

on the air conditioning, and drive with the windows open for the first few minutes. Once the hot air has been expelled, close the windows and turn the mode selector to the Recirculation Panel Mode or Recirculation Mode Bi-level position. When a comfortable condition has been reached, choose a mode position and adjust the temperature control knob and blower speed as necessary to maintain comfort. For high humidity conditions it may be necessary to remain in the Recirculation mode to maintain comfort.

Window Fogging

Windows will fog on the inside when the humidity inside the vehicle is high. This often occurs in mild or cool temperatures when it's rainy or humid. In most cases turning on the Air-conditioning (pressing the snowflake button) will clear the fog. Adjust the temperature control, air direction and blower speed to maintain comfort.

As the temperature gets colder it may be necessary to direct air onto the windshield by using MIX Mode position on the control. Adjust the temperature control and blower speed to maintain comfort. High blower

speeds will reduce fogging. Interior fogging on the windshield can be quickly removed by selecting the defrost mode.

Regular cleaning of the inside of the windows with a non-filming cleaning solution (vinegar and water works very well) will help prevent contaminants (cigarette smoke, perfumes, etc.) from sticking to the windows. Contaminates increase the rate of window fogging.

Summer Operation



























Air conditioned vehicles must be protected with a high quality antifreeze coolant during summer to provide proper corrosion protection and to raise the boiling point of the coolant for protection against overheating. A 50 % concentration is recommended.

When using the air conditioner in extremely heavy traffic in hot weather especially when towing a trailer, additional engine cooling may be required. If this situation is encountered, operate the transmission in a lower gear. When stopped in heavy traffic, it may be necessary to shift into NEUTRAL and depress the accelerator slightly for fast idle operation.

Winter Operation

When operating the system during the winter months, make sure the air intake, located directly in front of the windshield, is free of ice, slush, snow, or other obstructions.

Operation Tips Chart

WEATHER	CONTROL SETTINGS
<p>HOT WEATHER AND VEHICLE INTERIOR IS VERY HOT</p> 	<p>Start the vehicle, open the windows and turn the blower control knob to the high position (full clockwise). Set Mode control knob at or between  and . Set temperature control to full cold and press the  button on. After the hot air has been expelled, close the windows and turn the mode control knob to the  setting (counterclockwise) at either  or , or press the  button (if so equipped). Once comfortable, choose a mode position and adjust temperature control and blower speed as necessary for comfort.</p>
<p>WARM WEATHER</p> 	<p>If sunny, set the Mode control at or near  and press the  button on. If cloudy or dark, set the Mode control at or near . No  is necessary.</p>
<p>COOL OR COLD HUMID CONDITIONS</p> 	<p>If sunny, set the Mode control at or between  and , then press the  button on. If cloudy or dark set the Mode control at or near . No  is necessary.</p>
<p>COLD DRY CONDITIONS</p> 	<p>In cloudy or dark weather set the Mode control at or near . If sunny, set the Mode control at or between  and  and for snowy or very cold weather requiring extra heat to the windshield, use .</p>
<p>WINDOW FOGGING</p>	<p>In most cases turning on the Air-Conditioning (press the  button) will clear the fog, then adjust temperature control, air direction and blower speed to maintain comfort. As it gets colder it may be necessary to direct air onto the windshield. If so, set the Mode control at  or  and adjust temperature control and blower speed to maintain comfort. Higher blower speeds will reduce fogging.</p>

REAR WINDOW DEFROSTER – Quad-Cab Only

CAUTION!

Use care when washing the inside of the rear window to prevent damage to heating elements. Use a soft cloth and a mild washing solution, wiping parallel to the heating elements. Also, keep all objects a safe distance from the window to prevent damaging the heating elements.

STARTING AND OPERATING

CONTENTS

■ Starting Procedures	144	□ NV244 Transfer Case Operating Information / Precautions	157
□ Manual Transmission	144	□ Shifting Procedure - NV244 Transfer Case	160
□ Automatic Transmission	144	■ Limited-Slip Differential — If Equipped	162
□ Normal Starting	144	■ Parking Brake	163
□ Engine Block Heater — If Equipped	146	■ Brake System	164
■ Shifting	146	□ Rear Wheel Anti-Lock Brake System	164
□ Automatic Transmission	146	□ Four-Wheel Anti-Lock Brake System — If Equipped	165
□ Manual Transmission	150	■ Power Steering	166
■ Four-Wheel Drive Operation	151	■ Rocking The Vehicle	167
□ NV 233 Transfer Case Operating Information/Precautions	151	■ Tire Safety Information	167
□ Shifting Procedure - NV233 Transfer Case	155		

□ Tire Markings	167	■ Fuel Requirements	184
□ Tire Identification Number (TIN)	171	□ Reformulated Gasoline	184
□ Tire Loading And Tire Pressure	172	□ Gasoline/Oxygenate Blends	185
■ Tires—General Information	175	□ MMT In Gasoline	185
□ Tire Pressure	175	□ Sulfur In Gasoline	185
□ Tire Inflation Pressures	176	□ Materials Added To Fuel	186
□ Radial-Ply Tires	178	■ Adding Fuel	186
□ Compact Spare Tire — If Equipped	178	□ Fuel Filler Cap (Gas Cap)	186
□ Tire Spinning	179	□ Fuel Tank Filler Tube	187
□ Tread Wear Indicators	180	□ Fuel System Cautions	188
□ Replacement Tires	180	□ Carbon Monoxide Warnings	189
□ Alignment And Balance	181	■ Catalytic Converter	189
■ Supplemental Tire Pressure Information	182	■ Vehicle Loading	191
■ Tire Chains	182	□ Certification Label	191
■ Snow Tires	183	□ Curb Weight	192
■ Tire Rotation Recommendations	183	□ Loading	192

■ Loading Wide Building Materials	194	□ Cooling System Tips—Trailer Towing	201
■ Trailer Towing	195	■ Snowplow	201
□ Definitions	195	□ Dodge Dakota Models	201
□ Trailer And Tongue Weight	197	■ Recreational Towing (Behind Motorhome, Etc.) Of 4X4 Vehicles	202
□ Trailer Towing—Hitches	198	□ Recreational Towing Procedure	202
□ Trailer Towing Information (Maximum Trailer Weight Ratings)	199	□ Returning To Normal Operation	204
□ Trailer Towing Requirements	199	■ Traction	206
□ Trailer Tow Wiring	200	■ Equipment Identification Plate	206

STARTING PROCEDURES

The starter should not be operated for more than 15 second intervals. Waiting a few seconds between such intervals will protect the starter from overheating.

Manual Transmission

Apply the parking brake, place the gearshift control lever in NEUTRAL and depress clutch pedal to the floor before starting the vehicle. This vehicle is equipped with a clutch interlocking ignition system. It will not start unless the clutch is depressed.

Automatic Transmission

Start the engine with the shift lever in NEUTRAL or PARK position. Apply the brake before shifting to any driving range.

WARNING!

Do not attempt to push or tow your vehicle to get it started. Vehicles equipped with an automatic transmission cannot be started this way. Unburned fuel could enter the catalytic converter and once the engine has started, ignite and damage the converter and vehicle. If the vehicle has a discharged battery, booster cables may be used to obtain a start from a booster battery or the battery in another vehicle. This type of start can be dangerous if done improperly. See section 6 of this manual for the proper jump starting procedures and follow them carefully.

Normal Starting

Normal starting of either a warm or cold engine is obtained without pumping or depressing the accelerator pedal. Turn the key to the START position and release when the engine starts. If the engine fails to start within 10 seconds, turn the key to the OFF position, wait 5 seconds, then repeat the starting procedure.

If Engine Fails To Start

If the engine fails to start after you have followed the Normal Starting procedure, it may be flooded. Push the accelerator pedal all the way to the floor and hold it there while cranking the engine. This should clear any excess fuel in case the engine is flooded.

CAUTION!

To prevent damage to the starter, do not crank the engine for more than 15 seconds at a time. Wait 10 to 15 seconds before trying again.

If the engine has been flooded, it may start to run, but not have enough power to continue running when the key is released. If this occurs, continue cranking with the accelerator pedal pushed all the way to the floor. Release the accelerator pedal and the key once the engine is running smoothly.

If the engine shows no sign of starting after two 15 second periods of cranking with the accelerator pedal held to the floor, the Normal Starting procedure should be repeated.

WARNING!

Never pour fuel or other flammable liquid into the throttle body air inlet opening in an attempt to start the vehicle. This could result in flash fire causing serious personal injury.

5

After Starting

The idle speed is automatically controlled on fuel injected engines and will decrease as the engine warms up.

CAUTION!

Long periods of engine idling can cause excessive exhaust temperatures which can damage your vehicle. Do not leave your vehicle unattended with the engine running.

WARNING!

Do not leave children or animals inside parked vehicles in hot weather. Interior heat build up may cause serious injury or death.

Engine Block Heater — If Equipped

The engine block heater warms engine coolant and permits quicker starts in cold weather. Connect the cord to a standard 110-115 volt AC electrical outlet with a grounded, three wire extension cord.

The engine block heater cord is located at the right front of the engine compartment for all engine applications.

WARNING!

Remember to disconnect the cord before driving. Damage to the 110-115 volt electrical cord could cause electrocution.

SHIFTING**Automatic Transmission**

The gear shift lever is mounted on the right side of the steering column. To engage a gear for driving, move the shift lever from P-Park or N-Neutral to the desired gear range (R-Reverse, D-Drive, 2-Second, or 1-First). To move the shift lever, pull it toward you, then release it when the desired gear range is reached. The Transmission Range Indicator (labeled "Gear Selector") in the instrument cluster shows the selected gear range. The Indicator is illuminated for night driving.

Brake/Transmission Interlock System

This system prevents you from moving the gear shift out of Park and into any gear unless the brake pedal is pressed. This system is active only while the ignition

switch is in the ON position. Always depress the **brake pedal first**, before moving the gear selector out of PARK.

Gear Ranges

DO NOT race the engine when shifting from Park or Neutral position into another gear range.

“P” Park

This position supplements parking brake by locking the transmission. The engine can be started in this range. Never use Park while the vehicle is in motion. Apply the parking brake when leaving vehicle in this range. Always apply the parking brake first, then place the selector in the Park position.

WARNING!

Your vehicle could move and injure you and others if it is not completely in P (Park). Check by trying to move the gearshift lever back and forth without first pulling the lever toward you, after you have set it in P. Make sure it is in Park before leaving the vehicle.

WARNING!

Never use Park position on an automatic transmission as a substitute for the parking brake. Always apply parking brake fully when parked to guard against vehicle movement and possible injury or damage.

WARNING!

It is dangerous to shift the selector lever out of “P” or “N” if the engine speed is higher than idle speed. If your foot is not firmly on the brake pedal, the vehicle could accelerate quickly forward or in reverse. You could lose control of the vehicle and hit someone or something. Only shift into gear when the engine is idling normally and when your right foot is firmly on the brake pedal.

5

“R” Reverse

Use this range only after the vehicle has come to a complete stop.

“N” Neutral

Shift to Neutral when vehicle is standing for prolonged periods with engine running. Engine may be started in this range. Set the parking brake if you must leave the vehicle.

“D” Drive

Use this position for most city and highway driving.

“2” Second

Use this position for driving slowly in heavy city traffic or on mountain roads where more precise speed control is desirable. Use it also when climbing long grades, and for engine braking when descending moderately steep grades. To prevent excessive engine speed do not exceed 45 mph (72 km/h) in this range.

“1” First

Use this position for driving up very steep hills and for engine braking at low speeds 25 mph (40 km/h) or less when going down hill. To prevent excessive engine speed do not exceed 25 mph (40 km/h) in this range.

Overdrive

The transmission contains a fourth and fifth (if equipped) speed (Overdrive) and will automatically shift from Drive to Overdrive if the following conditions are present:

- The transmission selector is in Drive.
- Engine coolant has reached normal operating temperature.
- Vehicle speed is above approximately 30 mph (48 km/h).
- The “O/D OFF” button has not been activated.
- Transmission has reached normal operating temperature.

Overdrive can be locked out by pressing the O/D Off button located at the end of the transmission gear shift lever. A light in the instrument cluster shows that the feature has been deactivated. Pressing the button a second time restores the Overdrive function.

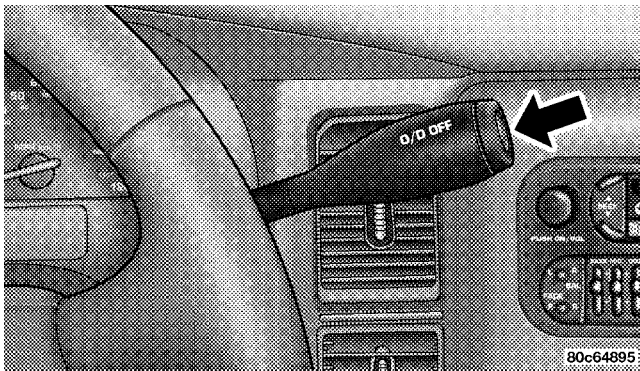

The “O/D OFF” feature must be selected, if desired, each time the engine is started.

NOTE: If the vehicle is started in extremely cold temperatures, the transmission may not shift into Overdrive and will automatically select the most desirable gear for operation at this temperature. Normal operation will resume when the transmission fluid temperature has risen to a suitable level. Refer also to the Note under torque converter clutch, later in this section.

If the transmission temperature gets extremely hot, the transmission will automatically select the most desirable gear for operation at this temperature. If the transmission temperature becomes hot enough the O/D OFF and/or TRANS TEMP light(s) may illuminate and the transmission may downshift out of Overdrive until the transmission cools down. After cooldown, the transmission will resume normal operation.

When To Lock Out Overdrive

When driving in hilly areas, towing a trailer, carrying a heavy load, or whenever frequent transmission shifting occurs, press the “O/D OFF” button. This will improve performance and reduce the potential for transmission overheating or failure due to excessive shifting.

Torque Converter Clutch

A feature designed to improve fuel economy is included in all automatic transmissions. A clutch within the torque converter engages automatically at a calibrated speed at light throttle. It engages at higher speeds under heavier acceleration. This may result in a slightly different feeling or response during normal operation in high gear. When

the vehicle speed drops below a calibrated speed, or during acceleration, the clutch automatically and smoothly disengages. The feature is operational in Overdrive and in Drive.

NOTE: The torque converter clutch will not engage until the transmission fluid and engine coolant are warm [usually after 1-3 miles (1.6 - 4.8 km) of driving]. Because the engine speed is higher when the torque converter clutch is not engaged, it may seem as if the transmission is not shifting into Overdrive when cold. This is normal. Pressing the O/D OFF button, when the transmission is sufficiently warm, will demonstrate that the transmission is able to shift into and out of overdrive.

NOTE: If the vehicle has not been driven in several days, the first few seconds of operation after shifting the transmission into gear may seem sluggish. This is due to the fluid partially draining from the torque converter into the transmission. This condition is normal and will not cause damage to the transmission. The torque converter will refill within five seconds of shifting from Park into any other gear position.

Manual Transmission

NOTE: The parking brake should be engaged before leaving the vehicle, especially on an incline.

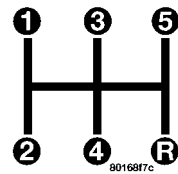

Use each gear in numerical order - do not skip a gear. Be sure the transmission is in FIRST gear— not THIRD, when starting from a standing position; otherwise damage to the clutch can result from starting in THIRD.

For most city driving you will find it easier to use only the lower gears. For steady highway driving with light accelerations, 5th gear is recommended. To shift into 5th gear, move the shift lever to the right beyond the spring pressure point and push it forward. When shifting from 5th to 4th gear, pull the lever down toward you in one motion. Do not pull the lever sharply left as you may shift accidentally into 2nd gear and damage the transmission or engine.

To shift into Reverse, come to a complete stop. Depress the clutch and pause briefly to allow the gear train to spin down. Move the shift lever from the Neutral position straight across and back into Reverse.

Never drive with your foot resting on the clutch pedal. Do not attempt to hold the vehicle on a hill with the clutch pedal partially engaged, as this will cause abnormal wear on the clutch.

Recommended Shift Speeds

To use your manual transmission for fuel economy it should be upshifted as listed below. Shift at the vehicle speeds listed for acceleration and cruise conditions (relatively steady speeds).

Recommended Manual Transmission Shift Speeds in MPH (KM/H)					
Engine	Model	1 to 2	2 to 3	3 to 4	4 to 5
3.7L/ 4.7L	All	15 (24)	25 (40)	40 (64)	45 (72)

Higher upshift speeds may be used to obtain a desired acceleration rate.

Downshifting

Moving from a high gear down to the lower gears in descending numerical order is recommended to preserve brakes when driving down steep hills. In addition, downshifting at the right time provides better acceleration when you want to resume speed. For acceleration initiated at speeds less than 20 mph (30 km/h), second gear is recommended.

FOUR-WHEEL DRIVE OPERATION

NV 233 Transfer Case Operating Information/Precautions

The NV233 is an electric shift transfer case and is operated by the 4WD Control Switch (Transfer Case Switch), which is located on the instrument panel.

The NV233 transfer case provides 4 mode positions: 2 (rear) wheel drive high range, 4 wheel drive high range, 4 wheel drive low range, and neutral.

The NV233 transfer case is designed to be driven in the 2 wheel drive position (2WD) for normal street and highway conditions (dry hard surfaced roads).

When additional traction is required, the transfer case 4HI and 4LO positions can be used to lock the front and rear driveshafts together and force the front and rear wheels to rotate at the same speed. This is accomplished by rotating the 4WD Control Switch to the desired position - see Shifting Procedure section for specific shifting instructions. The 4HI and 4LO positions are designed for loose, slippery road surfaces only. Driving in the 4HI and 4LO positions on dry hard surfaced roads may cause increased tire wear and damage to the driveline components.

The transfer case Neutral (N) position is selected by depressing the recessed button located on the lower left hand corner of the 4WD Control Switch.

NOTE: The transfer case Neutral (N) position is to be used for recreational towing only. See Recreational Towing section for specific procedures on shifting into and out of Neutral (N).

Transfer Case Position Indicator Lights

Transfer case position indicator lights are located on the Four-Wheel-Drive Control Switch, found on your instrument panel, and indicate the current and desired transfer

case selection. When you select a different transfer case position, the indicator lights will do the following:

If All Shift Requirements are Met

1. The current position indicator light will turn OFF.
2. The selected position indicator light will flash until the transfer case completes the shift.
3. When the shift is complete, the indicator light for the selected position will stop flashing and remain ON.

If One or More Shift Requirements are not Met

1. The indicator light for the current position will remain ON.
2. The newly selected position indicator light will flash.
3. The transfer case **will not** shift.

NOTE: Before retrying a selection, make certain that all the necessary requirements for selecting a new transfer case position have been met. To retry the selection, turn the control knob back to the current position, wait five (5)

seconds, and retry selection. To find the shift requirements, refer to the "Shifting Procedure" for your transfer case, located in this section of the owner's manual.

The "SERVICE 4WD" warning light monitors the electric shift 4WD system. If this light remains on after engine start up or illuminates during driving, it means that the 4WD system is not functioning properly and that service is required.

WARNING!

Always engage the parking brake when powering down the vehicle if the "Service 4WD" light is illuminated. Not engaging the parking brake may allow the vehicle to roll which may cause personal injury.

NOTE: Do not attempt to make a shift while only the front or rear wheels are spinning. The NV233 transfer case is not equipped with a synchronizer and therefore the front and rear driveshaft speeds must be equal for the shift to take place. Shifting while only the front or rear wheels are spinning can cause damage to the transfer case.

When operating your vehicle in 4LO, the engine speed is approximately three times that of the 2WD or 4HI positions at a given road speed. Take care not to overspeed the engine and do not exceed 25 mph (40 km/h).

Proper operation of 4 wheel drive vehicles depends on tires of equal size, type and circumference on each wheel. Any difference in tire size can cause damage to the transfer case.

Because 4 wheel drive provides improved traction, there is a tendency to exceed safe turning and stopping speeds. Do not go faster than road conditions permit.

WARNING!

You or others could be injured if you leave the vehicle unattended with the transfer case in the Neutral (N) position without first fully engaging the parking brake. The transfer case Neutral (N) position disengages both the front and rear driveshafts from the powertrain and will allow the vehicle to move regardless of the transmission position. The parking brake should always be applied when the driver is not in the vehicle.

For additional information on the appropriate use of each transfer case mode position see the information below:

2WD

Rear Wheel Drive High Range - Normal street and highway driving. Dry hard surfaced roads.

4HI

4 Wheel Drive High Range - Locks the front and rear driveshafts together. Forces the front and rear wheels to rotate at the same speed. Additional traction for loose, slippery road surfaces only.

4LO

4 Wheel Drive Low Range - Low speed 4 wheel drive. Locks the front and rear driveshafts together. Forces the front and rear wheels to rotate at the same speed. Additional traction and maximum pulling power for loose, slippery road surfaces only. Do not exceed 25 mph (40 km/h).

N

Neutral - Disengages both the front and rear driveshafts from the powertrain. To be used for flat towing behind another vehicle. See Recreational Towing for more information.

Shifting Procedure - NV233 Transfer Case

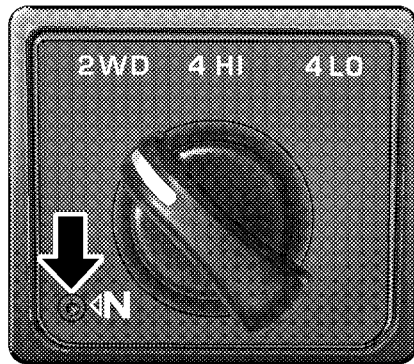

80bc07fb

NOTE: If any of the requirements to select a new transfer case position have not been met, the transfer case will not shift. The indicator light for the previous position will remain ON and the newly selected position indicator light will continue to flash until all the requirements for the selected position have been met. To retry a shift: return the control knob back to the original position, make certain all shift requirements have been met, wait five (5) seconds and try the shift again.

2WD to 4HI or 4HI to 2WD

Rotate the 4WD Control Switch to the desired position. Shifts between 2WD and 4HI can be done with the vehicle stopped or in motion. With the vehicle in motion, the transfer case will engage / disengage faster if you momentarily release the accelerator pedal after turning the control switch. If the vehicle is stopped, the ignition key must be in the ON position with the engine either RUNNING or OFF. This shift cannot be completed if the key is in the accessory position.

NOTE: On vehicles equipped with Anti-Lock Brake Systems, the 4x4 system will not allow shifts between 2WD/ 4HI if the rear wheels are spinning (no traction). In this situation the selected position indicator light will flash and the original position indicator light will remain ON. At this time, reduce speed and stop spinning the wheels to complete the shift. There may be a delay up to 10 seconds for the shift to complete after the wheels have stopped spinning.

4HI to 4LO or 4LO to 4HI

NOTE: When shifting into or out of 4LO some gear noise may be heard. This noise is normal and is not detrimental to the vehicle or occupants.

Shifting can be performed with the vehicle rolling 2-3 mph (3-5 km/h) or completely stopped. USE EITHER OF THE FOLLOWING PROCEDURES:

Preferred Procedure

1. With engine RUNNING, slow vehicle to 2-3 mph (3-5 km/h).
2. Shift the transmission into NEUTRAL (depress clutch on manual transmissions).
3. While still rolling, rotate the transfer case control switch to the desired position.
4. After the desired position indicator light is ON (not flashing), shift transmission back into gear (release clutch on manual transmissions).

Alternate Procedure

1. Bring the vehicle to complete stop.
2. With the key ON and the engine either OFF or RUNNING, shift the transmission into NEUTRAL (depress clutch on manual transmissions).
3. Rotate the transfer case control switch to the desired position.
4. After the desired position indicator light is ON (not flashing), shift transmission back into gear (release clutch on manual transmissions).

NOTE: If steps 1 or 2 of either the Preferred or Alternate Procedure are not satisfied prior to attempting the shift or if they no longer are being met while the shift attempt is in process then the desired position indicator light will flash continuously while the original position indicator light is ON, until all requirements have been met.

NOTE: The ignition key must be ON for a shift to take place and for the position indicator lights to be operable. If the key is not ON then the shift will not take place and no position indicator lights will be on or flashing.

NV244 Transfer Case Operating Information / Precautions

The NV244 is an electric shift transfer case and is operated by the 4WD Control Switch, which is located on the instrument panel.

The NV244 transfer case provides 4 mode positions - Normal all wheel drive high range, 4 wheel drive high range, 4 wheel drive low range, and neutral.

This transfer case is equipped with an inter-axle differential that allows driving the vehicle in the normal all wheel drive position (AWD) at all times on any given road surface, including dry hard surfaced roads. The AWD mode allows the front and rear wheels to rotate at different speeds. This eliminates driveline binding and component wear normally associated with driving the vehicle in the 4HI position on dry hard surfaced roads. This feature provides the safety, security, and convenience of operating in all wheel drive at all times regardless of road conditions.

When additional traction is required, the 4HI and 4LO positions can be used to lock the front and rear drive-shafts together through the transfer case inter-axle differential and force the front and rear wheels to rotate at the same speed. This is accomplished by rotating the 4WD Control Switch to these positions. The 4HI and 4LO positions are intended for loose, slippery road surfaces only. Driving in the 4HI and 4LO positions on dry hard surfaced roads may cause increased tire wear and damage to the driveline components.

The transfer case Neutral (N) position is selected by depressing the recessed button located on the lower left hand corner of the 4WD Control Switch.

NOTE: The transfer case Neutral (N) position is to be used for recreational towing only. (See Recreational Towing section for specific procedures on shifting into and out of Neutral (N).)

Transfer Case Position Indicator Lights

Transfer case position indicator lights are located on the Four-Wheel-Drive Control Switch, found on your instrument panel, and indicate the current and desired transfer

case selection. When you select a different transfer case position, the indicator lights will do the following:

If All Shift Requirements are Met

1. The current position indicator light will turn OFF.
2. The selected position indicator light will flash until the transfer case completes the shift.
3. When the shift is complete, the indicator light for the selected position will stop flashing and remain ON.

If One or More Shift Requirements are not Met

1. The indicator light for the current position will remain ON.
2. The newly selected position indicator light will flash.
3. The transfer case **will not** shift.

NOTE: Before retrying a selection, make certain that all the necessary requirements for selecting a new transfer case position have been met. To retry the selection, turn the control knob back to the current position, wait five (5)

seconds, and retry selection. To find the shift requirements, refer to the "Shifting Procedure" for your transfer case, located in this section of the owner's manual.

The SERVICE 4WD warning light monitors the electric shift 4WD system. If this light remains on after engine start up or illuminates during driving, it means that the 4WD system is not functioning properly and that service is required.

WARNING!

Always engage the parking brake when powering down the vehicle if the "Service 4WD" light is illuminated. Not engaging the parking brake may allow the vehicle to roll which may cause personal injury.

NOTE: Do not attempt to make a shift while only the front or rear wheels are spinning. The NV244 transfer case is not equipped with a synchronizer and therefore the front and rear driveshaft speeds must be equal for the

shift to take place. Shifting while only the front or rear wheels are spinning can cause damage to the transfer case.

When operating your vehicle in 4LO, the engine speed is approximately three times that of the AWD or 4HI positions at a given road speed. Take care not to over-speed the engine and do not exceed 25 mph (40 km/h).

Proper operation of 4 wheel drive vehicles depends on tires of equal size, type and circumference on each wheel. Any difference in tire size can cause damage to the transfer case.

Because 4 wheel drive provides improved traction, there is a tendency to exceed safe turning and stopping speeds. Do not go faster than road conditions permit.

WARNING!

You or others could be injured if you leave the vehicle unattended with the transfer case in the Neutral (N) position without first fully engaging the parking brake. The transfer case Neutral (N) position disengages both the front and rear driveshafts from the powertrain and will allow the vehicle to move regardless of the transmission position. The parking brake should always be applied when the driver is not in the vehicle.

5

For additional information on the appropriate use of each transfer case mode position see the information below:

AWD

Normal All Wheel Drive High Range - Employs inter-axle differential. Allows front and rear wheels to rotate at different speeds. All road surfaces.

4HI

4 Wheel Drive High Range - Locks the transfer case inter-axle differential. Forces front and rear wheels to rotate at the same speed. Additional traction for loose, slippery road surfaces only.

4LO

4 Wheel Drive Low Range - Low speed 4 wheel drive. Locks the transfer case inter-axle differential. Forces the front and rear wheels to rotate at the same speed. Additional traction and maximum pulling power for loose, slippery road surfaces only. Do not exceed 25 mph (40 km/h).

N

Neutral - Disengages both the front and rear driveshafts from the powertrain. To be used for flat towing behind another vehicle. See Recreational Towing for more information.

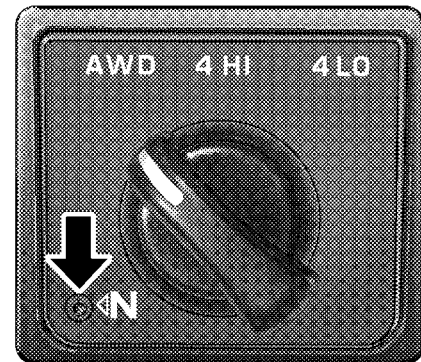
Shifting Procedure - NV244 Transfer Case

80bc0805

NOTE: If any of the requirements to select a new transfer case position have not been met, the transfer case will not shift. The indicator light for the previous position will remain ON and the newly selected position indicator light will continue to flash until all the requirements for the selected position have been met. To retry a shift: return the control knob back to the original position, make certain all shift requirements have been met, wait five (5) seconds and try the shift again.

AWD to 4HI or 4HI to AWD

Rotate the 4WD Control Switch to the desired position. Shifts between AWD and 4HI can be done with the vehicle stopped or in motion. With the vehicle in motion, the transfer case will engage / disengage faster if you momentarily release the accelerator pedal after turning the control switch. If the vehicle is stopped the ignition key must be in the ON position with the engine either RUNNING or OFF. This shift cannot be completed if the key is in the accessory position.

NOTE: On vehicles equipped with a Anti-Lock Brake Systems, the 4x4 system will not allow shifts between AWD/ 4HI if the rear wheels are spinning (no traction). In this situation the selected position indicator light will flash and the original position indicator light will remain ON. At this time, reduce speed and stop spinning the wheels to complete the shift. There may be a delay up to 10 seconds for the shift to complete after the wheels have stopped spinning.

NOTE: Delayed shifting out of the 4HI position may be experienced due to uneven tire wear, low tire pressure, or excessive loading.

4HI to 4LO or 4LO to 4HI

NOTE: When shifting into or out of 4LO some gear noise may be heard. This noise is normal and is not detrimental to the vehicle or occupants.

Shifting can be performed with the vehicle rolling 2-3 mph (3-5 km/h) or completely stopped. USE EITHER OF THE FOLLOWING PROCEDURES:

Preferred Procedure

1. With engine RUNNING, slow vehicle to 2-3 mph (3-5 km/h).
2. Shift the transmission into NEUTRAL (depress clutch on manual transmissions).
3. Ensure ignition key is in the ON position with the engine either RUNNING or OFF. While still rolling, rotate the transfer case control switch to the desired position.
4. After the desired position indicator light is ON (not flashing), shift transmission back into gear (release clutch on manual transmissions).

Alternate Procedure

1. Bring the vehicle to complete stop.
2. With the key ON and the engine either OFF or RUNNING, shift the transmission into NEUTRAL (depress clutch on manual transmissions).
3. Rotate the transfer case control switch to the desired position.
4. After the desired position indicator light is ON (not flashing), shift transmission back into gear (release clutch on manual transmissions).

NOTE: If steps 1 or 2 of either the Preferred or Alternate Procedure are not satisfied prior to attempting the shift or if they no longer are being met while the shift attempt is in process, then the desired position indicator light will flash continuously while the original position indicator light is ON, until all requirements have been met.

NOTE: The ignition key must be ON for a shift to take place and for the position indicator lights to be operable. If the key is not ON then the shift will not take place and no position indicator lights will be on or flashing.

LIMITED-SLIP DIFFERENTIAL — IF EQUIPPED

The limited-slip differential provides additional traction on snow, ice, mud, sand and gravel. It improves traction when there is a difference between the characteristics of the surface under the right and left rear wheels. During normal driving and cornering, the limited-slip unit is similar to a conventional differential. But on a slippery surface, the differential delivers more of the driving effort to the wheel having the better traction.

WARNING!

On vehicles equipped with a limited-slip differential, never run the engine with one rear wheel off the ground. The vehicle may drive through the rear wheel remaining on the ground and cause you to lose control of the vehicle.

Care should be taken to avoid sudden accelerations when both rear wheels are on a slippery surface. This could cause both rear wheels to spin, and allow the vehicle to slide sideways on the crowned surface of a road or in a turn.

PARKING BRAKE

The parking brake should be applied whenever the driver is not in the vehicle.

The foot operated parking brake is positioned below the lower left corner of the instrument panel.

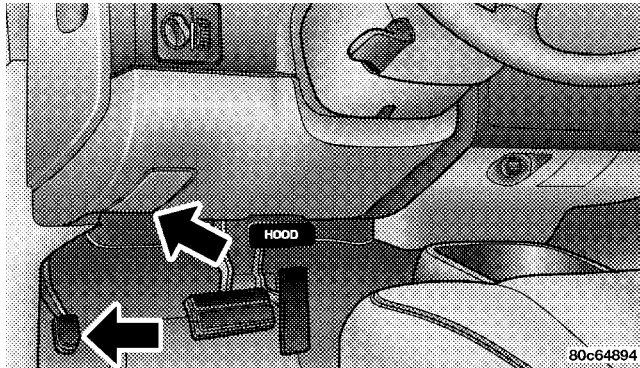

To apply the parking brake: Place your foot on the parking brake pedal and push firmly downward as far as the pedal will go. When the parking brake is applied and the ignition is ON, the BRAKE light in the instrument cluster will light.

NOTE: The BRAKE light in the instrument cluster indicates only that the parking brake is applied—it does not indicate the degree of application.

To release the parking brake: Pull the parking brake release handle towards you. The BRAKE light in the instrument cluster will go out when the parking brake is disengaged.

To park on a hill: You must make sure that the parking brake is fully applied and the gear shift lever is in PARK (for an automatic transmission) or in REVERSE or FIRST (for a manual transmission). You should apply the parking brake before shifting to PARK; otherwise, the load on the transmission locking mechanism may make it difficult to move the shift lever out of the Park position.

When parking on a hill, turn the front wheels:

- **Toward** the curb on a **downhill** grade.
- **Away** from the curb on an **uphill** grade.

WARNING!

- **Always fully apply the parking brake when leaving your vehicle, or vehicle may roll and cause damage or injury. Also be certain to leave an automatic transmission in Park, a manual transmission in Reverse or first gear. Failure to do so may cause the vehicle to roll and cause damage or injury.**
- **Be sure the parking brake is fully disengaged before driving. Failure to do so can lead to brake failure and an accident.**
- **Leaving children in a vehicle unattended is dangerous for a number of reasons. A child or others could be injured. Children should be warned not to touch the parking brake or the gear selector lever. Don't leave the key in the ignition. A child could operate power windows, other controls, or move the vehicle.**

BRAKE SYSTEM

In the event power assist is lost for any reason (for example, repeated brake applications with the engine off), the brakes will still function. The effort required to brake the vehicle will be significantly increased over that required with the power system operating.

If either the front or rear hydraulic system loses normal capability, the remaining system will still function with some loss of braking effectiveness. This will be evident by increased pedal travel during application, greater pedal force required to slow or stop, and activation of the Brake Warning light and the ABS light during brake use.

Rear Wheel Anti-Lock Brake System

This Anti-Lock Brake System provides increased vehicle stability and brake performance under most braking conditions. The system automatically controls the operation of the rear brakes to prevent rear wheel lockup.

The system remains operational in the four-wheel drive mode. The level of performance is reduced when the front brakes are locked up. This will cause the rear brakes to lock-up through the drivetrain, which may reduce the effectiveness of the anti-lock system.

During severe braking conditions, particularly with changing road surfaces, such as ice to concrete, a slight drop or minor pulsation may be felt in the brake pedal.

WARNING!

Both Anti-Lock Brake Systems contain sophisticated electronic equipment. It may be susceptible to interference caused by improperly installed or high output radio transmitting equipment. This interference can cause possible loss of anti-lock braking capability. Installation of such equipment should be done by qualified professionals.

Four-Wheel Anti-Lock Brake System — If Equipped

This Anti-Lock Brake System is designed to aid the driver in maintaining vehicle control under adverse braking conditions. The system operates with a separate computer to modulate hydraulic pressure to prevent wheel lock-up and help avoid skidding on slippery surfaces.

The system's pump motor runs during an ABS stop to provide regulated hydraulic pressure. The pump motor makes a low humming noise during operation, which is normal.

The Anti-Lock Brake System includes an amber ABS warning light. When the light is illuminated, the Anti-Lock Brake System is not functioning. The system reverts to standard non-anti-lock brakes. Turning the ignition OFF and ON again may reset the Anti-Lock Brake System if the fault detected was only momentary.

WARNING!

Pumping of the Anti-Lock Brakes will diminish their effectiveness and may lead to an accident. Pumping makes the stopping distance longer. Just press firmly on your brake pedal when you need to slow down or stop.

WARNING!

- **Anti-lock system (ABS) cannot prevent the natural laws of physics from acting on the vehicle, nor can it increase braking or steering efficiency beyond that afforded by the condition of the vehicle brakes and tires or the traction afforded.**
- **The ABS cannot prevent accidents, including those resulting from excessive speed in turns, following another vehicle too closely, or hydroplaning. Only a safe, attentive, and skillful driver can prevent accidents.**
- **The capabilities of an ABS equipped vehicle must never be exploited in a reckless or dangerous manner which could jeopardize the user's safety or the safety of others.**

When you are in a severe braking condition involving use of the Anti-lock Brake System, you will experience some pedal drop as the vehicle comes to a stop. This is the result of the system reverting to the base brake system.

Engagement of the Anti-lock Brake System may be accompanied by a pulsing sensation. You may also hear a clicking noise. These occurrences are normal, and indicate that the system is functioning properly.

POWER STEERING

Your power steering system will provide mechanical steering capability if power assist is lost.

If for any reason the hydraulic pressure is interrupted, it will still be possible to steer your vehicle. Under these conditions you will experience an increase in steering effort and a noticeable amount of "free play" in the steering wheel.

ROCKING THE VEHICLE

If vehicle becomes stuck in snow, sand, or mud, it can often be moved by a rocking motion. Move the gear selector rhythmically between FIRST and REVERSE, while applying slight pressure to the accelerator.

The least amount of accelerator pedal pressure to maintain the rocking motion without spinning the wheels or racing the engine is most effective. Allow the engine to idle with the transmission selector in NEUTRAL for at least one minute after every five rocking-motion cycles. This will minimize overheating and reduce the risk of transmission failure during prolonged efforts to free a stuck vehicle.

TIRE SAFETY INFORMATION

Tire Markings

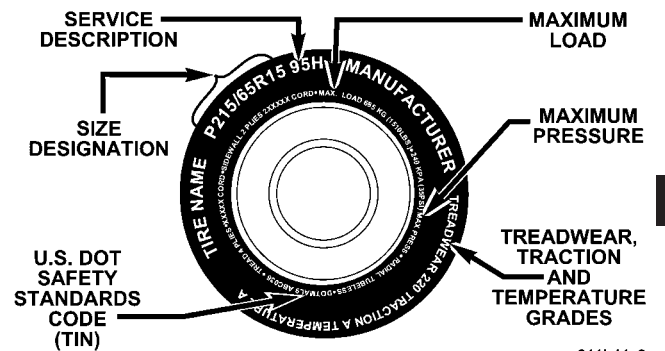

NOTE:

- P(Passenger)-Metric tire sizing is based on U.S. design standards. P-Metric tires have the letter "P" molded into the sidewall preceding the size designation. Example: P215/65R15 95H.
- European Metric tire sizing is based on European design standards. Tires designed to this standard have the tire size molded into the sidewall beginning with the section width. The letter "P" is absent from this tire size designation. Example: 215/65R15 96H
- LT(Light Truck)-Metric tire sizing is based on U.S. design standards. The size designation for LT-Metric tires is the same as for P-Metric tires except for the letters "LT" that are molded into the sidewall preceding the size designation. Example: LT235/85R16.
- Temporary Spare tires are high pressure compact spares designed for temporary emergency use only. Tires designed to this standard have the letter "T" molded into the sidewall preceding the size designation. Example: T145/80D18 103M.
- High Flotation tire sizing is based on U.S. design standards and begins with the tire diameter molded into the sidewall. Example: 31x10.5 R15 LT.

Tire Sizing Chart

EXAMPLE:	
Size Designation:	
P = Passenger car tire size based on U.S. design standards	
"...blank..." = Passenger car tire based on European design standards	
LT = Light Truck tire based on U.S. design standards	
T = Temporary Spare tire	
31 = Overall Diameter in Inches (in)	
215 = Section Width in Millimeters (mm)	
65 = Aspect Ratio in Percent (%)	—Ratio of section height to section width of tire.
10.5 = Section Width in Inches (in)	
R = Construction Code	—"R" means Radial Construction. —"D" means Diagonal or Bias Construction.
15 = Rim Diameter in Inches (in)	

EXAMPLE:	
Service Description:	
95 = Load Index	—A numerical code associated with the maximum load a tire can carry.
H = Speed Symbol	—A symbol indicating the range of speeds at which a tire can carry a load corresponding to its load index under certain operating conditions. —The maximum speed corresponding to the Speed Symbol should only be achieved under specified operating conditions. (ie. tire pressure, vehicle loading, road conditions and posted speed limits).
Load Identification:	
"...blank..."	= Absence of any text on sidewall of the tire indicates a Standard Load (SL) Tire
Extra Load (XL)	= Extra Load (or Reinforced) Tire
Light Load	= Light Load Tire
C,D,E	= Load range associated with the maximum load a tire can carry at a specified pressure
Maximum Load — Maximum Load indicates the maximum load this tire is designed to carry.	
Maximum Pressure — Maximum Pressure indicates the maximum permissible cold tire inflation pressure for this tire.	

Tire Identification Number (TIN)

The TIN may be found on one or both sides of the tire however the date code may only be on one side. Tires with white sidewalls will have the full TIN including date code located on the white sidewall side of the tire.

Look for the TIN on the outboard side of black sidewall tires as mounted on the vehicle. If the TIN is not found on the outboard side then you will find it on the inboard side of the tire.

EXAMPLE:	
DOT MA L9 ABCD 0301	
DOT = Department of Transportation	
	—This symbol certifies that the tire is in compliance with the U.S. Department of Transportation tire safety standards, and is approved for highway use.
MA = Code representing the tire manufacturing location.(2 digits)	
L9 = Code representing the tire size.(2 digits)	
ABCD = Code used by tire manufacturer.(1 to 4 digits)	
03 = Number representing the week in which the tire was manufactured.(2 digits)	
	—03 means the 3rd week.
01 = Number representing the year in which the tire was manufactured.(2 digits)	
	—01 means the year 2001.
	—Prior to July 2000, tire manufacturers were only required to have 1 number to represent the year in which the tire was manufactured. Example: 031 could represent the 3rd week of 1981 or 1991.

Tire Loading and Tire Pressure

Tire Placard Location

NOTE: Some vehicles have a “Tire and Loading Information” placard located on the driver’s side “B” pillar.

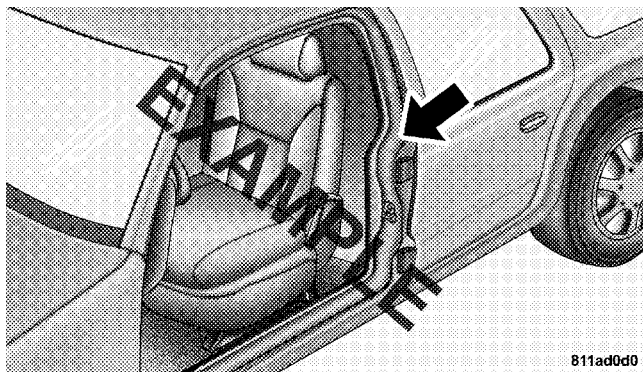

Tire and Loading Information Placard

TIRE AND LOADING INFORMATION			
SEATING CAPACITY - TOTAL 5 FRONT 2 REAR 3			
THE COMBINED WEIGHT OF OCCUPANTS AND CARGO SHOULD NEVER EXCEED XXX KG OR XXX LBS.			
TIRE	FRONT	REAR	SPARE
ORIGINAL TIRE SIZE	P195/70R14	P195/70R14	T125/70D15
COLD TIRE INFLATION PRESSURE	200kPa, 29PSI	200kPa, 29PSI	420kPa, 60PSI
SEE OWNER'S MANUAL FOR ADDITIONAL INFORMATION			4N109268

811b5a9a

This placard tells you important information about the,

- 1) number of people that can be carried in the vehicle
- 2) the total weight your vehicle can carry
- 3) the tire size designed for your vehicle
- 4) the cold tire inflation pressures for the front, rear and spare tires.

Loading

The vehicle maximum load on the tire must not exceed the load carrying capacity of the tire on your vehicle. You will not exceed the tire’s load carrying capacity if you

adhere to the loading conditions, tire size and cold tire inflation pressures specified on the Tire and Loading Information placard and the Vehicle Loading section of this manual.

NOTE: Under a maximum loaded vehicle condition, gross axle weight ratings (GAWR's) for the front and rear axles must not be exceeded. For further information on GAWR's, vehicle loading and trailer towing, see the Vehicle Loading section of this manual.

To determine the maximum loading conditions of your vehicle, locate the statement "The combined weight of occupants and cargo should never exceed XXX kg or XXX lbs." on the Tire and Loading Information placard. The combined weight of occupants, cargo/luggage and trailer tongue weight (if applicable) should never exceed the weight referenced here.

Steps for Determining Correct Load Limit

1. Locate the statement "The combined weight of occupants and cargo should never exceed XXX pounds" on your vehicle's placard.
2. Determine the combined weight of the driver and passengers that will be riding in your vehicle.

3. Subtract the combined weight of the driver and passengers from XXX kilograms or XXX pounds.

4. The resulting figure equals the available amount of cargo and luggage load capacity. For example, if "XXX" amount equals 1400 lbs. and there will be five 150 lb. passengers in your vehicle, the amount of available cargo and luggage load capacity is 650 lb. (1400–750 (5 x 150) = 650 lb.)

5. Determine the combined weight of luggage and cargo being loaded on the vehicle. That weight may not safely exceed the available cargo and luggage load capacity calculated in step 4.

6. If your vehicle will be towing a trailer, load from your trailer will be transferred to your vehicle. Consult this manual to determine how this reduces the available cargo and luggage load capacity of your vehicle.

NOTE: The following table shows examples on how to calculate total load, cargo/luggage and towing capacities of your vehicle with varying seating configurations and number and size of occupants. This table is for illustration purposes only and may not be accurate for the seating and load carry capacity of your vehicle.

174 STARTING AND OPERATING

NOTE: For the following example the combined weight of occupants and cargo should never exceed 865 lbs. (392 Kg).

Occupants			Combined weight of occupants and cargo from Tire Placard	MINUS	Combined Occupant's weight	=	AVAILABLE Cargo/Luggage and Trailer Tongue Weight
TOTAL	FRONT	REAR					
EXAMPLE 1			865 lbs	minus	Occupant 1: 200 lbs Occupant 2: 130 lbs Occupant 3: 160 lbs Occupant 4: 100 lbs Occupant 5: 80 lbs TOTAL WEIGHT: 670 lbs	=	195 lbs
5	2	3					
EXAMPLE 2			865 lbs	minus	Occupant 1: 210 lbs Occupant 2: 180 lbs Occupant 3: 150 lbs TOTAL WEIGHT: 540 lbs	=	325 lbs
3	2	1					
EXAMPLE 3			865 lbs	minus	Occupant 1: 200 lbs Occupant 2: 200 lbs TOTAL WEIGHT: 400 lbs	=	465 lbs
2	2	0					

WARNING!

Overloading of your tire is dangerous. Overloading can cause tire failure, affect vehicle handling, and increase your stopping distance. Use tires of the recommended load capacity for your vehicle. Never overload them.

TIRES—GENERAL INFORMATION**Tire Pressure**

Proper tire inflation pressure is essential to the safe and satisfactory operation of your vehicle. Three primary areas are affected by improper tire pressure:

1. Safety—**WARNING!**

Improperly inflated tires are dangerous and can cause accidents.

- Under inflation increases tire flexing and can result in tire failure.
- Over inflation reduces a tire's ability to cushion shock. Objects on the road and chuck holes can cause damage that results in tire failure.
- Unequal tire pressures can cause steering problems. You could lose control of your vehicle.
- Over inflated or under inflated tires can affect vehicle handling and can fail suddenly, resulting in loss of vehicle control.
- Unequal tire pressures from one side of the vehicle to the other can cause the vehicle to drift to the right or left.

Always drive with each tire inflated to the recommended cold tire inflation pressure.

2. *Economy*—

Improper inflation pressures can cause uneven wear patterns to develop across the tire tread. These abnormal wear patterns will reduce tread life resulting in a need for earlier tire replacement. Underinflation also increases tire rolling resistance and results in higher fuel consumption.

3. *Ride Comfort and Vehicle Stability*—

Proper tire inflation contributes to a comfortable ride. Overinflation produces a jarring and uncomfortable ride.

Tire Inflation Pressures

The proper cold tire inflation pressure for passenger cars is listed on either the face of the driver's door or the driver's side "B" pillar. For vehicles other than passenger cars, the cold tire inflation pressures are listed on either the "B" pillar, the Certification Label or in the Tire Inflation Pressures brochure in the glove compartment.

Some vehicles may have Supplemental Tire Pressure Information for vehicle loads that are less than the maximum loaded vehicle condition. These pressure conditions will be found in the "Supplemental Tire Pressure Information" section of this manual.

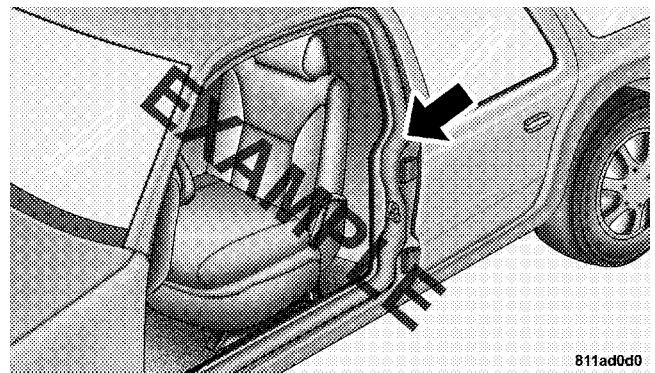

"B" PILLAR

The pressure should be checked and adjusted as well as inspecting for signs of tire wear or visible damage at least once a month. Use a good quality pocket-type gauge to check tire pressure. Do not make a visual judgement when determining proper inflation. Radial tires may look properly inflated even when they are underinflated.

CAUTION!

After inspecting or adjusting the tire pressure always reinstall the valve stem cap—if equipped. This will prevent moisture and dirt from entering the valve stem, which could damage the valve stem.

Inflation pressures specified on the placard are always “cold tire inflation pressure”. Cold tire inflation pressure is defined as the tire pressure after the vehicle has not been driven for at least 3 hours, or driven less than 1 mile (1 km) after a 3 hour period. The cold tire inflation pressure must not exceed the maximum inflation pressure molded into the tire side wall.

Check tire pressures more often if subject to a wide range of outdoor temperatures, as tire pressures vary with temperature changes.

Tire pressures change by approximately 1 psi (7 kPa) per 12° F (7° C) of air temperature change. Keep this in mind when checking tire pressure inside a garage especially in the winter.

Example: If garage temperature = 68° F (20° C) and the outside temperature = 32° F (0° C) then the cold tire inflation pressure should be increased by 3 psi (21 kPa), which equals 1 psi (7 kPa) for every 12° F (7° C) for this outside temperature condition.

Tire pressure may increase from 2 to 6 psi (13 to 40 kPa) during operation. DO NOT reduce this normal pressure build up or your tire pressure will be too low.

Tire Pressures for High Speed Operation

The manufacturer advocates driving at safe speeds within posted speed limits. Where speed limits or conditions are such that the vehicle can be driven at high speeds, maintaining correct tire inflation pressure is very important. Increased tire pressure and reduced vehicle loading may be required for high speed vehicle operation. Refer to original equipment or an authorized tire dealer for recommended safe operating speeds, loading and cold tire inflation pressures.

WARNING!

High speed driving with your vehicle under maximum load is dangerous. The added strain on your tires could cause them to fail. You could have a serious accident. Don't drive a vehicle loaded to the maximum capacity at continuous speeds above 75 mph (120 km/h).

Radial-Ply Tires**WARNING!**

Combining radial ply tires with other types of tires on your vehicle will cause your vehicle to handle poorly. The instability could cause an accident. Always use radial ply tires in sets of four (or 6, in case of trucks with dual rear wheels). Never combine them with other types of tires.

Cuts and punctures in radial tires are repairable only in the tread area because of sidewall flexing. Consult your authorized tire dealer for radial tire repairs.

Compact Spare Tire — If Equipped

The compact spare is for temporary emergency use with radial tires. It is engineered to be used on your style vehicle only. Since this tire has limited tread life, the original tire should be repaired (or replaced) and reinstalled at the first opportunity.

WARNING!

Temporary use spare tires are for emergency use only. With these tires, do not drive more than 50 mph (80 km/h). Temporary-use spare tires have a total tread life of 3,000 miles (4 800 km). Be sure to follow the warnings which apply to your spare. Failure to do so could result in spare tire failure and loss of vehicle control.

Do not install a wheel cover or attempt to mount a conventional tire on the compact spare wheel, since the wheel is designed specifically for the compact spare.

Do not install more than one compact spare tire/wheel on the vehicle at any given time.

CAUTION!

Because of the reduced ground clearance, do not take your vehicle through an automatic car wash with the compact spare installed. Damage to the vehicle may result.

Tire Spinning

When stuck in mud, sand, snow, or ice conditions, do not spin your vehicle's wheels above 35 mph (55 km/h).

See the paragraph on Freeing A Stuck Vehicle in Section 6 of this manual.

WARNING!

Fast spinning tires can be dangerous. Forces generated by excessive wheel speeds may cause tire damage or failure. A tire could explode and injure someone. Do not spin your vehicle's wheels faster than 35 mph (55 km/h) when you are stuck. And don't let anyone near a spinning wheel, no matter what the speed.

Tread Wear Indicators

Tread wear indicators are in the original equipment tires to help you in determining when your tires should be replaced.

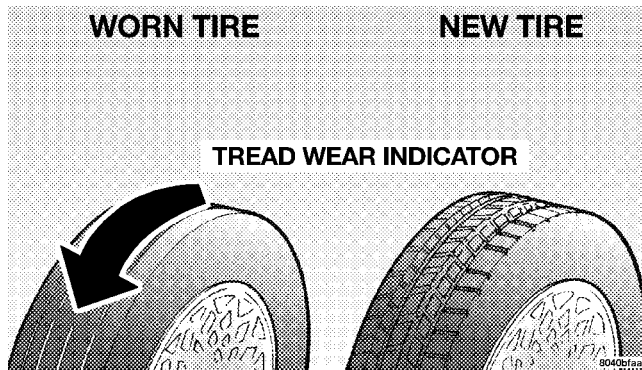

These indicators are molded into the bottom of the tread grooves and will appear as bands when the tread depth becomes 1/16 inch (2 mm). When the indicators appear in 2 or more adjacent grooves, the tire should be replaced.

Many states have laws requiring tire replacement at this point.

Replacement Tires

The tires on your new vehicle provide a balance of many characteristics. They should be inspected regularly for wear and correct cold tire inflation pressure. The manufacturer strongly recommends that you use tires equivalent to the originals in size, quality and performance when replacement is needed (see the paragraph on tread wear indicators). Refer to the Tire and Loading Information placard for the size designation of your tire. The service description and load identification will be found on the original equipment tire. Failure to use equivalent replacement tires may adversely affect the safety, handling, and ride of your vehicle. We recommend that you contact your original equipment or an authorized tire dealer with any questions you may have on tire specifications or capability.

WARNING!

- Do not use a tire, wheel size or rating other than that specified for your vehicle. Some combinations of unapproved tires and wheels may change suspension dimensions and performance characteristics, resulting in changes to steering, handling, and braking of your vehicle. This can cause unpredictable handling and stress to steering and suspension components. You could lose control and have an accident resulting in serious injury or death. Use only the tire and wheel sizes with load ratings approved for your vehicle.
- Never use a tire with a smaller load index or capacity, other than what was originally equipped on your vehicle. Using a tire with a smaller load index could result in tire overloading and failure. You could lose control and have an accident.
- Failure to equip your vehicle with tires having adequate speed capability can result in sudden tire failure and loss of vehicle control.

CAUTION!

Replacing original tires with tires of a different size may result in false speedometer and odometer readings.

Alignment And Balance

Poor suspension alignment may result in:

- Fast tire wear.
- Uneven tire wear, such as feathering and one-sided wear.
- Vehicle pull to right or left.

Tires may also cause the vehicle to pull to the left or right. Alignment will not correct this condition. See your dealer for proper diagnosis.

Improper alignment will not cause vehicle vibration. Vibration may be a result of tire and wheel out-of-balance. Proper balancing will reduce vibration and avoid tire cupping and spotty wear.

SUPPLEMENTAL TIRE PRESSURE INFORMATION

A light load vehicle condition is defined as two passengers {150 lbs (68 kg) each} plus 200 lbs (91kg) of cargo. Cold tire inflation pressures for a lightly loaded vehicle will be found on a “Supplemental Tire Pressure Inflation” label located on the face of the driver’s door or in the Tire Information Pressures pamphlet in the glove box.

TIRE CHAINS

Use only Class S chains, or other traction aids that meet SAE specifications. Chains must be the proper size for the vehicle as recommended by the chain manufacturer.

These cautions apply to all chain traction devices, including link and cable (radial) chains.

CAUTION!

To avoid damage to your vehicle, tires or chains observe the following precautions:

- Because of restricted chain clearance between tires and other suspension components, it is important that only chains in good condition are used. Broken chains can cause serious damage. Stop the vehicle immediately if noise occurs that could indicate chain breakage. Remove the damaged parts of the chain before further use.
- Install chains as tightly as possible and then retighten after driving about 1/2 mile (0.8 km).
- Do not exceed 30 mph (48 km/h).
- Drive cautiously and avoid severe turns and large bumps, especially with a loaded vehicle.
- Install only Class S chains on 4x2 and 4x4 vehicles.
- Do not install tire chains on the front wheels of 4x2 vehicles.
- Do not install tire chains or traction devices on rear wheels of 4x2 vehicles with tires larger than LT225/75R16. These tires are too large for sufficient body clearance with chains or other traction devices.
- Do not install tire chains or traction devices on front wheels of 4x4 models with tires larger than LT225/75R16. Do not install tire chains or traction devices on rear wheels of 4x4 models with tires larger than LT225/75R16. These tires are too large for sufficient body clearance with chains or other traction devices.
- Do not drive for a prolonged period on dry pavement.
- Tire chains are not allowed on 4x2 vehicles equipped with P255/65R16 or P255/55R17 tires or 4x4 vehicles equipped with P265/70R16 tires.
- Observe the tire chain manufacturer’s instructions on method of installation, operating speed, and conditions for usage. Always use the lower suggested operating speed if both the chain manufacturer and the vehicle manufacturer suggest a maximum speed.

SNOW TIRES

Snow tires should be of the same size and type construction as the front tires. Consult the manufacturer of the snow tire to determine any maximum vehicle speed requirement associated with the tire. These tires should always be operated at the vehicle maximum capacity inflation pressures under any load condition.

While studded tires improve performance on ice, skid and traction capability on wet or dry surfaces may be poorer than that of non-studded tires. Some states prohibit studded tires; therefore, local laws should be checked before using these tire types.

TIRE ROTATION RECOMMENDATIONS

Tires on the front and rear axles of vehicles operate at different loads and perform different steering, driving, and braking functions. For these reasons, they wear at unequal rates and tend to develop irregular wear patterns. These effects can be reduced by timely rotation of tires. The benefits of rotation are especially worthwhile with aggressive tread designs such as those on all season type tires. Rotation will increase tread life, help to maintain mud, snow and wet traction levels, and contribute to a smooth, quiet ride.

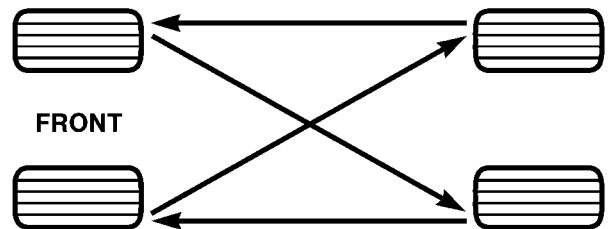

Follow the recommended tire rotation frequency for your type of driving found in the “Maintenance Schedules” Section of this manual. More frequent rotation is permissible if desired. The reasons for any rapid or unusual wear should be corrected prior to rotation being performed.

FUEL REQUIREMENTS

Your engine is designed to meet all emissions regulations and provide excellent fuel economy and performance when using high quality unleaded “regular” gasoline having an octane rating of 87. The routine use of premium gasoline is not recommended. Under normal conditions the use of premium fuel will not provide a benefit over high quality regular gasolines and in some circumstances may result in poorer performance.



Light spark knock at low engine speeds is not harmful to your engine. However, continued heavy spark knock at high speeds can cause damage and immediate service is required. Engine damage resulting from operation with a heavy spark knock may not be covered by the new vehicle warranty.

Poor quality gasoline can cause problems such as hard starting, stalling and hesitations. If you experience these symptoms, try another brand of “regular” gasoline before considering service for the vehicle.

Over 40 auto manufacturers world-wide have issued and endorsed consistent gasoline specifications (the Worldwide Fuel Charter, WWFC) to define fuel properties necessary to deliver enhanced emissions, performance and durability for your vehicle. The manufacturer recommends the use of gasolines that meet the WWFC specifications if they are available.

Reformulated Gasoline

Many areas of the country require the use of cleaner burning gasoline referred to as “Reformulated Gasoline.” Reformulated gasolines contain oxygenates, and are specifically blended to reduce vehicle emissions and improve air quality.

The manufacturer strongly supports the use of reformulated gasolines. Properly blended reformulated gasolines will provide excellent performance and durability for the engine and fuel system components.

Gasoline/Oxygenate Blends

Some fuel suppliers blend unleaded gasoline with oxygenates such as 10% ethanol, MTBE and ETBE. Oxygenates are required in some areas of the country during the winter months to reduce carbon monoxide emissions. Fuels blended with these oxygenates may be used in your vehicle.

CAUTION!

DO NOT use gasolines containing METHANOL. Gasoline containing methanol may damage critical fuel system components.

MMT In Gasoline

MMT is a manganese-containing metallic additive that is blended into some gasoline to increase octane. Gasolines blended with MMT provide no performance advantage beyond gasolines of the same octane number without MMT. Gasolines blended with MMT reduce spark plug life and reduce emission system performance in some vehicles. We recommend that gasolines free of MMT be

used in your vehicle. The MMT content of gasoline may not be indicated on the gasoline pump; therefore, you should ask your gasoline retailer whether or not his/her gasoline contains MMT.

It is even more important to look for gasolines without MMT in Canada because MMT can be used at levels higher than allowed in the United States. MMT is prohibited in Federal and California reformulated gasolines.

Sulfur In Gasoline

If you live in the northeast United States, your vehicle may have been designed to meet California low emission standards with Cleaner-Burning California reformulated gasoline with low sulfur. If such fuels are not available in states adopting California emission standards, your vehicles will operate satisfactorily on fuels meeting federal specifications, but emission control system performance may be adversely affected. Gasoline sold outside of California is permitted to have higher sulfur levels which may affect the performance of the vehicle's catalytic converter. This may cause the Check Engine or Service Engine Soon light to illuminate. We recommend that you try a different brand of unleaded gasoline having lower

sulfur to determine if the problem is fuel related prior to returning your vehicle to an authorized dealer for service.

CAUTION!

If the Check Engine or Service Engine Soon light is flashing, immediate service is required; see onboard diagnostics system section.

Materials Added To Fuel

All gasolines sold in the United States are required to contain effective detergent additives. Use of additional detergents or other additives is not needed under normal conditions and would result in unnecessary cost. Therefore, you should not have to add anything to the fuel.

ADDING FUEL**Fuel Filler Cap (Gas Cap)**

The gas cap is behind the fuel filler door. If the gas cap is lost or damaged, be sure the replacement cap is for use with this vehicle.

CAUTION!

Damage to the fuel system or emission control system could result from using an improper fuel tank filler tube cap (gas cap). A poorly fitting cap could let impurities into the fuel system.

WARNING!

- Remove the fuel tank filler tube cap (gas cap) slowly to prevent fuel spray from the filler neck which may cause injury.
- The volatility of some gasolines may cause a buildup of pressure in the fuel tank that may increase while you drive. This pressure can result in a spray of gasoline and/or vapors when the cap is removed from a hot vehicle. Removing the cap slowly allows the pressure to vent and prevents fuel spray.
- Never allow any lit smoking materials near the vehicles while removing the cap or filling the tank.
- Never add fuel to the vehicle when the engine is running.

Fuel Tank Filler Tube

NOTE: On some models, the fuel tank filler tube has a restricting door about 2 inches (50 mm) down from the opening. If fuel is poured from a portable container, the container should have a flexible nozzle long enough to force open the restricting door.

CAUTION!

To avoid fuel spillage and overfilling, do not “top off” the fuel tank after filling.

NOTE: When the fuel nozzle “clicks” or shuts off, the fuel tank is full.

NOTE: Tighten the gas cap until you hear a “clicking” sound. This is an indication that the gas cap is properly tightened.

The Check Engine light will come on if the gas cap is not properly secured. Make sure that the gas cap is tightened each time the vehicle is refueled.

WARNING!

A fire may result if gasoline is pumped into a portable container that is inside of a vehicle. You could be burned. Always place gas containers on the ground while filling.

Fuel System Cautions**CAUTION!**

Follow these guidelines to maintain your vehicle's performance:

- The use of leaded gas is prohibited by Federal law. Using leaded gasoline can impair engine performance, damage the emission control system, and could result in loss of warranty coverage.
- An out-of-tune engine, or certain fuel or ignition malfunctions, can cause the catalytic converter to overheat. If you notice a pungent burning odor or

some light smoke, your engine may be out of tune or malfunctioning and may require immediate service. Contact your dealer for service assistance.

- When pulling a heavy load or driving a fully loaded vehicle when the humidity is low and the temperature is high, use a premium unleaded fuel to help prevent spark knock. If spark knock persists, lighten the load, or engine piston damage may result.
- The use of fuel additives which are now being sold as octane enhancers is not recommended. Most of these products contain high concentrations of methanol. Fuel system damage or vehicle performance problems resulting from the use of such fuels or additives is not the responsibility of the manufacturer and may not be covered under the New Vehicle Warranty.

NOTE: Intentional tampering with emissions control systems can result in civil penalties being assessed against you.

Carbon Monoxide Warnings

WARNING!

Carbon monoxide (CO) in exhaust gases is deadly. Follow the precautions below to prevent carbon monoxide poisoning:

- Do not inhale exhaust gases. They contain carbon monoxide, a colorless and odorless gas which can kill. Never run the engine in a closed area, such as a garage, and never sit in a parked vehicle with the engine running for an extended period. If the vehicle is stopped in an open area with the engine running for more than a short period, adjust the ventilation system to force fresh, outside air into the vehicle.
- Guard against carbon monoxide with proper maintenance. Have the exhaust system inspected every time the vehicle is raised. Have any abnormal conditions repaired promptly. Until repaired, drive with all side windows fully open.

- Keep the liftgate closed when driving your vehicle to prevent carbon monoxide and other poisonous exhaust gases from entering the vehicle.

CATALYTIC CONVERTER

The catalytic converter requires the use of unleaded fuel only. Leaded gasoline will destroy the effectiveness of the converter as an emission control device. Under normal operating conditions, the catalytic converter will not require maintenance. However, you must keep the engine maintained to assure proper operation and prevent possible damage.

NOTE: Intentional tampering with emissions control systems result in civil penalties being assessed against you.

CAUTION!

Damage to the catalytic converter can result if your vehicle is not kept in proper operating condition. In the event of engine malfunction, particularly involving engine misfire or other apparent loss of performance, have your vehicle serviced promptly. Continued operation of your vehicle with a severe malfunction could cause the converter to overheat, resulting in possible damage to the converter and vehicle.

As with any vehicle do not park or operate this vehicle in areas where combustible materials such as grass or leaves can contact a hot exhaust system.

A scorching odor may appear if you continue to run a malfunctioning engine. The odor may indicate severe and abnormal catalyst overheating. If this occurs, the vehicle should be stopped, the engine shut off and the vehicle allowed to cool. Service, including a tune-up to manufacturer's specifications should be obtained immediately.

To minimize the possibility of catalytic converter damage:

- Do not shut off the engine or interrupt the ignition when the transmission is in gear and the vehicle is in motion.
- Do not try to start the engine by pushing or towing the vehicle.
- Do not idle the engine with any spark plug wires disconnected or removed, such as when diagnostic testing.
- Do not idle the engine for prolonged periods during very rough idle or malfunctioning operating conditions.
- Do not allow vehicle to run out of fuel.

NOTE: Intentional tampering with emissions control systems can result in civil penalties being assessed against you.

VEHICLE LOADING

Certification Label

As required by National Highway Traffic Safety Administration Regulations, your vehicle has a certification label affixed to the driver's side door or pillar.

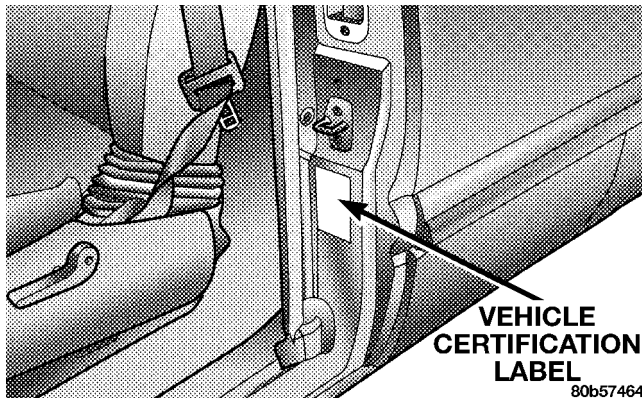

This label contains the month and year of manufacture, Gross Vehicle Weight Rating (GVWR), Gross Axle Weight Rating (GAWR) front and rear, and Vehicle Identification Number (VIN). A Month-Day-Hour (MDH) number is included on this label and shows the Month, Day, and

Hour of manufacture. The bar code that appears on the bottom of the label is your Vehicle Identification Number (VIN).

Gross Vehicle Weight Rating (GVWR)

The GVWR is the total permissible weight of your vehicle including driver, passengers, vehicle, options, and cargo. The label also specifies maximum capacities of front and rear axle systems. Total load must be limited so that GVWR is not exceeded.

Payload

The payload of a vehicle is defined as the allowable load weight a truck can carry including the weight of the driver, all passengers, options, and cargo.

Gross Axle Weight Rating (GAWR)

The GAWR is the maximum permissible load on the front and rear axles. The load must be distributed in the cargo area so that the GAWR of each axle is not exceeded.

Each axle GAWR is determined by the component in the system with the lowest load carrying capacity (axle, springs, tires, or wheels).

Heavier axles or suspension components sometimes specified by purchasers for increased durability do not necessarily increase the vehicle's GVWR.

Tire Size

This is the minimum allowable tire size for your vehicle. Replacement tires must be equal to the load capacity of this tire size.

Rim Size

This is the rim size that is appropriate for the tire size listed.

Inflation Pressure (Cold)

This is the cold tire inflation pressure for your vehicle for all loading conditions up to full GAWR.

Curb Weight

The curb weight of a vehicle is defined as the total weight of the vehicle with all fluids, including vehicle fuel, at full capacity conditions, and with no occupants or cargo loaded into the vehicle. The front and rear curb weight values are determined by weighing your vehicle on a commercial scale before any occupants or cargo are added.

Loading

The actual total weight and the weight of the front and rear of your vehicle at the ground can best be determined by weighing it when it is loaded and ready for operation.

The entire vehicle should first be weighed on a commercial scale to insure that the GVWR has not been exceeded. The weight on the front and rear of the vehicle should then be determined separately to be sure that the load is properly distributed over front and rear axle. Weighing the vehicle may show that the GAWR of either the front or rear axles has been exceeded but the total load is within the specified GVWR. If so, weight must be shifted from front to rear or rear to front as appropriate until the specified weight limitations are met.

Store heavier items down low and be sure that the weight is distributed equally. Stow all loose items securely before driving.

Improper weight distribution can have an adverse effect on the way your vehicle steers and handles and the way the brakes operate.

WARNING!

Do not load your vehicle any heavier than the GVWR or the maximum front and rear GAWR. If you do, parts on your vehicle can break, or it can change the way your vehicle handles. This could cause you to lose control. Also, overloading can shorten the life of your vehicle.

A loaded vehicle is shown in the following example. Note that neither GVWR nor GAWR capabilities are exceeded. Overloading can cause potential safety hazards and shorten service life.

NOTE: The weights shown in this chart are not necessarily the weights for your vehicle. Also, the amount of load added to both the front and rear axles can be computed after the vehicle has been weighed both in its "curb weight" condition, and in its "loaded and ready for operation" condition.

Gross Vehicle Weight Rating (GVWR) 6500 LBS.

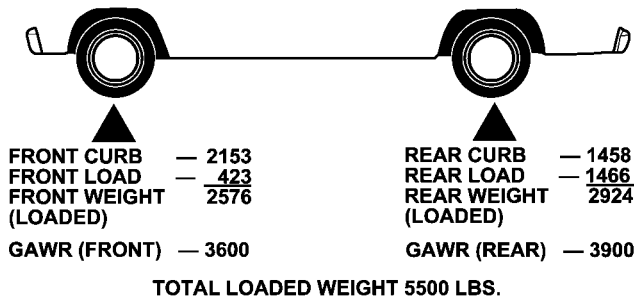

LOADING WIDE BUILDING MATERIALS

Four foot wide building materials can be conveniently carried in the Dakota pickup box. For occasional use up to 600 lbs (272 kg) of unrestrained material [9 pcs. 3/4" (19 mm) plywood] can be supported on 2 X 6 lumber placed crossbody in indentations provided in the pickup box inner walls. See illustration.

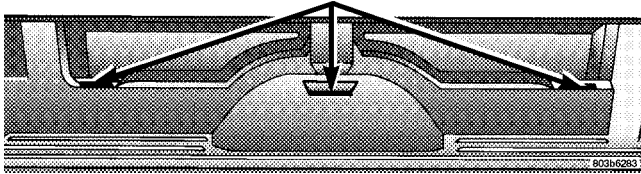
**LOAD REST INDENTATIONS
TO SUPPORT WIDE LOADS****WARNING!**

- Care should always be exercised when operating a vehicle with unrestrained cargo. Vehicle speeds may need to be reduced. Severe turns or rough roads may cause shifting or bouncing of the cargo that may result in vehicle damage. If wide building materials are to be frequently carried, the installation of a support is recommended. This will restrain the cargo and transfer the load to the pickup box floor.
- If you wish to carry more than 600 lbs (272 kg) of material suspended above the wheelhouse, supports must be installed to transfer the weight of the load to the pickup box floor or vehicle damage may result. The use of proper supports will permit loading up to the rated payload.
- Unrestrained cargo may be thrown forward in an accident causing serious or fatal injury.

See your dealer or a reputable installer of aftermarket equipment for further information on the installation of these supports.

WARNING!

It is extremely dangerous to ride in a cargo area, inside or outside of a vehicle. In a collision, people riding in these areas are more likely to be seriously injured or killed.

Do not allow people to ride in any area of your vehicle that is not equipped with seats and seat belts.

Be sure every one in your vehicle is in a seat and using a seat belt properly

TRAILER TOWING

To maintain warranty coverage, follow the requirements and recommendations in this manual concerning vehicles used for trailer towing.

Definitions

The following trailer towing related terminology definitions will assist in understanding the subsequent sections:

GROSS COMBINATION WEIGHT RATING (GCWR) is the total permissible weight of your vehicle and trailer when weighed in combination. (Note that GCWR ratings include a 68 kg (150 lb.) allowance for the presence of a driver.) Tongue Weight (of a trailer) is the weight placed on a vehicle's trailer hitch by the trailer.

GROSS TRAILER WEIGHT (GTW) is the weight of the trailer plus the weight of all cargo, consumables and equipment (permanent or temporary) loaded in or on the trailer in its "loaded and ready for operation" condition.

TRAILER SWAY CONTROL is a telescoping link that can be installed between the hitch receiver and the trailer

tongue that typically provides adjustable friction associated with the telescoping motion to dampen any unwanted trailer swaying motions while traveling.

CAUTION!

- **During the first 500 miles (805 km) your new vehicle is driven, do not tow a trailer. Doing so may damage your vehicle.**
- **When first towing a trailer, limit your speed to 50 mph (80 km/h) during the first 500 miles (805 km) of towing.**

Consider the following items when computing the weight on the rear axle:

- the tongue weight of the trailer
- the weight of any other type of cargo or equipment put in or on your vehicle

NOTE: Remember that everything put into or on the trailer adds to the load on your vehicle. Also, additional factory-installed options, or dealer-installed options, must be considered as part of the total load on your vehicle. Refer to the Certification label located at the driver's door for the Gross Vehicle Weight Rating.

Perform maintenance services as prescribed in the Maintenance Schedules section. When your vehicle is used for trailer towing, never exceed the gross axle weight rating (GAWR) and GVWR.

WARNING!

Improper towing can lead to an injury accident. Follow these guidelines to make your trailer towing as safe as possible:

- Be sure the trailer is loaded heavier in front, with 60% to 65% of the weight located ahead of the trailer's axles(s) sufficiently to place result in tongue weights of between 10% and 15% of the GTW loaded trailer weight on the tow hitch of your vehicle. (For a "5th

Wheel" style trailer, this range of loading on the "King Pin" should be between 15% and 25%.) Loads balanced over the wheels or biased toward "heavier in the rear" can cause the trailer to sway severely side to side which will cause loss of control of vehicle and trailer. Failure to load trailers heavier in front is the cause of many trailer accidents.

- Do **not** interconnect the hydraulic brake system of your vehicle with that of the trailer. This could cause inadequate braking and possible personal injury.
- Trailer brakes are recommended for trailers over 1,000 lbs. (454 kg) and required for trailers in excess of 2,000 lbs. (907 kg).
- Use an approved trailer harness and connector. If a hitch is ordered, the proper wiring will be provided.
- When hauling cargo or towing a trailer, do not overload your vehicle or trailer. Overloading can cause a loss of control, poor performance or damage to brakes, axle, engine, transmission, steering, suspension, chassis structure or tires.

- Make certain that the load is secured in the trailer and will not shift during travel. When trailering cargo that cannot be fully secured, dynamic load shifts can occur that may be difficult for the driver to control.
- All trailer hitches should be professionally installed on your vehicle.
- Safety chains must always be used between your vehicle and trailer.
- Connect trailer lighting and brakes using factory harnesses only. Do not cut or splice any wiring to the brake circuits.

Trailer and Tongue Weight

Gross Trailer Weight (GTW) means the weight of the trailer plus the weight of all cargo and equipment loaded on the trailer when in actual underway towing condition. The recommended way to measure GTW is to put your fully loaded trailer on a vehicle scale. The entire weight of the trailer must be supported by the scale.

Tongue Weight is the weight placed on the vehicle's trailer hitch by the trailer. Always load a trailer with 60%

to 65% of the weight in the front of the trailer. This places 10% to 15% of the GTW on the tow hitch of your vehicle.

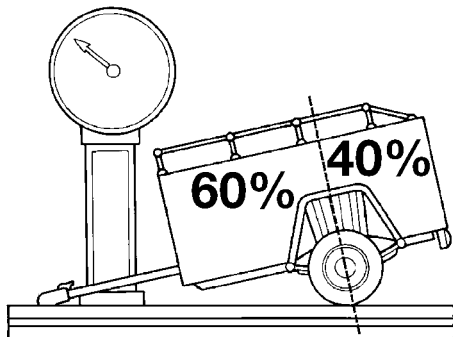

Trailer sway control and equalizing hitch are required for tongue weights above 350 lbs. (159 kg).

Trailer Towing—Hitches:

With a Class I Hitch, your vehicle can be equipped to tow trailers with a Gross Trailer Weight (GTW) of 2,000 lbs. (907 kg) maximum. Vehicles equipped with a rear step bumper are rated for a Class I Hitch.

With a Class II Hitch, your vehicle can be equipped to tow trailers with a Gross Trailer Weight (GTW) of 3,500 lbs. (1,587 kg) maximum. Tongue weight must be equal to at least 10% of GTW, but no more than 15% of GTW.

With a Class III Hitch, your vehicle can be equipped to tow trailers with a Gross Trailer Weight (GTW) of 5,000 lbs. (2,268 kg) maximum. Tongue weight must be equal to at least 10% of GTW, but no more than 15% of GTW.

With a Class IV Hitch, you can tow a trailer with a Gross Trailer Weight of up to 6,700 lbs. (3039 kg.) depending on your vehicle equipment. The Trailer Tow Package includes the platform hitch receiver, and a 7 lead wiring harness mounted on the hitch.

NOTE: When towing a trailer, the following requirements must be adhered to:

- GCWR must not be exceeded
- Total weight must be distributed between the tow vehicle and the trailer such that the following four (4) ratings are not exceeded:
 1. GVWR

2. GTW

3. **Tongue weight rating for the trailer hitch utilized (This requirement may limit the ability to always achieve the 10% to 15% range of tongue weight [15% to 25% for a "5th Wheel" style trailer] as a percentage of total trailer weight.)**

4. GAWR ratings

NOTE: Towing a trailer equipped with more than the standard lighting (turn, tail, stop and backup lights) may cause an abnormally high electrical current draw through the headlight switch, causing the switch to fail. To prevent a recurring switch failure install a trailer tow wiring harness overlay kit with relay to bypass headlight switch (available from your dealer).

Trailer Towing Information (Maximum Trailer Weight Ratings)

"Trailer Towing Guide"

NOTE: For trailer towing information (maximum trailer weight ratings) refer to the following website address: [http:// www.dodge.com/towing](http://www.dodge.com/towing).

In Canada, refer to the following website address: [http:// www.dodge.ca](http://www.dodge.ca).

Trailer Towing Requirements

All Dodge Dakota trucks are intended to tow trailers up to 2,000 lbs. without added equipment or alterations to standard equipment. Your vehicle may be factory equipped for safe towing of trailers weighing over 2,000 lbs. with the Trailer Tow Package. The electrical part of this package includes an instruction sheet, a 7/4 pin adaptor, a wiring pigtail for an aftermarket electric trailer brake controller, and three relays that must be installed into the power distribution center. These items are stored in the glove box. Also included in the Trailer Tow Package are two fuses and a relay that are located on the driver's side of the engine compartment on a harness near the Power Distribution Center. This relay and the fuses power up the trailer towing option. See your Dodge dealer for further information.

If you regularly pull a trailer, regardless of the trailer size, stop and turn signals on the trailer are recommended for motoring safety. To handle the additional electrical load

of the trailer lights and assure their proper functioning, a heavy duty turn signal flasher can be installed as a separate equipment item by your dealer.

WARNING!

The direct connection of hydraulic brake lines from vehicle brake system to trailer system is not acceptable. The extra load may cause brake failure and you may be injured.

Heavy trailer towing also may require breakaway electric trailer brakes, anti-sway devices or equalizing hitches for safe operation. Such devices are commonly required by state law.

For all trailer tow or heavy-duty applications it is strongly recommended that the factory fill rear axle lubricant be replaced with an SAE 75W-140 synthetic gear lubricant. Mopar® Synthetic Gear Lubricant is of this type.

Trailer Tow Wiring

The Trailer Tow Package includes a wiring harness located at the rear underbody of the vehicle.

NOTE: Connect trailer lighting and brakes using factory harnesses only. Do not cut or splice wiring to the brake circuits.

The electrical connections are all complete to the vehicle but you must mate the harness to a trailer connector. Refer to the following table for wire color and function.

Wire Color	Function
Black	Ground Wire
Blue	Trailer Brake
Black/Orange	Tail & Running Lamps
Red/Tan	Battery
Dk. Green/Red	Lt. Stop & Turn Signal
Brown/Red	Rt. Stop & Turn Signal
Violet/Black	Backup Lamps

Cooling System Tips—Trailer Towing

To reduce potential for engine and transmission overheating, take the following actions:

- **City Driving** —When stopped for short periods of time, put transmission in neutral and increase engine idle speed.
- **Highway Driving** —Reduce your speed.
- **Air Conditioning** —Turn off temporarily.

See Cooling System Operating information in the Maintenance section of this manual for more information.

To reduce potential for automatic transmission overheating, turn the Overdrive OFF when driving in hilly areas or shift the transmission to Drive position 2 on more severe grades. Move the shift lever to the next lower position to eliminate excessive transmission shifting. This action will also reduce the possibility of transmission overheating and provide better engine braking.

NOTE: If your vehicle has an automatic transmission and you tow a trailer frequently follow Maintenance Schedule “B”.

SNOWPLOW**Dodge Dakota Models**

NOTE: Do not use Dodge Dakota Models for snowplow applications.

WARNING!

Snowplows, winches, and other aftermarket equipment should not be added to the front end or your vehicle. The airbag crash sensors may be affected by the change in the front end structure. The airbags could deploy unexpectedly or could fail to deploy during a collision resulting in serious injury or death.

CAUTION!

Using this vehicle for snowplow applications can cause damage to the vehicle.

RECREATIONAL TOWING (BEHIND MOTORHOME, ETC.) OF 4X4 VEHICLES**CAUTION!**

Internal damage to the transfer case will occur if a front or rear wheel lift is used when recreational towing.

NOTE: Both the NV233 and NV244 transfer cases must be shifted into Neutral (N) for recreational towing. The Neutral (N) selection button is located on the lower left hand corner of the 4WD Control Switch. Shifts into and out of transfer case Neutral (N) can take place with the selector switch in any mode position. Automatic Transmissions must be placed in P (Park) position for recreational towing. Manual Transmissions must be placed in gear (for example, 4th gear) for recreational towing.

Recreational Towing Procedure

Use the following procedure to prepare your vehicle for recreational towing.

CAUTION!

It is necessary to follow these steps to be certain that the transfer case is fully in Neutral (N) before recreational towing to prevent damage to internal parts.

1. Bring vehicle to a complete stop.
2. Shut engine OFF.
3. Place ignition key in the ON position.
4. Depress brake pedal.
5. Shift automatic transmission to Neutral (N) or depress clutch on manual transmission.

6. Using the point of a ballpoint pen or similar object, depress the recessed transfer case Neutral (N) button for 4 seconds.
7. After shift is completed and the Neutral (N) light comes on release Neutral (N) button.
8. Start engine.
9. Shift automatic transmission into Reverse (R).
10. Release brake pedal for five seconds and ensure that there is no vehicle movement.
11. Repeat steps 9 and 10 with the transmission in Drive (D).
12. Shut engine OFF and place ignition key to the unlocked OFF position.
13. Shift automatic transmission into Park (P). Shift Manual transmissions into 4th gear.
14. Attach vehicle to tow vehicle with tow bar.

NOTE: Items 1 through 5 are requirements that must be met prior to depressing the Neutral (N) selection button, and must continue to be met until the 4 seconds elapses and the shift has been completed. If any of these requirements (with the exception of 3 - Key ON) are not met prior to depressing the Neutral (N) button or are no longer met during the 4 second timer, then the Neutral (N) indicator light will flash continuously until all requirements are met or until the Neutral (N) button is released.

NOTE: The ignition key must be ON for a shift to take place and for the position indicator lights to be operable. If the key is not ON, the shift will not take place and no position indicator lights will be on or flashing.

NOTE: Flashing neutral (N) position indicator light indicates that shift requirements have not been met.

CAUTION!

Damage to the transmission may occur if the transmission is shifted into Park (P) with the transfer case in Neutral (N) and the engine RUNNING. With the transfer case in Neutral (N) ensure that the engine is OFF prior to shifting the transmission into Park (P).

Returning to Normal Operation

Use the following procedure to prepare your vehicle for normal usage.

1. Bring vehicle to a complete stop.
2. Shut engine OFF.
3. Place ignition key in the ON position.
4. Depress brake pedal.
5. Shift automatic transmission to Neutral (N) or depress clutch on manual transmission.

6. Using the point of a ballpoint pen or similar object, depress the recessed transfer case Neutral (N) button for 1 second.

7. After the Neutral (N) indicator light turns off release the Neutral (N) button.

8. After the Neutral (N) button has been released the transfer case will shift to the position identified by the selector switch.

9. Shift automatic transmission into Drive (D), release the clutch on manual transmission.

NOTE: Items 1 through 5 are requirements that must be met prior to depressing the Neutral (N) selection button, and must continue to be met until 1 second elapses and the shift has been completed. If any of these requirements (with the exception of 3 - key ON) are not met prior to depressing the Neutral (N) button or are no longer met during the 1 second time, then all of the mode position indicator lights will flash continuously until all requirements are met or until the Neutral (N) button is released.

NOTE: The ignition key must be ON for a shift to take place and for the position indicator lights to be operable. If the key is not ON, the shift will not take place and no position indicator lights will be on or flashing.

NOTE: Flashing neutral (N) position indicator light indicates that shift requirements have not been met.

WARNING!

You or others could be injured if you leave the vehicle unattended with the transfer case in the Neutral (N) position without first fully engaging the parking brake. The transfer case Neutral (N) position disengages both the front and rear driveshafts from the powertrain and will allow the vehicle to move despite the transmission position. The parking brake should always be applied when the driver is not in the vehicle.

CAUTION!

- **Do not use a bumper mounted clamp-on tow bar on your vehicle. The bumper face bar will be damaged.**
- **Do not disconnect the rear driveshaft because fluid will leak from the transfer case and damage internal parts.**

TRACTION

When driving on wet or slushy roads, it is possible for a wedge of water to build up between the tire and road surface. This is known as hydroplaning and may cause partial or complete loss of vehicle control and stopping ability. To reduce this possibility, the following precautions should be observed:

1. Slow down during rainstorms or when roads are slushy.
2. Slow down if road has standing water or puddles.
3. Replace tires when tread wear indicators first become visible.
4. Keep tires properly inflated.
5. Maintain sufficient distance between your vehicle and the car in front to avoid a collision in a sudden stop.

EQUIPMENT IDENTIFICATION PLATE

The equipment Identification Plate is located on the hood inner surface.

The following information about your vehicle is displayed on this plate: Model, Wheelbase, Vehicle Identification Number, Truck Order Number, and code numbers with descriptions of all production and special equipment on the truck as shipped from the factory.

NOTE: Always refer to the Equipment Identification Plate When Ordering Parts.

WHAT TO DO IN EMERGENCIES

CONTENTS

■ Hazard Warning Flasher	208	□ Tire Changing Procedure	211
■ Adding Fuel	208	■ Jump Starting	215
■ Changing A Flat Tire	209	■ Towing A Disabled Vehicle	217
□ Jack Location	209	□ Four-Wheel Drive Vehicles	218
□ Jack Removal And Stowage	210	□ Two-Wheel Drive Vehicles	218
□ Removing The Spare Tire	210		

HAZARD WARNING FLASHER

The flasher switch is on the top of the steering column, just behind the steering wheel. Press the flasher switch and all front and rear directional signals will flash intermittently.

Press the switch a second time to turn off the emergency flashers.

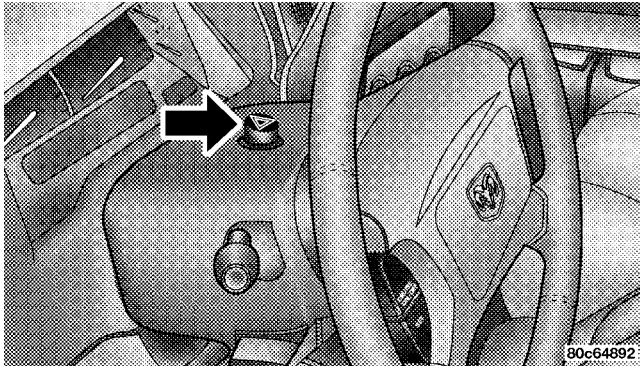

This is an emergency warning system and should not be used when the vehicle is in motion. Use it when your vehicle is disabled and is creating a safety hazard for other motorists.

If it is necessary to leave the vehicle to go for service, the flasher system will continue to operate with the ignition key removed and the vehicle locked.

ADDING FUEL

On some models, the fuel tank filler tube, on vehicles equipped with a catalytic converter, has a restricting door about 2 inches (50 mm) inside the opening. If using a portable fuel container, it should have a flexible nozzle long enough to force open the restricting door.

WARNING!

A fire may result if gasoline is pumped into a portable container that is in a vehicle or on a truck bed. You could be burned. Always place gas containers on the ground while filling.

WARNING!

Remove the gas cap slowly to prevent fuel spray from the filler neck which may cause injury.

The volatility of present gasolines may cause a build up of pressure in the fuel tank that may increase while you drive. This pressure can result in a spray of gasoline and/or vapors when you remove the cap from a hot vehicle. Removing the cap slowly allows the pressure to vent and prevents fuel spray.

Never allow any lit smoking materials near the vehicles while removing the cap or filling the tank.

Never add fuel to the vehicle when the engine is running.

CHANGING A FLAT TIRE**Jack Location**

The jack, jack drive tube, 2 tube extensions, and wheel wrench are located behind the seat on the passenger's side of the vehicle.

WARNING!

The jack is designed as a tool for changing tires only. The jack should not be used to lift the vehicle for service purposes, unless suitable supports are placed under the vehicle as a safety measure. The vehicle should be jacked on a firm level surface only. Avoid ice or slippery areas.

- In the Regular Cab the jack and tools are stowed under a formation in the carpet behind the passenger seat.
- In the Quad Cab the jack and tools are stowed under the rear seat. Lift the passenger side rear seat cushion to gain access to this area.

- In the Club Cab the jack and tools are stowed in a floor compartment located under the rear seat on the passenger's side of the vehicle. The seat cushion can be lifted to a vertical position to allow access to this compartment.

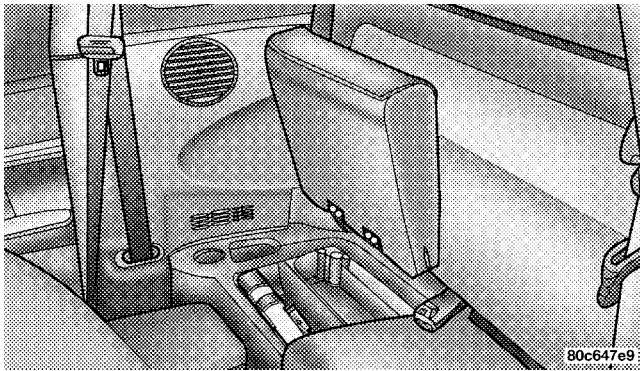

Jack Removal and Stowage

- Quad Cab models have a Hoop-Style stowage follow the instructions below:
 - For jack removal, turn the screw counterclockwise to remove the jack from beneath the retaining hoop.

- For jack stowage, place the jack beneath the retaining hoop and turn the jack screw clockwise until the jack is firmly secured within the retaining hoop. Refer to the graphic below. The seat has been removed for clarity.

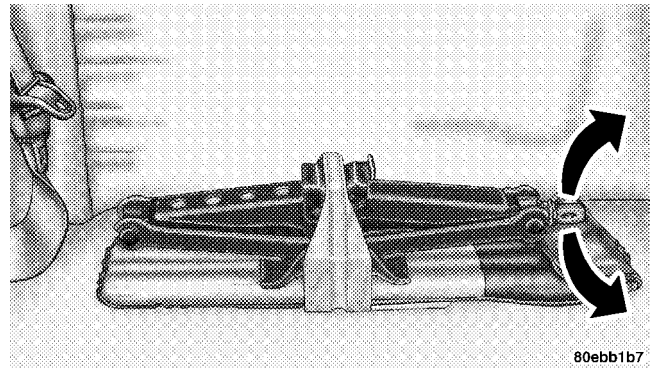

Quad Cab Jack Stowage

Removing The Spare Tire

Remove the spare tire before attempting to jack the truck. Attach the wheel wrench to the jack extension tube. Insert the tube through the access hole in the rear bumper and into the winch mechanism tube. Rotate the wheel wrench

handle counterclockwise until the spare tire is on the ground with enough cable slack to allow you to pull it out from under the vehicle. When the spare is clear, tilt the retainer at the end of the cable and pull it through the center of the wheel.

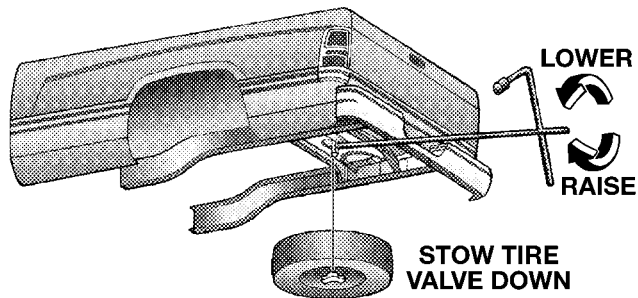

80a8eb3c

It is recommended that you stow the flat or spare to avoid tangling the loose cable.

NOTE: The winch mechanism is designed for use with the jack extension tube only. Use of an air wrench or other power tools is not recommended and can damage the winch.

Tire Changing Procedure

WARNING!

Getting under a jacked-up vehicle is dangerous. The vehicle could slip off the jack and fall on you. You could be crushed. Never get any part of your body under a vehicle that is on a jack. Never start or run the engine while the vehicle is on a jack. If you need to get under a raised vehicle, take it to a service center where it can be raised on a lift.

6

Do not raise this vehicle using a bumper jack. The jack is designed as a tool for changing tires on this vehicle only. It is not recommended that the jack be used for service purposes or to lift more than one wheel at a time.

Preparations

Park the vehicle on a firm level surface, avoiding ice or slippery areas. Set the parking brake and place the gear selector in PARK (automatic transmission) or REVERSE (manual transmission). On four-wheel drive vehicles, shift the transfer case to the "4L" position.

WARNING!

Do not attempt to change a tire on the side of the vehicle close to moving traffic. Pull far enough off the road to avoid the danger of being hit when operating the jack or changing the wheel.

- Turn on the Hazard Warning Flasher.

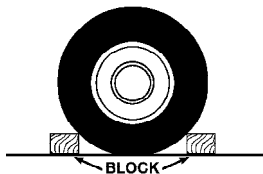

- Block both the front and rear of the wheel diagonally opposite the jacking position. For example, if the right front wheel is being changed, block the left rear wheel.
- Passengers should not remain in the vehicle when the vehicle is being jacked.

Instructions

1. Remove the spare wheel, jack, and tools from storage.
2. Remove wheel center cap using the spade end of the wheel wrench.
3. Using the wheel wrench, loosen, but do not remove, the wheel nuts by turning them counterclockwise one turn while the wheel is still on the ground.
4. When changing a front wheel, place the jack under the frame rail behind the wheel. Locate the jack as far forward as possible on the straight part of the frame. Make sure that the upstanding tab of the jack contacts the vertical side of the frame. Operate the jack using the jack drive tube and the wheel wrench— the tube extension, may be used but is not required.

When changing a rear wheel, assemble the jack drive tube to the jack and connect the drive tube to the extension tube. Place the jack under the axle between the spring and the shock absorber with the drive tubes extending to the rear. Connect the jack tube extension and wheel wrench.

Before raising the wheel off the ground, make sure that the jack will not damage surrounding truck parts and adjust the jack position as required.

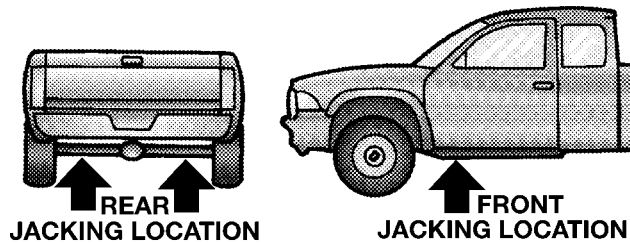

80a5f29c

5. By rotating the wheel wrench clockwise, raise the vehicle until the wheel just clears the surface.

WARNING!

Raising the vehicle higher than necessary can make the vehicle unstable and cause an accident. It could slip off the jack and hurt someone near it. Raise the vehicle only enough to remove the tire.

6. Remove the wheel nuts and pull the wheel off. Install the spare wheel and wheel nuts with the cone shaped end of the nuts toward the wheel. Lightly tighten the nuts. To avoid risk of forcing the vehicle off the jack, do not fully tighten the nuts until the vehicle has been lowered.

7. Using the wheel wrench, finish tightening the nuts in a crisscross pattern. Correct nut tightness is 85-115 ft. lbs. (115-155 N-m) torque. If in doubt about the correct tightness, have them checked with a torque wrench by your dealer or at a service station.

WARNING!

A loose tire or jack thrown forward in a collision or hard stop could injure someone in the vehicle. Always stow the jack parts and the extra tire and wheel in the places provided.

8. Install wheel center cap and remove wheel blocks. Do not install chrome or aluminum wheel center caps on the spare wheel. This may result in cap damage.
9. Lower the jack to its fully closed position. Stow the replaced tire, jack, and tools as previously described.
10. Adjust the tire pressure when possible.

NOTE: Do not oil wheel studs. For chrome wheels, do not substitute with chrome plated wheel nuts.

WARNING!

Carefully follow these tire changing warnings to help prevent personal injury or damage to your vehicle:

- **Always park on a firm, level surface as far from the edge of the roadway as possible before raising the vehicle.**
- **Block the wheel diagonally opposite the wheel to be raised.**
- **Apply the parking brake firmly before jacking.**
- **Never start the engine with the vehicle on a jack.**
- **Do not let anyone sit in the vehicle when it is on a jack.**
- **Do not get under the vehicle when it is on a jack.**
- **Only use the jack in the positions indicated.**
- **If working on or near a roadway, be extremely careful of motor traffic.**

To Stow The Flat Or Spare

Turn the wheel so that the valve stem is down. Slide the wheel retainer through the center of the wheel and position it properly across the wheel opening.

For convenience in checking the spare tire inflation, stow with the valve stem toward the rear of the vehicle.

Attach the wheel wrench to the extension tube. Rotate the winch mechanism until the wheel is drawn into place against the underside of the vehicle. Continue to rotate until you feel the winch mechanism slip or click 3 or 4 times. It cannot be overtightened. Push against the tire several times to be sure it is firmly in place.

JUMP STARTING**WARNING!**

- **Battery fluid is a corrosive acid solution; do not allow battery fluid to contact eyes, skin or clothing. Don't lean over battery when attaching clamps or allow the clamps to touch each other. If acid splashes in eyes or on skin, flush the contaminated area immediately with large quantities of water.**
- **A battery generates hydrogen gas which is flammable and explosive. Keep flame or spark away from the vent holes. Do not use a booster battery or any other booster source with an output that exceeds 12 volts.**

Check the Battery Test Indicator (if equipped). If a yellow or bright colored dot is visible in the indicator (if equipped), DO NOT jump-start the battery.

If the indicator (if equipped) is dark or shows a green dot, proceed as follows:

1. Wear eye protection and remove all metal jewelry such as watch bands or bracelets which might make an unintended electrical contact.
2. Park the booster vehicle within cable reach but without letting the vehicles touch. Set the parking brake, place the automatic transmission in PARK or the manual transmission in NEUTRAL and turn the ignition OFF on both vehicles.
3. Turn OFF heater, radio and all unnecessary electrical loads.
4. Connect one end of a jumper cable to the positive terminal of the booster battery. Connect the other end of the same cable to the positive terminal of the discharged battery.

WARNING!

Do not permit vehicles to touch each other as this could establish a ground connection and personal injury could result.

5. Connect the other cable, first to the negative terminal of the booster battery and then to the engine of the vehicle with the discharged battery. Make sure you have a good contact on the engine.

WARNING!

Do not connect the cable to the negative post of the discharge battery. The resulting electrical spark could cause the battery to explode.

During cold weather when temperatures are below freezing point, electrolyte in a discharged battery may freeze. Do not attempt jump starting because the battery could rupture or explode. The battery temperature must be brought up above freezing point before attempting jump start.

6. Start the engine in the vehicle which has the booster battery, let the engine idle a few minutes, then start the engine in the vehicle with the discharged battery.
7. When removing the jumper cables, reverse the above sequence exactly. Be careful of the moving belts and fan.

WARNING!

Any procedure other than above could result in:

1. Personal injury caused by electrolyte squirting out the battery vent;
2. Personal injury or property damage due to battery explosion;
3. Damage to charging system of booster vehicle or of immobilized vehicle.

TOWING A DISABLED VEHICLE

Proper towing or lifting equipment is required to prevent damage to your vehicle. Use of safety chains is recommended. **Attach towing device to main structural members of the vehicle — not to bumpers or associated brackets. State and local laws applying to vehicles under tow must be observed.**

Four-Wheel Drive Vehicles

The manufacturer recommends towing with all wheels off the ground. Acceptable methods are to tow the vehicle on a flatbed or with one end of the vehicle raised and the opposite end on a towing dolly.

Two-Wheel Drive Vehicles

Provided that the transmission is operable, tow with the transmission in Neutral and the ignition key in the OFF position along with the front wheels raised and the rear wheels on the ground. The speed must not exceed 30 mph (50 km/h) and the distance must not exceed 15 miles (25 km).

If the vehicle is to be towed more than 15 miles (25 km), it must be towed on a flatbed, or with the rear wheels raised and the front wheels on the ground, or with the front end raised and the rear wheels on a towing dolly.

MAINTAINING YOUR VEHICLE

CONTENTS

■ Engine Compartment 3.7L V6	221	□ Ignition Cables	230
■ Engine Compartment 4.7L V-8	222	□ Engine Air Cleaner Filter	230
■ Onboard Diagnostic System — OBD II	223	□ Engine Fuel Filter	231
■ Emissions Inspection And Maintenance Programs	224	□ Catalytic Converter	231
■ Replacement Parts	225	□ Maintenance-Free Battery	232
■ Dealer Service	225	□ Air Conditioner Maintenance	233
■ Maintenance Procedures	226	□ Power Steering — Fluid Check	234
□ Engine Oil	226	□ Front Suspension Ball Joints	235
□ Engine Oil Filter	229	□ Steering Linkage	235
□ Drive Belts — Check Condition And Tension . .	230	□ Drive Shaft Constant Velocity Joints — 4X4 Models	235
□ Spark Plugs	230	□ Body Lubrication	235

□ Windshield Wiper Blades	235	■ Vehicle Storage	254
□ Windshield Washers	236	■ Replacement Light Bulbs	254
□ Exhaust System	236	■ Bulb Replacement	255
□ Cooling System	237	□ Headlights	255
□ Emission Related Components	241	□ Parking/Turn Signal Lights	256
□ Brake System	243	□ Rear Side Marker, Tail Lights, Turn Signals And Backup Lights — Replacement	256
□ Clutch Hydraulic System	245	□ License Lights	257
□ Manual Transmission	245	□ Center High-Mounted Stoplight	257
□ Automatic Transmission	245	□ Fog Lights	257
□ Transfer Case	248	■ Fluids And Capacities	258
□ Axles	248	■ Recommended Fluids, Lubricants And Genuine Parts	259
□ Selection Of Lubricating Grease	248	□ Engine	259
□ Appearance Care And Protection From Corrosion	249	□ Chassis	260
■ Power Distribution Center	252		
■ Fuse Block	253		

ENGINE COMPARTMENT 3.7L V6

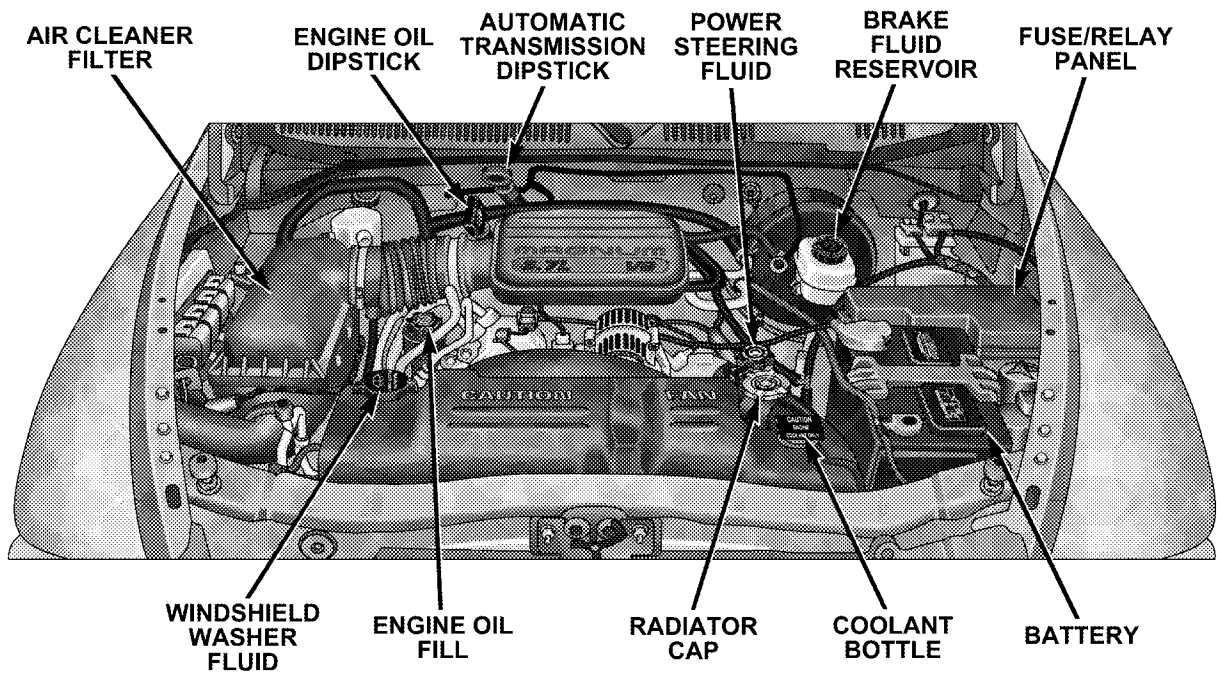

811b38ad

ENGINE COMPARTMENT 4.7L V-8

AIR CLEANER FILTER TRANSMISSION DIPSTICK ENGINE OIL DIPSTICK BRAKE FLUID RESERVOIR BATTERY POWER DISTRIBUTION CENTER

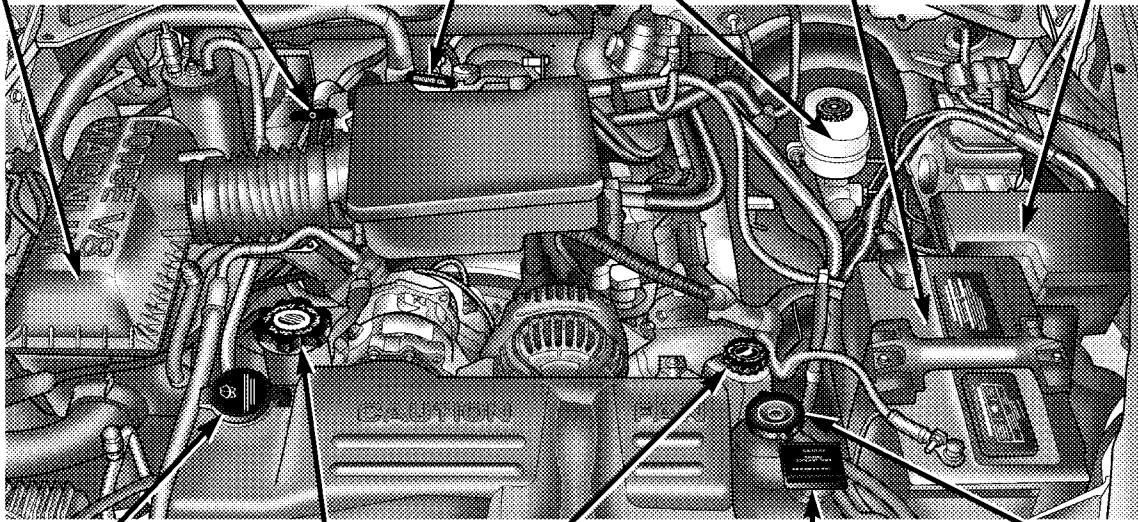

WINDSHIELD WASHER FLUID ENGINE OIL FILL POWER STEERING FLUID COOLANT BOTTLE COOLANT PRESSURE CAP

ONBOARD DIAGNOSTIC SYSTEM — OBD II

Your vehicle is equipped with a sophisticated onboard diagnostic system called OBD II. This system monitors the performance of the emissions, engine, and automatic transmission control systems. When these systems are operating properly, your vehicle will provide excellent performance and fuel economy, as well as engine emissions well within current government regulations.

If any of these systems require service, the OBD II system will turn on the “Malfunction Indicator Light.” It will also store diagnostic codes and other information to assist your service technician in making repairs. Although your vehicle will usually be drivable and not need towing, see your dealer for service as soon as possible.

CAUTION!

- **Prolonged driving with the “Malfunction Indicator Light” on could cause further damage to the emission control system. It could also affect fuel economy and driveability. The vehicle must be serviced before any emissions tests can be performed.**
- **If the “Malfunction Indicator Light” is flashing while the engine is running, severe catalytic converter damage and power loss will soon occur. Immediate service is required.**

EMISSIONS INSPECTION AND MAINTENANCE PROGRAMS

In some localities, it may be a legal requirement to pass an inspection of your vehicle's emissions control system. Failure to pass could prevent vehicle registration.



For states which have an I/M (Inspection and Maintenance) requirement, this check verifies the following: the MIL (Malfunction Indicator Lamp) is functioning and is not on when the engine is running, and that the OBD (On Board Diagnostic) system is ready for testing.

Normally, the OBD system will be ready. The OBD system may **not** be ready if your vehicle was recently serviced, if you recently had a dead battery, or a battery replacement. If the OBD system should be determined not ready for the I/M test, your vehicle may fail the test.

Your vehicle has a simple ignition key actuated test which you can use prior to going to the test station. To check if your vehicle's OBD system is ready, you must do the following:

1. Insert your ignition key into the ignition switch.

2. Turn the ignition to the ON position, but do not crank or start the engine.

3. If you crank or start the engine, you will have to start this test over.

4. As soon as you turn your key to the ON position, you will see your MIL symbol come on as part of a normal bulb check.

5. Approximately 15 seconds later, one of two things will happen:

- a. The MIL light will blink for approximately 5 seconds and then remain on until the first engine crank or the key is turned off. This means that your vehicle's OBD system is **not ready** and you should **not** proceed to the I/M station.

- b. The MIL light will remain fully illuminated until the first engine crank or the key is turned off. This means that your vehicle's OBD system is **ready** and you can proceed to the I/M station.

If your OBD system is **not ready**, you should see your dealer or repair facility. If your vehicle was recently

serviced or had a battery failure or replacement, you may need to do nothing more than drive your vehicle as you normally would in order for your OBD system to update. A recheck with the above test routine may then indicate that the system is now ready.

Regardless of whether your vehicle's OBD system is ready or not ready, if the MIL symbol is illuminated during normal vehicle operation, you should have your vehicle serviced before going to the I/M station. The I/M station can fail your vehicle because the MIL symbol is on with the engine running.

REPLACEMENT PARTS

Use of genuine Mopar® parts for normal/scheduled maintenance and repairs is highly recommended to insure the designed performance. Damage or failures caused by the use of non-Mopar® parts for maintenance and repairs will not be covered by the manufacturer's warranty.

DEALER SERVICE

Your dealer has the qualified service personnel, special tools and equipment to perform all service operations in an expert manner. Service manuals are available which include detailed service information for your vehicle. Refer to these manuals before attempting any procedure yourself.

NOTE: Intentional tampering with emissions control systems can result in civil penalties being assessed against you.

WARNING!

You can be badly injured working on or around a motor vehicle. Do only that service work for which you have the knowledge and the proper equipment. If you have any doubt about your ability to perform a service job, take your vehicle to a competent mechanic.

MAINTENANCE PROCEDURES

The pages that follow contain the **required** maintenance services determined by the engineers who designed your vehicle.

Besides the maintenance items for which there are fixed maintenance intervals, there are other items that should operate satisfactorily without periodic maintenance. However, if a malfunction of these items does occur, it could adversely affect the engine or vehicle performance. These items should be inspected if a malfunction is observed or suspected.

Engine Oil

Checking Engine Oil Level

To assure proper lubrication of your vehicle's engine, the engine oil must be maintained at the correct level. The best time to check the engine oil level is about 5 minutes after a fully warmed up engine is shut off or before starting the engine after it has sat overnight.

Checking the oil while the vehicle is on level ground will improve the accuracy of the oil level readings. Maintain the oil level between the ADD and SAFE markings on the dipstick. Adding one quart of oil when the reading is at the ADD mark will result in a SAFE reading on these engines.

It is important to check the oil while the vehicle is on level ground. Add oil only when the level is at or below the ADD OIL mark.

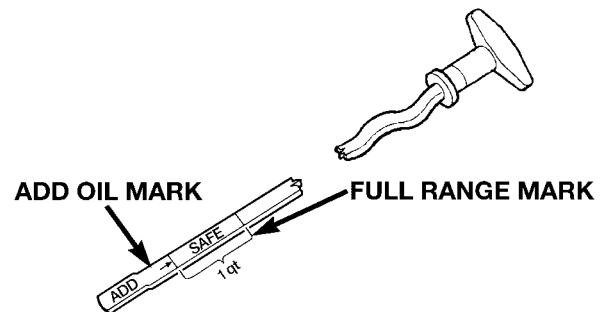

CAUTION!

Overfilling or underfilling the crankcase will cause oil aeration or loss of oil pressure. This could damage your engine.

Frequency Of Oil Change

Road conditions and your style of driving affect the interval at which your oil should be changed. Check the following to determine if any apply to you:

- Day or night temperatures are below 32°F (0°C).
- Stop and go driving.
- Extensive engine idling.
- Driving in dusty conditions
- Short trips of less than 10 miles (16.2 km)
- More than 50% of your driving is at sustained high speeds during hot weather, above 32°C (90°F)

- Trailer towing
- Taxi, Police or delivery service (commercial service)
- Off-road or desert operation
- **If equipped for and operating with E-85 (ethanol) fuel.**

NOTE: If **ANY** of these apply to you then change your engine oil every 3,000 miles (5 000 km) or 3 months, whichever comes first and follow schedule "B" of the "Maintenance Schedules" section of this manual.

If none of these apply to you, then change your engine oil at every interval shown on schedule "A" of the "Maintenance Schedules" section of this manual.

4x4 Models, If Used Primarily For Off-Road Operation

Every 50 hours of use.

Dusty Conditions

Driving through dust-laden air increases the problems of keeping abrasive materials out of the engine. Under these conditions, special attention should be given to the engine air cleaner and the crankcase inlet air cleaner. The crankcase ventilation system should also be checked periodically. Make sure that these units are always clean. This will tend to reduce to a minimum the amount of abrasive material that may enter the engine.

Engine Oil Selection

For best performance and maximum protection under all types of operating conditions, the manufacture only recommends engine oils that are API certified and meet the requirements of DaimlerChrysler Material Standard MS-6395. Use Mopar or an equivalent oil meeting the specification MS-6395.

American Petroleum Institute (API) Oil Identification Symbol

There is a symbol to aid you in selecting the proper engine oil.



This symbol means that the oil has been certified by the American Petroleum Institute (API). The manufacture only recommends API Certified engine oils that meet the requirements of DaimlerChrysler Material Standard MS-6395. Use Mopar or an equivalent oil meeting the specification MS-6395.

Engine Oil Viscosity Chart

The proper SAE viscosity grade of engine oil should be selected based on the following recommendation and be within the operating temperature shown in the recommended SAE viscosity chart.

- SAE 5W-30 is the oil recommended in trucks equipped with a 3.7L/4.7L engine, for optimum fuel economy.
- Synthetic engine oils may be used provided that the oil quality requirements described above are met and the recommended maintenance intervals for oil and filter changes are followed.

- Lubricants which do not have both the engine oil certification mark or current service symbol and the correct viscosity grade number should not be used.

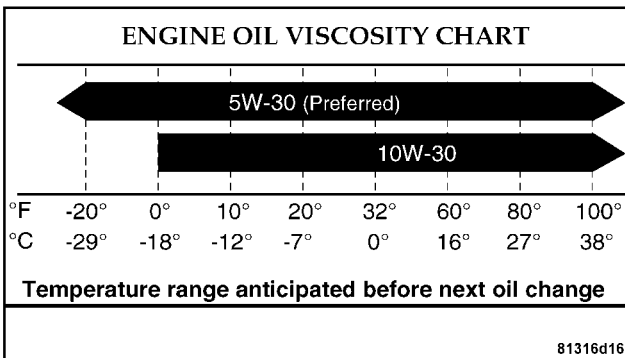

3.7L/4.7L Engines

Synthetic Engine Oils

There are a number of engine oils being promoted as either synthetic or semi-synthetic. If you chose to use such a product, use **only** those oils that meet the American Petroleum Institute (API) and SAE viscosity standard. Follow the service schedule that describes your driving type.

Materials Added to Engine Oil

The manufacture strongly recommends against the addition of any additives (other than leak detection dyes) to the engine oil. Engine oil is an engineered product and it's performance may be impaired by supplemental additives.

Disposing of Used Engine Oil And Oil Filters

Care should be taken in disposing of used engine oil and oil filters from your vehicle. Used oil and oil filters, indiscriminately discarded, can present a problem to the environment. Contact your dealer, service station, or governmental agency for advice on how and where used oil and oil filters can be safely discarded in your area.

Engine Oil Filter

The engine oil filter should be replaced at every engine oil change.

Engine Oil Filter Selection

The manufacturer's engines have a full-flow type oil filter. Use a filter of this type for replacement. The quality of replacement filters varies considerably. Only high

quality filters should be used to assure most efficient service. Mopar Engine Oil Filters are a high quality oil filter and are recommended.

Drive Belts — Check Condition and Tension

At the mileage indicated in the maintenance schedule, all belts should be checked for condition and proper tension. Improper belt tension can cause belt slippage and failure.

Belts should be inspected for evidence of cuts, cracks, or glazing, and replaced if there is indication of damage which could result in belt failure. If adjustment is required, see your authorized dealer for service. Low generator belt tension can cause battery failure. A special tool is required to properly measure tension and to restore belt tension to factory specifications.

Also check belt routing to make sure there is no interference between the belts and other engine components.

Spark Plugs

Spark plugs must fire properly to assure proper engine performance and emission control. The plugs installed in your vehicle should operate satisfactorily in normal service for the mileage indicated in the Maintenance

Chart. New plugs should be installed at this mileage. The entire set should be replaced if there is any malfunction due to a faulty spark plug. Check the Vehicle Emissions Control Information label for the proper type of spark plug for your vehicle.

CAUTION!

When replacing plugs, do not overtighten. You could damage them and cause them to leak.

Ignition Cables

Replace the ignition cables at the mileage interval shown in the maintenance charts.

Engine Air Cleaner Filter

Under normal driving conditions, replace the air filter at the intervals shown on Schedule "A". If, however, you drive the vehicle frequently under dusty or severe conditions, the filter element should be inspected periodically and replaced if necessary at the intervals shown on Schedule "B".

WARNING!

The air cleaner can provide a measure of protection in the case of engine backfire. Do not remove the air cleaner unless such removal is necessary for repair or maintenance. Make sure that no one is near the engine compartment before starting the vehicle with the air cleaner removed. Failure to do so can result in serious personal injury.

Engine Fuel Filter

A plugged fuel filter can cause stalling, limit the speed at which a vehicle can be driven or cause hard starting. Should an excessive amount of dirt accumulate in the fuel tank, frequent filter replacement may be necessary.

Catalytic Converter

The catalytic converter requires the use of unleaded fuel only. Leaded gasoline will destroy the effectiveness of the catalyst as an emission control device.

Under normal operating conditions, the catalytic converter will not require maintenance. However, it is important to keep the engine properly tuned to assure proper catalyst operation and prevent possible catalyst damage.

CAUTION!

Damage to the catalytic converter can result if your vehicle is not kept in proper operating condition. In the event of engine malfunction, particularly involving engine misfire or other apparent loss of performance, have your vehicle serviced promptly. Continued operation of your vehicle with a severe malfunction could cause the converter to overheat, resulting in possible damage to the converter and the vehicle.

NOTE: Intentional tampering with emissions control systems can result in civil penalties being assessed against you.

WARNING!

A hot exhaust system can start a fire if you park over materials that can burn. Such materials might be grass or leaves coming into contact with your exhaust system. Do not park or operate your vehicle in areas where your exhaust system can contact anything that can burn.

In unusual situations involving grossly malfunctioning engine operation, a scorching odor may indicate severe and abnormal catalyst overheating. If this occurs, the vehicle should be stopped, the engine shut off and the vehicle allowed to cool. Thereafter, service, including a tune-up to manufacturer's specifications, should be obtained immediately.

To minimize the possibility of catalyst damage:

- Do not shut off the engine or interrupt the ignition when the transmission is in gear and the vehicle is in motion.
- Do not try to start engine by pushing or towing the vehicle.
- Do not idle the engine with any spark plug wires disconnected or removed, such as when diagnostic testing, or for prolonged periods during very rough idling or malfunctioning operating conditions.

Maintenance-Free Battery



All Dodge trucks are equipped with maintenance-free batteries. You will never have to add water, nor is periodic maintenance required.

WARNING!

Battery posts, terminals, and related accessories contain lead and lead compounds. Always wash hands after handling the battery.

CAUTION!

It is essential when replacing the cables on the battery that the positive cable is attached to the positive post and the negative cable is attached to the negative post. Battery posts are marked (+) positive and negative (-) and identified on the battery case. Also, if a "fast charger" is used while battery is in the vehicle, disconnect both vehicle battery cables before connecting the charger to battery. Do not use a "fast charger" to provide starting voltage.

BATTERY CONDITION INDICATOR	O.K. TO JUMP START	 <ul style="list-style-type: none"> DARKENED INDICATOR WITH GREEN DOT • BATTERY CHARGE OK • FLUID LEVEL OK
		 <ul style="list-style-type: none"> DARKENED INDICATOR NO GREEN DOT • BATTERY CHARGE LOW • FLUID LEVEL OK
	DO NOT JUMP START	 <ul style="list-style-type: none"> YELLOW OR BRIGHT INDICATOR • BATTERY CHARGE UNKNOWN • FLUID LEVEL LOW (CHARGE MAY STILL BE SUFFICIENT TO START YOUR CAR)

To determine the battery charge, check the battery test indicator (if equipped) on top of the battery. Refer to the illustration.

Air Conditioner Maintenance

For best possible performance, your air conditioner should be checked and serviced by an Authorized Dealer at the start of each warm season. This service should include cleaning of the condenser fins and a performance test. Drive belt tension should also be checked at this time.

WARNING!

- Use only refrigerants and compressor lubricants approved by the manufacturer for your air conditioning system. Some unapproved refrigerants are flammable and can explode, injuring you. Other unapproved refrigerants or lubricants can cause the system to fail, requiring costly repairs.
- The air conditioning system contains refrigerant under high pressure. To avoid risk of personal injury or damage to the system, adding refrigerant or any repair requiring lines to be disconnected should be done by an experienced repairman.

Refrigerant Recovery and Recycling

R-134a Air Conditioning Refrigerant is a hydrofluorocarbon (HFC) that is endorsed by the Environmental Protection Agency and is an ozone-saving product. However, the manufacturer recommends that air conditioning service be performed by dealers or other service facilities using recovery and recycling equipment.

Power Steering — Fluid Check

Checking the power steering fluid level at a defined service interval is not required. The fluid should only be checked if a leak is suspected, abnormal noises are apparent, and/or the system is not functioning as anticipated. Coordinate inspection efforts through a certified DaimlerChrysler Dealership."

WARNING!

Fluid level should be checked on a level surface and with the engine off to prevent injury from moving parts and to insure accurate fluid level reading. Do not overfill. Use only manufacturers recommended power steering fluid.

If necessary, add fluid to restore to the proper indicated level. With a clean cloth, wipe any spilled fluid from all surfaces. Refer to Recommended Fluids, Lubricants, and Genuine Parts for correct fluid type.

Front Suspension Ball Joints

The ball joints and seals should be inspected whenever the vehicle is serviced for other reasons. Damaged seals should be replaced to prevent leakage or contamination of the grease.

Steering Linkage

Whenever the vehicle is hoisted, all steering linkage joints should be inspected for evidence of damage. Damaged seals should be replaced to prevent leakage or contamination of the grease.

Drive Shaft Constant Velocity Joints — 4X4 Models

All four-wheel drive models are equipped with four constant velocity joints. Periodic lubrication of these joints is not required. However, the joint boot should be inspected for external leakage or damage periodically. If external leakage or damage is evident, the joint boot and grease should be replaced immediately. Continued operation could result in failure of the joint due to water and dirt contamination of the grease. This would require complete replacement of the joint assembly. Refer to the Service Manual for the detailed replacement procedure.

Body Lubrication

Locks and all body pivot points, including such items as seat tracks, doors, liftgate and hood hinges, should be lubricated periodically to assure quiet, easy operation and to protect against rust and wear. Prior to the application of any lubricant, the parts concerned should be wiped clean to remove dust and grit; after lubricating excess oil and grease should be removed. Particular attention should also be given to hood latching components to insure proper function. When performing other underhood services, the hood latch, release mechanism and safety catch should be cleaned and lubricated.

The external lock cylinders should be lubricated twice a year, preferably in the fall and spring. Apply a small amount of a high quality lubricant such as Mopar® Lock Cylinder Lubricant directly into the lock cylinder.

Windshield Wiper Blades

The rubber edges of the wiper blades and the windshield should be cleaned periodically with a sponge or soft cloth and a mild nonabrasive cleaner. This will remove accumulations of salt or road film.

Operation of the wipers on dry glass for long periods may cause deterioration of the wiper blades. Always use washer fluid when using the wipers to remove salt or dirt from a dry windshield.

Avoid using the wiper blades to remove frost or ice from the windshield. Keep the blade rubber out of contact with petroleum products such as engine oil, gasoline, etc.

Windshield Washers

The fluid reservoir should be checked for fluid level at regular intervals. When freezing weather is anticipated, flush out the water in the reservoir by operating the system. Fill the reservoir with windshield washer anti-freeze (not radiator antifreeze), and operate the system for a few seconds to flush out the residual water.

To prevent freeze-up of your windshield washer system in cold weather, select a solution or mixture that meets or exceeds the temperature range of your climate. This rating information can be found on most washer fluid containers.

WARNING!

Commercially available windshield washer solvents are flammable. They could ignite and burn you. Care must be exercised when filling or working around the washer solution.

After the engine has warmed, operate the defroster for a few minutes to reduce the possibility of smearing or freezing the fluid on the cold windshield. Mopar All Weather Windshield Washer Solution used with water as directed on the container, aids cleaning action, reduces freezing point to avoid line clogging, and is not harmful to paint or trim.

Exhaust System

The best protection against carbon monoxide entry into the vehicle body is a properly maintained engine exhaust system.

Whenever a change is noticed in the sound of the exhaust system, when exhaust fumes can be detected inside the vehicle, or when the underside or rear of the vehicle is damaged, have a competent mechanic inspect the complete exhaust system and adjacent body areas for broken, damaged, deteriorated, or mispositioned parts. Open seams or loose connections could permit exhaust fumes to seep into the passenger compartment. In addition, inspect the exhaust system each time the vehicle is raised for lubrication or oil change. Replace as required.

WARNING!

Exhaust gases can injure or kill. They contain carbon monoxide (CO) which is colorless and odorless. Breathing it can make you unconscious and can eventually poison you. To avoid breathing CO, follow the preceding safety tips.

Cooling System

Inspection

Coolant protection checks should be made at every 12 months (before the onset of freezing weather, where applicable). If coolant is dirty or rusty in appearance, the system should be drained, flushed and refilled with fresh coolant. Check face of radiator for any accumulation of bugs, leaves, etc. If dirty, clean the radiator core by gently spraying water from a garden hose at the back of the core.

Check the reserve tank tubing for condition and tightness of connection at reserve tank and radiator. Inspect the entire system for leaks.

With the engine at normal operating temperature (but not running), check the coolant pressure cap for proper vacuum sealing by draining a small amount of coolant from the radiator drain cock. If the cap is sealing properly, the coolant will begin to drain from the reserve tank. Do not remove the pressure cap when the cooling system is hot.

WARNING!

You or others can be badly burned by hot coolant or steam from your radiator. If you see or hear steam coming from under the hood don't open the hood until the radiator has had time to cool. If you open the hood and see steam or hot coolant escaping from the radiator, don't touch anything. Get away quickly. Never try to open a pressure cap when the radiator is hot.

Cooling System Maintenance

At the intervals shown on the Maintenance Schedules, the system should be drained, flushed and filled.

Cooling System — Drain, Flush And Refill

If the solution is dirty and contains a considerable amount of sediment, clean and flush with a reliable cooling system cleaner. Follow with a thorough rinsing to remove all deposits and chemicals. Discard old antifreeze solution according to recommended procedure.

Disposal of Used Engine Coolant

Used ethylene glycol-based engine coolant is a regulated substance requiring proper disposal. Check with your local authorities to determine the disposal rules for your community. Do not store ethylene glycol-based engine coolant in open containers or allow it to remain in puddles on the ground. Prevent ingestion by animals and children. If ingested by a child, contact a physician immediately. Clean up any ground spills immediately.

Recommended Engine Coolant

Refer to Recommended Fluids, Lubricants and Genuine Parts for correct fluid type.

CAUTION!

Mixing of coolants other than specified (non-HOAT), may result in engine damage that may not be covered under the new vehicle warranty, and decreased corrosion protection. If a non-HOAT coolant is introduced into the cooling system in an emergency, it should be replaced with the specified coolant as soon as possible.

Do not use plain water alone or alcohol base antifreeze products. Do not use additional rust inhibitors or antirust products, as they may not be compatible with the radiator coolant and may plug the radiator.

This vehicle has not been designed for use with Propylene Glycol based coolants. Use of Propylene Glycol based coolants is not recommended.

Adding Coolant

When adding coolant or refilling system, a 50% solution of ethylene glycol antifreeze coolant in water should be

used. Higher concentrations (not to exceed 65%) are required if temperatures below -37°F (-38°C) are anticipated.

Use only high purity water such as distilled or deionized water when mixing the water/antifreeze solution. The use of lower quality water will reduce the amount of corrosion protection in the engine cooling system.

Please note that it is the owner's responsibility to maintain the proper level of protection against freezing according to the temperatures occurring in the area where the vehicle is operated.

WARNING!

Never add coolant to the radiator when the engine is overheated. Do not loosen or remove pressure cap to cool overheated engine. The coolant is under pressure and severe scalding could result.

Coolant Pressure Cap

The coolant pressure cap must be fully tightened to prevent loss of coolant, and to insure that coolant will return to the radiator from the coolant reserve tank.

The pressure cap should be inspected and cleaned if there is any accumulation of foreign material on the sealing surfaces.

WARNING!

The warning words “DO NOT OPEN HOT” on the coolant pressure cap are a safety precaution. Heat causes pressure to build up in the cooling system. To prevent scalding or injury, do not remove the pressure cap when the system is hot or under pressure.

Coolant Level

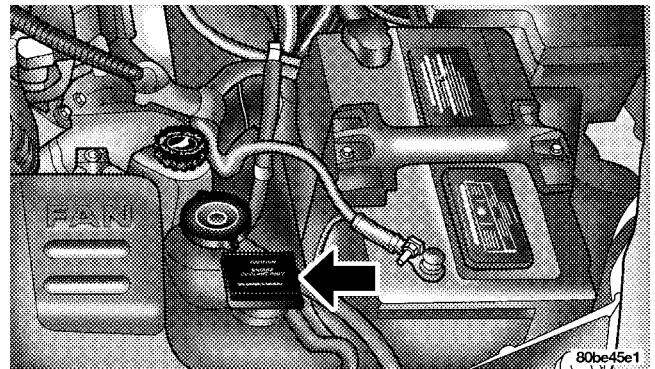

The coolant reserve system provides a quick visual method for determining that the coolant level is adequate. With the engine idling, and warmed to normal operating temperature, remove the cap from the overflow bottle, remove the dipstick and wipe the excess coolant from it. Reinsert the dipstick and remove. Observe the dipstick checking the holes along the stem for coolant. Check the coolant level whenever the hood is raised.



80880443

The radiator normally remains completely full, so there is no need to remove the pressure cap except when checking coolant freeze point or when replacing coolant. Your service attendant should be advised of this. When additional coolant is needed to maintain the proper level, it should be added to the overflow bottle. Do not overfill.

Points To Remember

- A. Do not overfill the reserve tank (overflow bottle).
- B. Check coolant freeze point in the radiator and in the reserve tank. If antifreeze needs to be added, contents of reserve tank also must be protected against freezing.
- C. If frequent coolant additions are required, or if the level in the reserve tank does not drop when the engine cools, the cooling system should be pressure tested for leaks.

D. Maintain a minimum coolant concentration of 50% ethylene glycol.

E. Make sure that the radiator and reserve tank overflow hoses are not kinked or obstructed.

F. Keep the front of the radiator clean. If your vehicle is equipped with air conditioning, keep the front of the condenser clean also.

G. The thermostat should not be changed for summer or winter operation. If replacement is ever necessary, install ONLY the correct type thermostat. Other designs may result in unsatisfactory cooling performance.

Emission Related Components

Fuel System Hoses And Vapor/Vacuum Harnesses

When the vehicle is serviced for scheduled maintenance, inspect surface of hoses and nylon tubing for evidence of heat and mechanical damage. Hard and brittle rubber, cracking, checking, tears, cuts, abrasions, and excessive swelling suggest deterioration of the rubber. Particular attention should be given to examining hose surfaces nearest to high heat sources, such as the exhaust manifold.

Insure nylon tubing in these areas has not melted or collapsed.

Inspect all hose clamps and couplings to make sure they are secure and no leaks are present.

NOTE: Fluids such as oil, power steering fluid, and brake fluid are used during assembly plant operations to ease the assembly of hoses to couplings. Therefore, oil wetness at the hose-coupling area is not necessarily an indication of leakage. Actual dripping of hot fluid when systems are under pressure (during vehicle operation), should be noted before hose is replaced based on leakage.

You are urged to use only manufacturer specified hoses and clamps, or their equivalent in material and specification, in any fuel system servicing. It is mandatory to replace all clamps that have been loosened or removed during service. Care should be taken in installing new clamps to insure they are properly torqued.

Positive Crankcase Ventilation (PCV) Valve

Proper operation of the crankcase ventilation system requires that the PCV valve be free of sticking or plugging because of deposits. Deposits can accumulate in the

PCV valve and passage with increasing mileage. Have the PCV valve, hoses, and passages checked for proper operation at the intervals specified. If the valve is plugged or sticking, replace with a new valve. **Do not attempt to clean the oil PCV valve!** Check ventilating hose for indication of damage or plugging with deposits. Replace if necessary.

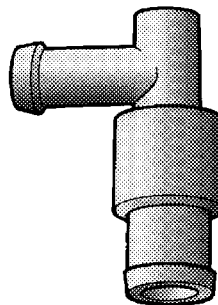

Brake System

Power Disc Brakes (Front)

Disc brakes do not require adjustment; however, several hard stops during the break-in period are recommended to seat the linings and wear off any foreign material.

Self-Adjusting Rear Brakes

To maintain the correct adjustment, you need only drive your vehicle in reverse and apply the brakes. If further adjustment is needed, drive forward about 20 feet (6 meters) before you repeat the reverse application. To avoid poor braking, brake pull, or damage to brake drums, the brake linings should be inspected as specified in the Maintenance Schedule.

Brake Master Cylinders

The fluid level in the master cylinders should be checked whenever the vehicle is serviced, or immediately if the brake system warning light is on. If necessary, add fluid to bring level to the full mark on the side of the reservoir of the brake master cylinder. Be sure to clean the top of the master cylinder area before removing the cap. With disc brakes, fluid level can be expected to fall as the brake

pads wear. Brake fluid level should be checked when pads are replaced. If the brake fluid level is abnormally low, check system for leaks.

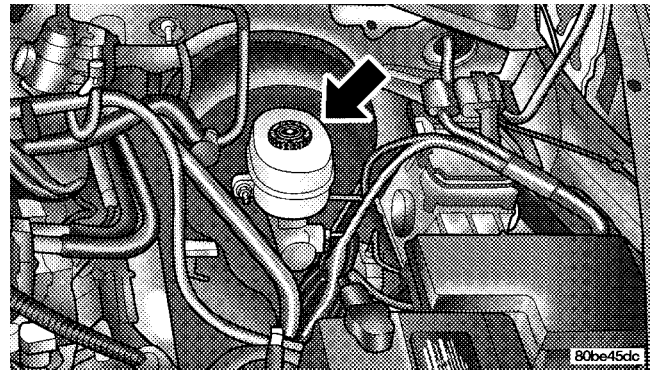

Refer to Recommended Fluids, Lubricants and Genuine Parts for correct fluid type.

WARNING!

Use of brake fluid that may have a lower initial boiling point, or is unidentified as to specifications, may result in sudden brake failure during hard prolonged braking. You could have an accident.

WARNING!

Overfilling the brake fluid reservoir can result in spilling brake fluid on hot engine parts and the brake fluid catching fire.

Use only brake fluid that has been in a tightly closed container to avoid contamination from foreign matter or moisture.

CAUTION!

Do not allow a petroleum-base fluid to contaminate the brake fluid. Seal damage may result.

Brake Linings

Your vehicle is equipped with self-adjusting brakes. A few brake applications while moving in reverse will maintain your brakes at the specified adjustment. Adjustment will continue until the brake linings are worn. To avoid brake failure, brake pull or damage to drums, inspect the brake linings as specified. If excessively worn, the brake linings must be replaced.

Brake Hoses

Inspection should be performed whenever the brake system is serviced or at intervals specified. Inspect hydraulic brake hoses for surface cracking, scuffing or worn spots. If there is any evidence of cracking, scuffing, or worn spots, the hose should be replaced immediately! Eventual deterioration of the hose can take place with possible burst failure.

WARNING!

Worn brake hoses can burst and cause brake failure. You could have an accident. If you see any sign of cracking, scuffing, or worn spots, have the brake hoses replaced immediately.

Clutch Hydraulic System

The clutch hydraulic system is a sealed maintenance free system. In the event of leakage or other malfunction, the system must be replaced.

Manual Transmission**Fluid Level Check**

This fluid should be checked whenever other underhood services are performed. The fluid level is checked by removing the fill plug. If the level of the lubricant is more than 1/4" (6.35 mm) below the bottom of the filler hole while the vehicle is level, enough lubricant should be added to bring the level to the bottom of the filler hole.

NV-3500 5-Speed Transmission Lubricant Selection

These transmissions are filled with manual transmission fluid at the factory. This fluid does not require periodic changing. If it becomes necessary to add or change the fluid in these transmissions, Refer to Recommended Fluids, Lubricants and Genuine Parts for correct fluid type.

Automatic Transmission**Fluid Level Check – 3.7/4.7L Engine**

Check the fluid level while the transmission is at normal operating temperature 180°F (82°C). This occurs after at least 15 miles (25 km) of driving. At normal operating temperature the fluid cannot be held comfortably between the fingertips.

To check the automatic transmission fluid level properly, the following procedure must be used:

1. Operate the engine at idle speed and normal operating temperature.
2. The vehicle must be on level ground.

3. Fully apply the parking brake and press the brake pedal.
4. Place the gear selector momentarily in each gear position ending with the lever in P (Park).

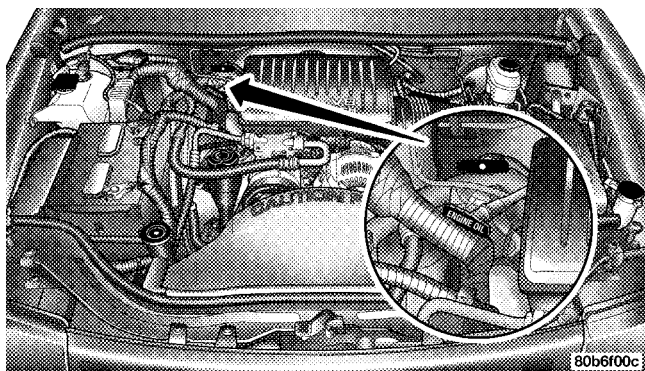

5. Remove the dipstick, wipe it clean and reinsert it until seated.
6. Remove the dipstick again and note the fluid level on both sides. The fluid level should be between the "HOT" (upper) reference holes on the dipstick at normal operating temperature. Verify that solid coating of oil is seen on

both sides of the dipstick. If the fluid is low, add as required into the dipstick tube. **Do not overfill.** After adding any quantity of oil through the oil fill tube, wait a minimum of two (2) minutes for the oil to fully drain into the transmission before rechecking the fluid level.

NOTE: If it is necessary to check the transmission **below** the operating temperature, the fluid level should be between the two "COLD" (lower) holes on the dipstick with the fluid at approximately 70°F (21°C) (room temperature). If the fluid level is correctly established at room temperature, it should be between the "HOT" (upper) reference holes when the transmission reaches 180°F (82°C). Remember it is best to check the level at the normal operating temperature.

CAUTION!

Be aware that if the fluid temperature is below 50°F (10°C) it may not register on the dipstick. Do not add fluid until the temperature is elevated enough to produce an accurate reading.

7. Check for leaks. Release parking brake.

To prevent dirt and water from entering the transmission after checking or replenishing fluid, make certain that the dipstick cap is properly reseated. It is normal for the dipstick cap to spring back slightly from its fully seated position, as long as its seal remains engaged in the dipstick tube.

Automatic Transmission Fluid And Filter Change

To obtain best performance and long life for automatic transmissions, the manufacturer recommends that they be given regular maintenance service by an Authorized Dodge Dealer or Service Center. It is important that the transmission be adjusted periodically, the fluid be maintained at the correct level, and that it be drained and refilled as specified.

It is important that proper lubricant is used in the transmission. Refer to Recommended Fluids, Lubricants and Genuine Parts for correct fluid type. It is important that the transmission fluid be maintained at the prescribed level using the recommended fluid.

CAUTION!

Using a transmission fluid other than the manufacturers recommended fluid may cause deterioration in transmission shift quality and/or torque converter shudder. Using a transmission fluid other than the manufacturers recommended fluid will result in more frequent fluid and filter changes. Refer to Recommended Fluids, Lubricants and Genuine Parts for correct fluid type.

Refer to the “Maintenance Schedules” section for the proper service intervals for your type of driving.

If the transmission is disassembled for any reason, the fluid and filter should be changed, and the bands adjusted (if equipped).

Special Additives

The manufacturer strongly recommends against the addition of any fluid additives to the transmission. Exception to this policy is the use of special dyes to aid in detecting fluid leaks. The use of transmission sealers should be avoided, since they may adversely affect seals.

Transfer Case

Inspect the transfer case for fluid leaks. If a fluid leak is evident the transfer case fluid level can be checked by removing the filler plug located on the back side of the transfer case. The fluid level should be at the bottom edge of the filler plug hole when the vehicle is in a level position.

The transfer case fluid should be drained and refilled at the intervals specified.

Lubricant Selection

Refer to Recommended Fluids, Lubricants and Genuine Parts for correct fluid type.

Axles

Refer to Recommended Fluids, Lubricants and Genuine Parts for correct fluid type.

The manufacturer does not recommend regularly scheduled oil changes for axles in vehicles whose operation is classified as normal truck service.

NOTE: The presence of water in the gear lubricant will result in corrosion and possible failure of differential components. Operation of the vehicle in water, as may be

encountered in some off-highway types of service, will require draining and refilling the axle to avoid damage.

Rear Axle

Limited-slip differentials require the use of Mopar® limited slip additive. Refer to Recommended Fluids, Lubricants and Genuine Parts for correct fluid type. This should be added to the gear lubricant whenever a fluid change is made, when equipped with a limited-slip differential. Rear axle fluid level should be 1/4" (6.35 mm) below filler plug hole for 8 1/4 axles and should be 5/8" (16 mm) below filler plug hole for 9 1/4" axles.

Front Axle

Front axle fluid level should be at the bottom of the filler plug hole.

Selection of Lubricating Grease

The National Lubricating Grease Institute (NLGI) has developed a symbol (Certification Mark) to aid the vehicle owner in the proper selection of grease for chassis components. This symbol, an example shown below, is located on the grease container and identifies the application and quality of the grease.



There are two groups identified, those for wheel bearings (Letter "G") and those for chassis (Letter "L") lubrication. Performance categories within these groups result in dual letter designations for each group. The letter designations shown in the example are the highest

quality level available and when combined as shown can be used for chassis lubrication. Use only those greases that have the NLGI symbol on the container along with the proper quality level for your application.

Appearance Care and Protection from Corrosion

Protection of Body and Paint from Corrosion

Vehicle body care requirements vary according to geographic locations and usage. Chemicals that make roads passable in snow and ice, and those that are sprayed on trees and road surfaces during other seasons, are highly corrosive to the metal in your vehicle. Outside parking,

which exposes your vehicle to airborne contaminants, road surfaces on which the vehicle is operated, extreme hot or cold weather and other extreme conditions will have an adverse effect on paint, metal trim, and underbody protection.

The following maintenance recommendations will enable you to obtain maximum benefit from the corrosion resistance built into your vehicle.

What Causes Corrosion?

Corrosion is the result of deterioration or removal of paint and protective coatings from your vehicle.

The most common causes are:

- Road salt, dirt and moisture accumulation.
- Stone and gravel impact.
- Insects, tree sap and tar.
- Salt in the air near seacoast localities.
- Atmospheric fallout/industrial pollutants.

Washing

- Wash your vehicle regularly. Always wash your vehicle in the shade using a mild car wash soap, and rinse the panels completely with clear water.
- If insects, tar or other similar deposits have accumulated on your vehicle, wash it as soon as possible.
- Use Mopar auto polish to remove road film and stains and to polish your vehicle. Take care never to scratch the paint.
- Avoid using abrasive compounds and power buffing that may diminish the gloss or thin out the paint finish.

CAUTION!
Do not use abrasive or strong cleaning materials such as steel wool or scouring powder, which will scratch metal and painted surfaces.

Special Care

- If you drive on salted or dusty roads or if you drive near the ocean, hose off the undercarriage at least once a month.
- It is important that the drain holes in the lower edges of the doors, rocker panels and tailgate be kept clear and open.
- If you detect any stone chips or scratches in the paint, touch them up immediately. The cost of such repairs is considered the responsibility of the owner.
- If your vehicle is damaged due to an accident or similar cause which destroys the paint and protective coating have your vehicle repaired as soon as possible. The cost of such repairs is considered the responsibility of the owner.
- All wheels and wheel trim, especially aluminum and chrome plated wheels should be cleaned regularly with mild soap and water to prevent corrosion. To remove heavy soil, select a nonabrasive, non-acidic cleaner. Do not use scouring pads, steel wool, a bristle brush or metal polishes. Only Mopar cleaners are

recommended. Do not use oven cleaner. Avoid automatic car washes that use acidic solutions or harsh brushes that may damage the wheels' protective finish.

- If you carry special cargo such as chemicals, fertilizers, de-icer salt, etc., be sure that such materials are well packaged and sealed.
- If a lot of driving is done on gravel roads, consider mud or stone shields behind each wheel.
- Use Mopar touch up paint on scratches as soon as possible. Your dealer has touch up paint to match the color of your vehicle.

Interior Care

Use Mopar Fabric Cleaner to clean fabric upholstery and carpeting.

Use Mopar Vinyl Cleaner to clean vinyl upholstery and trim.

Mopar Total Clean is specifically recommended for leather upholstery.

Your leather upholstery can be best preserved by regular cleaning with a damp soft cloth. Small particles of dirt can act as an abrasive and damage the leather upholstery and should be removed promptly with a damp cloth. Stubborn soils can be removed easily with a soft cloth and Mopar Total Clean. Care should be taken to avoid soaking your leather upholstery with any liquid. Please do not use polishes, oils, cleaning fluids, solvents, detergents, or ammonia based cleaners to clean your leather upholstery. Application of a leather conditioner is not required to maintain the original condition.

WARNING!

Do not use volatile solvents for cleaning purposes. Many are potentially flammable, and if used in closed areas they may cause respiratory harm.

7

Glass Surfaces

All glass surfaces should be cleaned on a regular basis with any commercial household-type glass cleaner. Never use an abrasive type cleaner. Use caution when cleaning inside rear windows equipped with electric

defrosters or windshields equipped with a windshield wiper de-icer. Do not use scrapers or other sharp instruments which may scratch the elements.

When cleaning the rear view mirror, spray cleaner on the towel or rag that you are using. Do not spray cleaner directly on the mirror.

Cleaning Plastic Instrument Cluster Lenses

The lenses in front of the instruments in this vehicle are molded in clear plastic. When cleaning the lenses, care must be taken to avoid scratching the plastic.

1. Clean with a wet soft rag. A mild soap solution may be used, but do not use high alcohol content or abrasive cleaners. If soap is used, wipe clean with a clean damp rag.
2. Dry with a soft tissue.

Seat Belt Maintenance

Do not bleach, dye or clean the belts with chemical solvents or abrasive cleaners. This will weaken the fabric. Sun damage will also weaken the fabric.

If the belts need cleaning, use a mild soap solution or lukewarm water. Do not remove the belts from the car to wash them.

Replace the belts if they appear frayed or worn or if the buckles do not work properly.

POWER DISTRIBUTION CENTER

Your vehicle is equipped with an electrical Power Distribution Center located in the engine compartment near the battery.

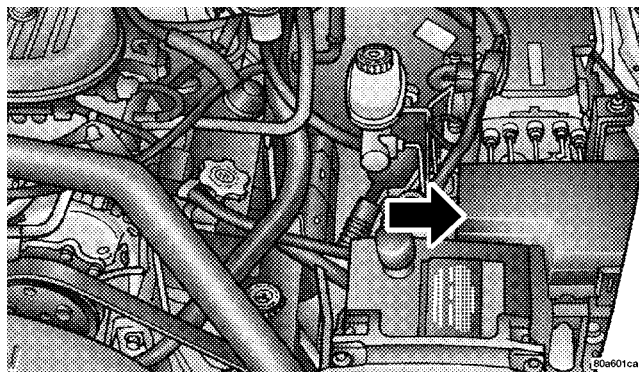

This power center houses plug-in cartridge and relays. A label inside the latching cover of the center identifies each component for ease of replacement, if necessary. Cartridge fuses and relays can be obtained from your Dodge dealer.

FUSE BLOCK

The fuse block contains blade-type mini-fuses, relays, and circuit breakers for high-current circuits. It is located just inboard of the left end of the instrument panel, behind the panel surface. It is accessible through a snap-in cover. Refer to the label on the backside of the fuse block cover for the proper fuse amperage and position.

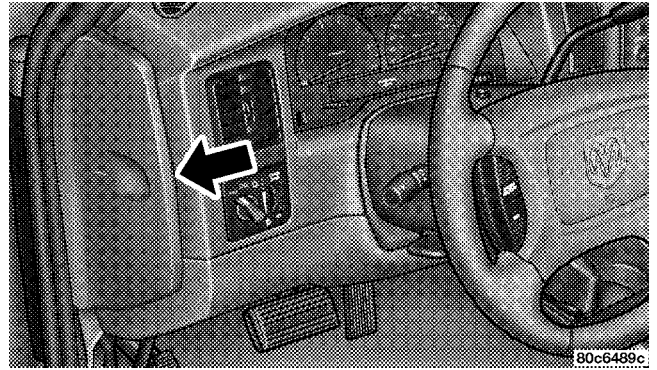

CAUTION!

When replacing a blown fuse, it is important to use only a fuse having the correct amperage rating. The use of a fuse with a rating other than indicated may result in a dangerous electrical system overload. If a properly rated fuse continues to blow, it suggests a problem in the circuit that must be corrected.

NOTE: If you are leaving your vehicle dormant for longer than 21 days, you may want to take steps to protect your battery. You may do this by disconnecting the battery or by disconnecting the ignition-off draw (I.O.D.) fuse in cavity #12. The I.O.D. cavity includes a snap-in retainer that allows the fuse to be disconnected, without removing it from the fuse block. Pressing the I.O.D. fuse back into the cavity reconnects it.

VEHICLE STORAGE

If you are storing your vehicle for more than 21 days, we recommend that you take the following steps to minimize the drain on your vehicle's battery:

- Disconnect the Ignition-Off Draw fuse (I.O.D.) fuse located in cavity #12 of the fuse block. The I.O.D. cavity includes a snap-in retainer that allows the fuse to be disconnected, without removing it from the fuse block.
- The transfer case should be placed in the 4HI mode and kept in this position to minimize the battery drain.
- As an alternative to the above steps you may disconnect the negative cable from the battery.

REPLACEMENT LIGHT BULBS

LIGHT BULBS — Inside

	Bulb No.
A/C Control	74
Ash Tray	161
Brake System Warning Indicator	194
Dome Light	579
EGR Reminder	194
Glove Box.	194
Heater Control	158
High Beam Indicator	194
Instrument Cluster.	194
Low Fuel Indicator	194
Low Washer Fluid Indicator	194
Oil Indicator	194
Overhead Console	578
Seat Belt Indicator	194
Switched Dome.	578
Temperature Indicator	194
Turn Signals	194
Underhood Light.	561
4x4 Shift Indicator	161

LIGHT BULBS — Outside	Bulb No.
Headlight	9007LL
Back-Up	3157
Center High Mounted Stoplight	921
Fog Lamp	881L
Front Sidemarker	168
License Plate Light	168
Park & Turn Signal (2)	3157
Tail, Stop, & Sidemarker	3157
Cargo (2)	921

BULB REPLACEMENT

Headlights

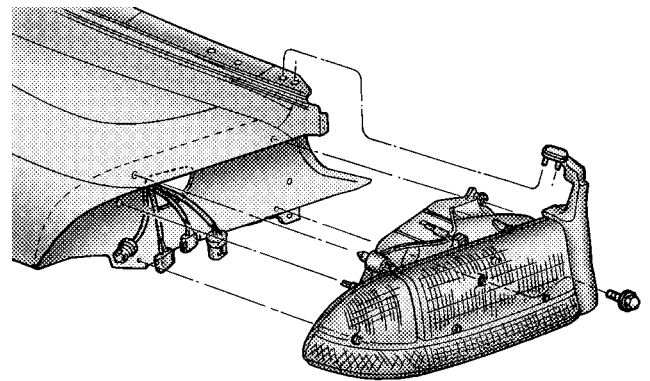

80bfe0c5

1. Open the hood.
2. Remove the screw as shown and pull the parking/turn signal housing out.
3. Disconnect connectors from the parking/turn signal lamp.

4. Remove the bolts attaching the headlamp to the inner fender panel.
5. Grasp the headlamp and pull firmly to disengage it from the panel.
6. Disconnect all connectors and separate the headlamp module from the vehicle
7. Remove the retaining ring holding the bulb to the headlamp.
8. Pull the bulb socket from the headlamp and pull the bulb from the socket.

NOTE: These are Halogen bulbs. Take care not to touch the bulb with your fingers.

Parking/Turn Signal Lights

1. Remove the screw as shown and pull the parking/turn signal housing out.

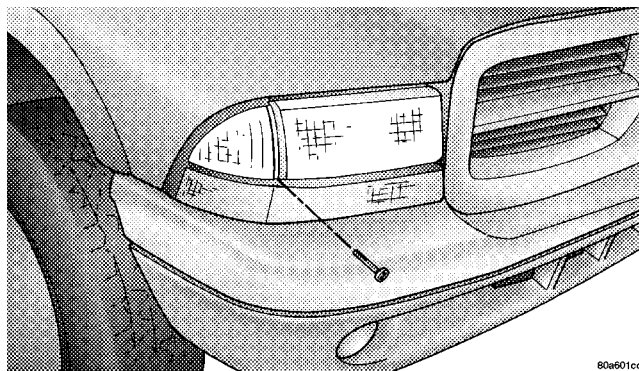

80a601cd

2. Turn the bulb and socket assembly 1/4 turn and pull to remove socket from housing.
3. The bulb can be removed from the socket by pulling straight out.

NOTE: Body oils from your fingers could cause excessive heat buildup which reduces bulb life.

Rear Side Marker, Tail Lights, Turn Signals And Backup Lights — Replacement

1. Remove the screws as illustrated. Grasp the tail light housing and pull it rearward.

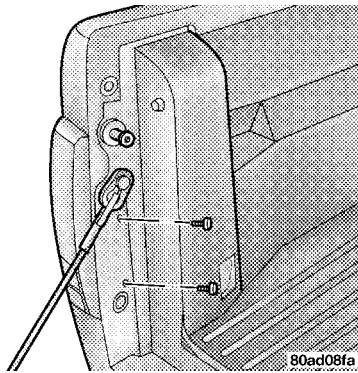

2. Rotate the bulb and socket assembly 1/4 turn and pull it from housing.
3. The bulb can be removed from the sockets by pulling it straight out.

License Lights

1. Rotate the socket 1/4 turn counterclockwise.
2. Pull the bulb from socket.

Center High-Mounted Stoplight

1. Remove two screws securing the stoplight housing assembly to the roof.

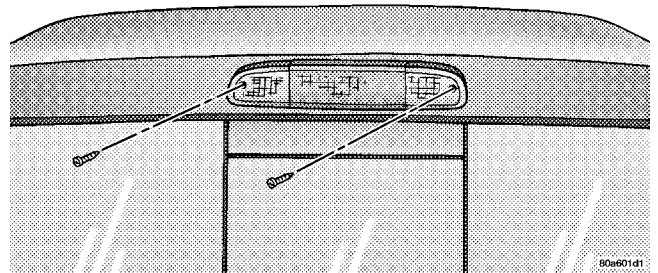

2. Turn the bulb and socket assembly 1/4 counterclockwise and free it from the housing.
3. Pull the bulb straight from socket to remove it.

Fog Lights

1. Rotate the bulb and connector 1/4 turn counterclockwise.
2. Pull the bulb off of connector.

FLUIDS AND CAPACITIES

	U.S.	Metric
Fuel		
Regular/Club Cab, 87 Octane	20 Gal. w/ORVR, 22 Gal. w/o ORVR	76L w/ORVR, 83L w/o ORVR
Quad Cab, 87 Octane	24 Gal.	91L
Engine Oil (with filter)		
3.7L, SAE 5W-30, API Certified	5 Qt.	4.7L
4.7L, SAE 5W-30, API Certified	6 Qt.	5.7L
Cooling System		
3.7L (Mopar® Antifreeze/Coolant 5 Year/100,000 Mile Formula)	NA	NA
4.7L (Mopar® Antifreeze/Coolant 5 Year/100,000 Mile Formula)	17 Qt.	16L

RECOMMENDED FLUIDS, LUBRICANTS AND GENUINE PARTS**Engine**

Component	Fluids, Lubricants and Genuine Parts
Engine Coolant	Mopar® Antifreeze/Coolant 5 Year/100,000 Mile Formula HOAT (Hybrid Organic Additive Technology) P/N 5011764AB or equivalent.
Engine Oil	Use SAE 5W-30, API Certified, meeting material standard MS-6395.
Engine Oil Filter	Mopar® Engine Oil Filter, P/N 5281090 or equivalent.
Spark Plugs	Refer to the Vehicle Emission Control Information label in the engine compartment.
Fuel Selection	87 Octane, (R+M)/2 Method

Chassis

Component	Fluids, Lubricants and Genuine Parts.
Automatic Transmission	Mopar® ATF+4, Automatic Transmission Fluid.
Manual Transmission (NV 3500)	Mopar® Manual Transmission Fluid, part number 4874464
Transfer Case	Mopar® ATF+4, Automatic Transmission Fluid.
Front and Rear Axles	SAE 75W-90 Multipurpose Type, GL-5 Gear Lubricant. Limited-Slip Rear Axles Require Mopar® limited slip additive. Four (4) ounces (118 ml) should be added to the gear lubricant whenever a fluid change is made.
Rear Axle Fluid for Trailer Towing	For all trailer towing or heavy duty applications, replace the factory fill rear axle fluid with Mopar® Synthetic Gear Lubricant SAE 75W-140 (MS-8985)
Brake Master Cylinder	Mopar® DOT 3 and SAE J1703 should be used. If DOT 3 brake fluid is not available, then DOT 4. Use only recommended brake fluids.
Power Steering Reservoir	Mopar® ATF+4, Automatic Transmission Fluid.
Steering Linkage	Mopar® Multi-Mileage Lubricant 5
Ball Joints	Mopar® Multi-Mileage Lubricant 5

MAINTENANCE SCHEDULES

CONTENTS

■ Emission Control System Maintenance	262	□ Schedule “B”	265
■ Emissions Testing	262	□ Schedule “A”	274
■ Maintenance Schedules	263		

EMISSION CONTROL SYSTEM MAINTENANCE

The “Scheduled” maintenance services, listed in **bold type** on the following pages must be done at the times or mileages specified to assure the continued proper functioning of the emission control system. These, and all other maintenance services included in this manual, should be done to provide best vehicle performance and reliability. More frequent maintenance may be needed for vehicles in severe operating conditions such as dusty areas and very short trip driving.

Inspection and service also should be done any time a malfunction is suspected.

NOTE: Maintenance, replacement, or repair of the emission control devices and systems on your vehicle may be performed by any automotive repair establishment or individual using any automotive part which has been certified pursuant to U.S. EPA or, in the State of California, California Air Resources Board regulations.

EMISSIONS TESTING

In some localities, it may be or will become a legal requirement to ensure that all emissions components and systems are functioning properly as a part of the test procedure. The test center accomplishes this by checking the On Board Diagnostic System (OBD) system with an electronic scan tool. If your vehicle has recently been serviced, the OBD system may have been reset to a “not ready” condition because the OBD system has not had sufficient time since the servicing to reconfirm that emissions components are operating properly. In most cases, a reasonable mix and amount of normal city and highway driving and at least one overnight-off period will be required to prepare your vehicle for this check; however your dealer has the equipment and procedures required to make certain that the OBD system of your vehicle is ready for the required testing.

MAINTENANCE SCHEDULES

There are two maintenance schedules that show the **required** service for your vehicle.

First is Schedule "B". It is for vehicles that are operated under the conditions that are listed below and at the beginning of the schedule.

- Day or night temperatures are below 32° F (0° C).
- Stop and go driving.
- Extensive engine idling.
- Driving in dusty conditions.
- Short trips of less than 10 miles (16 km).
- More than 50% of your driving is at sustained high speeds during hot weather, above 90° F (32° C).
- Trailer towing.
- Heavy Loading.
- Taxi, police, or delivery service (commercial service).
- Off-road or desert operation.

- If equipped for and operating with E-85 (ethanol) fuel.

NOTE: If ANY of these apply to you then change your engine oil every 3,000 miles (5 000 km) or 3 months, whichever comes first and follow schedule "B" of the "Maintenance Schedules" section of this manual.

NOTE: Most vehicles are operated under the conditions listed for Schedule "B".

Second is Schedule "A". It is for vehicles that are not operated under any of the conditions listed under Schedule "B".

Use the schedule that best describes your driving conditions. Where time and mileage are listed, follow the interval that occurs first.

NOTE: Under no circumstances should oil change intervals exceed 6,000 miles (10 000 km) or 6 months whichever comes first.

CAUTION!

Failure to perform the required maintenance items may result in damage to the vehicle.

At Each Stop for Fuel

- Check the engine oil level about 5 minutes after a fully warmed engine is shut off. Checking the oil level while the vehicle is on level ground will improve the accuracy of the oil level reading. Add oil only when the level is at or below the ADD or MIN mark.
- Check the windshield washer solvent and add if required.

Once a Month

- Check tire pressure and look for unusual wear or damage.
- Inspect the battery and clean and tighten the terminals as required.
- Check the fluid levels of coolant reservoir, brake master cylinder, and transmission and add as needed.

- Check all lights and all other electrical items for correct operation.

At Each Oil Change

- Change the engine oil filter.
- Inspect the exhaust system.
- Inspect the brake hoses.
- Inspect the CV joints (if equipped) and front suspension components.
- Check the automatic transmission fluid level (if equipped).
- Check the manual transmission fluid level (if equipped).
- Check the coolant level, hoses, and clamps.

Tire Rotation

- Rotate the tires every 6,000 miles (10 000 km).

Schedule "B"

Follow schedule "B" if you usually operate your vehicle under one or more of the following conditions.

- Day or night temperatures are below 32° F (0° C).
- Stop and go driving.
- Extensive engine idling.
- Driving in dusty conditions.
- Short trips of less than 10 miles (16 km).
- More than 50% of your driving is at sustained high speeds during hot weather, above 90° F (32° C).

- Trailer towing.
- Heavy Loading.
- Taxi, police, or delivery service (commercial service).
- Off-road or desert operation.
- **If equipped for and operating with E-85 (ethanol) fuel.**

NOTE: If **ANY** of these apply to you then change your engine oil every 3,000 miles (5 000 km) or 3 months, whichever comes first and follow schedule "B" of the "Maintenance Schedules" section of this manual.

266 SCHEDULE "B"

Miles (Kilometers)	3,000 (5 000)	6,000 (10 000)	9,000 (14 000)	12,000 (19 000)	15,000 (24 000)
Change engine oil and engine oil filter.	X	X	X	X	X
Change rear axle fluid.				X	
Change front axle fluid (4X4).				X	
Inspect brake linings.				X	
Inspect engine air cleaner filter, replace if necessary.					X

Miles (Kilometers)	18,000 (29 000)	21,000 (34 000)	24,000 (38 000)	27,000 (43 000)	30,000 (48 000)
Change engine oil and engine oil filter.	X	X	X	X	X
Change rear axle fluid.			X		
Change front axle fluid (4X4).			X		
Check transfer case fluid level (4X4).					X
Inspect brake linings.			X		
Inspect engine air cleaner filter, replace if necessary.					X
Replace spark plugs.					X
Inspect PCV valve, replace as necessary.*					X
Drain and refill automatic transmission fluid and change main sump filter (4.7L).					X

268 SCHEDULE "B"

Miles (Kilometers)	33,000 (53 000)	36,000 (58 000)	39, 000 (62 000)	42,000 (67 000)	45,000 (72 000)
Change engine oil and engine oil filter.	X	X	X	X	X
Change rear axle fluid.		X			
Change front axle fluid (4X4).		X			
Inspect brake linings.		X			
Inspect engine air cleaner filter, replace if necessary.					X

Miles (Kilometers)	48,000 (77 000)	51,000 (82 000)	54,000 (86 000)	57,000 (91 000)	60,000 (96 000)
Change engine oil and engine oil filter.	X	X	X	X	X
Change rear axle fluid.	X				X
Change front axle fluid (4X4).	X				X
Inspect brake linings.	X				X
Inspect engine air cleaner filter, replace if necessary.					X
Replace spark plugs.					X
Inspect PCV valve, replace as necessary.*					X
Inspect auto tension drive belt and replace if required.					X
Drain and refill transfer case (4X4).					X
Drain and refill automatic transmission fluid, change filter (3.7L). This applies only if your vehicle is used for police, taxi, fleet, heavy loading, or trailer towing.					X
Drain and refill automatic transmission fluid and change main sump filter (4.7L).					X

270 SCHEDULE "B"

Miles (Kilometers)	63,000 (101 000)	66,000 (106 000)	69,000 (110 000)	72,000 (115 000)	75,000 (120 000)
Change engine oil and engine oil filter.	X	X	X	X	
Change rear axle fluid.				X	
Change front axle fluid (4X4).				X	
Inspect brake linings.				X	
Inspect engine air cleaner filter, replace if necessary.					X
Inspect auto tension drive belt, replace if required.					X

Miles (Kilometers)	78,000 (125 000)	81,000 (130 000)	84,000 (134 000)	87,000 (139 000)	90,000 (144 000)
Change engine oil and engine oil filter.	X	X	X	X	X
Change rear axle fluid.			X		
Change front axle fluid (4X4).			X		
Check transfer case fluid level (4X4).					X
Inspect brake linings.			X		
Inspect engine air cleaner filter, replace if necessary.					X
Replace spark plugs.					X
Inspect PCV valve, replace as necessary.*					X
Inspect auto tension drive belt and replace if required.					X
Drain and refill automatic transmission fluid and change main sump and cooler return filter (if equipped) (4.7L).					X

272 SCHEDULE "B"

Miles (Kilometers)	93,000 (149 000)	96,000 (154 000)	99,000 (158 000)	100,000 (160 000)	102,000 (163 000)
Change engine oil and engine oil filter.	X	X	X		X
Flush and replace engine coolant.					X
Change rear axle fluid.		X			
Change front axle fluid (4X4).		X			
Inspect brake linings.		X			

Miles (Kilometers)	105,000 (168 000)	108,000 (173 000)	111,000 (178 000)	114,000 (182 000)	117,000 (187 000)	120,000 (192 000)
Change engine oil and engine oil filter.	X	X	X	X	X	X
Change rear axle fluid.		X				X
Change front axle fluid (4X4).		X				X
Inspect brake linings.		X				X
Inspect engine air cleaner filter, replace if necessary.	X					X
Replace spark plugs.						X
Inspect PCV valve, replace as necessary.*						X
Inspect auto tension drive belt and replace if required.	X					X
Drain and refill transfer case fluid (4X4).						X
Drain and refill automatic transmission fluid, change filter (3.7L). This applies only if your vehicle is used for police, taxi, fleet, heavy loading, or trailer towing.						X
Drain and refill automatic transmission fluid and change main sump filter (4.7L).						X

* This maintenance is recommended by the manufacture to the owner but is not required to maintain the emissions warranty.

‡ This maintenance is not required if previously replaced. Inspection and service should also be performed anytime a malfunction is observed or suspected. Retain all receipts.

274 SCHEDULE "A"

Schedule "A"

Miles (Kilometers) [Months]	6,000 (10 000) [6]	12,000 (19 000) [12]	18,000 (29 000) [18]	24,000 (38 000) [24]	30,000 (48 000) [30]
Change engine oil and engine oil filter.	X	X	X	X	X
Check transfer case fluid level (4X4).					X
Inspect brake linings.			X		
Replace engine air cleaner filter.					X
Replace spark plugs.					X

Miles (Kilometers)	36,000 (58 000)	42,000 (67 000)	48,000 (77 000)	54,000 (84 000)	60,000 (96 000)	66,000 (106 000)
[Months]	[36]	[42]	[48]	[54]	[60]	[66]
Change engine oil and engine oil filter.	X	X	X	X	X	X
Flush and replace engine coolant at 60 months, regardless of mileage.					X	
Check transfer case fluid level (4X4).					X	
Inspect brake linings.	X			X		
Replace engine air cleaner filter.					X	
Replace spark plugs.					X	
Inspect PCV valve, replace as necessary.*					X	
Inspect auto tension drive belt and replace if required.					X	

276 SCHEDULE "A"

Miles (Kilometers)	72,000 (115 000)	78,000 (125 000)	84,000 (134 000)	90,000 (144000)	96,000 (154 000)	100,000 (160 000)
[Months]	[72]	[78]	[84]	[90]	[96]	
Change engine oil and engine oil filter.	X	X	X	X	X	
Check transfer case fluid Level (4X4).				X		
Inspect brake linings.	X			X		
Replace engine air cleaner filter.				X		
Replace spark plugs.				X		
Inspect PCV valve, replace as necessary.*				X		
Inspect auto tension drive belt and replace if required.‡				X		
Drain and refill automatic transmission fluid and change main sump and cooler return filter (if equipped) (4.7L).						X

Miles (Kilometers) [Months]	102,000 (163 000) [102]	108,000 (173 000) [108]	114,000 (182 000) [114]	120,000 (192 000) [120]
Change engine oil and engine oil filter.	X	X	X	X
Drain and refill transfer case fluid (4X4).				X
Flush and replace engine coolant, if not done at 60 mos.	X			
Inspect brake linings.		X		
Replace engine air cleaner filter.				X
Replace spark plugs.				X
Inspect PCV valve, replace if necessary.*				X
Inspect auto tension drive belt and replace if required.‡				X

* This maintenance is recommended by the manufacture to the owner but is not required to maintain the emissions warranty.

‡ This maintenance is not required if previously replaced.

Inspection and service should also be performed anytime a malfunction is observed or suspected. Retain all receipts.

WARNING!
You can be badly injured working on or around a motor vehicle. Do only that service work for which you have the knowledge and the right equipment. If you have any doubt about your ability to perform a service job, take your vehicle to a competent mechanic.

IF YOU NEED CONSUMER ASSISTANCE

CONTENTS

■ Suggestions For Obtaining Service For Your Vehicle	280	■ Warranty Information	282
□ Prepare For The Appointment	280	■ Mopar® Parts	284
□ Prepare A List	280	■ Reporting Safety Defects	284
□ Be Reasonable With Requests	280	□ In Canada	284
■ If You Need Assistance	280	■ Publication Order Forms	284

SUGGESTIONS FOR OBTAINING SERVICE FOR YOUR VEHICLE**Prepare For The Appointment**

If you're having warranty work done, be sure to have the right papers with you. Take your warranty folder. All work to be performed may not be covered by the warranty, discuss additional charges with the service manager. Keep a maintenance log of your vehicle's service history. This can often provide a clue to the current problem.

Prepare A List

Make a written list of your vehicle's problems or the specific work you want done. If you've had an accident, or work done that is not on your maintenance log, let the service advisor know.

Be Reasonable With Requests

If you list a number of items, and you must have your vehicle by the end of the day, discuss the situation with the service advisor and list the items in order of priority. At many dealers you may obtain a rental vehicle at a

minimal daily charge. If you need a rental, it is advisable to make these arrangements when you call for an appointment.

IF YOU NEED ASSISTANCE

The manufacturer and its dealers are vitally interested in your satisfaction. We want you to be happy with our products and services.

Your selling dealer is best equipped and most anxious to provide prompt resolution for any warranty issue or related matter that you may experience. The manufacturer's dealers have the facilities, factory-trained technicians, special tools, and the latest information to assure your vehicle is fixed correctly and in a timely manner. The manufacturer has empowered its dealers to make warranty and repair decisions that ensure you are not inconvenienced. There is no need for you to wait for a decision from the manufacturer. If a special circumstance occurs that requires information from the manufacturer, we have asked the dealer's service management to make the contact on your behalf.

This is why you should always talk to your dealer's service manager first. Most matters can be resolved with this process.

- If for some reason you are still not satisfied, talk to the general manager or owner of the dealership. They want to know if you need assistance.
- If your dealership is unable to resolve the concern, you may contact the Manufacturer's Customer Center.

Any communication to the Manufacturer's Customer Center should include the following information:

- Owner's name and address
- Owner's telephone number (home and office)
- Dealership name
- Vehicle identification number
- Vehicle delivery date and mileage

DaimlerChrysler Motors Corporation Customer Center

P.O. Box 21-8004
Auburn Hills, MI 48321-8004
Phone: (800) 992-1997

DaimlerChrysler Canada Inc. Customer Center

P.O. Box 1621
Windsor, Ontario N9A 4H6
Phone —(800) 465-2001

In Mexico contact:

Av. Prolongacion Paseo de la Reforma, 1240
Sante Fe C.P. 05109
Mexico, D. F.
In Mexico (915) 729-1248 or 729-1240
Outside Mexico (525) 729-1248 or 729-1240

Customer Assistance For The Hearing Or Speech Impaired (TDD/TTY)

To assist customers who have hearing difficulties, the manufacturer has installed special TDD (Telecommunication Devices for the Deaf) equipment at its Customer Center. Any hearing or speech impaired customer who has access to a TDD or a conventional teletypewriter (TTY) in the United States can communicate with the manufacturer by dialing 1-800-380-CHRY.

Service Contract

You may have purchased a service contract for your vehicle to help protect you from the high cost of unexpected repairs after your manufacturer's new vehicle limited warranty expires. The manufacturer stands behind only the manufacturer's Service Contracts. If you purchased a manufacturer's Service Contract, you will receive Plan Provisions and an Owner Identification Card in the mail within three weeks of your vehicle delivery date. If you have any questions about your service contract, call the manufacturer's Service Contract National Customer Hotline at 1-800-521-9922.

The manufacturer will not stand behind any service contract that is not the manufacturer's Service Contract. It is not responsible for any service contract other than the manufacturer's Service Contract. If you purchased a service contract that is not a manufacturer's Service Contract, and you require service after your manufacturer's new vehicle limited warranty expires, please refer to your contract documents, and contact the person listed in those documents.

We appreciate that you have made a major investment when you purchased your new vehicle. Your dealer has also made a major investment in facilities, tools, and training to assure that you are absolutely delighted with your ownership experience. You'll be pleased with their sincere efforts to resolve any warranty issues or related concerns.

WARRANTY INFORMATION

See your manufacturer's Warranty Information Booklet for information on warranty coverage and transfer of warranty.

DESCRIPTION	1 Yr/ 12,000	2 Yr/ 24,000	3 Yr/ 36,000	3 Yr/ 50,000	3 Yr/ Unlmtd	5 Yr/ 100,000	7 Yr/ 70,000	8 Yr/ 80,000
Basic Limited Warranty Coverage	████████████████████							
Special Extended Warranty Coverage								
Powertrain Limited Warranty (\$100 deductible)	████████████████████			1st Owner & 2nd Owner with Paid Powertrain Transfer				
	████████████████████			2nd Owner If Powertrain Not Transferred and 3rd (And After) Owners				
Anti-Corrosion Perforation Limited Warranty: All Panels	████████████████████			████████████████████				
Outer Panels	████████████████████			████████████████████				
Federal Emission Warranty	████████████████████			████████████████████				
Federal Emission Warranty - Specified Components	████████████████████			████████████████████				
California Emission Warranty	████████████████████			████████████████████				
California Emission Warranty - Specified Components	████████████████████			████████████████████				

NOTE: Vehicles used as a police vehicle, taxi, limousine, postal delivery vehicle, ambulance or rental vehicle are covered only under the 3 year/36,000 mile Basic Limited Warranty.

MOPAR® PARTS

Mopar® fluids, lubricants, parts, and accessories are available from your dealer. They will help you keep your vehicle operating at its best.

REPORTING SAFETY DEFECTS

In the 50 United States and Washington D.C.: If you believe that your vehicle has a defect which could cause a crash or cause injury or death, you should immediately inform the National Highway Traffic Safety Administration (NHTSA) in addition to notifying the manufacturer.

If NHTSA receives similar complaints, it may open an investigation, and if it finds that a safety defect exists in a group of vehicles, it may order a recall and remedy campaign. However, NHTSA cannot become involved in individual problems between you, your dealer, and the manufacturer.

To contact NHTSA, you may either call the Auto Safety Hotline toll free at 1-800-424-9393 (or 366-0123 in Washington DC area) or write to: NHTSA, U.S. Dept. of

Transportation, Washington DC 20590. You can also obtain other information about motor vehicle safety from the Hotline.

In Canada:

If you believe that your vehicle has a safety defect, you should contact the Customer Service Department immediately. Canadian customers who wish to report a safety defect to the Canadian government should write to Transport Canada, Motor Vehicle Defect Investigations and Recalls, 2780 Sheffield Road, Ottawa, Ontario K1B 3V9.

PUBLICATION ORDER FORMS

To order the following manuals, you may use either the website or the phone numbers listed below. Visa, Mastercard, American Express, and Discover orders are accepted. If you prefer mailing your payment, please call for an order form.

NOTE: A street address is required when ordering manuals. (No P.O. Boxes).

- *Service Manuals.*

These comprehensive service manuals provide the information that students and professional technicians need in diagnosing/troubleshooting, problem solving, maintaining, servicing and repairing DaimlerChrysler Corporation vehicles. A complete working knowledge of the vehicle, system and/or components is written in straightforward language with illustrations, diagrams and charts.

- *Diagnostic Procedure Manuals.*

Filled with diagrams, charts and detailed illustrations, these practical manuals make it easy for students and technicians to find and fix problems on computer-controlled vehicle systems and features. They show exactly how to find and correct problems the first time, using step-by-step troubleshooting and driveability procedures, proven diagnostic tests and a complete list of all tools and equipment.

- *Owner's Manuals.*

These manuals have been prepared with the assistance of service and engineering specialists to acquaint you with specific Chrysler group vehicles. Included are starting, operating, emergency and maintenance procedures as well as specifications, capabilities and safety tips.

Call Toll Free at **1-800-890-4038 (U.S.)** or **1-800-387-1143 (Canada)**

Or

Visit us on the World Wide Web at:

www.techauthority.daimlerchrysler.com or
www.daimlerchrysler.ca/manuals

INDEX

- Adding Engine Coolant (Antifreeze) 239
Adding Fuel 186,208
Air Conditioner Maintenance 233
Air Conditioning 134
Air Conditioning, Operating Tips 135,137
Air Conditioning Refrigerant 234
Air Conditioning System 134
Air Pressure, Tires 176,182
Airbag 31,34,102
Airbag Light 38
Airbag On/Off Switch 34
Alarm 21,102
Alarm, Panic 19
Alignment and Balance 181
Alterations/Modifications, Vehicle 5
Antifreeze (Engine Coolant) 238,258
Anti-Lock Brake System 164,165
Anti-Lock Warning Light 102
Anti-Theft System 21,102
Appearance Care 249
Automatic Dimming Mirror 59
Automatic Transmission 144,146,245
 Adding Fluid 246
 Fluid and Filter Changes 247
 Fluid Level Check 245
 Fluid Type 247,260
 Gear Ranges 147
 Overdrive 148
 Shifting 146
 Special Additives 247
 Torque Converter 149
Axle Fluid 260
Axle Lubrication 248
Backfire, Engine 190
Ball Joints 235
Battery 232
 Charging 215
 Emergency Starting 215
 Gas Caution 215
 Keyless Transmitter Replacement 21
 Saving Feature 68
Belts, Drive 230
Belts, Seat 25
Body Mechanism Lubrication 235
B-Pillar Location 172

- Brake Fluid 260
- Brake System 164,243
 - Anti-Lock 164,165
 - Disc Brakes 243
 - Fluid Check 243
 - Hoses 244
 - Master Cylinder 243
 - Parking 163
 - Self-Adjusting Rear 243
 - Warning Light 101
- Brake/Transmission Interlock 146
- Break-In Recommendations, New Vehicle 52
- Bulb Replacement 255
- Bulbs, Light 254

- Camper 90
- Capacities, Fluid 258
- Capacity, Cargo Weight 191
- Caps, Filler
 - Fuel 186
 - Power Steering 234
- Car Washes 250
- Carbon Monoxide Warning 91,189

- Cargo 191
- Cargo Area Features 194
- Cargo Light 70,102
- Cassette Tape and Player Maintenance 131
- Cassette Tape Player 106,119,121
- Catalytic Converter 189,231
- CD Changer 113,117,122
- CD Player 110,114,116,124,126
- Cellular Phone 132
- Center High Mounted Stop Light 257
- Center Lap Belts 30
- Center Seat Storage Compartment 89
- Certification Label 191
- Changing A Flat Tire 209
- Charging 215
- Chart, Tire Sizing 169
- Child Restraint 38,39,52
- Child Restraint Tether Anchors 42,46
- Child Safety Locks 16
- Child Seat 45
- Climate Control 133
- Clock 105
- Club Cab 24,64

- Compact Disc Maintenance 132
Compact Disc Player 106,110
Compact Spare Tire 178
Compass 79
Compass Calibration 79,80
Computer, Trip/Travel 77
Console, Floor 88
Console, Overhead 76
Contract, Service 282
Converter, Catalytic 189
Coolant Pressure Cap 240
Cooling System 237,240
 Adding Coolant (Antifreeze) 239
 Coolant Capacity 258
 Coolant Level 240
 Disposal of Used Coolant 238
 Drain, Flush, and Refill 238
 Inspection 237
 Points to Remember 241
 Radiator Cap 240
 Selection of Coolant 238,258,259
 Temperature Gauge 99
Cruise Control 74
Cruise Light 104
Cup Holder 89
Customer Assistance 280
Daytime Running Lights 69
Dealer Service 225
Defroster, Rear Window 140
Defroster, Windshield 54,133,136
Delay Wipers 71
Diagnostic System, Onboard 223
Differential, Limited-Slip 162
Dimmer Switch, Headlight 100
Dipsticks
 Automatic Transmission 245
 Oil (Engine) 226
 Power Steering 234
Disabled Vehicle Towing 217
Disc Brakes 243
Disposal
 Used Coolant 238
Door Ajar 103
Door Locks 13,14
Door Opener, Garage 81

- Downshifting 151
- Drive Belts 230
- Drive Shaft Universal Joints 235
- Electrical Power Outlets 86
- Electronic Power Distribution Center 252
- Electronic Speed Control 74
- Emergency, In Case of
 - Freeing Vehicle When Stuck 167
 - Jacking 211
 - Jump Starting 215
 - Overheating 239
 - Towing 217
- Emission Control System Maintenance 262
- Emission Related Components 241
- Engine
 - Air Cleaner 231
 - Air Cleaner Filter 230
 - Block Heater 146
 - Break-In Recommendations 52
 - Compartment 221,222
 - Coolant 238,259
 - Cooling 237
 - Exhaust Gas Caution 53,189
 - Fails to Start 145
 - Flooded, Starting 145
 - Fuel Requirements 258
 - Oil 226,258,259
 - Oil Selection 258
 - Oil Synthetic 229
 - Overheating 239
 - Starting 144
 - Temperature Gauge 99
- Entry System, Illuminated 12
- Equipment Identification Plate 206
- Exhaust Gas Caution 53,237
- Exhaust System 53,236
- Exterior Lighting 68
- Filters
 - Air Cleaner 230
 - Engine Fuel 231
 - Engine Oil 229,259
 - Engine Oil Disposal 229
- Flashers
 - Hazard Warning 208

Turn Signal	99	Gauge	100
Flat Tire Stowage	215	Materials Added	186
Flooded Engine Starting	145	Octane Rating	259
Floor Console	88	Requirements	184,258
Fluid, Brake	260	System Hoses	241
Fluid Capacities	258	Tank Capacity	258
Fluid Level Checks		Fuses	253
Automatic Transmission	245	Garage Door Opener	81
Brake	243	Gasoline	184
Cooling System	237	Gasoline, Reformulated	184
Power Steering	234	Gauges	
Transfer Case	248	Coolant Temperature	99
Fog Lights	69,257	Fuel	100
Four Wheel Drive	151	Oil Pressure	100
Operation	151	Speedometer	100
Four-Way Hazard Flasher	208	Tachometer	99
Freeing A Stuck Vehicle	167	Voltmeter	99
Front Axle	248	Gear Ranges	100,147
Fuel	184	Glass Cleaning	251
Adding	186	GVWR	191
Filler Cap	186	Hazard Warning Flasher	208
Filter	231		
Gasoline	184		

- Headlights 255
 Dimmer Switch 100
 High Beam 71
 High Beam/Low Beam Select Switch 71
 Lights On Reminder 69
 Replacing 255
 Switch 68
 Heater 133
 Heater, Engine Block 146
 High Beam/Low Beam Select Switch 71
 Hitches
 Trailer Towing 198
 Holder, Cup 89
 Homelink Transmitter 81
 Hood Release 66
 Hoses 241
 Ignition 11
 Cables 230
 Key 9,11
 Lock 11
 Illuminated Entry 12
 Infant Restraint 38,39
 Inflation Pressure Tires 182
 Inside Rearview Mirror 58
 Instrument Cluster 97,99
 Instrument Panel and Controls 96
 Instrument Panel Lens Cleaning 252
 Interior Appearance Care 251
 Interior Lights 67
 Intermittent Wipers 71
 Introduction 4
 Jack Location 209
 Jack Operation 211
 Jump Starting 215
 Key, Replacement 10
 Key, Sentry 9
 Key-In Reminder 9
 Keyless Entry System 17
 Keys 9
 Knee Bolster 31
 Lane Change and Turn Signals 70,99
 Lap Belts 30

- Lap/Shoulder Belts 25
- LATCH
(Lower Anchors and Tether for Children) 42
- Lead Free Gasoline 184
- Lights 54,67
- Airbag 38,102
- Anti-Lock Warning 102
- Back-Up 256
- Brake Warning 101
- Bulb Replacement 254
- Cargo 70
- Center Mounted Stop 257
- Check Gauges 101
- Courtesy/Reading 76
- Cruise 104
- Daytime Running 69
- Fog 69,257
- Hazard Warning Flasher 208
- Headlights 68
- High Beam 71
- Instrument Cluster 97,99
- Intensity Control 68
- Interior 67,76
- License 257
- Lights On Reminder 69
- Low Fuel 102
- Low Washer Fluid 101
- Malfunction Indicator 103
- Park 256
- Passing 70
- Seat Belt Reminder 101
- Service 254,255
- Transmission Warning 102
- Turn Signal 70,256
- Upshift Indicator 99,151
- Warning (Instrument Cluster Description) 99
- Washer Fluid 101
- Limited-Slip Differential 162
- Load Limits 191
- Loading Vehicle 191,194
- Tires 172
- Locks 13
- Child Protection 16
- Door 13
- Ignition 11
- Keys 9

Power Door	14	Outside	59
Lower Anchors and Tether for Children (LATCH)	42	Rearview	58
Lubricating Oil	248	Modifications/Alterations, Vehicle	5
Lubrication, Body	235	Mopar Parts	225,284
Lug Nuts	213	Multi-Function Control Lever	70
Lumbar Support	63	New Vehicle Break-In Period	52
Maintenance	226	Occupant Restraints	24
Maintenance Free Battery	232	Odometer	103
Maintenance Procedures	226	Trip	103
Maintenance Schedule	263	Oil, Engine	226,259
Schedule "A"	274	Capacity	258
Schedule "B"	265	Change Interval	227
Malfunction Indicator Light	103,224	Dipstick	226
Manual, Service	284	Disposal	229
Manual Transmission	144,150,245	Filter	229,259
Fluid Level Check	245	Filter Disposal	229
Lubricant Selection	245,260	Identification Logo	228
Shift Speeds	151	Materials Added to	229
Mirrors	58	Pressure Gauge	100
Automatic Dimming	59	Recommendation	228,258
Electric Powered	60	Synthetic	229

- Viscosity 228,258
Onboard Diagnostic System 223,224
Opener, Garage Door 81
Outside Rearview Mirrors 59
Overdrive 148
Overhead Console 76,77
Overhead Travel Information Center 77
Overheating, Engine 104,239
Owner's Manual 284
- Panic Alarm 19
Parking Brake 163
Parking On Hill 163
Passenger Airbag On/Off Switch 34
Passing Light 70
Pickup Box 194
Placard, Tire and Loading Information 172
Positive Crankcase Valve 242
Power
 Brakes 243
 Distribution Center 252
 Door Locks 14
 Mirrors 60
- Outlet 86
Steering 166,234
Windows 22
- Power Steering Fluid 260
Pregnant Women and Seat Belts 30
Pressure Gauge, Oil 100
Programmable Electronic Features 82,85
Programming Transmitters 19,82,85
- Quad Cab 65
- Radial Ply Tires 178
Radiator Cap 240
Radio 106,114,119,124
Radio Operation 114,119,132
Rear Axle 248
Rear Window Defroster 140
Rearview Mirrors 58
Reclining Front Seats 62
Recommended Fluids, Lubricants and Genuine
 Parts 259
Recreational Towing 202
 Shifting into Transfer Case Neutral (N) 202

Shifting out of Transfer Case Neutral (N) . . .	204	Extender	31
Reformulated Gasoline	184	Front Seat	25
Refrigerant	234	Inspection	54
Release, Hood	66	Reminder	101
Remote Keyless Entry	17	Seats	61
Remote Sound System Controls	130	Adjustment	61
Replacement Tires	180	Bench	63
Reporting Safety Defects	284	Easy Entry	64
Restraints, Child	38,45	Lumbar Support	63
Restraints, Occupant	24	Reclining	62
Rocking Vehicle When Stuck	167	Security Alarm	21,102
Rotation, Tires	183,264	Selection of Coolant	259
Safety Checks Inside Vehicle	54	Selection of Oil	228
Safety Checks Outside Vehicle	54	Self-Adjusting Brakes	243
Safety Defects, Reporting	284	Sentry Key	9
Safety Information, Tire	167	Service and Maintenance	262,263
Safety Tips	53	Service Assistance	280
Schedule, Maintenance	263	Service Contract	282
Seat Belt Maintenance	252	Service Manuals	284
Seat Belts	24,25	Setting the Clock	105
And Pregnant Women	30	Shift Speeds, Manual Transmission	151
Child Restraint	38,52	Shifting	146
		Manual Transmission	150

- Transfer Case 151
- Transfer Case, Shifting into Transfer
 - Case Neutral (N) 202
- Transfer Case, Shifting out of Transfer
 - Case Neutral (N) 204
- Shoulder Belt Upper Anchorage 29
- Signals, Turn 70,99,256
- Sliding Rear Window 23
- Snow Chains 182
- Snow Plow 201
- Snow Tires 183
- Spare Tire 210
- Spark Plugs 230
- Specifications
 - Fuel 184
- Speed Control 74
- Speedometer 100
- Starting 144
 - Emergency (Jump Starting) 215
 - Engine Block Heater 146
- Steering
 - Column Controls 70
 - Column Lock 11
 - Linkage 235
 - Power 166,234
 - Wheel, Tilt 73
- Steering Wheel Mounted Sound System
 - Controls 130
- Storage Compartment, Center Seat 89
- Storage, Vehicle 254
- Stuck, Freeing 167
- Supplemental Tire Pressure Information 182
- Synthetic Engine Oil 229
- Tachometer 99
- Tailgate 90
- Taillights 256
- Tape Player 131
- Temperature Gauge, Engine Coolant 99
- Tether Anchor, Child Restraint 42
- Thermostat 241
- Tilt Steering Column 73
- Tire and Loading Information Placard 172,182
- Tire Identification Number (TIN) 171
- Tire Markings 167
- Tire Safety Information 167

Tires	54,175	Torque Converter Clutch	149
Air Pressure	175	Towing	
Alignment	181	Disabled Vehicle	217
Chains	182	Guide	199
Changing	209	Recreational	202
Compact Spare	178	Trailering	195
General Information	175	Weight	199
High Speed	177	Traction	206
Inflation Pressures	176	Trailer Towing	195
Jacking	211	Cooling System Tips	201
Load Capacity	172	Hitches	198
Radial	178	Minimum Requirements	199
Replacement	180	Trailer and Tongue Weight	197
Rotation	183,264	Wiring	200
Safety	167,175	Trailer Towing Guide	199
Sizes	169	Trailer Weight	199
Snow Tires	183	Transfer Case	248
Spare Tire	210	Fluid	260
Spinning	179	Transmission	146,150,245
Tread Wear Indicators	180	Automatic	144,146,245
Warnings	182	Filter	247
Wheel Nut Torque	213	Fluid	245,247,260
Tongue Weight/Trailer Weight	197	Manual	144,150,245

- Transmitter Battery Service 21
Transmitter, Garage Door Opener 81
Transmitter Programming 19
Tread Wear Indicators 180
Trip Computer 77
Trip Odometer 103
Turn Signals 70,99,255,256
- Universal Transmitter 81
Unleaded Gasoline 184
- Vehicle Identification Number 5
Vehicle Loading 172,191,194
Vehicle Modifications/Alterations 5
Vehicle Storage 254
Vented Quarter Window 24
Voltmeter 99
- Warning Lights (Instrument Cluster Description) . 99
Warnings and Cautions 5
Warranty Information 282
- Washers, Windshield 72
Washing Vehicle 250
Weight Load Carrying 191
Wheel Alignment and Balance 181
Wheel and Wheel Trim 250
Wheel Changing 209
Wheel Nut Torque 213
Wind Buffeting 24
Window Fogging 137
Windows 22
 Power 22
 Rear Sliding 23
 Vented Quarter 24
Windshield Defroster 54,133,136
Windshield Washers 71,72,236
 Fluid 71,236
Windshield Wiper Blades 235
Windshield Wipers 71
Wiper Blade Replacement 235
Wipers, Intermittent 71
Wrecker Towing 217