

**CHRYSLER**



**SEBRING**  
2009 OWNER'S MANUAL

## **VEHICLES SOLD IN CANADA**

With respect to any Vehicles Sold in Canada, the name Chrysler LLC shall be deemed to be deleted and the name Chrysler Canada Inc. used in substitution therefore.

### **DRIVING AND ALCOHOL**

Drunken driving is one of the most frequent causes of accidents.

Your driving ability can be seriously impaired with blood alcohol levels far below the legal minimum. If you are drinking, don't drive. Ride with a designated non-drinking driver, call a cab, a friend, or use public transportation.

#### **WARNING!**

**Driving after drinking can lead to an accident. Your perceptions are less sharp, your reflexes are slower, and your judgment is impaired when you have been drinking. Never drink and then drive.**

This manual illustrates and describes the operation of features and equipment that are either standard or optional on this vehicle. This manual may also include a description of features and equipment that are no longer available or were not ordered on this vehicle. Please disregard any features and equipment described in this manual that are not on this vehicle.

Chrysler LLC reserves the right to make changes in design and specifications, and/or make additions to or improvements to its products without imposing any obligation upon itself to install them on products previously manufactured.

Copyright © 2008 Chrysler LLC



# TABLE OF CONTENTS

SECTION		PAGE	
1	INTRODUCTION .....	3	1
2	THINGS TO KNOW BEFORE STARTING YOUR VEHICLE .....	9	2
3	UNDERSTANDING THE FEATURES OF YOUR VEHICLE .....	83	3
4	UNDERSTANDING YOUR INSTRUMENT PANEL .....	171	4
5	STARTING AND OPERATING .....	263	5
6	WHAT TO DO IN EMERGENCIES .....	349	6
7	MAINTAINING YOUR VEHICLE .....	367	7
8	MAINTENANCE SCHEDULES .....	423	8
9	IF YOU NEED CONSUMER ASSISTANCE .....	441	9
10	INDEX .....	451	10



---

# INTRODUCTION

## CONTENTS

---

■ Introduction . . . . .	4	■ Vehicle Identification Number . . . . .	6
■ How To Use This Manual . . . . .	4	■ Vehicle Modifications/Alterations . . . . .	7
■ Warnings And Cautions . . . . .	6		

### INTRODUCTION

This Owner's Manual has been prepared with the assistance of service and engineering specialists to acquaint you with the operation and maintenance of your vehicle. It is supplemented by a Warranty Information Booklet and various customer-oriented documents. You are urged to read these publications carefully. Following the instructions and recommendations in this manual will help assure safe and enjoyable operation of your vehicle.

**NOTE:** After you read the manual, it should be stored in the vehicle for convenient reference and remain with the vehicle when sold, so that the new owner will be aware of all safety warnings.



















































































When it comes to service, remember that your authorized dealer knows your vehicle best, has the factory-trained technicians and genuine Mopar® parts, and is interested in your satisfaction.

### HOW TO USE THIS MANUAL

Consult the Table of Contents to determine which section contains the information you desire.

The detailed Index at the back of this Owner's Manual contains a complete listing of all subjects.

Consult the following table for a description of the symbols that may be used on your vehicle or throughout this Owner's Manual:

 WATER IN FUEL	 REAR WINDOW WIPER	 WINDSHIELD WIPER INTERMITTENT	 EXTERIOR BULB FAILURE	 HIGH BEAM	 TURN SIGNALS	 UPPER AIR OUTLET	 HEATED SEAT LOW	 DOOR LOCK	 ADJUSTABLE PEDALS	 ELECTRONIC SPEED CONTROL	 ESP BAS ELECTRONIC STABILITY PROGRAM / BRAKE ASSIST SYSTEM
 FUEL	 REAR WINDOW INTERMITTENT WIPER	 WINDSHIELD WASHER	 MASTER LIGHTING SWITCH	 LOW BEAM	 KEY ACTIVATE (POWER OUTLET)	 UPPER AND LOWER AIR OUTLET	 HEATED SEAT HIGH	 WINDOW LIFT	 TIRE PRESSURE MONITOR	 HILL DESCENT CONTROL	 BRAKE SYSTEM WARNING PARKING BRAKE
 FUEL FILL SIDE	 REAR WINDOW WASHER	 WINDSHIELD WASHER FLUID LEVEL	 DOME LIGHT	 FRONT FOG LIGHT	 HOOD RELEASE	 LOWER AIR OUTLET	 RECIRCULATION	 CONVERTIBLE 4 WINDOW DOWN	 TRACTION CONTROL	 AWD!	 FAILURE OF ANTI-LOCK BRAKING SYSTEM
 ENGINE OIL	 REAR WINDOW DEFROST	 WINDSHIELD, ELECTRICALLY HEATED	 PARK LIGHTS	 REAR FOG LAMP	 LIFTGATE RELEASE AND LIFTGATE OPEN	 DEFROST AND LOWER AIR OUTLET	 VENTILATING FAN	 WINDOW LOCK	 ELECTRONIC THROTTLE CONTROL	 4WD!	 BRAKE SYSTEM WARNING BRAKE
 BATTERY CHARGING	 HEATED MIRROR	 WINDSHIELD DEFROST	 INSTRUMENT PANEL ILLUMINATION	 SEAT BELT	 SLIDING DOOR	 TRUNK / DECK RELEASE	 AIR CONDITIONING	 CHILD SEAT TETHER ANCHOR	 VOICE RECOGNITION BUTTON	 WARNING	 TOW / HAUL
 GLOW PLUG	 POWER STEERING FLUID	 WINDSHIELD WIPER AND WASHER	 SIDE AIRBAG	 AIRBAG	 SLIDING DOOR	 EMERGENCY RELEASE HANDLE	 LICHTER	 LOWER ANCHORS AND TETHER FOR CHILDREN (LATCH)	 DISCONNECT BUTTON	 HAZARD	 4 LOW
 MALFUNCTION INDICATOR LIGHT	 TRANS OIL TEMP	 ENGINE COOLANT TEMPERATURE	 SRS AIRBAG	 PASSENGER AIRBAG OFF	 DOOR AJAR	 CONVERTIBLE TOP DOWN	 CONVERTIBLE TOP UP	 HORN	 SEE OWNER'S MANUAL ISO		

## WARNINGS AND CAUTIONS

This Owner's Manual contains **WARNINGS** against operating procedures that could result in an accident or bodily injury. It also contains **CAUTIONS** against procedures that could result in damage to your vehicle. If you do not read this entire manual, you may miss important information. Observe all Warnings and Cautions.

## VEHICLE IDENTIFICATION NUMBER

The Vehicle Identification Number (VIN) is found on the left front corner of the instrument panel, visible through the windshield. This number also appears on the vehicle registration and title.

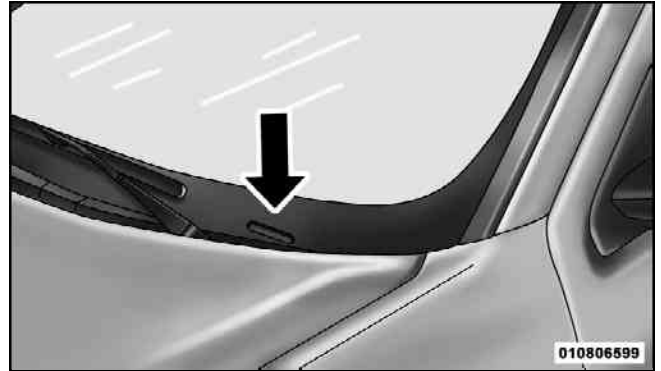

Vehicle Identification Number



## VEHICLE MODIFICATIONS/ALTERATIONS

### WARNING!

Any modifications or alterations to this vehicle could seriously affect its roadworthiness and safety and may lead to an accident resulting in serious injury or death.



# THINGS TO KNOW BEFORE STARTING YOUR VEHICLE

## CONTENTS

---

■ A Word About Your Keys . . . . .	12	■ Vehicle Security Alarm System — If Equipped . . .	19
□ Ignition Key Removal . . . . .	13	□ Rearming The System . . . . .	19
□ Key-In-Ignition Reminder . . . . .	15	□ To Arm The System . . . . .	19
□ Locking The Doors With The Key . . . . .	15	□ To Disarm The System . . . . .	20
■ Sentry Key® . . . . .	15	■ Illuminated Entry System — If Equipped . . . . .	21
□ Replacement Keys . . . . .	17	■ Remote Keyless Entry (RKE) — If Equipped . . . .	21
□ Sentry Key® Programming . . . . .	17	□ To Unlock The Doors . . . . .	22
□ General Information . . . . .	18	□ To Lock The Doors . . . . .	24
		□ To Unlatch The Trunk . . . . .	25

## 10 THINGS TO KNOW BEFORE STARTING YOUR VEHICLE

- Using The Express Down Windows Feature
  - If Equipped . . . . . 26
- Using The Panic Alarm . . . . . 26
- Programming Additional RKE Transmitters . . . 26
- Battery Replacement . . . . . 27
- General Information . . . . . 28
- Remote Start System — If Equipped . . . . . 29
  - How To Use Remote Start . . . . . 30
- Door Locks . . . . . 32
  - Manual Door Locks . . . . . 32
  - Power Door Locks . . . . . 33
  - Child Protection Door Lock System (Rear Doors) . . . . . 35
- Power Windows . . . . . 36
  - Power Window Switches . . . . . 36
  - Auto Window Down — If Equipped . . . . . 37
  - Auto Window Up — If Equipped . . . . . 38
  - Window Lockout Switch . . . . . 38
  - Wind Buffeting . . . . . 39
- Trunk Lock And Release . . . . . 39
- Trunk Safety Warning . . . . . 40
  - Trunk Internal Emergency Release . . . . . 41
- Occupant Restraints . . . . . 42
  - Lap/Shoulder Belts . . . . . 44
  - Lap/Shoulder Belt Untwisting Procedure . . . . . 49
  - Adjustable Upper Shoulder Belt Anchorage . . . 49

□ Rear Seat Belts . . . . .	50
□ Seat Belt Pretensioners . . . . .	50
□ Enhanced Seat Belt Reminder System (BeltAlert®) . . . . .	50
□ BeltAlert® Programming . . . . .	51
□ Automatic Locking Mode . . . . .	52
□ Seat Belts And Pregnant Women . . . . .	52
□ Seat Belt Extender . . . . .	52
□ Supplemental Restraint System (SRS) — Airbags . . . . .	53
□ SRS Components . . . . .	54
□ Front Seat Airbag Features . . . . .	55

**THINGS TO KNOW BEFORE STARTING YOUR VEHICLE 11**

□ Airbag Deployment Sensors And Controls . . . . .	61
□ Event Data Recorder (EDR) . . . . .	67
□ Child Restraints . . . . .	69
□ Transporting Pets . . . . .	80
■ Engine Break-In Recommendations . . . . .	80
■ Safety Tips . . . . .	81
□ Exhaust Gas . . . . .	81
□ Safety Checks You Should Make Inside The Vehicle . . . . .	81
□ Periodic Safety Checks You Should Make Outside The Vehicle . . . . .	82

### A WORD ABOUT YOUR KEYS

The authorized dealer that sold you your vehicle has the key code numbers for your vehicle locks. These numbers can be used to order duplicate keys from your authorized dealer. Ask your authorized dealer for these numbers and keep them in a safe place.

You can insert the double-sided keys into the locks with either side up.

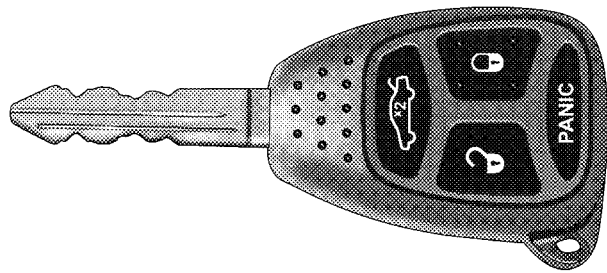

815afa1a

Vehicle Key

## Ignition Key Removal

### Automatic Transaxle

Place the shift lever in PARK. Turn the ignition switch to the ACC position, push the key and cylinder inward, rotate the key to the LOCK position, and remove the key.

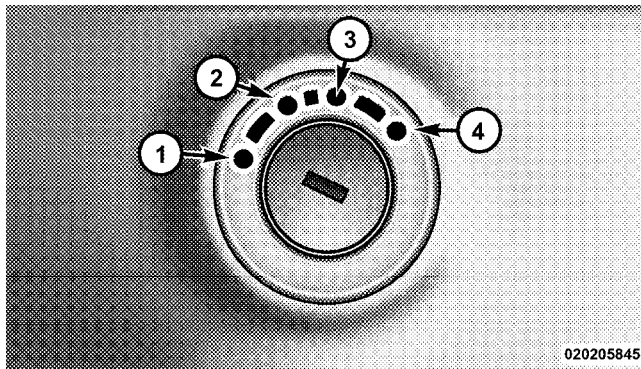

**Ignition Switch Positions**

- |                     |           |
|---------------------|-----------|
| 1 — LOCK            | 3 — ON    |
| 2 — ACC (ACCESSORY) | 4 — START |

### NOTE:

- If you try to remove the key before you place the shift lever in PARK, the key may become trapped temporarily in the ignition switch lock cylinder. If this occurs, rotate the key to the right slightly, then remove the key as described. If a malfunction occurs, the system will trap the key in the ignition switch lock cylinder to warn you that this safety feature is inoperable. The engine can be started and stopped, but the key cannot be removed until you obtain service.
- For vehicles not equipped with the Electronic Vehicle Information Center (EVIC), the power window switches, radio, hands-free system (if equipped), and power outlets will remain active for 45 seconds after the ignition switch is turned to the LOCK position. Opening either door will cancel this feature.
- For vehicles equipped with the Electronic Vehicle Information Center (EVIC), the power window

switches, radio, hands-free system (if equipped), and power outlets will remain active for up to 10 minutes after the ignition switch is turned to the LOCK position. Opening either door will cancel this feature. The time for this feature is programmable. For details, refer to “Key-Off Power Delay,” under “Personal Settings (Customer-Programmable Features)” under “Electronic Vehicle Information Center (EVIC)” in Section 4 of this manual.

### **WARNING!**

**NEVER** leave children alone in a vehicle. Leaving unattended children in a vehicle is dangerous for a number of reasons. A child or others could be seriously or fatally injured. Don't leave the keys in the ignition. A child could operate power windows, other controls, or move the vehicle.



**CAUTION!**

An unlocked car is an invitation to thieves. Always remove key from the ignition and lock all doors when leaving the vehicle unattended.

**Key-In-Ignition Reminder**

Opening the driver's door when the key is in the ignition, sounds a signal to remind you to remove the key.

**NOTE:**

- The Key-In-Ignition reminder only sounds when the ignition key is placed in the LOCK or ACC position.
- With either front door open, and the key in the ignition, both the power door locks and Remote Keyless Entry (RKE) transmitter will not function.

**Locking the Doors with the Key**

There is only one external door lock cylinder which is located in the driver's door only.

You can insert the key with either side up. To lock the door, turn the key rearward. To unlock the door, turn the key forward. For door lock lubrication, see "Body Lubrication" under "Maintenance Procedures" in Section 7 "Maintaining Your Vehicle" of this manual.

**SENTRY KEY®**

The Sentry Key® Immobilizer System prevents unauthorized vehicle operation by disabling the engine. The system does not need to be armed or activated. Operation is automatic, regardless of whether the vehicle is locked or unlocked.

The system uses ignition keys, which have an embedded electronic chip (transponder), to prevent unauthorized vehicle operation. Therefore, only keys that are programmed to the vehicle can be used to start and operate the vehicle. The system will shut the engine off in two seconds if someone uses an invalid key to start the engine.

**NOTE:** A key which has not been programmed is also considered an invalid key even if it is cut to fit the ignition switch lock cylinder for that vehicle.

During normal operation, after turning on the ignition switch, the Vehicle Security Light will turn on for three seconds for a bulb check. If the light remains on after the bulb check, it indicates that there is a problem with the electronics. In addition, if the light begins to flash after the bulb check, it indicates that someone used an invalid key to start the engine. Either of these conditions will result in the engine being shut off after two seconds.

If the Vehicle Security Light turns on during normal vehicle operation (vehicle running for longer than 10 seconds), it indicates that there is a fault in the electronics. Should this occur, have the vehicle serviced as soon as possible.

### CAUTION!

**Always remove the Sentry Key® from the vehicle and lock all doors when leaving the vehicle unattended.**

#### NOTE:

- The Sentry Key® Immobilizer System is not compatible with some aftermarket remote starting systems. Use of these systems may result in vehicle starting problems and loss of security protection.
- Exxon/Mobil Speed Pass™, additional Sentry Keys®, or any other transponder equipped components on the same keychain will **not** cause a key-related (transponder) fault unless the additional part is **physically held against the ignition key** being used when starting the vehicle. Cell phones, pagers, or other Radio Frequency (RF) electronics will not cause interference with this system.

All of the keys provided with your vehicle have been programmed to the vehicle electronics.

## Replacement Keys

**NOTE:** Only keys that have been programmed to the vehicle electronics can be used to start the vehicle. Once a Sentry Key<sup>®</sup> has been programmed to a vehicle, it cannot be programmed to any other vehicle.

At the time of purchase, the original owner is provided with a four-digit Personal Identification Number (PIN). The PIN is required for authorized dealer replacement of keys. Duplication of keys may be performed at an authorized dealer or by using the Customer Key Programming procedure. This procedure consists of programming a blank key to the vehicle electronics. A blank key is one which has never been programmed.

**NOTE:** When having the Sentry Key<sup>®</sup> Immobilizer System serviced, bring all vehicle keys with you to the authorized dealer.

## Sentry Key<sup>®</sup> Programming

You can program new keys to the system if you have two valid Sentry Keys<sup>®</sup> by performing the following procedure:

1. Cut the additional Sentry Key<sup>®</sup> Transponder blank(s) to match the ignition switch lock cylinder key code.
2. Insert the first valid key into the ignition switch. Turn the ignition switch to the ON position for at least three seconds, but no longer than 15 seconds. Then, turn the ignition switch to the LOCK position and remove the first key.
3. Insert the second valid key into the ignition switch. Turn the ignition switch to the ON position within 15 seconds. After ten seconds, a chime will sound. In

In addition, the Vehicle Security Light will begin to flash. Turn the ignition switch to the LOCK position and remove the second key.

4. Insert a blank Sentry Key® into the ignition switch. Turn the ignition switch to the ON position within 60 seconds. After 10 seconds, a single chime will sound. In addition, the Vehicle Security Light will stop flashing. To indicate that programming is complete, the indicator light will turn on again for three seconds and then turn off.

The new Sentry Key® is programmed. **The Remote Keyless Entry (RKE) transmitter will also be programmed during this procedure.**

Repeat this procedure to program up to eight keys. If you do not have a programmed Sentry Key® contact your authorized dealer for details.

**NOTE:** If a programmed key is lost, see your authorized dealer to have all remaining keys erased from the systems memory. This will prevent the lost key from starting your vehicle. The remaining keys must then be reprogrammed. All vehicle keys must be taken to your authorized dealer at the time of service to be reprogrammed.

### General Information

The Sentry Key® system complies with FCC rules part 15 and with RSS-210 of Industry Canada. Operation is subject to the following conditions:

- This device may not cause harmful interference.
- This device must accept any interference that may be received, including interference that may cause undesired operation.

## VEHICLE SECURITY ALARM SYSTEM — IF EQUIPPED

The Vehicle Security Alarm system monitors the doors and trunk for unauthorized entry and ignition switch for unauthorized operation.

If something triggers the alarm, the system will signal for about 18 minutes. For the first three minutes, the horn will sound intermittently and the headlights, park lights, taillights and the indicator light in the cluster will flash. Then the exterior lights will flash for another 15 minutes.

### Rearming The System:

If something triggers the alarm, and no action is taken to disarm it, the system will turn off the horn after three minutes, turn off all of the visual signals after 15 minutes, and then the system will rearm itself.

### To Arm The System:

1. Remove the keys from the ignition switch and get out of the vehicle.
2. Lock the door using either the power door lock switch (one door must be open) or the LOCK button on the Remote Keyless Entry (RKE) transmitter (doors can be open or closed), and close all doors.

**NOTE:** The system will not arm if you lock the doors with the manual door lock plungers.

3. The Vehicle Security Light in the instrument cluster will flash rapidly for 16 seconds. This shows that the system is arming. During this period, if a door is opened, the ignition switch is turned ON, or the power door locks are unlocked in any manner, the system will automatically disarm. After 16 seconds, the indicator light will flash slowly. This shows that the system is fully armed.

### NOTE:

- During the 16 second arming period, if a door is opened or the ignition switch is turned ON, the system will automatically disarm.
- Once armed, the Vehicle Security Alarm system disables the unlock switch on the driver door trim panel and passenger door trim panel, the trunk release button on the instrument panel, and the HomeLink®/Garage Door Opener (if equipped).

### To Disarm The System

Either press the UNLOCK button on the RKE transmitter or insert a valid Sentry Key® into the ignition lock cylinder and turn the key to the ON/START position.

### NOTE:

- The driver's door key cylinder and the trunk button on the RKE transmitter cannot arm or disarm the system.

- The system remains armed during trunk entry. Pressing the trunk button will not disarm the system. If someone enters the vehicle through the trunk and opens any door, the alarm will sound.

The Vehicle Security Alarm system is designed to protect your vehicle; however, you can create conditions where the system will give you a false alarm. If one of the previously described arming sequences has occurred, the system will arm regardless of whether you are in the vehicle or not. If you remain in the vehicle and open a door, the alarm will sound. If this occurs, disarm the system.

If the Vehicle Security Alarm system is armed and the battery becomes disconnected the system will remain armed when the battery is reconnected. The exterior lights will flash, and the horn will sound. If this occurs, disarm the system.

### **Tamper Alert**

If the alarm was triggered, but the warning signals have timed out, the park and taillights flash three times (instead of the normal twice), and the horn will chirp three times, when unlocking the vehicle with a valid RKE transmitter to alert the driver.

### **ILLUMINATED ENTRY SYSTEM — IF EQUIPPED**

The courtesy/reading lights will turn on when you use the Remote Keyless Entry (RKE) transmitter or open either door.

This feature also turns on the approach lighting (if so equipped). For details, refer to “Illumination Approach,” under “Personal Settings (Customer-Programmable Features)” under “Electronic Vehicle Information Center (EVIC)” in Section 4 of this manual.

The interior lights will fade to off after about 30 seconds or they will immediately fade to off once the ignition switch is turned ON.

### **NOTE:**

- The front courtesy overhead console and door courtesy lights do not turn on if the dimmer control is in the interior lights ON position (extreme top position).
- The Illuminated Entry system will not operate if the dimmer control is in the “defeat” position (extreme downward position).

### **REMOTE KEYLESS ENTRY (RKE) — IF EQUIPPED**

This system allows you to lock or unlock the doors, open the trunk, lower both front windows (if equipped), or activate the Panic Alarm from distances a maximum of 66 ft (20 m) using a Remote Keyless Entry (RKE) transmitter. The RKE transmitter does not need to be pointed at the vehicle to activate the system.

**NOTE:**

- The line of transmission must not be blocked with metal objects.
- Inserting the key into the ignition switch disables all buttons on the RKE transmitter.

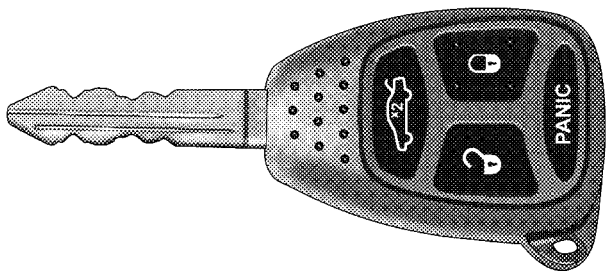

815afa1a

Vehicle Key

**To Unlock the Doors**

Press and release the UNLOCK button on the RKE transmitter once to unlock the driver's door, or twice to unlock all doors. The turn signal lights will flash to acknowledge the unlock signal. The Illuminated Entry system (if equipped) will also turn on.

**Remote Key Unlock, Driver Door/All Doors First Press**

This feature lets you program the system to unlock either the driver's door or all doors on the first press of the UNLOCK button on the RKE transmitter. To change the current setting, proceed as follows:

- For vehicles equipped with the Electronic Vehicle Information Center (EVIC), refer to "Remote Key Unlock," under "Personal Settings (Customer-Programmable Features)" under "Electronic Vehicle Information Center (EVIC)" in Section 4 of this manual for details.



- For vehicles not equipped with the EVIC, perform the following procedure:

1. Press and hold the LOCK button on a programmed RKE transmitter for at least four seconds, but not longer than 10 seconds. Then, press and hold the UNLOCK button while still holding the LOCK button.
2. Release both buttons at the same time.
3. Test the feature while outside of the vehicle, by pressing the LOCK/UNLOCK buttons on the RKE transmitter with the ignition in the LOCK position, and the key removed.
4. Repeat these steps if you want to return this feature to its previous setting.

**NOTE:** Pressing the LOCK button on the RKE transmitter while you are inside the vehicle will activate the Vehicle Security Alarm system. Opening a door with the

system activated will cause the alarm to sound. Press the UNLOCK button to deactivate the Vehicle Security Alarm system.

### Flash Lights With Lock

The feature will cause the turn signal lights to flash when the doors are locked or unlocked with the RKE transmitter. This feature can be turned on or turned off. To change the current setting, proceed as follows:

- For vehicles equipped with the Electronic Vehicle Information Center (EVIC), refer to “Flash Lights with Lock,” under “Personal Settings (Customer-Programmable Features)” under “Electronic Vehicle Information Center (EVIC)” in Section 4 of this manual for details.

- For vehicles not equipped with the EVIC, perform the following procedure:

1. Press and hold the UNLOCK button on a programmed RKE transmitter for at least four seconds, but not longer than 10 seconds. Then, press and hold the LOCK button while still holding the UNLOCK button.
2. Release both buttons at the same time.
3. Test the feature while outside of the vehicle, by pressing the LOCK/UNLOCK buttons on the RKE transmitter with the ignition in the LOCK position, and the key removed.
4. Repeat these steps if you want to return this feature to its previous setting.

**NOTE:** Pressing the LOCK button on the RKE transmitter while you are in the vehicle will activate the Vehicle Security Alarm system. Opening a door with the system

activated will cause the alarm to sound. Press the UNLOCK button to deactivate the Vehicle Security Alarm system.

### **Illuminated Approach — If Equipped**

This feature activates the headlights for up to 90 seconds when the doors are unlocked with the RKE transmitter. The time for this feature is programmable on vehicles equipped with EVIC. For details, refer to “Illuminated Approach,” under “Personal Settings (Customer-Programmable Features),” under “Electronic Vehicle Information Center (EVIC)” in Section 4 of this manual.

### **To Lock the Doors**

Press and release the LOCK button on the RKE transmitter to lock all doors. The turn signal lights will flash and the horn will chirp once to acknowledge the lock signal.

## Sound Horn with Lock

This feature will cause the horn to chirp when the doors are locked with the RKE transmitter. This feature can be turned on or off. To change the current setting, proceed as follows:

- For vehicles equipped with EVIC, refer to “Sound Horn with Lock,” under “Personal Settings (Customer-Programmable Features)” under “Electronic Vehicle Information Center (EVIC)” in Section 4 of this manual for details.
- For vehicles not equipped with the EVIC, perform the following steps:
  1. Press the LOCK button on a programmed RKE transmitter for at least four seconds, but not longer than 10 seconds. Then, press the PANIC button while still holding the LOCK button.

2. Release both buttons at the same time.
3. Test the feature while outside of the vehicle, by pressing the LOCK button on the RKE transmitter with the ignition in the LOCK position, and the key removed.
4. Repeat these steps if you want to return this feature to its previous setting.

**NOTE:** Pressing the LOCK button on the RKE transmitter while you are in the vehicle will activate the Vehicle Security Alarm. Opening a door with the alarm activated will cause the alarm to sound. Press the UNLOCK button to deactivate the Vehicle Security Alarm.

## To Unlatch the Trunk

Press the TRUNK button on the RKE transmitter two times to unlatch the trunk.

### **Using the Express Down Windows Feature — If Equipped**

This feature allows you to remotely lower both front door windows at the same time. To use this feature, press and release the UNLOCK button on the RKE transmitter and then immediately press and hold the UNLOCK button until the windows lower to the level desired or until they lower completely.

### **Using the Panic Alarm**

To turn the Panic Alarm feature on or off, press and hold the PANIC button on the RKE transmitter for at least one second and release. When the Panic Alarm is on, the headlights and park lights will flash, the horn will pulse on and off, and the Illuminated Entry system (if equipped) will turn on.

The Panic Alarm will stay on for three minutes unless you turn it off by pressing the PANIC button a second time or if the vehicle speed is 5 mph (8 km/h) or greater.

**NOTE:** You may need to be close to the vehicle when using the RKE transmitter to turn off the Panic Alarm due to the Radio Frequency (RF) noises emitted by the system.

### **Programming Additional RKE Transmitters**

Refer to “Sentry Key® Programming” under “Sentry Key®” in this section.

If you do not have a programmed RKE transmitter, contact your authorized dealer for details.

## Battery Replacement

The recommended replacement battery is CR2032.

**NOTE:** Perchlorate Material — special handling may apply. See [www.dtsc.ca.gov/hazardouswaste/perchlorate](http://www.dtsc.ca.gov/hazardouswaste/perchlorate).

1. With the RKE transmitter buttons facing down, use a flat blade to pry the two halves of the RKE transmitter apart. Make sure not to damage the seal during removal.

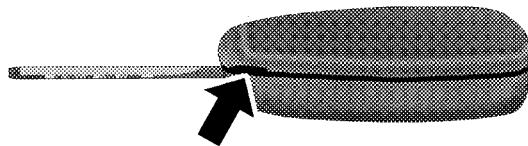

2

81182c72

### Separating RKE Transmitter Halves

2. Remove and replace the batteries. Avoid touching the new batteries with your fingers. Skin oils may cause battery deterioration. If you touch a battery, clean it with rubbing alcohol.
3. To assemble the RKE transmitter case, snap the two halves together.

### General Information

This device complies with part 15 of FCC rules and with RS-210 of Industry Canada. Operation is subject to the following conditions:

1. This device may not cause harmful interference.
2. This device must accept any interference that may be received including interference that may cause undesired operation.

**NOTE:** Changes or modifications not expressly approved by the party responsible for compliance could void the user's authority to operate the equipment.

If your RKE transmitter fails to operate from a normal distance, check for these two conditions.

1. Weak batteries in the RKE transmitter. The expected life of batteries is five years.
2. Closeness to a radio transmitter such as a radio station tower, airport transmitter, military base, and some mobile or CB radios.

## REMOTE START SYSTEM — IF EQUIPPED

Remote start conveniently starts the engine from outside the vehicle by using the Remote Keyless Entry (RKE) transmitter while maintaining security. The system has a targeted range of up to 328 ft (100 m). The vehicle must be locked, the deck lid and hood closed and the shift lever in PARK in order to start the engine using the Remote Start button on the RKE transmitter.

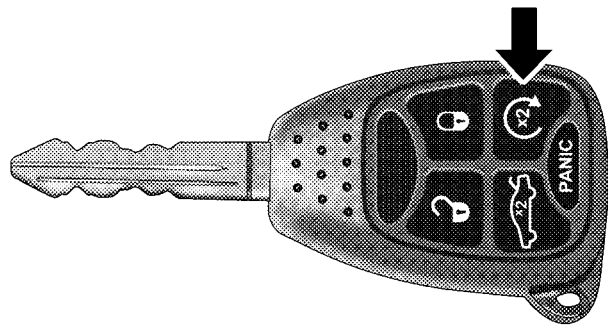

81db10a8

### Remote Start Button

**NOTE:** Remote start requires automatic transaxle equipped vehicles.

### How to Use Remote Start

All of the following conditions must be met before the engine will remote start:

- Shift lever in PARK
- Doors closed
- Hood closed
- Trunk closed
- Hazard switch off
- Brake switch inactive (brake pedal not pressed)
- Ignition key removed from ignition switch
- Battery at an acceptable charge level, and
- RKE PANIC button not pressed

### To Enter Remote Start Mode



Press and release the REMOTE START button on the RKE transmitter twice. The engine will start and the vehicle will remain in the Remote Start mode for a 15 minute cycle.

#### NOTE:

- If an engine fault is present the vehicle will start and then shut down 10 seconds later.
- For security, power window operation is disabled when the vehicle is in the Remote Start mode.
- The engine can be started two consecutive times (two 15 minute cycles) with the RKE transmitter. However, the ignition switch must be cycled to the ON position before you can repeat the start sequence for a third cycle.



**To Exit Remote Start Mode Without Driving the Vehicle**

Allow the engine to run for the entire 15 minute cycle.

**To Exit Remote Start Mode and Drive the Vehicle**

Before the end of the 15 minute cycle, press and release the UNLOCK button on the RKE transmitter to unlock the doors and disarm the Vehicle Security Alarm (if equipped). Then, within 15 minutes, insert the key into the ignition switch and turn the switch to the ON position. Then, insert the key into the ignition switch and turn the switch to the ON position, otherwise the engine will shut off at the end of 15 minute cycle.

**NOTE:** The ignition switch must be in the ON position in order to drive the vehicle.

**To Turn Off the Engine While in Remote Start Mode**

Press and release the REMOTE START button one time.

**NOTE:** To avoid inadvertent shut downs, the system will disable the one-time press of the Remote Start button for two seconds after receiving a valid remote start request.

## DOOR LOCKS

### Manual Door Locks

To lock each door, push the door lock plunger on each door trim panel downward. To unlock each door, pull the door lock plunger on each door trim panel upward.

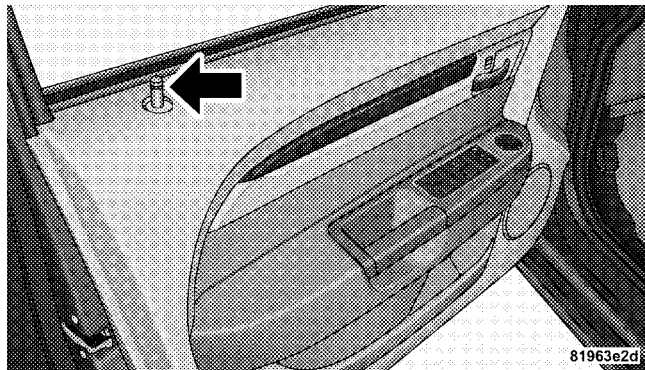

Manual Lock Plunger

### WARNING!

- For personal security and safety in the event of an accident, lock the vehicle doors as you drive as well as when you park and leave the vehicle.
- When leaving the vehicle always remove the key from the ignition lock, and lock your vehicle. Unsupervised use of vehicle equipment may cause severe personal injuries and death.
- Never leave children alone in a vehicle. Leaving unattended children in a vehicle is dangerous for a number of reasons. A child or others could be seriously or fatally injured. Don't leave the keys in the ignition. A child could operate power windows, other controls, or move the vehicle.

**CAUTION!**

An unlocked vehicle is an invitation to thieves. Always remove the key from the ignition and lock all of the doors when leaving the vehicle unattended.

**Power Door Locks**

A door lock switch is located on the driver and passenger door panel. Press this switch to lock or unlock the doors.

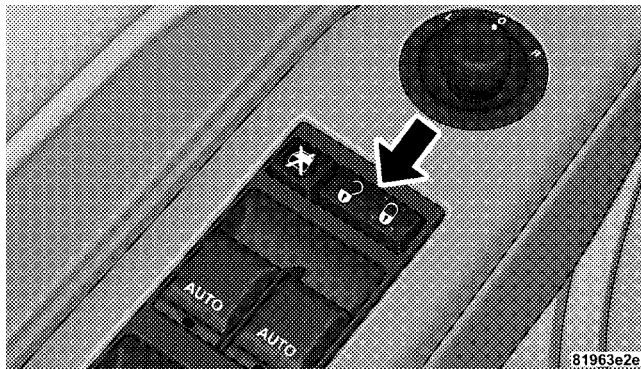

2

**Power Door Lock Switch****Automatic Door Locks — If Equipped**

When enabled, your door locks will lock automatically when the vehicle's speed exceeds 15 mph (24 km/h). The Automatic Door Locks feature can be enabled or disabled by your authorized dealer. See your authorized dealer for programming.

**Automatic Unlock Doors On Exit**

The doors will unlock automatically on vehicles with power door locks if:

1. The Automatic Unlock Doors on Exit feature is enabled.
2. The transmission was in gear and the vehicle speed returned to 0 mph (0 km/h).
3. The transmission is in NEUTRAL or PARK.
4. The driver door is opened.
5. The doors were not previously unlocked.
6. The vehicle speed is 0 mph (0 km/h).

**Automatic Unlock Doors On Exit Programming**

The Automatic Unlock Doors on Exit feature can be enabled or disabled as follows:

- For vehicles equipped with the Electronic Vehicle Information Center (EVIC), refer to “Personal Settings (Customer-Programmable Features)” under “Electronic Vehicle Information Center (EVIC)” in Section 4 of this manual for details.
- For vehicles not equipped with the EVIC, perform the following procedure:
  1. Close all doors and place the key in the ignition.
  2. Cycle the ignition switch between LOCK and ON and then back to LOCK four times, ending up in the LOCK position.

3. Depress the power door unlock switch to unlock the doors.
4. A single chime will indicate the completion of the programming.
5. Repeat these steps if you want to return this feature to its previous setting.

**NOTE:** Use the Automatic Unlock Doors on Exit feature in accordance with local laws.

### **Child Protection Door Lock System (Rear Doors)**

The Child Protection Door Lock (Rear Doors) are located inside the rear edge of the door. Insert the tip of the ignition key or similar flat-bladed object into the lock and rotate approximately one-quarter turn to the lock or unlock position (as indicated by the stamped icons).

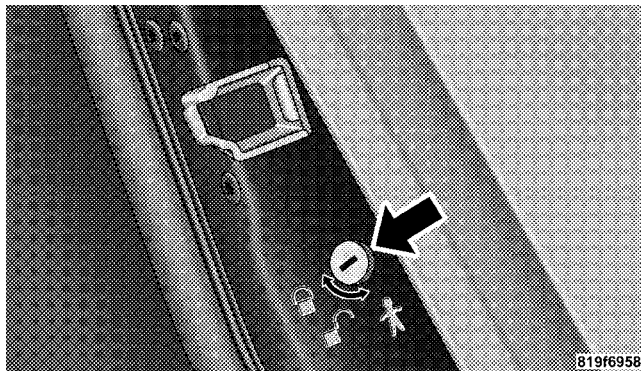

**Child Lock Control**

**WARNING!**

Avoid trapping anyone in a vehicle in a collision. Remember that the rear doors can only be opened from the outside when the child protection locks are engaged.

**NOTE:** For emergency exit with the system engaged, move the lock plunger up (UNLOCKED position), roll down the window, and open the door with the outside door handle.

**POWER WINDOWS****Power Window Switches**

The control on the driver's door has up/down switches that give you fingertip control of all four power windows.

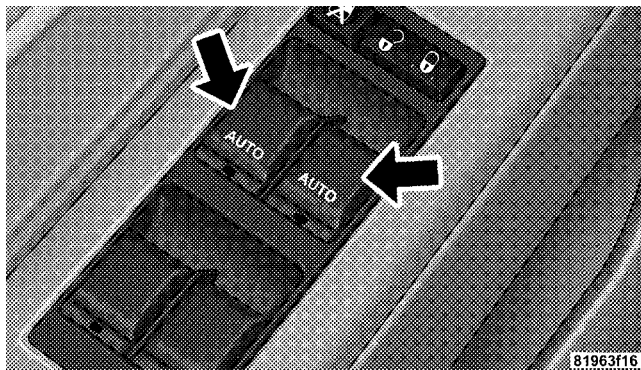
**AUTO Power Window Switch**

There is a single window control on the front and rear passenger's door trim panel, which operates the front and rear passenger door windows. The window controls will operate when the ignition switch is turned to the ON or ACC position, and when the accessory delay feature is active.

**WARNING!**

Never leave children in a vehicle, with the keys in the ignition switch. Occupants, particularly unattended children, can become entrapped by the windows while operating the power window switches. Such entrapment may result in serious injury or death.

**Auto Window Down — If Equipped**

The front window controls on the driver and passenger door trim panels have an Auto Down feature. These switches are labeled AUTO to indicate this capability. Push the window switch past the first detent, release, and the window will go down automatically.

To open the window part way, push the window switch to the first detent and release it when you want the window to stop.

To cancel the Auto Down movement, operate the switch either in the up or down direction and release the switch.

For vehicles not equipped with the Electronic Vehicle Information Center (EVIC), the power window switches will remain active for 45 seconds after the ignition switch is turned to the LOCK position. Opening either door will cancel this feature.

For vehicles equipped with EVIC, the power window switches will remain active for up to 10 minutes after the ignition switch is turned off. Opening either door will cancel this feature. The time for this feature is programmable. For details, refer to “Key-Off Power Delay,” under “Personal Settings (Customer-Programmable Features)” under “Electronic Vehicle Information Center (EVIC)” in Section 4 of this manual.

### Auto Window Up — If Equipped

Lift the window switch to the second detent, release, and the window will go up automatically.

To cancel the Auto Up movement, operate the switch either in the up or down direction and release the switch.

To close the window part way, lift the window switch to the first detent and release it when you want the window to stop.

#### NOTE: ANTI-PINCH PROTECTION

- If the window runs into any obstacle during auto-closure, it will reverse direction and then stop. Remove the obstacle and use the window switch again to close the window.
- Any impact due to rough road conditions may trigger the auto reverse function unexpectedly during auto-closure. If this happens, pull the switch lightly to the first detent and hold to close window manually.

### WARNING!

**When the window is almost closed, there is no anti-pinch protection. To avoid personal injury, be sure to clear your arms, hands, fingers and all objects from the window path before closing.**

#### Reset Auto Up

Anytime the vehicle battery goes dead, the Auto Up function will be disabled. To reactivate the Auto Up feature, pull the window switch up to close the window completely and continue to hold the switch up for an additional two seconds after the window is closed.

#### Window Lockout Switch

The window lockout switch on the driver's door allows you to disable the window control on the other doors. To disable the window controls on the other doors, press the window LOCK button. To enable the window controls, press the window control button again.



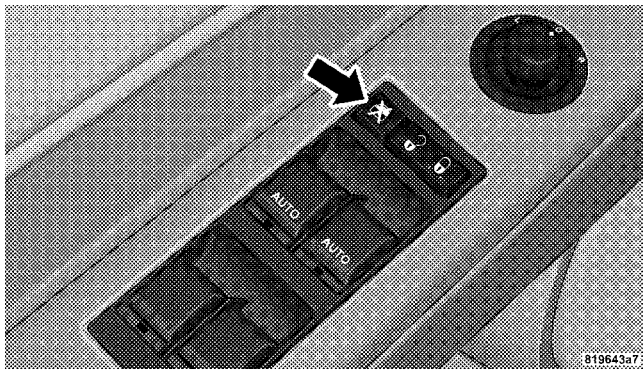

Window Lockout Switch

### Wind Buffeting

Wind buffeting can be described as the perception of pressure on the ears or a helicopter type sound in the ears. Your vehicle may exhibit wind buffeting with the windows down, or the sunroof (if equipped) in certain

open or partially open positions. This is a normal occurrence and can be minimized. If the buffeting occurs with the rear windows open, then open the front and rear windows together to minimize the buffeting. If the buffeting occurs with the sunroof open, then adjust the sunroof opening to minimize the buffeting.

2

### TRUNK LOCK AND RELEASE

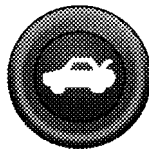

81ac2fd7

Use the Remote Keyless Entry (RKE) Transmitter to open the trunk from outside the vehicle. From inside the vehicle the trunk lid can be released by pressing the TRUNK RELEASE button located next to the steering wheel on the instrument panel.

**NOTE:** The shift lever must be in PARK for this switch to operate.

To unlatch the trunk lid from outside the vehicle, press and release the TRUNK button on the RKE transmitter two times.

With the ignition ON, the word “deck” will display in place of the odometer display indicating that the trunk is open. The odometer display will reappear once the trunk is closed or if the trip button is depressed.

With the key in the lock position or with the key out, the word “deck” will display until the trunk is closed.

On EVIC-equipped vehicles, the words “Trunk Ajar” will display.

## TRUNK SAFETY WARNING

### WARNING!

**Do not allow children to have access to the trunk, either by climbing into the trunk from outside, or through the inside of the vehicle. Always close the trunk lid when your vehicle is unattended. Once in the trunk, young children may not be able to escape, even if they entered through the rear seat. If trapped in the trunk, children can die from suffocation or heat stroke.**

### Trunk Internal Emergency Release

As a security measure, a Trunk Internal Emergency Release lever is built into the trunk latching mechanism. In the event of an individual being locked inside the trunk, the trunk can be simply opened by pulling on the glow-in-the-dark handle attached to the trunk latching mechanism.

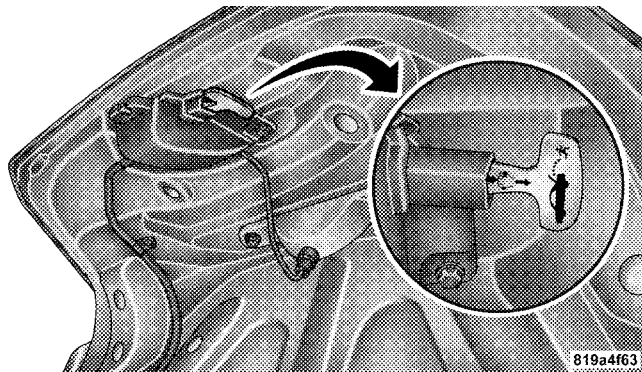

Trunk Internal Emergency Release

## OCCUPANT RESTRAINTS

Some of the most important safety features in your vehicle are the restraint systems. The following safety features are standard on all vehicles:

- Three-point lap and shoulder belts for all seating positions
- Pretensioning and load-limiting retractors for the front seat belts
- Advanced multistage driver and new active-vent front passenger airbags
- New active-vent front passenger airbags
- Knee bolsters for front seat occupants
- An energy absorbing steering column and steering wheel

- Supplemental Side Airbag Inflatable Curtains (SABIC) that span the front and second rows for sedans (if equipped)
- Supplemental front seat-mounted thorax side airbags
- Front seat belt retractors incorporate pretensioners to enhance occupant protection by managing occupant energy during an impact event
- All seat belt systems (except the driver's) include Automatic Locking Retractors (ALRs), which lock the seat belt webbing into position by extending the belt all the way out and then adjusting the belt to the desired length to restrain a child seat or secure a large item in a seat

If you will be carrying children too small for adult-size seat belts, your seat belts or the LATCH feature also can be used to hold infant and child restraint systems. For

more information on LATCH, see Lower Anchors and Tether for CHildren (LATCH) in this section.

**NOTE:** The front airbags have a multistage inflator design. This allows the airbag to have different rates of inflation that are based on collision severity.

**Please pay close attention to the information in this section. It tells you how to use your restraint system properly to keep you and your passengers as safe as possible.**

### **WARNING!**

**In a collision, you and your passengers can suffer much greater injuries if you are not properly buckled up. You can strike the interior of your vehicle or other passengers, or you can be thrown out of the vehicle. Always be sure you and others in your vehicle are buckled up properly.**

Buckle up even though you are an excellent driver, even on short trips. Someone on the road may be a poor driver and cause a collision that includes you. This can happen far away from home or on your own street.

Research has shown that seat belts save lives, and they can reduce the seriousness of injuries in a collision. Some of the worst injuries happen when people are thrown from the vehicle. Seat belts reduce the possibility of ejection and the risk of injury caused by striking the inside of the vehicle. **Everyone in a motor vehicle should be belted at all times.**

### Lap/Shoulder Belts

All seating positions in your vehicle are equipped with lap/shoulder belts.

The belt webbing retractor will lock only during very sudden stops or collisions. This feature allows the shoulder part of the belt to move freely with you under normal conditions. But in a collision, the belt will lock and reduce your risk of striking the inside of the vehicle or being thrown out.

#### **WARNING!**

- Be sure everyone in your vehicle is in a seat and using a seat belt properly.
- It is extremely dangerous to ride in a cargo area, inside or outside of a vehicle. In a collision, people riding in these areas are more likely to be seriously injured or killed.

*(Continued)*

#### **WARNING! (Continued)**

- Wearing a seat belt incorrectly is dangerous. Seat belts are designed to go around the large bones of your body. These are the strongest parts of your body and can take the forces of a collision the best.
- Wearing your belt in the wrong place could make your injuries in a collision much worse. You might suffer internal injuries, or you could even slide out of part of the belt. Follow these instructions to wear your seat belt safely and to keep your passengers safe, too.
- Two people should never be belted into a single seat belt. People belted together can crash into one another in an accident, hurting one another badly. Never use a lap/shoulder belt or lap belt for more than one person, no matter what their size.

## Lap/Shoulder Belt Operating Instructions

1. Enter the vehicle and close the door. Sit back and adjust the seat.
2. The seat belt latch plate is above the back of the front seat, next to your arm. Grasp the latch plate and pull out the belt. Slide the latch plate up the webbing as far as necessary to allow the belt to go around your lap.



2

### Pulling Out the Latch Plate

3. When the belt is long enough to fit, insert the latch plate into the buckle until you hear a "click."

**WARNING!**

- A belt that is buckled into the wrong buckle will not protect you properly. The lap portion could ride too high on your body, possibly causing internal injuries. Always buckle your belt into the buckle nearest you.
- A belt that is too loose will not protect you as well. In a sudden stop, you could move too far forward, increasing the possibility of injury. Wear your seat belt snugly.

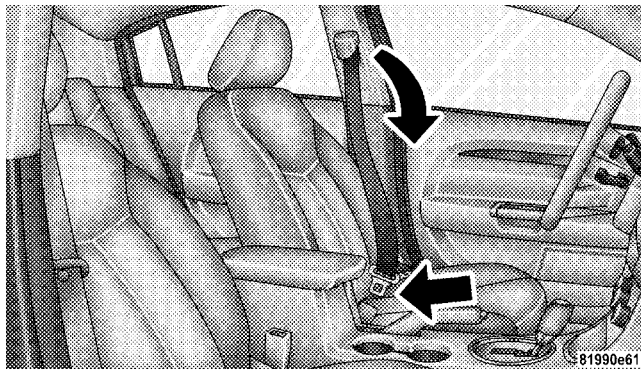

Inserting Latch Plate into Buckle



**WARNING!**

- A belt that is worn under your arm is very dangerous. Your body could strike the inside surfaces of the vehicle in a collision, increasing head and neck injury. A belt worn under the arm can cause internal injuries. Ribs aren't as strong as shoulder bones. Wear the belt over your shoulder so that your strongest bones will take the force in a collision.
- A shoulder belt placed behind you will not protect you from injury during a collision. You are more likely to hit your head in a collision if you do not wear your shoulder belt. The lap and shoulder belt are meant to be used together.

4. Position the lap belt across your thighs, below your abdomen. To remove slack in the lap belt portion, pull up on the shoulder belt. To loosen the lap belt if it is too tight, tilt the latch plate and pull on the lap belt. A snug belt reduces the risk of sliding under the belt in a collision.

2

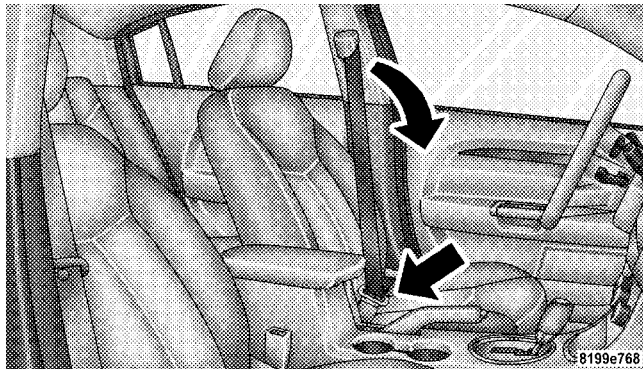

Positioning the Lap Belt

**WARNING!**

- A lap belt worn too high can increase the risk of internal injury in a collision. The belt forces won't be at the strong hip and pelvic bones, but across your abdomen. Always wear the lap belt as low as possible and keep it snug.
- A twisted belt can't do its job as well. In a collision, it could even cut into you. Be sure the belt is straight. If you can't straighten a belt in your vehicle, take it to your authorized dealer and have it fixed.

5. Position the shoulder belt on your chest so that it is comfortable and not resting on your neck. The retractor will withdraw any slack in the belt.

6. To release the belt, push the red button on the buckle. The belt will automatically retract to its stowed position. If necessary, slide the latch plate down the webbing to allow the belt to retract fully.

**WARNING!**

A frayed or torn belt could rip apart in a collision and leave you with no protection. Inspect the belt system periodically, checking for cuts, frays, or loose parts. Damaged parts must be replaced immediately. Do not disassemble or modify the system. Seat belt assemblies must be replaced after a collision if they have been damaged (i.e., bent retractor, torn webbing, etc.).

### Lap/Shoulder Belt Untwisting Procedure

Use the following procedure to untwist a twisted lap/shoulder belt.

1. Position the latch plate as close as possible to the anchor point.
2. At about 6 to 12 in (15 to 30 cm) above the latch plate, grasp and twist the belt webbing 180 degrees to create a fold that begins immediately above the latch plate.
3. Slide the latch plate upward over the folded webbing. The folded webbing must enter the slot at the top of the latch plate.
4. Continue to slide the latch plate up until it clears the folded webbing.

### Adjustable Upper Shoulder Belt Anchorage

In the front seat, the shoulder belt can be adjusted upward or downward to position the belt away from your neck. Push anchorage button to release the anchorage, and move it up or down to the position that serves you best.

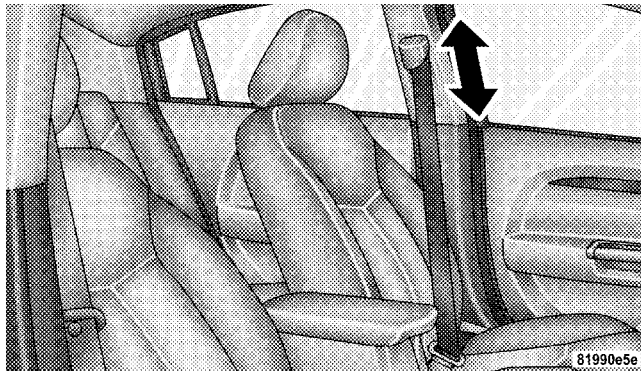

Adjustable Anchorage

As a guide, if you are shorter than average, you will prefer a lower position, and if you are taller than average, you'll prefer a higher position. When you release the anchorage, try to move it up or down to make sure that it is locked in position.

### **Rear Seat Belts**

The shoulder belt anchorages of the rear three point belts are nonadjustable for outboard and center rear passengers on sedans. The center belt is mounted to the rear shelf panel and exits through a bezel in the panel.

### **Seat Belt Pretensioners**

The seat belts for both front seating positions are equipped with pretensioning devices that are designed to remove slack from the seat belt in the event of a collision. These devices improve the performance of the seat belt by assuring that the belt is tight about the occupant early in a collision. Pretensioners work for all size occupants, including those in child restraints.

In addition, the front passenger seat belt includes a two-stage load-limiting feature to enhance occupant protection for the same reason.

**NOTE:** These devices are not a substitute for proper seat belt placement by the occupant. The seat belt still must be worn snugly and positioned properly.

The pretensioners are triggered by the Occupant Restraint Controller (ORC). Like the front airbags, the pretensioners are single use items. After a collision that is severe enough to deploy the airbags and pretensioners, both must be replaced.

### **Enhanced Seat Belt Reminder System (BeltAlert®)**

If the occupied driver's seat belt has not been buckled within 60 seconds of starting the vehicle and if the vehicle speed is greater than 5 mph (8 km/h), The Enhanced Warning System (BeltAlert®) will alert the driver to buckle their seat belt. The driver should also instruct all other occupants to buckle their seat belts. Once the

warning is triggered, BeltAlert® will continue to chime and flash the Seat Belt Warning Light for 96 seconds or until the driver's seat belt is buckled.

BeltAlert® will be reactivated if the driver's seat belt is unbuckled for more than 10 seconds and the vehicle speed is greater than 5 mph (8 km/h).

### **BeltAlert® Programming**

BeltAlert® can be enabled or disabled by your authorized dealer or by following these steps:

#### **NOTE:**

- The following steps must occur within the first 60 seconds of the ignition switch being turned to the ON or START position.
- Chrysler LLC does not recommend deactivating BeltAlert®.

1. Turn the ignition switch to the LOCK position and buckle the driver's seat belt.

2. Turn the ignition switch to the ON position and wait for the Seat Belt Warning Light to turn off.

3. Within 60 seconds of turning the ignition switch to the ON position, unbuckle and then re-buckle the driver's seat belt at least three times within 10 seconds, ending with the seat belt buckled.

**NOTE:** Watch for the Seat Belt Warning Light to turn on while unbuckling and off while re-buckling the seat belt. It may be necessary to retract the seat belt partially each time when unbuckling.

4. Turn the ignition switch to the LOCK position. A single chime will sound to signify that you have successfully completed the programming.

BeltAlert® can be reactivated by repeating this procedure.

**NOTE:** Although BeltAlert® has been deactivated, the Seat Belt Warning Light will continue to illuminate while the driver's seat belt remains unbuckled.

## **Automatic Locking Mode**

In this mode, the shoulder belt is automatically pre-locked. However, the belt will still retract to remove any slack in the shoulder belt. The Automatic Locking mode is available on all passenger-seating positions. Use the Automatic Locking mode anytime a child safety seat is installed in a passenger seating position. Children 12 years old and younger should be properly restrained in the rear seat whenever possible.

### **How to Engage the Automatic Locking Mode**

1. Buckle the combination lap/shoulder belt.
2. Grasp the shoulder portion and pull downward until the entire belt is extracted.
3. Allow the belt to retract. As the belt retracts, you will hear a clicking sound. This indicates the safety belt is now in the Automatic Locking mode.

### **How to Disengage the Automatic Locking Mode**

Unbuckle the combination lap/shoulder belt and allow it to retract completely to disengage the Automatic Locking mode and activate the Vehicle Sensitive (Emergency) Locking mode.

### **Seat Belts and Pregnant Women**

We recommend that pregnant women use the seat belts throughout their pregnancy. Keeping the mother safe is the best way to keep the baby safe.

Pregnant women should wear the lap part of the belt across the thighs and as snug across the hips as possible. Keep the belt low so that it does not come across the abdomen. That way the strong bones of the hips will take the force if there is a collision.

### **Seat Belt Extender**

If a seat belt is too short, even when fully extended and when the adjustable upper shoulder belt anchorage (if equipped) is in its lowest position, your authorized

dealer can provide you with a seat belt extender. This extender should be used only if the existing belt is not long enough. When it is not required, remove the extender, and stow it.

### WARNING!

Using a seat belt extender when not needed can increase the risk of injury in a collision. Only use when the lap belt is not long enough when it is worn low and snug, and in the recommended seating positions. Remove and store the extender when not needed.

### Supplemental Restraint System (SRS) — Airbags

This vehicle has airbags for both the driver and front passenger as a supplement to the seat belt restraint systems. The driver's front airbag is mounted in the center of the steering wheel. The passenger's front airbag

is mounted in the instrument panel, above the glove compartment. The words SRS AIRBAG are embossed on the airbag covers.

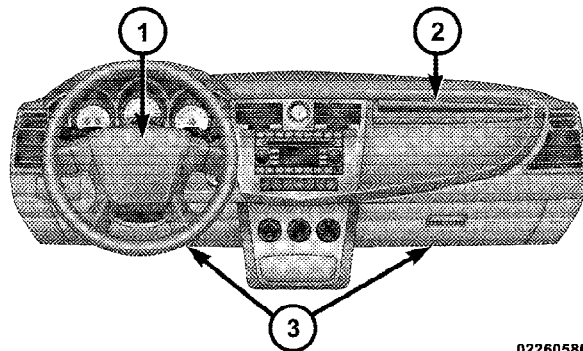

Front Airbag Components

- 1 — Driver Airbag
- 2 — Passenger Airbag
- 3 — Knee Bolster

022605860

**NOTE:** The front airbags are certified to the Federal regulations that allow less forceful deployment.

The front airbags have a multistage inflator design. This may allow the airbag to have different rates of inflation that are based on collision severity and occupant size.

This vehicle may also be equipped with side airbags to protect the driver, front, and rear passengers sitting next to a window. If the vehicle is equipped with side airbags, they are located above the side windows. The trim covering the side airbags is labeled SRS AIRBAG.

**NOTE:** Airbag covers may not be obvious in the interior trim; but they will open to allow airbag deployment.

### **SRS Components**

The airbag system consists of the following:

- Occupant Restraint Controller (ORC)
- Airbag Warning Light

- Driver Airbag
- Front Passenger Airbag
- Supplemental Side Airbag Inflatable Curtains (SABIC) (if equipped)
- Front Seat-Mounted Thorax Side Airbags
- Front Impact Sensors
- Side Impact Sensors (if equipped)
- Steering Wheel and Column
- Instrument Panel
- Seat Belt Warning Light
- Knee Impact Bolster
- Front Seat Belt Pretensioners



### **Front Seat Airbag Features**

The front airbag system has dual-stage driver and front passenger airbags. This system provides output appropriate to the level of crash severity as determined by the Occupant Restraint Controller (ORC) and the impact sensors at the front of the car.

The first stage inflator is triggered immediately during an impact that requires airbag deployment. The timing of the second stage determines whether the output force is low, medium, or high. If a low output is sufficient to meet the need, the second stage is expended later in the crash event.

### **Driver Airbag Special Features**

Driver airbag deployment and force level is controlled by the driver's seat position as well as impact severity. Use of special inflators, result in a very compact driver's side airbag.

In addition to the small size, the inflating gasses exit through strategically placed vents, which direct the gas away from the occupant.

### **Front Passenger Airbag Special Features**

A new active-venting front passenger airbag is designed to reduce the risk of occupants who may be out of position by the use of active vents positioned on each side of the airbag.

### Supplemental Front Seat-Mounted Thorax Side Airbags

Front seat-mounted thorax side airbags provide enhanced protection and work together with supplemental Side Airbag Inflatable Curtains (SABIC) to help protect an occupant during a side impact. The seat-mounted side airbag is marked with an airbag label sewn into the outboard side of the seat.

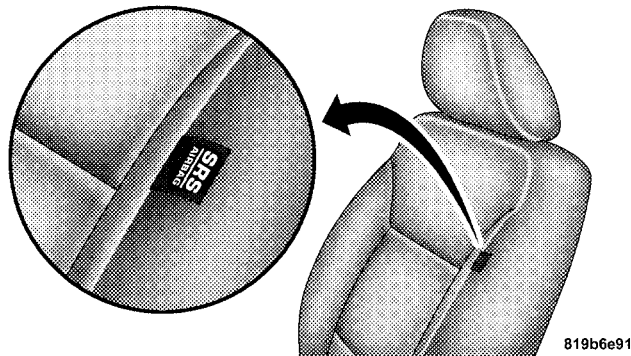

819b6e91

#### Seat-Mounted Side Airbag Label

When the bag deploys, it opens the seam between the front and side of the seat's trim cover. Each bag deploys independently, that is a left side impact deploys the left bag only and a right-side impact deploys only the right bag.

### Supplemental Side Airbag Inflatable Curtain (SABIC) — If Equipped

Supplemental Side Airbag Inflatable Curtain (SABIC) Airbags offer side-impact protection to front and rear seat outboard occupants in addition to that provided by the body structure. Each airbag features inflated chambers place adjacent to the head of each outboard occupant that reduce the potential for side-impact head injuries. The curtains deploy downward, covering both windows on the impact side.

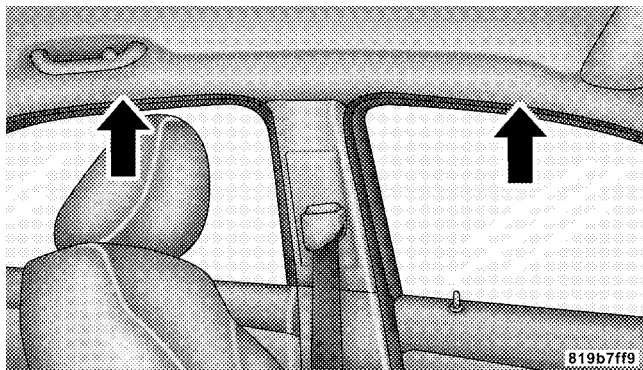

2

#### Side Airbag Inflatable Curtains (SABIC) Location

**NOTE:** Airbag covers may not be obvious in the interior trim; but they will open to allow airbag deployment.

The system includes sensors adjacent to both front and rear seat occupants that are calibrated to deploy the side bags during an impact severe enough to require airbag occupant protection.

**WARNING!**

- Do not put anything on or around the airbag covers or attempt to open them manually. You may damage the airbags and you could be injured because the airbags are not there to protect you. These protective covers for the airbag cushions are designed to open only when the airbags are inflating.
- Do not use accessory seat covers or place objects between you and the side airbags; the performance could be adversely affected and/or objects could be pushed into you, causing serious injury.

*(Continued)*

**WARNING! (Continued)**

- If your vehicle is equipped with left and right window bags, do not stack luggage or other cargo up high enough to block the location of the Side Airbag Inflatable Curtains (SABIC). The area where the side curtain airbag is located should remain free from any obstructions.
- Do not attach cup holders or any other objects on or around the door. The inflating side airbag could drive the object into occupants, causing serious injury.

Airbags inflate in moderate to high speed impacts. Along with seat belts and pretensioners, front airbags, and side airbags work with the knee bolsters to provide improved protection for the driver and front passenger.

The seat belts are designed to protect you in many types of collisions. The front airbags deploy in moderate to severe frontal collisions. If your vehicle is equipped, the side airbag on the crash side of the vehicle is triggered in moderate to severe side collisions. In certain types of collisions, both the front and side airbags may be triggered. However, even in collisions where the airbags work, you need the seat belts to keep you in the right position for the airbags to protect you properly.

Here are some simple steps you can take to minimize the risk of harm from a deploying airbag.

**1. Children 12 years old and younger should always ride buckled up in a rear seat.**

### **WARNING!**

**Infants in rear facing child restraints should NEVER ride in the front seat of a vehicle with a passenger front airbag. An airbag deployment can cause severe injury or death to infants in that position.**

Children that are not big enough to wear the vehicle seat belt properly (see section on Child Restraints) should be secured in the rear seat in child restraints or belt-positioning booster seats. Older children who do not use child restraints or belt-positioning booster seats should ride properly buckled up in the rear seat. Never allow children to slide the shoulder belt behind them or under their arm.

If a child from 1 to 12 years old must ride in the front passenger seat because the vehicle is crowded, move the seat as far back as possible, and use the proper child restraint. Refer to the section on Child Restraints.

You should read the instructions provided with your child restraint to make sure that you are using it properly.

2. All occupants should wear their lap and shoulder belts properly.
3. The driver and front passenger seats should be moved back as far as practical to allow the front airbags room to inflate.
4. If your vehicle has thorax side airbags, do not lean against the door as airbags will inflate forcefully into the space between you and the door.
5. If the airbag system in this vehicle needs to be modified to accommodate a disabled person, contact the Customer Center. Phone numbers are provided under "If You Need Assistance" in Section 9 of this manual.

**WARNING!**

- Relying on the airbags alone could lead to more severe injuries in a collision. The airbags work with your seat belt to restrain you properly. In some collisions, the airbags won't deploy at all. Always wear your seat belts even though you have airbags.
- Being too close to the steering wheel or instrument panel during front airbag deployment could cause serious injury. Airbags need room to inflate. Sit back, comfortably extending your arms to reach the steering wheel or instrument panel.
- Side airbags also need room to inflate. Do not lean against the door. Sit upright in the center of the seat.

## Airbag Deployment Sensors and Controls

### Occupant Restraint Controller (ORC)

The **Occupant Restraint Controller System (ORC)** is part of a Federally regulated safety system required for this vehicle.

The ORC determines if a frontal collision is severe enough to require the airbags to inflate. Based on the sensor signals, a central electronic Occupant Restraint Controller (ORC) deploys the front airbags, side inflatable airbag curtains (if equipped), seat-mounted thorax side airbags, and front seat belt pretensioners as required for each type of impact.

The ORC monitors the readiness of the electronic parts of the system whenever the ignition switch is in the START or RUN positions. These include all of the items listed above except the steering wheel and column, instrument panel, and passenger knee bolsters. If the key is in the

OFF position, in the ACC position, or not in the ignition, the airbags are not on and will not inflate.

The ORC contains a backup power supply system that will deploy the airbags even if the battery loses power or it becomes disconnected prior to deployment.



The ORC also turns on the Airbag Warning Light in the instrument panel for six to eight seconds for a self-check when the ignition is first turned on. After the self-check, the Airbag Warning Light will turn off. If the ORC detects a malfunction in any part of the system, it turns on the Airbag Warning Light either momentarily or continuously. A single chime will sound if the light comes on again after initial start up.

It also includes diagnostics that will illuminate the instrument cluster Airbag Warning Light if a malfunction is noted. The diagnostics also record the nature of the malfunction.

**WARNING!**

Ignoring the Airbag Warning Light in your instrument panel could mean you won't have the airbags to protect you in a collision. If the light does not come on, stays on after you start the vehicle, or if it comes on as you drive, have the airbag system checked right away.

**Impact Sensors**

Two sensors, located on the front body structure, trigger airbag deployment in direct frontal impacts and aid the Occupant Restraint Controller (ORC) in determining appropriate response to frontal impact events. Additional sensors in the ORC determine the level of airbag deployment and provide deployment verification.

**Side Inflatable Curtain and Front Seat-Mounted Airbags — If Equipped**

The Occupant Restraint Controller System (ORC) deploys the side inflatable curtain and seat-mounted thorax side airbags during collision with other vehicles and during collisions where the impact is confined to a particular area of the vehicle — such as collisions with poles, trees or similar objects.

It will deploy the side inflatable curtains and front seat-mounted thorax side airbags only on the impact side of the vehicle.

The front driver and passenger seat contain inflatable side airbags to protect the occupant from impact injuries. Correctly functioning front passenger seat components are critical for the ORC to properly classify the front passenger and calculate the proper airbag deployment. Do not make any modifications to the front passenger seat components, assembly, or to the seat cover.



The following requirements must be strictly adhered to:

- Do not make any modifications to the front passenger seat components, assembly, or to the seat cover in any way.
- Do not use prior or future model year seat covers not designated for the specific model being repaired. Always use the correct seat cover specified for the vehicle.
- Do not replace the seat cover with an aftermarket seat cover.
- Do not add a secondary seat cover other than those approved by Chrysler LLC/Mopar®.
- At no time should any supplemental restraint system (SRS) component or SRS related component or fastener be modified or replaced with any part except those which are approved by Chrysler LLC/Mopar®.

## WARNING!

**Unapproved modifications or service procedures to the front passenger seat assembly, its related components, or seat cover may inadvertently change the airbag deployment in case of a frontal crash. This could result in death or serious injury to the front seat passenger if the vehicle is involved in an accident. A modified vehicle may not comply with required Federal Motor Vehicle Safety Standards (FMVSS).**

### Enhanced Accident Response System

In the event of an impact that causes airbag deployment, with the vehicle stopped, and the vehicle communication network intact, and the power intact, the Enhanced Accident Response System performs the following functions:

- Cuts off fuel to the engine

- Flashes hazard lights
- Turns on the interior lights which remain on as long as the battery has power or until the ignition key is removed
- Unlocks the doors automatically

### **If a Deployment Occurs**

The airbag systems are designed to deploy when the Occupant Restraint Controller (ORC) detect a moderate-to-severe collision, to help restrain the driver and front passenger, and then immediately deflate.

**NOTE:** A frontal collision that is not severe enough to need airbag protection will not activate the system. This does not mean something is wrong with the airbag system.

If you do have a collision, which deploys the airbags, any or all of the following may occur:

- The nylon airbag material may sometimes cause abrasions and/or skin reddening to the driver and front passenger as the airbags deploy and unfold. The abrasions are similar to friction rope burns or those you might get sliding along a carpet or gymnasium floor. They are not caused by contact with chemicals. They are not permanent and normally heal quickly. However, if you haven't healed significantly within a few days, or if you have any blistering, see your doctor immediately.
- As the airbags deflate, you may see some smoke-like particles. The particles are a normal by-product of the process that generates the nontoxic gas used for airbag inflation. These airborne particles may irritate the skin, eyes, nose, or throat. If you have skin or eye irritation, rinse the area with cool water. For nose or throat

irritation, move to fresh air. If the irritation continues, see your doctor. If these particles settle on your clothing, follow the garment manufacturer's instructions for cleaning.

- It is not advisable to drive your vehicle after the airbags have deployed. If you are involved in another collision, the airbags will not be in place to protect you.

### **WARNING!**

Deployed airbags and seat belt pretensioners cannot protect you in another collision. Have the airbags, seat belt pretensioners, and the front passenger seat belt retractor assembly replaced by an authorized dealer as soon as possible. Also, have the Occupant Restraint Controller System serviced as well.

## Maintaining Your Airbag System

### **WARNING!**

- Modifications to any part of the airbag system could cause it to fail when you need it. You could be injured if the airbag system is not there to protect you. Do not modify the components or wiring, including adding any kind of badges or stickers to the steering wheel hub trim cover or the upper right side of the instrument panel. Do not modify the front bumper, vehicle body structure, or add aftermarket side steps or running boards.
- It is dangerous to try to repair any part of the airbag system yourself. Be sure to tell anyone who works on your vehicle that it has an airbag system.

**NOTE:** Perchlorate Material — special handling may apply. See [www.dtsc.ca.gov/hazardouswaste/perchlorate](http://www.dtsc.ca.gov/hazardouswaste/perchlorate)

### **WARNING!**

**Do not attempt to modify any part of your advanced airbag system. The airbag may inflate accidentally or may not function properly if modifications are made. Take your vehicle to an authorized dealer for any advanced airbag system service. If your seat including your trim cover and cushion needs to be serviced in any way (including removal or loosening/tightening of seat attachment bolts), take the vehicle to your authorized dealer. Only manufacturer approved seat accessories may be used. If it is necessary to modify an advanced airbag system for persons with disabilities, contact your authorized dealer.**

### **Airbag Warning Light**



You will want to have the airbags ready to inflate for your protection in a collision. While the airbag system is designed to be maintenance free, if any of the following occurs, have an authorized dealer service the system immediately.

- The Airbag Warning Light does not come on during the six to eight seconds when the ignition switch is first turned on.
- The light remains on after the six to eight second interval.
- The light comes on and remains on while driving.

**NOTE:** If the speedometer, tachometer, or any engine related gauges are not working, the Occupant Restraint Controller (ORC) may also be disabled. The airbags may not be ready to inflate for your protection. Promptly check fuse block for blown fuses. Refer to the label

located on the inside of the fuse block cover for the proper airbag fuses. See your authorized dealer if the fuse is good.

### **Event Data Recorder (EDR)**

In the event of an accident, your vehicle is designed to record up to five seconds of specific vehicle data parameters (see the following list) in an event data recorder prior to the moment of airbag deployment, or near deployment, and up to a quarter second of high-speed deceleration data during and/or after airbag deployment. EDR data are **ONLY** recorded if an airbag deploys, or nearly deploys, and are otherwise unavailable.

#### **NOTE:**

1. A near-deployment event occurs when the airbag sensor detects severe vehicle deceleration usually indicative of a crash, but not severe enough to warrant airbag deployment.

2. Under certain circumstances, EDR data may not be recorded (e.g., loss of battery power).

In conjunction with other data gathered during a complete accident investigation, the electronic data may be used by Chrysler LLC and others to learn more about the possible causes of crashes and associated injuries in order to assess and improve vehicle performance. In addition to crash investigations initiated by Chrysler LLC, such investigations may be requested by customers, insurance carriers, government officials, and professional crash researchers, such as those associated with universities, and with hospital and insurance organizations.

In the event that an investigation is undertaken by Chrysler LLC (regardless of initiative), the company or its designated representative will first obtain permission of the appropriate custodial entity for the vehicle (usually the vehicle owner or lessee) before accessing the electronic data stored, unless ordered to download data by a

court with legal jurisdiction (i.e., pursuant to a warrant). A copy of the data will be provided to the custodial entity upon request. General data that does not identify particular vehicles or crashes may be released for incorporation in aggregate crash databases, such as those maintained by the US government and various states. Data of a potentially sensitive nature, such as would identify a particular driver, vehicle, or crash, will be treated confidentially. Confidential data will not be disclosed by Chrysler LLC to any third party except when:

1. Used for research purposes, such as to match data with a particular crash record in an aggregate database, provided confidentiality of personal data is thereafter preserved.
2. Used in defense of litigation involving a Chrysler LLC product.
3. Requested by police under a legal warrant.

4. Otherwise required by law.

Data parameters that may be recorded:

- Diagnostic trouble code(s) and warning light status for electronically-controlled safety systems, including the airbag system
- Airbag disable light status (if equipped)
- "Time" of airbag deployment (in terms of ignition cycles and vehicle mileage)
- Airbag deployment level (if applicable)
- Impact acceleration and angle
- Seat belt status
- Brake status (service and parking brakes)
- Accelerator status (including vehicle speed)
- Engine control status (including engine speed)

- Transmission gear selection
- Cruise control status
- Traction/stability control status
- Tire Pressure Monitoring System status (if equipped)

### **Child Restraints**

Everyone in your vehicle needs to be buckled up all the time, including babies and children. Every state in the United States and all Canadian provinces require that small children ride in proper restraint systems. This is the law, and you can be prosecuted for ignoring it.

Children 12 years and younger should ride properly buckled up in a rear seat, if available. According to crash statistics, children are safer when properly restrained in the rear seats, rather than in the front.

### **WARNING!**

**In a collision, an unrestrained child, even a tiny baby, can become a missile inside the vehicle. The force required to hold even an infant on your lap could become so great that you could not hold the child, no matter how strong you are. The child and others could be badly injured. Any child riding in your vehicle should be in a proper restraint for the child's size.**

There are different sizes and types of restraints for children from newborn size to the child almost large enough for an adult safety belt. Always check the child seat owner's manual to ensure you have the correct seat for your child. Use the restraint that is correct for your child.

## Infants and Small Children

- Safety experts recommend that children ride rearward-facing in the vehicle until they are at least one year old and weigh at least 20 lbs (9 kg). Two types of child restraints can be used rearward-facing: infant carriers and convertible child seats. Both types of child restraints are held in the vehicle by the lap/shoulder belt or the LATCH child restraint anchorage system.
- The infant carrier is only used rearward-facing in the vehicle. It is recommended for children who weigh up to about 20 lbs (9 kg). Convertible child seats can be used either rearward-facing or forward-facing in the vehicle. Convertible child seats often have a higher weight limit in the rearward-facing direction than infant carriers do, so they can be used rearward-facing by children who weigh more than 20 lbs (9 kg) but are less than one year old.

### WARNING!

**Rearward-facing child seats must NEVER be used in the front seat of a vehicle with a front passenger airbag. An airbag deployment could cause severe injury or death to infants in this position.**

### Older Children and Child Restraints

Children who weigh more than 20 lbs (9 kg) and who are older than one year can ride forward-facing in the vehicle. Forward-facing child seats and convertible child seats used in the forward-facing direction are for children who weigh 20 to 40 lbs (9 to 18 kg) and who are older than one year. These child seats are also held in the vehicle by the lap/shoulder belt or the LATCH child restraint anchorage system. Refer to “LATCH — Child Seat Anchorage System (Lower Anchors and Tether for CHildren)” in this section.



The belt-positioning booster seat is for children weighing more than 40 lbs (18 kg), but who are still too small to fit the vehicle's seat belts properly. If the child cannot sit with knees bent over the vehicle's cushion while the child's back is against the seatback, then the child should use a belt-positioning booster seat. The child and booster seat are held in the vehicle by the lap/shoulder belt. (Some booster seats are equipped with a front shield and are held in the vehicle by the lap portion.)

**WARNING!**

- **Improper installation can lead to failure of an infant or child restraint. It could come loose in a collision. The child could be badly injured or killed. Follow the manufacturer's directions exactly when installing an infant or child restraint.**

*(Continued)*

**WARNING! (Continued)**

- **A rearward-facing child restraint should only be used in a rear seat. A rearward facing child restraint in the front seat may be struck by a deploying passenger airbag which may cause severe or fatal injury to the infant.**

**Here are some tips on getting the most out of your child restraints:**

- Children who are large enough to wear the shoulder belt comfortably, and whose legs are long enough to bend over the front of the seat when their back is against the seatback, should use the lap/shoulder belt in a rear seat.

- Before buying any restraint system, make sure that it has a label certifying that it meets all applicable Safety Standards. We also recommend that you make sure that you can install the child restraint in the vehicle where you will use it, before you buy it.
- The restraint must be appropriate for your child's weight and height. Check the label on the restraint for weight and height limits.
- Carefully follow the instructions that come with the restraint. If you install the restraint improperly, it may not work when you need it.
- All passenger seating positions contain automatic locking retractors. However, any seat belt system will loosen with time, so check the belt occasionally and pull it tight if necessary.
- In the rear seat, you may have trouble tightening the lap/shoulder belt on the child restraint because the buckle or latch plate is too close to the belt path opening on the restraint. Disconnect the latch plate from the buckle and twist the short buckle end of the belt several times to shorten it. Insert the latch plate into the buckle with the release button facing out.
- If the belt still can't be tightened, or if by pulling and pushing on the restraint loosens the belt, disconnect the latch plate from the buckle, turn the latch plate around, and insert the latch plate into the buckle again. If you still can't make the child restraint secure, try a different seating position.
- Buckle the child into the seat according to the child restraint manufacturer's directions.

**CAUTION!**

**When your child restraint is not in use, secure it in the vehicle with the seat belt or remove it from the vehicle. Don't leave it loose in the vehicle. In a sudden stop or collision, it could strike the occupants or seatbacks and cause serious personal injury.**

**NOTE:** For additional information, refer to [www.seatcheck.org](http://www.seatcheck.org) or call 1-866-SEATCHECK.

**Lower Anchors and Tether for CHildren (LATCH)**

Your vehicle is equipped with the child restraint anchorage system called LATCH, which stands for Lower Anchors and Tether for CHildren. The LATCH system provides for the installation of the child restraint without using the vehicle seat belt. All rear seating positions have

lower anchorages that are capable of accommodating LATCH-compatible child seats having flexible, webbing-mounted lower attachments. Child seats with fixed lower attachments must be installed in the outboard positions only. Regardless of the specific type of lower attachment, **NEVER** install LATCH-compatible child seats such that two seats share a common lower anchorage. If you are installing LATCH-compatible child restraints in adjacent rear seating positions, you can use the LATCH anchors or the vehicle's seat belt for the outboard position, but you must use the vehicle's seat belt at the center position. If your child restraints are not LATCH-compatible, you can only install the child restraints using the vehicle's seat belts. For typical installation instructions, refer to "Installing the LATCH-Compatible Child Restraint System".

### Rear Seat LATCH Anchors

Child restraints systems having attachments designed to connect to the lower anchorages are now available. Child restraints having tether straps and hooks for connection to the top tether anchorage have been available for some time. In fact, many child restraint manufacturers will provide add-on tether strap kits for some of their older products. Tether anchorage kits are also available for most older vehicles.

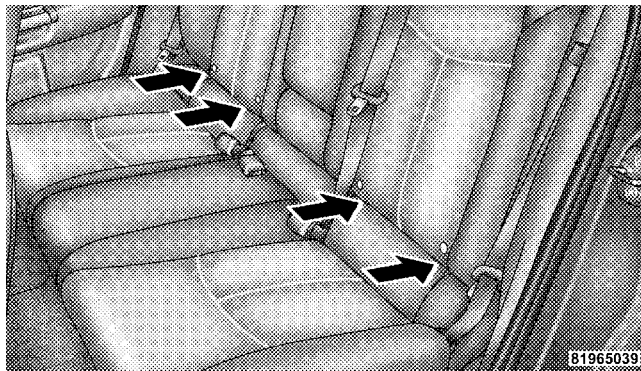

### Rear Seat LATCH Anchors

Because the lower anchorages are to be introduced to passenger carrying vehicles over a period of years, child restraint systems having attachments for those anchorages will continue to have features for installation in vehicles using the lap or lap/shoulder belt. They will also

have tether straps, and you are urged to take advantage of all of the available attachments provided with your child restraint in any vehicle.

**NOTE:** When using the LATCH attaching system to install a child restraint, please ensure that all seat belts not being used for occupant restraints are stowed and out of reach of children. It is recommended that before installing the child restraint, buckle the seat belt so the seat belt is tucked behind the child restraint and out of reach. If the buckled seat belt interferes with the child restraint installation, instead of tucking the seat belt behind the child restraint, route the seat belt through the child restraint belt path and then buckle it. This should stow the seat belt out of the reach of an inquisitive child. Remind all children in the vehicle that the seat belts are not toys and should not be played with, and never leave your child unattended in the vehicle.

## Installing the LATCH-Compatible Child Restraint System

We urge that you carefully follow the directions of the manufacturer when installing your child restraint. Not all child restraint systems will be installed as described here. Again, carefully follow the installation instructions that were provided with the child restraint system.



The rear seat lower anchorages are round bars, located at the rear of the seat cushion where it meets the seatback, and are just visible when you lean into the rear seat to install the child restraint. You will easily feel them if you run your finger along the intersection of the seatback and seat cushion surfaces.



In addition, there are tether strap anchorages behind each rear seating position located in the panel between the rear seatback and the rear window. These tether strap anchorages are under a plastic cover with this symbol on it.

Many, but not all restraint systems will be equipped with separate straps on each side, with each having a hook or connector for attachment to the lower anchorage and a means of adjusting the tension in the strap. Forward-facing toddler restraints and some rear-facing infant restraints will also be equipped with a tether strap, a hook for attachment to the tether strap anchorage and a means of adjusting the tension of the strap.

You will first loosen the adjusters on the lower straps and on the tether strap so that you can more easily attach the hooks or connectors to the vehicle anchorages. Next, attach the lower hooks or connectors over the top of the seat cover material. Then rotate the tether anchorage

cover directly behind the seat where you are placing the child restraint and attach the tether strap to the anchorage, being careful to route the tether strap to provide the most direct path between the anchor and the child restraint. Finally, tighten all three straps as you push the child restraint rearward and downward into the seat, removing slack in the straps according to the child restraint manufacturer's instructions.

**NOTE:**

- Ensure that the tether strap does not slip into the opening between the seatbacks as you remove slack in the strap.
- When using the LATCH attaching system to install a child restraint, please ensure that all seat belts not being used for occupant restraints are stowed and out of reach of children. It is recommended that before installing the child restraint, buckle the seat belt so the seat belt is tucked behind the child restraint and out of

reach. If the buckled seat belt interferes with the child restraint installation, instead of tucking the seat belt behind the child restraint, route the seat belt through the child restraint belt path and then buckle it. This should stow the seat belt out of the reach of an inquisitive child. Remind all children in the vehicle that the seat belts are not toys and should not be played with, and never leave your child unattended in the vehicle.

### WARNING!

Improper installation of a child restraint to the LATCH anchorages can lead to failure of an infant or child restraint. The child could be badly injured or killed. Follow the manufacturer's directions exactly when installing an infant or child restraint.

## Installing Child Restraint Tether Strap

1. Rotate the cover over the anchor directly behind the seat where you are placing the child restraint.

2

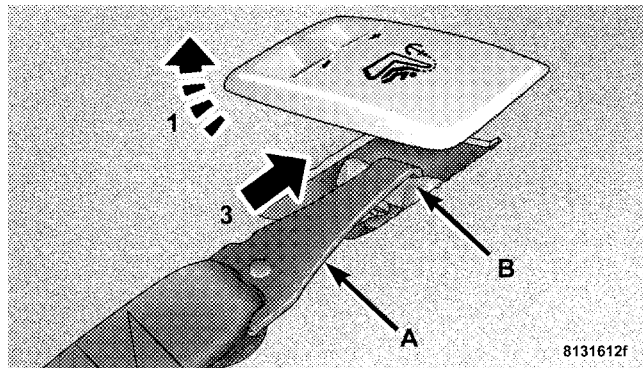

### Installing Child Restraint Tether Strap

- |                    |                     |
|--------------------|---------------------|
| 1— Cover           | A—Tether Strap Hook |
| 3— Attaching Strap | B—Tether Anchor     |

2. Route the tether strap to provide the most direct path for the strap between the anchor and the child seat. If your vehicle is equipped with adjustable rear head restraints, raise the head restraint, and where possible, route the tether strap under the head restraint and between the two posts. If not possible, lower the head restraint and pass the tether strap around the outboard side of the head restraint.
3. Attach the tether strap hook (A) of the child restraint to the anchor (B) and remove slack in the tether strap according to the child restraint manufacturer's instructions.

**WARNING!**

**An incorrectly anchored tether strap could lead to increased head motion and possible injury to the child. Use only the anchor positions directly behind the child seat to secure a child restraint top tether strap.**

**Installing Child Restraints Using the Vehicle Seat Belts**

The passenger seat belts are equipped with Automatic Locking Retractors (ALRs), which are designed to keep the lap portion tight around the child restraint.

The seat belt must be in the Automatic Locking mode in order to enable a child restraint to be tightly installed. Refer to "Automatic Locking Mode" in this section for details. A locking clip should not be necessary once the automatic locking feature is enabled. Position the shoulder and lap belt on the child restraint. The Automatic Locking Retractor (ALR) is activated by first attaching the child seat, then pulling all of the webbing out of the retractor, then allowing the webbing to retract. As the webbing retracts, you will hear a clicking sound. This indicates the safety belt is now in the Automatic Locking mode. To release, simply unbuckle the seat belt by depressing the button, and allow the webbing to retract into the retractor.



In the rear seat, you may have trouble tightening the lap/shoulder belt on the child restraint because the buckle or latch plate is too close to the belt path opening on the restraint. Disconnect the latch plate from the buckle and twist the short buckle-end belt several times to shorten it. Insert the latch plate into the buckle with the release button facing out.

If the belt still can't be tightened, or if by pulling and pushing on the restraint loosens the belt, you may need to do something more. Disconnect the latch plate from the buckle, turn the buckle around, and insert the latch plate into the buckle again. If you still can't make the child restraint secure, try a different seating position.

### **Children Too Large for Booster Seats**

Children who are large enough to wear the shoulder belt comfortably, and whose legs are long enough to bend over the front of the seat when their back is against the seatback, should use the lap/shoulder belt in a rear seat. Make sure that:

- The child is upright in the seat.
- The lap portion should be low on the hips and as snug as possible.
- Check belt fit periodically. A child's squirming or slouching can move the belt out of position.
- If the shoulder belt contacts the face or neck, move the child closer to the center of the vehicle. Never allow a child to put the shoulder belt under an arm or behind their back.

### **Transporting Pets**

Airbags deploying in the front seat could harm your pet. An unrestrained pet will be thrown about and possibly injured, or injure a passenger during panic braking or in a collision.

Pets should be restrained in the rear seat in pet harnesses or pet carriers that are secured by seat belts.

### **ENGINE BREAK-IN RECOMMENDATIONS**

A long break-in period is not required for the engine in your vehicle.

Drive moderately during the first 300 miles (500 km). After the initial 60 miles (100 km), speeds up to 50 or 55 mph (80 or 90 km/h) are desirable.

While cruising, brief full-throttle acceleration within the limits of local traffic laws, contributes to a good break-in. Wide-open throttle acceleration in low gear can be detrimental and should be avoided.

The engine oil installed in the engine at the factory is a high-quality energy conserving type lubricant. Oil changes should be consistent with anticipated climate conditions under which vehicle operations will occur. The recommended viscosity and quality grades are shown under “Engine Oil”, under “Maintenance Procedures” in section 7 of this manual. **NON-DETERGENT OR STRAIGHT MINERAL OILS MUST NEVER BE USED.**

A new engine may consume some oil during its first few thousand miles (kilometers) of operation. This should be considered as a normal part of the break-in and not interpreted as an indication of difficulty.

## SAFETY TIPS

### Exhaust Gas

#### WARNING!

Exhaust gases can injure or kill. They contain carbon monoxide (CO) which is colorless and odorless. Breathing it can make you unconscious and can eventually poison you. To avoid breathing (CO), follow these safety tips:

Do not run the engine in a closed garage or in confined areas any longer than needed to move your vehicle in or out of the area.

If it is necessary to sit in a parked vehicle with the engine running, adjust your heating or cooling controls to force outside air into the vehicle. Set the blower at high speed.

#### WARNING!

If you are required to drive with the deck lid open, make sure that all windows are closed, and the climate control blower switch is set at high speed. **DO NOT** use the recirculation mode.

2

### Safety Checks You Should Make Inside the Vehicle

#### Seat Belts

Inspect the seat belt system periodically, checking for cuts, frays and loose parts. Damaged parts must be replaced immediately. Do not disassemble or modify the system.

Front seat belt assemblies must be replaced after a collision. Rear seat belt assemblies must be replaced after a collision if they have been damaged (i.e., bent retractor, torn webbing, etc.). If there is any question regarding belt or retractor condition, replace the seat belt.

### **Airbag Warning Light**

The Airbag Warning Light should come on and remain on for six to eight seconds as a bulb check when the ignition switch is first turned ON. If the LED is not lit during starting, have it checked. If the light stays on or comes on while driving, have the system checked by an authorized dealer.

### **Defroster**

Check operation by selecting the defrost mode and place the blower control on high speed. You should be able to feel the air directed against the windshield.

**NOTE:** If the defrost feature is not functioning, the cause should be located and corrected immediately by an authorized service center. The windshield could fog up while driving and obscure your visibility.

## **Periodic Safety Checks You Should Make Outside the Vehicle**

### **Tires**

Examine tires for excessive tread wear or uneven wear patterns. Check for stones, nails, glass, or other objects lodged in the tread. Inspect tread and sidewall for cuts or cracks. Check wheel nuts for tightness. Check the tires (including spare) for proper pressure.

### **Lights**

Have someone observe the operation of exterior lights while you work the controls. Check turn signal and high beam indicator lights on the instrument panel.

### **Fluid Leaks**

Check area under vehicle after overnight parking for fuel, engine coolant, oil, or other fluid leaks. In addition, if gasoline fumes are detected or fuel, power steering fluid, transmission fluid, or brake fluid leaks are suspected, the cause should be located and corrected immediately.

# UNDERSTANDING THE FEATURES OF YOUR VEHICLE

## CONTENTS

---

■ Mirrors . . . . .	87	□ Phone Call Features . . . . .	101
□ Inside Day/Night Mirror . . . . .	87	□ UConnect® System Features . . . . .	104
□ Automatic Dimming Mirror — If Equipped . . . . .	88	□ Advanced Phone Connectivity . . . . .	109
□ Power Mirrors . . . . .	89	□ Things You Should Know About Your UConnect® System . . . . .	110
□ Adjusting Sideview Mirrors . . . . .	90	□ General Information . . . . .	119
□ Illuminated Vanity Mirrors — If Equipped . . . . .	90	■ Voice Recognition System (VR) — If Equipped . . . . .	119
■ Hands-Free Communication (UConnect®) — If Equipped . . . . .	91	□ Voice Recognition System (VR) Operation . . . . .	119
□ Operation . . . . .	93	□ Commands . . . . .	121

- Voice Training . . . . . 124
- Seats . . . . . 125
  - Manual Front Seat Adjustment . . . . . 125
  - Reclining Bucket Seats . . . . . 127
  - Lumbar Support — If Equipped . . . . . 128
  - Power Seats — If Equipped . . . . . 128
  - Adjustable Head Restraints . . . . . 129
  - Heated Seats — If Equipped . . . . . 130
  - Fold Flat Passenger Seat Back . . . . . 131
  - Folding Rear Seat . . . . . 132
  - Folding Rear Seat Center Armrest . . . . . 133
- To Open And Close The Hood . . . . . 133
- Lights . . . . . 135
  - Map/Reading/Interior Lights . . . . . 135
  - Headlights, Parking Lights And Instrument Panel Lights . . . . . 136
  - Automatic Headlight System — If Equipped . . . . . 137
  - Headlight Time Delay . . . . . 137
  - Flash-To-Pass . . . . . 138
  - Daytime Running Lights (DRL) — If Equipped . . . . . 138
  - Lights On Reminder . . . . . 138
  - Fog Lights — If Equipped . . . . . 138
  - Turn Signals . . . . . 139
  - High Beam/Low Beam Select Switch . . . . . 140

- Windshield Wipers And Washers . . . . . 141
  - Intermittent Wiper System . . . . . 142
  - Mist Feature . . . . . 143
  - Headlights With Wipers Feature (Available With Auto Headlights Only) . . . . . 143
  - Windshield Washers . . . . . 144
- Tilt/Telescoping Steering Column . . . . . 144
- Electronic Speed Control — If Equipped . . . . . 145
  - To Activate . . . . . 146
  - To Set At A Desired Speed . . . . . 146
  - To Deactivate . . . . . 146
  - To Resume Speed . . . . . 147
  - To Vary The Speed Setting . . . . . 147

- To Accelerate For Passing . . . . . 148
- Garage Door Opener — If Equipped . . . . . 148
  - Programming HomeLink® . . . . . 149
  - Gate Operator/Canadian Programming . . . . . 153
  - Security . . . . . 153
  - Troubleshooting Tips . . . . . 154
  - General Information . . . . . 154
- Power Sunroof — If Equipped . . . . . 155
  - Sunroof Operation . . . . . 156
  - Auto Sunroof Express With Anti-Pinch Protection — If Equipped . . . . . 156
  - Sunshade Operation . . . . . 157
  - Wind Buffeting . . . . . 157

<input type="checkbox"/> Sunroof Maintenance . . . . .	157	<input checked="" type="checkbox"/> Storage . . . . .	163
<input type="checkbox"/> Ignition Off Operation . . . . .	157	<input type="checkbox"/> Driver's Side Sunglass Holder — If Equipped . . . . .	163
<input checked="" type="checkbox"/> Electrical Power Outlets . . . . .	158	<input type="checkbox"/> Cargo Area . . . . .	164
<input checked="" type="checkbox"/> Cigar Lighter And Ash Receiver — If Equipped . . . . .	160	<input checked="" type="checkbox"/> Console Features . . . . .	165
<input checked="" type="checkbox"/> Cupholders . . . . .	161	<input type="checkbox"/> Dual Storage Bins . . . . .	166
<input type="checkbox"/> Heated/Cooled Cupholder — If Equipped . . . . .	161	<input type="checkbox"/> Video Console — If Equipped . . . . .	168
<input type="checkbox"/> Rear Bottle Holders . . . . .	162	<input checked="" type="checkbox"/> Rear Window Features . . . . .	169
		<input type="checkbox"/> Rear Window Defroster — If Equipped . . . . .	169



## MIRRORS

### Inside Day/Night Mirror

A two-point pivot system allows for horizontal and vertical mirror adjustment. Adjust the mirror to center on the view through the rear window.

Headlight glare can be reduced by moving the small control under the mirror to the night position (toward the rear of the vehicle). The mirror should be adjusted while set in the day position (toward the windshield).

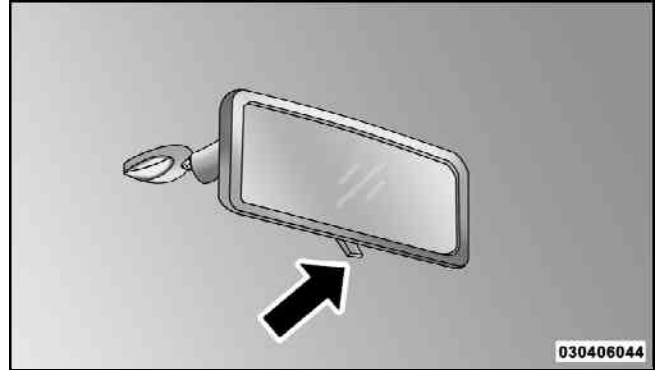

3

Adjusting Rearview Mirror

**Automatic Dimming Mirror — If Equipped**

This mirror will automatically adjust for headlight glare from vehicles behind you. Push in the button on the face of the mirror to activate the dimming feature.

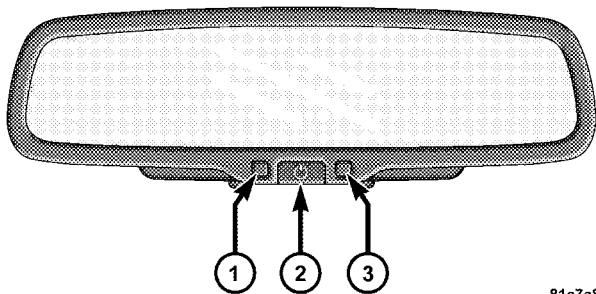

81c7a8c8

- 1 — Auto Dimming Mirror Power Indicator
- 2 — On/Off Switch
- 3 — Auto Dimming Mirror Sensor

**CAUTION!**

To avoid damage to the mirror during cleaning, never spray any cleaning solution directly onto the mirror. Apply the solution onto a clean cloth and wipe the mirror clean.

## Power Mirrors

The power mirrors switch is located on the drivers door trim panel.

The rotary knob has three separate positions: L for the left mirror, O for Off; and R for the right mirror.

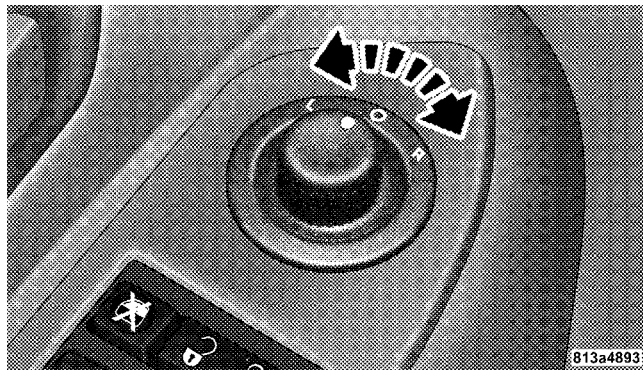

Power Mirror Switch

After selecting a mirror, move the knob in the same direction you want the mirror to move. When finished, return the knob to the center Off position to guard against accidentally moving a mirror position.

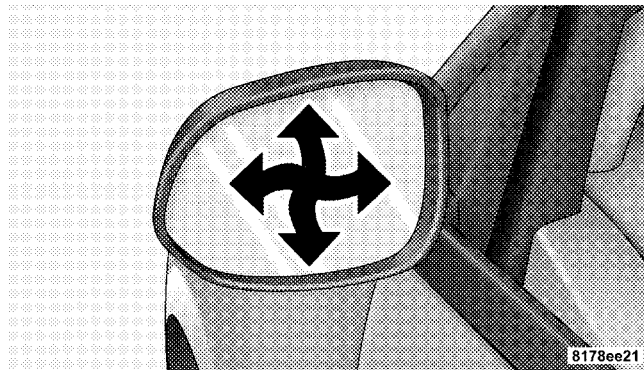

Mirror Directions

## Adjusting Sideview Mirrors

### Outside Mirror — Driver's Side

Adjust the outside mirror to center on the adjacent lane of traffic, with a slight overlap of the view obtained on the inside mirror.

### Outside Mirror — Passenger's Side

Adjust the convex outside mirror so you can just see the side of your vehicle in the part of the mirror closest to the vehicle.

#### WARNING!

Vehicles and other objects seen in the right side convex mirror will look smaller and farther away than they really are. Relying too much on your right side mirror could cause you to collide with another vehicle or other object. Use your inside mirror when judging the size or distance of a vehicle seen in this convex mirror.

## Illuminated Vanity Mirrors — If Equipped

An illuminated vanity mirror is on each sun visor. To use the mirror, lower the sun visor and rotate the mirror cover upward. The lights will turn on automatically. Closing the mirror cover turns off the lights.

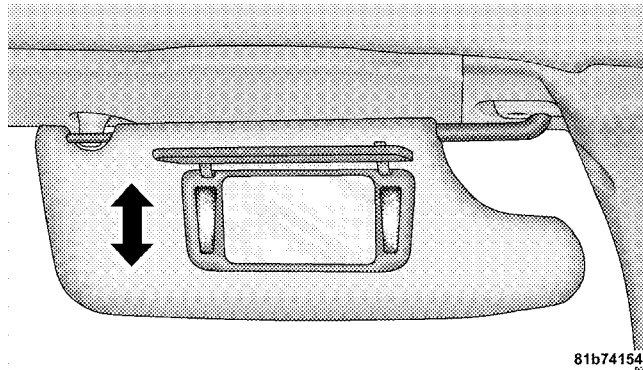

81b74154

Illuminated Vanity Mirror

## HANDS-FREE COMMUNICATION (UConnect®) — IF EQUIPPED

**NOTE:** The sales code RER and REU radios contain an integrated Hands-Free Communication (UConnect®) system. Refer to your “Navigation User’s Manual” for UConnect® system operating instructions for these radios. Radio sales code can be located on the lower right corner of the Radio faceplate.

UConnect® is a voice-activated, hands-free, in-vehicle communications system. UConnect® allows you to dial a phone number with your cellular phone using simple voice commands (e.g., “Call” ... “Mike” ... “Work” or “Dial” ... “248-555-1212”). Your cellular phone’s audio is transmitted through your vehicle’s audio system; the system will automatically mute your radio when using the UConnect® system.

**NOTE:** The UConnect® system requires a cellular phone equipped with the Bluetooth® “Hands-Free Profile,” Version 0.96 or higher. See the UConnect® website for supported phones.

**NOTE:** For UConnect® customer support, visit the following websites:

- [www.chrysler.com/uconnect](http://www.chrysler.com/uconnect)
- [www.dodge.com/uconnect](http://www.dodge.com/uconnect)
- [www.jeep.com/uconnect](http://www.jeep.com/uconnect)
- or call 1-877-855-8400

UConnect® allows you to transfer calls between the system and your cellular phone as you enter or exit your vehicle and enables you to mute the system’s microphone for private conversation.

The UConnect® system is driven through your Bluetooth® “Hands-Free Profile” cellular phone. UConnect® features Bluetooth® technology - the global standard that enables different electronic devices to connect to each other without wires or a docking station, so UConnect® works no matter where you stow your cellular phone (be it your purse, pocket, or briefcase), as long as your phone is turned on and has been paired to the vehicle’s UConnect® system. The UConnect® system allows up to seven cellular phones to be linked to the system. Only one linked (or paired) cellular phone can be used with the system at a time. The system is available in English, Spanish, or French languages.

#### *Phone Button*



The rearview mirror contains the microphone for the system (depending on the type of mirror and radio equipped), and either the

radio or the mirror has the two control buttons (PHONE Button and VOICE RECOGNITION button) that will enable you to access the system.

#### *Voice Recognition Button*



Actual button location may vary with the radio. The individual buttons are described in the “Operation” section.

The UConnect® system can be used with any Hands-Free Profile certified Bluetooth® cellular phone. See the UConnect® website for supported phones. If your cellular phone supports a different profile (e.g., Headset Profile) you may not be able to use any UConnect® features. Refer to your cellular service provider or the phone manufacturer for details.

The UConnect® system is fully integrated with the vehicle's audio system. The volume of the UConnect® system can be adjusted either from the radio volume control knob or from the steering wheel radio control (right switch), if so equipped.

The radio display will be used for visual prompts from the UConnect® system such as "CELL" or caller ID on certain radios.

### Operation

Voice commands can be used to operate the UConnect® system and to navigate through the UConnect® menu structure. Voice commands are required after most UConnect® system prompts. You will be prompted for a specific command and then guided through the available options.

- Prior to giving a voice command, one must wait for the beep, which follows the "Ready" prompt or another prompt.

- For certain operations, compound commands can be used. For example, instead of saying "Setup" and then "Phone Pairing," the following compound command can be said: "Setup Phone Pairing."
- For each feature explanation in this section, only the combined form of the voice command is given. You can also break the commands into parts and say each part of the command when you are asked for it. For example, you can use the combined form voice command "Phonebook New Entry," or you can break the combined form command into two voice commands: "Phonebook" and "New Entry." Please remember, the UConnect® system works best when you talk in a normal conversational tone, as if speaking to someone sitting a few feet/meters away from you.

### Voice Command Tree

Refer to "Voice Tree" in this section.

### Help Command

If you need assistance at any prompt, or if you want to know your options at any prompt, say "Help" following the beep. The UConnect® system will play all the options at any prompt if you ask for help.

To activate the UConnect® system from idle, simply press the PHONE button and follow the audible prompts for directions. All UConnect® system sessions begin with a press of the PHONE button on the radio control head.

### Cancel Command

At any prompt, after the beep, you can say "Cancel" and you will be returned to the main menu. However, in a few instances the system will take you back to the previous menu.

### Pair (Link) UConnect® System to a Cellular Phone

To begin using your UConnect® system, you must pair your compatible Bluetooth® enabled cellular phone.

To complete the pairing process, you will need to reference your cellular phone Owner's Manual. The UConnect® website may also provide detailed instructions for pairing.

The following are general phone to UConnect® system pairing instructions:

- Press the PHONE button to begin.
- After the "Ready" prompt and the following beep, say "Setup Phone Pairing."
- When prompted, after the beep, say "Pair a Phone" and follow the audible prompts.
- You will be asked to say a four-digit Personal Identification Number (PIN), which you will later need to enter into your cellular phone. You can enter any four-digit PIN. You will not need to remember this PIN after the initial pairing process.



- For identification purposes, you will be prompted to give the UConnect® system a name for your cellular phone. Each cellular phone that is paired should be given a unique phone name.
- You will then be asked to give your cellular phone a priority level between one and seven, with one being the highest priority. You can pair up to seven cellular phones to your UConnect® system. However, at any given time, only one cellular phone can be in use, connected to your UConnect® system. The priority allows the UConnect® system to know which cellular phone to use if multiple cellular phones are in the vehicle at the same time. For example, if priority three and priority five phones are present in the vehicle, the UConnect® system will use the priority three cellular phone when you make a call. You can select to use a lower priority cellular phone at any time (refer to "Advanced Phone Connectivity" in this section).

### Dial by Saying a Number

- Press the PHONE button to begin.
- After the "Ready" prompt and the following beep, say "Dial."
- The system will prompt you to say the number you want to call.
- For example, you can say "234-567-8901".
- The UConnect® system will confirm the phone number and then dial. The number will appear in the display of certain radios.

### Call by Saying a Name

- Press the PHONE button to begin.
- After the "Ready" prompt and the following beep, say "Call."

- The system will prompt you to say the name of the person you want to call.
- After the "Ready" prompt and the following beep, say the name of the person you want to call. For example, you can say "John Doe," where John Doe is a previously stored name entry in the UConnect® phonebook or downloaded phonebook. To learn how to store a name in the phonebook, refer to "Add Names to Your UConnect® Phonebook," in the phonebook.
- The UConnect® system will confirm the name and then dial the corresponding phone number, which may appear in the display of certain radios.
- After the "Ready" prompt and the following beep, say "Phonebook New Entry."
- When prompted, say the name of the new entry. Use of long names helps the voice recognition and it is recommended. For example, say "Robert Smith" or "Robert" instead of "Bob."
- When prompted, enter the number designation (e.g., "Home," "Work," "Mobile," or "Pager"). This will allow you to store multiple numbers for each phonebook entry, if desired.
- When prompted, recite the phone number for the phonebook entry that you are adding.

### **Add Names to Your UConnect® Phonebook**

**NOTE:** Adding names to the UConnect® phonebook is recommended when the vehicle is not in motion.

- Press the PHONE button to begin.

After you are finished adding an entry into the phonebook, you will be given the opportunity to add more phone numbers to the current entry or to return to the main menu.

The UConnect® system will allow you to enter up to 32 names in the phonebook with each name having up to four associated phone numbers and designations. Each language has a separate 32-name phonebook accessible only in that language. In addition, if equipped and supported by your phone, UConnect® automatically downloads your mobile phone's phonebook.

### **Phonebook Download – Automatic Phonebook Transfer From Mobile Phone**

If equipped and specifically supported by your phone, UConnect® automatically downloads names (text names) and number entries from the mobile phone's phonebook. Specific Bluetooth® Phones with Phone Book Access Profile may support this feature. See UConnect® website for supported phones.

- To call a name from downloaded (or UConnect®) Phonebook, follow the procedure in “Call by Saying a Name” section.

- Automatic download and update, if supported, begins as soon as the Bluetooth® wireless phone connection is made to the UConnect®, for example, after you start the vehicle.
- A maximum of 1000 entries per phone will be downloaded and updated every time a phone is connected to the UConnect®.
- Depending on the maximum number of entries downloaded, there may be a short delay before the latest downloaded names can be used. Until then, if available, the previous downloaded phonebook is available for use.
- Only the phonebook of the currently connected mobile phone is accessible.
- Only the mobile phone's phonebook is downloaded. SIM card phonebook is not part of the Mobile phonebook.

- This downloaded phonebook cannot be edited or deleted on the UConnect®. These can only be edited on the mobile phone. The changes are transferred and updated to UConnect® on the next phone connection.

### **Phonebook Download — Single Entry**

If equipped and supported by your phone, UConnect® allows the user to download entries from their phone via Bluetooth®. To use this feature, press the PHONE button and say “Phonebook Download.” The system prompts, “Ready to accept “V” card entry via Bluetooth®...” The system is now ready to accept phonebook entries from your phone using the Bluetooth® Object Exchange Profile (OBEX). Please see your phone Owner’s Manual for specific instructions on how to send these entries from your phone.

#### **NOTE:**

- The phone handset must support Bluetooth® OBEX transfers of phonebook entries to use this feature.

- Some phones cannot send phonebook entries if they are already connected to any system via Bluetooth®, and you may see a message on the phone display that the Bluetooth® link is busy. In this case, the user must first disconnect or drop the Bluetooth® connection to the UConnect® system, and then send the address book entry via Bluetooth®. Please see your phone Owner’s Manual for specific instructions on how to drop the Bluetooth® connection.
- If the phonebook entry is longer than 24 characters, it will only use the first 24 characters.

### **Edit UConnect® Phonebook Entries**

#### **NOTE:**

- Editing names in the phonebook is recommended when the vehicle is not in motion.
- Automatic downloaded phonebook entries cannot be deleted or edited.

- Press the PHONE button to begin.
- After the "Ready" prompt and the following beep, say "Phonebook Edit."
- You will then be asked for the name of the phonebook entry that you wish to edit.
- Next, choose the number designation (home, work, mobile, or pager) that you wish to edit.
- When prompted, recite the new phone number for the phonebook entry that you are editing.

After you are finished editing an entry in the phonebook, you will be given the opportunity to edit another entry in the phonebook, call the number you just edited, or return to the main menu.

"Phonebook Edit" can be used to add another phone number to a name entry that already exists in the phonebook. For example, the entry John Doe may have a

mobile and a home number, but you can add "John Doe's" work number later using the "Phonebook Edit" feature.

### Delete UConnect® Phonebook Entry

**NOTE:** Editing phonebook entries is recommended when the vehicle is not in motion.

- Press the PHONE button to begin.
- After the "Ready" prompt and the following beep, say "Phonebook Delete."
- After you enter the Phonebook Delete menu, you will then be asked for the name of the entry that you wish to delete. You can either say the name of a phonebook entry that you wish to delete or you can say "List Names" to hear a list of the entries in the phonebook from which you choose. To select one of the entries from the list, press the VOICE RECOGNITION button while the UConnect® system is playing the desired entry and say "Delete."

- After you enter the name, the UConnect® system will ask you which designation you wish to delete: home, work, mobile, pager, or all. Say the designation you wish to delete.
- Note that only the phonebook entry in the current language is deleted.
- Automatic downloaded phonebook entries cannot be deleted or edited.

#### **Delete/Erase "All" UConnect® Phonebook Entries**

- Press the PHONE button to begin.
- After the "Ready" prompt and the following beep, say "Phonebook Erase All."
- The UConnect® system will ask you to verify that you wish to delete all the entries from the phonebook.
- After confirmation, the phonebook entries will be deleted.

- Note that only the phonebook in the current language is deleted.
- Automatic downloaded phonebook entries cannot be deleted or edited.

#### **List All Names in the UConnect® Phonebook**

- Press the PHONE button to begin.
- After the "Ready" prompt and the following beep, say "Phonebook List Names."
- The UConnect® system will play the names of all the phonebook entries, including the downloaded phonebook entries, if available.
- To call one of the names in the list, press the VOICE RECOGNITION button during the playing of the desired name, and say "Call."

**NOTE:** The user can also exercise "Edit" or "Delete" operations at this point.

- The UConnect® system will then prompt you as to the number designation you wish to call.
- The selected number will be dialed.

### **Phone Call Features**

The following features can be accessed through the UConnect® system if the feature(s) are available on your cellular service plan. For example, if your cellular service plan provides three-way calling, this feature can be accessed through the UConnect® system. Check with your cellular service provider for the features that you have.

#### **Answer or Reject an Incoming Call - No Call Currently in Progress**

When you receive a call on your cellular phone, the UConnect® system will interrupt the vehicle audio system, if on, and will ask if you would like to answer the

call. Press the PHONE button to accept the call. To reject the call, press and hold the PHONE button until you hear a single beep, indicating that the incoming call was rejected.

#### **Answer or Reject an Incoming Call - Call Currently in Progress**

If a call is currently in progress and you have another incoming call, you will hear the same network tones for call waiting that you normally hear when using your cellular phone. Press the PHONE button to place the current call on hold and answer the incoming call.

**NOTE:** The UConnect® system compatible phones in the market today do not support rejecting an incoming call when another call is in progress. Therefore, the user can only answer an incoming call or ignore it.

### **Making a Second Call While Current Call is in Progress**

To make a second call while you are currently on a call, press the VOICE RECOGNITION button and say "Dial" or "Call" followed by the phone number or phonebook entry you wish to call. The first call will be on hold while the second call is in progress. To go back to the first call, refer to "Toggling Between Calls" in this section. To combine two calls, refer to "Conference Call" in this section.

### **Place/Retrieve a Call From Hold**

To put a call on hold, press the PHONE button until you hear a single beep. This indicates that the call is on hold. To bring the call back from hold, press and hold the PHONE button until you hear a single beep.

### **Toggling Between Calls**

If two calls are in progress (one active and one on hold), press the PHONE button until you hear a single beep,

indicating that the active and hold status of the two calls have switched. Only one call can be placed on hold at a time.

### **Conference Call**

When two calls are in progress (one active and one on hold), press and hold the PHONE button until you hear a double beep indicating that the two calls have been joined into one conference call.

### **Three-Way Calling**

To initiate three-way calling, press the VOICE RECOGNITION button while a call is in progress, and make a second phone call, as described under "Making a Second Call While Current Call is in Progress." After the second call has established, press and hold the PHONE button until you hear a double beep, indicating that the two calls have been joined into one conference call.



### Call Termination

To end a call in progress, momentarily press the PHONE button. Only the active call(s) will be terminated and if there is a call on hold, it will become the new active call. If the active call is terminated by the far end, a call on hold may not become active automatically. This is cell phone-dependent. To bring the call back from hold, press and hold the PHONE button until you hear a single beep.

### Redial

- Press the PHONE button to begin.
- After the "Ready" prompt and the following beep, say "Redial."
- The UConnect® system will call the last number that was dialed from your cellular phone.

**NOTE:** This may not be the last number dialed from the UConnect® system.

### Call Continuation

Call continuation is the progression of a phone call on the UConnect® system after the vehicle ignition key has been switched to OFF. Call continuation functionality available on the vehicle can be any one of three types:

- After the ignition key is switched to OFF, a call can continue on the UConnect® system either until the call ends, or until the vehicle battery condition dictates cessation of the call on the UConnect® system and transfer of the call to the mobile phone.
- After the ignition key is switched to OFF, a call can continue on the UConnect® system for a certain duration, after which the call is automatically transferred from the UConnect® system to the mobile phone.
- An active call is automatically transferred to the mobile phone after the ignition key is switched to OFF.

## UConnect® System Features

### Language Selection

To change the language that the UConnect® system is using:

- Press the PHONE button to begin.
- After the "Ready" prompt and the following beep, say the name of the language you wish to switch to English, Espanol, or Francais.
- Continue to follow the system prompts to complete the language selection.

After selecting one of the languages, all prompts and voice commands will be in that language.

**NOTE:** After every UConnect® language change operation, only the language-specific 32-name phonebook is usable. The paired phone name is not language-specific and usable across all languages.

### Emergency Assistance

If you are in an emergency and the mobile phone is reachable:

- Pick up the phone and manually dial the emergency number for your area.

If the phone is not reachable and the UConnect® system is operational, you may reach the emergency number as follows:

- Press the PHONE button to begin.
- After the "Ready" prompt and the following beep, say "Emergency" and the UConnect® system will instruct the paired cellular phone to call the emergency number. This feature is supported in the U.S., Canada, and Mexico.

**NOTE:**

- The emergency number dialed is based on the country where the vehicle is purchased (911 for the U.S. and

Canada and 060 for Mexico). The number dialed may not be applicable with the available cellular service and area.

- If supported, this number may be programmable on some systems. To do this, press the PHONE button and say 'Setup', followed by 'Emergency'.
- The UConnect® system does slightly lower your chances of successfully making a phone call as to that for the cell phone directly.

### **WARNING!**

**Your phone must be turned on and paired to the UConnect® system to allow use of this vehicle feature in emergency situations, when the cell phone has network coverage and stays paired to the UConnect® system.**

### **Towing Assistance**

If you need towing assistance:

- Press the PHONE button to begin.
- After the "Ready" prompt and the following beep, say "Towing Assistance."

### **NOTE:**

- The towing assistance number dialed is based on the country where the vehicle is purchased (1-800-528-2069 for the U.S., 1-877-213-4525 for Canada, 55-14-3454 for Mexico City and 1-800-712-3040 for outside Mexico City in Mexico).
- If supported, this number may be programmable on some systems. To do this, press the PHONE button and say "Setup", followed by "Towing Assistance".

**Paging**

To learn how to page, refer to "Working with Automated Systems." Paging works properly except for pagers of certain companies, which time out a little too soon to work properly with the UConnect® system.

**Voice Mail Calling**

To learn how to access your voice mail, refer to "Working with Automated Systems."

**Working with Automated Systems**

This method is used in instances where one generally has to press numbers on the cellular phone keypad while navigating through an automated telephone system.

You can use your UConnect® system to access a voice mail system or an automated service, such as a paging service or automated customer service line. Some services require immediate response selection. In some instances, that may be too quick for use of the UConnect® system.

When calling a number with your UConnect® system that normally requires you to enter in a touch-tone sequence on your cellular phone keypad, you can press the VOICE RECOGNITION button and say the sequence you wish to enter, followed by the word "Send." For example, if required to enter your PIN followed with a pound, (3 7 4 6 #), you can press the VOICE RECOGNITION button and say, "3 7 4 6 # Send." Saying a number, or sequence of numbers, followed by "Send," is also to be used for navigating through an automated customer service center menu structure, and to leave a number on a pager.

You can also send stored UConnect® phonebook entries as tones for fast and easy access to voice mail and pager entries. To use this feature, dial the number you wish to call and then press the VOICE RECOGNITION button and say, "Send." The system will prompt you to enter the name or number and say the name of the phonebook entry you wish to send. The UConnect® system will then

send the corresponding phone number associated with the phonebook entry, as tones over the phone.

**NOTE:**

- You may not hear all of the tones due to cellular phone network configurations. This is normal.
- Some paging and voice mail systems have system time out settings that are too short and may not allow the use of this feature.

**Barge In - Overriding Prompts**

The “Voice Recognition” button can be used when you wish to skip part of a prompt and issue your voice recognition command immediately. For example, if a prompt is asking “Would you like to pair a phone, clear a...,” you could press the VOICE RECOGNITION button and say, “Pair a Phone” to select that option without having to listen to the rest of the voice prompt.

**Turning Confirmation Prompts ON/OFF**

Turning confirmation prompts off will stop the system from confirming your choices (e.g., the UConnect® system will not repeat a phone number before you dial it).

- Press the PHONE button to begin.
- After the “Ready” prompt and the following beep, say “Setup Confirmations.” The UConnect® system will play the current confirmation prompt status and you will be given the choice to change it.

**Phone and Network Status Indicators**

If available on the radio and/or on a premium display such as the instrument panel cluster, and supported by your cellular phone, the UConnect® system will provide notification to inform you of your phone and network status when you are attempting to make a phone call using UConnect®. The status is given for roaming, network signal strength, phone battery strength, etc.

### Dialing Using the Cellular Phone Keypad

You can dial a phone number with your cellular phone keypad and still use the UConnect® system (while dialing via the cellular phone keypad, the user must exercise caution and take precautionary safety measures). By dialing a number with your paired Bluetooth® cellular phone, the audio will be played through your vehicle's audio system. The UConnect® system will work the same as if you dial the number using voice recognition.

**NOTE:** Certain brands of cellular phones do not send the dial ring to the UConnect® system to play it on the vehicle audio system, so you will not hear it. Under this situation, after successfully dialing a number the user may feel that the call did not go through even though the call is in progress. Once your call is answered, you will hear the audio.

### Mute/Un-Mute (Mute OFF)

When you mute the UConnect® system, you will still be able to hear the conversation coming from the other party, but the other party will not be able to hear you. In order to mute the UConnect® system:

- Press the VOICE RECOGNITION button.
- Following the beep, say "Mute."

In order to un-mute the UConnect® system:

- Press the VOICE RECOGNITION button.
- Following the beep, say "Mute off."

## Advanced Phone Connectivity

### Transfer Call to and from Cellular Phone

The UConnect® system allows ongoing calls to be transferred from your cellular phone to the UConnect® system without terminating the call. To transfer an ongoing call from your UConnect® paired cellular phone to the UConnect® system or vice versa, press the VOICE RECOGNITION button and say "Transfer Call."

### Connect or Disconnect Link Between the UConnect® System and Cellular Phone

Your cellular phone can be paired with many different electronic devices, but can only be actively "connected" with one electronic device at a time.

If you would like to connect or disconnect the Bluetooth® connection between a UConnect® paired cellular phone and the UConnect® system, follow the instructions described in your cellular phone User's Manual.

### List Paired Cellular Phone Names

- Press the PHONE button to begin.
- After the "Ready" prompt and the following beep, say "Setup Phone Pairing."
- When prompted, say "List Phones."
- The UConnect® system will play the phone names of all paired cellular phones in order from the highest to the lowest priority. To "select" or "delete" a paired phone being announced, press the VOICE RECOGNITION button and say "Select" or "Delete." Also, see the next two sections for an alternate way to "select" or "delete" a paired phone.

### Select Another Cellular Phone

This feature allows you to select and start using another phone paired with the UConnect® system.

- Press the PHONE button to begin.
- After the "Ready" prompt and the following beep, say "Setup Select Phone" and follow the prompts.
- You can also press the VOICE RECOGNITION button at any time while the list is being played, and then choose the phone that you wish to select.
- The selected phone will be used for the next phone call. If the selected phone is not available, the UConnect® system will return to using the highest priority phone present in or near (approximately within 30 ft (9 m)) the vehicle.

### Delete UConnect® Paired Cellular Phones

- Press the PHONE button to begin.
- After the "Ready" prompt and the following beep, say "Setup Phone Pairing."
- At the next prompt, say "Delete" and follow the prompts.
- You can also press the VOICE RECOGNITION button at any time while the list is being played, and then choose the phone you wish to delete.

### Things You Should Know About Your UConnect® System

#### UConnect® Tutorial

To hear a brief tutorial of the system features, press the PHONE button and say "UConnect® Tutorial."



## Voice Training

For users experiencing difficulty with the system recognizing their voice commands or numbers, the UConnect® system Voice Training feature may be used. To enter this training mode, follow one of the two following procedures:

From outside the UConnect® mode (e.g., from radio mode):

- Press and hold the VOICE RECOGNITION button for five seconds until the session begins, or,
- Press the VOICE RECOGNITION button and say the "Setup, Voice Training" command.

Repeat the words and phrases when prompted by the UConnect® system. For best results, the Voice Training session should be completed when the vehicle is parked with the engine running, all windows closed, and the blower fan switched off.

This procedure may be repeated with a new user. The system will adapt to the last trained voice only.

To restore the Voice Recognition system to factory default settings, enter the Voice Training session via the above procedure and follow the prompts.

## Voice Recognition (VR)

- For best performance, adjust the rearview mirror to provide at least ½ in (1 cm) gap between the overhead console (if equipped) and the mirror.
- Always wait for the beep before speaking.
- Speak normally, without pausing, just as you would speak to a person sitting a few feet/meters away from you.
- Make sure that no one other than you is speaking during a voice recognition period.

- Performance is maximized under:
  - low-to-medium blower setting,
  - low-to-medium vehicle speed,
  - low road noise,
  - smooth road surface,
  - fully closed windows,
  - dry weather condition.
- Even though the system is designed for users speaking in North American English, French, and Spanish accents, the system may not always work for some.
- When navigating through an automated system such as voice mail, or when sending a page, at the end of speaking the digit string, make sure to say "Send."
- Storing names in the phonebook when the vehicle is not in motion is recommended.
- It is not recommended to store similar sounding names in the UConnect® phonebook.
- Phonebook (Downloaded and UConnect® Local) name recognition rate is optimized when the entries are not similar.
- You can say "O" (letter "O") for "0" (zero). "800" must be spoken "eight-zero-zero."
- Even though international dialing for most number combinations is supported, some shortcut dialing number combinations may not be supported.
- In a convertible vehicle, system performance may be compromised with the convertible top down.

### Far End Audio Performance

- Audio quality is maximized under:
  - low-to-medium blower setting,
  - low-to-medium vehicle speed,
  - low road noise,
  - smooth road surface,
  - fully closed windows,
  - dry weather conditions, and
  - operation from the driver's seat.
- Performance, such as audio clarity, echo, and loudness to a large degree rely on the phone and network, and not the UConnect® system.

- Echo at the far end can sometimes be reduced by lowering the in-vehicle audio volume.
- In a convertible vehicle, system performance may be compromised with the convertible top down.

### Bluetooth® Communication Link

Cellular phones have been found to lose connection to the UConnect® system. When this happens, the connection can generally be re-established by switching the phone off/on. Your cellular phone is recommended to remain in Bluetooth® ON mode.

### Power-Up

After switching the ignition key from OFF to either the ON or ACC position, or after a language change, you must wait at least five seconds prior to using the system.

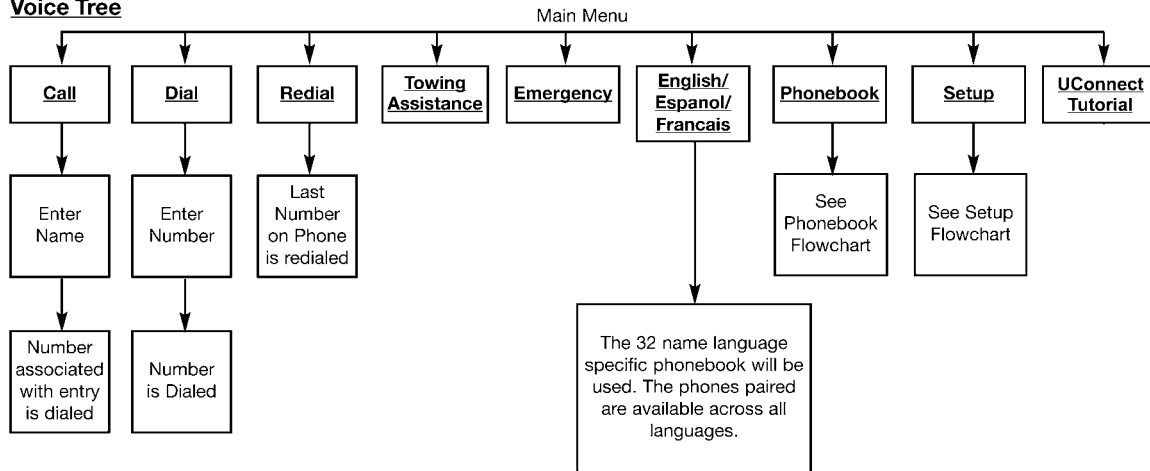
**Voice Tree**

**Note:** Available Voice commands are shown in bold face and are underlined.

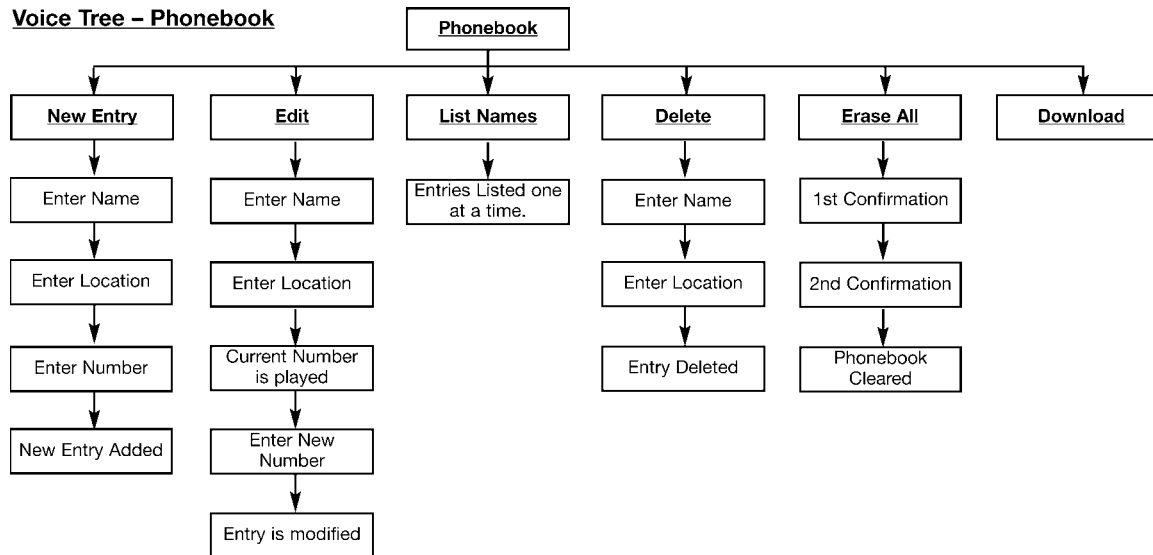
**Voice Tree - Phonebook**

**Note:** Available Voice commands are shown in bold face and are underlined.

81c6bf80

## Voice Tree – Setup

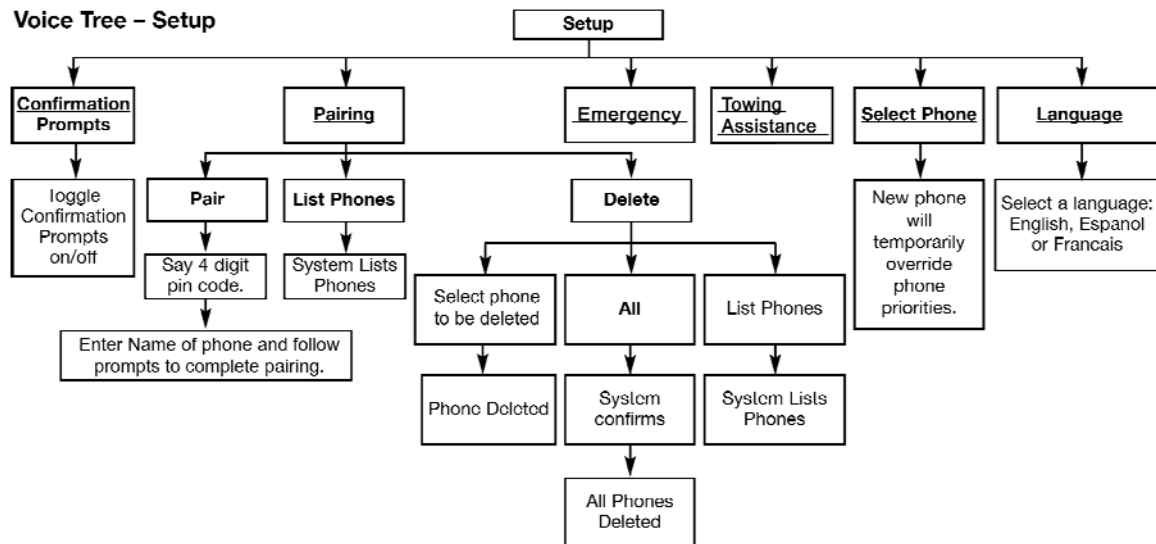

**Note:** Available Voice commands are shown in bold face and are underlined.

030605540

Voice Commands	
Primary	Alternate(s)
zero	
one	
two	
three	
four	
five	
six	
seven	
eight	
nine	
star (*)	
plus (+)	
pound (#)	
add location	
all	

Voice Commands	
Primary	Alternate(s)
call	
cancel	
confirmation prompts	
continue	
delete	
dial	
download	
edit	
emergency	
English	
erase all	
Espanol	
Francais	
help	
home	

Voice Commands	
Primary	Alternate(s)
language	
list names	
list phones	
mobile	
mute	
mute off	
new entry	
no	
pager	
pair a phone	
phone pairing	pairing
phonebook	phone book
previous	
record again	
redial	

Voice Commands	
Primary	Alternate(s)
return to main menu	return or main menu
select phone	select
send	
set up	phone settings or phone set up
towing assistance	
transfer call	
UConnect® Tutorial	
try again	
voice training	
work	
yes	



### General Information

This device complies with Part 15 of the FCC rules and RSS 210 of Industry Canada. Operation is subject to the following conditions:

- Changes or modifications not expressly approved by the party responsible for compliance could void the user's authority to operate the equipment.
- This device may not cause harmful interference.
- This device must accept any interference received, including interference that may cause undesired operation.

### VOICE RECOGNITION SYSTEM (VR) — IF EQUIPPED

#### Voice Recognition System (VR) Operation



This Voice Recognition system allows you to control your AM, FM radio, satellite radio, disc player, and a memo recorder.

**NOTE:** Take care to speak into the Voice Interface System as calmly and normally as possible. The ability of the Voice Interface System to recognize user voice commands may be negatively affected by rapid speaking or a raised voice level.

#### **WARNING!**

**Any voice commanded system should be used only in safe driving conditions and all attention should be kept on the roadway ahead. Failure to do so may result in an accident causing serious injury or death.**

When you press the VR hard-key, you will hear a beep. The beep is your signal to give a command.

**NOTE:** If you do not say a command within a few seconds, the system will present you with a list of options.

If you ever wish to interrupt the system while it lists options, press the VR hard-key, listen for the beep, and say your command.

Pressing the VR hard-key while the system is speaking is known as “barging in.” The system will be interrupted and after the beep you can add or change commands. This will become helpful once you start to learn the options.

**NOTE:** At any time, you can say the words “Cancel”, “Help”, or “Main Menu”.

These commands are universal and can be used from any menu. All other commands can be used depending upon the active application.

For example, if you are in the disc menu and you are listening to FM radio, you can speak commands from the disc menu or from the FM radio menu.

When using this system, you should speak clearly and at a normal speaking volume.

The system will best recognize your speech if the windows are closed, and the heater/air-conditioning fan is set to low.

At any point, if the system does not recognize one of your commands, you will be prompted to repeat it.

To hear the first available Menu, press the VR hard-key and say “Help” or “Main Menu”.

## Commands

The Voice Recognition system understands two types of commands. Universal commands are available at all times. Local commands are available if the supported radio mode is active.

## Changing the Volume

1. Start a dialogue by pressing the VR hard-key.
2. Say a command (e.g., "Help").
3. Use the ON/OFF VOLUME rotary knob to adjust the volume to a comfortable level while the Voice Recognition system is speaking. Please note the volume setting for VR is different than the audio system.

## Main Menu

Start a dialogue by pressing the VR hard-key. You may say "Main Menu" to switch to the main menu.

In this mode, you can say the following commands:

- "Radio" (to switch to the radio mode)
- "Disc" (to switch to the disc mode)
- "Memo" (to switch to the memo recorder)
- "System Setup" (to switch to system setup)

**Radio AM (or Radio Long Wave or Radio Medium Wave — If Equipped)**

To switch to the AM band say “AM” or “Radio AM”. In this mode, you may say the following commands:

- “Frequency” (to change the frequency)
- “Next Station” (to select the next station)
- “Previous Station” (to select the previous station)
- “Radio Menu” (to switch to the radio menu)
- “Main Menu” (to switch to the main menu)

**Radio FM**

To switch to the FM band say “FM” or “Radio FM”. In this mode, you may say the following commands:

- “Frequency” (to change the frequency)
- “Next Station” (to select the next station)
- “Previous Station” (to select the previous station)

- “Radio Menu” (to switch to the radio menu)
- “Main Menu” (to switch to the main menu)

**Satellite Radio**

To switch to satellite radio mode say “Sat” or “Satellite Radio”. In this mode, you may say the following commands:

- “Channel Number” (to change the channel by its spoken number)
- “Next Channel” (to select the next channel)
- “Previous Channel” (to select the previous channel)
- “List Channel” (to hear a list of available channels)
- “Select Name” (to say the name of a channel)
- “Radio Menu” (to switch to the radio menu)
- “Main Menu” (to switch to the main menu)

## Disc

To switch to the disc mode say “Disc”. In this mode, you may say the following commands:

- “Track” (#) (to change the track)
- “Next Track” (to play the next track)
- “Previous Track” (to play the previous track)
- “Main Menu” (to switch to the main menu)

## Memo

To switch to the voice recorder mode say “Memo”. In this mode, you may say the following commands:

- “New Memo” (to record a new memo) — During the recording you may press the VR hard-key to stop recording. You proceed by saying one of the following commands:
  - “Save” (to save the memo)

- “Continue” (to continue recording)
- “Delete” (to delete the recording)
- “Play Memos” (to play previously recorded memos)
  - During the playback you may press the VR hard-key to stop playing memos. You proceed by saying one of the following commands:
    - “Repeat” (to repeat a memo)
    - “Next” (to play the next memo)
    - “Previous” (to play the previous memo)
    - “Delete” (to delete a memo)
- “Delete All” (to delete all memos)

## System Setup

To switch to system setup say “Setup”. In this mode, you may say the following commands:

- “Language English”
- “Language French”
- “Language Spanish”
- “Tutorial”
- “Voice Training”

**NOTE:** Keep in mind that you have to press the VR hard-key first and wait for the beep before speaking the “Barge In” commands.

## Voice Training

For users experiencing difficulty with the system recognizing their voice commands or numbers, the UConnect® system Voice Training feature may be used.

1. Press the VR hard-key, say “System Setup” and once you are in that menu then say “Voice Training.” This will train your own voice to the system and will improve recognition.
2. Repeat the words and phrases when prompted by the UConnect® System. For best results, the Voice Training session should be completed when the vehicle is parked, engine running, all windows closed, and the blower fan switched off. This procedure may be repeated with a new user. The system will adapt to the last trained voice only.

## SEATS

### Manual Front Seat Adjustment

The manual seat adjustment bar is at the front of the seat, near the floor. Pull the bar upward to move the seat forward or rearward. Release the bar once the seat is in the position desired. Then, using body pressure, move forward and rearward on the seat to be sure that the seat adjusters have latched.

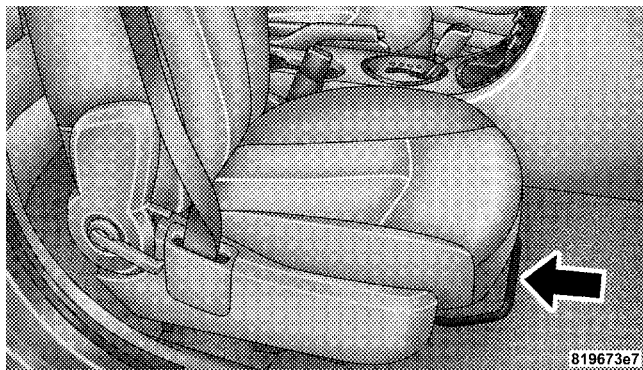

Manual Seat Adjusting Bar

**WARNING!**

Adjusting a seat while the vehicle is moving is dangerous. The sudden movement of the seat could cause you to lose control. The seat belt might not be properly adjusted and you could be injured. Adjust the seat only while the vehicle is parked.

**Driver Seat Manual Height Adjuster — If Equipped**

A lever style height adjustment feature enhances comfort for petite as well as tall drivers. A lever with a ratcheting mechanism, located on the outboard side of the seat, raises and lowers it. Total travel is 2.2 in (56 mm).

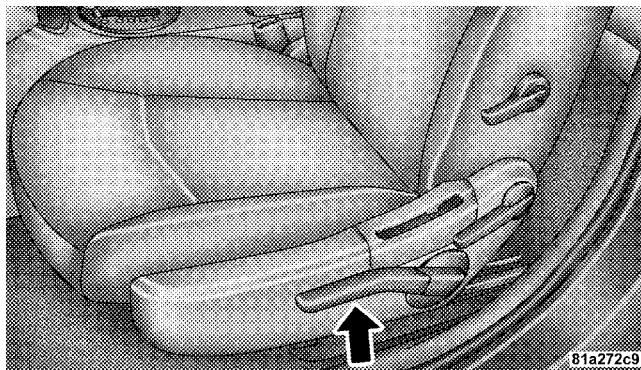

**Manual Seat Height Adjustment Lever**



## Reclining Bucket Seats

The recliner control is on the side of the seat. To recline, lean forward slightly before lifting the lever, then lean back to the desired position and release the lever. Lean forward and lift the lever to return the seatback to its normal position.

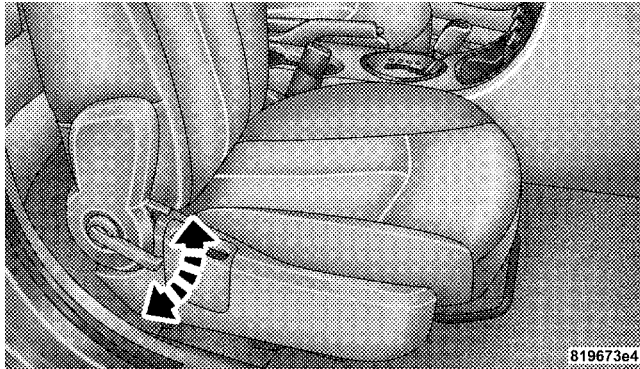

Seatback Adjustment

### WARNING!

- **Adjusting a seat while the vehicle is moving is dangerous.** The sudden movement of the seat could cause you to lose control. The seat belt might not be properly adjusted and you could be injured. Adjust the seat only while the vehicle is parked.
- **Do not ride with the seatback reclined so that the shoulder belt is no longer resting against your chest.** In a collision you could slide under the seat belt and be seriously or even fatally injured. Use the recliner only when the vehicle is parked.

### Lumbar Support — If Equipped

This feature allows you to increase or decrease the amount of lumbar support. The control lever is located on the outboard side of the driver's seatback. Turn the control lever downward to increase and upward to decrease the desired amount of lumbar support.

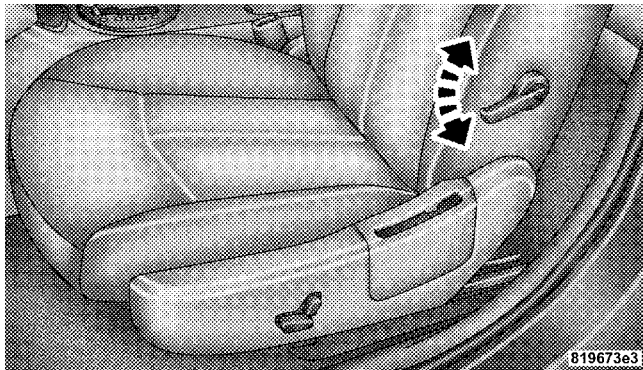

Lumbar Support

### Power Seats — If Equipped

The power seat switches are on the outboard side of the seat near the floor. Use the front switch to move the seat up, down, forward, rearward, or to tilt the seat. The rear switch controls the seatback recliner.

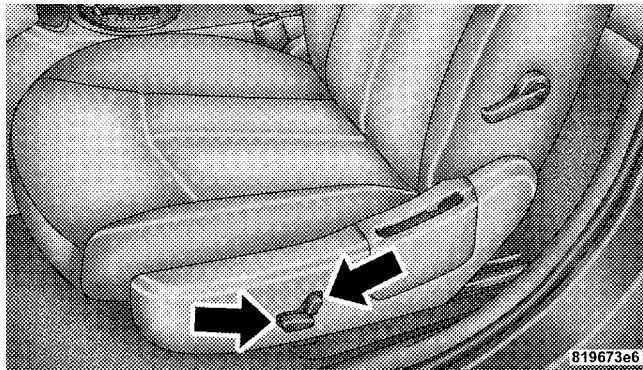

Power Seat Switches

**CAUTION!**

Do not place any article under a power seat as it may cause damage to the seat controls.

**WARNING!**

- Adjusting a seat while the vehicle is moving is dangerous. The sudden movement of the seat could cause you to lose control. The seat belt might not be properly adjusted and you could be injured. Adjust the seat only while the vehicle is parked.
- Do not ride with the seatback reclined so that the shoulder belt is no longer resting against your chest. In a collision you could slide under the seat belt and be seriously or even fatally injured. Use the recliner only when the vehicle is parked.

**Adjustable Head Restraints**

Head restraints can reduce the risk of whiplash injury in the event of impact from the rear. Adjust the restraints so that the upper edge is as high as practical. To raise, pull up on the head restraint. To lower, depress the button on the post guide and push down on the head restraint.

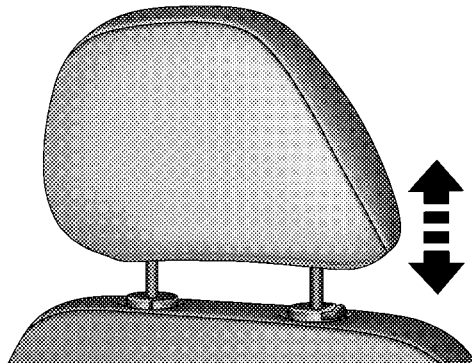
**3**

81b7959a

**Adjustable Head Restraint**

### Heated Seats — If Equipped

This feature heats leather or cloth front driver and passenger seats. The switches for the heated seats are located in the center console above the climate controls.

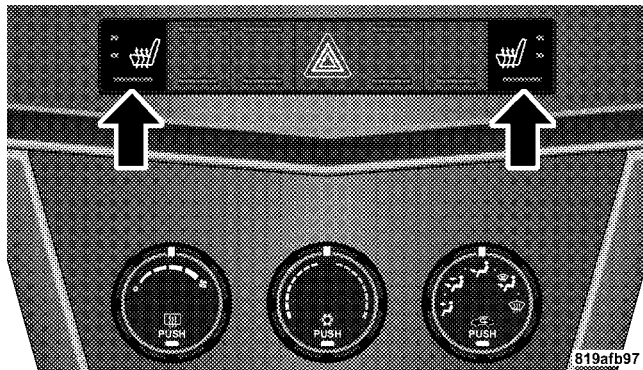

Heated Seat Switches

Press the switch once to choose High (two lights), press it a second time to choose Low (one light), press it a third time to turn the heater Off (no lights).

#### WARNING!

Persons who are unable to feel pain to the skin because of advanced age, chronic illness, diabetes, spinal cord injury, medication, alcohol use, exhaustion or other physical condition must exercise care when using the seat heater. It may cause burns even at low temperatures, especially if used for long periods of time. Do not place anything on the seat that insulates against heat, such as a blanket or cushion. This may cause the seat heater to overheat.

### Fold Flat Passenger Seat Back

The recline handle on the front passenger seat also releases the seatback to fold forward.

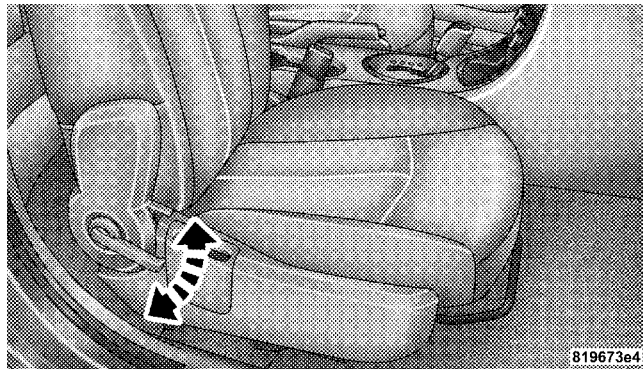

Seatback Adjustment

The hard seatback features a work surface and a molded rim for retaining items stored on the seatback panel.

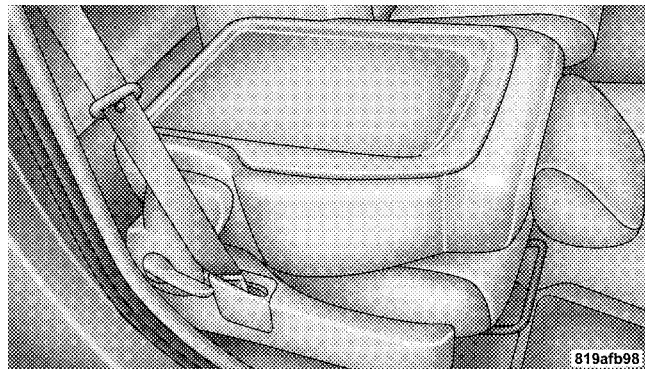

Fold Flat Front Passenger Seat



### Folding Rear Seat

To provide additional storage area, the rear seatback can be folded forward. Pull on the loops shown in the picture to fold down either or both seatbacks.

When returning the rear seatback to the upright position, be sure the seatback is latched.

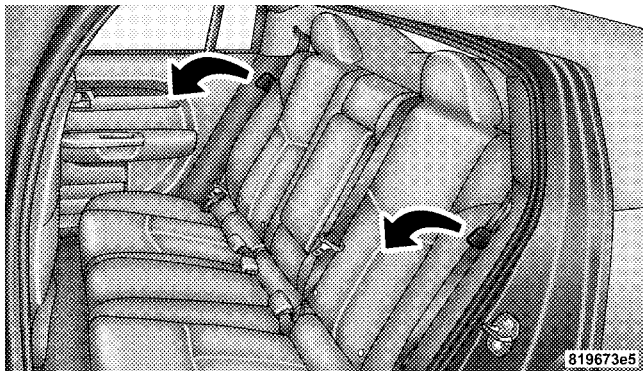

Folding Rear Seats

### WARNING!

The rear cargo area of the vehicle (with the rear seatbacks in the locked-up or folded down position) should not be used as a play area by children. They could be seriously injured in an accident. Children should be seated and using the proper restraint system.

### Folding Rear Seat Center Armrest

The rear seat is equipped with a folding armrest with cupholders.

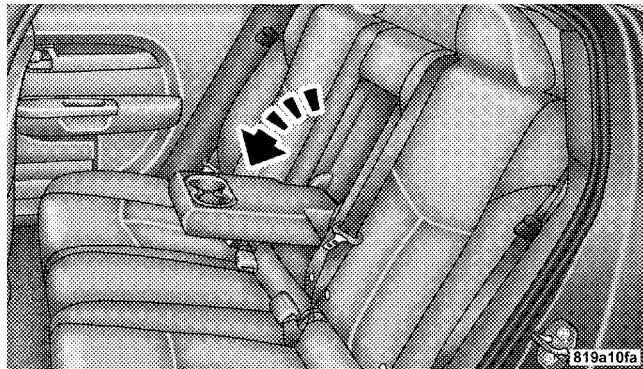

Folding Rear Seat Armrest

### TO OPEN AND CLOSE THE HOOD

To open the hood, two latches must be released.

1. Pull the hood release lever located under the left side of the instrument panel.

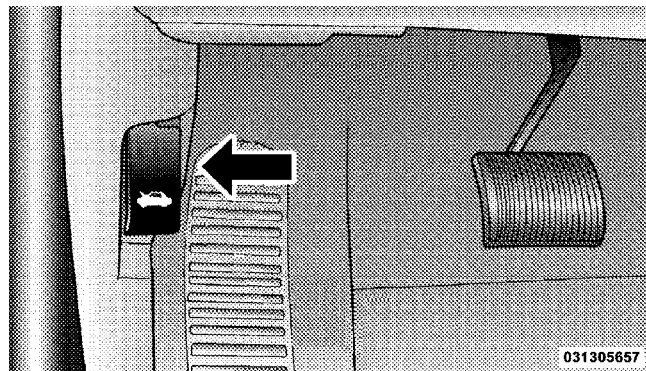

Hood Release Lever

2. Then lift the secondary latch located under the front edge of the hood, near the center and raise the hood.

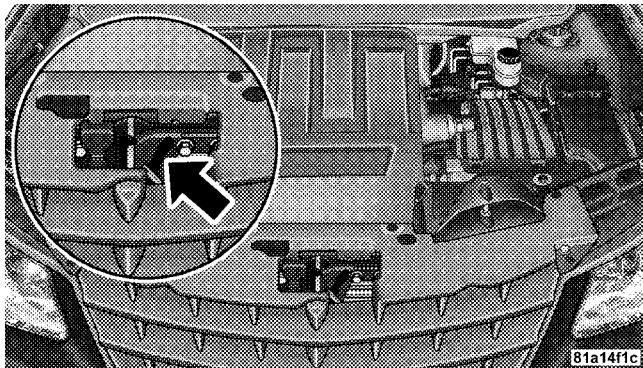

#### Hood Safety Catch

Use the hood prop rod to secure the hood in the open position. Place the upper end of the prop rod in the hole on the left underside of the hood.

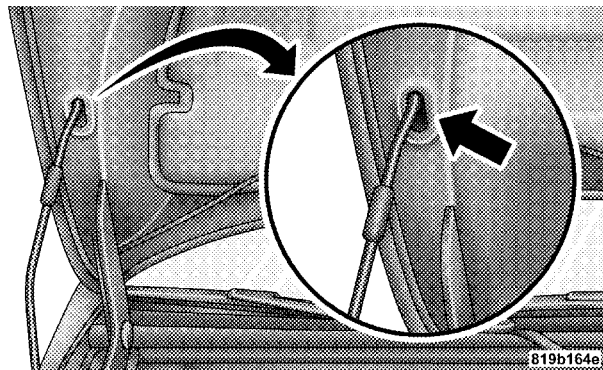

#### Hood Prop Rod Hole Location

Before closing the hood, make sure to stow the prop rod in its proper location. To prevent possible damage, do not slam the hood to close it. Use a firm downward push at the center of the hood to ensure that both latches engage.



**WARNING!**

If the hood is not fully latched it could fly up when the vehicle is moving and block your forward vision. You could have a collision. Be sure all hood latches are fully latched before driving.

**LIGHTS****Map/Reading/Interior Lights**

These lights are mounted between the sun visors above the rearview mirror. Each light can be turned on by pressing the barrel. Press the barrel a second time to turn the light off. Both of these lights can swivel so that the light can be aimed at a specific spot, if desired. The lights will remain on until the switch is pressed a second time, so be sure they have been turned off before leaving the vehicle. They will not turn off automatically. Interior

lighting also comes on when a door is opened or the dimmer control is turned fully upward, past the second detent.

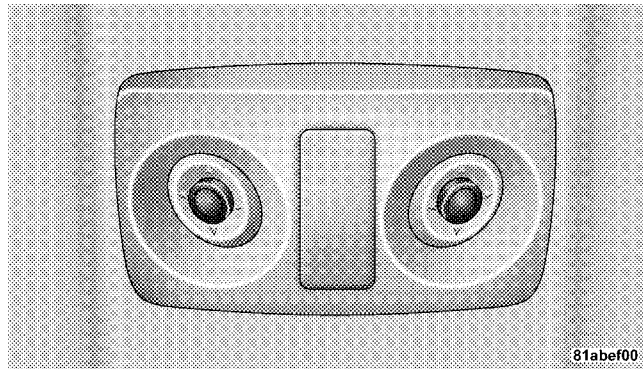
**Interior Dome Lamp**

There is a second light located midway back in the headliner.

To protect the battery, the interior lights will turn off automatically 10 minutes after the ignition switch is moved to the LOCK position. This will occur if the interior lights were switched on manually or are on because a door is open. To restore interior light operation, either turn the ignition switch ON or cycle the light switch.

### Headlights, Parking Lights and Instrument Panel Lights

Turn the end of the multifunction lever to the first detent for parking light operation. Turn to the second detent for headlight operation. Turn to the third detent AUTO headlight operation (if equipped).

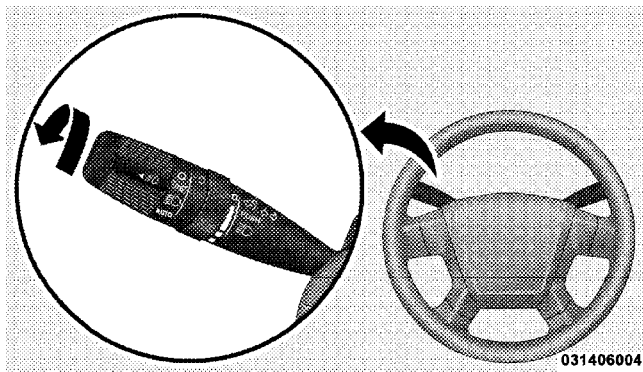

Headlight Switch

To change the brightness of the instrument panel lights, rotate the center portion of the multifunction lever up or down.

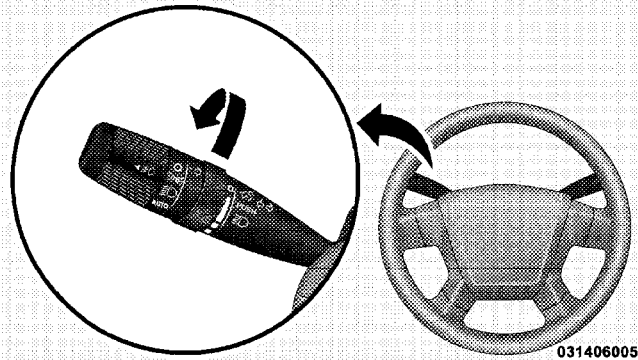

Dimmer Control

### Automatic Headlight System — If Equipped

Turning the end of the multifunction lever to the third detent (AUTO), will activate the automatic headlight system.

With the engine running and the multifunction lever in the AUTO position, the headlights will turn on and turn off based on the surrounding light levels.

3

### Headlight Time Delay

There is also a feature that delays turning off the vehicle lights for 30, 60, or 90 seconds after the ignition switch is turned OFF. To activate the headlight delay, the multifunction lever must be rotated to the off position after the ignition switch is turned OFF. Only the headlights will illuminate during this time. Refer to “Electronic Vehicle Information Center (EVIC)” under “Customer-Programmable Features” in Section 4 to turn this feature “On/Off” or set the time interval.

### **Flash-To-Pass**

You can signal another vehicle with your headlights by lightly pulling the multifunction lever toward you. This will cause the headlights to turn on at high beam and remain on until the lever is released.

**NOTE:** If the multifunction lever is held in the flash-to-pass position for more than 15 seconds, the high beams will shut off. If this occurs, wait 30 seconds for the next flash-to-pass operation.

### **Daytime Running Lights (DRL) — If Equipped**

The high beam lights will come on as DRL at DRL intensity (lower), whenever the ignition is ON, the engine is running, the headlight switch is off, the parking brake is off, the turn signal is off, and the shift lever is in any position except PARK.

**NOTE:** On this vehicle, the DRL will automatically turn off when the turn signal is in operation and automatically turn back on when the turn signal is not operating.

### **Lights On Reminder**

If the headlights or parking lights are on after the ignition is turned OFF, a chime will sound to alert the driver when the driver's door is opened.

### **Fog Lights — If Equipped**

 The front fog light switch is on the multifunction lever. To activate the front fog lights, turn on the parking lights or the low beam headlights and pull out the end of the multifunction lever.

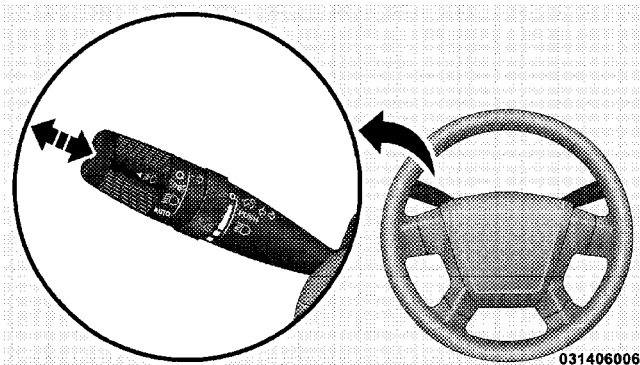

031406006

### Front Fog Light Control

**NOTE:** The front fog lights will only operate with the headlights on low beam. Selecting high beam headlights will turn off the front fog lights.

### Turn Signals

Move the multifunction lever up or down and the arrows on each side of the instrument cluster flash to show proper operation of the front and rear turn signal lights. You can signal a lane change by moving the lever partially up or down without moving beyond the detent.

3

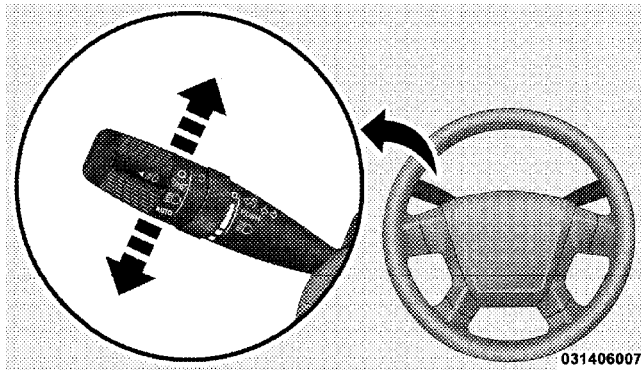

031406007

### Turn Signal Control

If either light remains on and does not flash, or there is a very fast flash rate, check for a defective outside light bulb. If an indicator fails to light when the lever is moved, it would suggest that the fuse or indicator bulb is defective.

### Turn Signal Auto-Mode

You can signal a lane change by moving the lever partially upward or downward without moving beyond the detent. The turn signal will automatically flash three times, regardless of how long the lever is held.

### High Beam/Low Beam Select Switch

Push the multifunction lever away from you to switch the headlights to high beam. Pull the lever toward you, to switch the headlights back to low beam.

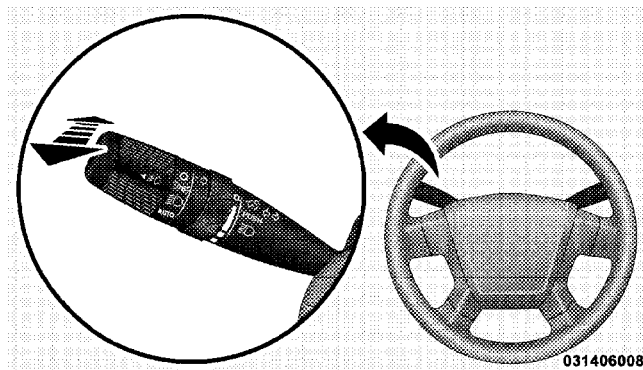

High Beam/Low Beam Select

## WINDSHIELD WIPERS AND WASHERS



The wipers and washers are operated by a switch on the control lever. The lever is located on the right side of the steering column.

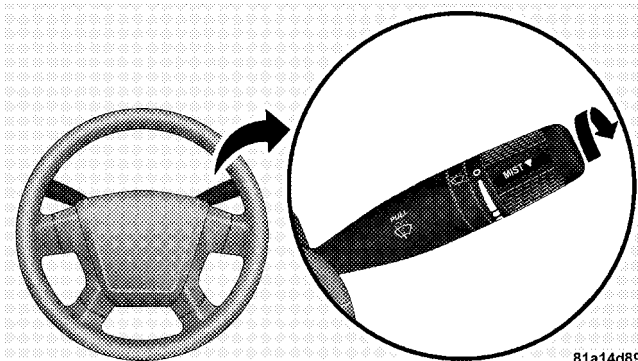

81a14d89

Windshield Wiper/Washer Lever

Rotate the end of the lever to the first detent past the intermittent settings for low speed wiper operation, or to the second detent past the intermittent settings for high speed wiper operation.

**NOTE:** The wipers will automatically return to the park position if you turn the ignition switch OFF while they are operating. The wipers will resume operation when you turn the ignition switch to the ON position again.

3

### CAUTION!

- Turn the windshield wipers off when driving through an automatic car wash. Damage to the windshield wipers may result if the wiper control is left in any position other than off.

*(Continued)*

**CAUTION! (Continued)**

- Always remove any buildup of snow that prevents the windshield wiper blades from returning to the off position. If the windshield wiper control is turned off and the blades cannot return to the off position, damage to the wiper motor may occur.

**Intermittent Wiper System**

Use the intermittent wiper system when weather conditions make a single wiping cycle with a variable pause between cycles desirable. Rotate the end of the windshield wiper/washer control lever to the first detent, and then turn the end of the lever to select the desired delay interval. There are five delay settings, which allow you to regulate the wipe interval from a minimum of one cycle every second to a maximum of approximately 18 seconds between cycles.

For vehicles equipped with the Speed Sensitive Intermittent Wiper System, the wiper delay times depend on vehicle speed. If the vehicle is moving less than 10 mph (16 km/h), delay times will double.

**WARNING!**

Sudden loss of visibility through the windshield could lead to an accident. You might not see other vehicles or other obstacles. To avoid sudden icing of the windshield during freezing weather, warm the windshield with defroster before and during windshield washer use.



### Mist Feature

Push down on the wiper control lever to activate a single wipe to clear the windshield of road mist or spray from a passing vehicle. As long as the lever is held down, the wipers will continue to operate.

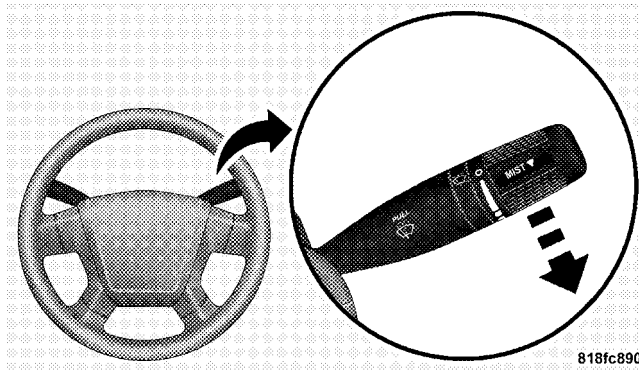

818fc890

Mist Control

### Headlights With Wipers Feature (Available With Auto Headlights Only)

When this feature is active, the headlights will turn on approximately 10 seconds after the wipers are turned on if the multifunction lever (on the left side of the steering column) is placed in the A (AUTO) position. In addition, the headlights will turn off when the wipers are turned off if they were turned on by this feature.

The headlights with wipers feature can be turned on or off through the Electronic Vehicle Information Center (EVIC) — if equipped. For details, refer to “Headlights with Wipers,” under “Personal Settings (Customer-Programmable Features)” under “Electronic Vehicle Information Center” in Section 4 of this manual.

### Windshield Washers

To use the washer, pull the windshield wiper/washer control lever toward you and hold it for as long as washer spray is desired.

If you activate the washer while the wiper control is in the delay range, the wipers will operate in low speed for two wipe cycles after releasing the lever and then resume the intermittent interval previously selected.

If you activate the washer while the wiper control is in the off position, the wipers will operate for two wipe cycles and then turn off.

### TILT/TELESCOPING STEERING COLUMN

This feature allows you to tilt the steering column upward or downward. It also allows you to lengthen or shorten the steering column. The tilt/telescoping control handle is located below the steering wheel at the end of the steering column.

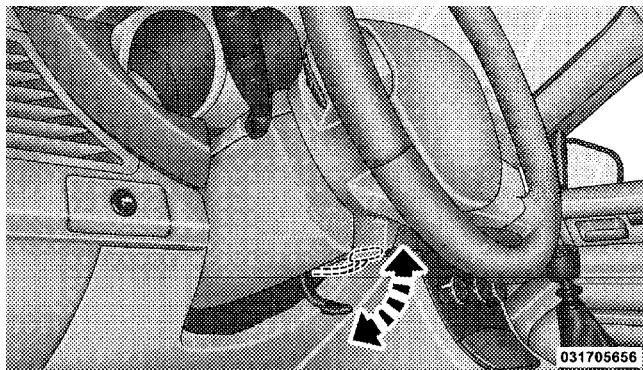

### Tilt/Telescoping Steering Wheel Lock

To unlock the steering column, pull the control handle outward. To tilt the steering column, move the steering wheel upward or downward as desired. To lengthen or shorten the steering column, pull the steering wheel outward or push it inward as desired. To lock the steering column in position, push the control handle inward until fully engaged.

**WARNING!**

Do not adjust the steering wheel while driving. The telescoping adjustment must be locked while driving. Adjusting the steering wheel while driving or driving without the telescoping adjustment locked could cause the driver to lose control of the vehicle.

**ELECTRONIC SPEED CONTROL — IF EQUIPPED**

When engaged, the Electronic Speed Control takes over the accelerator operation at speeds greater than 25 mph (40 km/h).

The Electronic Speed Control lever is located on the right side of the steering wheel.



Electronic Speed Control Lever

81bc4c2c

### To Activate



Push and release the ON/OFF button located on the end of the Electronic Speed Control lever. The CRUISE indicator in the instrument cluster will illuminate. To turn the system off, push and release the ON/OFF button a second time. The CRUISE indicator will turn off. Be sure to turn the system off when not in use.

**NOTE:** The Electronic Speed Control system will automatically turn off when the ignition is turned OFF.

### WARNING!

**Leaving the Electronic Speed Control when not in use is dangerous. You could accidentally set the system or cause it to go faster than you want. You could lose control and have an accident. Always leave the system off when you are not using it.**

### To Set At A Desired Speed

When the vehicle reaches the speed desired, press down on the lever and release SET DECEL. Release the accelerator and the vehicle will operate at the selected speed.

#### NOTE:

- The vehicle must be traveling at least 25 mph (40 km/h) for the Electronic Speed Control to set.
- The vehicle should be traveling at a steady speed and on level ground before pressing the lever SET DECEL.

### To Deactivate

A soft tap on the brake pedal, or pulling the Electronic Speed Control lever toward you (CANCEL), or normal brake pressure while slowing the vehicle will deactivate the Electronic Speed Control without erasing the set speed from memory. Pressing the ON/OFF button or turning off the ignition erases the set speed from memory.

### To Resume Speed

If you deactivated the Electronic Speed Control without erasing the set speed from memory and your vehicle speed is above 20 mph (32 km/h) you can resume the previous set speed. To do so, push the lever up and release RESUME ACCEL, and then remove your foot from the accelerator pedal.

### To Vary The Speed Setting

When the Electronic Speed Control is set, you can increase speed by pushing up and holding the lever RESUME ACCEL. Release the lever when the desired speed is reached, and the new set speed will be established.

Tapping RESUME ACCEL once will result in a 1 mph (2 km/h) speed increase. Each time the lever is tapped, speed increases so that tapping the lever three times will increase speed by 3 mph (5 km/h), etc.

To decrease speed while the Electronic Speed Control is set, push down and hold the lever SET DECEL. Release the lever when the desired speed is reached, and the new set speed will be established.

Tapping the SET DECEL lever once will result in a 1 mph (2 km/h) speed decrease. Each time the button is tapped, speed decreases.

### WARNING!

**Electronic Speed Control can be dangerous where the system cannot maintain a constant speed. Your vehicle could go too fast for the conditions, and you could lose control. An accident could be the result. Don't use Electronic Speed Control in heavy traffic or on roads that are winding, icy, snow-covered, or slippery.**

### To Accelerate For Passing

Depress the accelerator as you would normally. When the pedal is released, the vehicle will return to the set speed.

### Using Electronic Speed Control On Hills

**NOTE:** The Electronic Speed Control system maintains speed up and down hills. A slight speed change on moderate hills is normal.

On steep hills, a greater speed loss or gain may occur so it may be preferable to drive without Electronic Speed Control.

### GARAGE DOOR OPENER — IF EQUIPPED

HomeLink® replaces up to three remote controls (hand-held transmitters) that operate devices such as garage door openers, motorized gates, lighting, or home security systems. The HomeLink® unit operates off your vehicle's battery.

The HomeLink® buttons that are located in the headliner or sun visor designate the three different HomeLink® channels.

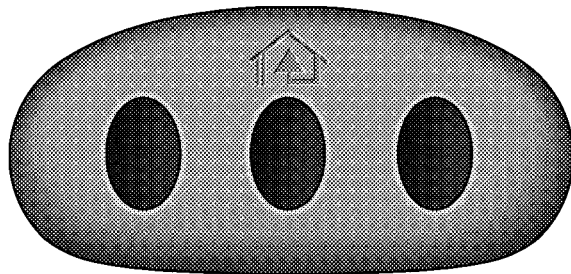

81cb44fe

### HomeLink® Buttons

**NOTE:** HomeLink® is disabled when the Vehicle Security Alarm is active.

**WARNING!**

- Your motorized door or gate will open and close while you are training the universal transceiver. Do not train the transceiver if people or pets are in the path of the door or gate. Only use this transceiver with a garage door opener that has a “stop and reverse” feature as required by Federal safety standards. This includes most garage door opener models manufactured after 1982. Do not use a garage door opener without these safety features. Call toll-free 1-800-355-3515 or, on the Internet at [www.HomeLink.com](http://www.HomeLink.com) for safety information or assistance.
- Vehicle exhaust contains carbon monoxide, a dangerous gas. Do not run your vehicle in the garage while training the transceiver. Exhaust gas can cause serious injury or death.

**Programming Homelink®****Before You Begin**

If you have not trained any of the HomeLink® buttons, erase all channels before you begin training.

To do this, press and hold the two outside buttons for up to 20 seconds until the red indicator flashes.

It is recommended that a new battery be placed in the handheld transmitter of the device being programmed to HomeLink® for more efficient training and accurate transmission of the radio-frequency signal.

Your vehicle should be parked outside of the garage when programming.

## Begin Programming

1. Turn the ignition switch to the ON/RUN position.
2. Hold the battery side of the handheld transmitter away from the HomeLink® button you wish to program.

Place the handheld transmitter 1 to 3 in (3 to 8 cm) away from the HomeLink® button you wish to program while keeping the indicator light in view.

3. Simultaneously press and hold both the chosen HomeLink® button and the handheld transmitter button until the HomeLink® indicator changes from a slow to a rapidly blinking light, then release both the HomeLink® and handheld transmitter buttons.

Watch for the HomeLink® indicator to change flash rates. When it changes, it is programmed. It may take up to 30 seconds, or longer in rare cases. The garage door may open and close while you train.

## NOTE:

- Some gate operators and garage door openers may require you to replace Step 3 with procedures noted in the “Gate Operator/Canadian Programming” section.
  - After training a HomeLink® channel, if the garage door does not operate with HomeLink® and the garage door opener was manufactured after 1995, the garage door opener may have a rolling code. If so, proceed to Step 5 “Programming A Rolling Code System.”
4. Press and hold the just-trained HomeLink® button and observe the indicator light.

If the indicator light stays on constantly, programming is complete and the garage door (or device) should activate when the HomeLink® button is pressed.



If the indicator light blinks rapidly for two seconds and then turns to a constant light, proceed to Step 5 “Programming A Rolling Code System.”

### 5. Programming A Rolling Code System

At the garage door opener motor (in the garage), locate the “Learn” or “Training” button.

This can usually be found where the hanging antenna wire is attached to the garage door opener motor. It is NOT the button normally used to open and close the door.

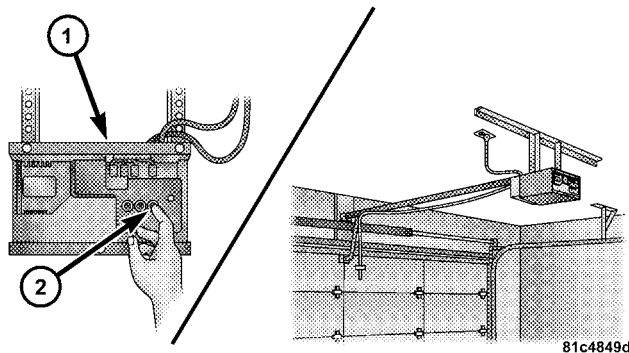

81c4849d

### Training The Garage Door Opener

- 1 — Door Opener
- 2 — Training Button

6. Firmly press and release the “Learn” or “Training” button. The name and color of the button may vary by manufacturer.

**NOTE:** There are 30 seconds in which to initiate the next step after the “Learn” button has been pressed.

7. Return to the vehicle and press the programmed HomeLink® button twice (holding the button for two seconds each time). If the device is plugged in and activates, programming is complete.

If the device does not activate, press the button a third time (for two seconds) to complete the training.

If you have any problems, or require assistance, please call toll-free 1-800-355-3515 or, on the Internet at [www.HomeLink.com](http://www.HomeLink.com) for information or assistance.

To program the remaining two HomeLink® buttons, repeat each step for each remaining button. **DO NOT** erase the channels.

### Using HomeLink®

To operate, simply press and release the programmed HomeLink® button. Activation will now occur for the trained device (i.e., garage door opener, gate operator, security system, entry door lock, home/office lighting, etc. The handheld transmitter of the device may also be used at any time.

### Reprogramming a Single Homelink® Button

To reprogram a channel that has been previously trained, follow these steps:

1. Turn the ignition switch to the ON/RUN position.
2. Press and hold the desired HomeLink® button until the indicator light begins to flash after 20 seconds. **Do not release the button.**
3. **Without releasing the button,** proceed with Programming Homelink® Step 2 and follow all remaining steps.

### Gate Operator/Canadian Programming

Canadian radio frequency laws require transmitter signals to time-out (or quit) after several seconds of transmission – which may not be long enough for HomeLink® to pick up the signal during programming. Similar to this Canadian law, some U.S. gate operators are designed to time-out in the same manner.

It may be helpful to unplug the device during the cycling process to prevent possible overheating of the garage door or gate motor.

If you are having difficulties programming a garage door opener or a gate operator, replace “Programming HomeLink®” Step 3, with the following:

**3. Continue to press and hold the HomeLink® button while you press and release - every two seconds (“cycle”) your handheld transmitter until HomeLink® has successfully accepted the frequency signal. The indicator light will flash slowly and then rapidly when fully trained.**

If you unplugged the device for training, plug it back in at this time.

Then proceed with Step 4 under “Programming HomeLink®,” earlier in this section.

### Security

It is advised to erase all channels before you sell or turn in your vehicle.

To do this, press and hold the two outside buttons for 20 seconds until the red indicator flashes. Note that all channels will be erased. Individual channels cannot be erased.

The HomeLink® Universal Transceiver is disabled when the Vehicle Security Alarm is active.

### Troubleshooting Tips

If you are having trouble programming HomeLink®, here are some of the most common solutions:

- Replace the battery in the original transmitter.
- Press the “Learn” button on the Garage Door Opener to complete the training for a Rolling Code.
- Did you unplug the device for training, and remember to plug it back in?

If you have any problems, or require assistance, please call toll-free 1-800-355-3515 or, on the Internet at [www.HomeLink.com](http://www.HomeLink.com) for information or assistance.

### General Information

This device complies with FCC rules Part 15 and Industry Canada RSS-210. Operation is subject to the following two conditions:

1. This device may not cause harmful interference.
2. This device must accept any interference that may be received including interference that may cause undesired operation.

#### NOTE:

- The transmitter has been tested and it complies with FCC and IC rules. Changes or modifications not expressly approved by the party responsible for compliance could void the user’s authority to operate the device.
- The term IC before the certification/registration number only signifies that Industry Canada technical specifications were met.

## POWER SUNROOF — IF EQUIPPED

The sunroof controls are mounted between the sun visors in the Dome/Reading Lamp.

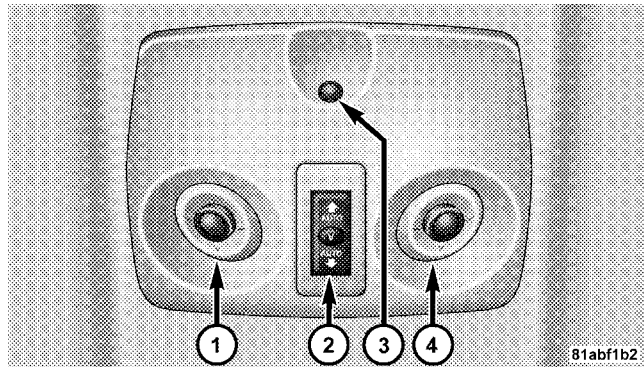

Power Sunroof Switch

- |                          |                              |
|--------------------------|------------------------------|
| 1 — Left Interior Light  | 3 — ATC Sensor (If Equipped) |
| 2 — Power Sunroof Switch | 4 — Right Interior Light     |

## WARNING!

- Never leave children in a vehicle, with the keys in the ignition switch. Occupants, particularly unattended children, can become entrapped by the power sunroof while operating the power sunroof switch. Such entrapment may result in serious injury or death.
- In an accident, there is greater risk of being thrown from a vehicle with an open sunroof. You could also be seriously injured or killed. Always fasten your seat belt properly and make sure all passengers are properly secured too.
- Do not allow small children to operate the sunroof. Never allow fingers or other body parts, or any object to project through the sunroof opening. Injury may result.

## Sunroof Operation

### Opening Sunroof Manually

Press the switch rearward and hold, and the sunroof will open automatically from any position. The sunroof will open fully, then stop automatically. During this operation, any release of the sunroof switch will stop the sunroof.

### Opening Sunroof - Express

Press the switch rearward and release, and the sunroof will open automatically from any position. The sunroof will open fully, then stop automatically. This is called Express Open. During Express Open operation, any movement of the sunroof switch will stop the sunroof.

### Closing Sunroof Manually

To close the sunroof from an open or vent position, press and **hold** the switch forward. The sunroof will close fully and stop automatically. Release the switch to stop sunroof travel at any point.

### Venting Sunroof - Express

Press and release the "V" button, and the sunroof will open to the vent position. This is called Express Vent.

### Closing Sunroof - Express

Press the switch forward and release, and the sunroof will close automatically from any position. The sunroof will close fully, then stop automatically. This is called Express Close. During Express Close operation, any movement of the sunroof switch will stop the sunroof.

### Auto Sunroof Express With Anti-Pinch Protection — If Equipped

During express closing, anytime an obstacle that restricts glass movement is detected, the motor will stop and reverse travel to avoid pinching the object.

### **Sunshade Operation**

The sunshade can be opened manually. However, the sunshade will open automatically as the sunroof opens.

**NOTE:** The sunshade cannot be closed if the sunroof is open.

### **Wind Buffeting**

Wind buffeting can be described as the perception of pressure on the ears or a helicopter-type sound in the ears. Your vehicle may exhibit wind buffeting with the windows down, or the sunroof (if so equipped) in certain open or partially open positions. This is a normal occurrence and can be minimized. If the buffeting occurs with the rear windows open, then open the front and rear windows together to minimize the buffeting. If the buffeting occurs with the sunroof open, adjust the sunroof opening to minimize the buffeting.

### **Sunroof Maintenance**

Use only a nonabrasive cleaner and a soft cloth to clean the glass panel.

### **Ignition Off Operation**

For vehicles not equipped with the Electronic Vehicle Information Center (EVIC), the power sunroof switch will remain active for 45 seconds after the ignition switch is turned OFF. Opening either front door will cancel this feature.

For vehicles equipped with the EVIC, the power sunroof switch will remain active for up to 10 minutes after the ignition switch is turned OFF. Opening either front door will cancel this feature. The time is programmable. For details, refer to “Key-Off Power Delay,” under “Personal Settings (Customer-Programmable Features)” under “Electronic Vehicle Information Center (EVIC)” in Section 4 of this manual.

## ELECTRICAL POWER OUTLETS

There are two 12-Volt electrical outlets on this vehicle. Both of the outlets are protected by a fuse.

The instrument panel power outlet, located below the climate control knobs, has power available only when the ignition is ON. This outlet will also operate a conventional cigar lighter unit.

**NOTE:** If desired, the instrument panel power outlet can be converted by your authorized dealer to provide power with the ignition switch while in the LOCK position.

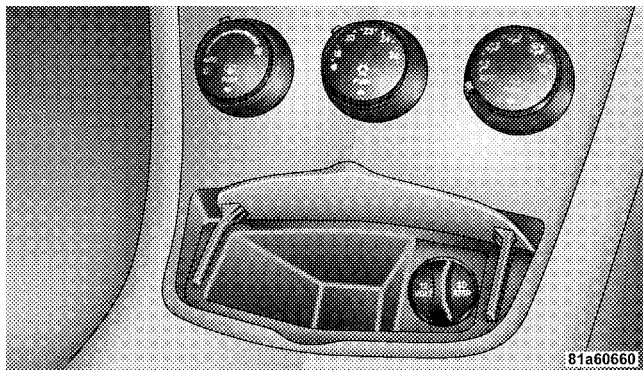

**Instrument Panel Power Outlet**



The center console power outlet is powered directly from the battery (power available at all times). Items plugged into this outlet may discharge the battery and/or prevent engine starting.

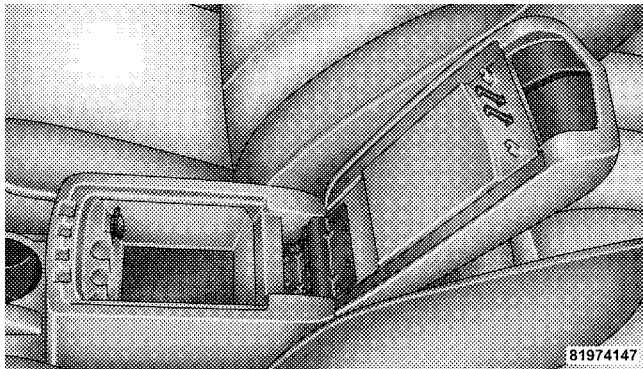

Console Interior

### WARNING!

To avoid serious injury or death:

- Do not use a three-prong adapter.
- Do not insert any objects into the receptacles.
- Do not touch with wet hands.
- Close the lid when not in use and while driving the vehicle.
- If this outlet is mishandled, it may cause an electric shock and failure.

**CAUTION!**

- Many accessories that can be plugged in draw power from the vehicle's battery, even when not in use (i.e., cellular phones, etc.). Eventually, if plugged in long enough, the vehicle's battery will discharge sufficiently to degrade battery life and/or prevent engine starting.
- Accessories that draw higher power (i.e., coolers, vacuum cleaners, lights, etc.) will degrade the battery even more quickly. Only use these intermittently and with greater caution.
- After the use of high power draw accessories, or long periods of the vehicle not being started (with accessories still plugged in), the vehicle must be driven a sufficient length of time to allow the generator to recharge the vehicle's battery.

**CIGAR LIGHTER AND ASH RECEIVER — IF EQUIPPED**

An optional ash receiver is available from your authorized dealer and will fit in the center console front cupholder.

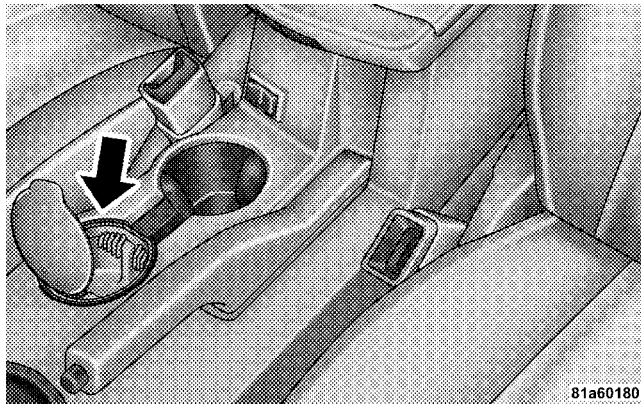

81a60180

Ash Receiver

**CAUTION!**

For vehicles equipped with the heated and cooled cupholder, locate the cup holder ash receiver in the forward cupholder.

The optional ash receiver also comes with a cigar lighter. You may use the power outlet, located in the instrument panel below the climate control knobs, or in the bottom of the console compartment, for this cigar lighter.

**CUPHOLDERS****Heated/Cooled Cupholder — If Equipped**

With this feature the rear cavity of the cupholder can keep cool beverages cool, and hot beverages hot. The rear cupholder heats to 140°F (60 °C) or cools to 35°F (1.6 °C).

The switch is located on the front of the center console and has three positions: Heat, Off, Cool.

When the unit is on and the LED is Red, the cup holder is being heated. When the LED is Blue, the cup holder is being cooled.

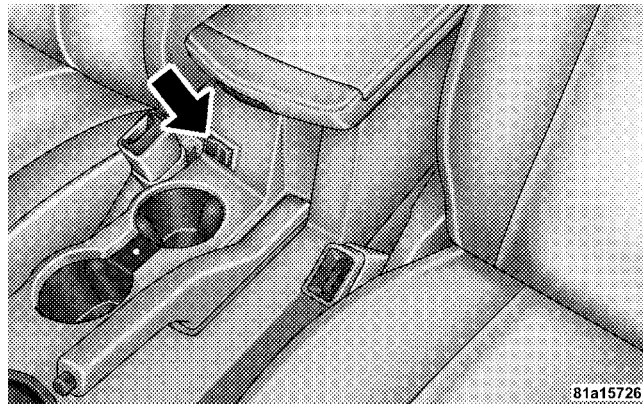

Heated or Cooled Cupholder

**CAUTION!**

Make sure the beverage container can withstand the temperatures shown above, when using the Cooled or Heated Cupholder.

**Rear Bottle Holders**

There are built-in bottle holders located in both rear door trim panels.

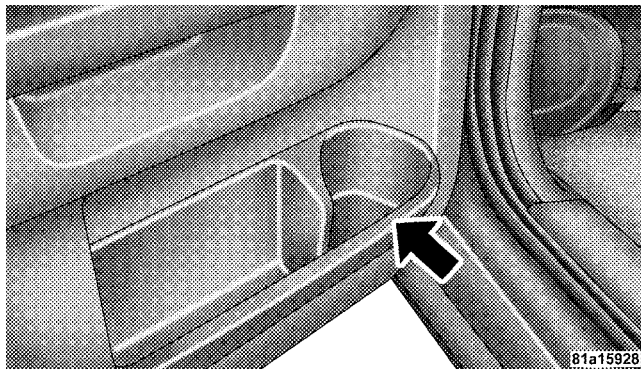

Rear Bottle Holder

**WARNING!**

If containers of hot liquid are placed in the bottle holder, they can spill when the door is closed, burning the occupants. Be careful when closing the doors to avoid injury.

## STORAGE

### Driver's Side Sunglass Holder — If Equipped

An integrated sunglass holder is located in the headliner above the sun visor. To access the sunglass holder, lower the sun visor. Small items such as toll tickets can be stored between the two straps, while sunglasses or other items can be stored above the two straps.

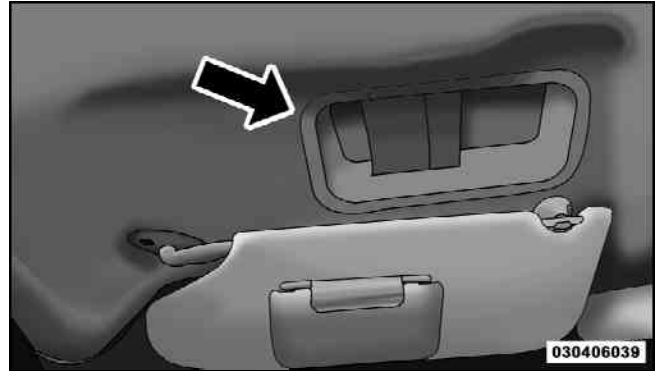

Sunglass Holder

### Cargo Area

The 60/40 split-folding rear seat provides cargo-carrying versatility. The seatbacks fold down easily by pulling nylon tabs between the seatbacks and the bolsters. When the seats are folded down, they provide a continuous, nearly flat extension of the load floor.

When the seatback is folded to the upright position, make sure it is latched by strongly pulling on the top of the seatback above the seat strap.

#### **WARNING!**

- Be certain that the seatback is securely locked into position. If the seatback is not securely locked into position, the seat will not provide the proper stability for child seats and/or passengers. An improperly latched seat could cause serious injury.

*(Continued)*

#### **WARNING! (Continued)**

- The cargo area in the rear of the vehicle (with the rear seatbacks in the locked-up or folded down position) should not be used as a play area by children when the vehicle is in motion. They could be seriously injured in an accident. Children should be seated and using the proper restraint system.
- To help protect against personal injury, passengers should not be seated in the rear cargo area. The rear cargo space is intended for load carrying purposes only, not for passengers, who should sit in seats and use seat belts.
- The weight and position of cargo and passengers can change the vehicle center of gravity and vehicle handling. To avoid loss of control resulting in personal injury, follow these guidelines for loading your vehicle:

Always place cargo evenly on the cargo floor. Put heavier objects as low and as far forward as possible.

Place as much cargo as possible in front of the rear axle. Too much weight or improperly placed weight over or behind the rear axle can cause the rear of the vehicle to sway.

Do not pile luggage or cargo higher than the top of the seatback. This could impair visibility or become a dangerous projectile in a sudden stop or collision.

### CONSOLE FEATURES

The center console armrest slides forward from design position to provide added user comfort. Two cupholders, each of which can accommodate large beverage containers. A one piece cupholder insert for both cavities can easily be removed for cleaning. The cupholders will also

accommodate large size cups and 20 oz. (.5 L) bottles. An optional removable ashtray may be located in the one cupholder.

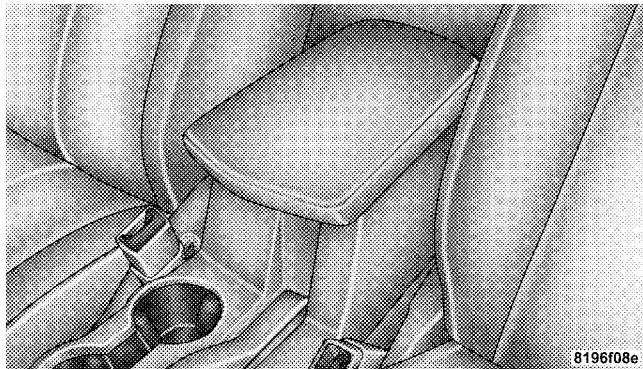

Console Features



## Dual Storage Bins

Lifting a latch at the front of the hinged armrest provides access to these storage areas.

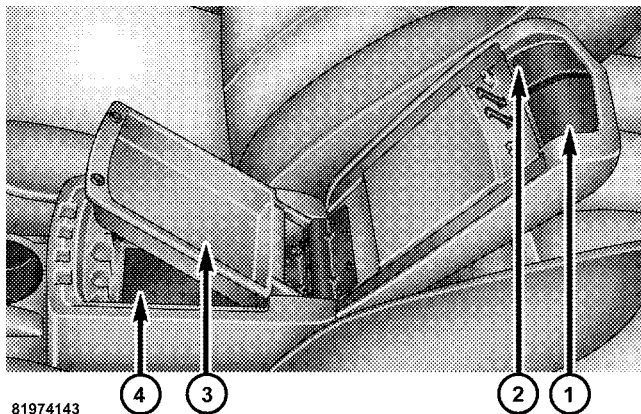

81974143

Storage Console Detail

- 1 — Release Top Compartment
- 2 — Release Bottom Compartment
- 3 — Top Compartment
- 4 — Bottom Compartment



The left latch opens to the top storage area.

The lower bin can be accessed directly, without first exposing the upper bin, by operating the right latch with the armrest down.

The first storage bin can be used to hold smaller items.

The lower storage bin includes a molded-in coin holder, room for CD's, DVD's, and a power outlet that allows a cell phone to recharge while concealed.

**NOTE:**

- A notch in the side of the console base under the armrest will also allow use of cell phone while still plugged into the power outlet and with the armrest latched down.
- The power outlet located inside the console can also energize the cigar lighter in the available Smoker's Package.

### Video Console — If Equipped

The optional VES™ (Video Entertainment System) includes the following components:

- The screen for a rear seat DVD player is stored under the armrest.
- Remote Control
- Audio/Video RCA Jacks

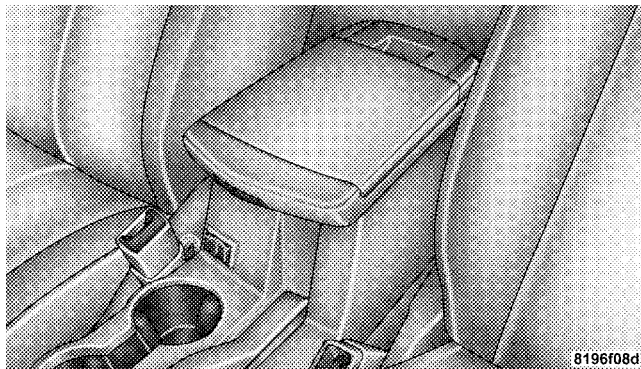

**Video Console**

Refer to, “Video Entertainment System — If Equipped,” in Section 4 of this manual, for further information.

## REAR WINDOW FEATURES

### Rear Window Defroster — If Equipped



The electric rear window defroster switch is located on the climate control. Press this button to turn on the rear window defroster and the heated side mirrors (if equipped). An LED in the button will illuminate when the rear window defroster is on. The rear window defroster automatically turns off after approximately 10 minutes of operation for the first push of the button, and will turn off after approximately five minutes for the second push of the button.

### CAUTION!

- To avoid damaging the electrical conductors of the rear window defroster, do not use scrapers, sharp instruments, or abrasive window cleaners on the interior surface of the window.
- Labels can be peeled off after soaking with warm water.



# UNDERSTANDING YOUR INSTRUMENT PANEL

## CONTENTS

---

■ Instrument Panel Features . . . . .	174	□ Personal Settings (Customer-Programmable Features) . . . . .	196
■ Instrument Cluster – Base . . . . .	175	■ Setting The Analog Clock . . . . .	199
■ Instrument Cluster – Premium . . . . .	176	■ Sales Code REQ — AM/FM Stereo Radio And 6-Disc CD/DVD Changer (MP3/WMA AUX Jack) . . . . .	199
■ Instrument Cluster Descriptions . . . . .	177	□ Operating Instructions - Radio Mode . . . . .	199
■ Electronic Vehicle Information Center (EVIC) – If Equipped . . . . .	189	□ Operation Instructions - (Disc Mode For CD And MP3/WMA Audio Play, DVD-Video) . . . . .	208
□ EVIC Displays . . . . .	191	□ Notes On Playing MP3/WMA Files . . . . .	210
□ Oil Change Required . . . . .	191		
□ Trip Functions . . . . .	192		
□ Compass Display . . . . .	194		

- List Button  
(Disc Mode For MP3/WMA Play) . . . . . 212
- Info Button  
(Disc Mode For MP3/WMA Play) . . . . . 213
- AM/FM/CD/DVD Multimedia System Radio  
(RER/REN) – If Equipped . . . . . 215
  - Operating Instructions — Voice Recognition  
System (VR) — If Equipped . . . . . 215
  - Operating Instructions — Hands-Free  
Communication (UConnect®) — If Equipped . . 215
  - Clock Setting Procedure . . . . . 216
- Sales Code RES — AM/FM Stereo Radio With  
CD Player (MP3 AUX Jack) . . . . . 218
  - Operating Instructions — Radio Mode . . . . . 218
  - Operation Instructions — CD Mode For CD  
And MP3 Audio Play . . . . . 221
  - Notes On Playing MP3 Files . . . . . 223
  - Operation Instructions - Auxiliary Mode . . . . 226
- Sales Code RES/RSC — AM/FM Stereo Radio  
With CD Player (MP3 AUX Jack) And Sirius  
Radio. . . . . 227
  - Operating Instructions — Radio Mode . . . . . 227
  - Operation Instructions — CD Mode For CD  
And MP3 Audio Play . . . . . 233
  - Notes On Playing MP3 Files . . . . . 235
  - List Button (CD Mode For MP3 Play) . . . . . 237
  - Info Button (CD Mode For MP3 Play) . . . . . 238
- Satellite Radio — If Equipped  
(REN/REQ/RER/RES/REU Radios Only). . . . . 239
  - System Activation . . . . . 239

- Electronic Serial Number/Sirius Identification Number (ESN/SID) . . . . . 239
- Selecting Satellite Mode . . . . . 240
- Satellite Antenna . . . . . 240
- Reception Quality . . . . . 241
- Operating Instructions — Satellite Mode . . . . . 241
- Operating Instructions — Hands-Free Phone (If Equipped). . . . . 244
- Operating Instructions — Video Entertainment System (VES)<sup>TM</sup> (If Equipped). . . . . 244
- Video Entertainment System (VES)<sup>TM</sup> — If Equipped . . . . . 244
- Remote Sound System Controls — If Equipped . . . . . 246

- Right-Hand Switch Functions . . . . . 247
- Left-Hand Switch Functions For Radio Operation . . . . . 247
- Left-Hand Switch Functions For Media (i.e., CD) Operation . . . . . 247
- CD/DVD Maintenance . . . . . 248
- Radio Operation And Cellular Phones . . . . . 248
- Climate Controls . . . . . 249
  - Manual Heating Ventilation And Air Conditioning (HVAC). . . . . 249
  - Automatic Temperature Control (ATC) — If Equipped. . . . . 253
  - Operating Tips . . . . . 259

## INSTRUMENT PANEL FEATURES

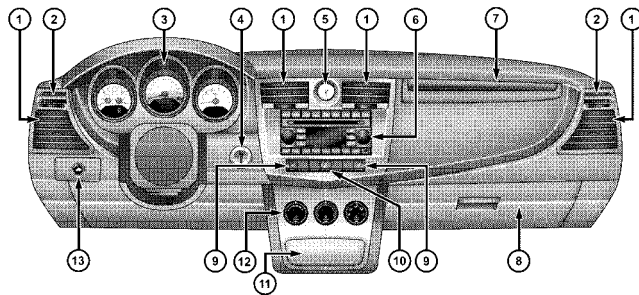

81a15e80

- 1 - Air Outlet
- 2 - Side Window Demister Outlet
- 3 - Instrument Cluster
- 4 - Ignition Switch
- 5 - Analog Clock

- 6 - Radio
- 7 - Upper Glove Compartment/Beverage Cooler – If Equipped
- 8 - Lower Glove Compartment
- 9 - Heated Seat Switch – If Equipped
- 10 - Hazard Switch

- 11 - Storage Compartment
- 12 - Climate Control
- 13 - Trunk Release Switch



INSTRUMENT CLUSTER – BASE

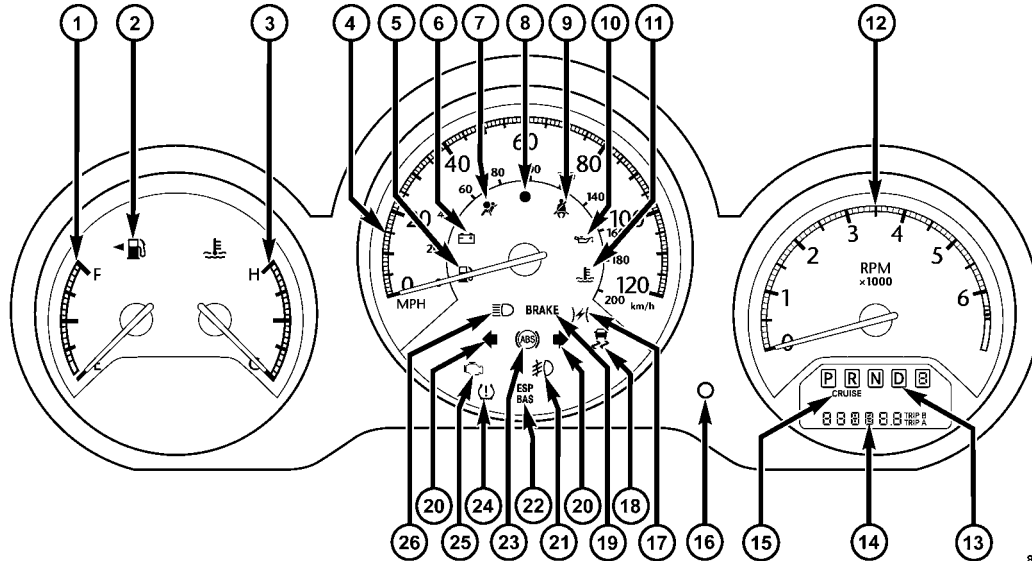

### INSTRUMENT CLUSTER – PREMIUM

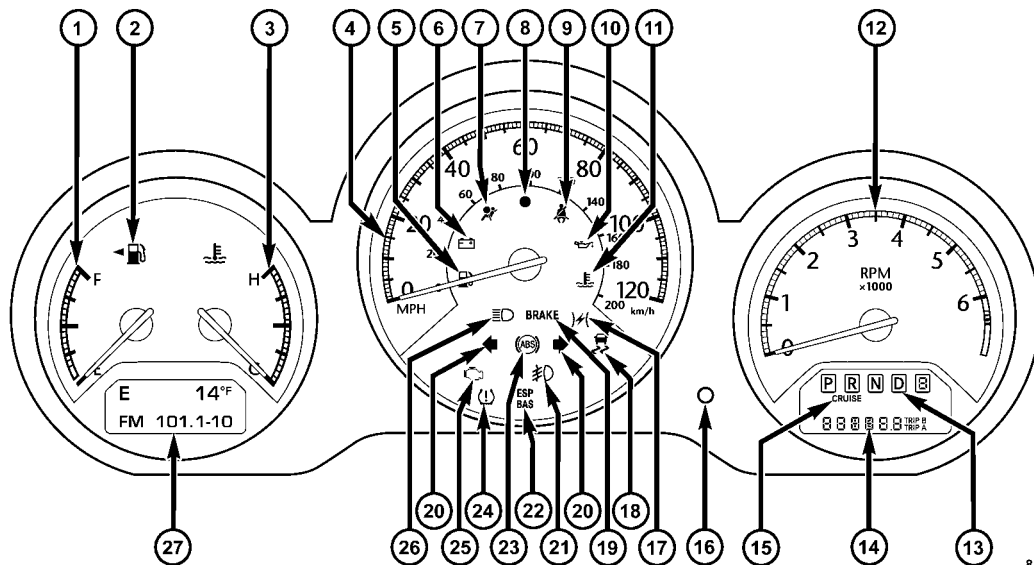

## INSTRUMENT CLUSTER DESCRIPTIONS

### 1. *Fuel Gauge*

When the ignition switch is in the ON position, the pointer will show the level of fuel remaining in the fuel tank.

### 2. *Fuel Door Reminder*



This is a reminder that the Fuel Filler Door is located on the left side of the vehicle.

### 3. *Temperature Gauge*

The temperature gauge shows engine coolant temperature. Any reading below the red area of the gauge shows that the engine cooling system is operating properly. The gauge pointer may show a higher than normal temperature when driving in hot weather, up mountain grades, in heavy stop and go traffic, or when towing a trailer.

If the pointer rises to the **H** (red) mark, the instrument cluster will sound a chime. Pull over and stop the vehicle. Idle the vehicle with the air conditioner turned off until the pointer drops back into the normal range. If the pointer remains on the **H** (red) mark, turn the engine off immediately and call for service.

There are steps that you can take to slow down an impending overheat condition. If your air conditioning is on, turn it off. The air conditioning system adds heat to the engine cooling system and turning off the A/C removes this heat. You can also turn the Temperature control to maximum heat, the Mode control to Floor and the Fan control to High. This allows the heater core to act as a supplement to the radiator and aids in removing heat from the engine cooling system.

### 4. *Speedometer*

Indicates the vehicle speed in miles per hour (MPH) and kilometers per hour (km/h).

### 5. Low Fuel Light



When the fuel level drops to approximately 2.0 gallons (7.6 Liters), the fuel symbol will light and a single chime will sound.

**NOTE:** This light will remain on until a minimum of approximately 3.0 gallons of fuel is added.

### 6. Charging System Light



This light shows the status of the electrical charging system. The light should come on briefly when the ignition is first turned on and remain on briefly as a bulb check. If the light stays on or comes on while driving, turn off some of the vehicle's electrical devices, such as the Front Fog Lights or Rear Window Defroster. If the Charging System Light remains on, it means that the vehicle is experiencing a problem with the charging system. Obtain SERVICE IMMEDIATELY. See your local authorized dealer.

### 7. Airbag Warning Light



The light comes on and remains on for six to eight seconds as a bulb check when the ignition switch is first turned ON. If the light does not turn on during starting, stays on, or turns on while driving, have the system inspected by an authorized dealer.

### 8. Vehicle Security Light — If Equipped



This light will flash rapidly for approximately 16 seconds when the alarm system is arming. The light will begin to flash slowly indicating that the system is armed. The light will stop flashing when the vehicle is disarmed.

### 9. *Seat Belt Reminder Light*



When the ignition switch is first turned ON, this light will come on for about six seconds. A chime will sound if you have not pulled the shoulder belt out of the retractor. This is a reminder to “buckle up”. If you do not buckle up, the light will remain on.

### 10. *Oil Pressure Warning Light*



This light indicates low engine oil pressure. The light will come on and remain on when the ignition switch is turned from the OFF to the ON position, and the light will turn off after the engine is started. If the bulb does not come on during starting, have the system checked by an authorized dealer.

If the light comes on and remains on while driving, stop the vehicle and shut off the engine. **DO NOT OPERATE THE VEHICLE UNTIL THE CAUSE IS CORRECTED.**

The light does not show the quantity of oil in the engine. This can be determined using the procedure shown in Section 7.

### 11. *Engine Temperature Warning Light*



This light warns of an overheated engine condition. If the engine is critically hot, a warning chime will sound 10 times. After the chime turns off, the engine will still be critically hot until the light goes out.

### 12. *Tachometer*

The silver area of the scale shows the permissible engine revolutions-per-minute (rpm x 1000) for each gear range. Before reaching the red area, ease up on the accelerator to prevent engine damage.

### 13. *Shift Lever Indicator*

This display indicator shows the automatic transmission shift lever selection.

**NOTE:** You must apply the brakes before shifting from PARK.

#### 14. Odometer/Trip Odometer

The odometer shows the total distance the vehicle has been driven. U.S. federal regulations require that upon transfer of vehicle ownership, the seller certify to the purchaser the correct mileage that the vehicle has been driven. Therefore, if the odometer reading is changed during repair or replacement, be sure to keep a record of the reading before and after the service so that the correct mileage can be determined.

The two trip odometers show individual trip mileage. To switch from odometer to trip odometers, press and release the Trip Odometer button. To reset a trip odometer, display the desired trip odometer to be reset then push and hold the button until the display resets (approximately 2 seconds). Refer to "Trip Odometer Button" for additional information.

#### *Vehicle Warning Messages*

When the appropriate conditions exist, "door," "deck," "LoW TirE," "CHAngE OIL," "GASCAP" or "HOTOIL" will display in the odometer.

**NOTE:** If the instrument cluster is equipped with the optional Electronic Vehicle Information Center (EVIC), then all warnings including "Low Tire," "Door Ajar" and "Trunk Ajar" will only display in the EVIC. (Refer to "Electronic Vehicle Information Center (EVIC)" in this section for specific messages).

#### *LoW TirE*

When the appropriate condition exists the odometer display will toggle between LoW and TirE for three cycles.

#### *HOTOIL*

When this message is displayed there is an engine over-temperature condition.

### *GASCAP*

If the vehicle diagnostic system detects a leak or change in the evaporative system, or the fuel filler cap is loose, improperly installed, or damaged, the words “GASCAP” will display in the odometer. If this occurs, tighten the fuel filler cap properly and press the odometer reset button to turn off the “GASCAP” message. (Refer to “Onboard Diagnostic System — OBDII” in Section 7 of this manual for more information). If the problem continues, the message will appear the next time the vehicle is started. See your authorized dealer service center as soon as possible.

### *CHAngE OIL*

Your vehicle is equipped with an engine oil change indicator system. The “CHAngE OIL” message will flash in the instrument cluster odometer for approximately 12 seconds after a single chime has sounded to indicate the next scheduled oil change interval. The engine oil change indicator system is duty cycle based, which

means the engine oil change interval may fluctuate dependent upon your personal driving style.

Unless reset, this message will continue to display each time you turn the ignition switch to the “ON” position. To turn off the message temporarily, press and release the Trip Odometer button on the instrument cluster. To reset the oil change indicator system (after performing the scheduled maintenance) perform the following procedure:

1. Turn the ignition switch to the ON position (Do not start the engine).
2. Fully depress the accelerator pedal slowly 3 times within 10 seconds.
3. Turn the ignition switch to the LOCK position.

**NOTE:** If the indicator message illuminates when you start the vehicle, the oil change indicator system did not reset. If necessary repeat this procedure.

4. For vehicles equipped with the Electronic Vehicle Information Center (EVIC), refer to “Electronic Vehicle Information Center (EVIC)” in this section of the manual.

### *15. Cruise Indicator — If Equipped*

**CRUISE** This indicator shows that the Speed Control System is ON.

### *16. Odometer/Trip Odometer Reset Button*

#### *Single Trip Odometer*

Press and release this button to change the display from odometer to trip odometer. The word “Trip” displays to show that the odometer is in Trip Mode. Press and release the button again to change the display back to the odometer.

To reset the trip odometer, first set the display to Trip Mode. Then push and hold the button (approximately 2 seconds) until the display resets to 0 miles. The odometer must be in Trip Mode to reset the trip odometer.

#### *Dual Trip Odometer — If Equipped*

Press and release this button to change the display from odometer to “Trip A.” Press and release it a second time to change the display to “Trip B.” Press and release it a third time to change the display back to the odometer.

To reset the trip odometer, first display the trip mileage that you want to reset, “Trip A” or “Trip B.” Then push and hold the button (approximately 2 seconds) until the display resets to 0 miles. The odometer must be in Trip Mode to reset the trip odometer.



### 17. *Electronic Throttle Control (ETC) Indicator Light*



This light informs you of a problem with the Electronic Throttle Control (ETC) system. If a problem is detected, the light will come on while the engine is running. If the light remains lit with the engine running your vehicle will usually be drivable and not need towing, however see your dealer for service as soon as possible.

If the light is flashing when the engine is running you may experience power loss, an elevated/rough idle, and increased brake pedal effort, and your vehicle may require towing. Immediate service is required.

The light will come on when the ignition switch is first turned on and remain on approximately 15 seconds as a bulb check. This is normal. If the light does not come on during starting, have the system checked by an authorized dealer.

### 18. *Electronic Stability Program (ESP) Indicator Light / Traction Control System (TCS) Indicator Light — If Equipped*



If this indicator light flashes during acceleration, apply as little throttle as possible. While driving, ease up on the accelerator. Adapt your speed and driving to the prevailing road conditions, and do not switch off the Electronic Stability Program (ESP), or Traction Control System (TCS).

### 19. *Brake Warning Light*

#### **BRAKE**

This light monitors various brake functions, including brake fluid level and parking brake application. If the brake light turns on, it may indicate that the parking brake is applied, that the brake fluid level is low, or that there is a problem with the anti-lock brake system (if equipped).

The dual brake system provides a reserve braking capacity in the event of a failure to a portion of the hydraulic system. Failure of either half of the dual brake system is indicated by the Brake Warning Light which will turn on when the brake fluid level in the master cylinder has dropped below a specified level.

The light will remain on until the cause is corrected.

**NOTE:** The light may flash momentarily during sharp cornering maneuvers which change fluid level conditions. The vehicle should have service performed, and the brake fluid level checked.

If brake failure is indicated, immediate repair is necessary.

### WARNING!

**Driving a vehicle with the brake light on is dangerous. Part of the brake system may have failed. It will take longer to stop the vehicle. You could have an accident. Have the vehicle checked immediately.**

Vehicles equipped with Anti-Lock brakes (ABS), are also equipped with Electronic Brake Force Distribution (EBD). In the event of an EBD failure, the Brake Warning Light will turn on along with the ABS Light. Immediate repair to the ABS system is required.

The operation of the Brake Warning Light can be checked by turning the ignition switch from the OFF position to the ON position. The light should illuminate for approximately three seconds. The light should then turn off unless the parking brake is applied or a brake fault is detected. If the light does not illuminate, have the light inspected by an authorized dealer.

The light also will turn on when the parking brake is applied with the ignition switch in the ON position.

**NOTE:** This light shows only that the parking brake is applied. It does not show the degree of brake application.

### 20. Turn Signal Indicators

 The arrows will flash in unison with the exterior turn signal, when using the turn signal lever.

### 21. Front Fog Light Indicator — If Equipped

 This light indicates when the front fog lights are ON.

### 22. Electronic Stability Program (ESP) Indicator Light / Brake Assist System (BAS) Warning Light

**ESP  
BAS** The malfunction lamp for the Electronic Stability Program (ESP) is combined with Brake Assist System (BAS). The yellow “ESP/BAS Warning Lamp” comes on when the ignition switch is turned to the “ON” position. The “ESP/BAS

Warning Lamp” should turn off with the engine running. If the “ESP/BAS Warning Lamp” comes on continuously with the engine running, a malfunction has been detected in either the ESP or the BAS system. If this light remains on after several ignition cycles, and the vehicle has been driven several miles at speeds greater than 30 mph (48 km/h), see an authorized dealer as soon as possible.

### 23. Anti-Lock Brake (ABS) Light — If Equipped



This light monitors the ABS. This light will come on when the ignition key is turned to the ON position and may stay on for approximately three seconds.

If the ABS light remains on or comes on during driving, it indicates that the Anti-Lock portion of the brake system is not functioning and that service is required, however, the conventional brake system will continue to operate normally provided that the BRAKE warning light is not on.

If the ABS light is on, the brake system should be serviced as soon as possible to restore the benefit of Anti-Lock Brakes.

The ABS warning light should be checked frequently to assure that it is operating properly. Turn the ignition key to the on position, but do not start the vehicle. The light should come on. If the light does not come on, have the system inspected by an authorized dealer.

#### *24. Tire Pressure Monitoring Telltale Light*



Each tire, including the spare (if provided), should be checked monthly, when cold and inflated to the inflation pressure recommended by the vehicle manufacturer on the vehicle placard or tire inflation pressure label. (If your vehicle has tires of a different size than the size indicated on the vehicle placard or tire inflation pressure label, you should determine the proper tire inflation pressure for those tires.)

As an added safety feature, your vehicle has been equipped with a Tire Pressure Monitoring System (TPMS) that illuminates a low tire pressure telltale when one or more of your tires is significantly under-inflated. Accordingly, when the low tire pressure telltale illuminates, you should stop and check your tires as soon as possible, and inflate them to the proper pressure. Driving on a significantly under-inflated tire causes the tire to overheat and can lead to tire failure. Under-inflation also reduces fuel efficiency and tire tread life, and may affect the vehicle's handling and stopping ability.

Please note that the TPMS is not a substitute for proper tire maintenance, and it is the driver's responsibility to maintain correct tire pressure, even if under-inflation has not reached the level to trigger illumination of the TPMS low tire pressure telltale.

Your vehicle has also been equipped with a TPMS malfunction indicator to indicate when the system is not operating properly. The TPMS malfunction indicator is combined with the low tire pressure telltale. When the system detects a malfunction, the telltale will flash for approximately one minute and then remain continuously illuminated. This sequence will continue upon subsequent vehicle start-ups as long as the malfunction exists. When the malfunction indicator is illuminated, the system may not be able to detect or signal low tire pressure as intended. TPMS malfunctions may occur for a variety of reasons, including the installation of replacement or alternate tires or wheels on the vehicle that prevent the TPMS from functioning properly. Always check the TPMS malfunction telltale after replacing one or more tires or wheels on your vehicle, to ensure that the replacement or alternate tires and wheels allow the TPMS to continue to function properly.

### CAUTION!

**The TPMS has been optimized for the original equipment tires and wheels. TPMS pressures and warning have been established for the tire size equipped on your vehicle. Undesirable system operation or sensor damage may result when using replacement equipment that is not of the same size, type, and/or style. Aftermarket wheels can cause sensor damage. Do not use tire sealant from a can, or balance beads if your vehicle is equipped with a TPMS, as damage to the sensors may result.**

### 25. *Malfunction Indicator Light (MIL)*



The Malfunction Indicator Light (MIL) is part of an onboard diagnostic system called OBD that monitors emissions, engine, and automatic trans-axle control systems. The light will illuminate when the key is in the ON position before engine start. If the bulb does not come on when turning the key from LOCK to ON, have the condition checked promptly.

Certain conditions such as a loose or missing gas cap, poor fuel quality, etc. may illuminate the light after engine start. The vehicle should be serviced if the light stays on through several of your typical driving cycles. In most situations the vehicle will drive normally and will not require towing.

If the MIL flashes when the engine is running, serious conditions may exist that could lead to immediate loss of power or severe catalytic converter damage. The vehicle should be serviced as soon as possible if this occurs.

### 26. *High Beam Indicator*



This light indicates that the headlights are on high beam. Pull the turn signal lever toward the steering wheel to switch the headlights to low beam.

### 27. *Electronic Vehicle Information Center (EVIC)*

#### *Display—Premium Cluster Only*

This display shows the EVIC messages when the appropriate conditions exist. Refer to “Electronic Vehicle Information Center (EVIC)” in this section for more information.

## ELECTRONIC VEHICLE INFORMATION CENTER (EVIC) – IF EQUIPPED

The Electronic Vehicle Information Center (EVIC) features a driver-interactive display that is located in the instrument cluster.

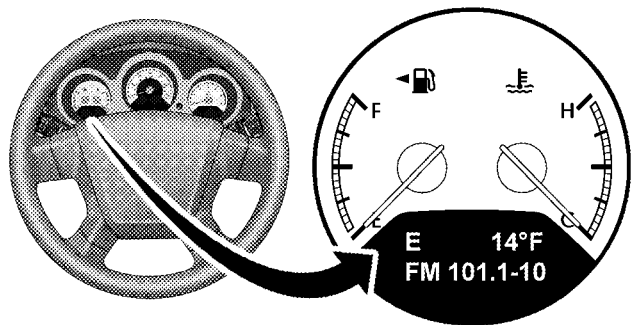

819788c7

Electronic Vehicle Information Center (EVIC)

The EVIC consists of the following:

- System status
- Vehicle information warning message displays
- Personal settings (customer programmable features)
- Compass heading display (N, S, E, W, NE, NW, SE, SW)
- Outside temperature display (°F or °C)
- Trip computer functions
- Audio mode displays – 12 preset Radio Stations or CD Title and Track number when playing
- Tire Pressure Monitor System (TPMS) displays (if equipped)

The system allows the driver to select information by pressing the following buttons on the instrument panel switch bank:



**MENU  
Button**

Press and release the MENU button to advance the display to Trip Functions or Personal settings or to return to the default System status display.



**STEP  
Button**

Press and release the STEP button to advance the display through the various Trip Functions or Personal settings.



**COM-  
PASS  
Button**

Press and release the COMPASS button to display the compass heading and the outside temperature.



**RESET  
Button**

Press and release the RESET button to accept a selection. The RESET button also resets various Trip Functions.



## EVIC Displays

When the appropriate conditions exist, the Electronic Vehicle Information Center (EVIC) displays the following messages.

- Turn Signal On (with a continuous warning chime after one mile traveled)
- Left Front Turn Signal Light Out (with a single chime)
- Left Rear Turn Signal Light Out (with a single chime)
- Right Front Turn Signal Light Out (with a single chime)
- Right Rear Turn Signal Light Out (with a single chime)
- RKE (Remote Keyless Entry) Battery Low (with a single chime)
- Personal Settings Not Available – Vehicle Not In PARK
- Personal Settings Not Available – Vehicle in Motion

- Left/Right Door Ajar (one or more, with a single chime if speed is above 1 mph / 1 km h)
- Door(s) Ajar (with a single chime if vehicle is in motion)
- Trunk Ajar (with a single chime)
- Headlights On
- Key In Ignition
- Oil Change Required (with a single chime)

## Oil Change Required

Your vehicle is equipped with an engine oil change indicator system. The Oil Change Required message will flash in the EVIC display for approximately five seconds after a single chime has sounded to indicate the next scheduled oil change interval. The engine oil change indicator system is duty cycle based, which means the engine oil change interval may fluctuate dependent upon your personal driving style.

Unless reset, this message will continue to display each time you turn the ignition switch to the ON/RUN position. To turn off the message temporarily, press and release the MENU button. To reset the oil change indicator system (after performing the scheduled maintenance) perform the following procedure:

1. Turn the ignition switch to the ON position (Do not start the engine).
2. Fully depress the accelerator pedal slowly three times within 10 seconds.
3. Turn the ignition switch to the LOCK position.

**NOTE:** If the indicator message illuminates when you start the vehicle, the oil change indicator system did not reset. If necessary repeat this procedure.

### **Trip Functions**

Press and release the MENU button until one of the following Trip Functions displays in the EVIC:

- Average Fuel Economy
- Distance To Empty
- Elapsed Time
- Display Units of Measure in

Press and release the STEP button to advance the display through the Trip Functions.

The Trip Functions mode displays the following information:

- *Average Fuel Economy*

Shows the average fuel economy since the last reset. When the fuel economy is reset, the display will read, RESET or show dashes for two seconds. Then, the history information will be erased, and the averaging will continue from the last fuel average reading before the reset.

- *Distance To Empty (DTE)*

Shows the estimated distance that can be traveled with the fuel remaining in the tank. This estimated distance is determined by a weighted average of the instantaneous and average fuel economy, according to the current fuel tank level. DTE cannot be reset through the RESET button.

**NOTE:** Significant changes in driving style or vehicle loading will greatly affect the actual drivable distance of the vehicle, regardless of the DTE display value.

When the DTE value is less than 30 miles (48 km) estimated driving distance, the DTE display will change to a text display of "LOW FUEL. This display will continue until the vehicle runs out of fuel. Adding a significant amount of fuel to the vehicle will turn off the LOW FUEL text and a new DTE value will display.

- *Elapsed Time*

Shows the total elapsed time of travel since the last reset. Elapsed time will increment when the ignition switch is in the ON or START position.

- *Display Units In:*

To make your selection, press and release the RESET button until U.S. or METRIC appears.

### **To Reset The Display**

Reset will only occur if a resettable function is currently displayed. Press and hold the RESET button once to clear the function currently displayed.

To reset all resettable functions, press and release the RESET button a second time within three seconds of resetting the currently displayed function (Reset ALL will display during this three second window).

## Compass Display



The compass heading indicates the direction the vehicle is facing. Press and release the compass button to display one of eight compass heading and the outside temperature.

COM-  
PASS  
Button

## Automatic Compass Calibration

This compass is self-calibrating, which eliminates the need to calibrate the compass manually. When the vehicle is new, the compass may appear erratic and the EVIC will flash the “CAL” indicator until the compass is calibrated. You may calibrate the compass by completing one or more 360-degree turns (in an area free from large metal or metallic objects) until the CAL indicator in the EVIC turns off. The compass will now function normally.

## Manual Compass Calibration

If the compass appears erratic or inaccurate, and the variance has been properly set, you may wish to manually recalibrate the compass. To manually calibrate the compass:

1. Start the engine. Leave the shift lever in PARK in order to enter the EVIC Programming Menus.
2. Press and release the MENU button until “Personal Settings” displays in the EVIC.
3. Press and release the STEP button until “Calibrate Compass Yes” displays in the EVIC.
4. Press and release the RESET button and the “CAL” indicator will quit flashing.
5. Drive the vehicle slowly, completing one or more circles (in an area free from large metal or metallic objects) until the “CAL” indicator turns off. The compass will now function normally.

### Compass Variance

Compass Variance is the difference between Magnetic North and Geographic North. To ensure compass accuracy, the compass variance should be properly set according to the variance map for the zone where the vehicle will be driven. When properly set, the compass will automatically account for this difference.

**NOTE:** Magnetic and battery powered devices, (such as cell phones, iPod's, radar detectors, PDA's and laptops) should be kept away from the top of the instrument panel. This is where the compass module is located and such devices may interfere and cause false compass readings.

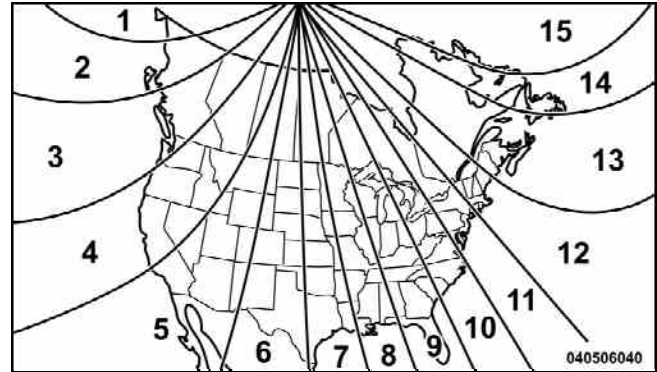

1. Turn the ignition switch to the ON position. Leave the shift lever in PARK.
2. Press and release the MENU button until "Personal Settings" displays in the EVIC.

3. Press and release the STEP button until “Compass Variance” and the current Variance Value displays in the EVIC.

4. Press and release the RESET button to increment the Variance Value by one, (one button press per update), until the proper variance zone is selected according to the map.

**NOTE:** The Variance Values will wrap around from 15 back to 1. The Default Variance is Zone 8.

5. Press and release the STEP button to exit. Press the STEP button if you wish to calibrate the compass manually (Refer to “Manual Compass Calibration”).

### **Personal Settings (Customer-Programmable Features)**

Personal settings allows the driver to set and recall features when the automatic transaxle is in PARK.

Press and release the MENU button until “Personal Settings” displays in the EVIC.

Press and release the STEP button to display the following programmable features:

#### **Language**

When in this display you may select different languages for all display nomenclature, including the trip functions. Pressing the RESET button while in this display selects English, Espanol, or Francais depending on availability. As you continue, the displayed information will be shown in the selected language.

#### **Auto Unlock on Exit**

When ON is selected and the transaxle is in the PARK or NEUTRAL position, all doors will unlock when the driver’s door is opened. To make your selection, press and hold the RESET button until ON or OFF appears.

### **Remote Key Unlock**

When “Driver Door 1st Press” is selected, only the driver’s door will unlock on the first press of the Remote Keyless Entry (RKE) transmitter UNLOCK button. When Driver Door 1st Press is selected, you must press of the RKE transmitter UNLOCK button twice to unlock the passenger’s doors. When “All Doors 1st Press” is selected, all of the doors will unlock on the first press of the RKE transmitter UNLOCK button. To make your selection, press and release the RESET button until “Driver Door 1st Press” or “All Doors 1st Press” appears.

### **Sound Horn with Lock**

When ON is selected, a short horn sound will occur when the RKE transmitter LOCK button is pressed. This feature may be selected with or without the flash lights ON, LOCK/UNLOCK feature. To make your selection, press and release the RESET button until ON or OFF appears.

### **Flash Lights with Lock**

When ON is selected, the front and rear turn signals will flash when the doors are locked or unlocked with the RKE transmitter. This feature may be selected with or without the Sound Horn on lock feature selected. To make your selection, press and release the RESET button until ON or OFF appears.

### **Headlights Off Delay**

When this feature is selected, the driver can choose to have the headlights remain on for 0, 30, 60, or 90 seconds when exiting the vehicle. To make your selection, press and hold the RESET button until 0, 30, 60, or 90 seconds appears.

### **Headlights With Wipers (Available with Auto Headlights Only)**

When ON is selected, and the headlight switch is in the AUTO position, the headlights will turn on approximately 10 seconds after the wipers are turned on. The headlights will also turn off when the wipers are turned off if they were turned on by this feature. To make your selection, press and hold the RESET button until ON or OFF appears.

**NOTE:** Turning the headlights on during the daytime causes the instrument panel lights to dim. To increase the brightness, refer to “Lights” in Section 3 of this manual.

### **Key-Off Power Delay**

When this feature is selected, the power window switches, radio, hands-free system (if equipped), and power outlets will remain active for up to 10 minutes after the ignition switch is turned to the LOCK position.

Opening a vehicle door will cancel this feature. To make your selection, press and hold the RESET button until Off, 45 sec., 5 min., or 10 min. appears.

### **Illumination Approach**

When this feature is selected, the headlights will activate and remain on for up to 90 seconds when the doors are unlocked with the RKE transmitter. To make your selection, press and hold the RESET button until OFF, 30, 60, or 90 seconds appears.

### **Display Units in English or Metric**

The EVIC and odometer can be changed between English and Metric units of measure. To make your selection, press and release the RESET button until U.S. or METRIC appears.



## SETTING THE ANALOG CLOCK

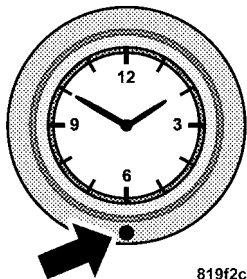

819f2c59

To set the analog clock, located at the top center of the instrument panel, press and hold the button in until the setting is correct. The clock will adjust slowly at first and then quicker the longer the button is held.

## SALES CODE REQ — AM/FM STEREO RADIO AND 6-DISC CD/DVD CHANGER (MP3/WMA AUX JACK)

**NOTE:** The radio sales code is located on the lower right side of the radio faceplate.

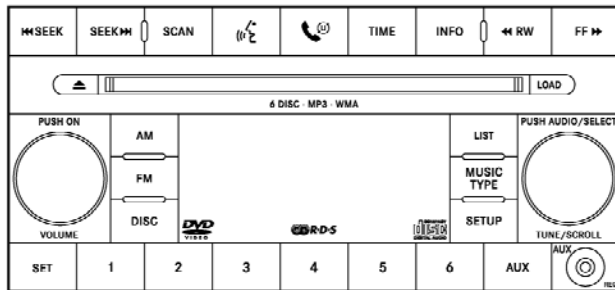

042005200

REQ Radio

## Operating Instructions - Radio Mode

**NOTE:** The ignition switch must be in the ON or ACC position to operate the radio.

**Power Switch/Volume Control (Rotary)**

Push the ON/VOLUME control knob to turn on the radio. Press the ON/VOLUME control knob a second time to turn off the radio.

**Electronic Volume Control**

The electronic volume control turns continuously (360 degrees) in either direction without stopping. Turning the ON/VOLUME control knob to the right increases the volume and to the left decreases it.

When the audio system is turned ON, the sound will be set at the same volume level as last played.

**SEEK Buttons**

Press and release the SEEK buttons to search for the next listenable station in AM/FM mode. Press the right switch to seek up and the left switch to seek down. The radio will remain tuned to the new station until you make another selection. Holding either button will bypass stations without stopping until you release it.

**SCAN Button**

Pressing the SCAN button causes the tuner to search for the next listenable station, in AM, FM or Satellite (if equipped) frequencies, pausing for five seconds at each listenable station before continuing to the next. To stop the search, press the SCAN button a second time.

**Voice Recognition Button (UConnect® Hands-Free Phone) — If Equipped**

Press this button to operate the Hands-Free Phone (UConnect®) feature (if equipped). Refer to “Hands-Free Communication (UConnect®)” in Section 3.

If your vehicle is not equipped with or this feature is not available on your vehicle, a “Not Equipped With UConnect” message will display on the radio screen.

**Phone Button (UConnect® Hands-Free Phone) — If Equipped**

Press this button to operate the Hands-Free Phone (UConnect®) feature (if equipped). Refer to “Hands-Free Communication (UConnect®)” in Section 3.

If your vehicle is not equipped with or this feature is not available on your vehicle, a “Not Equipped With UConnect” message will display on the radio screen.

**TIME Button**

Press the TIME button and the time of day will display. In AM or FM mode, pressing the TIME button will switch between the time and frequency displays.

**Clock Setting Procedure**

1. Press and hold the TIME button until the hours blink.
2. Adjust the hours by turning the right side TUNE/SCROLL control knob.

3. After adjusting the hours, press the right side TUNE/SCROLL control knob to set the minutes. The minutes will begin to blink.

4. Adjust the minutes using the right side TUNE/SCROLL control knob. Press the TUNE/SCROLL control knob to save the time change.

5. To exit, press any button/knob or wait five seconds.

The clock can also be set by pressing the SETUP button and selecting the “SET HOME CLOCK” entry. Once in this display follow the above procedure, starting at step 2.

**INFO Button**

Press the INFO button for an RDS station (one with call letters displayed). The radio will return a Radio Text message broadcast from an FM station (FM mode only).

**RW/FF**

Pressing the RW (Rewind) or FF (Fast Forward) buttons causes the tuner to search for the next frequency in the direction of the arrows. This feature operates in AM, FM or Satellite (if equipped) frequencies.

**TUNE Control**

Turn the rotary TUNE/SCROLL control knob clockwise to increase or counterclockwise to decrease the frequency.

**Setting the Tone, Balance, and Fade**

Push the rotary TUNE/SCROLL control knob and BASS will display. Turn the TUNE/SCROLL control knob to the right or left to increase or decrease the bass tones.

Push the rotary TUNE/SCROLL control knob a second time and MID will display. Turn the TUNE/SCROLL control knob to the right or left to increase or decrease the mid-range tones.

Push the rotary TUNE/SCROLL control knob a third time and TREBLE will display. Turn the TUNE/SCROLL control knob to the right or left to increase or decrease the treble tones.

Push the rotary TUNE/SCROLL control knob a fourth time and BALANCE will display. Turn the TUNE/SCROLL control knob to the right or left to adjust the sound level from the right or left side speakers.

Push the rotary TUNE/SCROLL control knob a fifth time and FADE will display. Turn the TUNE/SCROLL control knob to the left or right to adjust the sound level between the front and rear speakers.

Push the rotary TUNE/SCROLL control knob again to exit setting tone, balance, and fade.

**MUSIC TYPE Button**

Pressing this button once will turn on the Music Type mode for five seconds. Pressing the MUSIC TYPE button or turning the TUNE/SCROLL control knob within five seconds will allow the program format type to be selected. Many radio stations do not currently broadcast Music Type information.

Toggle the MUSIC TYPE button to select the following format types:

Program Type	16-Digit Character Display
No program type or undefined	None
Adult Hits	Adlt Hit
Classical	Classicl
Classic Rock	Cls Rock
College	College
Country	Country

Program Type	16-Digit Character Display
Foreign Language Information	Language Inform
Jazz	Jazz
News	News
Nostalgia	Nostalga
Oldies	Oldies
Personality	Persnlty
Public	Public
Rhythm and Blues	R & B
Religious Music	Rel Musc
Religious Talk	Rel Talk
Rock	Rock
Soft	Soft
Soft Rock	Soft Rck
Soft Rhythm and Blues	Soft R & B

Program Type	16-Digit Character Display
Sports	Sports
Talk	Talk
Top 40	Top 40
Weather	Weather

By pressing the SEEK button when the Music Type icon is displayed, the radio will be tuned to the next frequency station with the same selected Music Type name. The Music Type function only operates when in the FM mode.

If a preset button is activated while in the Music Type (Program Type) mode, the Music Type mode will be exited and the radio will tune to the preset station.

### SETUP Button

Pressing the SETUP button allows you to select between the following items:

**NOTE:** Turn the TUNE/SCROLL control knob to scroll through the entries. Push the AUDIO/SELECT button to select an entry and make changes.

- **DVD Enter** - When the disc is in DVD Menu mode, selecting DVD Enter will allow you to play the current highlighted selection. Use the remote control to scroll up and down the menu (if equipped).



- **DISC Play/Pause** - You can toggle between playing the DVD and pausing the DVD by pushing the SELECT button (if equipped).

- **DVD Play Options** - Selecting the DVD Play Options will display the following:
  - Subtitle – Repeatedly pressing SELECT will switch subtitles to different subtitle languages that are available on the disc (if equipped).

- Audio Stream – Repeatedly pressing SELECT will switch to different audio languages (if supported on the disc) (if equipped).
- Angle – Repeatedly pressing SELECT will change the viewing angle if supported by the DVD disc (if equipped).

**NOTE:**

- The available selections for each of the above entries varies depending upon the disc.
- These selections can only be made while playing a DVD.
- **VES™ Power** - Allows you to turn VES™ ON and OFF (if equipped).
- **VES™ Lock** - Locks out rear VES™ remote controls (if equipped).

- **VES™ CH1/CH2** - Allows the user to change the mode of either the IR1 or IR2, wireless headphones by pressing the AUDIO/SELECT button (if equipped).
- **Set Home Clock** - Pressing the SELECT button allows you to set the clock. Turn the TUNE/SCROLL control knob to adjust the hours and then press and turn the TUNE/SCROLL control knob to adjust the minutes. Press the TUNE/SCROLL control knob again to save changes.
- **Player Defaults** - Selecting this item will allow the user to scroll through the following items, and set defaults according to customer preference.

***Menu Language — If Equipped***

Selecting this item will allow the user to choose the default startup DVD menu language (effective only if language supported by disc). If you want to select a language not listed, then scroll down and select "other." Enter the four-digit country code using the TUNE/SCROLL control knob to scroll up and down to select the number and then push to select.

***Audio Language — If Equipped***

Selecting this item allows you to choose a default audio language (effective only if the language is supported by the disc). You can select a language not listed by scrolling down and selecting "other." Enter the country code using the TUNE/SCROLL control knob to scroll up and down to select the number and then push to select.

***Subtitle Language — If Equipped***

Selecting this item allows you to choose a default subtitle language (effective only if the language is supported by

the disc). You can select a language not listed by scrolling down and selecting "other." Enter the country code using the TUNE/SCROLL control knob to scroll up and down to select the number and then push to select.

***Subtitles — If Equipped***

Selecting this item allows you to choose between subtitle Off or On.

***Audio DRC — If Equipped***

Selecting this item allows you to limit maximum audio dynamic range. The default is set to "High," and under this setting, dialogues will play at 11 db higher than if the setting is "Normal."

***Aspect Ratio — If Equipped***

Selecting this item allows you to choose between wide screen, pan scan, and letter box.



### *AutoPlay — If Equipped*

When this is set to On and a DVD video is inserted, it will bypass the DVD menu screen and automatically play the movie. In some rare cases, the DVD player may not auto-play the main title. In such cases, use the MENU button on the remote control to select desired title to play.

**NOTE:** The user will have to set these defaults before loading a disc. If changes are made to these settings after a disc is loaded, changes will not be effective. Also, the defaults are effective only if the disc supports the customer-preferred settings.

### **AM and FM Buttons**

Press the buttons to select AM or FM Modes.

### **SET Button — To Set the Pushbutton Memory**

When you are receiving a station that you wish to commit to pushbutton memory, press the SET button. The symbol SET 1 will now show in the display window. Select the button (1-6) you wish to lock onto this station

and press and release that button. If a button is not selected within five seconds after pressing the SET button, the station will continue to play but will not be stored into pushbutton memory.

You may add a second station to each pushbutton by repeating the above procedure with this exception: Press the SET button twice and SET 2 will show in the display window. Each button can be set for SET 1 and SET 2 in both AM and FM. This allows a total of 12 AM, 12 FM, and 12 Satellite (if equipped) stations to be stored into pushbutton memory. The stations stored in SET 2 memory can be selected by pressing the pushbutton twice.

Every time a preset button is used, a corresponding button number will display.

### Buttons 1 - 6

These buttons tune the radio to the stations that you commit to pushbutton memory {12 AM, 12 FM, and 12 Satellite (if equipped) stations}.

### DISC Button

Pressing the DISC button will allow you to switch from AM/FM modes to Disc modes.

### Operation Instructions - (DISC MODE for CD and MP3/WMA Audio Play, DVD-VIDEO)

The radio DVD player and many DVD discs are coded by geographic region. These region codes must match in order for the disc to play. If the region code for the DVD disc does not match the region code for the radio DVD player, it will not play the disc. Customers may take their vehicle to an authorized dealer to change the region code of the player a maximum of five times.

### CAUTION!

The radio may shut down during extremely hot conditions. When this occurs, the radio will indicate "Disc Hot" and shut off until a safe temperature is reached. This shutdown is necessary to protect the optics of the DVD player and other radio internal components.

**NOTE:** The ignition switch must be in the ON or ACC position to operate the radio.

### LOAD Button — Loading Compact Disc(s)

Press the LOAD button and the pushbutton with the corresponding number (1-6) where the CD is being loaded. The radio will display PLEASE WAIT and prompt when to INSERT DISC. After the radio displays "INSERT DISC," insert the CD into the player.

Radio display will show "LOADING DISC" when the disc is loading and "READING DISC" when the radio is reading the disc.

### CAUTION!

This CD player will accept 4-3/4 in (12 cm) discs only. The use of other sized discs may damage the CD player mechanism.

#### Eject Button — Ejecting Compact Disc(s)



Press the EJECT button and the pushbutton with the corresponding number (1-6) where the CD was loaded and the disc will unload and move to the entrance for easy removal. Radio display will show "EJECTING DISC" when the disc is being ejected and prompt the user to remove the disc.

Press and hold the EJECT button for five seconds and all CDs will be ejected from the radio.

The disc can be ejected with the radio and ignition OFF.

#### SEEK Button (CD MODE)

Press the right SEEK button for the next selection on the CD. Press the left SEEK button to return to the beginning of the current selection, or return to the beginning of the previous selection if the CD is within the first second of the current selection. Pressing and holding the SEEK button will allow you to scroll through the tracks faster in CD, MP3/MWA modes.

#### SCAN Button (CD MODE)

Press the SCAN button to scan through each track on the CD currently playing.

#### TIME Button (CD MODE)

Press this button to change the display from a large CD playing time display to a small CD playing time display.

**RW/FF (CD MODE)**

Press and hold FF (Fast Forward) and the CD player will begin to fast forward until FF is released, or RW or another CD button is pressed. The RW (Rewind) button works in a similar manner.

**AM or FM Button (CD MODE)**

Switches the Radio into the AM or FM Radio mode.

**Notes On Playing MP3/WMA Files**

The radio can play MP3/WMA files; however, acceptable MP3/WMA file recording media and formats are limited. When writing MP3/WMA files, pay attention to the following restrictions.

**Supported Media (Disc Types)**

The MP3/WMA file recording media supported by the radio are CDDA, CD-R, CD-RW, MP3, WMA, DVD Video, DVD-R, DVD-RW, DVD+R, DVD+RW, and CDDA+MP3.

**Supported Medium Formats (File Systems)**

The medium formats supported by the radio are ISO 9660 Level 1 and Level 2 and includes the Joliet extension. When reading discs recorded using formats other than ISO 9660 Level 1 and Level 2, the radio may fail to read files properly and may be unable to play the file normally. UDF and Apple HFS formats are not supported.

The radio uses the following limits for file systems:

- Maximum number of directory levels: 8
- Maximum number of files: 255
- Maximum number of folders: 100
- Maximum number of characters in file/folder names:
  - Level 1: 12 (including a separator "." and a three-character extension)
  - Level 2: 31 (including a separator "." and a three-character extension)

Multisession disc formats are supported by the radio. Multisession discs may contain combinations of normal CD audio tracks and computer files (including MP3/WMA files). Discs created with an option such as "keep disc open after writing" are most likely multisession discs. The use of multisession for CD audio or MP3/WMA playback may result in longer disc loading times.

If a disc contains multi-formats, such as CD audio and MP3/WMA tracks, the radio will only play the MP3/WMA tracks on that disc.

### Supported MP3/WMA File Formats

The radio will recognize only files with the \*.MP3/WMA extension as MP3/WMA files. Non-MP3/WMA files named with the \*.MP3/WMA extension may cause playback problems. The radio is designed to recognize the file as an invalid MP3/WMA and will not play the file.

When using the MP3/WMA encoder to compress audio data to an MP3/WMA file, the bit rate and sampling

frequencies in the following table are supported. In addition, variable bit rates (VBR) are also supported. The majority of MP3/WMA files use a 44.1 kHz sampling rate and a 192, 160, 128, 96 or VBR bit rates.

MPEG Specification	Sampling Frequency (kHz)	Bit Rate (kbps)
MPEG-1 Audio Layer 3	48, 44.1, 32	320, 256, 224, 192, 160, 128, 112, 96, 80, 64, 56, 48
MPEG-2 Audio Layer 3	24, 22.05, 16	160, 128, 144, 112, 96, 80, 64, 56, 48

WMA Specification	Sampling Frequency (kHz)	Bit Rate (kbps)
WMA	44.1 and 48	48, 64, 96, 128, 160, 192 VBR

ID3 Tag information for artist, song title, and album title are supported for ID3 version 1 tags. ID3 version 2 is not supported by the radios.

Playlist files are not supported. MP3 Pro files are not supported.

### **Playback of MP3/WMA Files**

When a medium containing MP3/WMA data is loaded, the radio checks all files on the medium. If the medium contains a lot of folders or files, the radio will take more time to start playing the MP3/WMA files.

Loading times for playback of MP3/WMA files may be affected by the following:

- Media - CD-RW media may take longer to load than CD-R media
- Medium formats - Multisession discs may take longer to load than non-multisession discs

- Number of files and folders - Loading times will increase with more files and folders

To increase the speed of disc loading, it is recommended to use CD-R media and single-session discs. To create a single-session disc, enable the “Disc at Once” option before writing to the disc.

### **LIST Button (DISC Mode for MP3/WMA Play)**

Pressing the LIST button will bring up a list of all folders on the disc. Scrolling up or down the list is done by turning the TUNE/SCROLL control knob. Selecting a folder by pressing the TUNE/SCROLL control knob will begin playing the files contained in that folder (or the next folder in sequence if the selection does not contain playable files).

The folder list will time out after five seconds.

**INFO Button (DISC Mode for MP3/WMA Play)**

Pressing the INFO button repeatedly will scroll through the following TAG information: Song Title, Artist, File Name, and Folder Name (if available).

Press the INFO button once more to return to "elapsed time" priority mode.

Press and hold the INFO button for three seconds or more and radio will display song titles for each file.

Press and hold the INFO button again for three seconds to return to "elapsed time" display.

**Operation Instructions - Auxiliary Mode**

The auxiliary (AUX) jack is an audio input jack, which allows the user to plug in a portable device such as an MP3/WMA player, cassette player, or microphone and utilize the vehicle's audio system to amplify the source and play through the vehicle speakers.

Pressing the AUX button will change the mode to auxiliary device if the AUX jack is connected.

**NOTE:** The AUX device must be turned on and the device's volume set to the proper level. If the AUX audio is not loud enough, turn the device's volume up. If the AUX audio sounds distorted, turn the device's volume down.

**SEEK Button (Auxiliary Mode)**

No function.

**SCAN Button (Auxiliary Mode)**

No function.

**EJECT Button (Auxiliary Mode)**

No function.



**TIME Button (Auxiliary Mode)**

Press the TIME button to change the display from elapsed playing time to time of day. The time of day will display for five seconds.

**RW/FF (Auxiliary Mode)**

No function.

**SET Button (Auxiliary Mode)**

No function.

**Operating Instructions — Voice Recognition System (VR) (If Equipped)**

For the radio, refer to “Voice Recognition System (VR)” in Section 3.

For UConnect® “Voice Recognition System (VR),” refer to “Hands-Free Communication (UConnect®)” in Section 3.

**Operating Instructions - Hands-Free Phone (UConnect®) (If Equipped)**

Refer to “Hands-Free Communication (UConnect®)” in Section 3.

**Operating Instructions - Satellite Radio Mode (If Equipped)**

Refer to “Satellite Radio” in this section.

**Operating Instructions - Video Entertainment System (VES)<sup>TM</sup> (If Equipped)**

Refer to separate “Video Entertainment System (VES)<sup>TM</sup> Guide.”

**Dolby<sup>®</sup>**

Manufactured under license from Dolby<sup>®</sup> Laboratories. “Dolby<sup>®</sup>” and the double-D symbol are trademarks of Dolby<sup>®</sup> Laboratories.



### *Macrovision*

This product incorporates copyright protection technology that is protected by U.S. patents and other intellectual property rights. Use of this copyright protection technology must be authorized by Macrovision, and is intended for home and other limited viewing uses only, unless otherwise authorized by Macrovision. Reverse engineering or disassembly is prohibited

### *DTS™*

"DTS™" and "DTS™ 2.0" are trademarks of Digital Theater Systems, Inc.

## **AM/FM/CD/DVD MULTIMEDIA SYSTEM RADIO (RER/REN) – IF EQUIPPED**

**NOTE:** The sales code is located on the lower right side of the unit's faceplate.

The REN and RER Multimedia systems contain a radio, CD/DVD player, USB port, and a 30-gigabyte hard drive (HDD). Sirius Satellite Radio is optional. The 6.5 in (16.5 cm) touch screen allows for easy menu selection.

The RER radio also contains a Global Positioning System (GPS)-based Navigation system.

Refer to your Multimedia system (REN) or Navigation (RER) user's manual for detailed operating instructions.

### **Operating Instructions — Voice Recognition System (VR) — If Equipped**

For the radio, refer to "Voice Recognition System (VR)" in Section 3.

### **Operating Instructions — Hands-Free Communication (UConnect®) — If Equipped**

Refer to "Hands-Free Communication (UConnect®)" in Section 3.

## Clock Setting Procedure

### Global Positioning System (GPS) — RER only

The GPS receiver used in this system is synchronized to the time data being transmitted by the GPS satellite. The satellite clock is Greenwich Mean Time (GMT). This is the worldwide standard for time. This makes the system's clock very accurate, once the appropriate time zone and daylight savings information is set.

### To Manually Set the Clock — RER/REN

1. Turn on the multimedia system.
2. Touch the screen where the time is displayed.
3. Touch the screen where "User Clock" is displayed. The clock setting menu will appear on the screen.

4. To move the hour forward, touch the screen where the word "Hour" with the arrow pointing upward is displayed. To move the hour backward, touch the screen where the word "Hour" with the arrow pointing downward is displayed.

5. To move the minute forward, touch the screen where the word "Min" with the arrow pointing upward is displayed. To move the minute backward, touch the screen where the word "Min" with the arrow pointing downward is displayed.

6. To save the new time setting, touch the screen where the word "Save" is displayed.

### Changing Daylight Savings Time

When selected, this feature will display the time of day in daylight savings time. Proceed as follows to change the current setting:

1. Turn on the multimedia system.

2. Touch the screen where the time is displayed. The clock setting menu will appear on the screen.

3. When this feature is on, a check mark will appear in the box next to the words “Daylight Savings.” Touch the screen where the words “Daylight Savings” are displayed to change the current setting.

### **Show Time if Radio is Off**

When selected, this feature will display the time of day on the touch screen when the multimedia system is turned off. Proceed as follows to change the current setting:

1. Turn on the multimedia system.
2. Touch the screen where the time is displayed. The clock setting menu will appear on the screen.
3. When this feature is on, a check mark will appear in the box next to the words “Show Time if Radio is Off.”

Touch the screen where the words “Show Time if Radio is Off” are displayed to change the current setting.

### **Changing the Time Zone**

1. Turn on the multimedia system.
2. Touch the screen where the time is displayed. The clock setting menu will appear on the screen.
3. Touch the screen where the words “Set Time Zone” are displayed. The time zone selection menu will appear on the screen.
4. Select a time zone by touching the screen where your selection appears. If you do not see a time zone that you want to select, touch the screen where the word “Page” is displayed to view additional time zones in the menu.
5. Touch the screen where the word “Save” is displayed.

## SALES CODE RES — AM/FM STEREO RADIO WITH CD PLAYER (MP3 AUX JACK)

**NOTE:** The radio sales code is located on the lower right side of the radio faceplate.

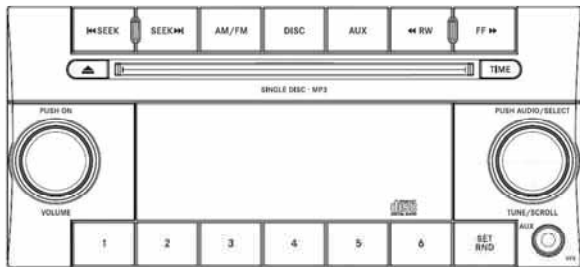

042305232

### RES Radio

## Operating Instructions — Radio Mode

**NOTE:** The ignition switch must be in the ON or ACC position to operate the radio.

### Power Switch/Volume Control (Rotary)

Push the On/Volume control knob to turn on the radio. Push the On/Volume control knob a second time to turn off the radio.

### Electronic Volume Control

The electronic volume control turns continuously (360 degrees) in either direction, without stopping. Turning the On/Volume control knob to the right increases the volume, and to the left decreases it.

When the audio system is turned on, the sound will be set at the same volume level as last played.

### SEEK Buttons

Press and release the SEEK buttons to search for the next listenable station in AM/FM mode. Press the right switch

to seek up and the left switch to seek down. The radio will remain tuned to the new station until you make another selection. Holding either button will bypass stations without stopping, until you release it.

### **TIME Button**

Press the TIME button and the time of day will display. In AM or FM mode, pressing the TIME button will switch between the time and frequency displays.

### **Clock Setting Procedure**

1. Press and hold the TIME button, until the hours blink.
2. Adjust the hours by turning the right side Tune/Scroll control knob.
3. After adjusting the hours, press the right side Tune/Scroll control knob to set the minutes. The minutes will begin to blink.

4. Adjust the minutes using the right side Tune/Scroll control knob. Press the Tune/Scroll control knob to save time change.

5. To exit, press any button/knob, or wait five seconds.

### **RW/FF**

Pressing the RW (Rewind) or FF (Fast Forward) buttons causes the tuner to search for the next frequency in the direction of the arrows. This feature operates in either AM or FM frequencies.

### **TUNE Control**

Turn the rotary Tune/Scroll control knob clockwise to increase, or counterclockwise to decrease, the frequency.

### **Setting the Tone, Balance, and Fade**

Push the rotary Tune/Scroll control knob and BASS will display. Turn the Tune/Scroll control knob to the right or left to increase or decrease the bass tones.

Push the rotary Tune/Scroll control knob a second time and MID will display. Turn the Tune/Scroll control knob to the right or left to increase or decrease the mid-range tones.

Push the rotary Tune/Scroll control knob a third time and TREBLE will display. Turn the Tune/Scroll control knob to the right or left to increase or decrease the treble tones.

Push the rotary Tune/Scroll control knob a fourth time and BALANCE will display. Turn the Tune/Scroll control knob to the right or left to adjust the sound level from the right or left side speakers.

Push the rotary Tune/Scroll control knob a fifth time and FADE will display. Turn the Tune/Scroll control knob to the left or right to adjust the sound level between the front and rear speakers.

Push the rotary Tune/Scroll control knob again to exit setting tone, balance, and fade.

### **AM/FM Button**

Press the buttons to select either AM or FM mode.

### **SET/RND Button — To Set the Pushbutton Memory**

When you are receiving a station that you wish to commit to pushbutton memory, press the SET/RND button. The symbol SET 1 will now show in the display window. Select the button (1 to 6) you wish to lock onto this station and press and release that button. If a button is not selected within five seconds after pressing the SET/RND button, the station will continue to play but will not be stored into pushbutton memory.

You may add a second station to each pushbutton by repeating the above procedure with this exception: Press the SET/RND button twice and SET 2 will show in the display window. Each button can be set for SET 1 and SET 2 in both AM and FM. This allows a total of 12 AM

and 12 FM stations to be stored into pushbutton memory. The stations stored in SET 2 memory can be selected by pressing the pushbutton twice.

Every time a preset button is used, a corresponding button number will display.

### **Buttons 1 - 6**

These buttons tune the radio to the stations that you commit to pushbutton memory (12 AM and 12 FM stations).

### **DISC Button**

Pressing the DISC button will allow you to switch from AM/FM modes to Disc modes.

### **Operation Instructions — CD MODE For CD And MP3 Audio Play**

#### **NOTE:**

- The ignition switch must be in the ON or ACC position to operate the radio.

- This radio is capable of playing compact discs (CD), recordable compact discs (CD-R), rewritable compact discs (CD-RW), compact discs with MP3 tracks and multisession compact discs with CD and MP3 tracks.

### **Inserting Compact Disc(s)**

Gently insert one CD into the CD player with the CD label facing up. The CD will automatically be pulled into the CD player and the CD icon will illuminate on the radio display. If a CD does not go into the slot more than 1.0 in (2.5 cm), a disc may already be loaded and must be ejected before a new disc can be loaded.

If you insert a disc with the ignition ON and the radio ON, the unit will switch from radio to CD mode and begin to play when you insert the disc. The display will show the disc number, the track number, and index time in minutes and seconds. Play will begin at the start of track 1.

**CAUTION!**

- This CD player will accept 4-3/4 in (12 cm) discs only. The use of other sized discs may damage the CD player mechanism.
- Do not use adhesive labels. These labels can peel away and jam the player mechanism.
- RES is a single CD player. Do not attempt to insert a second CD if one is already loaded.
- Dual-media disc types (one side is a DVD, the other side is a CD) should not be used, and they can cause damage to the player.

**EJECT Button - Ejecting a CD**

Press the EJECT button to eject the CD.



If you have ejected a disc and have not removed it within 10 seconds, it will be reloaded. If the CD is not removed, the radio will reinsert the CD but will not play it.

A disc can be ejected with the radio and ignition OFF.

**NOTE:** Ejecting with ignition OFF is not allowed on convertible or soft-top models (if equipped).

**SEEK Button**

Press the right SEEK button for the next selection on the CD. Press the left SEEK button to return to the beginning of the current selection, or return to the beginning of the previous selection if the CD is within the first second of the current selection. Pressing and holding the SEEK button will allow faster scrolling through the tracks in CD, MP3 modes.

**TIME Button**

Press this button to change the display from a large CD playing time display to a small CD playing time display.



**RW/FF**

Press the RW button to stop the CD at the beginning of the current CD track/title.

Press and hold the FF (Fast Forward) button and the CD player will begin to fast forward until FF is released, or RW or another CD button is pressed. The RW (Reverse) button works in a similar manner.

**AM/FM Button**

Press the button to select either AM or FM mode.

**SET/RND Button (Random Play Button)**

Press this button while the CD is playing to activate Random Play. This feature plays the selections on the compact disc in random order to provide an interesting change of pace.

Press the right SEEK button to move to the next randomly selected track.

Press the RND button a second time to stop Random Play.

**Notes on Playing MP3 Files**

The radio can play MP3 files; however, acceptable MP3 file recording media and formats are limited. When writing MP3 files, pay attention to the following restrictions.

**Supported Media (Disc Types)**

The MP3 file recording media supported by the radio are CDDA, CD-R, CD-RW, MP3, and CDDA+MP3.

**Supported Medium Formats (File Systems)**

The medium formats supported by the radio are ISO 9660 Level 1 and Level 2 and includes the Joliet extension. When reading discs recorded using formats other than ISO 9660 Level 1 and Level 2, the radio may fail to read files properly and may be unable to play the file normally. UDF and Apple HFS formats are not supported.

The radio uses the following limits for file systems:

- Maximum number of folder levels: 8
- Maximum number of files: 255
- Maximum number of folders. (The radio display of file names and folder names is limited. For large numbers of files and/or folders, the radio may be unable to display the file name and folder name, and will assign a number instead. With a maximum number of files, exceeding 20 folders will result in this display. With 200 files, exceeding 50 folders will result in this display.)
- Maximum number of characters in file/folder names:
  - Level 1: 12 (including a separator "." and a three-character extension)

- Level 2: 31 (including a separator "." and a three-character extension)

Multisession disc formats are supported by the radio. Multisession discs may contain combinations of normal CD audio tracks and computer files (including MP3 files). Discs created with an option such as "keep disc open after writing" are most likely multisession discs. The use of multisession for CD audio or MP3 playback may result in longer disc loading times.

### **Supported MP3 File Formats**

The radio will recognize only files with the \*.MP3 extension as MP3 files. Non-MP3 files named with the \*.MP3 extension may cause playback problems. The radio is designed to recognize the file as an invalid MP3 and will not play the file.

When using the MP3 encoder to compress audio data to an MP3 file, the bit rate and sampling frequencies in the following table are supported. In addition, variable bit rates (VBR) are also supported. The majority of MP3 files use a 44.1 kHz sampling rate and a 192, 160, 128, 96 or VBR bit rate.

MPEG Specification	Sampling Frequency (kHz)	Bit Rate (kbps)
MPEG-1 Audio Layer 3	48, 44.1, 32	320, 256, 224, 192, 160, 128, 112, 96, 80, 64, 56, 48, 40, 32
MPEG-2 Audio Layer 3	24, 22.05, 16	160, 128, 144, 112, 96, 80, 64, 56, 48, 40, 32, 24, 16, 8

ID3 Tag information for artist, song title, and album title are supported for version 1 ID3 tags. ID3 version 2 is not supported by the radios.

Playlist files are not supported. MP3 Pro files are not supported.

### Playback of MP3 Files

When a medium containing MP3 data is loaded, the radio checks all files on the medium. If the medium contains a lot of folders or files, the radio will take more time to start playing the MP3 files.

Loading times for playback of MP3 files may be affected by the following:

- Media - CD-RW media may take longer to load than CD-R media
- Medium formats - Multisession discs may take longer to load than non-multisession discs

- Number of files and folders - Loading times will increase with more files and folders

To increase the speed of disc loading, it is recommended to use CD-R media and single-session discs. To create a single-session disc, enable the “Disc at Once” option before writing to the disc.

### **Operation Instructions - Auxiliary Mode**

The auxiliary (AUX) jack is an audio input jack, which allows the user to plug in a portable device, such as an MP3 player, or cassette player, and utilize the vehicle’s audio system to amplify the source and play through the vehicle speakers.

Pressing the DISC/AUX button will change the mode to auxiliary device if the AUX jack is connected.

**NOTE:** The AUX device must be turned on and the device’s volume set to proper level. If the AUX audio is not loud enough, turn the device’s volume up. If the AUX audio sounds distorted, turn the device’s volume down.

### **TIME Button (Auxiliary Mode)**

Press this button to change the display to time of day. The time of day will display for five seconds (when ignition is OFF).

## SALES CODE RES/RSC — AM/FM STEREO RADIO WITH CD PLAYER (MP3 AUX JACK) AND SIRIUS RADIO

**NOTE:** The radio sales code is located on the lower right side of the radio faceplate.

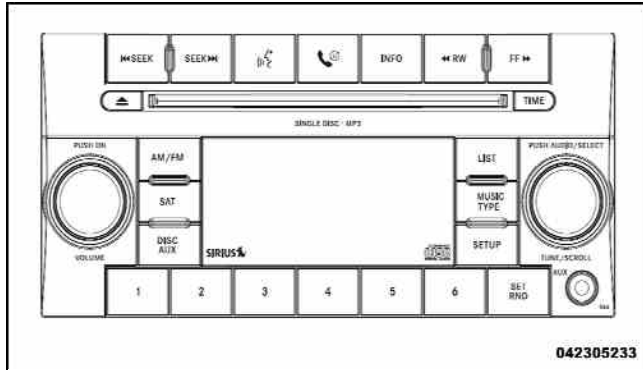

RES/RSC Radio

## Operating Instructions — Radio Mode

**NOTE:** The ignition switch must be in the ON or ACC position to operate the radio.

### Power Switch/Volume Control (Rotary)

Push the On/Volume control knob to turn on the radio. Push the On/Volume control knob a second time to turn off the radio.

### Electronic Volume Control

The electronic volume control turns continuously (360 degrees) in either direction without stopping. Turning the On/Volume control knob to the right increases the volume and to the left decreases it.

When the audio system is turned on, the sound will be set at the same volume level as last played.

**SEEK Buttons**

Press and release the SEEK buttons to search for the next listenable station in AM/FM mode. Press the right switch to seek up and the left switch to seek down. The radio will remain tuned to the new station until you make another selection. Holding either button will bypass stations without stopping until you release it.

**Voice Recognition System (Radio) — If Equipped**

Refer to “Voice Recognition System (VR)” in Section 3.

**Voice Recognition Button (UConnect® Hands-Free Phone) — If Equipped**

Press this button to operate the Hands-Free Phone (UConnect®) feature (if equipped). Refer to “Hands-Free Communication (UConnect®)” in Section 3.

If your vehicle is not equipped with or this feature is not available on your vehicle, a “Not Equipped With UConnect” message will display on the radio screen.

**Phone Button (UConnect® Hands-Free Phone) — If Equipped**

Press this button to operate the Hands-Free Phone (UConnect®) feature (if equipped). Refer to “Hands-Free Communication (UConnect®)” in Section 3.

If your vehicle is not equipped with or this feature is not available on your vehicle, a “Not Equipped With UConnect” message will display on the radio screen.

**TIME Button**

Press the TIME button and the time of day will display. In AM or FM mode, pressing the TIME button will switch between the time and frequency displays.

**Clock Setting Procedure**

1. Press and hold the TIME button, until the hours blink.
2. Adjust the hours by turning the right side Tune/Scroll control knob.

3. After adjusting the hours, press the right side Tune/Scroll control knob to set the minutes. The minutes will begin to blink.
4. Adjust the minutes using the right side Tune/Scroll control knob. Press the Tune/Scroll control knob to save time change.
5. To exit, press any button/knob or wait five seconds.

The clock can also be set by pressing the SETUP button. For vehicles equipped with satellite radio, press the SETUP button, use the Tune/Scroll control to select SET CLOCK, and then follow the above procedure, starting at Step 2. For vehicles not equipped with satellite radio, press the SETUP button and then follow the above procedure, starting at Step 2.

### **INFO Button**

Press the INFO button for an RDS station (one with call letters displayed). The radio will return a Radio Text message broadcast from an FM station (FM mode only).

### **RW/FF**

Pressing the RW (Rewind) or FF (Fast Forward) buttons causes the tuner to search for the next frequency in the direction of the arrows. This feature operates in either AM or FM frequencies.

### **TUNE Control**

Turn the rotary Tune/Scroll control knob clockwise to increase or counterclockwise to decrease the frequency.

### **Setting the Tone, Balance, and Fade**

Push the rotary Tune/Scroll control knob and BASS will display. Turn the Tune/Scroll control knob to the right or left to increase or decrease the bass tones.

Push the rotary Tune/Scroll control knob a second time and MID will display. Turn the Tune/Scroll control knob to the right or left to increase or decrease the mid-range tones.

Push the rotary Tune/Scroll control knob a third time and TREBLE will display. Turn the Tune/Scroll control knob to the right or left to increase or decrease the treble tones.

Push the rotary Tune/Scroll control knob a fourth time and BALANCE will display. Turn the Tune/Scroll control knob to the right or left to adjust the sound level from the right or left side speakers.

Push the rotary Tune/Scroll control knob a fifth time and FADE will display. Turn the Tune/Scroll control knob to the left or right to adjust the sound level between the front and rear speakers.

Push the rotary Tune/Scroll control knob again to exit setting tone, balance, and fade.

### MUSIC TYPE Button

Pressing this button once will turn on the Music Type mode for five seconds. Pressing the MUSIC TYPE button or turning the Tune/Scroll control knob within five seconds will allow the program format type to be selected. Many radio stations do not currently broadcast Music Type information.

Toggle the MUSIC TYPE button to select the following format types:

Program Type	16-Digit Character Display
No program type or undefined	None
Adult Hits	Adlt Hit
Classical	Classicl
Classic Rock	Cls Rock
College	College
Country	Country



Program Type	16-Digit Character Display
Foreign Language	Language
Information	Inform
Jazz	Jazz
News	News
Nostalgia	Nostalgia
Oldies	Oldies
Personality	Persnlty
Public	Public
Rhythm and Blues	R & B
Religious Music	Rel Musc
Religious Talk	Rel Talk
Rock	Rock
Soft	Soft
Soft Rock	Soft Rck
Soft Rhythm and Blues	Soft R&B

Program Type	16-Digit Character Display
Sports	Sports
Talk	Talk
Top 40	Top 40
Weather	Weather

By pressing the SEEK button when the Music Type icon is displayed, the radio will be tuned to the next frequency station with the same selected Music Type name. The Music Type function only operates when in the FM mode.

If a preset button is activated while in the Music Type (Program Type) mode, the Music Type mode will be exited and the radio will tune to the preset station.

**SETUP Button**

Pressing the SETUP button allows you to select between the following items:

- **Set Clock** — Pressing the SELECT button will allow you to set the clock. Turn the Tune/Scroll control knob to adjust the hours and then press and turn the Tune/Scroll control knob to adjust the minutes. Press the Tune/Scroll control knob again to save changes.

**AM/FM Button**

Press the button to select either AM or FM mode.

**SET/RND Button — To Set the Pushbutton Memory**

When you are receiving a station that you wish to commit to pushbutton memory, press the SET/RND button. The symbol SET 1 will now show in the display window. Select the button (1 to 6) you wish to lock onto this station and press and release that button. If a button is not selected within five seconds after pressing the SET/RND button, the station will continue to play but will not be stored into pushbutton memory.

You may add a second station to each pushbutton by repeating the above procedure with this exception: Press the SET/RND button twice and SET 2 will show in the display window. Each button can be set for SET 1 and SET 2 in both AM and FM. This allows a total of 12 AM and 12 FM stations to be stored into pushbutton memory. The stations stored in SET 2 memory can be selected by pressing the pushbutton twice.

Every time a preset button is used, a corresponding button number will display.

**Buttons 1 - 6**

These buttons tune the radio to the stations that you commit to pushbutton memory (12 AM and 12 FM stations).

**DISC/AUX Button**

Pressing the DISC/AUX button will allow you to switch from AM/FM modes to DISC/AUX mode.

## Operation Instructions — CD MODE for CD and MP3 Audio Play

### NOTE:

- The ignition switch must be in the ON or ACC position to operate the radio.
- This radio is capable of playing compact discs (CD), recordable compact discs (CD-R), rewritable compact discs (CD-RW), compact discs with MP3 tracks and multisession compact discs with CD and MP3 tracks.

### Inserting Compact Disc(s)

Gently insert one CD into the CD player with the CD label facing up. The CD will automatically be pulled into the CD player and the CD icon will illuminate on the radio display. If a CD does not go into the slot more than 1.0 in (2.5 cm), a disc may already be loaded and must be ejected before a new disc can be loaded.

If you insert a disc with the ignition ON and the radio ON, the unit will switch from radio to CD mode and begin to play when you insert the disc. The display will show the disc number, the track number, and index time in minutes and seconds. Play will begin at the start of track 1.

### CAUTION!

- **This CD player will accept 4-3/4 in (12 cm) discs only. The use of other sized discs may damage the CD player mechanism.**
- **Do not use adhesive labels. These labels can peel away and jam the player mechanism.**
- **RES is a single CD player. Do not attempt to insert a second CD if one is already loaded.**
- **Dual-media disc types (one side is a DVD, the other side is a CD) should not be used, and they can cause damage to the player.**

**EJECT Button - Ejecting a CD**

Press the EJECT button to eject the CD.



If you have ejected a disc and have not removed it within 10 seconds, it will be reloaded. If the CD is not removed, the radio will reinsert the CD but will not play it.

A disc can be ejected with the radio and ignition OFF.

**NOTE:** Ejecting with ignition OFF is not allowed on convertible or soft-top models (if equipped).

**SEEK Button**

Press the right SEEK button for the next selection on the CD. Press the left SEEK button to return to the beginning of the current selection, or return to the beginning of the previous selection if the CD is within the first second of

the current selection. Pressing and holding the SEEK button will allow faster scrolling through the tracks in CD, MP3 modes.

**TIME Button**

Press this button to change the display from a large CD playing time display to a small CD playing time display.

**RW/FF**

Press the RW button to stop the CD at the beginning of the current CD track/title.

Press and hold FF (Fast Forward) and the CD player will begin to fast forward until FF is released or RW or another CD button is pressed. The RW (Reverse) button works in a similar manner.

**AM/FM Button**

Press the button to select either AM or FM mode.

### **SET/RND Button (Random Play Button)**

Press this button while the CD is playing to activate Random Play. This feature plays the selections on the compact disc in random order to provide an interesting change of pace.

Press the right SEEK button to move to the next randomly selected track.

Press the SET/RND button a second time to stop Random Play.

### **Notes On Playing MP3 Files**

The radio can play MP3 files; however, acceptable MP3 file recording media and formats are limited. When writing MP3 files, pay attention to the following restrictions.

### **Supported Media (Disc Types)**

The MP3 file recording media supported by the radio are CDDA, CD-R, CD-RW, MP3, and CDDA+MP3.

### **Supported Medium Formats (File Systems)**

The medium formats supported by the radio are ISO 9660 Level 1 and Level 2 and includes the Joliet extension. When reading discs recorded using formats other than ISO 9660 Level 1 and Level 2, the radio may fail to read files properly and may be unable to play the file normally. UDF and Apple HFS formats are not supported.

The radio uses the following limits for file systems:

- Maximum number of folder levels: 8
- Maximum number of files: 255
- Maximum number of folders. (The radio display of file names and folder names is limited. For large numbers of files and/or folders, the radio may be unable to display the file name and folder name and will assign a number instead. With a maximum number of files, exceeding 20 folders will result in this display. With 200 files, exceeding 50 folders will result in this display.)

- Maximum number of characters in file/folder names:
  - Level 1: 12 (including a separator "." and a three-character extension)
  - Level 2: 31 (including a separator "." and a three-character extension)

Multisession disc formats are supported by the radio. Multisession discs may contain combinations of normal CD audio tracks and computer files (including MP3 files). Discs created with an option such as "keep disc open after writing" are most likely multisession discs. The use of multisession for CD audio or MP3 playback may result in longer disc loading times.

### Supported MP3 File Formats

The radio will recognize only files with the \*.MP3 extension as MP3 files. Non-MP3 files named with the \*.MP3

extension may cause playback problems. The radio is designed to recognize the file as an invalid MP3 and will not play the file.

When using the MP3 encoder to compress audio data to an MP3 file, the bit rate and sampling frequencies in the following table are supported. In addition, variable bit rates (VBR) are also supported. The majority of MP3 files use a 44.1 kHz sampling rate and a 192, 160, 128, 96 or VBR bit rates.

MPEG Specification	Sampling Frequency (kHz)	Bit Rate (kbps)
MPEG-1 Audio Layer 3	48, 44.1, 32	320, 256, 224, 192, 160, 128, 112, 96, 80, 64, 56, 48, 40, 32
MPEG-2 Audio Layer 3	24, 22.05, 16	160, 128, 144, 112, 96, 80, 64, 56, 48, 40, 32, 24, 16, 8

ID3 Tag information for artist, song title, and album title are supported for version 1 ID3 tags. ID3 version 2 is not supported by the radios.

Playlist files are not supported. MP3 Pro files are not supported.

### Playback of MP3 Files

When a medium containing MP3 data is loaded, the radio checks all files on the medium. If the medium contains a lot of folders or files, the radio will take more time to start playing the MP3 files.

Loading times for playback of MP3 files may be affected by the following:

- Media - CD-RW media may take longer to load than CD-R media
- Medium formats - Multisession discs may take longer to load than non-multisession discs

- Number of files and folders - Loading times will increase with more files and folders

To increase the speed of disc loading, it is recommended to use CD-R media and single-session discs. To create a single-session disc, enable the “Disc at Once” option before writing to the disc.

### LIST Button (CD Mode for MP3 Play)

Pressing the LIST button will bring up a list of all folders on the disc. Scrolling up or down the list is done by turning the Tune/Scroll control knob. Selecting a folder by pressing the Tune/Scroll control knob will begin playing the files contained in that folder (or the next folder in sequence if the selection does not contain playable files).

The folder list will time out after five seconds.

**INFO Button (CD Mode for MP3 Play)**

Pressing the INFO button repeatedly will scroll through the following TAG information: Song Title, Artist, File Name, and Folder Name (if available).

Press the INFO button once more to return to "elapsed time" priority mode.

Press and hold the INFO button for three seconds or more and the radio will display song titles for each file.

Press and hold the INFO button again for three seconds to return to "elapsed time" display.

**Operation Instructions - Auxiliary Mode**

The auxiliary (AUX) jack is an audio input jack, which allows the user to plug in a portable device such as an MP3 player, or cassette player, and utilize the vehicle's audio system to amplify the source and play through the vehicle speakers.

Pressing the AUX button will change the mode to auxiliary device if the AUX jack is connected.

**NOTE:** The AUX device must be turned on and the device's volume set to proper level. If the AUX audio is not loud enough, turn the device's volume up. If the AUX audio sounds distorted, turn the device's volume down.

**TIME Button (Auxiliary Mode)**

Press this button to change the display to time of day. The time of day will display for five seconds (when ignition is OFF).

**Operating Instructions - Hands-Free Phone (UConnect®) (If Equipped)**

Refer to "Hands-Free Communication (UConnect®)" in Section 3.

**Operating Instructions - Satellite Radio Mode (If Equipped)**

Refer to "Satellite Radio" in this section.



## **SATELLITE RADIO — IF EQUIPPED (REN/REQ/RER/RES/REU RADIOS ONLY)**

Satellite radio uses direct satellite-to-receiver broadcasting technology to provide clear digital sound, coast to coast. The subscription service provider is Sirius Satellite Radio. This service offers over 130 channels of music, sports, news, entertainment, and programming for children, directly from its satellites and broadcasting studios.

**NOTE:** Sirius service is not available in Hawaii and has limited coverage in Alaska.

### **System Activation**

Sirius Satellite Radio service is pre-activated, and you may begin listening immediately to the one year of audio service that is included with the factory-installed satellite radio system in your vehicle. Sirius will supply a welcome kit that contains general information, including

how to setup your on-line listening account at no additional charge. For further information, call the toll-free number 888-539-7474, or visit the Sirius web site at [www.sirius.com](http://www.sirius.com), or at [www.siriuscanada.ca](http://www.siriuscanada.ca) for Canadian residents.

### **Electronic Serial Number/Sirius Identification Number (ESN/SID)**

Please have the following information available when calling:

1. The Electronic Serial Number/Sirius Identification Number (ESN/SID).
2. Your Vehicle Identification Number.

To access the ESN/SID, refer to the following steps:

### **ESN/SID Access With REQ/RES Radios**

With the ignition switch in the ON/RUN or ACC position and the radio on, press the SETUP button and scroll using the Tune/Scroll control knob until Sirius ID is selected. Press the Tune/Scroll control knob and the Sirius ID number will display. The Sirius ID number display will time out in two minutes. Press any button on the radio to exit this screen.

### **ESN/SID Access With REN/RER Radios**

While in SAT mode, press the MENU button on the radio faceplate.

Next, touch the SUBSCRIPTION tab on the touch screen. All the ESNs that apply to your vehicle will display.

### **ESN/SID Access With REU Radio**

While in SAT mode, press the MENU button on the radio faceplate.

Next, turn the knob surrounding the joystick in the center of the radio to scroll to Subscription, and then press and release the joystick. All of the ESNs that apply to your vehicle will display.

### **Selecting Satellite Mode**

Press the SAT button until "SAT" appears in the display. A CD may remain in the radio while in the Satellite radio mode.

### **Satellite Antenna**

To ensure optimum reception, do not place items on the roof around the rooftop antenna location or strap items to the trunk lid around the trunk lid antenna (if equipped). Metal objects placed within the line of sight of the antenna will cause decreased performance. Larger luggage items such as bikes should be placed as far rearward as possible, within the loading design of the rack. Do not place items directly on or above the antenna.

## Reception Quality

Satellite reception may be interrupted due to one of the following reasons:

- The vehicle is parked in an underground parking structure or under a physical obstacle.
- Dense tree coverage may interrupt reception in the form of short audio mutes.
- Driving under wide bridges or along tall buildings can cause intermittent reception.
- Placing objects over or too close to the antenna can cause signal blockage.

## Operating Instructions — Satellite Mode

**NOTE:** The ignition switch must be in the ON or ACC position to operate the radio.

## SEEK Buttons

Press and release the SEEK buttons to search for the next channel in Satellite mode. Press the right switch to seek up and the left switch to seek down. The radio will remain tuned to the new channel until you make another selection. Holding either button will bypass channels without stopping until you release it.

## SCAN Button (When Equipped)

Pressing the SCAN button causes the tuner to search for the next channel, pausing for eight seconds before continuing to the next. To stop the search, press the SCAN button a second time.

**INFO Button — Except REU Radio**

Pressing the INFO button will cycle the display information between Artist, Song Title, and Composer (if available). Also, pressing and holding the INFO button for an additional three seconds will make the radio display the Song Title all of the time (press and hold again to return to normal display).

**INFO Button — REU Radio**

Pressing the INFO button will display information about Artist, Song Title, and Composer (if available). Pressing the INFO button again will close the INFO screen.

**RW/FF**

Pressing the RW (Rewind) or FF (Fast Forward) buttons causes the tuner to search for the next channel in the direction of the arrows.

**TUNE Control (Rotary)**

Turn the rotary Tune/Scroll control knob clockwise to increase or counterclockwise to decrease the channel.

**MUSIC TYPE Button — Except REU Radio**

Pressing this button once will turn on the Music Type mode for five seconds. Pressing the MUSIC TYPE button or turning the Tune/Scroll control knob within five seconds will allow the program format type to be selected.

Toggle the MUSIC TYPE button again to select the music type.

By pressing the SEEK button when the Music Type function is active, the radio will be tuned to the next channel with the same selected Music Type name.

If a preset button is activated while in the Music Type (Program Type) mode, the Music Type mode will be exited and the radio will tune to the preset channel.

### **MUSIC TYPE Button — REU Radio**

Pressing this button provides a MUSIC TYPES list from which you can make a selection. Once a selection is made, you can seek up, or down, or scan the channels and the radio will tune to the next station matching the selected format. There is no time-out for this screen. Pressing the MUSIC TYPE button again will close the MUSIC TYPE screen. Once closed, seek up, seek down, and scan will no longer be based on your selection.

### **SETUP Button**

Pressing the SETUP button allows you to select the following items:

- Display Sirius ID number — Press the AUDIO/SELECT button to display the Sirius ID number. This number is used to activate, deactivate, or change the Sirius subscription.

### **SET Button – To Set the Pushbutton Memory**

When you are receiving a channel that you wish to commit to pushbutton memory, press the SET button. The symbol SET 1 will now show in the display window. Select the button (1-6) you wish to lock onto this channel and press and release that button. If a button is not selected within five seconds after pressing the SET button, the channel will continue to play but will not be stored into pushbutton memory.

You may add a second channel to each pushbutton by repeating the above procedure with this exception: Press the SET button twice and SET 2 will show in the display window. Each button can be set for SET 1 and SET 2. This allows a total of 12 Satellite channels to be stored into pushbutton memory. The channels stored in SET 2 memory can be selected by pressing the pushbutton twice.

Every time a preset button is used, a corresponding button number will display.

**Buttons 1 - 6**

These buttons tune the radio to the channels that you commit to pushbutton memory (12 Satellite stations).

**Operating Instructions — Hands-Free Phone (If Equipped)**

Refer to “Hands-Free Communication (UConnect®)” in Section 3.

**Operating Instructions — Video Entertainment System (VES)<sup>™</sup> (If Equipped)**

Refer to separate “Video Entertainment System (VES)<sup>™</sup> Guide.”

**VIDEO ENTERTAINMENT SYSTEM (VES)<sup>™</sup> — IF EQUIPPED**

The optional Video Entertainment System (VES)<sup>™</sup> includes the following components for rear seat entertainment:

- A diagonal 7 in (17.8 cm) Liquid Crystal Display (LCD) screen integrated into the center console armrest. The screen features brightness control for optimum daytime and nighttime viewing.

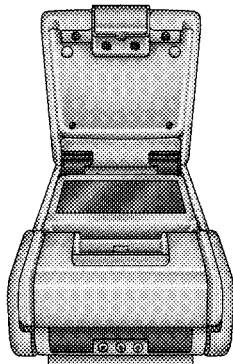

Opening the Rear Seat VES<sup>™</sup>

- The LCD screen swings up from the rear of the armrest to allow the rear seat passenger(s) to view the display.

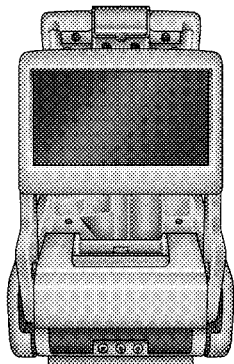

8199818b

VES™ Video Screen

**NOTE:** Close the armrest after the LCD screen has been raised to its viewing position.

- The touch screen radio and DVD player controls allow front seat operation for easy setup in the case of younger rear seat passengers.
- A battery-powered infrared remote control snaps into a molded compartment in the center console armrest upper storage bin.

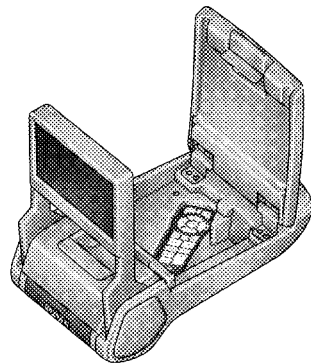

81abfb61

VES™ Remote Control

- Two wireless infrared headsets allow rear seat passengers to listen to the same or individual audio sources.

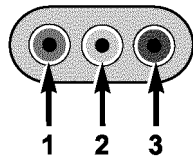

Audio/Video RCA Jacks (AUX Jacks) on the rear of the center console enable the monitor to display video directly from a video camera, connect video games for display on the screen, or play music directly from an MP3 player.

1. Video in (yellow)
2. Left audio in (white)
3. Right audio in (red)

**NOTE:** Refer to your “Vehicle Entertainment System (VES)<sup>™</sup> Users Manual” for detailed operating instructions.

## REMOTE SOUND SYSTEM CONTROLS — IF EQUIPPED

The remote sound system controls are located on the rear surface of the steering wheel. The left and right controls are rocker-type switches with a pushbutton in the center of each switch. Reach behind the steering wheel to access the switches.

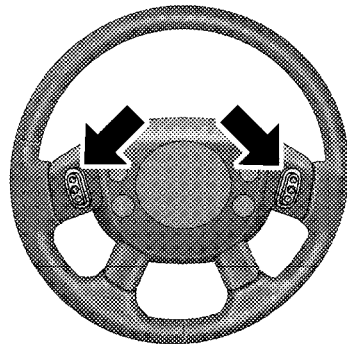

Remote Sound System Controls



### Right-Hand Switch Functions

- Press the top of the switch to increase the volume.
- Press the bottom of the switch to decrease the volume.
- Press the button in the center of the switch to change modes (i.e., AM, FM, etc.).

### Left-Hand Switch Functions for Radio Operation

- Press the top of the switch to SEEK the next listenable station up from the current setting.
- Press the bottom of the switch to SEEK the next listenable station down from the current setting.
- Press the button in the center of the switch to tune to the next preset that you have programmed.

### Left-Hand Switch Functions for Media (i.e., CD) Operation

- Press the top of the switch once to listen to the next track.
- Press the bottom of the switch once either to listen to the beginning of the current track or to listen to the beginning of the previous track if it is within one second after the current track begins to play.
- Press the switch up or down twice to listen to the second track, three times to listen to the third track, and so forth.
- Press the button located in the center of the switch to change to the next preset that you have programmed.

**CD/DVD MAINTENANCE**

To keep a CD/DVD in good condition, take the following precautions:

1. Handle the disc by its edge; avoid touching the surface.
2. If the disc is stained, clean the surface with a soft cloth, wiping from center to edge.
3. Do not apply paper or tape to the disc; avoid scratching the disc.
4. Do not use solvents such as benzene, thinner, cleaners, or antistatic sprays.
5. Store the disc in its case after playing.
6. Do not expose the disc to direct sunlight.
7. Do not store the disc where temperatures may become too high.

**NOTE:** If you experience difficulty in playing a particular disc, it may be damaged (i.e. scratched, reflective coating removed, a hair, moisture or dew on the disc) oversized, or have theft protection encoding. Try a known good disc before considering disc player service.

**RADIO OPERATION AND CELLULAR PHONES**

Under certain conditions, the cellular phone being ON in your vehicle can cause erratic or noisy performance from your radio. This condition may be lessened or eliminated by relocating the cellular phone antenna. This condition is not harmful to the radio. If your radio performance does not satisfactorily “clear” by the repositioning of the antenna, it is recommended that the radio volume be turned down or off during cellular phone operation.

## CLIMATE CONTROLS

The Air Conditioning and Heating System is designed to make you comfortable in all types of weather.

### Manual Heating Ventilation and Air Conditioning (HVAC)

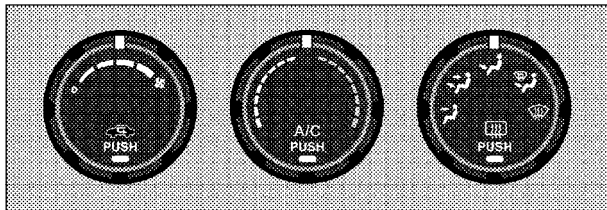

045605962

The Manual Temperature Controls consist of a series of outer rotary dials and inner push knobs.

### Blower Control



045605997

Rotate this control to regulate the amount of air forced through the ventilation system in any mode. The blower speed increases as you move the control to the right from the "O" (OFF) position. There are four blower speeds.

**NOTE:** For vehicles equipped with Remote Start, the climate controls will not function during Remote Start operation if the blower control is left in the "O" (Off) position.

## Temperature Control

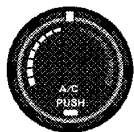

045605998

Rotate this control to regulate the temperature of the air inside the passenger compartment. Rotating the dial left into the blue area of the scale indicates cooler temperatures while the rotating right into the red area indicates warmer temperatures.

**NOTE:** If your air conditioning performance seems lower than expected, check the front of the A/C condenser located in front of the radiator for an accumulation of dirt or insects. Clean with a gentle water spray from behind the radiator and through the condenser. Fabric front fascia protectors may reduce airflow to the condenser, reducing air conditioning performance.

## Mode Control (Air Direction)



045605971

Rotate this control to choose from several patterns of air distribution. You can select either a primary mode as identified by the symbols on the control, or a blend of two of these modes. The closer the setting is to a particular symbol, the more air distribution you receive from that mode.

### *Panel*

 Air is directed through the outlets in the instrument panel. These outlets can be adjusted to direct airflow.

**NOTE:** The center instrument panel outlets can be aimed so that they are directed toward the rear seat passengers for maximum airflow to the rear.

### *Bi-Level*

 Air is directed through the panel and floor outlets.

**NOTE:** For all settings except full cold or full hot, there is a difference in temperature between the upper and lower outlets. The warmer air flows to the floor outlets. This feature gives improved comfort during sunny but cool conditions.

### *Floor*

 Air is directed through the floor outlets with a small amount flowing through the defrost and side window demist outlets.

### *Mix*

 Air is directed through the floor, defrost, and side window demist outlets. This setting works best in cold or snowy conditions that require extra heat to the windshield. This setting is good for maintaining comfort while reducing moisture on the windshield.

### *Defrost*



Air is directed through the windshield and side window demist outlets. Use this mode with maximum blower and temperature settings for best windshield and side window defrosting.

**NOTE:** The air conditioning compressor operates in Mix, Defrost, or a blend of these modes, even if the Air Conditioning (A/C) button is not pressed. This dehumidifies the air to help dry the windshield. To improve fuel economy, use these modes only when necessary.

### Recirculation Control



Pressing the Recirculation Control button will temporarily put the system in recirculation mode (ten minutes). This can be used when outside conditions such as smoke, odors, dust, or high humidity are present. Activating recirculation will cause the LED in the control button to illuminate. After ten minutes, the system will return to normal mode function and the LED will turn off.

#### NOTE:

- Continuous use of the recirculation mode may make the inside air stuffy and window fogging may occur. Extended use of this mode is not recommended.
- The use of the recirculation mode in cold or damp weather will cause windows to fog on the inside, because of moisture buildup inside the vehicle. Select the Outside Air position for maximum defogging.

- The A/C will engage automatically to prevent fogging when the recirculation button is pressed and the mode control is set to panel or panel / floor.
- The A/C can be deselected manually without disturbing the mode control selection.
- When the ignition switch is turned to the LOCK position, the recirculation feature will be cancelled.

### Air Conditioning Control

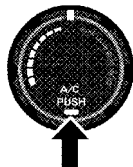

045605999

Press in on this button to engage the Air Conditioning. A light will illuminate when the Air Conditioning System is engaged. Rotating the dial left into the blue area of the scale indicates cooler temperatures while the rotating right into the red area indicates warmer temperatures.

**NOTE:** The air conditioning compressor will not engage until the engine has been running for about 10 seconds.

- **MAX A/C**

For maximum cooling use the A/C and recirculation buttons at the same time.

- **ECONOMY MODE**

If economy mode is desired, press the A/C button to turn OFF the indicator light and the A/C compressor. Then, move the temperature control to the desired temperature.

## Automatic Temperature Control (ATC) — If Equipped

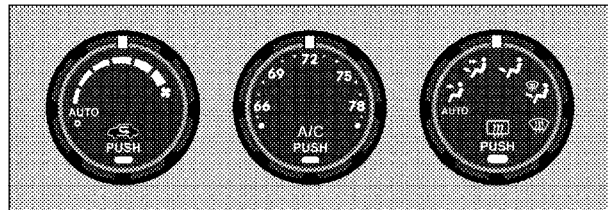

4

045605964

### Automatic Temperature Control

#### Automatic Operation

The Infrared Climate Control System automatically maintains the climate in the cabin of the vehicle at the comfort levels desired by the driver and passenger. To accomplish this, the system gathers information from the cabin infrared sensor mounted between the sun-visors and from various sensors located throughout the vehicle.

The controls on the climate control provide the system with operator input. Other sensors take account of vehicle speed, A/C pressure, outside temperature, and engine cooling temperature. Using all of these inputs, the system automatically adjusts airflow temperature, airflow distribution, airflow volume, and the amount of outside air recirculation. This maintains a comfortable temperature even under changing conditions.

Operation of the system is quite simple.

1. Turn the Mode Control knob (on the right) and the Blower Control knob (on the left) to AUTO.

**NOTE:** The AUTO position performs best for front seat occupants only.

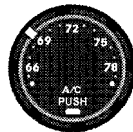

045606000

2. Dial in the temperature you would like the system to maintain by rotating the Temperature Control knob. Once the comfort level is selected, the system will maintain that level automatically using the heating system. Should the desired comfort level require air conditioning, the system will automatically make the adjustment.

You will experience the greatest efficiency by simply allowing the system to function automatically. Selecting the "O" (OFF) position on the blower control stops the system completely and closes the outside air intake.

72°F (22°C) is the recommended setting for maximum comfort for the average person; however, this may vary.



**NOTE:**

- The temperature setting can be adjusted at anytime without affecting automatic operation.
- Pressing the Air Conditioning Control button while in AUTO mode will cause the LED in the control button to flash three times and then turn off. This indicates that the system is in AUTO mode and requesting the air conditioning is not necessary.
- If your air conditioning performance seems lower than expected, check the front of the A/C condenser located in front of the radiator for an accumulation of dirt or insects. Clean with a gentle water spray from behind the radiator and through the condenser. Fabric front fascia protectors may reduce airflow to the condenser, reducing air conditioning performance.

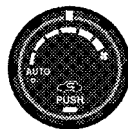
**Blower Control**

045606047

For full automatic operation or for automatic blower operation turn the knob to AUTO position. In manual mode there are six blower speeds that can be individual selected. In off position the blower will shut off.

**Manual Operation**

This system offers a full complement of manual override features, which consist of Blower Preferred Automatic, Mode Preferred Automatic, or Blower and Mode Preferred Automatic. This means the operator can override the blower, the mode, or both. There is a manual blower range for times when the AUTO setting is not desired. The blower can be set to any fixed blower speed by rotating the Blower Control knob (on the left).

**NOTE:** Please read the Automatic Temperature Control Operation Chart that follows for details.

Automatic Temperature Control Operation		The system will...				
Operation	How	Blower Control	Mode Control	Air Temperature Control	Air Recirculation Control	A/C Operation
Full Automatic Operation	Set blower knob to Auto. Set mode knob to Auto. Set temperature knobs for comfort.	Automatic	Automatic	Automatic	Automatic but can be overridden for 10 minutes at a time.	Automatic
Blower Preferred Automatic	Set blower knob to any desired airflow level other than Auto. Set mode knob to Auto. Set temperature knobs for comfort.	User selectable to any speed.	Automatic	Automatic	Automatic but can be overridden for 10 minutes at a time.	Automatic
Mode Preferred Automatic	Set mode knob to any desired air delivery point other than Auto. Set blower knob to Auto. Set temperature knobs for comfort.	Automatic	User selectable to any air delivery point.	Automatic	User selectable outside or recirculated.	User selectable A/C on or off.
Blower and Mode Preferred Automatic	Set blower knob to any desired airflow level other than Auto. Set mode knob to any desired air delivery point other than Auto. Set temperature knobs for comfort.	User selectable to any speed.	User selectable to any air delivery point.	Automatic	User selectable outside or recirculated.	User selectable A/C on or off.

The operator can override the AUTO mode setting to change airflow distribution by rotating the Mode Control knob (on the right) to one of the following positions.

- *Panel*

 Air is directed through the outlets in the instrument panel. These outlets can be adjusted to direct airflow.

**NOTE:** The center instrument panel outlets can be aimed so that they are directed toward the rear seat passengers for maximum airflow to the rear.

- *Bi-Level*

 Air is directed through the panel and floor outlets.

**NOTE:** For all settings except full cold or full hot, there is a difference in temperature between the upper and lower outlets. The warmer air flows to the floor outlets. This feature gives improved comfort during sunny but cool conditions.

- *Floor*

 Air is directed through the floor outlets with a small amount flowing through the defrost and side window demist outlets.

- *Mix*

 Air is directed through the floor, defrost, and side window demist outlets. This setting works best in cold or snowy conditions that require extra heat to the windshield. This setting is good for maintaining comfort while reducing moisture on the windshield.

- *Defrost*

 Air is directed through the windshield and side window demist outlets. Use this mode with maximum blower and temperature settings for best windshield and side window defrosting.

- *Air Conditioner Control*



Press this button to turn on the air conditioning during manual operation only. When the air conditioning is turned on, cool dehumidified air will flow through the outlets selected with the Mode control dial. Press this button a second time to turn OFF the air conditioning. An LED in the button illuminates when manual compressor operation is selected.

- *Recirculation Control*



The system will automatically control recirculation. However, pressing the Recirculation Control button will temporarily put the system in recirculation mode (ten minutes). This can be used when outside conditions such as smoke, odors, dust, or high humidity are present. Activating recirculation will cause the LED in the control button to illuminate. After ten minutes, the system will return to normal AUTO mode function and the LED will turn off.

**NOTE:**

- When the ignition switch is turned to the LOCK position, the recirculation feature will be cancelled.
- In cold weather, use of the Recirculation mode may lead to excessive window fogging. The Recirculation mode is not allowed in the floor, defrost, or defrost/floor mode in order to improve window clearing. Recirculation will be disabled automatically if these modes are selected.
- Extended use of recirculation may cause the windows to fog. If the interior of the windows begins to fog, press the Recirculation button to return to outside air. Some temp/humidity conditions will cause captured interior air to condense on windows and hamper visibility. For this reason, the system will not allow Recirculation to be selected while in floor, defrost, or defrost/floor mode. Attempting to use the recirculation while in these modes will cause the LED in the control button to blink and then turn off.

- Most of the time, when in Automatic Operation, you can temporarily put the system into Recirculation Mode by pressing the Recirculation Button. However, under certain conditions, while in Automatic Mode, the system is blowing air out the defrost vents. When these conditions are present, and the Recirculation Button is pressed, the indicator will flash and then turn off. This tells you that you are unable to go into recirculation mode at this time. If you would like the system to go into Recirculation Mode, you must first move the Mode Knob to Panel, Panel/Floor and then press the Recirculation Button. This feature reduces the possibility of window fogging.

### Operating Tips

**NOTE:** Refer to the chart at the end of this section for suggested control settings for various weather conditions.

### Summer Operation

The engine cooling system in air-conditioned vehicles must be protected with a high-quality antifreeze coolant to provide proper corrosion protection and to protect against engine overheating. A 50% solution of ethylene glycol antifreeze coolant in water is recommended. Refer to “Maintenance Procedures” in Section 7 of this manual for proper coolant selection.

### Winter Operation

Use of the air Recirculation mode during winter months is not recommended because it may cause window fogging.

### Vacation Storage

Anytime you store your vehicle, or keep it out of service (i.e., vacation) for two weeks or more, run the air conditioning system at idle for about five minutes in the fresh air and high blower settings. This will ensure adequate system lubrication to minimize the possibility of compressor damage when the system is started again.

### Window Fogging

Interior fogging on the windshield can be quickly removed by turning the mode selector to Defrost. The Defrost/Floor mode can be used to maintain a clear windshield and provide sufficient heating. If side window fogging becomes a problem, increase blower speed. Vehicle windows tend to fog on the inside in mild but rainy or humid weather.

**NOTE:** Recirculate without A/C should not be used for long periods as fogging may occur.

### Side Window Demisters

A side window demister outlet is located at each end of the instrument panel. These non-adjustable outlets direct air toward the side windows when the system is in the FLOOR, MIX, or DEFROST mode. The air is directed at the area of the windows through which you view the outside mirrors.











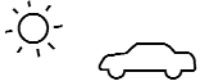





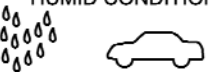

### Outside Air Intake

Make sure the air intake, located directly in front of the windshield, is free of obstructions such as leaves. Leaves collected in the air intake may reduce airflow, and if they enter the plenum, they could plug the water drains. In winter months, make sure the air intake is clear of ice, slush, and snow.

### A/C Air Filter — If Equipped

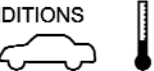
The A/C Filter prevents most dust and pollen from entering the cabin. The filter acts on air coming from outside the vehicle and recirculated air within the passenger compartment. Refer to “Maintenance Procedures” in Section 7 of this manual for A/C Air Filter service information or see your authorized dealer for service. Refer to the “Maintenance Schedules” in Section 8 of this manual for filter service intervals.

## Control Setting Suggestions for Various Weather Conditions

WEATHER	CONTROL SETTINGS
<p>HOT WEATHER AND VEHICLE INTERIOR IS VERY HOT</p> 	<p>Open the windows, start the vehicle. Set the Fan control to the high position (full clockwise). Press the  button. Set the Mode control at or between  and . Set the temperature control to full cool. After the hot air is pushed from the vehicle press the  button to turn recirculate on and roll up the windows. Once you are comfortable, press the  button to turn recirculate off and adjust the temperature control for comfort.</p>
<p>WARM WEATHER</p> 	<p>If it's sunny, set the Mode control at or near  and turn the air conditioning on. If it's cloudy or dark, set the Mode control at or near .</p>
<p>COOL OR COLD HUMID CONDITIONS</p> 	<p>If it's sunny, set the Mode control at or between  and  then turn the air conditioning on. If it's cloudy or dark, set the Mode control at or near  and turn the air conditioning on. If the windows begin to fog, set Mode control at or between  and .</p>
<p>COLD DRY CONDITIONS</p> 	<p>Set the Mode control at or near . If it is sunny, you may want more upper air. In this case, set the Mode control at or between  and . In very cold weather, if you need extra heat at the windshield, set the Mode control at or near the .</p>





# STARTING AND OPERATING

## CONTENTS

---

■ Starting Procedures . . . . .	267	□ Brake/Transaxle Interlock System . . . . .	271
□ Normal Starting . . . . .	267	□ Automatic Transaxle Ignition Interlock System . . . . .	272
□ Tip Start Feature . . . . .	268	□ 4 Speed/6 Speed Automatic Transaxle . . . . .	272
□ Extremely Cold Weather (Below $-20^{\circ}\text{F}$ Or $-29^{\circ}\text{C}$ ) . . . . .	268	■ AutoStick <sup>®</sup> — If Equipped . . . . .	276
□ If Engine Fails To Start . . . . .	268	□ Operation . . . . .	276
□ After Starting . . . . .	269	□ General Information . . . . .	277
■ Engine Block Heater — If Equipped . . . . .	269	■ Driving On Slippery Surfaces . . . . .	278
■ Automatic Transaxle . . . . .	270	□ Acceleration . . . . .	278

□ Traction . . . . .	278	□ Brake Assist System (BAS) . . . . .	292
■ Driving Through Water . . . . .	279	□ Electronic Stability Program (ESP) . . . . .	293
□ Flowing/Rising Water . . . . .	279	■ Tire Safety Information . . . . .	296
□ Shallow Standing Water . . . . .	279	□ Tire Markings . . . . .	296
■ Power Steering . . . . .	281	□ Tire Identification Number (TIN) . . . . .	300
□ Power Steering Fluid Check . . . . .	282	□ Tire Loading And Tire Pressure . . . . .	301
■ Parking Brake . . . . .	282	■ Tires — General Information . . . . .	305
■ Brake System . . . . .	285	□ Tire Pressure . . . . .	305
□ Anti-Lock Brake System — If Equipped . . . . .	286	□ Tire Inflation Pressures . . . . .	306
■ Anti—Lock Brake System (ABS) . . . . .	288	□ Radial-Ply Tires . . . . .	308
■ Electronic Brake Control System . . . . .	291	□ Compact Spare Tire — If Equipped . . . . .	309
□ Anti-Lock Brake System (ABS) . . . . .	291	□ Limited Use Spare — If Equipped . . . . .	310
□ Traction Control System (TCS) . . . . .	291	□ Tire Spinning . . . . .	311

□ Tread Wear Indicators . . . . .	311	□ Reformulated Gasoline . . . . .	326
□ Life Of Tire . . . . .	312	□ Gasoline/Oxygenate Blends . . . . .	326
□ Replacement Tires . . . . .	312	□ E-85 Usage In Non-Flex Fuel Vehicles . . . . .	327
■ Tire Chains . . . . .	314	□ MMT In Gasoline . . . . .	327
■ Snow Tires . . . . .	314	□ Materials Added To Fuel . . . . .	328
■ Tire Rotation Recommendations . . . . .	315	□ Fuel System Cautions . . . . .	328
■ Tire Pressure Monitor System (TPMS) . . . . .	316	□ Carbon Monoxide Warnings . . . . .	329
□ Base System . . . . .	318	■ Flexible Fuel— 2.7L Only (Except California Emission States) . . . . .	330
□ Premium System — If Equipped . . . . .	320	□ E-85 General Information . . . . .	330
□ General Information . . . . .	324	□ Ethanol Fuel (E-85) . . . . .	331
■ Fuel Requirements . . . . .	325	□ Fuel Requirements . . . . .	331
□ 2.4L And 2.7L Engine . . . . .	325	□ Selection Of Engine Oil For Flexible Fuel Vehicles (E-85) And Gasoline Vehicles . . . . .	332
□ 3.5L Engine . . . . .	325		

- Starting . . . . . 332
- Cruising Range . . . . . 333
- Replacement Parts . . . . . 333
- Maintenance . . . . . 333
- Adding Fuel . . . . . 333
  - Fuel Filler Cap (Gas Cap) . . . . . 333
  - Loose Filler Cap Message . . . . . 336
- Vehicle Loading . . . . . 336
  - Vehicle Certification Label . . . . . 336
  - Gross Vehicle Weight Rating (GVWR) . . . . . 337
  - Gross Axle Weight Rating (GAWR) . . . . . 337
  - Overloading . . . . . 337
  - Loading . . . . . 338
- Trailer Towing . . . . . 338
  - Common Towing Definitions . . . . . 338
  - Trailer Hitch Classification . . . . . 340
  - Trailer Towing Weights (Maximum Trailer Weight Ratings) . . . . . 341
  - Trailer And Tongue Weight . . . . . 342
  - Towing Requirements . . . . . 343
  - Towing Tips . . . . . 346
- Recreational Towing (Behind Motorhome, Etc.) . . . . . 348
  - Towing This Vehicle Behind Another Vehicle (Flat Towing With All Four Wheels On The Ground) . . . . . 348

## STARTING PROCEDURES

Before starting your vehicle, adjust your seat, adjust both inside and outside mirrors, and fasten your seat belt. Make sure all occupants have securely fastened their seat belts.

### WARNING!

- Never leave children alone in a vehicle. Leaving children in a vehicle unattended is dangerous for a number of reasons. A child or others could be seriously or fatally injured. Do not leave the key in the ignition. A child could operate power windows, other controls, or move the vehicle.
- Do not leave animals or children inside parked vehicles in hot weather; interior heat buildup may cause serious injury or death.

*(Continued)*

### WARNING! (Continued)

- Be sure to turn off the engine and remove the key from the ignition switch if you want to rest or sleep in your car. Accidents can be caused by inadvertently moving the gear selection lever or by pressing the accelerator pedal. This may cause excessive heat in the exhaust system, resulting in overheating and vehicle fire which may cause serious or fatal injuries.

### Normal Starting

The shift lever must be in the PARK or NEUTRAL position before you can start the engine. Apply the brakes before shifting to any driving gear.

**NOTE:** Normal starting of either a cold or a warm engine does not require pumping or depressing the accelerator pedal.

### Tip Start Feature

**Do not** press the accelerator. Turn the ignition key briefly to START position, and release it. The starter motor will continue to run, and it will disengage automatically when the engine is running. If the engine fails to start, the starter will disengage automatically in 10 seconds. If this occurs, turn the ignition switch to the LOCK position, wait 10 to 15 seconds, then repeat the normal starting procedure.

### Extremely Cold Weather (Below $-20^{\circ}\text{F}$ or $-29^{\circ}\text{C}$ )

To ensure reliable starting at these temperatures, use of an externally powered electric engine block heater (available from your authorized dealer) is recommended.

### If Engine Fails to Start

#### WARNING!

- **Never pour fuel or other flammable liquid into the throttle body air inlet opening in an attempt to start the vehicle. This could result in flash fire causing serious personal injury.**
- **Do not attempt to push or tow your vehicle to get it started. Vehicles equipped with an automatic transmission cannot be started this way. Unburned fuel could enter the catalytic converter and once the engine has started, ignite and damage the converter and vehicle. If the vehicle has a discharged battery, booster cables may be used to obtain a start from a booster battery or the battery in another vehicle. This type of start can be dangerous if done improperly. Refer to Section 6 for proper jump-starting procedures and follow them carefully.**

If the engine fails to start after you have followed the “Normal Starting” or “Extreme Cold Weather” procedures, it may be flooded. To clear any excess fuel, push the accelerator pedal all the way to the floor and hold it. Then, turn the ignition switch to the START position and release it as soon as the starter engages. The starter motor will disengage automatically in 10 seconds. Once this occurs, release the accelerator pedal, turn the ignition switch to the LOCK position, wait 10 to 15 seconds, then repeat the normal starting procedure.

### CAUTION!

To prevent damage to the starter, do not crank the engine for more than 15 seconds at a time. Wait 10 to 15 seconds before trying again.

### After Starting

The idle speed will automatically decrease as the engine warms up.

### ENGINE BLOCK HEATER — IF EQUIPPED

The engine block heater warms the engine, and permits quicker starts in cold weather. Connect the cord to a standard 110-115 Volt AC electrical outlet with a grounded, three-wire extension cord.

The engine block heater cord is routed under the hood on the passenger side of the vehicle near the right head lamp assembly. It is located between the front grille and the radiator, but underneath the black upper seal.

### WARNING!

Remember to disconnect the cord before driving. Damage to the 110-115 Volt electrical cord could cause electrocution.

**AUTOMATIC TRANSAXLE****CAUTION!**

Damage to the transaxle may occur if the following precautions are not observed:

- Shift the shift lever into PARK only after the vehicle has come to a complete stop.
- Shift the shift lever into or out of REVERSE only after the vehicle has come to a complete stop and the engine is at idle speed.
- Do not shift the shift lever from REVERSE, PARK, or NEUTRAL into any forward gear when the engine is above idle speed.
- Before shifting the shift lever into any gear, make sure your foot is firmly on the brake pedal.

**NOTE:** You MUST press and hold the brake pedal down while shifting the shift lever out of PARK.

**WARNING!**

- It is dangerous to move the shift lever out of or if the engine speed is higher than idle speed. If your foot is not firmly on the brake pedal, the vehicle could accelerate quickly forward or in reverse. You could lose control of the vehicle and hit someone or something. Only shift into gear when the engine is idling normally and when your right foot is firmly on the brake pedal.

*(Continued)*



**WARNING! (Continued)**

- Unintended movement of a vehicle could injure those in and near the vehicle. As with all vehicles, you should never exit a vehicle while the engine is running. Before exiting a vehicle, you should always shift the vehicle into PARK, remove the key from the ignition, and apply the parking brake. Once the key is removed from the ignition, the shift lever is locked in the PARK position, securing the vehicle against unwanted movement. Furthermore, you should never leave children unattended inside a vehicle.

**Brake/Transaxle Interlock System**

This system prevents you from moving the shift lever out of PARK and into any gear unless the brake pedal is pressed. This system is active only while the ignition switch is in the ON position. **Always press the brake pedal first, before moving the shift lever out of PARK.**

**NOTE:** If a malfunction occurs, the transaxle will not shift out of PARK. Battery power is required to release the Brake/Transaxle Interlock system. However, an override system allows you to shift out of PARK in case of loss of power. To activate the override system:

- Firmly apply the parking brake.
- Insert the ignition key into the ignition key lock cylinder and rotate it to the ON position.
- Remove the cup holder liner.
- Insert a key, screwdriver, or finger into the hole at the front of the cup holder and push and hold the manual override release lever forward.
- While holding the release lever forward, move the shift lever from PARK to NEUTRAL.
- Release the manual override.

**NOTE:** If this occurs, even if the override is successful, it is recommended that you visit a dealer at your earliest possible convenience. Your dealer has diagnostic equipment to determine if the problem could recur.

### **Automatic Transaxle Ignition Interlock System**

This system prevents the key from being removed unless the shift lever is in PARK. It also prevents shifting out of PARK unless the key is in the ON position, and the brake pedal is applied.

**NOTE:** If a malfunction occurs, the system will trap the key in the ignition switch lock cylinder to warn you that this safety feature is inoperable. The engine can be started and stopped, but the key cannot be removed until you obtain service.

### **4 Speed/6 Speed Automatic Transaxle**

The electronically controlled transaxle provides a precise shift schedule. The transaxle electronics are self-calibrating; therefore, the first few shifts on a new vehicle may be somewhat abrupt. This is a normal condition, and precision shifts will develop within a few hundred miles.

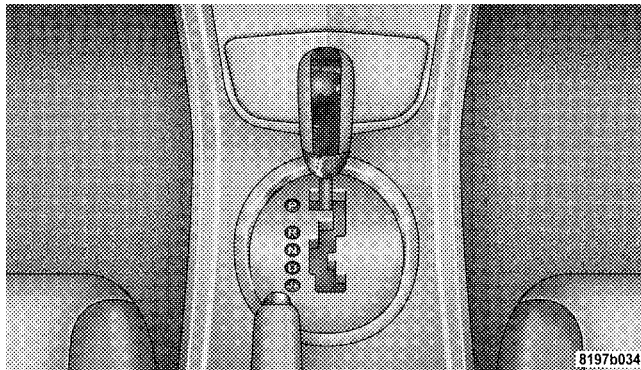

**Shift Lever**

## Gear Ranges

### *PARK*

Supplements the parking brake by locking the transaxle. The engine can be started in this range. Never attempt to use PARK while vehicle is in motion. Apply parking brake when leaving vehicle in this range.

When parking on a flat surface, place the shift lever into the PARK position first, and then apply the parking brake.

When parking on a hill, it is important to set the parking brake before placing the shift lever in PARK, otherwise the load on the transaxle locking mechanism may make it difficult to move the shift lever out of PARK. As an added precaution, turn the front wheels toward the curb on a downhill grade and away from the curb on an uphill grade.

### **WARNING!**

**Never use PARK as a substitute for the parking brake. Always apply parking brake fully when parked to guard against vehicle movement and possible injury or damage.**

### **CAUTION!**

**DO NOT race the engine when shifting from PARK or NEUTRAL positions into another gear range as this can damage the drivetrain.**

### *REVERSE*

Use this range for moving the vehicle rearward. Shift into this range only after the vehicle has come to a complete stop.

### NEUTRAL

Engine may be started in this range.

#### WARNING!

**Do not coast in NEUTRAL and never turn off the ignition to coast down a hill. These are unsafe practices that limit your response to changing traffic or road conditions. You might lose control of the vehicle and have an accident.**

### DRIVE – 6 Speed Transaxle

This range should be used for most city and highway driving. It provides the smoothest upshifts, downshifts, and best fuel economy. However, use the AutoStick® mode and select the appropriate gear when frequent transaxle shifting occurs in the DRIVE range. For example: When operating the vehicle under heavy loading conditions, (i.e. in hilly terrain, traveling into strong headwinds, or while towing heavy trailers). Under these

conditions, reducing shifting by selecting the appropriate gear in AutoStick® will improve the performance and extend transmission life by reducing excessive shifting and heat build-up.

### DRIVE – 4 Speed Transaxle

This range should be used for most city and highway driving, it provides the smoothest upshifts, downshifts, and best fuel economy. However, select the "3" range when frequent transaxle shifting occurs while using the DRIVE range, such as when operating the vehicle under heavy loading conditions, (i.e. in hilly terrain, traveling into strong headwinds, or while towing heavy trailers). Under these conditions, using the "3" range will improve performance and extend transaxle life by reducing excessive shifting and heat build-up.

### *DRIVE 3 — 4 Speed Transaxle*

This range eliminates shifts into fourth gear. The transaxle will operate normally in first and second gear. Shifts into third gear may be delayed to provide second gear operation at higher speeds. The "3" range should also be used when descending steep grades to prevent brake system distress

**NOTE:** Using the "3" range while operating the vehicle under heavy operating conditions will improve performance and extend transaxle life by reducing excessive shifting and heat build-up.

### *LOW With 4-Speed Transaxle*

This range should be used for engine braking when descending very steep grades. In this range, upshifts will occur only to prevent engine overspeed while downshifts occur earlier than other gear range selections.

## CAUTION!

If the transaxle operating temperature exceeds acceptable limits, the vehicle computer will override DRIVE (OVERDRIVE) and [5] for 6-Speed AutoStick® transaxle and [3] for 4-Speed auto transaxle, range by changing shift points. This is done to prevent transaxle damage due to overheating.

### **Reset Mode - Electronic Transaxle**

The transaxle is monitored electronically for abnormal conditions. If a condition is detected that could cause damage, the transaxle automatically shifts into 2nd gear (3rd gear for 6-speed). The transaxle remains in 2nd gear (3rd gear for 6-speed) despite the forward gear selected. PARK, REVERSE, and NEUTRAL will continue to operate. This Reset feature allows the vehicle to be driven to a dealer for service without damaging the transaxle.

In the event of a momentary problem, the transaxle can be reset to regain all forward gears by performing the following steps:

1. Stop the vehicle.
2. Shift the shift lever into PARK.
3. Turn the ignition switch to the LOCK position.
4. Restart the engine.
5. Shift the shift lever into the desired gear range and resume driving.

**NOTE:** Even if the transaxle can be reset, it is recommended that you visit a dealer at your earliest possible convenience. Your dealer has diagnostic equipment to determine if the problem could recur.

If the transaxle cannot be reset, dealer service is required.

### **AUTOSTICK® — IF EQUIPPED**

AutoStick® is a driver-interactive transaxle that offers six manual ratio changes to provide you with more control. AutoStick® allows you to maximize engine braking, eliminate undesirable upshifts and downshifts, and improve overall vehicle performance. This system can also provide you with more control during passing, city driving, cold slippery conditions, mountain driving, trailer towing, and many other situations.

### **Operation**

By placing the shift lever one shift-level below the DRIVE position, it can be moved from side to side. This allows the driver to select a higher or lower range of gears. Moving the shift lever to the left (-) triggers a downshift and to the right (+) an upshift. The gear position will display in the instrument cluster on the transaxle range indicator.

**NOTE:** In Autostick® mode, the transaxle will only shift up or down when the driver moves the shift lever to the right (+) or left (-).

AutoStick® is deactivated when the shift lever is moved from the AutoStick (+/-) position into the DRIVE position.

### General Information

- You can start out in 1st or 2nd gear. The system will ignore attempts to upshift at too low of a vehicle speed.
- If a ratio other than 1st is selected, and the vehicle is brought to a stop, the transaxle control logic will automatically select the 1st gear ratio.
- Starting out in 2nd gear is helpful in snowy or icy conditions.
- Avoid using speed control when Autostick® is engaged.
- The transaxle will automatically shift up when maximum engine speed is reached while Autostick® is engaged.
- Transaxle shifting will be more noticeable when Autostick® is engaged.
- If a downshift would cause the engine to over-speed, that shift will not occur until it is safe for the engine. Mostly the transaxle will stay in the manually selected ratio, however.
- If the system detects powertrain overheating, the transaxle will revert to the automatic shift mode and remain in that mode until the powertrain cools off.
- If the system detects a problem, it will disable the AutoStick® mode and the transaxle will return to the automatic mode until the problem is corrected.

## DRIVING ON SLIPPERY SURFACES

### Acceleration

Rapid acceleration on snow covered, wet, or other slippery surfaces may cause the front wheels to pull erratically to the right or left. This phenomenon occurs when there is a difference in the surface traction under the front (driving) wheels.

### WARNING!

**Rapid acceleration on slippery surfaces is dangerous. Unequal traction can cause sudden pulling of the front wheels. You could lose control of the vehicle and possibly have an accident. Accelerate slowly and carefully whenever there is likely to be poor traction (ice, snow, wet, mud, loose sand, etc.).**

### Traction

When driving on wet or slushy roads, it is possible for a wedge of water to build up between the tire and road surface. This is hydroplaning and may cause partial or complete loss of vehicle control and stopping ability. To reduce this possibility, the following precautions should be observed:

1. Slow down during rainstorms or when roads are slushy.
2. Slow down if the road has standing water or puddles.
3. Replace the tires when tread wear indicators first become visible.
4. Keep the tires properly inflated.
5. Maintain enough distance between your vehicle and the vehicle in front of you to avoid a collision in a sudden stop.



## DRIVING THROUGH WATER

Driving through water more than a few inches/centimeters deep will require extra caution to ensure safety and prevent damage to your vehicle.

### Flowing/Rising Water

#### WARNING!

Do not drive on or cross a road or a path where water is flowing and/or rising (as in storm run-off). Flowing water can wear away the road or path's surface and cause your vehicle to sink into deeper water. Furthermore, flowing and/or rising water can carry your vehicle away swiftly. Failure to follow this warning may result in injuries that are serious or fatal to you, your passengers, and others around you.

### Shallow Standing Water

Although your vehicle is capable of driving through shallow standing water, consider the following Caution and Warning before doing so.

#### CAUTION!

- Always check the depth of the standing water before driving through it. Never drive through standing water that is deeper than the bottom of the tire rims mounted on the vehicle.
- Determine the condition of the road or the path that is under water and if there are any obstacles in the way before driving through the standing water.
- Do not exceed 5 mph (8 km/h) when driving through standing water. This will minimize wave effects.

*(Continued)*

**CAUTION! (Continued)**

- Driving through standing water may cause damage to your vehicle's drivetrain components. Always inspect your vehicle's fluids (i.e., engine oil, transmission/transaxle, axle, etc.) for signs of contamination (i.e., fluid that is milky or foamy in appearance) after driving through standing water. Do not continue to operate the vehicle if any fluid appears contaminated, as this may result in further damage. Such damage is not covered by the New Vehicle Limited Warranty.
- Getting water inside your vehicle's engine can cause it to lock up and stall out, and cause serious internal damage to the engine. Such damage is not covered by the New Vehicle Limited Warranty.

**WARNING!**

- Driving through standing water limits your vehicle's traction capabilities. Do not exceed 5 mph (8 km/h) when driving through standing water.
- Driving through standing water limits your vehicle's braking capabilities, which increases stopping distances. Therefore, after driving through standing water, drive slowly and lightly press on the brake pedal several times to dry the brakes.
- Getting water inside your vehicle's engine can cause it to lock up and stall out, and leave you stranded.
- Failure to follow these warnings may result in injuries that are serious or fatal to you, your passengers, and others around you.

## POWER STEERING

The standard power steering system will give you good vehicle response and increased ease of maneuverability in tight spaces. The system will provide mechanical steering capability if power assist is lost.

If for some reason the power assist is interrupted, it will still be possible to steer your vehicle. Under these conditions, you will observe a substantial increase in steering effort, especially at very low vehicle speeds and during parking maneuvers.

**NOTE:** Increased noise levels at the end of the steering wheel travel are considered normal and do not indicate that there is a problem with the power steering system.

Upon initial start-up in cold weather, the power steering pump may make noise for a short amount of time. This is due to the cold, thick fluid in the steering system. This noise should be considered normal, and it does not in any way damage the steering system.

### WARNING!

**Continued operation with reduced power steering assist could pose a safety risk to yourself and others. Service should be obtained as soon as possible.**

### CAUTION!

**Prolonged operation of the steering system at the end of the steering wheel travel will increase the steering fluid temperature and it should be avoided when possible. Damage to the power steering pump may occur.**

### Power Steering Fluid Check

Checking the power steering fluid level at a defined service interval is not required. The fluid should only be checked if a leak is suspected, abnormal noises are apparent, and/or the system is not functioning as anticipated. Coordinate inspection efforts through an authorized dealer.

No chemical flushes should be used in any power steering system; only the approved lubricant may be used.

#### **WARNING!**

Fluid level should be checked on a level surface and with the engine off to prevent injury from moving parts and to ensure accurate fluid level reading. Do not overfill. Use only manufacturer's recommended power steering fluid.

If necessary, add fluid to restore to the proper indicated level. With a clean cloth, wipe any spilled fluid from all surfaces. Refer to "Fluids, Lubricants, and Genuine Parts" in Section 7 for the correct fluid type.

### PARKING BRAKE

The parking brake should always be applied when the driver is not in the vehicle.

#### **WARNING!**

Never use the PARK position as a substitute for the parking brake. Always apply parking brake fully when parked to guard against vehicle movement and possible injury or damage.

When parking on a flat surface, place the shift lever in the PARK position first, and then apply the parking brake.

When parking on a hill, it is important to apply the parking brake before placing the shift lever in PARK, otherwise the load on the transaxle locking mechanism may make it difficult to move the shift lever out of PARK. As an added precaution, turn the front wheels toward the curb on a downhill grade and away from the curb on an uphill grade.

To apply the parking brake, grasp the handle and pull it upward until you feel resistance. To release the parking brake, grasp the handle and pull it slightly while pressing the button on the end of the handle. When the button drops into the handle (releasing the lock), guide the handle downward to its stop, and then release the button and the handle.

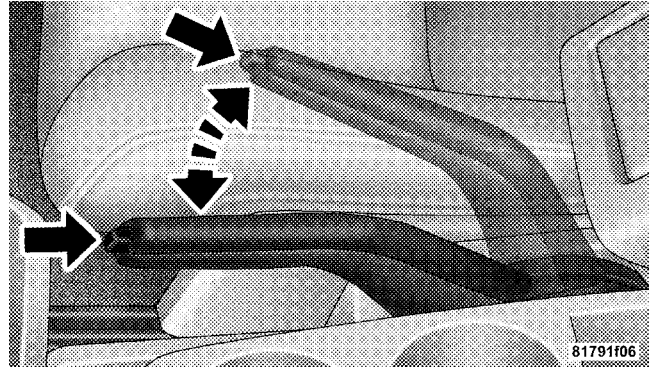

Parking Brake

**NOTE:**

- The parking brake will not release unless the handle is pulled upward slightly past its applied position.

- If the parking brake is applied while the vehicle is moving, a chime will sound to alert the driver. The chime will sound up to 10 times or until the vehicle has returned to a stop.

The Brake System Warning Light in the instrument cluster will turn on when the parking brake is applied and the ignition switch is on.

**NOTE:** This light only shows that the parking brake is applied. It does not show the degree of brake application.

### **CAUTION!**

If the Brake System Warning Light remains on with the parking brake released, a brake system malfunction is indicated. Have the brake system serviced by an authorized dealer immediately.

### **WARNING!**

- **Never leave children alone in a vehicle. Leaving children in a vehicle unattended is dangerous for a number of reasons. A child or others could be seriously or fatally injured. Do not leave the key in the ignition. A child could operate power windows, other controls, or move the vehicle.**
- **Be sure the parking brake is fully disengaged before driving: failure to do so can lead to brake failure, and an accident.**

## BRAKE SYSTEM

**BRAKE** Your vehicle is equipped with dual hydraulic brake systems. If either of the two hydraulic systems loses normal capability, the remaining system will still function. However, there will be some loss of overall braking effectiveness. This will be evident by increased pedal travel during application and greater pedal force required to slow or stop the vehicle. In addition, if the malfunction is caused by a leak in the hydraulic system, the Brake System Warning Light will turn on as the brake fluid level drops in the master cylinder.

In the event power assist is lost for any reason (i.e., repeated brake applications with the engine OFF) the brakes will still function. However, the effort required to brake the vehicle will be much greater than that required with the power system operating.

### WARNING!

- **Riding the brakes can lead to brake failure and possibly an accident. Driving with your foot resting or riding on the brake pedal can result in abnormally high brake temperatures, excessive lining wear, and possible brake damage. You wouldn't have your full braking capacity in an emergency.**
- **Driving a vehicle with the Brake System Warning Light on is dangerous. A significant decrease in braking performance or vehicle stability during braking may occur. It will take you longer to stop the vehicle or will make your vehicle harder to control. You could have an accident. Have the vehicle checked immediately.**

### Anti-Lock Brake System — If Equipped

The Anti-Lock Brake System (ABS) provides increased vehicle stability and brake performance under most braking conditions. The system automatically “pumps” the brakes during severe braking conditions to prevent wheel lock-up.

When the vehicle is driven over 7 mph (11 km/h), you may also hear a slight clicking sound as well as some related motor noises. These noises are the system performing its self check cycle to ensure that the ABS is working properly. This self check occurs each time the vehicle is started and accelerated past 7 mph (11 km/h).

ABS is activated during braking under certain road or stopping conditions. ABS-inducing conditions can include ice, snow, gravel, bumps, railroad tracks, loose debris, or panic stops.

You also may experience the following when the brake system goes into Anti-lock:

- The ABS motor running (it may continue to run for a short time after the stop),
- The clicking sound of solenoid valves,
- Brake pedal pulsations, and
- A slight drop or fall away of the brake pedal at the end of the stop.

These are all normal characteristics of ABS.

#### **WARNING!**

- **The ABS contains sophisticated electronic equipment that may be susceptible to interference caused by improperly installed or high output radio transmitting equipment. This interference can cause possible loss of anti-lock braking capability. Installation of such equipment should be performed by qualified professionals.**

*(Continued)*



**WARNING! (Continued)**

- Pumping of the Anti-Lock Brakes will diminish their effectiveness and may lead to an accident. Pumping makes the stopping distance longer. Just press firmly on your brake pedal when you need to slow down or stop.
- The ABS cannot prevent the natural laws of physics from acting on the vehicle, nor can it increase braking or steering efficiency beyond that afforded by the condition of the vehicle brakes and tires or the traction afforded.
- The ABS cannot prevent accidents, including those resulting from excessive speed in turns, following another vehicle too closely, or hydroplaning. Only a safe, attentive, and skillful driver can prevent accidents.

*(Continued)*

**WARNING! (Continued)**

- The capabilities of an ABS equipped vehicle must never be exploited in a reckless or dangerous manner, which could jeopardize the user's safety or the safety of others.

All vehicle wheels and tires must be the same size and type and tires must be properly inflated to produce accurate signals for the computer.

**Anti-Lock Brake Light**

The Anti-Lock Brake Light monitors the ABS. The light will come on when the ignition switch is turned to the ON position and may stay on for as long as four seconds.

If the Anti-Lock Brake Light remains on or comes on while driving, it indicates that the Anti-Lock portion of the brake system is not functioning and that service is required. However, the conventional brake system will continue to operate normally if the Brake System Warning Light is not on.

If the Anti-Lock Brake Light is on, the brake system should be serviced as soon as possible to restore the benefits of Anti-Lock brakes. If the Anti-Lock Brake Light does not come on when the ignition switch is turned to the ON position, have the light repaired as soon as possible.

If both the Brake System Warning Light and the Anti-Lock Brake Light remain on, the ABS and Electronic Brake Force Distribution (EBD) systems are not functioning. Immediate repair to the ABS system is required.

### **ANTI—LOCK BRAKE SYSTEM (ABS)**

The Anti-Lock Brake System (ABS) provides increased vehicle stability and brake performance under most braking conditions. The system automatically “pumps” the brakes during severe braking conditions to prevent wheel lock-up.

#### **WARNING!**

- **Pumping of the Anti-Lock Brakes will diminish their effectiveness and may lead to an accident. Pumping makes the stopping distance longer. Just press firmly on your brake pedal when you need to slow down or stop.**

*(Continued)*

**WARNING! (Continued)**

- The ABS cannot prevent the natural laws of physics from acting on the vehicle, nor can it increase braking or steering efficiency beyond that afforded by the condition of the vehicle brakes and tires or the traction afforded.
- The ABS cannot prevent accidents, including those resulting from excessive speed in turns, following another vehicle too closely, or hydroplaning. Only a safe, attentive, and skillful driver can prevent accidents.
- The capabilities of an ABS equipped vehicle must never be exploited in a reckless or dangerous manner, which could jeopardize the user's safety or the safety of others.



The ABS light monitors the Anti-Lock Brake System. The light will come on when the ignition switch is turned to the ON position and may stay on for as long as four seconds.

If the ABS light remains on or comes on while driving, it indicates that the Anti-Lock portion of the brake system is not functioning and that service is required. However, the conventional brake system will continue to operate normally if the BRAKE warning light is not on.

If the ABS light is on, the brake system should be serviced as soon as possible to restore the benefits of Anti-Lock brakes. If the ABS light does not come on when the ignition switch is turned to the ON position, have the bulb repaired as soon as possible.

If both the Brake Warning Light and the ABS Light remain on, the Anti-Lock brakes (ABS) and Electronic Brake Force Distribution (EBD) systems are not functioning. Immediate repair to the ABS system is required. See your authorized Dealer Service Center.

When the vehicle is driven over 7 mph (11 km/h), you may also hear a slight clicking sound as well as some related motor noises. These noises are the system performing its self-check cycle to ensure that the ABS system is working properly. This self check occurs each time the vehicle is started and accelerated past 7 mph (11 km/h).

ABS is activated during braking under certain road or stopping conditions. ABS-inducing conditions can include ice, snow, gravel, bumps, railroad tracks, loose debris, or panic stops.

You also may experience the following when the brake system goes into Anti-lock:

- The ABS motor running (it may continue to run for a short time after the stop),
- the clicking sound of solenoid valves,
- brake pedal pulsations,
- and a slight drop or fall away of the brake pedal at the end of the stop.

These are all normal characteristics of ABS.

### **WARNING!**

**The Anti-Lock Brake System contains sophisticated electronic equipment that may be susceptible to interference caused by improperly installed or high output radio transmitting equipment. This interference can cause possible loss of anti-lock braking capability. Installation of such equipment should be performed by qualified professionals.**

All vehicle wheels and tires must be the same size and type and tires must be properly inflated to produce accurate signals for the computer.

### **ELECTRONIC BRAKE CONTROL SYSTEM**

Your vehicle may be equipped with an optional advanced electronic brake control system that includes Anti-Lock Brake System (ABS), Traction Control System (TCS), Brake Assist System (BAS), and Electronic Stability Program (ESP). All systems work together to enhance vehicle stability and control in various driving conditions and are commonly referred to as ESP.

#### **Anti-Lock Brake System (ABS)**

This system aids the driver in maintaining vehicle control under adverse braking conditions. The system controls hydraulic brake pressure to prevent wheel lock-up and help avoid skidding on slippery surfaces during braking. Refer to “Anti-Lock Brake System” in this Section of the manual for more information about ABS.

### **Traction Control System (TCS)**



This system monitors the amount of wheel spin of each of the driven wheels. If wheel spin is detected, brake pressure is applied to the slipping wheel(s) and engine power is reduced to provide enhanced acceleration and stability. A feature of the TCS system functions similar to a limited slip differential and controls the wheel spin across a driven axle. If one wheel on a driven axle is spinning faster than the other, the system will apply the brake of the spinning wheel. This will allow more engine torque to be applied to the wheel that is not spinning. This feature remains active even if TCS and ESP are in the “Partial Off” mode. Refer to “Electronic Stability Program (ESP)” in this Section of this manual.

### **Brake Assist System (BAS)**

The BAS is designed to optimize the vehicle's braking capability during emergency braking maneuvers. The system detects an emergency braking situation by sensing the rate and amount of brake application and then applies optimum pressure to the brakes. This can help reduce braking distances. The BAS complements the Anti-Lock Brake System (ABS). Applying the brakes very quickly results in the best BAS assistance. To receive the benefit of the system, you must apply continuous braking pressure during the stopping sequence. Do not reduce brake pedal pressure unless braking is no longer desired. Once the brake pedal is released, the BAS is deactivated.

#### **WARNING!**

- **BAS cannot prevent the natural laws of physics from acting on the vehicle, nor can it increase braking efficiency beyond that afforded by the condition of the vehicle brakes and tires or the traction afforded.**
- **The BAS cannot prevent accidents, including those resulting from excessive speed in turns, following another vehicle too closely, or hydroplaning. Only a safe, attentive, and skillful driver can prevent accidents.**
- **The capabilities of a BAS-equipped vehicle must never be exploited in a reckless or dangerous manner, which could jeopardize the user's safety or the safety of others.**

## Electronic Stability Program (ESP)

This system enhances directional control and stability of the vehicle under various driving conditions. ESP corrects for over/under steering of the vehicle by applying the brake of the appropriate wheel to assist in counteracting the over/under steer condition. Engine power may also be reduced to help the vehicle maintain the desired path. ESP uses sensors in the vehicle to determine the vehicle path intended by the driver and compares it to the actual path of the vehicle. When the actual path does not match the intended path, ESP applies the brake of the appropriate wheel to assist in counteracting the oversteer or understeer condition

- Oversteer - when the vehicle is turning more than appropriate for the steering wheel position.
- Understeer - when the vehicle is turning less than appropriate for the steering wheel position.

## ESP/TCS Indicator Light

The “ESP/TCS Indicator Light, located in the instrument cluster, starts to flash as soon as the tires lose traction and the ESP system becomes active. The ESP/TCS Indicator Light also flashes when TCS is active. If the ESP/TCS Indicator Light begins to flash during acceleration, ease up on the accelerator and apply as little throttle as possible. Be sure to adapt your speed and driving to the prevailing road conditions.

### WARNING!

- **Electronic Stability Program (ESP) cannot prevent the natural laws of physics from acting on the vehicle, nor can it increase the traction afforded by prevailing road conditions.**

*(Continued)*

**WARNING! (Continued)**

- **ESP cannot prevent accidents, including those resulting from excessive speed in turns, driving on very slippery surfaces, or hydroplaning. Only a safe, attentive, and skillful driver can prevent accidents.**
- **The capabilities of an ESP-equipped vehicle must never be exploited in a reckless or dangerous manner, which could jeopardize the user's safety or the safety of others.**

**ESP Operating Modes**

All ESP equipped vehicles can choose the following ESP operating modes:

***ESP On***

This is the normal operating mode for ESP. Whenever the vehicle is started the ESP system will be in this mode.

This mode should be used for almost all driving situations. ESP should only be turned to Partial Off for specific reasons as noted below.

***Partial ESP Mode***

This mode is entered by momentarily depressing the ESP Control Switch. When in Partial Off mode, the TCS portion of ESP, except for the limited slip feature described in the TCS section, has been disabled and the ESP/TCS Indicator Light will be illuminated. All other stability features of ESP function normally, with the exception of engine power reduction. This mode is intended to be used if the vehicle is in deep snow, sand, or gravel conditions and more wheel spin than ESP would normally allow is required to gain traction.

To turn ESP on again, momentarily depress the ESP Control Switch. This will restore the normal ESP On mode of operation.



**WARNING!**

**In the Partial ESP mode, the engine torque reduction and stability features are desensitized. Therefore, the enhanced vehicle stability offered by ESP is unavailable.**

**NOTE:** To improve the vehicle's traction when driving with snow chains, or starting off in deep snow, sand or gravel, it may be desirable to switch to the "Partial Off" mode by pressing the ESP switch. Once the situation requiring ESP to be switched to the "Partial Off" mode is overcome, turn ESP on again by momentarily depressing the "ESP Control Switch." This may be done while the vehicle is in motion.

## ESP/BAS Warning Light and ESP/TCS Indicator Light

### **ESP BAS**

The malfunction indicator for the ESP is combined with the BAS indicator. The yellow ESP/BAS Warning Light and the yellow ESP/TCS Indicator Light in the instrument cluster both come on when the ignition switch is turned to the ON position. They should both go out with the engine running. If the ESP/BAS Warning Light comes on continuously with the engine running, a malfunction has been detected in either the ESP or BAS system, or both. If this light remains on after several ignition cycles, and the vehicle has been driven several miles (kilometers) at speeds greater than 30 mph (48 km/h), see your authorized dealer as soon as possible to have the problem diagnosed and corrected.

**NOTE:**

- The ESP Indicator Light and the ESP/BAS Warning Light come on momentarily each time the ignition switch is turned ON.
- Each time the ignition is turned ON, the ESP System will be ON even if it was turned off previously.
- The ESP Control System will make buzzing or clicking sounds when it is active. This is normal; the sounds will stop when ESP becomes inactive following the maneuver that caused the ESP activation.

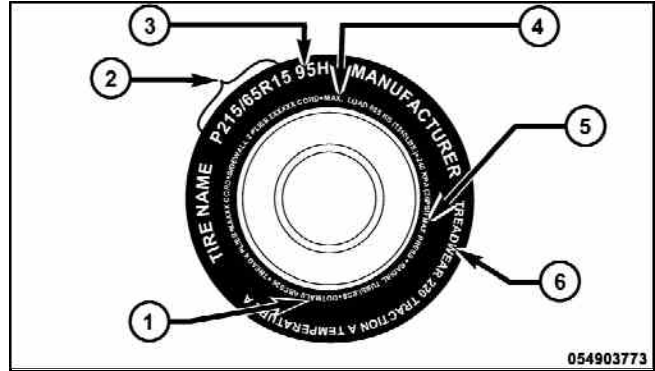
**TIRE SAFETY INFORMATION****Tire Markings**

- 1 — U.S. DOT Safety Standards Code (TIN)  
 2 — Size Designation  
 3 — Service Description

- 4 — Maximum Load  
 5 — Maximum Pressure  
 6 — Treadwear, Traction and Temperature Grades

**NOTE:**

- P (Passenger) - Metric tire sizing is based on U.S. design standards. P-Metric tires have the letter "P" molded into the sidewall preceding the size designation. Example: P215/65R15 95H.
- European-Metric tire sizing is based on European design standards. Tires designed to this standard have the tire size molded into the sidewall beginning with the section width. The letter "P" is absent from this tire size designation. Example: 215/65R15 96H.
- LT (Light Truck) - Metric tire sizing is based on U.S. design standards. The size designation for LT-Metric tires is the same as for P-Metric tires except for the letters "LT" that are molded into the sidewall preceding the size designation. Example: LT235/85R16.
- Temporary spare tires are high-pressure compact spares designed for temporary emergency use only. Tires designed to this standard have the letter "T" molded into the sidewall preceding the size designation. Example: T145/80D18 103M.
- High flotation tire sizing is based on U.S. design standards and it begins with the tire diameter molded into the sidewall. Example: 31x10.5 R15 LT.

## Tire Sizing Chart

<b>EXAMPLE:</b>
<b>Size Designation:</b>
<p><b>P</b> = Passenger car tire size based on U.S. design standards  <b>"...blank..."</b> = Passenger car tire based on European design standards  <b>LT</b> = Light truck tire based on U.S. design standards  <b>T</b> = Temporary spare tire  <b>31</b> = Overall diameter in inches (in)</p>
<b>215</b> = Section width in millimeters (mm)
<p><b>65</b> = Aspect ratio in percent (%)  — Ratio of section height to section width of tire</p>
<b>10.5</b> = Section width in inches (in)
<p><b>R</b> = Construction code  — "R" means radial construction  —"D" means diagonal or bias construction</p>
<b>15</b> = Rim diameter in inches (in)

## EXAMPLE:

**Service Description:**

**95** = Load Index

— A numerical code associated with the maximum load a tire can carry

**H** = Speed Symbol

— A symbol indicating the range of speeds at which a tire can carry a load corresponding to its load index under certain operating conditions

— The maximum speed corresponding to the speed symbol should only be achieved under specified operating conditions (i.e., tire pressure, vehicle loading, road conditions, and posted speed limits)

**Load Identification:**

"...blank..." = Absence of any text on the sidewall of the tire indicates a Standard Load (SL) tire

**Extra Load (XL)** = Extra load (or reinforced) tire

**Light Load** = Light load tire

**C, D, E** = Load range associated with the maximum load a tire can carry at a specified pressure

**Maximum Load** — Maximum load indicates the maximum load this tire is designed to carry

**Maximum Pressure** — Maximum pressure indicates the maximum permissible cold tire inflation pressure for this tire

**Tire Identification Number (TIN)**

The TIN may be found on one or both sides of the tire, however, the date code may only be on one side. Tires with white sidewalls will have the full TIN, including the date code, located on the white sidewall side of the tire.

Look for the TIN on the outboard side of black sidewall tires as mounted on the vehicle. If the TIN is not found on the outboard side, then you will find it on the inboard side of the tire.

**EXAMPLE:****DOT MA L9 ABCD 0301**

**DOT** = Department of Transportation

— This symbol certifies that the tire is in compliance with the U.S. Department of Transportation tire safety standards and is approved for highway use

**MA** = Code representing the tire manufacturing location (two digits)

**L9** = Code representing the tire size (two digits)

**ABCD** = Code used by the tire manufacturer (one to four digits)

**03** = Number representing the week in which the tire was manufactured (two digits)

—03 means the 3rd week.

**01** = Number representing the year in which the tire was manufactured (two digits)

—01 means the year 2001

— Prior to July 2000, tire manufacturers were only required to have one number to represent the year in which the tire was manufactured. Example: 031 could represent the 3rd week of 1981 or 1991

## Tire Loading and Tire Pressure

### Tire Placard Location

**NOTE:** The proper cold tire inflation pressure is listed on the driver's side B-Pillar.

### Tire and Loading Information Placard

**TIRE AND LOADING INFORMATION**

SEATING CAPACITY - TOTAL 5 FRONT 2 REAR 3

THE COMBINED WEIGHT OF OCCUPANTS AND CARGO SHOULD NEVER EXCEED XXX KG OR XXX LBS.

TIRE	FRONT	REAR	SPARE
ORIGINAL TIRE SIZE	P195/70R14	P195/70R14	T125/70D15
COLD TIRE INFLATION PRESSURE	200kPa, 29PSI	200kPa, 29PSI	420kPa, 60PSI

SEE OWNER'S MANUAL FOR ADDITIONAL INFORMATION 4N109268

Callouts: 1 points to Seating Capacity; 2 points to Weight Limit; 3 points to Original Tire Size; 4 points to Cold Tire Inflation Pressure.

811b5a9a

Tire and Loading Information Placard

This placard tells you important information about the:

- 1) number of people that can be carried in the vehicle
- 2) total weight your vehicle can carry
- 3) tire size designed for your vehicle
- 4) cold tire inflation pressures for the front, rear, and spare tires.

### Loading

The vehicle maximum load on the tire must not exceed the load carrying capacity of the tire on your vehicle. You will not exceed the tire's load carrying capacity if you adhere to the loading conditions, tire size, and cold tire inflation pressures specified on the Tire and Loading Information placard and in the "Vehicle Loading" section of this manual.

**NOTE:** Under a maximum loaded vehicle condition, gross axle weight ratings (GAWRs) for the front and rear axles must not be exceeded. For further information on GAWRs, vehicle loading, and trailer towing, refer to “Vehicle Loading” in this section.

To determine the maximum loading conditions of your vehicle, locate the statement “The combined weight of occupants and cargo should never exceed XXX lbs or XXX kg” on the Tire and Loading Information placard. The combined weight of occupants, cargo/luggage and trailer tongue weight (if applicable) should never exceed the weight referenced here.

### *Steps for Determining Correct Load Limit*

1. Locate the statement “The combined weight of occupants and cargo should never exceed XXX lbs or XXX kg” on your vehicle’s placard.
2. Determine the combined weight of the driver and passengers that will be riding in your vehicle.
3. Subtract the combined weight of the driver and passengers from XXX lbs or XXX kg.
4. The resulting figure equals the available amount of cargo and luggage load capacity. For example, if “XXX” amount equals 1,400 lbs (635 kg) and there will be five 150 lb (68 kg) passengers in your vehicle, the amount of available cargo and luggage load capacity is 650 lbs (295 kg) (since  $5 \times 150 = 750$ , and  $1400 - 750 = 650$  lbs [295 kg]).
5. Determine the combined weight of luggage and cargo being loaded on the vehicle. That weight may not safely exceed the available cargo and luggage load capacity calculated in step 4.



6. If your vehicle will be towing a trailer, load from your trailer will be transferred to your vehicle. Consult this manual to determine how this reduces the available cargo and luggage load capacity of your vehicle.

**NOTE:**

- The following table shows examples on how to calculate total load, cargo/luggage, and towing capacities of your vehicle with varying seating configurations

and number and size of occupants. This table is for illustration purposes only and may not be accurate for the seating and load carry capacity of your vehicle.

- For the following example, the combined weight of occupants and cargo should never exceed 865 lbs (392 kg).

Occupants			Combined weight of occupants and cargo from Tire Placard	MINUS	Combined Occupant's weight	=	AVAILABLE Cargo/Luggage and Trailer Tongue Weight
TOTAL	FRONT	REAR					
<b>EXAMPLE 1</b>			865 lbs	minus	670 lbs	=	195 lbs
5	2	3					
<b>EXAMPLE 2</b>			865 lbs	minus	540 lbs	=	325 lbs
3	2	1					
<b>EXAMPLE 3</b>			865 lbs	minus	400 lbs	=	465 lbs
2	2	0					

Occupant 1: 200 lbs  
 Occupant 2: 130 lbs  
 Occupant 3: 160 lbs  
 Occupant 4: 100 lbs  
 Occupant 5: 80 lbs  
 TOTAL WEIGHT: 670 lbs

Occupant 1: 210 lbs  
 Occupant 2: 180 lbs  
 Occupant 3: 150 lbs  
 TOTAL WEIGHT: 540 lbs

Occupant 1: 200 lbs  
 Occupant 2: 200 lbs  
 TOTAL WEIGHT: 400 lbs

**WARNING!**

Overloading of your tires is dangerous. Overloading can cause tire failure, affect vehicle handling, and increase your stopping distance. Use tires of the recommended load capacity for your vehicle. Never overload them.

**TIRES — GENERAL INFORMATION****Tire Pressure**

Proper tire inflation pressure is essential to the safe and satisfactory operation of your vehicle. Three primary areas are affected by improper tire pressure:

**Safety****WARNING!**

- Improperly inflated tires are dangerous and can cause accidents.
- Under inflation increases tire flexing and can result in tire failure.
- Over inflation reduces a tire's ability to cushion shock. Objects on the road and chuckholes can cause damage that result in tire failure.
- Unequal tire pressures can cause steering problems. You could lose control of your vehicle.
- Over inflated or under inflated tires can affect vehicle handling and can fail suddenly, resulting in loss of vehicle control.

*(Continued)*

**WARNING! (Continued)**

- Unequal tire pressures from one side of the vehicle to the other can cause the vehicle to drift to the right or left.
- Always drive with each tire inflated to the recommended cold tire inflation pressure.

**Economy**

Improper inflation pressures can cause uneven wear patterns to develop across the tire tread. These abnormal wear patterns will reduce tread life resulting in a need for earlier tire replacement. Under inflation, also increases tire rolling resistance and results in higher fuel consumption.

**Ride Comfort and Vehicle Stability**

Proper tire inflation contributes to a comfortable ride. Over inflation produces a jarring and uncomfortable ride.

**Tire Inflation Pressures**

The proper cold tire inflation pressure is listed on the driver's side "B" Pillar.

Some vehicles may have Supplemental Tire Pressure Information for vehicle loads that are less than the maximum loaded vehicle condition. These pressure conditions will be found in the "Supplemental Tire Pressure Information" section of this manual.

The pressure should be checked and adjusted as well as inspecting for signs of tire wear or visible damage at least once a month. Use a good quality pocket-type gauge to check tire pressure. Do not make a visual judgement when determining proper inflation. Radial tires may look properly inflated even when they are under inflated.

**CAUTION!**

**After inspecting or adjusting the tire pressure, always reinstall the valve stem cap (if equipped). This will prevent moisture and dirt from entering the valve stem, which could damage the valve stem.**

Inflation pressures specified on the placard are always “cold tire inflation pressure.” Cold tire inflation pressure is defined as the tire pressure after the vehicle has not been driven for at least 3 hours, or driven less than 1 mile (1 km) after a 3 hour period. The cold tire inflation pressure must not exceed the maximum inflation pressure molded into the tire sidewall.

Check tire pressures more often if subject to a wide range of outdoor temperatures, as tire pressures vary with temperature changes.

Tire pressures change by approximately 1 psi (7 kPa) per 12° F (7° C) of air temperature change. Keep this in mind when checking tire pressure inside a garage, especially in the winter.

Example: If garage temperature = 68° F (20° C) and the outside temperature = 32° F (0° C) then the cold tire inflation pressure should be increased by 3 psi (21 kPa), which equals 1 psi (7 kPa) for every 12° F (7° C) for this outside temperature condition.

Tire pressure may increase from 2 to 6 psi (13 to 40 kPa) during operation. DO NOT reduce this normal pressure build up or your tire pressure will be too low.

### Tire Pressures for High Speed Operation

The manufacturer advocates driving at safe speeds within posted speed limits. Where speed limits or conditions are such that the vehicle can be driven at high speeds, maintaining correct tire inflation pressure is very important. Increased tire pressure and reduced vehicle loading may be required for high-speed vehicle operation. Refer to original equipment or an authorized tire dealer for recommended safe operating speeds, loading and cold tire inflation pressures.

#### **WARNING!**

**High speed driving with your vehicle under maximum load is dangerous. The added strain on your tires could cause them to fail. You could have a serious accident. Don't drive a vehicle loaded to the maximum capacity at continuous speeds above 75 mph (120 km/h).**

### Radial-Ply Tires

#### **WARNING!**

**Combining radial ply tires with other types of tires on your vehicle will cause your vehicle to handle poorly. The instability could cause an accident. Always use radial ply tires in sets of four (or 6, in case of trucks with dual rear wheels). Never combine them with other types of tires.**

Cuts and punctures in radial tires are repairable only in the tread area because of sidewall flexing. Consult your authorized tire dealer for radial tire repairs.

### Compact Spare Tire — If Equipped

The compact spare is for temporary emergency use with radial tires. It is engineered to be used on your style vehicle only. Since this tire has limited tread life, the original tire should be repaired (or replaced) and reinstalled at the first opportunity.

#### WARNING!

**Temporary use spare tires are for emergency use only. With these tires, do not drive more than 50 mph (80 km/h). Temporary-use spare tires have limited tread life. When the tread is worn to the tread wear indicators, the temporary use spare tire needs to be replaced. Be sure to follow the warnings, which apply to your spare. Failure to do so could result in spare tire failure and loss of vehicle control.**

#### CAUTION!

**Prolonged use of limited use spare, or an incorrect tire size on either front wheel, may damage transaxle differential and result in loss of vehicle mobility.**

Do not install a wheel cover or attempt to mount a conventional tire on the compact spare wheel, since the wheel is designed specifically for the compact spare.

Do not install more than one compact spare tire/wheel on the vehicle at any given time.

#### CAUTION!

**Because of the reduced ground clearance, do not take your vehicle through an automatic car wash with the compact spare installed. Damage to the vehicle may result.**

### Limited Use Spare — If Equipped

The limited use spare tire is for temporary emergency use on your vehicle. This tire is identified by a limited use spare tire warning label located on the limited use spare tire and wheel assembly. This tire may look like the original equipped tire on the front or rear axle of your vehicle, but it is not. Installation of this limited use spare tire affects vehicle handling. Since it is not the same tire, replace (or repair) the original tire and reinstall on the vehicle at the first opportunity.

#### WARNING!

- The limited use spare tires are for emergency use only. Installation of this limited use spare tire affects vehicle handling. With this tire, do not drive more than 50 mph (80 km/h). Keep inflated to the cold tire inflation pressure listed on either your tire placard or limited use spare tire and wheel assembly. Replace (or repair) the original tire at the first opportunity and reinstall it on your vehicle. Failure to do so could result in loss of vehicle control.
- Prolonged use of limited use spare, or incorrect tire size of front wheel, may damage the transaxle differential and result in loss of vehicle mobility and could result in loss of vehicle control.



## Tire Spinning

When stuck in mud, sand, snow, or ice conditions, do not spin your vehicle's wheels faster than 30 mph (48 km/h) or for longer than 30 seconds continuously without stopping when you are stuck.

Refer to "Freeing A Stuck Vehicle" in Section 6 of this manual for additional information.

### WARNING!

Fast spinning tires can be dangerous. Forces generated by excessive wheel speeds may cause tire damage or failure. A tire could explode and injure someone. Do not spin your vehicle's wheels faster than 30 mph (48 km/h) or for more than 30 seconds continuously when you are stuck, and don't let anyone near a spinning wheel, no matter what the speed.

## Tread Wear Indicators

Tread wear indicators are in the original equipment tires to help you in determining when your tires should be replaced.

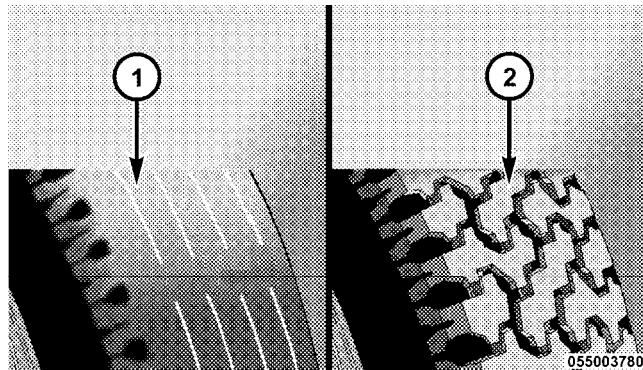

- 1 — Worn Tire
- 2 — New Tire

These indicators are molded into the bottom of the tread grooves. They will appear as bands when the tread depth becomes approximately 1/16 in (2 mm). When the tread is worn to the tread wear indicators, the tire should be replaced.

### Life of Tire

The service life of a tire is dependent upon varying factors including but not limited to:

- Driving style
- Tire pressure
- Distance driven

### WARNING!

**Tires and spare tire should be replaced after six years, regardless of the remaining tread. Failure to follow this warning can result in sudden tire failure. You could lose control and have an accident resulting in serious injury or death.**

Keep dismantled tires in a cool, dry place with as little exposure to light as possible. Protect tires from contact with oil, grease, and gasoline.

### Replacement Tires

The tires on your new vehicle provide a balance of many characteristics. They should be inspected regularly for wear and correct cold tire inflation pressure. The manufacturer strongly recommends that you use tires equivalent to the originals in size, quality and performance when replacement is needed (refer to the paragraph on "Tread Wear Indicators"). Refer to the "Tire and Loading

Information” placard for the size designation of your tire. The service description and load identification will be found on the original equipment tire. Failure to use equivalent replacement tires may adversely affect the safety, handling, and ride of your vehicle. We recommend that you contact your original equipment or an authorized tire dealer with any questions you may have on tire specifications or capability.

### **WARNING!**

- **Do not use a tire, wheel size or rating other than that specified for your vehicle. Some combinations of unapproved tires and wheels may change suspension dimensions and performance characteristics, resulting in changes to steering, handling, and braking of your vehicle. This can cause unpredictable handling and stress to steering and suspension components. You could lose control and have an accident resulting in serious injury or death. Use only the tire and wheel sizes with load ratings approved for your vehicle.**
- **Never use a tire with a smaller load index or capacity, other than what was originally equipped on your vehicle. Using a tire with a smaller load index could result in tire overloading and failure. You could lose control and have an accident.**

*(Continued)*

**WARNING! (Continued)**

- Failure to equip your vehicle with tires having adequate speed capability can result in sudden tire failure and loss of vehicle control.

**CAUTION!**

Replacing original tires with tires of a different size may result in false speedometer and odometer readings.

**TIRE CHAINS**

Due to limited clearance, tire chains are not recommended.

**CAUTION!**

Damage to the vehicle may result if tire chains are used.

**SNOW TIRES**

Snow tires should be of the same size and type construction as the front tires. Consult the manufacturer of the snow tire to determine any maximum vehicle speed requirement associated with the tire. These tires should always be operated at the vehicle maximum capacity inflation pressures under any load condition.

While studded tires improve performance on ice, skid and traction capability on wet or dry surfaces may be poorer than that of non-studded tires. Some states prohibit studded tires; therefore, local laws should be checked before using these tire types.

## TIRE ROTATION RECOMMENDATIONS

Tires on the front and rear axles of vehicles operate at different loads and perform different steering, driving, and braking functions. For these reasons, they wear at unequal rates and tend to develop irregular wear patterns. These effects can be reduced by timely rotation of tires. The benefits of rotation are especially worthwhile with aggressive tread designs such as those on all season type tires. Rotation will increase tread life, help to maintain mud, snow and wet traction levels, and contribute to a smooth, quiet ride.

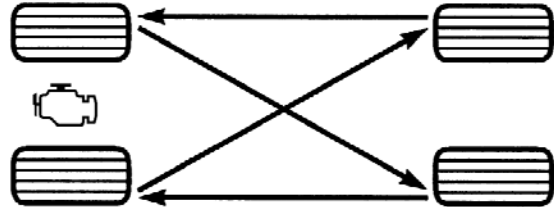

055703771

Follow the recommended tire rotation frequency for your type of driving found in the “Maintenance Schedules” section of this manual. More frequent rotation is permissible if desired. The reasons for any rapid or unusual wear should be corrected prior to rotation being performed.

## TIRE PRESSURE MONITOR SYSTEM (TPMS)

- The Tire Pressure Monitor System (TPMS) will warn the driver of a low tire pressure based on the vehicle recommended cold placard pressure.
- The tire pressure will vary with temperature by about 1 psi (7 kPa) for every 12 F (7 C). This means that when the outside temperature decreases, the tire pressure will decrease. Tire pressure should always be set based on cold inflation tire pressure. This is defined as the tire pressure after the vehicle has not been driven for at least three hours, or driven less than 1 mile (1 km) after a three hour period. The cold tire inflation pressure must not exceed the maximum inflation pressure molded into the tire sidewall. Refer to the “Tires – General Information” in this section for information on how to properly inflate the vehicle’s tires. The tire pressure will also increase as the vehicle is driven - this is normal and there should be no adjustment for this increased pressure.
- The TPM System will warn the driver of a low tire pressure if the tire pressure falls below the low-pressure warning limit for any reason, including low temperature effects and natural pressure loss through the tire.
- The TPM System will continue to warn the driver of low tire pressure as long as the condition exists, and will not turn off until the tire pressure is at or above the recommended cold placard pressure. Once the low tire pressure warning (Tire Pressure Monitoring Telltale Light) illuminates, you must increase the tire pressure to the recommended cold placard pressure in order for the Tire Pressure Monitoring Telltale Light to turn off. The system will automatically update and the Tire Pressure Monitoring Telltale Light will turn off

once the system receives the updated tire pressures. The vehicle may need to be driven for up to 20 minutes above 15 mph (25 km/h) in order for the TPMS to receive this information.

– For example, your vehicle may have a recommended cold (parked for more than three hours) placard pressure of 30 psi (207 kPa). If the ambient temperature is 68 F (20 C) and the measured tire pressure is 27 psi (186 kPa), a temperature drop to 20 F (-7 C) will decrease the tire pressure to approximately 23 psi (157 kPa). This tire pressure is sufficiently low enough to turn ON the Tire Pressure Monitoring Telltale Light. Driving the vehicle may cause the tire pressure to rise to approximately 27 psi (186 kPa), but the Tire Pressure Monitoring Telltale Light will still be ON. In this situation, the Tire Pressure Monitoring Telltale Light will turn OFF only after the tires are inflated to the vehicle's recommended cold placard pressure value.

### CAUTION!

- The TPMS has been optimized for the original equipment tires and wheels. TPMS pressures and warning have been established for the tire size equipped on your vehicle. Undesirable system operation or sensor damage may result when using replacement equipment that is not of the same size, type, and/or style. Aftermarket wheels can cause sensor damage. Do not use aftermarket tire sealants or balance beads if your vehicle is equipped with a TPMS, as damage to the sensors may result.
- After inspecting or adjusting the tire pressure, always reinstall the valve stem cap. This will prevent moisture and dirt from entering the valve stem, which could damage the Tire Pressure Monitoring Sensor.

**NOTE:**

- The TPMS is not intended to replace normal tire care and maintenance, or to provide warning of a tire failure or condition.
- The TPMS should not be used as a tire pressure gauge while adjusting your tire pressure.
- Driving on a significantly under-inflated tire causes the tire to overheat and can lead to tire failure. Under-inflation also reduces fuel efficiency and tire tread life, and may affect the vehicle's handling and stopping ability.
- The TPMS is not a substitute for proper tire maintenance, and it is the driver's responsibility to maintain correct tire pressure using an accurate tire pressure gauge, even if under-inflation has not reached the level to trigger illumination of the Tire Pressure Monitoring Telltale light.

- Seasonal temperature changes will affect tire pressure, and the TPMS will monitor the actual tire pressure in the tire.

**Base System**

The Tire Pressure Monitor System (TPMS) uses wireless technology with wheel rim mounted electronic sensors to monitor tire pressure levels. Sensors, mounted to each wheel as part of the valve stem, transmit tire pressure readings to the Receiver Module.

**NOTE:** It is particularly important for you to check the tire pressure in all of the tires on your vehicle monthly and to maintain the proper pressure.

The TPMS consists of the following components:

- Receiver Module
- Four Tire Pressure Monitoring Sensors
- Tire Pressure Monitoring Telltale Light



### Tire Pressure Monitoring Low Pressure Warnings



The Tire Pressure Monitoring Telltale Light will illuminate in the instrument cluster and a chime will sound when tire pressure is low in one or more of the four active road tires. Should this occur, you should stop as soon as possible, check the inflation pressure of each tire on your vehicle, and inflate each tire to the vehicle's recommended cold placard pressure value. Once the system receives the updated tire pressures, the system will automatically update and the Tire Pressure Monitoring Telltale Light will turn off. The vehicle may need to be driven for up to 20 minutes above 15 mph (25 km/h) in order for the TPMS to receive this information.

### Check TPMS Warning

The Tire Pressure Monitoring Telltale Light will flash on and off for 75 seconds and then remain on solid when a system fault is detected. The system fault will also sound a chime. If the ignition key is cycled, this sequence will

repeat, providing the system fault still exists. The Tire Pressure Monitoring Telltale Light will turn off when the fault condition no longer exists. A system fault can occur due to any of the following:

1. Jamming due to electronic devices or driving next to facilities emitting the same Radio Frequencies as the TPM sensors.
2. Installing some form of aftermarket window tinting that affects radio wave signals.
3. Lots of snow or ice around the wheels or wheel housings.
4. Using tire chains on the vehicle.
5. Using wheels/tires not equipped with TPM sensors.

**NOTE:**

1. The compact spare tire (if so equipped) does not have a tire pressure monitoring sensor. Therefore, the TPMS will not monitor the pressure in the compact spare tire.
2. If you install the compact spare tire in place of a road tire that has a pressure below the low-pressure warning limit, upon the next ignition key cycle, a chime will sound and the TPM Telltale Light will turn ON.
3. After driving the vehicle for up to 20 minutes above 15 mph (25 km/h), the TPM Telltale Light will flash on and off for 75 seconds and then remain on solid.
4. For each subsequent ignition key cycle, a chime will sound and the TPM Telltale Light will flash on and off for 75 seconds and then remain on solid.
5. Once you repair or replace the original road tire, and reinstall it on the vehicle in place of the compact spare, the TPMS will update automatically and the TPM Telltale

Light will turn OFF, as long no tire pressure is below the low-pressure warning limit in any of the four active road tires. The vehicle may need to be driven for up to 20 minutes above 15 mph (25 km/h) in order for the TPMS to receive this information.

**Premium System — If Equipped**

The Tire Pressure Monitor System (TPMS) uses wireless technology with wheel rim mounted electronic sensors to monitor tire pressure levels. Sensors, mounted to each wheel as part of the valve stem, transmit tire pressure readings to the Receiver Module.

**NOTE:** It is particularly important for you to check the tire pressure in all of the tires on your vehicle monthly and to maintain the proper pressure.

The TPMS consists of the following components:

- Receiver Module
- Four Tire Pressure Monitoring Sensors

- Three Trigger Modules (mounted in three of the four wheel-wells)
- Various Tire Pressure Monitoring System Messages, which display in the Electronic Vehicle Information Center (EVIC)
- Tire Pressure Monitoring Telltale Light

#### **Tire Pressure Monitoring Low Pressure Warnings**

 The Tire Pressure Monitoring Telltale Light will illuminate in the instrument cluster and a chime will sound when tire pressure is low in one or more of the four active road tires. In addition, the Electronic Vehicle Information Center (EVIC) will display a graphic showing the pressure values of each tire with the low tire pressure values flashing.

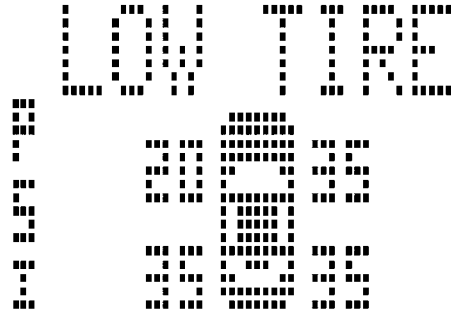

Should this occur, you should stop as soon as possible, and inflate all tires with low pressure (those flashing in the EVIC graphic) to the vehicle's recommended cold placard pressure value. Once the system receives the updated tire pressures, the system will automatically update, the graphic display in the EVIC will stop flashing, and the Tire Pressure Monitoring Telltale Light will turn off. The vehicle may need to be driven for up to 20 minutes above 15 mph (25 km/h) in order for the TPMS to receive this information.

### Check TPMS Warning

When a system fault is detected, a chime will sound and the Tire Pressure Monitoring Telltale Light will flash on and off for 75 seconds and then remain on solid. In addition, the EVIC will display a "CHECK TPM SYSTEM" message for three seconds and then display dashes

(- -) in place of the pressure value to indicate which sensor is not being received.

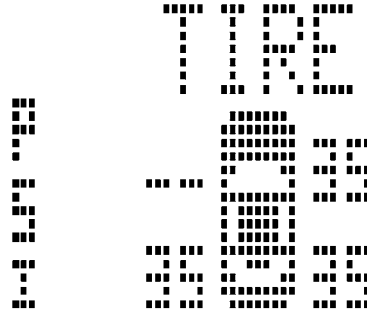

If the ignition key is cycled, this sequence will repeat, providing the system fault still exists. If the system fault no longer exists, the Tire Pressure Monitoring Telltale Light will no longer flash, and the "CHECK TPM SYSTEM" message will no longer display, and a pressure value will display in place of the dashes. A system fault can occur due to any of the following:

1. Jamming due to electronic devices or driving next to facilities emitting the same Radio Frequencies as the TPM sensors.
2. Installing some form of aftermarket window tinting that affects radio wave signals.
3. Lots of snow or ice around the wheels or wheel housings.
4. Using tire chains on the vehicle.
5. Using wheels/tires not equipped with TPM sensors.

**NOTE:**

1. The compact spare tire (if so equipped) does not have a tire pressure monitoring sensor. Therefore, the TPMS will not monitor the pressure in the compact spare tire.
2. If you install the compact spare tire in place of a road tire that has a pressure below the low-pressure warning limit, upon the next ignition key cycle, the TPM Telltale Light will remain ON, a chime will sound, and the EVIC will still display a flashing pressure value in the graphic display.
3. After driving the vehicle for up to 20 minutes above 15 mph (25 km/h), the TPM Telltale Light will flash on and off for 75 seconds and then remain on solid. In addition, the EVIC will display a "CHECK TPM SYSTEM" message for three seconds and then display dashes (- -) in place of the pressure value.

4. For each subsequent ignition key cycle, a chime will sound, the TPM Telltale Light will flash on and off for 75 seconds and then remain on solid, and the EVIC will display a "CHECK TPM SYSTEM" message for three seconds and then display dashes (- -) in place of the pressure value.

5. Once you repair or replace the original road tire, and reinstall it on the vehicle in place of the compact spare, the TPMS will update automatically. In addition, the TPM Telltale Light will turn OFF and the graphic in the EVIC will display a new pressure value instead of dashes (- -), as long no tire pressure is below the low-pressure warning limit in any of the four active road tires. The vehicle may need to be driven for up to 20 minutes above 15 mph (25 km/h) in order for the TPMS to receive this information.

### General Information

This device complies with part 15 of the FCC rules and RSS 210 of Industry Canada. Operation is subject to the following conditions:

- This device may not cause harmful interference.
- This device must accept any interference received, including interference that may cause undesired operation.

The tire pressure sensors are covered under one of the following licenses:

United States . . . . .	KR5S120123
Canada . . . . .	2671-S120123

## FUEL REQUIREMENTS

### 2.4L and 2.7L Engine



The 2.4L and 2.7L engines are designed to meet all emission regulations and provide excellent fuel economy and performance when using high quality unleaded “regular” gasolines having an octane rating of 87. The use of premium gasoline is not recommended. Under normal conditions, the use of premium gasoline will not provide a benefit over high quality unleaded “regular” gasolines, and in some circumstances may result in poorer performance.

### 3.5L Engine



The 3.5L engine is designed to meet all emissions regulations and provide satisfactory fuel economy and performance when

using high-quality unleaded gasoline having an octane range of 89. The manufacturer recommends the use of 89 octane for optimum performance. The use of premium gasoline is not recommended. Under normal conditions, the use of premium gasoline will not provide a benefit over high quality unleaded “regular” and “mid-grade” gasolines, and in some circumstances may result in poorer performance.

Light spark knock at low engine speeds is not harmful to your engine. However, continued heavy spark knock at high speeds can cause damage and immediate service is required.

Poor quality gasoline can cause problems such as hard starting, stalling, and hesitations. If you experience these symptoms, try another brand of gasoline (with the appropriate octane rating for your engine) before considering service for the vehicle.

Over 40 automobile manufacturers around the world have issued and endorsed consistent gasoline specifications (the World Wide Fuel Charter, WWFC) which define fuel properties necessary to deliver enhanced emissions, engine performance, and durability for your vehicle. The manufacturer recommends the use of gasolines that meet the WWFC specifications if they are available.

### Reformulated Gasoline

Many areas of the country require the use of cleaner burning gasoline referred to as "Reformulated Gasoline."

Reformulated gasolines contain oxygenates, and are specifically blended to reduce vehicle emissions and improve air quality.

The manufacturer supports the use of reformulated gasolines. Properly blended reformulated gasolines will provide excellent performance and durability of engine and fuel system components.

### Gasoline/Oxygenate Blends

Some fuel suppliers blend unleaded gasoline with oxygenates such as 10% ethanol, MTBE, and ETBE. Oxygenates are required in some areas of the country during the winter months to reduce carbon monoxide emissions. Fuels blended with these oxygenates may be used in your vehicle.

#### CAUTION!

**For vehicles equipped with a 2.4L or 3.5L engine, DO NOT use gasoline containing Methanol or E85 Ethanol. Use of these blends may result in starting and driveability problems and may damage critical fuel system components.**

**NOTE:** The 2.7L engine is now rated for E85 Ethanol use (EXCEPT CALIFORNIA EMISSION STATES). Only vehicles with the E-85 fuel filler door label can operate on E-85. For more information, see "Flexible Fuel" in this section.



Problems that result from using methanol/gasoline or E85 Ethanol blends are not the responsibility of the manufacturer. While MTBE is an oxygenate made from Methanol, it does not have the negative effects of Methanol.

### **E-85 Usage In Non-Flex Fuel Vehicles**

Non-FFV vehicles are compatible with gasoline containing 10% ethanol (E10). Gasoline with higher ethanol content may void the vehicle's warranty.

If a Non-FFV vehicle is inadvertently fueled with E-85 fuel, the engine will have some or all of these symptoms:

- operate in a lean mode
- OBD II "Malfunction Indicator Light" on
- poor engine performance
- poor cold start and cold drivability
- increased risk for fuel system component corrosion

To fix a Non-FFV vehicle inadvertently fueled once with E-85 perform the following:

- drain the fuel tank (see your authorized dealer)
- change the engine oil and oil filter
- disconnect and reconnect the battery to reset the engine controller memory

More extensive repairs will be required for prolonged exposure to E-85 fuel.

### **MMT in Gasoline**

MMT is a manganese containing metallic additive that is blended into some gasoline to increase octane. Gasoline blended with MMT provides no performance advantage beyond gasoline of the same octane number without MMT. Gasoline blended with MMT reduces spark plug life and reduces emission system performance in some vehicles. The manufacturer recommends that gasoline without MMT be used in your vehicle. The MMT content

of gasoline may not be indicated on the gasoline pump, therefore, you should ask your gasoline retailer whether or not his/her gasoline contains MMT.

It is even more important to look for gasolines without MMT in Canada, because MMT can be used at levels higher than those allowed in the United States.

MMT is prohibited in Federal and California reformulated gasolines.

### **Materials Added to Fuel**

All gasoline sold in the United States is required to contain effective detergent additives. Use of additional detergents or other additives is not needed under normal conditions and they would result in additional cost. Therefore, you should not have to add anything to the fuel.

### **Fuel System Cautions**

#### **CAUTION!**

**Follow these guidelines to maintain your vehicle's performance:**

- The use of leaded gas is prohibited by Federal law. Using leaded gasoline can impair engine performance and damage the emission control system.
- An out-of-tune engine, or certain fuel or ignition malfunctions, can cause the catalytic converter to overheat. If you notice a pungent burning odor or some light smoke, your engine may be out of tune or malfunctioning and may require immediate service. Contact your authorized dealer for service assistance.

- The use of fuel additives, which are now being sold as octane enhancers, is not recommended. Most of these products contain high concentrations of methanol. Fuel system damage or vehicle performance problems resulting from the use of such fuels or additives is not the responsibility of the manufacturer.

**NOTE:** Intentional tampering with emissions control systems can result in civil penalties being assessed against you.

### Carbon Monoxide Warnings

#### **WARNING!**

**Carbon monoxide (CO) in exhaust gases is deadly. Follow the precautions below to prevent carbon monoxide poisoning:**

- Do not inhale exhaust gases. They contain carbon monoxide, a colorless and odorless gas, which can kill. Never run the engine in a closed area, such as a garage, and never sit in a parked vehicle with the engine running for an extended period. If the vehicle is stopped in an open area with the engine running for more than a short period, adjust the ventilation system to force fresh, outside air into the vehicle.
- Guard against carbon monoxide with proper maintenance. Have the exhaust system inspected every time the vehicle is raised. Have any abnormal conditions repaired promptly. Until repaired, drive with all side windows fully open.
- Keep the trunk closed when driving your vehicle to prevent carbon monoxide and other poisonous exhaust gases from entering the vehicle.

## FLEXIBLE FUEL— 2.7L ONLY (EXCEPT CALIFORNIA EMISSION STATES)

### E-85 General Information

The information in this section is for Flexible Fuel vehicles only. This section only covers those subjects that are unique to these vehicles. Please refer to the other sections of this manual for information on features that are common between Flexible Fuel and gasoline only powered vehicles.

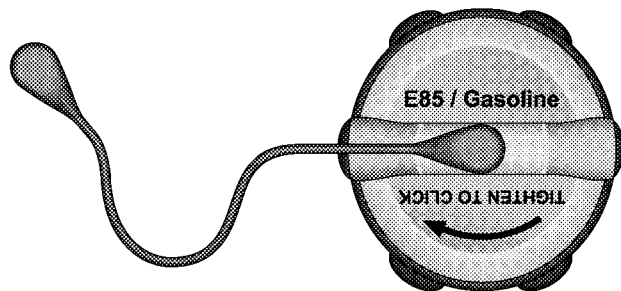

81ae46ab

E-85 Fuel Cap

**CAUTION!**

Only vehicles with the special E-85 fuel filler cap can operate on E-85.

Along with the special E-85 fuel filler cap, your vehicle may display a badge, which also indicates it can operate on E-85.



81ae46a9

E-85 Badge

### **ETHANOL FUEL (E-85)**

E-85 is a mixture of approximately 85% fuel ethanol and 15% unleaded gasoline.

### **WARNING!**

Ethanol vapors are extremely flammable and could cause serious personal injury. Never have any smoking materials lit in or near the vehicle when removing the fuel filler tube cap (gas cap) or filling the tank. Do not use E-85 as a cleaning agent and never use it near an open flame.

### **Fuel Requirements**

If your vehicle is E-85 compatible, it will operate on unleaded gasoline with an octane rating of 87, or E-85 fuel, or any mixture of these two fuels.

For best results, a refueling pattern that avoids alternating between E-85 and unleaded gasoline is recommended.

When you do switch fuel types it is recommended that:

- you do not add less than 5 gal (19 L) when refueling
- you drive the vehicle immediately after refueling for at least 5 miles (8 km)

Observing these precautions will avoid possible hard starting and/or significant deterioration in drivability during warm up.

**NOTE:** Use seasonally adjusted E-85 fuel (ASTM D5798). With non-seasonally adjusted E-85 fuel, you may experience hard starting and rough idle following start up even if the above recommendations are followed, especially when the ambient temperature is below 32°F (0°C).

### **Selection of Engine Oil For Flexible Fuel Vehicles (E-85) and Gasoline Vehicles**

FFV vehicles operated on E85 require specially formulated engine oils. These special requirements are included

in MOPAR® engine oils, and in equivalent oils meeting Chrysler Specification MS-6395. The manufacturer only recommends engine oils that are API Certified and meet the requirements of Material Standard MS-6395. MS-6395 contains additional requirements, developed during extensive fleet testing, to provide additional protection to the manufacturer's engines. Use MOPAR® or an equivalent oil meeting the specification MS-6395.

**NOTE:** Your engine oil filler cap also describes the correct engine oil to use.

### **Starting**

The characteristics of E-85 fuel make it unsuitable for use when ambient temperatures fall below 0°F (-18°C). In the range of 0°F (-18°C) to 32°F (0°C), you may experience an increase in the time it takes for your engine to start, and a deterioration in driveability (sags and/or hesitations) until the engine is fully warmed up.

## Cruising Range

Because E-85 fuel contains less energy per gallon than gasoline, you will experience an increase in fuel consumption. You can expect your fuel economy and driving range to decrease by about 30% compared to gasoline operation.

## Replacement Parts

All components in your Flexible Fuel Vehicle (FFV) are designed to be compatible with ethanol. Always be sure that your vehicle is serviced with correct ethanol compatible parts.

### CAUTION!

Replacing fuel system components with non-ethanol compatible components can damage your vehicle.

## Maintenance

### CAUTION!

Do not use ethanol mixture greater than 85% in your vehicle. It will cause difficulty in cold starting and may affect driveability.

## ADDING FUEL

### Fuel Filler Cap (Gas Cap)



As a reminder, a fuel icon with an arrow indicating which side of the vehicle the fuel filler door is located on, is located in the instrument cluster, just below the Fuel Gage.

The gas cap is behind the fuel filler door, on the left rear quarter panel of the vehicle. If the gas cap is lost or damaged, be sure the replacement cap is for use with this vehicle.

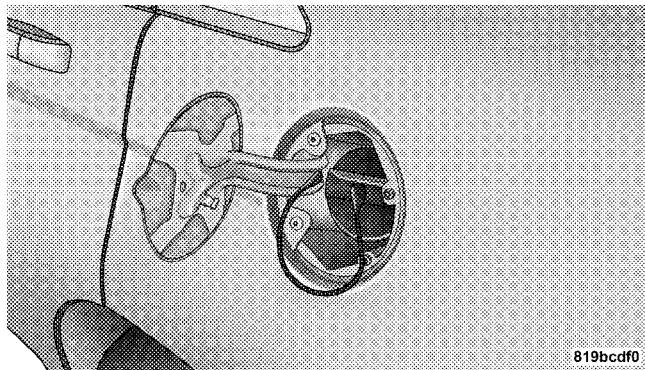

**Fuel Filler Door**

After removing the gas cap, place the gas cap tether cable over a hook on the inside of the fuel door. This keeps the gas cap suspended away from and protects the vehicle's surface.

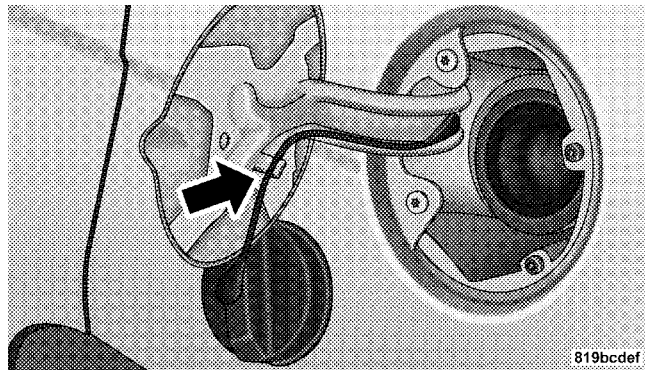

**Fuel Filler Door Features**

**NOTE:** If the gas cap is lost or damaged, be sure the replacement cap is for use with this vehicle.



**CAUTION!**

- Damage to the fuel system or emission control system could result from using an improper fuel tank filler tube cap (gas cap).
- A poorly fitting gas cap could let impurities into the fuel system and could cause the
- A poorly fitting gas cap may cause the Malfunction Indicator Light to turn on.
- To avoid fuel spillage and overfilling, do not “top off” the fuel tank after filling. When the fuel nozzle “clicks” or shuts off, the fuel tank is full.

**WARNING!**

- Never have any smoking materials lit in or near the vehicle when the gas cap is removed or the tank filled.
- Never add fuel when the engine is running. This is in violation of most state and federal fire regulations and doing so will cause the malfunction indicator light to turn on.
- A fire may result if gasoline is pumped into a portable container that is inside of a vehicle. You could be burned. Always place gas containers on the ground while filling.

**NOTE:**

- Tighten the gas cap until you hear a “clicking” sound. This is an indication that the gas cap is tightened properly. The Malfunction Indicator Light in the instrument cluster may turn on if the gas cap is not secured properly. Make sure that the gas cap is tightened each time the vehicle is refueled.
- When the fuel nozzle “clicks” or shuts off, the fuel tank is full.

**Loose Filler Cap Message**

If the vehicle's diagnostic system determines that the fuel filler cap is loose, improperly installed, or damaged, a “gASCAP” message will be displayed in the instrument cluster. Tighten the gas cap until a “clicking” sound is heard. This is an indication that the gas cap is properly tightened. Press the trip odometer reset button to turn off the message. If the problem persists, the message will appear the next time the vehicle is started. This might

indicate a damaged cap. If the problem is detected twice in a row, the system will turn on the Malfunction Indicator Light (MIL). Resolving the problem will turn the MIL light off.

**VEHICLE LOADING****Vehicle Certification Label**

Your vehicle has a certification label attached to the rear of the driver's door.

The label contains the following information:

- Name of manufacturer
- Month and year of manufacture
- Gross Vehicle Weight Rating (GVWR)
- Gross Axle Weight Rating (GAWR) front
- Gross Axle Weight Rating (GAWR) rear
- Vehicle Identification Number (VIN)

- Type of Vehicle
- Month Day and Hour of Manufacture (MDH)

The bar code allows a computer scanner to read the Vehicle Identification Number (VIN).

### **Gross Vehicle Weight Rating (GVWR)**

The GVWR is the total allowable weight of your vehicle. This includes driver, passengers, and cargo. The total load must be limited so that you do not exceed the GVWR.

### **Gross Axle Weight Rating (GAWR)**

The GAWR is the maximum capacity of the front and rear axles. Distribute the load over the front and rear axles evenly. Make sure that you do not exceed either front or rear GAWR.

## **WARNING!**

**Because the front wheels steer the vehicle, it is important that you do not exceed the maximum front or rear GAWR. A dangerous driving condition can result if either rating is exceeded. You could lose control of the vehicle and have an accident.**

### **Overloading**

The load carrying components (axle, springs, tires, wheels, etc.) of your vehicle will provide satisfactory service as long as you do not exceed the GVWR and front and rear GAWR.

The best way to figure out the total weight of your vehicle is to weigh it when it is fully loaded and ready for operation. Weigh it on a commercial scale to ensure that it is not over the GVWR.

Figure out the weight on the front and rear of the vehicle separately. It is important that you distribute the load evenly over the front and rear axles.

Overloading can cause potential safety hazards and shorten useful service life. Heavier axles or suspension components do not necessarily increase the vehicle's GVWR.

### **Loading**

To load your vehicle properly, first figure out its empty weight, axle by axle and side by side. Store heavier items down low and be sure you distribute their weight as evenly as possible. Stow all loose items securely before driving. If weighing the loaded vehicle shows that you have exceeded either GAWR, but the total load is within the specified GVWR, you must redistribute the weight. Improper weight distribution can have an adverse effect on the way your vehicle steers and handles and the way the brakes operate.

### **TRAILER TOWING**

In this section, you will find safety tips and information on limits to the type of towing you can reasonably do with your vehicle. Before towing a trailer, carefully review this information to tow your load as efficiently and safely as possible.

To maintain warranty coverage, follow the requirements and recommendations in this manual concerning vehicles used for trailer towing.

If you have any questions or concerns after reviewing this section, please consult your dealer to for full details on the towing capabilities of the vehicle.

### **Common Towing Definitions**

The following trailer towing related definitions will assist you in understanding the following information:

### **Gross Vehicle Weight Rating (GVWR)**

The GVWR is the total allowable weight of your vehicle. This includes driver, passengers, cargo, and tongue weight. The total load must be limited so that you do not exceed the GVWR.

### **Gross Trailer Weight (GTW)**

The GTW is the weight of the trailer plus the weight of all cargo, consumables and equipment (permanent or temporary) loaded in or on the trailer in its "loaded and ready for operation" condition. The recommended way to measure GTW is to put your fully loaded trailer on a vehicle scale. The entire weight of the trailer must be supported by the scale.

### **Gross Combination Weight Rating (GCWR)**

The GCWR is the total permissible weight of your vehicle and trailer when weighed in combination. (Note that GCWR ratings include a 150 lbs (68 kg) allowance for the presence of a driver).

### **Gross Axle Weight Rating (GAWR)**

The GAWR is the maximum capacity of the front and rear axles. Distribute the load over the front and rear axles evenly. Make sure that you do not exceed either front or rear GAWR.

#### **WARNING!**

**It is important that you do not exceed the maximum front or rear GAWR. A dangerous driving condition can result if either rating is exceeded. You could lose control of the vehicle and have an accident.**

### **Trailer Tongue Weight (TW)**

The tongue weight is the downward force exerted on the hitch ball by the trailer. In most cases it should not be less than or more than 10% of the trailer load. You must consider this as part of the load on your vehicle.

### Frontal Area

The frontal area is the maximum height and maximum width of the front of a trailer and its cargo.

### Weight-Carrying Hitch

A weight-carrying hitch supports the trailer tongue weight, just as if it were luggage located at a hitch ball or some other connecting point of the truck. These kinds of hitches are the most popular on the market today and they're commonly used to tow small- and medium-sized trailers.

### Trailer Hitch Classification

The following chart provides the industry standard for the maximum trailer weight a given trailer hitch class can tow and should be used to assist you in selecting the correct trailer hitch for your intended towing condition. Refer to the Trailer Towing Weights (Maximum Trailer Weight Ratings) chart for the Max. GTW towable for your given drivetrain.

Trailer Hitch Classification	
Class	Max. GTW (Gross Trailer Wt.)
Class I - Light Duty	2,000 lbs (907 kg)
Refer to the "Trailer Towing Weights (Maximum Trailer Weight Ratings)" chart for the Maximum Gross Trailer Weight (GTW) towable for your given drivetrain.	

All trailer hitches should be professionally installed on your vehicle.

## Trailer Towing Weights (Maximum Trailer Weight Ratings)

The following chart provides the maximum trailer weight ratings towable for your given drivetrain.

Maximum Trailer Weight Ratings			
Engine/Transaxle	Max. Frontal Area	Max. GTW (Gross Trailer Wt.)	Max. Trailer Tongue Wt. <sup>1</sup>
2.4L/Auto	See Note <sup>2</sup>	1,000 lbs (450 kg)	100 lbs (45 kg)
2.7L/Auto	See Note <sup>2</sup>	1,500 lbs (680 kg)	150 lbs (68 kg)
3.5L/Auto	22 sq.ft. (2.0 sq.m)	2,000 lbs (900 kg)	200 lbs (90 kg)
Refer to local laws for maximum trailer towing speeds.			

<sup>1</sup> The trailer tongue weight must be considered as part of the combined weight of occupants and cargo, and it should never exceed the weight referenced on the Tire and Loading Information placard. Refer to “Tire Safety Information” in Section 5 of this manual.

<sup>2</sup> Enclosed trailers or open utility trailers with front shields/guards are not recommended for use with all 4 cylinder and 2.7L engines with automatic transaxle. Please refer to the following website, <http://www-5.chrysler.com/searchapp/ui.jsp> or your authorized dealer for additional information.

**CAUTION!**

Towing a trailer with a larger than recommended frontal area could cause the engine to overheat or cause severe engine damage under extreme conditions.

**Trailer and Tongue Weight**

Always load a trailer with 60% to 65% of the weight in the front of the trailer. This places 10% of the Gross Trailer Weight (GTW) on the tow hitch of your vehicle. Loads balanced over the wheels or heavier in the rear can cause the trailer to sway **severely** side to side which will cause loss of control of vehicle and trailer. Failure to load trailers heavier in front is the cause of many trailer accidents.

Never exceed the maximum trailer tongue weight stamped on your bumper or trailer hitch.

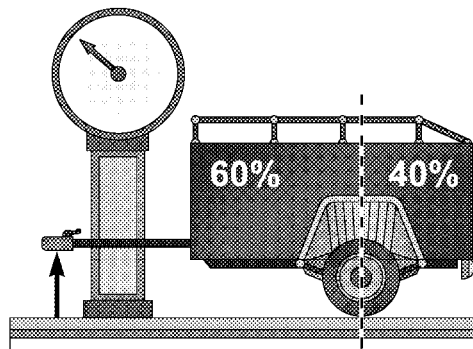

057003767

Consider the following items when computing the weight on the rear axle of the vehicle:

- The trailer tongue weight of the trailer.
- The weight of any other type of cargo or equipment put in or on your vehicle.
- The weight of the driver and all passengers.



**NOTE:** Remember that everything put into or on the trailer adds to the load on your vehicle. Also, additional factory-installed options, or authorized dealer-installed options, must be considered as part of the total load on your vehicle. Refer to the Tire and Loading Information placard in the Tire Safety Information section of this manual for the maximum combined weight of occupants and cargo for your vehicle.

**CAUTION!**

**Incorrect trailer tongue weight could result in increased yaw or vehicle instability. A negative trailer tongue weight could unload the rear suspension of the tow vehicle decreasing vehicle stability. Negative trailer tongue weight could cause the trailer to squat and potentially become disengaged from the tow vehicle resulting in a runaway trailer condition.**

### Towing Requirements

To promote proper break-in of your new vehicle drivetrain components the following guidelines are recommended:

**CAUTION!**

- **Avoid towing a trailer for the first 500 miles (805 km) of vehicle operation. Doing so may damage your vehicle.**
- **During the first 500 miles (805 km) of trailer towing, limit your speed to 50 mph (80 km/h).**

Perform the maintenance listed in Section 8 of this manual. When towing a trailer, never exceed the GAWR, or GCWR, ratings.

**WARNING!**

- **Improper towing can lead to an injury accident. Follow these guidelines to make your trailer towing as safe as possible:**
  - **Make certain that the load is secured in the trailer and that it will not shift during travel. When trailering cargo that is not fully secured, dynamic load shifts can occur that may be difficult for the driver to control. You could lose control of your vehicle and have an accident.**
- When hauling cargo, or towing a trailer, do not overload your vehicle or trailer. Overloading can cause a loss of control, poor performance, or damage to brakes, axle, engine, transaxle, steering, suspension, chassis structure, or tires.
- Safety chains must always be used between your vehicle and trailer. Always connect the chains to the frame or hook retainers of the vehicle hitch. Cross the chains under the trailer tongue and allow enough slack for turning corners.
- Vehicles with trailers should not be parked on a grade. When parking, apply the parking brake on the tow vehicle. Put the tow vehicle automatic transaxle in PARK. Always, block or "chock" the trailer wheels.
- GCWR must not be exceeded.
- **Total weight must be distributed between the tow vehicle and the trailer such that the following four ratings are not exceeded:**
  1. GVWR
  2. GTW
  3. GAWR

4. Trailer tongue weight rating for the trailer hitch utilized (This requirement may limit the ability to always achieve 10% of trailer tongue weight as a percentage of total trailer weight).

### Towing Requirements — Tires

- Do not attempt to tow a trailer while using a compact spare tire.
- Proper tire inflation pressures are essential to the safe and satisfactory operation of your vehicle. Refer to the “Tires — General Information” in this section for proper tire inflation procedures.
- Also, check the trailer tires for proper tire inflation pressures before trailer usage.
- Check for signs of tire wear or visible tire damage before towing a trailer. Refer to “Tires — General Information” in this section for information on tread wear indicators and for proper inspection procedure.

- When replacing tires, refer to “Tires — General Information” in this section for information on replacement tires and for proper tire replacement procedures. Replacing tires with a higher load carrying capacity will not increase the vehicle’s GVWR and GAWR limits.

### Towing Requirements — Trailer Brakes

- Do **not** interconnect the hydraulic brake system or vacuum system of your vehicle with that of the trailer. This could cause inadequate braking and possible personal injury.
- An electronically actuated trailer brake controller is required when towing a trailer with electronically actuated brakes. When towing a trailer equipped with a hydraulic surge actuated brake system, an electronic brake controller is not required.
- Trailer brakes are recommended for trailers over 1,000 lbs (450 kg) and required for trailers in excess of 2,000 lbs (907 kg).

**CAUTION!**

If the trailer weighs more than 1,000 lbs (450 kg) loaded, it should have its own brakes with adequate braking capacity. Failure to do this could lead to accelerated brake lining wear, higher brake pedal effort, and longer stopping distances.

**WARNING!**

- Do not connect trailer brakes to your vehicle's hydraulic brake lines. It can overload your brake system and cause it to fail. You might not have brakes when you need them and could have an accident.

*(Continued)*

**WARNING! (Continued)**

- Towing any trailer will increase your stopping distance. When towing, you should allow for additional space between your vehicle and the vehicle in front of you. Failure to do so could result in an accident.

**Towing Requirements — Trailer Lights and Wiring**

Whenever you pull a trailer, regardless of the trailer size, stop lights and turn signals on the trailer are required for motoring safety.

**Towing Tips**

Before setting out on a trip, practice turning, stopping, and backing the trailer in an area located away from heavy traffic.

Make sure all trailer and vehicle lights are working properly — including hazard flashers.

### Automatic Transaxle

The DRIVE range can be selected when towing. However, if frequent shifting occurs while in this range, third gear for a four-speed automatic and the fifth gear for a six-speed AutoStick® should be selected.

**NOTE:** Using third or fifth instead of DRIVE while operating the vehicle under heavy operating conditions, will improve performance and extend transaxle life by reducing excessive shifting and heat build-up. This action will also provide better engine braking.

If you **REGULARLY TOW** a trailer for more than 45 minutes of continuous operation, then change the automatic transaxle fluid and filter according to the interval specified for “police, taxi, fleet, or frequent trailer towing” in the “Maintenance Schedule” in this manual.

**NOTE:** Check the four-speed automatic transaxle fluid level before towing. AutoStick® six—speed transmission is sealed and the fluid level cannot be checked. See your authorized dealership service center for assistance.

### Electronic Speed Control — (If Equipped)

- Do not use in hilly terrain or with heavy loads.
- When using the speed control, if you experience speed drops greater than 10 mph (16 km/h), disengage until you can get back to cruising speed.
- Use speed control in flat terrain and with light loads to maximize fuel efficiency.

### Cooling System

To reduce potential for engine and transaxle overheating, take the following actions:

- *City Driving*

When stopped for short periods of time, put transaxle in neutral and increase engine idle speed.

- *Highway Driving*

Reduce speed.

- *Air Conditioning*

Turn off temporarily.

### RECREATIONAL TOWING (BEHIND MOTORHOME, ETC.)

#### Towing This Vehicle Behind Another Vehicle (Flat towing with all four wheels on the ground)

<b>CAUTION!</b>
<b>DO NOT flat tow this vehicle. Damage to the drivetrain will result.</b>

**NOTE:** If the vehicle requires towing make sure all four wheels are off the ground.

# WHAT TO DO IN EMERGENCIES

## CONTENTS

---

- Hazard Warning Flasher . . . . . 350
- If Your Engine Overheats . . . . . 350
  - Engine Oil Overheating (2.4L Engine Only)  
— If Equipped. . . . . 352
- Jacking And Tire Changing . . . . . 352
  - Jack Location . . . . . 353
  - Spare Tire Stowage . . . . . 353
  - Preparations For Jacking . . . . . 354
  - Jacking Instructions . . . . . 355
- Jump-Starting Procedure . . . . . 360
- Freeing A Stuck Vehicle . . . . . 363
- Towing A Disabled Vehicle . . . . . 364
  - Towing With The Ignition Key . . . . . 364
  - Towing Without The Ignition Key . . . . . 365
  - Towing This Vehicle Behind Another Vehicle . . . 365
  - Towing This Vehicle Behind Another Vehicle  
With A Tow Dolly . . . . . 365
  - Towing Without Power — Override  
Transaxle Interlock System . . . . . 365

## HAZARD WARNING FLASHER

The Hazard Warning flasher switch is located on the instrument panel, below the radio.



ⓈⓈⓈⓈⓈⓈⓈⓈ

Press the switch to turn on the Hazard Warning flashers. When the Hazard Warning flasher switch is activated, all directional turn signals will flash on and off to warn oncoming traffic of an emergency. Press the switch a second time to turn off flashers.

This is an emergency warning system and should not be used when the vehicle is in motion. Use it when your vehicle is disabled and is creating a safety hazard for other motorists.

If it is necessary to leave the vehicle to go for service, the Hazard Warning flasher will continue to operate with the ignition key removed and the vehicle locked.

**NOTE:** With extended use, the Hazard Warning flasher may wear down your battery.

## IF YOUR ENGINE OVERHEATS

In any of the following situations, you can reduce the potential for overheating by taking the appropriate action.

- On the highways — Slow down.
- In city traffic — While stopped, put transaxle in NEUTRAL, but do not increase engine idle speed.

If the pointer rises to the **H** (red) mark, the instrument cluster will sound a chime. Pull over and stop the vehicle with the engine at idle, when safe. Turn off the air conditioning and wait until the pointer drops back into the normal range. If the pointer remains on the H (red) mark for more than a minute, turn the engine off immediately and call for service.



**NOTE:** There are steps that you can take to slow down an impending overheat condition. If your air conditioner is on, turn it off. The air conditioning system adds heat to the engine cooling system and turning off the A/C removes this heat. You can also turn the temperature control to maximum heat, the mode control to floor, and the fan control to high. This allows the heater core to act as a supplement to the radiator and aids in removing heat from the engine cooling system.

### CAUTION!

**Driving with a hot cooling system could damage your vehicle. If temperature gauge reads "H", pull over and stop the vehicle with the engine at idle, when safe. Turn the air conditioner off and wait until the pointer drops back into the normal range. After appropriate action has been taken, if the pointer remains on the "H", turn the engine off immediately, and call for service.**

**WARNING!**

A hot engine cooling system is dangerous. You or others could be badly burned by steam or boiling coolant. You may want to call a service center if your vehicle overheats. If you decide to look under the hood yourself, refer to Section 7, Maintenance, of this manual. Follow the warnings under the Cooling System Pressure Cap paragraph.

**Engine Oil Overheating (2.4L Engine Only) — If Equipped**

During sustained high-speed driving or trailer tow up long grades on a hot day, the engine oil temperature may become too hot. If this happens, the “HOTOIL” message flashes in the odometer and the vehicle speed will be reduced to 53 mph (85 km/h) until the engine oil temperature is reduced.

**NOTE:** The vehicle speed is reduced to a maximum of 53 mph (85 km/h). You may of course, reduce your vehicle speed further if needed.

**JACKING AND TIRE CHANGING****WARNING!**

- Being under a jacked-up vehicle is dangerous. The vehicle could slip off the jack and fall on you. You could be crushed. Never put any part of your body under a vehicle that is on a jack. Never start or run the engine while the vehicle is on a jack. If you need to get under a raised vehicle, take it to a service center where it can be raised on a lift.

*(Continued)*

**WARNING! (Continued)**

- The jack is designed to use as a tool for changing tires only. The jack should not be used to lift the vehicle for service purposes. The vehicle should be jacked on a firm level surface only. Avoid ice or slippery areas.

**Jack Location**

The jack and jack-handle are stowed under the load floor in the trunk.

**Spare Tire Stowage**

The compact spare tire is stowed under the rear load floor in the trunk.

**Spare Tire Removal**

Lift up the load floor cover and remove the hold down.

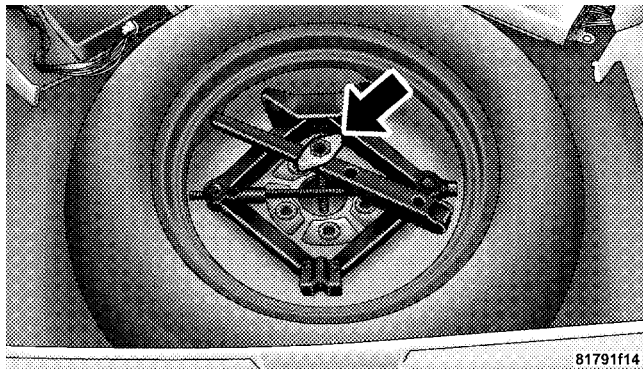

Spare Tire and Jack Stowage

## Preparations For Jacking

1. Park the vehicle on a firm level surface. Avoid ice or slippery areas.

### WARNING!

Do not attempt to change a tire on the side of the vehicle close to moving traffic. Pull far enough off the road to avoid the danger of being hit when operating the jack or changing the wheel.

2. Set the parking brake.

3. Place the shift lever into PARK (automatic transaxle) or REVERSE (manual transaxle).

4. Turn OFF the ignition.

5. Turn on the Hazard Warning Flasher.



6. Block both the front and rear of the wheel diagonally opposite the jacking position. For example, if changing the right front tire, block the left rear wheel.

**NOTE:** Passengers should not remain in the vehicle while the vehicle is being jacked.

## Jacking Instructions

### WARNING!

Carefully follow these tire changing warnings to help prevent personal injury or damage to your vehicle:

- Always park on a firm, level surface as far from the edge of the roadway as possible before raising the vehicle.
- Block the wheel diagonally opposite the wheel to be raised.
- Set the parking brake firmly and set an automatic transmission in PARK; a manual transmission in REVERSE.
- Never start or run the engine with the vehicle on a jack.
- Do not let anyone sit in the vehicle when it is on a jack.

*(Continued)*

### WARNING! (Continued)

- Do not get under the vehicle when it is on a jack.
- Only use the jack in the positions indicated and for lifting this vehicle during a tire change.
- If working on or near a roadway, be extremely careful of motor traffic.
- To assure that spare tires, flat or inflated are securely stowed, spares must be stowed with the valve stem facing the ground.
- Turn on the Hazard Warning Flasher.



Jack Warning Label

1. Remove the scissors jack and lug wrench from the spare wheel as an assembly. Turn the jack screw to the left to loosen the lug wrench, and remove the wrench from the jack assembly.

**NOTE:** The jack handle attaches to the side of the jack with two attachment points. When the jack is partially expanded, the tension between the two attachment points holds the jack handle in place.

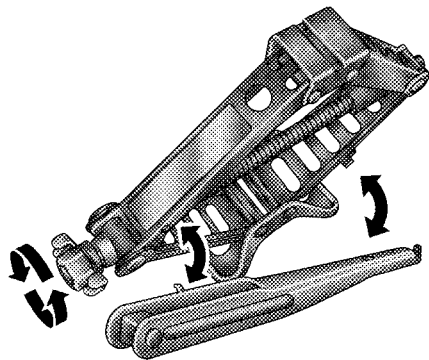

819b068d

#### Removing Jack Handle From Jack

2. Loosen, but do not remove, the wheel nuts by turning them to the left one turn while the wheel is still on the ground.

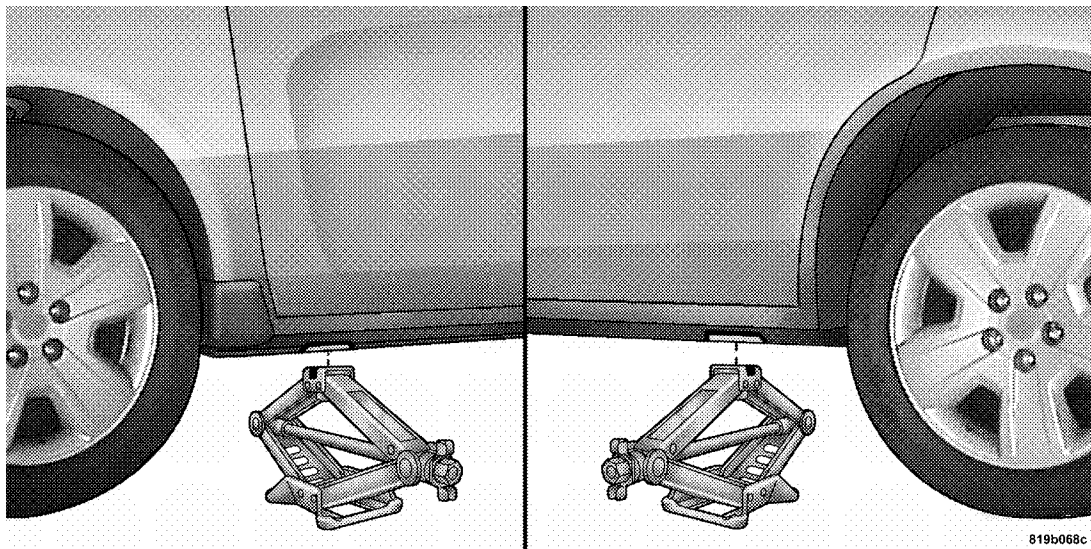

819b068c

Jacking Locations

**CAUTION!**

**Do not attempt to raise the vehicle by jacking on locations other than those indicated in step 3.**

3. There are two front jacking locations and two rear jacking locations on each side of the body (as pictured above).
4. Turn the jack screw to the left until the jack can be placed under the jacking location. Once the jack is positioned, turn the jack screw to the right until the jack head is properly engaged with the lift area closest to the wheel to be changed. Do not raise the vehicle until you are sure the jack is securely engaged.

**WARNING!**

**Raising the vehicle higher than necessary can make the vehicle less stable. It could slip off the jack and hurt someone near it. Raise the vehicle only enough to remove the tire.**

5. Raise the vehicle by turning the jack screw to the right, using the swivel wrench. Raise the vehicle only until the tire just clears the surface and enough clearance is obtained to install the spare tire. Minimum tire lift provides maximum stability.
6. Remove the wheel nuts, and pull the wheel and wheel covers (where applicable) off the hub. Install the spare wheel and wheel nuts with the cone shaped end of the nuts toward the wheel. Lightly tighten the nuts. To avoid the risk of forcing the vehicle off the jack, do not tighten the nuts fully until the vehicle has been lowered.



**WARNING!**

To avoid possible personal injury, handle the wheel covers with care to avoid contact with any sharp edges.

7. Lower the vehicle by turning the jack screw to the left.
8. Finish tightening the nuts. Push down on the wrench while tightening the wheel nuts. Alternate nuts, until each nut has been tightened twice. Correct wheel nut torque is 100 ft lbs (135 N·m). If you doubt that you have tightened the nuts correctly, have them checked with a torque wrench by your authorized dealer or at a service station.
9. Remove the wheel blocks and lower the jack until it is free. Reassemble the lug wrench to the jack assembly and stow it in the spare tire area. Secure the assembly using the means provided.

**WARNING!**

A loose tire or jack thrown forward in a collision or hard stop could endanger the occupants of the vehicle. Always stow the jack parts and the spare tire in the places provided.

10. Place the deflated (flat) tire in the cargo area and **have the tire repaired or replaced as soon as possible.**

**WARNING!**

A loose tire thrown forward in a collision or hard stop could injure the occupants in the vehicle. **Have the deflated (flat) tire repaired or replaced immediately.**

11. Check the tire pressure as soon as possible. Correct pressure as required.

## JUMP-STARTING PROCEDURE

The battery is stored between the left front headlight assembly and the left front wheel splash shield. Access is through the splash shield.

Jump-starting remote battery terminals are located under the hood.

### WARNING!

- Take care to avoid the radiator cooling fan whenever the hood is raised. It can start anytime the ignition switch is on. You can be hurt by the fan.

*(Continued)*

### WARNING! (Continued)

- Do not attempt to push or tow your vehicle to get it started. Vehicles equipped with an automatic transaxle cannot be started this way. Unburned fuel could enter the catalytic converter and once the engine has started, ignite and damage the converter and vehicle. If the vehicle has a discharged battery, booster cables may be used to obtain a start from another vehicle. This type of start can be dangerous if done improperly, so follow this procedure carefully.
- Do not use a booster battery or any other booster source with an output that exceeds 12-Volts.

1. Wear eye protection and remove any metal jewelry such as watchbands or bracelets that might make an inadvertent electrical contact.

2. When boosting from a battery in another vehicle, park that vehicle within booster cable reach, but without allowing the vehicles to touch. Set the parking brake, place the automatic transaxle in PARK and turn ignition to LOCK for both vehicles.

### WARNING!

Do not permit vehicles to touch each other as this could establish a ground connection and personal injury could result.

3. Turn off the heater, radio, and all unnecessary electrical loads.

4. Remove the protective cover over the remote jump-start positive battery post (+) in the engine compartment. Connect one end of the jumper cable to the positive battery post. Connect the other end of the same cable to the positive terminal of the booster battery. Refer to the following illustration for jump-starting connections.

5. Connect the other cable, first to the negative terminal of the booster battery and **then to the engine ground (-) of the vehicle with the discharged battery.** Make sure you have a good contact on the engine ground. Refer to the following illustration for jump-starting connections.

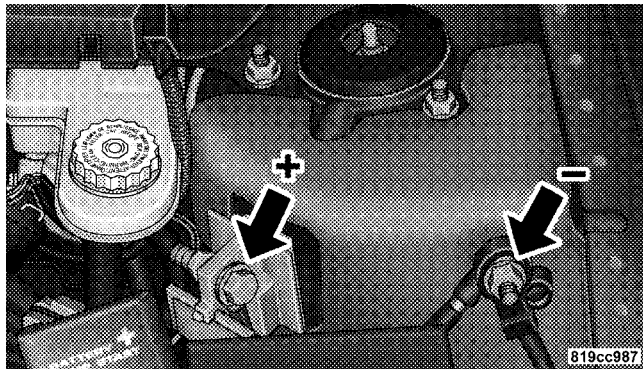

Jump-Starting Location

6. If the vehicle is equipped with Sentry Key® Immobilizer, turn the ignition switch to the ON position for three seconds before moving the ignition switch to the START position.
7. Start the engine in the vehicle that has the booster battery, let the engine idle a few minutes, and then start the engine in the vehicle with the discharged battery.
8. When removing the jumper cables, reverse the sequence exactly. Be careful of the moving belts and fan.
9. Reinstall the protective cover over the remote jump-start positive battery post.

**WARNING!**

**During cold weather when temperatures are below freezing point, electrolyte in a discharged battery may freeze. Do not attempt jump-starting because the battery could rupture or explode. The battery temperature must be brought up above the freezing point before attempting a jump-start.**

**NOTE:** Refer to “Maintenance Procedures” in Section 7 of this manual for information on accessing the battery for service or replacement.

**WARNING!**

Any procedure other than above could result in:

- Personal injury caused by electrolyte squirting out the battery vent;
- Personal injury or property damage due to battery explosion;
- Damage to charging system of booster vehicle or of immobilized vehicle.

**FREEING A STUCK VEHICLE**

If your vehicle becomes stuck in mud, sand, or snow, it can often be moved by a rocking motion. Turn your steering wheel right and left to clear the area around the front wheels. Then shift back and forth between REVERSE and FIRST gear. Usually the least accelerator pedal pressure to maintain the rocking motion without spinning the wheels is most effective.

**NOTE:**

If your vehicle is equipped with Traction Control, turn the system to Partial OFF before attempting to “rock” the vehicle. Refer to “Partial Off Mode” under “Electronic Stability Program (ESP)” in Section 5 of this manual.

**WARNING!**

Fast spinning tires can be dangerous. Forces generated by excessive wheel speeds may cause axle and tire damage or failure. A tire could explode and injure someone. Do not spin your vehicle’s wheels faster than 30 mph (48 km/h) or for longer than 30 seconds continuously without stopping when you are stuck, and don’t let anyone near a spinning wheel, no matter what the speed.

**CAUTION!**

Racing the engine or spinning the wheels too fast may lead to transaxle overheating and failure. It can also damage the tires. Do not spin the wheels above 30 mph (48 km/h). Do not spin the wheels continuously for more than 30 seconds.

**TOWING A DISABLED VEHICLE****Towing With The Ignition Key****Front Wheel Drive**

Your vehicle may be towed (with all four wheels flat on the ground), under the following conditions: The shift lever must be in NEUTRAL, the distance to be traveled must not exceed 15 miles (25 km), and the towing speed must not exceed 25 mph (40 km/h). Exceeding these towing limits may cause a transaxle failure. If the transaxle is not operative, or if the vehicle is to be towed more

than 15 miles (25 km), the vehicle must be transported either with a flat bed truck or with the front wheels off the ground.

**CAUTION!**

- If the vehicle being towed requires steering, the ignition switch must be in the ON position, not in the LOCK or ACC position.
- Do not attempt to tow this vehicle from the front with sling type towing equipment. Damage to the front fascia will result.
- Do not push or tow this vehicle with another vehicle as damage to the bumper fascia and transaxle may result.

If you must use the accessories (wipers, defrosters, etc.) while being towed, the key must be in the ON position, not the ACC position. Make certain the transaxle remains in NEUTRAL.

### **Towing Without The Ignition Key**

Special care must be taken when the vehicle is towed with the ignition in the LOCK position. Flatbed towing is the preferred towing method. However, if a flatbed towing vehicle is not available, a wheel lift towing vehicle may be used. Rear towing is not recommended with the front wheels on the ground, as transaxle damage can result. If rear towing is the only alternative, a front end dolly must be used. Proper towing equipment is necessary to prevent damage to the vehicle.

### **Towing This Vehicle Behind Another Vehicle**

Flat towing with all four wheels on the ground of vehicles equipped with an automatic transmission, is only permitted within the limitations described in this section.

### **Towing This Vehicle Behind Another Vehicle With A Tow Dolly**

Rear towing is not recommended with the front wheels on the ground, as transaxle damage can result. If rear towing is the only alternative, a front end dolly must be used. Proper towing equipment is necessary to prevent damage to the vehicle.

### **Towing Without Power — Override Transaxle Interlock System**

Special care must be taken when the vehicle is towed with the ignition in the LOCK position. A dolly should be used under the front wheels if the rear wheels are raised. Proper towing equipment is necessary to prevent damage to the vehicle.

Battery power is required to release the brake/transaxle interlock system. There is an override system that allows you to shift out of PARK in case of loss of power. To activate the override system:

- Firmly apply the parking brake.
- Insert the ignition key and rotate it to the ON position.
- Remove the cupholder liner.
- Insert a key, screwdriver, or similar object into the front hole then push and hold the manual override release lever forward.
- While holding the release lever forward, move the shift lever from PARK to NEUTRAL.
- Release the override.



# MAINTAINING YOUR VEHICLE

## CONTENTS

---

■ Engine Compartment — 2.4L . . . . .	369	■ Maintenance Procedures . . . . .	375
■ Engine Compartment — 2.7L . . . . .	370	□ Engine Oil . . . . .	375
■ Engine Compartment — 3.5L . . . . .	371	□ Engine Oil Filter . . . . .	379
■ Onboard Diagnostic System — OBD II . . . . .	372	□ Engine Air Cleaner Filter . . . . .	379
□ Loose Fuel Filler Cap Message . . . . .	372	□ Maintenance-Free Battery . . . . .	380
■ Emissions Inspection And Maintenance Programs . . . . .	373	□ Air Conditioner Maintenance . . . . .	381
■ Replacement Parts . . . . .	374	□ A/C Air Filter — If Equipped . . . . .	382
■ Dealer Service . . . . .	375	□ Body Lubrication . . . . .	384
		□ Windshield Wiper Blades . . . . .	384

- Adding Washer Fluid . . . . . 385
- Exhaust System . . . . . 385
- Cooling System . . . . . 388
- Brake System . . . . . 394
- Automatic Transaxle . . . . . 395
- Appearance Care And Protection From Corrosion . . . . . 398
- Cleaning Center Console Cupholders . . . . . 403
- Fuses . . . . . 404
  - Totally Integrated Power Module (TIPM) . . . . . 404
- Vehicle Storage . . . . . 410
- Replacement Bulbs . . . . . 410
  - Bulb Replacement . . . . . 411
    - Headlight . . . . . 411
    - Front Turn Signal/Parking Light . . . . . 413
    - Front Fog Light . . . . . 413
    - Tail/Stop, Rear Turn Signal And Backup Lights . . . . . 415
    - License Plate Light . . . . . 418
    - Center High-Mounted Stop Light (CHMSL) . . . . . 418
- Fluids And Capacities . . . . . 419
- Fluids, Lubricants, And Genuine Parts . . . . . 420
  - Engine . . . . . 420

## ENGINE COMPARTMENT — 2.4L

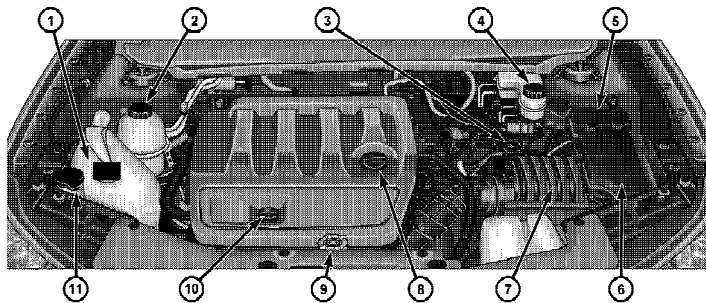

070305924

- 1 — Engine Coolant Reservoir
- 2 — Power Steering Fluid Reservoir
- 3 — Automatic Transaxle Dipstick
- 4 — Brake Fluid Reservoir
- 5 — Integrated Power Module
- 6 — Power Distribution Center

- 7 — Air Cleaner Filter
- 8 — Engine Oil Fill
- 9 — Coolant Pressure Cap
- 10 — Engine Oil Dipstick
- 11 — Washer Fluid Reservoir

## ENGINE COMPARTMENT — 2.7L

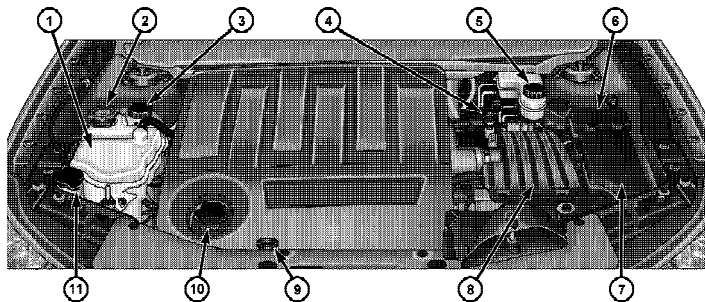

070605526

- 1 — Engine Coolant Reservoir
- 2 — Coolant Pressure Cap
- 3 — Power Steering Fluid Reservoir
- 4 — Automatic Transaxle Dipstick
- 5 — Brake Fluid Reservoir
- 6 — Integrated Power Module

- 7 — Power Distribution Center
- 8 — Air Cleaner Filter
- 9 — Engine Oil Dipstick
- 10 — Engine Oil Fill
- 11 — Washer Fluid Reservoir

## ENGINE COMPARTMENT — 3.5L

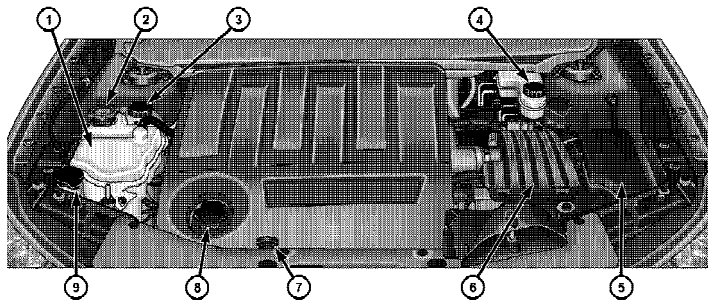

070905926

- 1 — Engine Coolant Reservoir
- 2 — Coolant Pressure Cap
- 3 — Power Steering Fluid Reservoir
- 4 — Brake Fluid Reservoir
- 5 — Power Distribution Center

- 6 — Air Cleaner Filter
- 7 — Engine Oil Dipstick
- 8 — Engine Oil Fill
- 9 — Washer Fluid Reservoir

## ONBOARD DIAGNOSTIC SYSTEM — OBD II

Your vehicle is equipped with a sophisticated Onboard Diagnostic system called OBD II. This system monitors the performance of the emissions, engine, and automatic transaxle control systems. When these systems are operating properly, your vehicle will provide excellent performance and fuel economy, as well as maintaining engine emissions well within current government regulations.

If any of these systems require service, the OBD II system will turn on the Malfunction Indicator Light (MIL). It will also store diagnostic codes and other information to assist an authorized service technician in making repairs. Although your vehicle will usually be drivable and not need towing, see your authorized dealer for service as soon as possible.

### CAUTION!

- **Prolonged driving with the “Malfunction Indicator Light” on could cause further damage to the emission control system. It could also affect fuel economy and driveability. The vehicle must be serviced before any emissions tests can be performed.**
- **If the “Malfunction Indicator Light” is flashing while the engine is running, severe catalytic converter damage and power loss will soon occur. Immediate service is required.**

### Loose Fuel Filler Cap Message

After fuel is added, the vehicle diagnostic system can determine if the fuel filler cap is possibly loose or improperly installed. A “GASCAP” message will be displayed in the instrument cluster. Tighten the gas cap until a “clicking” sound is heard. This is an indication that

the gas cap is properly tightened. Press the trip odometer “Reset” button to turn off the message. If the problem persists, the message will appear the next time the vehicle is started. This might indicate a damaged cap. If the problem is detected twice in a row, the system will turn on the “Malfunction Indicator Light (MIL).” Resolving the problem will turn the MIL light off.

## EMISSIONS INSPECTION AND MAINTENANCE PROGRAMS

In some localities, it may be a legal requirement to pass an inspection of your vehicle’s emissions control system. Failure to pass could prevent vehicle registration.



For states that require an Inspection and Maintenance (I/M), this check verifies the Malfunction Indicator Light (MIL) is functioning and is not on when the engine is running, and that the OBD II system is ready for testing.

Normally, the OBD II system will be ready. The OBD II system may **not** be ready if your vehicle was recently serviced, recently had a dead battery or a battery replacement. If the OBD II system should be determined not ready for the I/M test, your vehicle may fail the test.

Your vehicle has a simple ignition key-actuated test, which you can use prior to going to the test station. To check if your vehicle’s OBD II system is ready, you must do the following:

1. Insert your ignition key into the ignition switch.
2. Turn the ignition to the ON position, but do not crank or start the engine.
3. If you crank or start the engine, you will have to start this test over.
4. As soon as you turn your key to the ON position, you will see the MIL symbol come on as part of a normal bulb check.

5. Approximately 15 seconds later, one of two things will happen:

- a. The MIL will flash for about 10 seconds and then return to being fully illuminated until you turn OFF the ignition or start the engine. This means that your vehicle's OBD II system is **not ready** and you should **not** proceed to the I/M station.
- b. The MIL will not flash at all and will remain fully illuminated until you turn OFF the ignition or start the engine. This means that your vehicle's OBD II system is **ready** and you can proceed to the I/M station.

If your OBD II system is **not ready**, you should see your authorized dealer or repair facility. If your vehicle was recently serviced or had a battery failure or replacement, you may need to do nothing more than drive your vehicle as you normally would in order for your OBD II system to update. A recheck with the above test routine may then indicate that the system is now ready.

Regardless of whether your vehicle's OBD II system is ready or not, if the MIL is illuminated during normal vehicle operation you should have your vehicle serviced before going to the I/M station. The I/M station can fail your vehicle because the MIL is on with the engine running.

### REPLACEMENT PARTS

Use of genuine MOPAR® parts for normal/scheduled maintenance and repairs is highly recommended to ensure the designed performance. Damage or failures caused by the use of non-MOPAR® parts for maintenance and repairs will not be covered by the manufacturer's warranty.



## DEALER SERVICE

Your authorized dealer has the qualified service personnel, special tools, and equipment to perform all service operations in an expert manner. Service Manuals are available which include detailed service information for your vehicle. Refer to these manuals before attempting any procedure yourself.

**NOTE:** Intentional tampering with emissions control systems can result in civil penalties being assessed against you.

### WARNING!

You can be badly injured working on or around a motor vehicle. Only do service work for which you have the knowledge and the proper equipment. If you have any doubt about your ability to perform a service job, take your vehicle to a competent mechanic.

## MAINTENANCE PROCEDURES

The pages that follow contain the **required** maintenance services determined by the engineers who designed your vehicle.

Besides the maintenance items for which there are fixed maintenance intervals, there are other items that should operate satisfactorily without periodic maintenance. However, if a malfunction of these items does occur, it could adversely affect the engine or vehicle performance. These items should be inspected if a malfunction is observed or suspected.

### Engine Oil

#### Checking Oil Level

To assure proper engine lubrication, the engine oil must be maintained at the correct level. Check the oil level at regular intervals, such as every fuel stop.

The best time to check the engine oil level is about 5 minutes after a fully warmed engine is shut off. Do not check oil level before starting the engine after it has sat overnight. Checking engine oil level when the engine is cold will give you an incorrect reading.

Checking the oil while the vehicle is on level ground and only when the engine is hot, will improve the accuracy of the oil level readings. Maintain the oil level between the range markings on the dipstick. Either the range markings consist of a crosshatch zone marked SAFE or a crosshatch zone marked with MIN at the low end of the range and MAX at the high end of the range. Adding one quart of oil when the reading is at the low end of the range marking will raise the oil level to the high end of the range marking.

### CAUTION!

**Do not overfill the engine. Overfilling the engine will cause oil aeration, which can lead to loss of oil pressure and an increase in oil temperature. This could damage your engine.**

### Change Engine Oil

The oil change indicator system will remind you that it is time to take your vehicle in for scheduled maintenance. Refer to “Maintenance Schedule” in Section 8 of this manual for information on this system.

**NOTE: Under no circumstances should oil change intervals exceed 6,000 miles (10 000 km) or 6 months, whichever occurs first.**

## Engine Oil Selection

For best performance and maximum protection under all types of operating conditions, the manufacturer recommends engine oils that are API Certified and meet the requirements of Chrysler Material Standard MS-6395.

### American Petroleum Institute (API) Engine Oil Identification Symbol



This symbol means that the oil has been certified by the American Petroleum Institute (API). The manufacturer only recommends API Certified engine oils.

## Engine Oil Viscosity (SAE Grade) — 2.4L and 2.7L Engines

SAE 5W-20 engine oil is recommended for all operating temperatures. This engine oil improves low temperature starting and vehicle fuel economy. Your engine oil filler cap also shows the recommended engine oil viscosity for your vehicle.

The engine oil filler cap also shows the recommended engine oil viscosity for your engine. For information on engine oil filler cap location, refer to “Engine Compartment” in this section.

Lubricants which do not have both the engine oil certification mark and the correct SAE viscosity grade number should not be used.

**Engine Oil Viscosity (SAE Grade) — 3.5L Engine**

SAE 10W-30 engine oil is preferred for all operating temperatures. The engine oil filler cap also shows the recommended engine oil viscosity for your vehicle.

Lubricants which do not have both, the engine oil certification mark and the correct SAE viscosity grade number should not be used.

The engine oil filler cap also shows the recommended engine oil viscosity for your engine. For information on engine oil filler cap location, refer to “Engine Compartment” in this section.

Lubricants which do not have both, the engine oil certification mark and the correct SAE viscosity grade number should not be used.

**Synthetic Engine Oils**

You may use synthetic engine oils provided the recommended oil quality requirements are met, and the recommended maintenance intervals for oil and filter changes are followed.

**Materials Added to Engine Oils**

The manufacturer strongly recommends against the addition of any additives (other than leak detection dyes) to the engine oil. Engine oil is an engineered product and its performance may be impaired by supplemental additives.

**Disposing of Used Engine Oil and Oil Filters**

Care should be taken in disposing of used engine oil and oil filters from your vehicle. Used oil and oil filters, indiscriminately discarded, can present a problem to the environment. Contact your authorized dealer, service

station, or governmental agency for advice on how and where used oil and oil filters can be safely discarded in your area.

### **Engine Oil Filter**

The engine oil filter should be replaced at every engine oil change.

### **Engine Oil Filter Selection**

All of this manufacturer's engines have a full-flow type disposable oil filter. Use a filter of this type for replacement. The quality of replacement filters varies considerably. Only high quality filters should be used to assure most efficient service. MOPAR® engine oil filters are high quality oil filters and are recommended.

### **Engine Air Cleaner Filter**

#### **WARNING!**

The air induction system (air cleaner, hoses, etc.) can provide a measure of protection in the case of engine backfire. Do not remove the air induction system (air cleaner, hoses, etc.) unless such removal is necessary for repair or maintenance. Make sure that no one is near the engine compartment before starting the vehicle with the air induction system (air cleaner, hoses, etc.) removed. Failure to do so can result in serious personal injury.

Refer to the "Maintenance Schedule" in Section 8 of this manual for the proper maintenance intervals.

### Engine Air Cleaner Filter Selection

The quality of replacement engine air cleaner filters varies considerably. Only high quality filters should be used to assure most efficient service. MOPAR® engine air cleaner filters are high quality and are recommended.

### Maintenance-Free Battery

You will never have to add water, nor is periodic maintenance required.

**NOTE:** The battery is stored in a compartment behind the left front fender and is accessible without removing the tire and wheel. Remote battery terminals are located in the engine compartment for jump-starting.

To access the battery, turn the steering wheel fully to the right and remove the inner fender shield.

### WARNING!

- **Battery fluid is a corrosive acid solution and can burn or even blind you. Do not allow battery fluid to contact your eyes, skin, or clothing. Do not lean over a battery when attaching clamps. If acid splashes in eyes or on skin, flush the area immediately with large amounts of water.**
- **Battery gas is flammable and explosive. Keep flame or sparks away from the battery. Do not use a booster battery or any other booster source with an output greater than 12 volts. Do not allow cable clamps to touch each other.**
- **Battery posts, terminals, and related accessories contain lead and lead compounds. Wash hands after handling.**

**CAUTION!**

- It is essential when replacing the cables on the battery that the positive cable is attached to the positive post and the negative cable is attached to the negative post. Battery posts are marked positive (+) and negative (-) and identified on the battery case. Cable clamps should be tight on the terminal posts and free of corrosion. Apply grease to posts and clamps after tightening.
- If a “fast charger” is used while the battery is in the vehicle, disconnect both vehicle battery cables before connecting the charger to battery. Do not use a “fast charger” to provide starting voltage as battery damage can result.

**Air Conditioner Maintenance**

For best possible performance, your air conditioner should be checked and serviced by an authorized dealer

at the start of each warm season. This service should include cleaning of the condenser fins and a performance test.

**WARNING!**

- Use only refrigerants and compressor lubricants approved by the manufacturer for your air conditioning system. Some unapproved refrigerants are flammable and can explode, injuring you. Other unapproved refrigerants or lubricants can cause the system to fail, requiring costly repairs. Refer to Section 3 of the Warranty Information book for further warranty information.
- The air conditioning system contains refrigerant under high pressure. To avoid risk of personal injury or damage to the system, adding refrigerant or any repair requiring lines to be disconnected should be done by an experienced technician.

### Refrigerant Recovery and Recycling

R-134a air conditioning refrigerant is a hydrofluorocarbon (HFC) that is endorsed by the Environmental Protection Agency and is an ozone-saving product. However, the manufacturer recommends that air conditioning service be performed by authorized dealers or other service facilities using recovery and recycling equipment.

**NOTE:** Use only manufacturer approved A/C System Sealers, Stop Leak Products, Seal Conditioners, Compressor Oil, and Refrigerants.

### A/C Air Filter — If Equipped

Refer to the “Maintenance Schedule” in Section 8 of this manual for the proper maintenance intervals.

#### **WARNING!**

**Do not remove the A/C Air Filter while the blower is operating or personal injury may result.**

The A/C Air Filter is located in the fresh air inlet behind the glove box. Perform the following procedure to replace the filter:

1. Open the glove box and remove all contents.
2. Push in on the sides of the glove box and lower the door.
3. Disconnect the glove box door dampener from the slot on the side of the box. This is done by grasping the dampener connector (on the outside of the box) and the end of the connector pin (on the inside of the box) with your thumb and forefinger and pulling outward while lightly lifting upward on the door with your other hand. Once disconnected, the dampener will retract underneath the instrument panel if you release it.



- Pivot the glove box downward.
- Disengage the two retaining tabs that secure the filter cover to the HVAC housing and remove the cover.

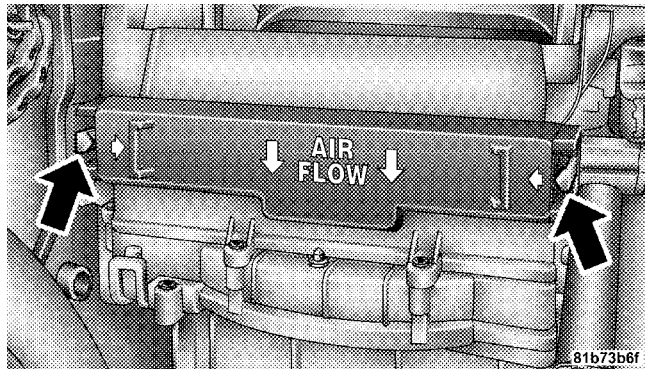

A/C Air Filter Replacement

- Remove the A/C Air Filter by pulling it straight out of the housing.
- Install the A/C Air Filter with the arrow on the filter pointing toward the floor. When installing the filter cover, make sure the retaining tabs fully engage the cover.

### CAUTION!

The A/C Air Filter is labeled with an arrow to indicate airflow direction through the filter. Failure to install the filter properly will result in the need to replace it more often.

- Reinstall the glove box door dampener and glove box.

### Body Lubrication

Locks and all body pivot points, including such items as seat tracks, door hinge pivot points and rollers, liftgate, tailgate, sliding doors and hood hinges, should be lubricated periodically with a lithium based grease such as MOPAR® Spray White Lube to assure quiet, easy operation and to protect against rust and wear. Prior to the application of any lubricant, the parts concerned should be wiped clean to remove dust and grit; after lubricating excess oil and grease should be removed. Particular attention should also be given to hood latching components to insure proper function. When performing other underhood services, the hood latch, release mechanism and safety catch should be cleaned and lubricated.

The external lock cylinders should be lubricated twice a year, preferably in the Fall and Spring. Apply a small amount of a high quality lubricant such as MOPAR® Lock Cylinder Lubricant directly into the lock cylinder.

### Windshield Wiper Blades

Clean the rubber edges of the wiper blades and the windshield periodically with a sponge or soft cloth and a mild non-abrasive cleaner or use the washer solvent. This will remove accumulations of salt, waxes, or road film and help reduce streaking and smearing.

Operation of the wipers on dry glass for long periods may cause deterioration of the wiper blades. Always use washer fluid when using the wipers to remove salt or dirt from a dry windshield.

Avoid using the wiper blades to remove frost or ice from the windshield. Make sure that they are not frozen to the glass before turning them on to avoid damaging the blade.

Keep the blade rubber out of contact with petroleum products such as engine oil, gasoline, etc.

**NOTE:** Always refer to the wiper blade packaging for specific installation instructions. Many wiper blade replacements fit multiple vehicles.

### **Adding Washer Fluid**

The fluid reservoir for the windshield washers is located in the engine compartment. Be sure to check the fluid level in the reservoir at regular intervals. Fill the reservoir with windshield washer solvent (not radiator antifreeze) and operate the system for a few seconds to flush out the residual water.

#### **WARNING!**

**Commercially available windshield washer solvents are flammable. They could ignite and burn you. Care must be exercised when filling or working around the washer solution.**

### **Exhaust System**

The best protection against carbon monoxide entry into the vehicle body is a properly maintained engine exhaust system.

If you notice a change in the sound of the exhaust system or if exhaust fumes can be detected inside the vehicle or when the underside or rear of the vehicle is damaged, have a competent technician inspect the complete exhaust system and adjacent body areas for broken, damaged, deteriorated, or mispositioned parts. Open seams or loose connections could permit exhaust fumes to seep into the passenger compartment. In addition, inspect the exhaust system each time the vehicle is raised for an oil change or lubrication. Replace as required.

**WARNING!**

Exhaust gases can injure or kill. They contain carbon monoxide (CO) which is colorless and odorless. Breathing it can make you unconscious and can eventually poison you. To avoid breathing CO, refer to Exhaust Gas in the Safety Tips section of this manual.

The catalytic converter requires the use of unleaded fuel only. Leaded gasoline will destroy the effectiveness of the catalyst as an emission control device.

Under normal operating conditions, the catalytic converter will not require maintenance. However, it is important to keep the engine properly tuned to assure proper catalyst operation and prevent possible catalyst damage.

**CAUTION!**

Damage to the catalytic converter can result if your vehicle is not kept in proper operating condition. In the event of engine malfunction, particularly involving engine misfire or other apparent loss of performance, have your vehicle serviced promptly. Continued operation of your vehicle with a severe malfunction could cause the converter to overheat, resulting in possible damage to the converter and the vehicle.

**NOTE:** Intentional tampering with emissions control systems can result in civil penalties being assessed against you.

**WARNING!**

**A hot exhaust system can start a fire if you park over materials that can burn. Such materials might be grass or leaves coming into contact with your exhaust system. Do not park or operate your vehicle in areas where your exhaust system can contact anything that can burn.**

In unusual situations involving grossly malfunctioning engine operation, a scorching odor may suggest severe and abnormal catalyst overheating. If this occurs, stop the vehicle, turn off the engine, and allow it to cool. Service, including a tune up to manufacturer's specifications, should be obtained immediately.

To minimize the possibility of catalyst damage:

- Do not shut off the engine or interrupt the ignition when the transaxle is in gear and the vehicle is in motion.
- Do not try to start the engine by pushing or towing the vehicle.
- Do not idle the engine with any ignition coil connectors disconnected for prolonged periods.

## Cooling System

### WARNING!

- When working near the radiator cooling fan, disconnect the fan motor lead or turn the ignition switch to the LOCK position. The fan is temperature controlled and can start at anytime the ignition switch is in the ON position.
- You or others can be badly burned by hot engine coolant (antifreeze) or steam from your radiator. If you see or hear steam coming from under the hood, do not open the hood until the radiator has had time to cool. Never try to open a cooling system pressure cap when the radiator is hot.

### Coolant Checks

Check engine coolant (antifreeze) protection every 12 months (before the onset of freezing weather, where applicable). If the engine coolant (antifreeze) is dirty or

rusty in appearance, the system should be drained, flushed, and refilled with fresh engine coolant (antifreeze). Check the front of the A/C condenser for any accumulation of bugs, leaves, etc. If dirty, clean by gently spraying water from a garden hose vertically down the face of the condenser.

Check the coolant recovery bottle tubing for brittle rubber, cracking, tears, cuts, and tightness of the connection at the bottle and radiator. Inspect the entire system for leaks.

### Cooling System — Drain, Flush, and Refill

If the engine coolant (antifreeze) is dirty or contains a considerable amount of sediment, clean and flush with a reliable cooling system cleaner. Follow with a thorough rinsing to remove all deposits and chemicals. Properly dispose of the old engine coolant (antifreeze).

Refer to the “Maintenance Schedule” in Section 8 of this manual for the proper maintenance intervals.

### Selection Of Coolant

Use only the manufacturer's recommended coolant. Refer to "Fluids, Lubricants, and Genuine Parts" in this section for the correct fluid type.

#### CAUTION!

- Mixing of engine coolant (antifreeze) other than specified HOAT engine coolant (antifreeze), may result in engine damage and may decrease corrosion protection. If a non-HOAT engine coolant (antifreeze) is introduced into the cooling system in an emergency, it should be replaced with the specified engine coolant (antifreeze) as soon as possible.

*(Continued)*

#### CAUTION! (Continued)

- Do not use water alone or alcohol-based engine coolant (antifreeze) products. Do not use additional rust inhibitors or antirust products, as they may not be compatible with the engine coolant (antifreeze) and may plug the radiator.
- This vehicle has not been designed for use with Propylene Glycol based engine coolant (antifreeze). Use of Propylene Glycol based engine coolant (antifreeze) is not recommended.

## Adding Coolant

Your vehicle has been built with an improved engine coolant (antifreeze) that allows extended maintenance intervals. This engine coolant (antifreeze) can be used up to 5 Years or 102,000 miles (170 000 km) before replacement. To prevent reducing this extended maintenance period, it is important that you use the same engine coolant (antifreeze) throughout the life of your vehicle. Please review these recommendations for using Hybrid Organic Additive Technology (HOAT) engine coolant (antifreeze).

When adding engine coolant (antifreeze):

- The manufacturer recommends using MOPAR® Antifreeze/Coolant 5 Year/100,000 Mile Formula HOAT (Hybrid Organic Additive Technology).

- Mix a minimum solution of 50% HOAT engine coolant (antifreeze) and distilled water. Use higher concentrations (not to exceed 70%) if temperatures below  $-34$  F ( $-37$  C) are anticipated.
- Use only high purity water such as distilled or deionized water when mixing the water/engine coolant (antifreeze) solution. The use of lower quality water will reduce the amount of corrosion protection in the engine cooling system.

Please note that it is the owner's responsibility to maintain the proper level of protection against freezing according to the temperatures occurring in the area where the vehicle is operated.

**NOTE:** Mixing engine coolant (antifreeze) types will decrease the life of the engine coolant (antifreeze) and will require more frequent coolant changes.



### Cooling System Pressure Cap

The cap must be fully tightened to prevent loss of engine coolant (antifreeze), and to ensure that engine coolant (antifreeze) will return to the radiator from the coolant recovery bottle.

The cap should be inspected and cleaned if there is any accumulation of foreign material on the sealing surfaces.

#### **WARNING!**

- The warning words “DO NOT OPEN HOT” on the cooling system pressure cap are a safety precaution. Never add engine coolant (antifreeze) when the engine is overheated. Do not loosen or remove the cap to cool an overheated engine. Heat causes pressure to build up in the cooling system. To prevent scalding or injury, do not remove the pressure cap while the system is hot or under pressure.
- Do not use a pressure cap other than the one specified for your vehicle. Personal injury or engine damage may result.

### **Disposal of Used Engine Coolant**

Used ethylene glycol based engine coolant (antifreeze) is a regulated substance requiring proper disposal. Check with your local authorities to determine the disposal rules for your community. To prevent ingestion by animals or children, do not store ethylene glycol based engine coolant (antifreeze) in open containers or allow it to remain in puddles on the ground. If ingested by a child, contact a physician immediately. Clean up any ground spills immediately.

### **Coolant Level**

**4 Cylinder Engines** — the coolant bottle provides a quick visual method for determining that the engine coolant (antifreeze) level is adequate. With the engine idling and warm to normal operating temperature, the level of the engine coolant (antifreeze) in the bottle should be between the “ADD” and “FULL” lines, shown on the bottle.

**6 Cylinder Engines** — the level of the engine coolant (antifreeze) in the pressurized coolant bottle should be between the “COLD” and “FULL” range on the bottle when the engine is cold.

The radiator normally remains completely full, so there is no need to remove the radiator cap unless checking for engine coolant (antifreeze) freeze point or replacing coolant. Advise your service attendant of this. As long as the engine operating temperature is satisfactory, the coolant bottle need only be checked once a month. When additional engine coolant (antifreeze) is needed to maintain the proper level, it should be added to the coolant bottle. Do not overfill.

### **Points To Remember**

**NOTE:** When the vehicle is stopped after a few miles (kilometers) of operation, you may observe vapor coming from the front of the engine compartment. This is normally a result of moisture from rain, snow, or high

humidity accumulating on the radiator and being vaporized when the thermostat opens, allowing hot engine coolant (antifreeze) to enter the radiator.

If an examination of your engine compartment shows no evidence of radiator or hose leaks, the vehicle may be safely driven. The vapor will soon dissipate.

- Do not overfill the coolant recovery bottle.
- Check engine coolant (antifreeze) freeze point in the radiator and in the coolant recovery bottle. If engine coolant (antifreeze) needs to be added, contents of coolant recovery bottle must also be protected against freezing.
- If frequent engine coolant (antifreeze) additions are required, or if the level in the coolant recovery bottle does not drop when the engine cools, the cooling system should be pressure tested for leaks.
- Maintain engine coolant (antifreeze) concentration at 50% HOAT engine coolant (antifreeze) (minimum) and distilled water for proper corrosion protection of your engine, which contains aluminum components.
- Make sure that the radiator and coolant recovery bottle overflow hoses are not kinked or obstructed.
- Keep the front of the radiator clean. If your vehicle is equipped with air conditioning, keep the front of the condenser clean.
- Do not change the thermostat for Summer or Winter operation. If replacement is ever necessary, install **ONLY** the correct type thermostat. Other designs may result in unsatisfactory cooling performance, poor gas mileage, and increased emissions.

## Brake System

In order to assure brake system performance, all brake system components should be inspected periodically. Refer to the "Maintenance Schedule" in Section 8 of this manual for the proper maintenance intervals.

### WARNING!

**Riding the brakes can lead to brake failure and possibly an accident. Driving with your foot resting or riding on the brake pedal can result in abnormally high brake temperatures, excessive lining wear, and possible brake damage. You would not have your full braking capacity in an emergency.**

### Master Cylinder - Brake Fluid Level Check

Check the fluid level in the master cylinder immediately if the brake system warning light indicates system failure.

Check the fluid level in the master cylinder when performing underhood services.

Clean the top of the master cylinder area before removing the cap. If necessary, add fluid to bring the fluid level up to the requirements described on the brake fluid reservoir.

Overfilling of fluid is not recommended because it may cause leaking in the system.

Fluid level can be expected to fall as the brake pads wear. Brake fluid level should be checked when pads are replaced. However, low fluid level may be caused by a leak and a checkup may be needed.

Use only manufacturer's recommended brake fluid. Refer to "Fluids, Lubricants, and Genuine Parts" in this section for the correct fluid type.

**WARNING!**

- Overfilling the brake fluid reservoir can result in spilling brake fluid on hot engine parts and the brake fluid catching fire.
- Use of a brake fluid that has a lower initial boiling point than the recommended MOPAR® DOT 3 product or a brake fluid that is unidentified as to FMVSS specification may result in sudden brake failure during hard prolonged braking. You could have an accident.

Use only brake fluid that has been in a tightly closed container to avoid contamination from foreign matter or moisture.

**CAUTION!**

Do not allow petroleum base fluid to contaminate the brake fluid, all brake seal components could be damaged causing partial or complete brake failure.

**Automatic Transaxle**

The automatic transaxle and differential assembly are contained within a single housing.

The fluid level in the automatic transaxle should be checked whenever the vehicle is serviced. Operation with an improper fluid level will greatly reduce the life of the transaxle and the fluid.

### Fluid Level Check — Vehicles with 2.4L and 2.7L Engines

Use the following procedure to check the automatic transaxle fluid level properly:

1. Park the vehicle on level ground.
2. Run the engine at curb idle speed for a minimum of 60 seconds.
3. Apply the parking brake fully.
4. Place the gear selector momentarily in each gear position ending with the lever in PARK.
5. Wipe the area around the dipstick clean to eliminate the possibility of dirt entering the transaxle.
6. Remove the dipstick and determine if the fluid is hot or cold. Hot fluid is approximately 180°F (82° C), which is the normal operating temperature after the vehicle is

driven at least 15 miles (24 km). Hot fluid cannot be held comfortably between the fingertips. Cold fluid is at a temperature below 80°F (27° C).

7. Wipe the dipstick clean and reinsert until seated. Then, remove dipstick and note the reading.
  - a. If the fluid is hot, the reading should be in the crosshatched area marked "HOT" (between the upper two holes in the dipstick).
  - b. If the fluid is cold, the fluid level should be between the lower two holes in the area marked "COLD."

If the fluid level is low, add sufficient fluid through the filler (dipstick) tube to bring it to the proper level. Do not overfill.

**CAUTION!**

- Using a transmission fluid other than the manufacturer's recommended fluid may cause deterioration in transmission shift quality and/or torque converter shudder. Using a transmission fluid other than that recommended by the manufacturer will result in more frequent fluid and filter changes. Refer to "Fluids, Lubricants, and Genuine Parts" for the correct fluid type.
- Dirt and water in the transaxle can cause serious damage. To prevent dirt and water from entering the transaxle after checking or replenishing fluid, make certain that the dipstick cap is re-seated properly.

**Fluid Level Check — Vehicles with 3.5L Engine**

The automatic transaxle has no dipstick and is dealer serviced only.

**Transmission Fluid and Filter Changes**

Refer to the "Maintenance Schedule" in Section 8 of this manual for the proper maintenance intervals.

In addition, change the fluid and filter if the transaxle is disassembled for any reason.

**Special Additives**

Automatic Transmission Fluid (ATF) is an engineered product and its performance may be impaired by supplemental additives. Therefore, do not add any fluid additives to the transaxle. The only exception to this policy is the use of special dyes to aid in detecting fluid leaks. In addition, avoid using transmission sealers as they may adversely affect seals.

## Appearance Care And Protection From Corrosion

### Protection of Body and Paint from Corrosion

Vehicle body care requirements vary according to geographic locations and usage. Chemicals that make roads passable in snow and ice and those that are sprayed on trees and road surfaces during other seasons are highly corrosive to the metal in your vehicle. Outside parking, which exposes your vehicle to airborne contaminants, road surfaces on which the vehicle is operated, extreme hot or cold weather and other extreme conditions will have an adverse effect on paint, metal trim, and underbody protection.

The following maintenance recommendations will enable you to obtain maximum benefit from the corrosion resistance built into your vehicle.

### What Causes Corrosion?

Corrosion is the result of deterioration or removal of paint and protective coatings from your vehicle.

The most common causes are:

- Road salt, dirt, and moisture accumulation.
- Stone and gravel impact.
- Insects, tree sap, and tar.
- Salt in the air near seacoast localities.
- Atmospheric fallout/industrial pollutants.



## Washing

- Wash your vehicle regularly. Always wash your vehicle in the shade using MOPAR® Car Wash or a mild car wash soap, and rinse the panels completely with clear water.
- If insects, tar, or other similar deposits have accumulated on your vehicle, use MOPAR® Super Kleen Bug and Tar Remover to remove.
- Use MOPAR® Cleaner Wax to remove road film, stains and to protect your paint finish. Take care never to scratch the paint.
- Avoid using abrasive compounds and power buffing that may diminish the gloss or thin out the paint finish.

### CAUTION!

**Do not use abrasive or strong cleaning materials such as steel wool or scouring powder, which will scratch metal and painted surfaces.**

## Special Care

- If you drive on salted or dusty roads or if you drive near the ocean, hose off the undercarriage at least once a month.
- It is important that the drain holes in the lower edges of the doors, rocker panels, and trunk be kept clear and open.
- If you detect any stone chips or scratches in the paint, touch them up immediately. The cost of such repairs is considered the responsibility of the owner.

- If your vehicle is damaged due to an accident or similar cause which destroys the paint and protective coating, have your vehicle repaired as soon as possible. The cost of such repairs is considered the responsibility of the owner.
- If you carry special cargo such as chemicals, fertilizers, de-icer salt, etc., be sure that such materials are well packaged and sealed.
- If a lot of driving is done on gravel roads, consider mud or stone shields behind each wheel.
- Use MOPAR® Touch Up Paint on scratches as soon as possible. Your authorized dealer has touch up paint to match the color of your vehicle.

### **Wheel and Wheel Trim Care**

All wheels and wheel trim, especially aluminum and chrome plated wheels, should be cleaned regularly with a mild soap and water to prevent corrosion. To remove

heavy soil and/or excessive brake dust, use MOPAR® Wheel Cleaner or equivalent or select a nonabrasive, non-acidic cleaner. Do not use scouring pads, steel wool, a bristle brush, or metal polishes. Only MOPAR® or equivalent is recommended. Do not use oven cleaner. Avoid automatic car washes that use acidic solutions or harsh brushes that may damage the wheels' protective finish.

### **Cleaning Headlights**

Your vehicle has plastic headlights that are lighter and less susceptible to stone breakage than glass headlights.

Plastic is not as scratch resistant as glass and therefore different lens cleaning procedures must be followed.

To minimize the possibility of scratching the lenses and reducing light output, avoid wiping with a dry cloth. To remove road dirt, wash with a mild soap solution followed by rinsing.

Do not use abrasive cleaning components, solvents, steel wool or other aggressive material to clean the lenses.

## Interior Care

### *Instrument Panel Cover*

The instrument panel cover has a low glare surface, which minimizes reflections in the windshield. Do not use protectants or other products, which may cause undesirable reflections. Use soap and warm water to restore the low glare surface.

### *Cleaning Interior Trim*

Interior Trim should be cleaned starting with a damp cloth, a damp cloth with MOPAR® Total Clean, then MOPAR® Spot & Stain Remover if absolutely necessary. Do not use harsh cleaners or Armorall. Use MOPAR® Total Clean to clean vinyl upholstery

### *Cleaning Leather Upholstery*

MOPAR® Total Clean is specifically recommended for leather upholstery.

Your leather upholstery can be best preserved by regular cleaning with a damp soft cloth. Small particles of dirt can act as an abrasive and damage the leather upholstery and should be removed promptly with a damp cloth. Stubborn soils can be removed easily with a soft cloth and MOPAR® Total Clean. Care should be taken to avoid soaking your leather upholstery with any liquid. Please do not use polishes, oils, cleaning fluids, solvents, detergents, or ammonia-based cleaners to clean your leather upholstery. Application of a leather conditioner is not required to maintain the original condition.

**WARNING!**

Do not use volatile solvents for cleaning purposes. Many are potentially flammable, and if used in closed areas they may cause respiratory harm.

**YES Essentials® Fabric Cleaning Procedure – If Equipped**

YES Essentials® seats may be cleaned in the following manner:

- Remove as much of the stain as possible by blotting with a clean, dry towel.
- Blot any remaining stain with a clean, damp towel.
- For tough stains, apply MOPAR® Total Clean or a mild soap solution to a clean, damp cloth and remove stain. Use a fresh, damp towel to remove soap residue.

- For grease stains, apply MOPAR® Multi-Purpose Cleaner to a clean, damp cloth and remove stain. Use a fresh, damp towel to remove soap residue.
- Do not use any solvents or protectants on Yes Essentials® products.

**Glass Surfaces**

All glass surfaces should be cleaned on a regular basis with MOPAR® Glass Cleaner or any commercial household-type glass cleaner. Never use an abrasive type cleaner. Use caution when cleaning the inside rear window equipped with electric defrosters or the right rear quarter window equipped with the radio antenna. Do not use scrapers or other sharp instruments, which may scratch the elements.

When cleaning the rear view mirror, spray cleaner on the towel or rag that you are using. Do not spray cleaner directly on the mirror.

### **Cleaning Plastic Instrument Cluster Lenses**

The lenses in front of the instruments in this vehicle are molded in clear plastic. When cleaning the lenses, care must be taken to avoid scratching the plastic.

1. Clean with a wet, soft rag. A mild soap solution may be used, but do not use high alcohol content or abrasive cleaners. If soap is used, wipe clean with a clean damp rag.
2. Dry with a soft tissue.

### **Seat Belt Maintenance**

Do not bleach, dye, or clean the belts with chemical solvents or abrasive cleaners. This will weaken the fabric. Sun damage can also weaken the fabric.

If the belts need cleaning, use a mild soap solution or lukewarm water. Do not remove the belts from the car to wash them.

Replace the belts if they appear frayed or worn or if the buckles do not work properly.

Dry with a soft tissue.

### **Cleaning Center Console Cupholders**

#### **Removal**

Grab the rubber portion of the cupholder and lift upward.

#### **Cleaning**

Soak the rubber cupholder liner in a mixture of medium hot tap water and one teaspoon of mild liquid dish soap. Let soak for approximately one hour. After one hour pull the liner from the water and dip it back into the water about six times. This will loosen any remaining debris. Rinse the liner thoroughly under warm running water. Shake the excess water from the liner and dry the outer surfaces with a clean soft cloth.

### Installation

Align the liner in the cupholder and press down firmly.

## FUSES

### Totally Integrated Power Module (TIPM)

The TIPM is located in the engine compartment near the air cleaner assembly. This center contains cartridge fuses and mini fuses. A label that identifies each component may be printed on the inside of the cover. Refer to the graphic below for FUSES/TIPM location.

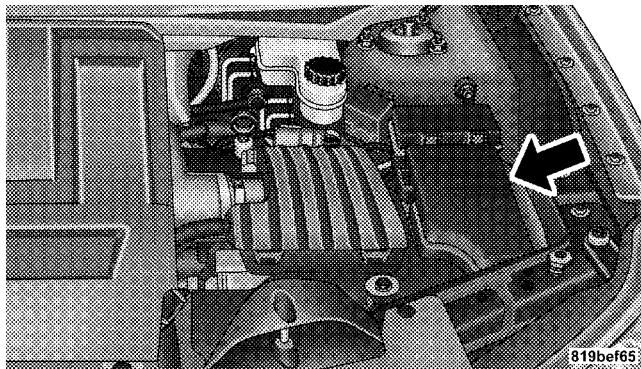

**Totally Integrated Power Module (TIPM)**

Cavity	Cartridge Fuse	Mini Fuse	Description
1	40 Amp Green	—	Power Top Module (If Equipped)
2	—	20 Amp Yellow	AWD Module
3	—	10 Amp Red	Battery Feed — Center High Mounted Stop Light (CHMSL)/ Brake Switch
4	—	10 Amp Red	Battery Feed — Ignition Switch
5	—	20 Amp Yellow	Trailer Tow — If Equipped

Cavity	Cartridge Fuse	Mini Fuse	Description
6	—	10 Amp Red	Ignition Off Draw (IOD) — Power Mirror Switch/Climate Controls
7	—	30 Amp Green	Ignition Off Draw (IOD) Sense 1
8	—	30 Amp Green	Ignition Off Draw (IOD) Sense 2
9	40 Amp Green		Battery Feed — Power Seats - if equipped/PZEV Air Pump - if equipped

Cavity	Cartridge Fuse	Mini Fuse	Description
10	—	20 Amp Yellow	Battery Feed — Cabin Compartment Node (CCN)
11	—	15 Amp Lt Blue	Selectable Power Outlet
12	—	20 Amp Yellow	—
13	—	20 Amp Yellow	—
14	—	10 Amp Red	Ignition Off Draw (IOD) — Cabin Compartment Node (CCN)/ Interior Lighting

Cavity	Cartridge Fuse	Mini Fuse	Description
15	40 Amp Green	—	Battery Feed — Radiator Fan Relay
16	—	15 Amp Lt. Blue	IGN Run/ACC — Cigar Lighter/ PWR Sunroof Mod
17	—	10 Amp Red	Ignition Off Draw (IOD) — Wireless Control Module (WCM)/ Clock/Steering Control Module (SCM)
18	40 Amp Green	—	Battery Feed — Auto Shutdown (ASD) Relay



Cavity	Cartridge Fuse	Mini Fuse	Description
19	—	20 Amp Yellow	Ignition Off Draw (IOD) — Power Amp Feed 2 - if equipped
20	—	15 Amp Lt. Blue	Ignition Off Draw (IOD) — Radio
21	—	10 Amp Red	—
22	—	10 Amp Red	Ignition Run — Climate Controls/Hot Cupholder - if equipped
23	—	15 Amp Lt. Blue	Auto Shutdown (ASD) Relay Feed 3

Cavity	Cartridge Fuse	Mini Fuse	Description
24	—	25 Amp Clear	Battery Feed — PWR Sunroof Feed
25	—	10 Amp Red	Ignition Run — Heated Mirrors - If Equipped
26	—	15 Amp Lt. Blue	Auto Shutdown (ASD) Relay Feed 2
27	—	10 Amp Red	Ignition Run — Occupant Classification Module (OCM)/Occupant Restraint Controller (ORC)

Cavity	Cartridge Fuse	Mini Fuse	Description
28	—	10 Amp Red	Ignition Run — Occupant Classification Module (OCM)/Occupant Restraint Controller (ORC)
29	—	—	Hot Car (No Fuse Required)
30	—	20 Amp Yellow	Ignition Run — Heated Seats - If Equipped
31	—	10 Amp Red	—
32	30 Amp Pink	—	Auto Shutdown (ASD) Relay Feed 1

Cavity	Cartridge Fuse	Mini Fuse	Description
33	—	10 Amp Red	Battery Feed — Switch Bank/ Diagnostic Link Connector/ Powertrain Control Module (PCM)
34	30 Amp Pink	—	Battery Feed — Anti-Lock Brakes (ABS) Module - if equipped/ Electronic Stability Program (ESP) Module - If Equipped

Cavity	Cartridge Fuse	Mini Fuse	Description
35	40 Amp Green	—	Battery Feed — Anti-Lock Brakes (ABS) Module - If Equipped/ Electronic Stabil- ity Program (ESP) Module - If Equipped
36	30 Amp Pink	—	Battery Feed — Passenger Door Module (PDM)/ Driver Door Module (DDM)
37	—	25 Amp Clear	Power Top Mod- ule (If Equipped)

### CAUTION!

- When installing the Totally Integrated Power Module cover, it is important to ensure the cover is properly positioned and fully latched. Failure to do so may allow water to get into the Totally Integrated Power Module, and possibly result in an electrical system failure.
- When replacing a blown fuse, it is important to use only a fuse having the correct amperage rating. The use of a fuse with a rating other than indicated may result in a dangerous electrical system overload. If a properly rated fuse continues to blow, it indicates a problem in the circuit that must be corrected.

**VEHICLE STORAGE**

If you will not be using your vehicle for more than 21 days, you may want to take steps to preserve your battery.

- Disengage the mini-fuse in the Power Distribution Center labeled IOD (Ignition Off-Draw).
- Disconnect the negative cable from the battery.

**REPLACEMENT BULBS**

All the inside bulbs are brass or glass wedge base. Aluminum base bulbs are not approved and should not be used for replacement.

<b>LIGHT BULBS — Interior</b>	<b>Bulb No.</b>
Front Courtesy/Reading Light . . . . .	578/W5W
Center Courtesy/Reading Light . . . . .	578/W5W
Visor Vanity Light . . . . .	A6220
Glove Box Light . . . . .	A6220
Shift Indicator Light . . . . .	IKLE14140
Rear Compartment (Trunk) Light . . . . .	579

**NOTE:** For lighted switches, see your authorized dealer for replacement.

<b>LIGHT BULBS — Exterior</b>	<b>Bulb No.</b>
Low Beam Headlight . . . . .	9006
High Beam Headlight . . . . .	9005
Front Park/Turn Signal/Side Marker Light . . . . .	3157AK
Front Fog Light . . . . .	9145/H10
Center High Mounted Stop (CHMSL) Light . . . . .	W16W (921)
Rear Tail/Stop Light . . . . .	3157K
Rear Turn Signal Light . . . . .	3057
Backup Light . . . . .	3157
License Light . . . . .	168 or W5W

## BULB REPLACEMENT

### Headlight

1. Raise and prop open the hood. Locate the connector behind the headlight.

**NOTE:** It may be necessary to remove the air cleaner filter housing and position the totally integrated power module aside prior to replacing the low beam headlight on the driver's side of the vehicle.

2. Reach into engine compartment and from behind the lamp assembly and grasp the connector.



3. Rotate bulb and connector one-quarter turn and pull outward from assembly.

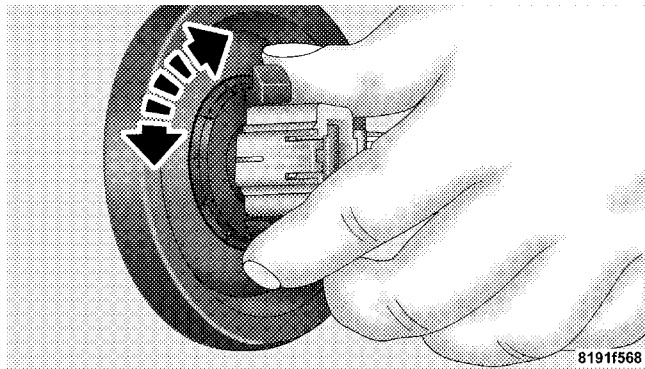

**CAUTION!**

Do not touch the new bulb with your fingers. Oil contamination will severely shorten bulb life.

4. Pull the bulb out of the socket and replace the bulb.

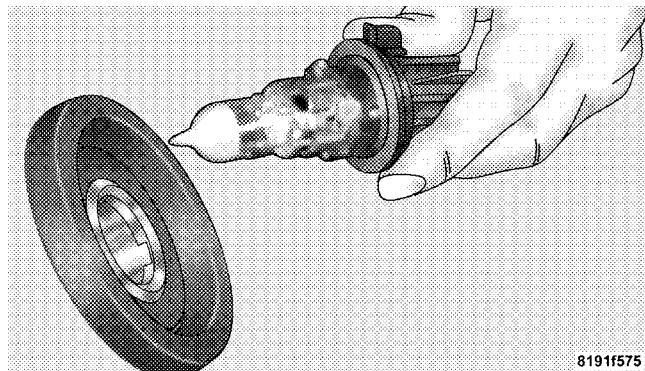

5. If the bulb comes in contact with any oily surface, clean the bulb with rubbing alcohol.

6. Reinsert the bulb and socket assembly and rotate clockwise one-quarter turn to secure.

## Front Turn Signal/Parking Light

1. Raise and prop open the hood.
2. Rotate the bulb's electrical connector one-quarter turn counterclockwise and remove it from the headlight housing.

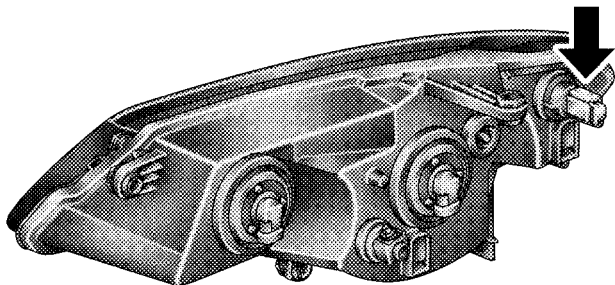

81b71ee8

3. Remove the bulb from the connector socket and install the replacement bulb.
4. Install the bulb and connector assembly into the headlight housing and rotate the connector one-quarter turn clockwise to lock it in place.

## Front Fog Light

**NOTE:** Access to the lights through the lower fascia cutout is limited. We recommend you access the lights by turning the steering wheel to allow access and remove the inner fender shield.

1. Rotate the bulb's electrical connector one-quarter turn counterclockwise and remove it from the fog light housing.

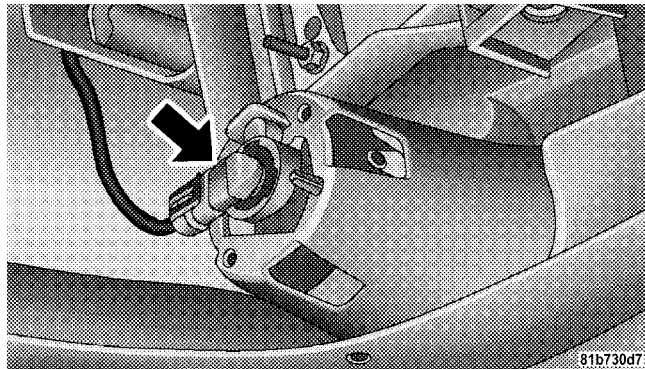

2. Remove the bulb from the connector socket and install the replacement bulb.

**CAUTION!**

**Do not touch the new bulb with your fingers. Oil contamination will severely shorten bulb life. If the bulb comes in contact with an oily surface, clean the bulb with rubbing alcohol.**

3. Install the bulb and connector assembly into the fog light housing and rotate the connector one-quarter turn clockwise to lock it in place.



### Tail/Stop, Rear Turn Signal and Backup Lights

The taillights are a two piece design. The turn signal, brake and taillights are located in the rear corner body panel housing. The backup and taillights are located in the trunk lid housing.

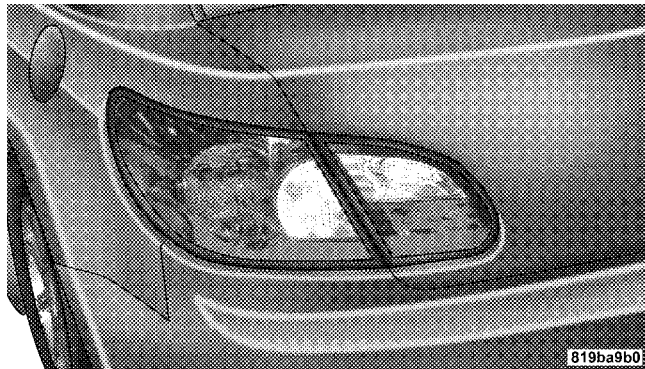

### Changing the Tail/Stop Light or Rear Turn Signal Light

1. Open the trunk and gently pull back the trunk liner behind the tail lamp

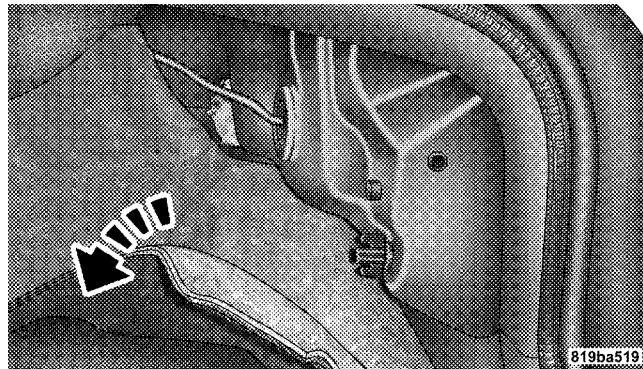

2. Remove the two plastic wing nuts from the taillight housing.

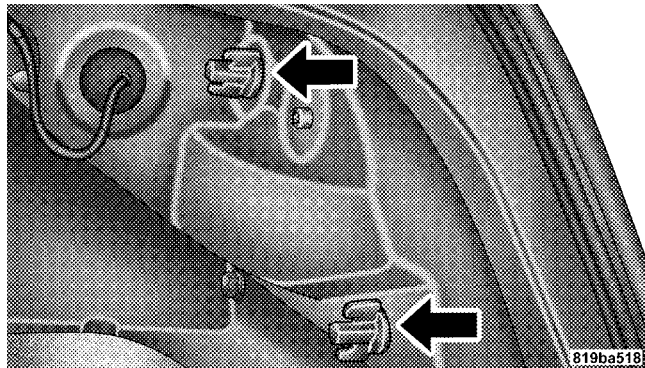

3. Grasp the taillight housing and pull it firmly outward while pushing gently on the studs from inside to disengage the housing from the vehicle.

4. Rotate the applicable bulb's electrical connector one-quarter turn counterclockwise and remove it from the taillight housing.

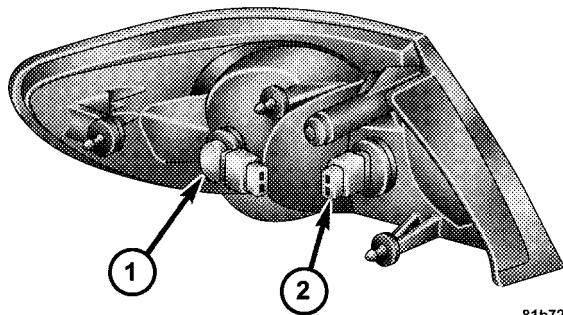

1 — Tail/Stop Light

2 — Turn Signal Light

5. Remove the bulb from the connector socket and install the replacement bulb.

6. Install the bulb and connector assembly into the taillight housing and rotate the connector one-quarter turn clockwise to lock it in place.

7. Reinstall the taillight housing.

### Changing the Backup Light

1. Open the trunk.

2. Rotate the bulb's electrical connector one-quarter turn counterclockwise and remove it from the housing.

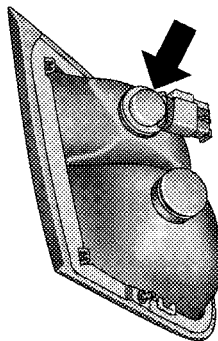

81b7273b

1 — Rear Fog Light

2 — Backup Light

7

3. Remove the bulb from the connector socket and install the replacement bulb.

4. Install the bulb and connector assembly into the housing and rotate the connector one-quarter turn clockwise to lock it in place.

## License Plate Light

1. Remove two retaining screws holding the light lens in place.

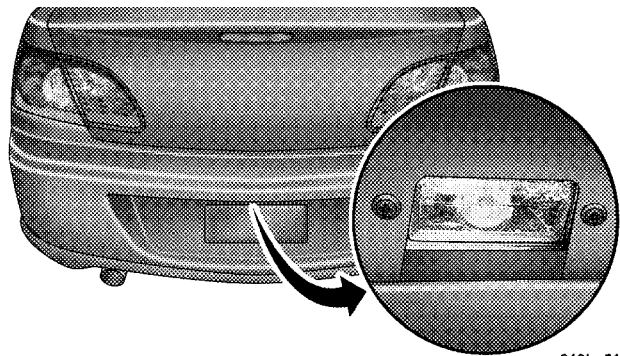

819ba516

2. Gently pry the lens loose.
3. Pull bulb from socket, replace and reattach the light lens with the two retaining screws.

## Center High-Mounted Stop Light (CHMSL)

1. Open the trunk lid.
2. Rotate the bulb's electrical connector one-quarter turn counterclockwise and remove it from the CHMSL housing.

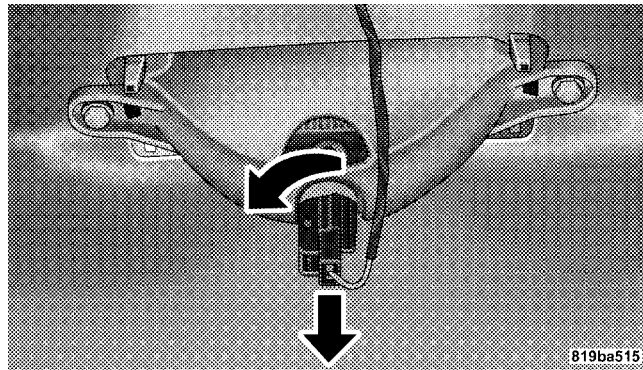

819ba515

3. Remove the bulb from the connector socket and install the replacement bulb.
4. Install the bulb and connector assembly into the CHMSL housing and rotate the connector one-quarter turn clockwise to lock it in place.

## FLUIDS AND CAPACITIES

	U.S.	Metric
<b>Fuel (Approximate)</b>		
2.4L and 2.7L Engines — (Except 2.4L PZEV)	16.9 Gallons	64 Liters
2.4L PZEV (Partial Zero Emissions Vehicle)	18.5 Gallons	70 Liters
3.5L Engine	17.2 Gallons	65 Liters
<b>Engine Oil with Filter</b>		
2.4L Engine (SAE 5W-20, API Certified)	4.5 Quarts	4.4 Liters
2.7L Engine (SAE 5W-20, API Certified)	5.5 Quarts	5.2 Liters
3.5L Engine (SAE 10W-30, API Certified)	5.5 Quarts	5.2 Liters

	U.S.	Metric
<b>Cooling System*</b>		
2.4L Engine (MOPAR® Antifreeze/Coolant 5 Year/100,000 Mile Formula) or equivalent.	7.7 Quarts	7.3 Liters
2.7L Engine (MOPAR® Antifreeze/Coolant 5 Year/100,000 Mile Formula) or equivalent.	9.8 Quarts	9.3 Liters
3.5L Engine (MOPAR® Antifreeze/Coolant 5 Year/100,000 Mile Formula) or equivalent.	11.6 Quarts	11 Liters

\* Includes heater and coolant recovery bottle filled to MAX level.

## FLUIDS, LUBRICANTS, AND GENUINE PARTS

### Engine

Component	Fluid, Lubricant, or Genuine Part
Engine Coolant	MOPAR® Antifreeze/Coolant 5 Year/100,000 Mile Formula HOAT (Hybrid Organic Additive Technology) or equivalent
Engine Oil (2.4L and 2.7L Engines)	Use API Certified engine oil. SAE 5W-20 is recommended. Refer to the engine oil fill cap for the correct SAE grade meeting Chrysler Material Standard MS-6395.

Component	Fluid, Lubricant, or Genuine Part
Engine Oil (3.5L Engine)	Use API Certified engine oil. SAE 10W-30 is recommended. Refer to the engine oil viscosity chart for the correct SAE grade meeting Chrysler Material Standard MS-6395.
Oil Filter (2.4L Engine )	MOPAR® Oil Filter (P/N 04884900AB) or equivalent
Oil Filter (2.7L and 3.5L Engine)	MOPAR® Oil Filter (P/N 04884899AB) or equivalent
Spark Plugs (2.4L Engine except PZEV*)	ZFR5F-11 (Gap 0.043 in [1.11 mm])
Spark Plugs (2.4L with PZEV)	ZFR5AP (Gap 0.031 in [0.8 mm])
Spark Plugs (2.7L Engine)	TE10PMC5 (Gap 0.050 in [1.27 mm])
Spark Plugs (3.5L Engine)	ZFR5LP-13G (Gap 0.050 in [1.27 mm])
Fuel Selection (2.4L and 2.7L Engine)	87 Octane
Fuel Selection (2.7L Engine - EXCEPT CALIFORNIA EMISSION STATES)	E-85 Ethanol
Fuel Selection (3.5L Engine)	89 Octane
* PZEV = Partial Zero Emission Vehicle	

**Chassis**

<b>Component</b>	<b>Fluid, Lubricant, or Genuine Part</b>
Automatic Transaxle	MOPAR® ATF+4 Automatic Transmission Fluid
Brake Master Cylinder	MOPAR® DOT 3 and SAE J1703 should be used. If DOT 3 brake fluid is not available, then DOT 4 is acceptable. Use only recommended brake fluids.
Power Steering Reservoir	MOPAR® ATF+4 Automatic Transmission Fluid



# MAINTENANCE SCHEDULES

## CONTENTS

---

■ Emissions Control System Maintenance . . . . .	424	□ Required Maintenance Intervals . . . . .	426
■ Maintenance Schedule . . . . .	424		

### EMISSIONS CONTROL SYSTEM MAINTENANCE

The Scheduled Maintenance services listed in **bold type** must be done at the times or mileages specified to ensure the continued proper functioning of the emissions control system. These and all other maintenance services included in this manual, should be done to provide best vehicle performance and reliability. More frequent maintenance may be needed for vehicles in severe operating conditions, such as dusty areas and very short trip driving.

Inspection and service should also be done anytime a malfunction is suspected.

**NOTE:** Maintenance, replacement or repair of the emissions control devices and systems on your vehicle may be performed by any automotive repair establishment or individual using any automotive part that has been certified pursuant to U.S. EPA or in the State of California, California Air Resources Board regulations.

### MAINTENANCE SCHEDULE

The oil change indicator system will remind you that it is time to take your vehicle in for scheduled maintenance.

On Electronic Vehicle Information Center (EVIC) equipped vehicles “Oil Change Required” will be displayed in the EVIC and a single chime will sound, indicating that an oil change is necessary.

On Non-EVIC equipped vehicles “Change Oil” will flash in the instrument cluster odometer and a single chime will sound, indicating that an oil change is necessary.

Based on engine operation conditions the oil change indicator message will illuminate, this means that service is required for your vehicle. Have your vehicle serviced as soon as possible, within the next 500 miles (805 km).

**NOTE:**

- The oil change indicator message will not monitor the time since the last oil change. Change your vehicle's oil if it has been 6 months since your last oil change even if the oil change indicator message is NOT illuminated.
- Change your engine oil more often if you drive your vehicle off-road for an extended period of time.
- Under no circumstances should oil change intervals exceed 6,000 miles (10 000 km) or six months, whichever comes first.

Your dealer will reset the oil change indicator message after completing the scheduled oil change. If this scheduled oil change is performed by someone other than your

dealer the message can be reset by referring to the steps described under "Oil Change Required" in "Use Factory Settings" of the EVIC section in this manual or under "Odometer/Trip Odometer" in the "Instrument Cluster Descriptions" section of this manual.

*At Each Stop for Fuel*

- Check the engine oil level about five minutes after a fully warmed engine is shut off. Checking the oil level while the vehicle is on level ground will improve the accuracy of the oil level reading. Add oil only when the level is at or below the ADD or MIN mark.
- Check the windshield washer solvent and add if required.

*Once a Month*

- Check tire pressure and look for unusual wear or damage.
- Inspect the battery and clean and tighten the terminals as required.
- Check the fluid levels of coolant reservoir, brake master cylinder, and transmission and add as needed.
- Check all lights and other electrical items for correct operation.

*At Each Oil Change*

- Change the engine oil filter.
- Inspect the brake hoses and lines.

**CAUTION!**

**Failure to perform the required maintenance items may result in damage to the vehicle.**

**Required Maintenance Intervals**

Refer to the Maintenance Schedules on the following pages for the required maintenance intervals.

**6,000 Miles (10,000 km) or  
6 Months Maintenance Service  
Schedule**

- Change the engine oil and engine oil filter.
- Rotate tires.

\_\_\_\_\_  
Odometer Reading Date

\_\_\_\_\_  
Repair Order # Dealer Code

\_\_\_\_\_  
Signature Authorized Chrysler Dealer

**12,000 Miles (20,000 km) or 12 Months Maintenance Service  
Schedule**

- Change the engine oil and engine oil filter.
- Rotate tires.
- If using your vehicle in dusty or off-road conditions, inspect the engine air cleaner filter, and replace if necessary.
- Inspect the brake linings, and replace as necessary.
- Replace the air conditioning filter (if equipped).
- Inspect the CV joints. Perform the first inspection at 12,000 miles (20 000 km) or 12 months.
- Inspect the exhaust system. Perform the first inspection at 12,000 miles (20 000 km) or 12 months.

\_\_\_\_\_  
Odometer Reading Date

\_\_\_\_\_  
Repair Order # Dealer Code

\_\_\_\_\_  
Signature Authorized Chrysler Dealer

**18,000 Miles (30,000 km) or 18 Months Maintenance Service Schedule**

- Change the engine oil and engine oil filter.
- Rotate tires.

\_\_\_\_\_  
 Odometer Reading Date

\_\_\_\_\_  
 Repair Order # Dealer Code

\_\_\_\_\_  
 Signature Authorized Chrysler Dealer

**24,000 Miles (40,000 km) or 24 Months Maintenance Service Schedule**

- Change the engine oil and engine oil filter.
- Rotate tires.
- If using your vehicle in dusty or off-road conditions, inspect the engine air cleaner filter, and replace if necessary.
- Inspect the brake linings, and replace as necessary.
- Replace the air conditioning filter (if equipped).
- Inspect the CV joints.
- Inspect the exhaust system.
- Inspect the front suspension, tie rod ends and boot seals, and replace if necessary.

\_\_\_\_\_  
 Odometer Reading Date

\_\_\_\_\_  
 Repair Order # Dealer Code

\_\_\_\_\_  
 Signature Authorized Chrysler Dealer

**30,000 Miles (50,000 km) or  
30 Months Maintenance  
Service Schedule**

- Change the engine oil and engine oil filter.
- Rotate tires.
- Replace the engine air cleaner filter.
- Replace the spark plugs (2.4L Engine except PZEV\*).**

\_\_\_\_\_  
Odometer Reading Date

\_\_\_\_\_  
Repair Order # Dealer Code

\_\_\_\_\_  
Signature Authorized Chrysler Dealer

**36,000 Miles (60,000 km) or  
36 Months Maintenance  
Service Schedule**

- Change the engine oil and engine oil filter.
- Rotate tires.
- If using your vehicle in dusty or off-road conditions, inspect the engine air cleaner filter, and replace if necessary.
- Inspect the brake linings, and replace as necessary.
- Replace the air conditioning filter (if equipped).

\_\_\_\_\_  
Odometer Reading Date

\_\_\_\_\_  
Repair Order # Dealer Code

\_\_\_\_\_  
Signature Authorized Chrysler Dealer

**42,000 Miles (70,000 km) or  
42 Months Maintenance  
Service Schedule**

- Change the engine oil and engine oil filter.
- Rotate tires.

\_\_\_\_\_  
Odometer Reading Date

\_\_\_\_\_  
Repair Order # Dealer Code

\_\_\_\_\_  
Signature Authorized Chrysler Dealer

**48,000 Miles (80,000 km) or 48 Months Maintenance Service Schedule**

- Change the engine oil and engine oil filter.
- Rotate tires.
- If using your vehicle in dusty or off-road conditions, inspect the engine air cleaner filter, and replace if necessary.
- Inspect the brake linings, and replace as necessary.
- Replace the air conditioning filter (if equipped).
- Inspect the CV joints.
- Inspect the exhaust system.
- Inspect the front suspension, tie rod ends and boot seals, and replace if necessary.

\_\_\_\_\_

Odometer Reading Date

\_\_\_\_\_

Repair Order # Dealer Code

\_\_\_\_\_

Signature Authorized Chrysler Dealer

**54,000 Miles (90,000 km) or 54 Months Maintenance Service Schedule**

- Change the engine oil and engine oil filter.
- Rotate tires.

\_\_\_\_\_

Odometer Reading Date

\_\_\_\_\_

Repair Order # Dealer Code

\_\_\_\_\_

Signature Authorized Chrysler Dealer



**60,000 Miles (100,000 km) or 60 Months Maintenance Service Schedule**

- Change the engine oil and engine oil filter.
- Rotate tires.
- Replace the engine air cleaner filter.
- Replace the spark plugs (2.4L Engine except PZEV\*).**
- Inspect the brake linings, and replace as necessary.
- Replace the air conditioning filter (if equipped).
- Change the automatic transaxle fluid & filter if using your vehicle for any of the following: police, taxi, fleet, or frequent trailer towing.

\_\_\_\_\_ Date

\_\_\_\_\_ Dealer Code

\_\_\_\_\_  
Signature Authorized Chrysler Dealer

**66,000 Miles (110,000 km) or 66 Months Maintenance Service Schedule**

- Change the engine oil and engine oil filter.
- Rotate tires.

\_\_\_\_\_ Date

\_\_\_\_\_ Dealer Code

\_\_\_\_\_  
Signature Authorized Chrysler Dealer

**72,000 Miles (120,000 km) or 72 Months Maintenance Service Schedule**

- Change the engine oil and engine oil filter.
- Rotate tires.
- If using your vehicle in dusty or off-road conditions, inspect the engine air cleaner filter, and replace if necessary.
- Inspect the brake linings, and replace as necessary.
- Replace the air conditioning filter (if equipped).
- Inspect the CV joints.
- Inspect the exhaust system.
- Inspect the front suspension, tie rod ends and boot seals, and replace if necessary.

\_\_\_\_\_ Date

\_\_\_\_\_ Dealer Code

\_\_\_\_\_  
Signature Authorized Chrysler Dealer

**78,000 Miles (130,000 km) or 78 Months Maintenance Service Schedule**

- Change the engine oil and engine oil filter.
- Rotate tires.

\_\_\_\_\_ Date

\_\_\_\_\_ Dealer Code

\_\_\_\_\_  
Signature Authorized Chrysler Dealer

**84,000 Miles (140,000 km) or  
84 Months Maintenance  
Service Schedule**

- Change the engine oil and engine oil filter.
- Rotate tires.
- If using your vehicle in dusty or off-road conditions, inspect the engine air cleaner filter, and replace if necessary.
- Inspect the brake linings, and replace as necessary.
- Replace the air conditioning filter (if equipped).

\_\_\_\_\_  
Odometer Reading Date

\_\_\_\_\_  
Repair Order # Dealer Code

\_\_\_\_\_  
Signature Authorized Chrysler Dealer

**90,000 Miles (150,000 km) or  
90 Months Maintenance  
Service Schedule**

- Change the engine oil and engine oil filter.
- Rotate tires.
- Replace the engine air cleaner filter.
- Replace the spark plugs (2.4L Engine except PZEV\*).**
- Inspect and replace the PCV valve, if necessary†.**

\_\_\_\_\_  
Odometer Reading Date

\_\_\_\_\_  
Repair Order # Dealer Code

\_\_\_\_\_  
Signature Authorized Chrysler Dealer

**96,000 Miles (160,000 km) or 96 Months Maintenance Service Schedule**

- Change the engine oil and engine oil filter.
- Rotate tires.
- If using your vehicle in dusty or off-road conditions, inspect the engine air cleaner filter, and replace if necessary.
- Inspect the brake linings, and replace as necessary.
- Replace the air conditioning filter (if equipped).
- Inspect the CV joints.
- Inspect the exhaust system.
- Inspect the front suspension, tie rod ends and boot seals, and replace if necessary.

\_\_\_\_\_

Odometer Reading Date

\_\_\_\_\_

Repair Order # Dealer Code

\_\_\_\_\_

Signature Authorized Chrysler Dealer

**102,000 Miles (170,000 km) or 102 Months Maintenance Service Schedule**

- Change the engine oil and engine oil filter.
- Rotate tires.
- Replace the spark plugs (2.4L PZEV\*, 2.7L and 3.5L Engines).**
- Replace the timing belt (3.5L Engine).**
- Flush and replace the engine coolant.
- Inspect accessory drive belt, replace if necessary.

\_\_\_\_\_

Odometer Reading Date

\_\_\_\_\_

Repair Order # Dealer Code

\_\_\_\_\_

Signature Authorized Chrysler Dealer

**108,000 Miles (180,000 km) or  
108 Months Maintenance  
Service Schedule**

- Change the engine oil and engine oil filter.
- Rotate tires.
- If using your vehicle in dusty or off-road conditions, inspect the engine air cleaner filter, and replace if necessary.
- Inspect the brake linings, and replace as necessary.
- Replace the air conditioning filter (if equipped).

\_\_\_\_\_  
Odometer Reading Date

\_\_\_\_\_  
Repair Order # Dealer Code

\_\_\_\_\_  
Signature Authorized Chrysler Dealer

**114,000 Miles (190,000 km) or  
114 Months Maintenance  
Service Schedule**

- Change the engine oil and engine oil filter.
- Rotate tires.

\_\_\_\_\_  
Odometer Reading Date

\_\_\_\_\_  
Repair Order # Dealer Code

\_\_\_\_\_  
Signature Authorized Chrysler Dealer

**120,000 Miles (200,000 km) or 120 Months Maintenance Service Schedule**

- Change the engine oil and engine oil filter.
- Rotate tires.
- Replace the engine air cleaner filter.
- Replace the spark plugs (2.4L Engine except PZEV\*).**
- Inspect the brake linings, and replace as necessary.
- Replace the air conditioning filter (if equipped).
- Inspect the CV joints.
- Inspect the exhaust system.
- Inspect the front suspension, tie rod ends and boot seals, and replace if necessary.
- Change the automatic transaxle fluid & filter.

\_\_\_\_\_

Odometer Reading Date

\_\_\_\_\_

Repair Order # Dealer Code

\_\_\_\_\_

Signature Authorized Chrysler Dealer

**126,000 Miles (210,000 km) or 126 Months Maintenance Service Schedule**

- Change the engine oil and engine oil filter.
- Rotate tires.

\_\_\_\_\_

Odometer Reading Date

\_\_\_\_\_

Repair Order # Dealer Code

\_\_\_\_\_

Signature Authorized Chrysler Dealer

**132,000 Miles (220,000 km) or  
132 Months Maintenance  
Service Schedule**

- Change the engine oil and engine oil filter.
- Rotate tires.
- If using your vehicle in dusty or off-road conditions, inspect the engine air cleaner filter, and replace if necessary.
- Inspect the brake linings, and replace as necessary.
- Replace the air conditioning filter (if equipped).

\_\_\_\_\_  
Odometer Reading Date

\_\_\_\_\_  
Repair Order # Dealer Code

\_\_\_\_\_  
Signature Authorized Chrysler Dealer

**138,000 Miles (230,000 km) or  
138 Months Maintenance  
Service Schedule**

- Change the engine oil and engine oil filter.
- Rotate tires.

\_\_\_\_\_  
Odometer Reading Date

\_\_\_\_\_  
Repair Order # Dealer Code

\_\_\_\_\_  
Signature Authorized Chrysler Dealer

**144,000 Miles (240,000 km) or 144 Months Maintenance Service Schedule**

- Change the engine oil and engine oil filter.
- Rotate tires.
- If using your vehicle in dusty or off-road conditions, inspect the engine air cleaner filter, and replace if necessary.
- Inspect the brake linings, and replace as necessary.
- Replace the air conditioning filter (if equipped).
- Inspect the CV joints.
- Inspect the exhaust system.
- Inspect the front suspension, tie rod ends and boot seals, and replace if necessary.

\_\_\_\_\_ Date

Odometer Reading

\_\_\_\_\_ Dealer Code

Repair Order #

\_\_\_\_\_

Signature Authorized Chrysler Dealer

**150,000 Miles (250,000 km) or 150 Months Maintenance Service Schedule**

- Change the engine oil and engine oil filter.
- Rotate tires.
- Replace the engine air cleaner filter.
- Replace the spark plugs (2.4L Engine except PZEV\*).**

\_\_\_\_\_ Date

Odometer Reading

\_\_\_\_\_ Dealer Code

Repair Order #

\_\_\_\_\_

Signature Authorized Chrysler Dealer



† This maintenance is recommended by the manufacturer to the owner, but is not required to maintain emissions warranty.

**WARNING!**

You can be badly injured working on or around a motor vehicle. Do only that service work for which you have the knowledge and the right equipment. If you have any doubt about your ability to perform a service job, take your vehicle to a competent mechanic.



# IF YOU NEED CONSUMER ASSISTANCE

## CONTENTS

---

■ Suggestions For Obtaining Service For Your Vehicle . . . . .	443	□ Customer Assistance For The Hearing Or Speech Impaired (TDD/TTY) . . . . .	445
□ Prepare For The Appointment . . . . .	443	□ Service Contract . . . . .	445
□ Prepare A List . . . . .	443	■ Warranty Information (U.S. Vehicles Only) . . . . .	446
□ Be Reasonable With Requests . . . . .	443	■ MOPAR® Parts . . . . .	446
■ If You Need Assistance . . . . .	443	■ Reporting Safety Defects . . . . .	446
□ Chrysler LLC Customer Center . . . . .	444	□ In The 50 United States And Washington, D.C. . . . .	446
□ Chrysler Canada Inc. Customer Center . . . . .	444	□ In Canada . . . . .	447
□ In Mexico Contact . . . . .	444		

442 IF YOU NEED CONSUMER ASSISTANCE

- Publication Order Forms . . . . . 447
- Department Of Transportation Uniform Tire Quality Grades . . . . . 448
  - Treadwear . . . . . 449

- Traction Grades . . . . . 449
- Temperature Grades . . . . . 450

## **SUGGESTIONS FOR OBTAINING SERVICE FOR YOUR VEHICLE**

### **Prepare For The Appointment**

If you're having warranty work done, be sure to have the right papers with you. Take your warranty folder. All work to be performed may not be covered by the warranty. Discuss additional charges with the service manager. Keep a maintenance log of your vehicle's service history. This can often provide a clue to the current problem.

### **Prepare A List**

Make a written list of your vehicle's problems or the specific work you want done. If you've had an accident or work done that is not on your maintenance log, let the service advisor know.

### **Be Reasonable With Requests**

If you list a number of items and you must have your vehicle by the end of the day, discuss the situation with

the service advisor and list the items in order of priority. At many authorized dealers, you may obtain a rental vehicle at a minimal daily charge. If you need a rental, it is advisable to make these arrangements when you call for an appointment.

### **IF YOU NEED ASSISTANCE**

The manufacturer and its authorized dealers are vitally interested in your satisfaction. We want you to be happy with our products and services.

Warranty service must be done by an authorized dealer. We strongly recommend that you take the vehicle to an authorized dealer. They know you and the vehicle best, and are most concerned that you get prompt and high quality service. The manufacturer's authorized dealers have the facilities, factory-trained technicians, special tools, and the latest information to ensure the vehicle is fixed correctly and in a timely manner.

This is why you should always talk to an authorized dealer's service manager first. Most matters can be resolved with this process.

- If for some reason you are still not satisfied, talk to the general manager or owner of the authorized dealership. They want to know if you need assistance.
- If an authorized dealership is unable to resolve the concern, you may contact the manufacturer's customer center.

Any communication to the manufacturer's customer center should include the following information:

- Owner's name and address
- Owner's telephone number (home and office)
- Authorized dealership name
- Vehicle Identification Number (VIN)
- Vehicle delivery date and mileage

**Chrysler LLC Customer Center**

P.O. Box 21-8004

Auburn Hills, MI 48321-8004

Phone: (800) 992-1997

**Chrysler Canada Inc. Customer Center**

P.O. Box 1621

Windsor, Ontario N9A 4H6

Phone: (800) 465-2001

**In Mexico contact:**

Av. Prolongacion Paseo de la Reforma, 1240

Sante Fe C.P. 05109

Mexico, D. F.

In Mexico City: 5081-7568

Outside Mexico City: 1-800-505-1300

**Customer Assistance For The Hearing Or Speech Impaired (TDD/TTY)**

To assist customers who have hearing difficulties, the manufacturer has installed special TDD (Telecommunication Devices for the Deaf) equipment at its customer center. Any hearing or speech impaired customer, who has access to a TDD or a conventional teletypewriter (TTY) in the United States, can communicate with the manufacturer by dialing 1-800-380-CHRY.

**Service Contract**

You may have purchased a service contract for a vehicle to help protect you from the high cost of unexpected repairs after the manufacturer's New Vehicle Limited Warranty expires. The manufacturer stands behind only the manufacturer's service contracts. If you purchased a manufacturer's service contract, you will receive Plan Provisions and an Owner Identification Card in the mail within three weeks of the vehicle delivery date. If you

have any questions about the service contract, call the manufacturer's Service Contract National Customer Hotline at 1-800-521-9922.

The manufacturer will not stand behind any service contract that is not the manufacturer's service contract. It is not responsible for any service contract other than the manufacturer's service contract. If you purchased a service contract that is not a manufacturer's service contract, and you require service after the manufacturer's New Vehicle Limited Warranty expires, please refer to the contract documents, and contact the person listed in those documents.

We appreciate that you have made a major investment when you purchased the vehicle. An authorized dealer has also made a major investment in facilities, tools, and training to assure that you are absolutely delighted with the ownership experience. You'll be pleased with their sincere efforts to resolve any warranty issues or related concerns.

**WARNING!**

Engine exhaust, some of its constituents, and certain vehicle components contain, or emit, chemicals known to the State of California to cause cancer and birth defects, or other reproductive harm. In addition, certain fluids contained in vehicles and certain products of component wear contain, or emit, chemicals known to the State of California to cause cancer and birth defects, or other reproductive harm.

**WARRANTY INFORMATION (U.S. Vehicles Only)**

See the Warranty Information Booklet for the terms and provisions of Chrysler Motors LLC warranties applicable to this vehicle.

**MOPAR® PARTS**

Mopar® fluids, lubricants, parts, and accessories are available from an authorized dealer. They will help keep the vehicle operating at its best.

**REPORTING SAFETY DEFECTS****In The 50 United States And Washington, D.C.**

If you believe that your vehicle has a defect that could cause a crash or cause injury or death, you should immediately inform the National Highway Traffic Safety Administration (NHTSA) in addition to notifying the manufacturer.

If NHTSA receives similar complaints, it may open an investigation, and if it finds that a safety defect exists in a group of vehicles, it may order a recall and remedy campaign. However, NHTSA cannot become involved in individual problems between you, your authorized dealer, and the manufacturer.



To contact NHTSA, you may either call the Auto Safety Hotline toll free at 1-888-327-4236 (TTY: 1-800-424-9153), or go to <http://www.safercar.gov>; or write to: Administrator, NHTSA, 400 Seventh Street, SW., Washington, D.C. 20590. You can also obtain other information about motor vehicle safety from <http://www.safercar.gov>.

### **In Canada**

If you believe that your vehicle has a safety defect, you should contact the Customer Service Department immediately. Canadian customers who wish to report a safety defect to the Canadian government should write to: Transport Canada, Motor Vehicle Defect Investigations and Recalls, 2780 Sheffield Road, Ottawa, Ontario K1B 3V9.

### **PUBLICATION ORDER FORMS**

To order the following manuals, you may use either the website or the phone numbers listed below. Visa, Mastercard, American Express, and Discover orders are accepted. If you prefer mailing your payment, please call for an order form.

**NOTE:** A street address is required when ordering manuals (no P.O. Boxes).

- *Service Manuals*

These comprehensive Service Manuals provide the information that students and professional technicians need in diagnosing/troubleshooting, problem solving, maintaining, servicing, and repairing Chrysler LLC vehicles. A complete working knowledge of the vehicle, system, and/or components is written in straightforward language with illustrations, diagrams, and charts.

- *Diagnostic Procedure Manuals*

Diagnostic Procedure Manuals are filled with diagrams, charts and detailed illustrations. These practical manuals make it easy for students and technicians to find and fix problems on computer-controlled vehicle systems and features. They show exactly how to find and correct problems the first time, using step-by-step troubleshooting and drivability procedures, proven diagnostic tests and a complete list of all tools and equipment.

- *Owner's Manuals*

These Owner's Manuals have been prepared with the assistance of service and engineering specialists to acquaint you with specific Chrysler LLC vehicles. Included are starting, operating, emergency and maintenance procedures as well as specifications, capabilities and safety tips.

*Call toll free at:*

- 1-800-890-4038 (U.S.)
- 1-800-387-1143 (Canada)

Or

*Visit us on the Worldwide Web at:*

- [www.techauthority.com](http://www.techauthority.com)

## **DEPARTMENT OF TRANSPORTATION UNIFORM TIRE QUALITY GRADES**

The following tire grading categories were established by the National Highway Traffic Safety Administration. The specific grade rating assigned by the tire's manufacturer in each category is shown on the sidewall of the tires on your vehicle.

All passenger car tires must conform to Federal safety requirements in addition to these grades.

### **Treadwear**

The Treadwear grade is a comparative rating, based on the wear rate of the tire when tested under controlled conditions on a specified government test course. For example, a tire graded 150 would wear one and one-half times as well on the government course as a tire graded 100. The relative performance of tires depends upon the actual conditions of their use, however, and may depart significantly from the norm due to variations in driving habits, service practices, and differences in road characteristics and climate.

### **Traction Grades**

The Traction grades, from highest to lowest, are AA, A, B, and C. These grades represent the tire's ability to stop on wet pavement, as measured under controlled conditions on specified government test surfaces of asphalt and concrete. A tire marked C may have poor traction performance.

#### **WARNING!**

**The traction grade assigned to this tire is based on straight-ahead braking traction tests, and does not include acceleration, cornering, hydroplaning, or peak traction characteristics.**

### Temperature Grades

The temperature grades are A (the highest), B, and C, representing the tire's resistance to the generation of heat and its ability to dissipate heat, when tested under controlled conditions on a specified indoor laboratory test wheel. Sustained high temperature can cause the material of the tire to degenerate and reduce tire life, and excessive temperature can lead to sudden tire failure. The grade C corresponds to a level of performance, which all passenger car tires must meet under the Federal Motor Vehicle Safety Standard No. 109. Grades B and A represent higher levels of performance on the laboratory test wheel, than the minimum required by law.

#### **WARNING!**

**The temperature grade for this tire is established for a tire that is properly inflated and not overloaded. Excessive speed, under-inflation, or excessive loading, either separately or in combination, can cause heat buildup and possible tire failure.**

---

# INDEX

- About Your Brakes . . . . . 282,285
- ABS (Anti-Lock Brake System) . . . . . 286,288
- Adding Engine Coolant (Antifreeze) . . . . . 390
- Adding Fuel . . . . . 333
- Adding Washer Fluid . . . . . 385
- Additives, Fuel . . . . . 328
- Air Cleaner, Engine (Engine Air Cleaner Filter) . . . 379
- Air Conditioner Maintenance . . . . . 381
- Air Conditioning . . . . . 249
- Air Conditioning Controls . . . . . 249
- Air Conditioning Filter . . . . . 260,382
- Air Conditioning, Operating Tips . . . . . 261
- Air Conditioning Refrigerant . . . . . 381,382
- Air Conditioning System . . . . . 249,253,381
- Air Pressure, Tires . . . . . 306
- Airbag . . . . . 53,62
- Airbag Deployment . . . . . 64
- Airbag Light . . . . . 54,61,66,82,178
- Airbag Maintenance . . . . . 65
- Airbag, Side . . . . . 56,61,62
- Airbag, Window (Side Curtain) . . . . . 57,61,62
- Alarm System (Security Alarm) . . . . . 19,178
- Alterations/Modifications, Vehicle . . . . . 7
- Antenna, Satellite Radio . . . . . 240
- Antifreeze (Engine Coolant) . . . . . 389,390,419
- Disposal . . . . . 392
- Anti-Lock Brake System (ABS) . . . . . 286,288
- Anti-Lock Warning Light . . . . . 286,287,288
- Anti-Theft Security Alarm (Theft Alarm) . . . . . 19
- Appearance Care . . . . . 398
- Ashtray . . . . . 160
- Assistance Towing . . . . . 105
- Auto Down Power Windows . . . . . 37
- Auto Unlock, Doors . . . . . 34
- Auto Up Power Windows . . . . . 38,156
- Automatic Dimming Mirror . . . . . 88
- Automatic Door Locks . . . . . 33,34
- Automatic Oil Change Indicator . . . . . 181,191,424

Automatic Temperature Control (ATC) . . . . .	253	Body Mechanism Lubrication . . . . .	384
Automatic Transaxle . . . . .	13,270,395	B-Pillar Location . . . . .	301
Adding Fluid . . . . .	396,397,422	Brake Assist System . . . . .	292
Filter . . . . .	397	Brake, Parking . . . . .	282
Fluid and Filter Changes . . . . .	397	Brake System . . . . .	285,394
Fluid Level Check . . . . .	396,397	Anti-Lock (ABS) . . . . .	286,288
Interlock System . . . . .	271,272	Fluid Check . . . . .	394,422
Reset Mode . . . . .	275	Master Cylinder . . . . .	394
Selection Of Lubricant . . . . .	422	Parking . . . . .	282
Shifting . . . . .	270	Warning Light . . . . .	183
Special Additives . . . . .	397	Brakes . . . . .	285,394
Autostick . . . . .	276	Brake/Transaxle Interlock . . . . .	271
Back-Up Lights . . . . .	415	Break-In Recommendations, New Vehicle . . . . .	80
Battery . . . . .	380	Bulb Replacement . . . . .	410,411
Gas Caution . . . . .	380	Bulbs, Light . . . . .	410
Jump Starting . . . . .	32	Calibration, Compass . . . . .	194
Keyless Transmitter Replacement (RKE) . . . . .	27	Capacities, Antifreeze (Engine Coolant) . . . . .	21
Location . . . . .	380	Capacities, Fluid . . . . .	419

- Caps, Filler  
  Fuel . . . . . 333  
  Oil (Engine) . . . . . 369,370,371,377,378  
  Power Steering . . . . . 282  
  Radiator (Coolant Pressure) . . . . . 391
- Car Washes . . . . . 399
- Carbon Monoxide Warning . . . . . 329
- Cargo Area Features . . . . . 164
- Cargo Compartment . . . . . 164
- Cargo Load Floor . . . . . 164
- Cargo (Vehicle Loading) . . . . . 164
- Caution, Exhaust Gas . . . . . 81
- Cellular Phone . . . . . 91,248
- Center High Mounted Stop Light . . . . . 418
- Chains, Tire . . . . . 314
- Changing A Flat Tire . . . . . 352
- Chart, Tire Sizing . . . . . 298
- Check Engine Light  
(Malfunction Indicator Light) . . . . . 373
- Child Restraint . . . . . 69,70,75,78
- Child Restraint Tether Anchors . . . . . 73,75
- Child Safety Locks . . . . . 35
- Cigar Lighter . . . . . 160
- Clean Air Gasoline . . . . . 326
- Cleaning  
  Wheels . . . . . 400  
  Windshield Wiper Blades . . . . . 384
- Climate Control . . . . . 249
- Clock . . . . . 199,201,216,219,228
- Coin Holder . . . . . 165
- Compact Disc (CD) Maintenance . . . . . 248
- Compact Spare Tire . . . . . 309
- Compass . . . . . 194
- Compass Calibration . . . . . 194
- Compass Variance . . . . . 195
- Computer, Trip/Travel . . . . . 21,192
- Console . . . . . 133,165
- Console, Floor . . . . . 133,165



Contract, Service . . . . .	445	Customer Programmable Features . . . . .	196
Coolant Pressure Cap (Radiator Cap) . . . . .	391	Data Recorder, Event . . . . .	67
Cooling System . . . . .	388	Dealer Service . . . . .	375
Adding Coolant (Antifreeze) . . . . .	390	Deck Lid, Power Release . . . . .	39
Coolant Capacity . . . . .	419	Defroster, Rear Window . . . . .	169
Coolant Level . . . . .	388,392	Defroster, Windshield . . . . .	82,251,257
Disposal of Used Coolant . . . . .	392	Delay (Intermittent) Wipers . . . . .	32,142
Drain, Flush, and Refill . . . . .	388	Diagnostic System, Onboard . . . . .	372
Inspection . . . . .	392	Dimmer Switch, Headlight . . . . .	140
Points to Remember . . . . .	392	Dipsticks	
Pressure Cap . . . . .	391	Automatic Transaxle . . . . .	396,397
Radiator Cap . . . . .	391	Oil (Engine) . . . . .	375
Selection of Coolant (Antifreeze) . . . . .	389,419,420	Power Steering . . . . .	282
Corrosion Protection . . . . .	398	Disabled Vehicle Towing . . . . .	364
Crankcase Ventilation Module . . . . .	21	Disposal	
Cruise Control (Speed Control) . . . . .	145	Antifreeze (Engine Coolant) . . . . .	392
Cruise Light . . . . .	182	Engine Oil . . . . .	378
Cupholders . . . . .	133,161,403	Door Locks, Automatic . . . . .	33
Customer Assistance . . . . .	443		

- Door Opener, Garage . . . . . 148
- Driving
- On Slippery Surfaces . . . . . 278
  - Through Flowing, Rising, or Shallow  
Standing Water . . . . . 279
- DVD Player (Video Entertainment System™) . . . . . 244
- E-85 Fuel . . . . . 330
- Electric Rear Window Defrost . . . . . 169
- Electric Remote Mirrors . . . . . 89
- Electrical Power Outlets . . . . . 158
- Electronic Speed Control (Cruise Control) . . . . . 145
- Electronic Stability Program (ESP) . . . . . 293
- Electronic Vehicle Information Center (EVIC) . . . . . 189
- Emergency, In Case of
- Jacking . . . . . 352
  - Jump Starting . . . . . 360
  - Towing . . . . . 364
- Emergency Trunk Release . . . . . 40,41
- Emission Control System Maintenance . . . . . 373,424
- Engine . . . . . 369,370,371
- Air Cleaner . . . . . 379
  - Block Heater . . . . . 269
  - Break-In Recommendations . . . . . 80
  - Checking Oil Level . . . . . 375
  - Coolant (Antifreeze) . . . . . 388,420
  - Cooling . . . . . 388
  - Exhaust Gas Caution . . . . . 329
  - Fuel Requirements . . . . . 325,419
  - Jump Starting . . . . . 360
  - Oil . . . . . 375,419,420
  - Oil Change Interval . . . . . 181,191,376,424
  - Oil Filler Cap . . . . . 369,370,371,377,378
  - Oil Filter . . . . . 379
  - Oil Filter Disposal . . . . . 378
  - Oil Selection . . . . . 377,419
  - Oil Synthetic . . . . . 378
  - Overheating . . . . . 350

- Temperature Gauge . . . . . 177
- Engine Oil Viscosity . . . . . 377,378
- Enhanced Accident Response Feature . . . . . 63
- Entry System, Illuminated . . . . . 21
- Ethanol . . . . . 326
- Event Data Recorder . . . . . 67
- Exhaust Gas Caution . . . . . 81,329,386
- Exhaust System . . . . . 385
- Extender, Seat Belt . . . . . 52
  
- Fabric Care . . . . . 401,402
- Filler Location Fuel . . . . . 177,333
- Filters
  - Air Cleaner . . . . . 379
  - Air Conditioning . . . . . 260,382
  - Automatic Transaxle . . . . . 397
  - Engine Oil . . . . . 379,420
  - Engine Oil Disposal . . . . . 378
- Flashers . . . . . 350
  
- Hazard Warning . . . . . 350
- Flash-To-Pass . . . . . 138
- Flat Tire Stowage . . . . . 359
- Flexible Fuel Vehicles . . . . . 330
  - Cruising Range . . . . . 333
  - Engine Oil . . . . . 332
  - Fuel Requirements . . . . . 330,331
  - Maintenance . . . . . 330,333
  - Replacement Parts . . . . . 333
  - Starting . . . . . 332
- Flooded Engine Starting . . . . . 268
- Floor Console . . . . . 165
- Fluid Capacities . . . . . 419
- Fluid Leaks . . . . . 82
- Fluid Level Checks
  - Automatic Transaxle . . . . . 396,397
  - Brake . . . . . 394,422
  - Cooling System . . . . . 388
  - Engine Oil . . . . . 375

- Power Steering . . . . . 282,422
- Fluids . . . . . 420
- Fluids, Lubricants and Genuine Parts . . . . . 420
- Fog Light Service . . . . . 413
- Fog Lights . . . . . 138,185,413
- Folding Rear Seat . . . . . 132,133
- Freeing A Stuck Vehicle . . . . . 363
- Fuel . . . . . 325
  - Adding . . . . . 333
  - Additives . . . . . 328
  - Clean Air . . . . . 326
  - Ethanol . . . . . 326
  - Filler Cap (Gas Cap) . . . . . 177,333
  - Filler Door (Gas Cap) . . . . . 177
  - Gasoline . . . . . 325
  - Gauge . . . . . 177
  - Light . . . . . 178
  - Materials Added . . . . . 328
  - Methanol . . . . . 326
  - Octane Rating . . . . . 325,420
  - Requirements . . . . . 325,419
  - Tank Capacity . . . . . 419
- Fuel, Flexible . . . . . *See Flexible Fuel Vehicles*
- Fuel System Caution . . . . . 335
- Fueling . . . . . 333
- Fuses . . . . . 404
- Garage Door Opener (HomeLink®) . . . . . 148
- Gas Cap (Fuel Filler Cap) . . . . . 333,336,372
- Gasoline, Clean Air . . . . . 326
- Gasoline (Fuel) . . . . . 325
- Gasoline, Reformulated . . . . . 326
- Gauges
  - Coolant Temperature . . . . . 177
  - Fuel . . . . . 177
  - Odometer . . . . . 180
  - Tachometer . . . . . 179
- Gear Ranges . . . . . 273

Gearshift . . . . .	273	On With Wipers . . . . .	143
General Information . . . . .	18,119,324	Passing . . . . .	138
General Maintenance . . . . .	375	Replacing . . . . .	411
Glass Cleaning . . . . .	402	Switch . . . . .	136
Gross Axle Weight Rating . . . . .	337,339	Heated Seats . . . . .	130
Gross Vehicle Weight Rating . . . . .	337,339	Heater . . . . .	249
GVWR . . . . .	337	Heater, Engine Block . . . . .	269
		Hitches	
Hands-Free Phone (UConnect®) . . . . .	91	Trailer Towing . . . . .	340
Hazard		HomeLink® (Garage Door Opener) Transmitter . . .	148
Driving Through Flowing, Rising, or Shallow		Hood Prop . . . . .	134
Standing Water . . . . .	279	Hood Release . . . . .	133
Hazard Warning Flasher . . . . .	350		
Head Restraints . . . . .	129	Ignition . . . . .	13
Headlights . . . . .	411	Key . . . . .	12,13
Bulb Replacement . . . . .	411	Lock . . . . .	13
Cleaning . . . . .	400	Ignition Key Removal . . . . .	13
High Beam . . . . .	140,188	Illuminated Entry . . . . .	21
High Beam/Low Beam Select Switch . . . . .	140	Immobilizer (Sentry Key) . . . . .	15

- Infant Restraint . . . . . 69,70  
Information Center, Vehicle . . . . . 189  
Inside Rearview Mirror . . . . . 87  
Instrument Cluster . . . . . 175,176,177  
Instrument Panel and Controls . . . . . 174  
Instrument Panel Cover . . . . . 401  
Instrument Panel Lens Cleaning . . . . . 403  
Integrated Power Module (Fuses) . . . . . 404  
Interior Appearance Care . . . . . 401  
Interior Lights . . . . . 135  
Intermittent Wipers (Delay Wipers) . . . . . 142  
Introduction . . . . . 4
- Jack Location . . . . . 353  
Jack Operation . . . . . 352,355  
Jacking Instructions . . . . . 355  
Jump Starting . . . . . 360
- Key, Programming . . . . . 17  
Key, Replacement . . . . . 17  
Key, Sentry (Immobilizer) . . . . . 15  
Key-In Reminder . . . . . 15  
Keyless Entry System . . . . . 21  
Keyless Entry System (Sedan) . . . . . 21  
Keys . . . . . 12  
Knee Bolster . . . . . 53,54
- Lane Change and Turn Signals . . . . . 185  
Lap/Shoulder Belts . . . . . 44  
LATCH (Lower Anchors and Tether  
for CHildren) . . . . . 75  
Latches  
    Hood . . . . . 133  
Lead Free Gasoline . . . . . 325  
Life of Tires . . . . . 312  
Light Bulbs . . . . . 410  
Lights . . . . . 82,135  
    Airbag . . . . . 54,66,82,178

- Anti-Lock . . . . . 287
- Back-Up . . . . . 415
- Brake Warning . . . . . 183
- Bulb Replacement . . . . . 411
- Center Mounted Stop . . . . . 418
- Daytime Running . . . . . 138
- Electronic Stability Program (ESP) Indicator . . . 293
- Engine Temperature Warning . . . . . 179
- Fog . . . . . 138,185,413
- Headlight Switch . . . . . 136
- Headlights . . . . . 136
- Headlights On With Wipers . . . . . 143
- High Beam Indicator . . . . . 188
- Illuminated Entry . . . . . 21
- Instrument Cluster . . . . . 136
- Interior . . . . . 135
- License . . . . . 418
- Lights On Reminder . . . . . 138
- Low Fuel . . . . . 178
- Malfunction Indicator (Check Engine) . . . . . 188
- Map Reading . . . . . 135
- Oil Pressure . . . . . 179
- Passing . . . . . 138
- Rear Tail . . . . . 415
- Seat Belt Reminder . . . . . 179
- Security Alarm (Theft Alarm) . . . . . 19
- Theft Alarm (Security Alarm) . . . . . 178
- Tire Pressure Monitoring (TPMS) . . . . . 186,316
- Traction Control . . . . . 293
- Turn Signal . . . . . 139,185,413,415
- Voltage . . . . . 178
- Warning (Instrument Cluster Description) . . . . . 177
- Loading Vehicle . . . . . 336,338
  - Capacities . . . . . 338
  - Tires . . . . . 301
- Locks
  - Auto Unlock . . . . . 34
  - Child Protection . . . . . 35

- Power Door . . . . . 33
- Low Tire Pressure System . . . . . 316
- Lower Anchors and Tether for CHildren  
(LATCH) . . . . . 75
- Lubrication, Body . . . . . 384
- Lumbar Support . . . . . 128
- Maintenance Free Battery . . . . . 380
- Maintenance, General . . . . . 375
- Maintenance Procedures . . . . . 375
- Maintenance Schedule . . . . . 424
- Malfunction Indicator Light  
(Check Engine) . . . . . 188,373
- Manual, Service . . . . . 447
- Map/Reading Lights . . . . . 135
- Master Cylinder (Brakes) . . . . . 394
- Methanol . . . . . 326
- Mini-Trip Computer . . . . . 192
- Mirrors . . . . . 87
- Automatic Dimming . . . . . 88
- Electric Powered . . . . . 89
- Outside . . . . . 90
- Rearview . . . . . 87
- Vanity . . . . . 90
- Modifications/Alterations, Vehicle . . . . . 7
- Monitor, Tire Pressure System . . . . . 316
- Mopar Parts . . . . . 374,446
- MTBE/ETBE . . . . . 326
- New Vehicle Break-In Period . . . . . 80
- Occupant Restraints . . . . . 61,64
- Occupant Restraints (Sedan) . . . . . 42,56,57,61,62
- Octane Rating, Gasoline (Fuel) . . . . . 325
- Odometer . . . . . 180
- Trip . . . . . 180,182
- Oil Change Indicator . . . . . 181,191,424



- Oil Change Indicator, Reset . . . . . 181,191
- Oil, Engine . . . . . 375,420
  - Capacity . . . . . 419
  - Change Interval . . . . . 181,191,376,424
  - Checking . . . . . 375
  - Dipstick . . . . . 375
  - Disposal . . . . . 378
  - Filter . . . . . 379,420
  - Filter Disposal . . . . . 378
  - Identification Logo . . . . . 377
  - Materials Added to . . . . . 378
  - Recommendation . . . . . 377,419
  - Synthetic . . . . . 378
  - Viscosity . . . . . 377,378,419
- Oil Filter, Change . . . . . 379
- Oil Filter, Selection . . . . . 379
- Oil Pressure Light . . . . . 179
- Onboard Diagnostic System . . . . . 372,373
- Opener, Garage Door (HomeLink®) . . . . . 148
- Operator Manual (Owner's Manual) . . . . . 4
- Overdrive . . . . . 274
- Overheating, Engine . . . . . 350
- Owner's Manual (Operator Manual) . . . . . 4,447
- Paint Care . . . . . 398
- Panic Alarm . . . . . 26
- Parking Brake . . . . . 282
- Parking On Hill . . . . . 283
- Passing Light . . . . . 138
- Personal Settings . . . . . 196
- Pets . . . . . 80
- Phone, Cellular . . . . . 91
- Phone, Hands-Free (UConnect®) . . . . . 91
- Placard, Tire and Loading Information . . . . . 301
- Power
  - Brakes . . . . . 285
  - Deck Lid Release . . . . . 39
  - Door Locks . . . . . 33

Mirrors	89	Rear Cupholder	162
Outlet (Auxiliary Electrical Outlet)	158	Rear Seat, Folding	132,133
Seats	128	Rear Window Defroster	169
Steering	281,282	Rear Window Features	169
Sunroof	155	Rearview Mirrors	87
Windows	36	Recorder, Event Data	67
Pregnant Women and Seat Belts	52	Recreational Towing	348
Preparation for Jacking	354	Reformulated Gasoline	326
Pretensioners		Refrigerant	382
Seat Belts	50	Reminder, Seat Belt	50,51
Programmable Electronic Features	196	Remote Control	
Programming Transmitters		Door Locks	21
(Remote Keyless Entry)	26	Security Alarm	19
Radial Ply Tires	308	Remote Keyless Entry (RKE)	21
Radiator Cap (Coolant Pressure Cap)	391	Remote Keyless Entry (Sedan)	21
Radio Operation	248	Remote Sound System (Radio) Controls	246
Radio Remote Controls	246	Remote Starting System	29
Radio, Satellite	239	Remote Trunk Release	39
		Replacement Bulbs	410

Replacement Keys . . . . .	17	Seat Belt Maintenance . . . . .	403
Replacement Parts . . . . .	374	Seat Belt Reminder . . . . .	50,51
Replacement Tires . . . . .	312	Seat Belts	
Reporting Safety Defects . . . . .	446	Adjustable Shoulder Belt . . . . .	49
Resetting Oil Change Indicator . . . . .	181,191	Adjustable Upper Shoulder Anchorage . . . . .	49
Restraint, Head . . . . .	129	And Pregnant Women . . . . .	52
Restraints, Child . . . . .	69	Child Restraint . . . . .	69,78
Restraints, Infant . . . . .	70	Extender . . . . .	52
Reverse Lights . . . . .	415	Front Seat . . . . .	44,45
Rotation, Tires . . . . .	315	Operating Instructions . . . . .	45
		Pretensioners . . . . .	50
Safety Checks Inside Vehicle . . . . .	81	Rear Seat . . . . .	44
Safety Checks Outside Vehicle . . . . .	82	Reminder . . . . .	179
Safety Defects, Reporting . . . . .	446	Untwisting Procedure . . . . .	49
Safety Information, Tire . . . . .	296	Seat Belts (Sedan) . . . . .	42
Safety Tips . . . . .	81	Seats . . . . .	125
Satellite Radio . . . . .	239	Adjustment . . . . .	125
Satellite Radio Antenna . . . . .	240	Cleaning . . . . .	133,402
Schedule, Maintenance . . . . .	424	Head Restraints . . . . .	129

- Heated . . . . . 130
- Lumbar Support . . . . . 128
- Power . . . . . 128
- Rear Folding . . . . . 132,133
- Rear Folding (Sedan) . . . . . 164
- Reclining . . . . . 127
- Security Alarm (Theft Alarm) . . . . . 19
- Selection of Coolant (Antifreeze) . . . . . 389,420
- Selection of Oil . . . . . 377
- Sentry Key (Immobilizer) . . . . . 15
- Sentry Key Programming . . . . . 17
- Service Assistance . . . . . 443
- Service Contract . . . . . 445
- Service Manuals . . . . . 447
- Setting the Clock . . . . . 199,201,216,219,228
- Settings, Personal . . . . . 196
- Shifting
  - Automatic Transaxle . . . . . 270
- Shoulder Belts . . . . . 44
- Side Window Demisters (Defrosters) . . . . . 260
- Signals, Turn . . . . . 415
- Slippery Surfaces, Driving On . . . . . 278
- Snow Chains (Tire Chains) . . . . . 314
- Snow Tires . . . . . 314
- Spare Tire . . . . . 309,310,353
- Specifications
  - Oil . . . . . 377
- Speed Control (Cruise Control) . . . . . 145,182
- Speedometer . . . . . 177
- Starting . . . . . 267
  - Engine Fails to Start . . . . . 268
- Starting Procedures . . . . . 267
- Steering
  - Power . . . . . 281,282
  - Tilt Column . . . . . 144
  - Wheel, Tilt . . . . . 144
- Steering Wheel Mounted Sound System
  - Controls . . . . . 246

Storage	163,410	Tire Identification Number (TIN)	300
Storage, Vehicle	259	Tire Markings	296
Stuck, Freeing	363	Tire Safety Information	296
Sun Roof	155	Tires	82,305,448
Supplemental Restraint System - Airbag	53	Aging (Life of Tires)	312
Synthetic Engine Oil	378	Air Pressure	305
		Chains	314
Tachometer	179	Changing	352
Taillights	415	Compact Spare	309
Telescoping Steering Column	144	Flat Changing	359
Temperature Control, Automatic (ATC)	253	General Information	305
Temperature Gauge, Engine Coolant	177,351	High Speed	308
Tether Anchor, Child Restraint	73	Inflation Pressures	306
Theft Alarm (Security Alarm)	19	Jacking	352
Theft System (Security Alarm)	19	Life of Tires	312
Tilt Steering Column	144	Load Capacity	301
Time Delay, Headlight	137	Pressure Monitor System (TPMS)	316
Tip Start	268	Pressure Warning Light	186
Tire and Loading Information Placard	301	Quality Grading	448

Radial	308	Hitches	340
Replacement	312	Minimum Requirements	343
Rotation	315	Trailer and Tongue Weight	342
Safety	296,305	Trailer Towing Guide	341
Sizes	298	Trailer Weight	341
Snow Tires	314	Transaxle	
Spare Tire	353	Additives	397
Spinning	311	Automatic	13,270,395
Tread Wear Indicators	311	Autostick	276
Tongue Weight/Trailer Weight	342	Filter	397
Towing	338	Maintenance	395
24-Hour Towing Assistance	105	Operation	270
Disabled Vehicle	364	Overdrive	274
Guide	341	Selection of Lubricant	422
Recreational	348	Transmission	<i>See Transaxle</i>
Weight	341	Transmitter Battery Service	
Towing Assistance	105	(Remote Keyless Entry)	27
Trailer Towing	338	Transmitter, Garage Door Opener	
Cooling System Tips	348	(HomeLink®)	148

- Transmitter Programming  
(Remote Keyless Entry) . . . . . 26
- Transporting Pets . . . . . 80
- Tread Wear Indicators . . . . . 311
- Trip Odometer . . . . . 180
- Trip Odometer Reset Button . . . . . 182
- Trunk Lid (Deck Lid) . . . . . 39
- Trunk Release, Emergency . . . . . 40,41
- Trunk Release Remote Control . . . . . 39
- Turn Signals . . . . . 139,185,415
- UConnect® (Hands-Free Phone) . . . . . 91
- Understanding Your Instrument Panel . . . . . 174
- Uniform Tire Quality Grades . . . . . 448
- Universal Transmitter . . . . . 148
- Unleaded Gasoline . . . . . 325
- Untwisting Procedure, Seat Belt . . . . . 49
- Upholstery Care . . . . . 401
- Vanity Mirrors . . . . . 90
- Variance, Compass . . . . . 195
- Vehicle Certification Label . . . . . 336
- Vehicle Identification Number (VIN) . . . . . 6
- Vehicle Loading . . . . . 301,336,338
- Vehicle Modifications/Alterations . . . . . 7
- Vehicle Storage . . . . . 259,410
- Vehicle Theft Alarm (Security Alarm) . . . . . 19
- Video Entertainment System™  
(Rear Seat Video System) . . . . . 244
- Viscosity, Engine Oil . . . . . 377,378
- Voice Recognition System (VR) . . . . . 119
- Warning Lights (Instrument Cluster  
Description) . . . . . 177
- Warnings and Cautions . . . . . 6
- Warranty Information . . . . . 446
- Washer, Adding Fluid . . . . . 385
- Washers, Windshield . . . . . 141,144,385

Washing Vehicle . . . . .	399	Windshield Defroster . . . . .	251,257
Water		Windshield Washers . . . . .	141,144
Driving Through . . . . .	279	Fluid . . . . .	385
Wheel and Wheel Trim . . . . .	400	Windshield Wiper Blades . . . . .	384
Wheel and Wheel Trim Care . . . . .	400	Windshield Wipers . . . . .	141
Wind Buffeting . . . . .	39,157	Wiper Blade Replacement . . . . .	384,385
Window Fogging . . . . .	260	Wipers, Intermittent . . . . .	142
Windows . . . . .	36		
Power . . . . .	36	YES Essentials® Fabric Cleaning Procedure . . . . .	402



## **INSTALLATION OF RADIO TRANSMITTING EQUIPMENT**

Special design considerations are incorporated into this vehicle's electronic system to provide immunity to radio frequency signals. Mobile two-way radios and telephone equipment must be installed properly by trained personnel. The following must be observed during installation.

The positive power connection should be made directly to the battery and fused as close to the battery as possible. The negative power connection should be made to body sheet metal adjacent to the negative battery connection. This connection should not be fused.

Antennas for two-way radios should be mounted on the roof or the rear area of the vehicle. Care should be used in mounting antennas with magnet bases. Magnets may affect the accuracy or operation of the compass on vehicles so equipped.

The antenna cable should be as short as practical and routed away from the vehicle wiring when possible. Use only fully shielded coaxial cable.

Carefully match the antenna and cable to the radio to ensure a low Standing Wave Ratio (SWR).

Mobile radio equipment with output power greater than normal may require special precautions.

All installations should be checked for possible interference between the communications equipment and the vehicle's electronic systems.



Chrysler LLC  
81-026-0904



First Edition

Printed in U.S.A.