

TABLE OF CONTENTS

SECTION		PAGE
1	INTRODUCTION	3
2	THINGS TO KNOW BEFORE STARTING YOUR VEHICLE	9
3	UNDERSTANDING THE FEATURES OF YOUR VEHICLE	63
4	UNDERSTANDING YOUR INSTRUMENT PANEL	137
5	STARTING AND OPERATING	205
6	WHAT TO DO IN EMERGENCIES	273
7	MAINTAINING YOUR VEHICLE	289
8	MAINTENANCE SCHEDULES	349
9	IF YOU NEED CONSUMER ASSISTANCE	365
10	INDEX	373

INTRODUCTION

CONTENTS

■ Introduction	4	■ Vehicle Identification Number	6
■ How To Use This Manual	4	■ Vehicle Modifications / Alterations	7
■ Warnings And Cautions	6		

4 INTRODUCTION

INTRODUCTION

This manual has been prepared with the assistance of service and engineering specialists to acquaint you with the operation and maintenance of your new vehicle. It is supplemented by a Warranty Information Booklet and various customer oriented documents. You are urged to read these publications carefully. Following the instructions and recommendations in this manual will help assure safe and enjoyable operation of your vehicle.

NOTE: After you read the manual, it should be stored in the vehicle for convenient reference and remain with the vehicle when sold, so that the new owner will be aware of all safety warnings.

When it comes to service, remember that your dealer knows your vehicle best, has the factory-trained technicians and genuine Mopar® parts, and is interested in your satisfaction.

WARNING!







































































Engine exhaust, some of its constituents, and certain vehicle components contain or emit chemicals known to the State of California to cause cancer and birth defects or other reproductive harm. In addition, certain fluids contained in vehicles and certain products of component wear contain or emit chemicals known to the State of California to cause cancer and birth defects or other reproductive harm.

HOW TO USE THIS MANUAL

Consult the table of contents to determine which section contains the information you desire.

The detailed index, at the rear of this manual, contains a complete listing of all subjects.

Consult the following table for a description of the symbols that may be used on your vehicle or throughout this owner's manual:

									
TURN SIGNALS	REAR WINDOW WIPER	WINDSHIELD WIPER INTERMITTENT	SRS AIRBAG SUPPLEMENTAL RESTRAINT SYSTEM	HIGH BEAM	HORN	UPPER AIR OUTLET	HEATED SEAT LOW	DOOR LOCK	ADJUSTABLE PEDALS
									
FUEL	REAR WINDOW INTERMITTENT WIPER	WINDSHIELD WASHER	FAILURE OF ANTI-LOCK BRAKING SYSTEM	LOW BEAM	KEY ACTIVATE (POWER OUTLET)	UPPER AND LOWER AIR OUTLET	HEATED SEAT HIGH	WINDOW LIFT	TIRE PRESSURE MONITOR
									
FUEL FILL SIDE	REAR WINDOW WASHER	WINDSHIELD WASHER FLUID LEVEL	SEAT BELT	FRONT FOG LIGHT	HOOD RELEASE	LOWER AIR OUTLET	RECIRCULATION	CONVERTIBLE 4 WINDOW DOWN	VOICE RECOGNITION BUTTON
									
ENGINE OIL	REAR WINDOW DEFROST	WINDSHIELD, ELECTRICALLY HEATED	AIRBAG	EXTERIOR BULB FAILURE	LIFTGATE RELEASE AND LIFTGATE OPEN	DEFROST AND LOWER AIR OUTLET	VENTILATING FAN	POWER STEERING FLUID	UCONNECT™ BUTTON
									
BATTERY CHARGING	HEATED MIRROR	WINDSHIELD DEFROST	SIDE AIRBAG	DOME LIGHT	SLIDING DOOR	TRUNK / DECK RELEASE	AIR CONDITIONING	SEE OWNER'S MANUAL ISO	TRACTION CONTROL
									
ENGINE COOLANT TEMPERATURE	CHILD SEAT TETHER ANCHOR	WINDSHIELD WIPER AND WASHER	HAZARD	PARK LIGHTS	SLIDING DOOR	CONVERTIBLE TOP UP	EMERGENCY RELEASE HANDLE	INSTRUMENT PANEL ILLUMINATION	WARNING
									
MALFUNCTION INDICATOR LIGHT	LOWER ANCHORS AND TETHER FOR CHILDREN (LATCH)	ELECTRONIC SPEED CONTROL	WINDOW LOCK	LIGHTER	DOOR AJAR	CONVERTIBLE TOP DOWN	PASSENGER AIRBAG OFF	MASTER LIGHTING SWITCH	ESP BAS ELECTRONIC STABILITY PROGRAM / BRAKE ASSIST SYSTEM

WARNINGS AND CAUTIONS

This manual contains **WARNINGS** against operating procedures which could result in an accident or bodily injury. It also contains **CAUTIONS** against procedures which could result in damage to your vehicle. If you do not read this entire manual you may miss important information. Observe all Warnings and Cautions.

VEHICLE IDENTIFICATION NUMBER

The vehicle identification number (VIN) is located near the left front corner of the windshield. The VIN is visible from outside of the vehicle through the windshield. This number also appears on the Automobile Information Disclosure Label affixed to a window on your vehicle. Save this label for a convenient record of your vehicle identification number and optional equipment.

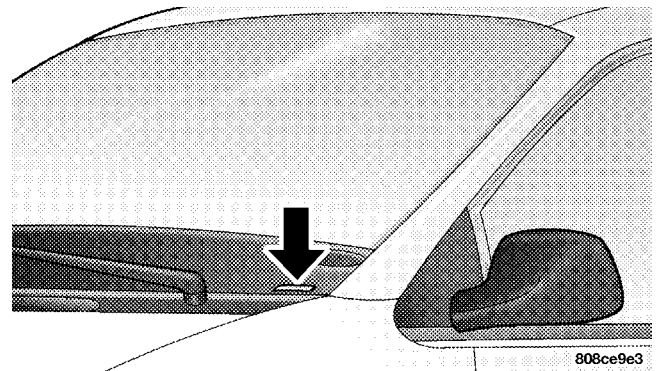

VIN LOCATION

NOTE: It is illegal to remove the VIN plate.

VEHICLE MODIFICATIONS / ALTERATIONS**WARNING!**

Any modifications or alterations to this vehicle could seriously affect its roadworthiness and safety and may lead to an accident resulting in serious injury or death.

THINGS TO KNOW BEFORE STARTING YOUR VEHICLE

CONTENTS

■ A Word About Your Keys	11	□ Power Door Locks	16
□ Ignition Key Removal	11	□ Child Protection Door Lock	19
□ Key-In-Ignition Reminder	12	■ Remote Keyless Entry	20
□ Horn	12	□ To Unlock The Doors	21
■ Sentry Key	12	□ To Lock The Doors	22
□ Replacement Keys	13	□ To Unlatch The Trunk	22
□ Customer Key Programming	14	□ Using The Panic Alarm	22
□ General Information	15	□ General Information	23
■ Illuminated Entry System	15	□ Transmitter Battery Service	24
■ Door Locks	15	■ Vehicle Theft Alarm — If Equipped	25
□ Manual Door Locks	15	■ Windows	26

10 THINGS TO KNOW BEFORE STARTING YOUR VEHICLE

□ Power Windows26	□ Seat Belt Extender38
■ Trunk Lock And Release29	□ Driver And Right Front Passenger Supplemental Restraint System (SRS) - Airbag39
■ Trunk Safety Warning30	■ Engine Break-In Recommendations60
□ Trunk Emergency Release31	■ Safety Tips60
■ Occupant Restraints31	□ Exhaust Gas60
□ Lap/Shoulder Belts32	□ Safety Checks You Should Make Inside The Vehicle61
□ Seat Belt Pretensioners36	□ Periodic Safety Checks You Should Make Outside The Vehicle61
□ Enhanced Seat Belt Reminder System (BeltAlert)37		
□ Seat Belts And Pregnant Women38		

A WORD ABOUT YOUR KEYS

You can insert the double sided keys into the locks with either side up.

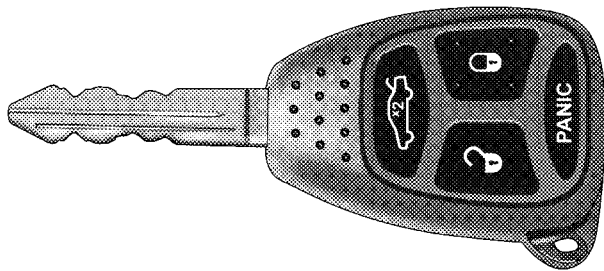

815afa1a

Vehicle Key

The dealer that sold you your new vehicle has the key code numbers for your vehicle locks. These numbers can be used to order duplicate keys from your dealer. Ask your dealer for these numbers and keep them in a safe place.

Ignition Key Removal

The shift lever must be in PARK. Turn the key to the LOCK position, then remove the key.

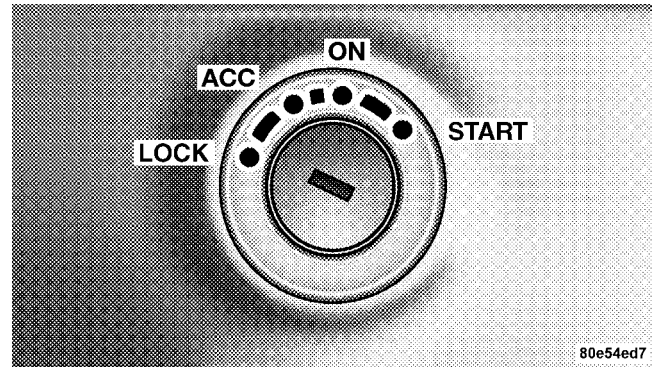

80e54ed7

Ignition Key Positions

NOTE: The power window switches, radio, power sunroof (if equipped), and power outlets will remain active for 10 minutes after the ignition switch has been turned off. Opening either front door will cancel this feature. The time is programmable through the electronic

12 THINGS TO KNOW BEFORE STARTING YOUR VEHICLE

vehicle information center (EVIC) — if equipped. Refer to Personal Settings in the Electronic Vehicle Information Center (EVIC) Section for details.

WARNING!

Leaving children in a vehicle unattended is dangerous for a number of reasons. A child or others could be injured. Children should be warned not to touch the parking brake, brake pedal or the gear selector lever. Don't leave the keys in the ignition. A child could operate power windows, other controls, or move the vehicle.

CAUTION!

An unlocked car is an invitation to thieves. Always remove key from the ignition and lock all doors when leaving the vehicle unattended.

Key-In-Ignition Reminder

If you open the driver's door and the key is in the ignition switch, a chime will sound to remind you to remove the key.

NOTE: The Key-In-Ignition reminder only sounds when the ignition key is placed in the LOCK or ACC positions.

Horn

Turn the ignition key to the ACC or ON position to operate the horn.

SENTRY KEY

The Sentry Key Immobilizer System prevents unauthorized operation of the vehicle by disabling the engine. The system will shut the engine off after 2 seconds of running if an invalid key is used to start the vehicle. This system utilizes ignition keys which have an electronic chip (transponder) embedded into them. Only keys that have been programmed to the vehicle can be used to start and operate the vehicle.

The Sentry Key Immobilizer System does not need to be armed or activated. Operation of the system is automatic regardless of whether or not the vehicle is locked or unlocked.

During normal operation, the Vehicle Theft Alarm Indicator Light will come on for three (3) seconds immediately after the ignition switch is turned on for a bulb check. Afterwards, if the bulb remains on, this indicates a problem with the electronics.

If the bulb begins to flash after the bulb check, this indicates that an invalid key has been used to start the vehicle. Both of these conditions will result in the engine being shut off after two (2) seconds of running. Keep in mind that a key which has not been programmed is also considered an invalid key even if it is cut to fit the ignition lock cylinder for that vehicle.

If the Vehicle Theft Alarm Indicator Light comes on during normal vehicle operation (vehicle has been running for longer than 10 seconds), a fault has been detected in the electronics and the vehicle should be serviced as soon as possible.

NOTE:

- The Sentry Key Immobilizer System is not compatible with remote starting systems. Use of these systems may result in vehicle starting problems and loss of security protection.
- Exxon/Mobil Speed Pass,TM additional Sentry Keys, or any other transponder equipped components on the same keychain will **not** cause a key-related (transponder) fault unless the additional part is **physically held against the ignition key** being used when starting the vehicle. Cell phones, pagers, or other RF electronics will not cause interference with this system.

All of the keys provided with your new vehicle have been programmed to the vehicle electronics.

Replacement Keys

NOTE: Only keys that have been programmed to the vehicle electronics can be used to start the vehicle. Once a Sentry Key has been programmed to a vehicle, it cannot be programmed to any other vehicle.

14 THINGS TO KNOW BEFORE STARTING YOUR VEHICLE

At the time of purchase, the original owner is provided with a four digit PIN number. This number is required for dealer replacement of keys. Duplication of keys may be performed at an authorized dealer or by using the Customer Key Programming procedure. This procedure consists of programming a blank key to the vehicle electronics. A blank key is one which has never been programmed.

NOTE: When having the Sentry Key Immobilizer System serviced, bring all vehicle keys with you to the dealer.

Customer Key Programming

You can program new sentry keys to the system if you have two valid sentry keys by performing the following procedure:

1. Cut the additional Sentry Key Transponder blank(s) to match the ignition switch lock cylinder key code.
2. Insert the first valid key into the ignition switch and turn the ignition switch ON for at least 3 seconds but no longer than 15 seconds. Turn the ignition switch OFF and remove the first key.

3. Insert the second valid key and turn the ignition switch ON within 15 seconds. After ten seconds a chime will sound and the Vehicle Theft Alarm Indicator Light will begin to flash. Turn the ignition switch OFF and remove the second key.

4. Insert a blank Sentry Key into the ignition switch and turn the ignition switch ON within 60 seconds. After 10 seconds a single chime will sound and the Vehicle Theft Alarm Indicator Light will stop flashing, turn on again for 3 seconds, and then turn off.

The new Sentry Key has been programmed. The Keyless Entry Transmitter will also be programmed during this procedure.

Repeat this procedure to program up to a total of 8 keys. If you do not have a programmed sentry key, contact your dealer for details.

NOTE: If a programmed key has been lost, see your dealer to have all remaining keys erased from the systems memory. This will prevent the lost key from starting your vehicle. The remaining keys must then be reprogrammed. All vehicle keys must be taken to the dealer at the time of service to be reprogrammed.

General Information

The Sentry Key system complies with FCC rules part 15 and with RSS-210 of Industry Canada. Operation is subject to the following conditions:

- This device may not cause harmful interference.
- This device must accept any interference that may be received, including interference that may cause undesired operation.

ILLUMINATED ENTRY SYSTEM

The courtesy lights will turn on when you use the keyless entry transmitter or open the doors.

The lights will fade to off after about 30 seconds or they will immediately fade to off once the ignition switch is turned ON from the LOCK position.

NOTE:

- None of the courtesy lights will operate if the dimmer control is in the “defeat” position (extreme downward position).

DOOR LOCKS**Manual Door Locks**

Lock the doors by pushing down on the door lock plunger on each door trim panel.

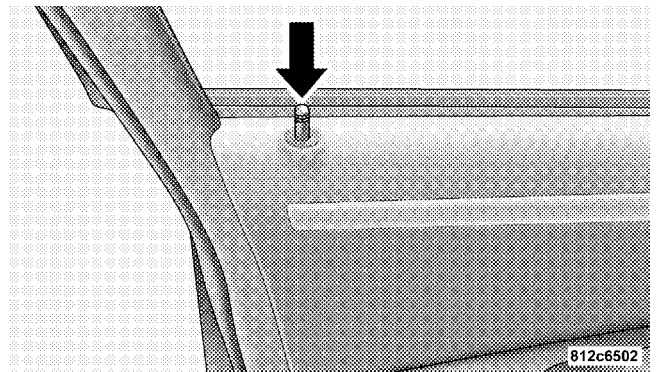
2

Door Lock Plunger

If the door lock plunger is down when you shut the door, the door will lock. Therefore, make sure the keys are not inside the vehicle before closing the door.

WARNING!

- For personal security and safety in the event of an accident, lock the vehicle doors as you drive as well as when you park and leave the vehicle.
- When leaving the vehicle always remove the key from the ignition lock, and lock your vehicle. Do not leave children unattended in the vehicle, or with access to an unlocked vehicle. Unsupervised use of vehicle equipment may cause severe personal injuries and death.

Power Door Locks

A power door lock switch is on each front door trim panel. Use this switch to lock or unlock the doors.

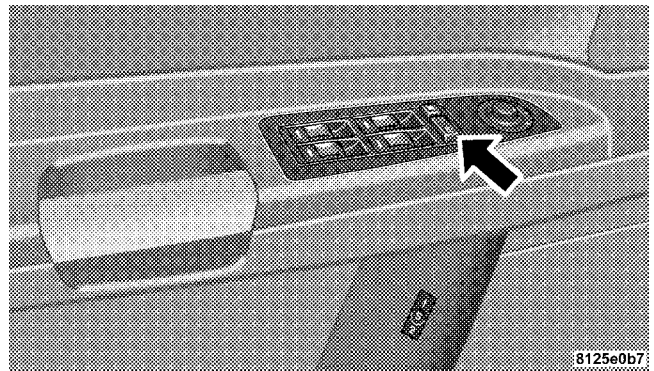

Power Door Lock Switch

If you press the power door lock switch while the key is in the ignition, and any front door is open, the power locks will not operate. This prevents you from accidentally locking your keys in the vehicle. Removing the key or closing the door will allow the locks to operate. A chime will sound if the key is in the LOCK or ACC position and a door is open, as a reminder to remove the key.

Automatic Door Locks

The doors will lock automatically on vehicles with power door locks if all of the following conditions are met:

1. The Auto Lock feature is enabled.
2. The transmission is in gear.
3. All doors are closed.
4. The throttle is pressed.
5. The vehicle speed is above 15 mph (24 km/h).
6. The doors were not previously locked using the power door lock switch or remote keyless entry transmitter.

The Automatic Door Lock feature can be enabled or disabled. Refer to “Personal Settings” (Customer Programmable Features) in the Electronic Vehicle Information Center (EVIC) section of this manual for details.

For vehicles not equipped with the EVIC, the Automatic Door Locks can be enabled or disabled by performing the following procedure:

1. Close all doors and place the key in the ignition.
2. Cycle the ignition switch between LOCK and ON and back to LOCK 4 times ending up in the LOCK position.

2

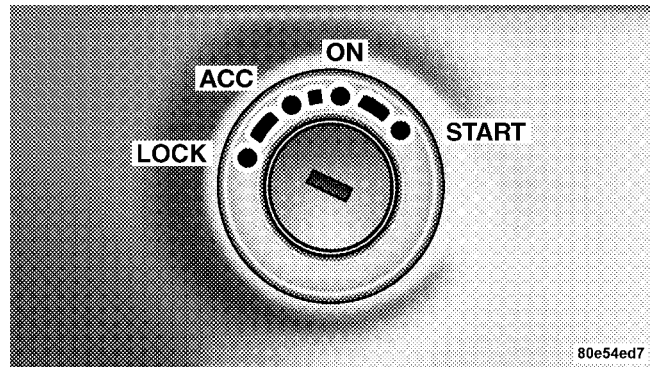

Ignition Key Position

80e54ed7

3. Depress the power door lock switch to lock the doors.

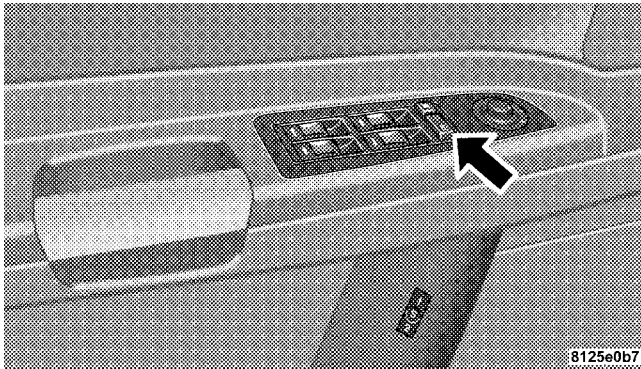

Power Door Lock Switch

4. A single chime will indicate the completion of the programming.

Auto Unlock

The doors will unlock automatically on vehicles with power door locks if:

1. The Auto Unlock feature is enabled.

2. The transmission was in gear and the vehicle speed returned to 0 mph (0 km/h).
3. The transmission is in NEUTRAL or PARK.
4. The driver door is opened.
5. The doors were not previously unlocked.
6. The vehicle speed is 0 mph (0 km/h).

The Auto Unlock feature can be enabled or disabled. Refer to “Personal Settings” (Customer Programmable Features) in the Electronic Vehicle Information Center (EVIC) section of this manual.

For vehicles not equipped with the EVIC, the Auto Unlock feature can be enabled or disabled by performing the following procedure:

1. Close all doors and place the key in the ignition.
2. Cycle the ignition switch between LOCK and ON and back to LOCK 4 times ending up in the LOCK position.

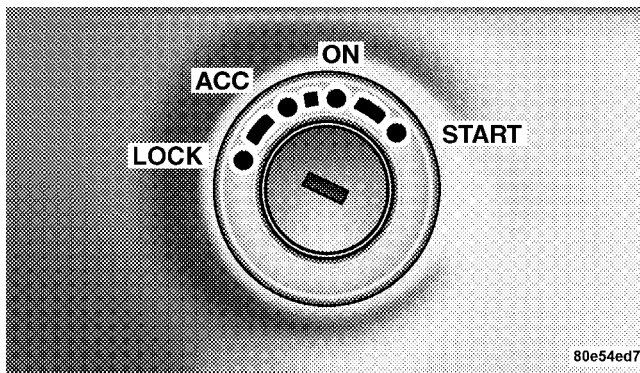

Ignition Key Position

3. Depress the power door unlock switch to unlock the doors.
4. A single chime will indicate the completion of the programming.

NOTE: Use the Auto Door Locks and Auto Unlock features in accordance with local laws.

Child Protection Door Lock

To provide a safer environment for small children riding in the rear seats, the rear doors are equipped with a child protection door lock system.

2

WARNING!

Avoid trapping anyone in the vehicle in a collision. Remember that the rear doors can only be opened from the outside when the child protection locks are engaged.

20 THINGS TO KNOW BEFORE STARTING YOUR VEHICLE

To activate the system, open the rear door and move the child lock control, located near the door's rear latch, to the ON position.

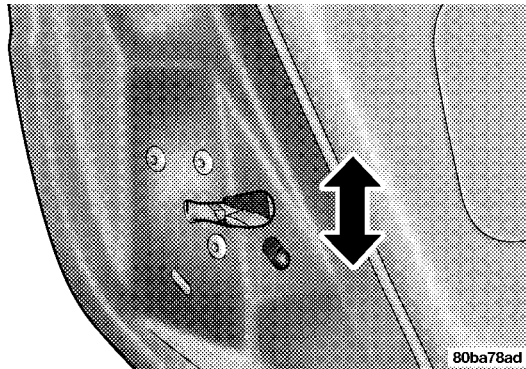

Child Lock Control

When the child lock system is engaged the door can be opened only by using the outside door handle even though the inside door lock is in the unlocked position.

REMOTE KEYLESS ENTRY

This system allows you to lock or unlock the doors, open the trunk, or activate the panic alarm from distances up to about 23 feet (7 meters) using a hand held radio transmitter. The transmitter need not be pointed at the vehicle to activate the system.

NOTE: Inserting the key into the ignition switch disables all buttons on that transmitter however; the buttons on the remaining transmitters will continue to work. Shifting the vehicle out of PARK disables all transmitter buttons for all keys.

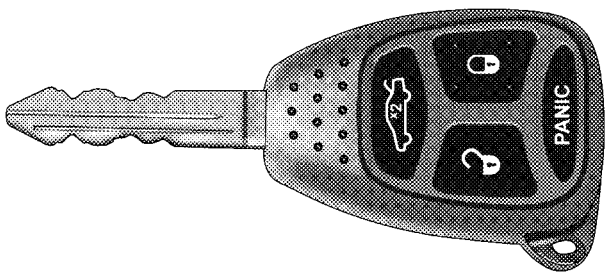

815afa1a

Keyless Entry Transmitter

To unlock the doors:

Press and release the UNLOCK button on the transmitter once to unlock the driver's door, or twice to unlock all doors. The turn signal lights will flash twice to acknowledge the unlock signal. The illuminated entry system also turns on.

The headlights will also activate and remain on for 90 seconds when the doors are unlocked with the remote keyless entry transmitter. The time for this feature is programmable on vehicles equipped with the Electronic

Vehicle Information Center (EVIC). Refer to "Turn Headlights on with Remote Key Unlock" under "Personal Settings" in the Electronic Vehicle Information Center (EVIC) section of this manual for details.

2

NOTE: The system can also be programmed to unlock all doors on the first press of the UNLOCK button. On electronic vehicle information center (EVIC) equipped vehicles, refer to "Remote Unlock Driver's Door 1st" under "Personal Settings" in the Electronic Vehicle Information Center (EVIC) section of this manual. On non-EVIC equipped vehicles, perform the following steps:

1. Press and hold the LOCK button on a programmed key fob.
2. Continue to hold the LOCK button at least 4 seconds, but not longer than 10 seconds, then press and hold the UNLOCK button while still holding the LOCK button.
3. Release both buttons at the same time.
4. Test the feature while outside of the vehicle, by pressing the LOCK/UNLOCK button on the keyfob.

22 THINGS TO KNOW BEFORE STARTING YOUR VEHICLE

NOTE: Pressing the LOCK button on the keyfob while you are inside the vehicle will activate the Security Alarm. Opening a door with the Security Alarm activated will cause the alarm to sound. Press the UNLOCK button to deactivate the Security Alarm.

The “Remote Unlock Driver’s Door 1st” feature can be reactivated by repeating this procedure.

To lock the doors:

Press and release the LOCK button on the transmitter to lock all doors. The turn signal lights will flash once and the horn will chirp once to acknowledge the signal. If desired, the “Sound Horn On Lock” feature can be turned on or off. On electronic vehicle information center (EVIC) equipped vehicles, refer to “Personal Settings” in the “Electronic Vehicle Information Center (EVIC)” section of this manual. On non-EVIC equipped vehicles, perform the following steps:

1. Press the LOCK button for 4 to 10 seconds.
2. While the LOCK button is pressed (after 4 seconds), press the PANIC button. Release both buttons.

The “Sound Horn On Lock” feature can be reactivated by repeating this procedure.

To unlatch the trunk:

Press the trunk button on the transmitter two times to unlatch the trunk.

Using The Panic Alarm:

To turn the panic alarm feature ON or OFF, press and hold the PANIC button on the transmitter for at least one second and release. When the panic alarm is on, the headlights and park lights will flash, the horn will pulse on and off and the interior lights will turn on.

The panic alarm will stay on for 3 minutes unless you turn it off by pressing the PANIC button a second time or if the vehicle speed is 15 mph (24 km/h) or greater.

NOTE:

- The interior lights will turn off when the ignition is switched to the ACC or ON position after the panic alarm is activated. However, the exterior lights and horn will remain on.

- When you turn off the panic alarm by pressing the PANIC button a second time, you may have to be closer to the vehicle due to the radio frequency noises of the system.

To Turn Off “Flash Lights On Lock/Unlock”

NOTE: The Flash Lights On Lock/Unlock feature can be turned on or off. On electronic vehicle information center (EVIC) equipped vehicles, refer to “Personal Settings” in the Electronic Vehicle Information Center (EVIC) section of this manual. On non-EVIC equipped vehicles, perform the following steps:

1. Press and hold the UNLOCK button on the key fob.
2. Continue to hold the UNLOCK button at least 4 seconds, but not longer than 10 seconds, then press and hold the LOCK button while still holding the UNLOCK button.
3. Release both buttons at the same time.

4. Test the flash lights with LOCK feature while outside of the vehicle, by pressing the LOCK button on the key fob with the ignition in the LOCK position, and the key removed.

NOTE: Pressing the LOCK button on the key fob, while you are in the vehicle, will activate the Security Alarm. Opening a door with the Security Alarm activated will cause the alarm to sound. Press the UNLOCK button to deactivate the Security Alarm.

The “Flash Lights On Lock/Unlock” feature can be reactivated by repeating this procedure.

General Information

This device complies with part 15 of the FCC rules and RSS 210 of Industry Canada. Operation is subject to the following conditions:

- This device may not cause harmful interference.
- This device must accept any interference received, including interference that may cause undesired operation.

24 THINGS TO KNOW BEFORE STARTING YOUR VEHICLE

If your Remote Keyless Entry transmitter fails to operate from a normal distance, check for these two conditions.

1. A weak battery in the transmitter. The expected life of the battery is a minimum of three years.
2. Closeness to a radio transmitter such as a radio station tower, airport transmitter, and some mobile or CB radios.

Transmitter Battery Service

The recommended replacement battery is one CR2032 battery.

NOTE: Do not touch the battery terminals that are on the back housing or the printed circuit board.

1. With the transmitter buttons facing down, remove the small screw, and separate the two halves of the transmitter. Make sure not to damage the rubber gasket during removal.

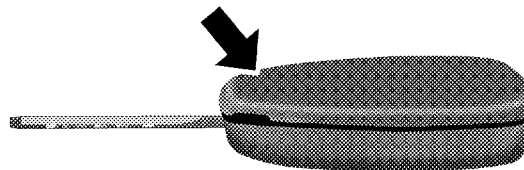

8135d46d

Separating Transmitter Halves

2. Remove and replace the battery. Avoid touching the new battery with your fingers. Skin oils may cause battery deterioration. If you touch a battery, clean it with rubbing alcohol.
3. To reassemble the transmitter case, join the two halves of the case together. Install and tighten the screw until snug. Make sure there is an even “gap” between the two halves. Test transmitter operation.

VEHICLE THEFT ALARM — IF EQUIPPED

The Vehicle Theft Alarm system monitors the vehicle doors for unauthorized entry and the ignition switch for unauthorized operation. If something triggers the alarm, the system will prevent the vehicle from starting and provide the following audible and visual signals: the horn will pulse; the headlights will flash; the park lights will flash; and the Vehicle Theft Alarm Indicator light in the instrument cluster will flash.

If something triggers the alarm, and no action is taken to disarm it, the system will turn off the horn after 3 minutes, turn off all of the visual signals after 15 minutes, and then the system will rearm itself.

To arm the system: Remove the key from the ignition switch and either:

1. Press a power door lock switch while the driver's or passenger's door is open.
2. Press the LOCK button on the keyless entry transmitter.

After the last door is closed, or if all doors are closed, the system will arm itself in about 16 seconds. During that time, the Vehicle Theft Alarm Indicator light will flash. If

it does not illuminate, the system is not arming. Also, if you open a door during the arming period, the system will cancel the arming process. If you wish to rearm the system after closing the door, you must repeat one of the previously described arming sequences.

To disarm the system: either press the UNLOCK button on the remote keyless entry transmitter or insert a valid sentry key into the ignition lock cylinder and turn the key to the ON/START position. If something has triggered the system in your absence, the horn will sound three times when you disarm the system. Check the vehicle for tampering.

NOTE:

- The driver's door key cylinder and the trunk button on the keyless entry transmitter cannot arm or disarm the system.
- The system remains armed during trunk entry. Pressing the trunk button will not disarm the system. If someone enters the vehicle through the trunk and opens any door the alarm will sound.
- When the system is armed, the doors can not be unlocked from the interior power door lock switches.

The Vehicle Theft Alarm system is designed to protect your vehicle, however, you can create conditions where the system will give you a false alarm. If one of the previously described arming sequences has occurred, the system will arm regardless of whether you are in the vehicle or not. If you remain in the vehicle and open a door, the alarm will sound. If this occurs, disarm the system.

If the alarm system is armed and the battery becomes disconnected the system will remain armed when the battery is reconnected. The exterior lights will flash, the horn will sound, and the ignition will not start the vehicle. If this occurs, disarm the system.

WINDOWS

Power Windows

The window controls on the driver's door control all the door windows.

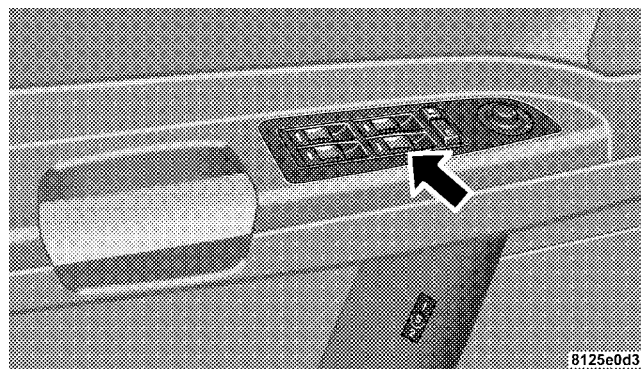

Power Window Switches

There are single window controls on each passenger door trim panel, which operate the passenger door windows. The window controls will operate only when the ignition switch is in the ON or ACCESSORY position.

The window lock switch on the driver's door allows you to disable the window controls on the passenger doors. When the lock switch is pressed, the window controls on the passenger doors will not illuminate and the passenger windows will be disabled.

WARNING!

Never leave children in a vehicle, with the keys in the ignition switch. Occupants, particularly unattended children, can become entrapped by the windows while operating the power window switches. Such entrapment may result in serious injury or death.

Auto Down Feature

The driver door power window switch, and some model passenger door power window switches have an auto down feature. Press the window switch to the second detent, release, and the window will go down automatically.

To open the window part way, press the window switch to the first detent and release it when you want the window to stop.

To stop the window from going all the way down during the auto-down operation, pull up on the switch briefly.

For vehicles not equipped with the Electronic Vehicle Information Center (EVIC), the power window switches will remain active for 10 minutes after the ignition switch is turned off. Opening either front door will cancel this feature.

For vehicles equipped with the EVIC, the power window switches will remain active for up to 60 minutes after the ignition switch is turned off. Opening either front door will cancel this feature. The time is programmable through the EVIC. Refer to "Delay Power Off to Accessories Until Exit" under "Personal Settings (Customer Programmable Features)" under "Electronic Vehicle Information Center (EVIC)" in Section 4 of this manual for details.

Auto Up Feature with Anti-Pinch Protection — If Equipped

Lift the window switch to the second detent, release, and the window will go up automatically.

To stop the window from going all the way up during the auto-up operation, push down on the switch briefly.

To close the window part way, lift the window switch to the first detent and release when you want the window to stop.

For vehicles not equipped with the Electronic Vehicle Information Center (EVIC), the power window switches will remain active for 10 minutes after the ignition switch is turned off. Opening either front door will cancel this feature.

For vehicles equipped with the EVIC, the power window switches will remain active for up to 60 minutes after the ignition switch is turned off. Opening either front door will cancel this feature. The time is programmable through the EVIC. Refer to “Delay Power Off to Accessories Until Exit” under “Personal Settings (Customer

Programmable Features)” under “Electronic Vehicle Information Center (EVIC)” in Section 4 of this manual for details.

NOTE: If the window runs into any obstacle during auto-closure it will reverse direction and then stop. Remove the obstacle and use the window switch again to close the window.

NOTE: Any impact due to rough road conditions may trigger the auto reverse function unexpectedly during auto closure. If this happens pull the switch lightly to the first detent and hold to close window manually.

WARNING!

There is no anti-pinch protection when the window is almost closed. Be sure to clear all objects from the window before closing.

Reset

Any time the vehicle battery is disconnected or goes dead the auto-up function will be disabled. To reactivate the auto-up feature perform the following steps after vehicle power is restored:

1. Pull the window switch up to close window completely and continue to hold the switch up for an additional two seconds after the window is closed.
2. Push the window switch down firmly to the second detent to open the window completely and continue to hold the switch down for an additional two seconds after the window is fully open.

Wind Buffeting

Wind buffeting can be described as the perception of pressure on the ears or a helicopter type sound in the ears. Your vehicle may exhibit wind buffeting with the windows down, or the sunroof (if equipped) in certain open or partially open positions. This is a normal occurrence and can be minimized. If the buffeting occurs with the rear windows open, then open the front and rear windows together to minimize the buffeting. If the

buffeting occurs with the sunroof open, then adjust the sunroof opening to minimize the buffeting.

TRUNK LOCK AND RELEASE

The trunk lid can be released from inside the vehicle by pressing the Trunk Release Button located on the instrument panel to the left of the steering wheel.

NOTE: The transmission must be in Park before the switch will operate.

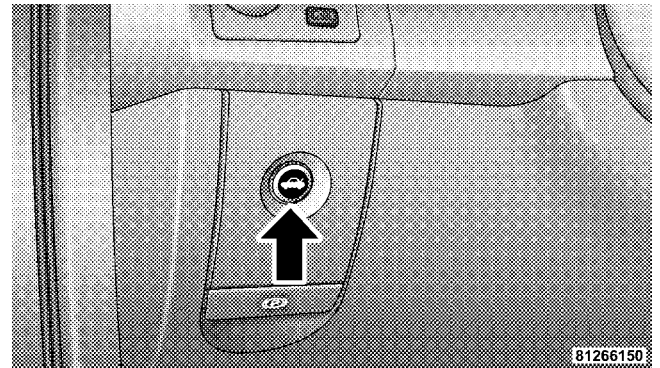

Trunk Release Button

The trunk lid can be released from outside the vehicle by pressing the trunk button on the Remote Keyless Entry Transmitter two times.

With the ignition ON, the trunk open symbol will display in the instrument cluster indicating that the trunk is open. The odometer display will reappear once the trunk is closed.

With the key in lock position or key out, the trunk open symbol will be displayed until the trunk is closed.

TRUNK SAFETY WARNING

WARNING!

Do not allow children to have access to the trunk, either by climbing into the trunk from outside, or through the inside of the vehicle. Always close the trunk lid when your vehicle is unattended. Once in the trunk, young children may not be able to escape, even if they entered through the rear seat. If trapped in the trunk, children can die from suffocation or heat stroke.

Trunk Emergency Release

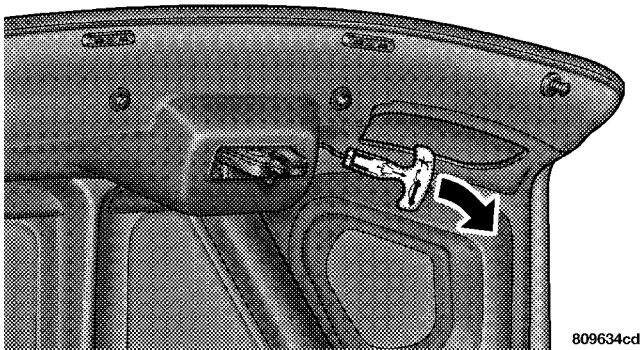

Emergency Release

The trunk of your vehicle is equipped with an emergency release handle. It is located on the inside of the trunk lid, near the latch, and is coated so that it glows in a darkened trunk. Pull on the handle to open the trunk.

OCCUPANT RESTRAINTS

Some of the most important safety features in your vehicle are the restraint systems. These include the front and rear seat belts for the driver and all passengers, front airbags for both the driver and front passenger and, if so equipped, left and right side curtain airbags for the driver and passengers seated next to a window. If you will be carrying children too small for adult-size belts, your seat belts also can be used to hold infant and child restraint systems.

Please pay close attention to the information in this section. It tells you how to use your restraint system properly to keep you and your passengers as safe as possible.

WARNING!

In a collision, you and your passengers can suffer much greater injuries if you are not properly buckled up. You can strike the interior of your vehicle or other passengers, or you can be thrown out of the vehicle. Always be sure you and others in your vehicle are buckled up properly.

Buckle up even though you are an excellent driver, even on short trips. Someone on the road may be a poor driver and cause a collision which includes you. This can happen far away from home or on your own street.

Research has shown that seat belts save lives, and they can reduce the seriousness of injuries in a collision. Some of the worst injuries happen when people are thrown from the vehicle. Seat belts reduce the possibility of ejection and the risk of injury caused by striking the inside of the vehicle. Everyone in a motor vehicle should be belted at all times.

Lap/Shoulder Belts

All seating positions in your vehicle are equipped with Lap/Shoulder Belts.

The belt webbing retractor is designed to lock during very sudden stops or impacts. This feature allows the shoulder part of the belt to move freely with you under normal conditions. But in a collision, the belt will lock and reduce your risk of striking the inside of the vehicle or being thrown out.

WARNING!

It is extremely dangerous to ride in a cargo area, inside or outside of a vehicle. In a collision, people riding in these areas are more likely to be seriously injured or killed.

Do not allow people to ride in any area of your vehicle that is not equipped with seats and seat belts.

Be sure everyone in your vehicle is in a seat and using a seat belt properly.

WARNING!

- Wearing a seat belt incorrectly is dangerous. Seat belts are designed to go around the large bones of your body. These are the strongest parts of your body and can take the forces of a collision the best. Wearing your belt in the wrong place could make your injuries in a collision much worse. You might suffer internal injuries, or you could even slide out of part of the belt. Follow these instructions to wear your seat belt safely and to keep your passengers safe, too.
- Two people should never be belted into a single seat belt. People belted together can crash into one another in an accident, hurting one another badly. Never use a lap/shoulder belt or a lap belt for more than one person, no matter what their size.

Lap/Shoulder Belt Operating Instructions

1. Enter the vehicle and close the door. Sit back and adjust the front seat.
2. The seat belt latch plate is above the back of your seat. Grasp the latch plate and pull out the belt. Slide the latch plate up the webbing as far as necessary to make the belt go around your lap.

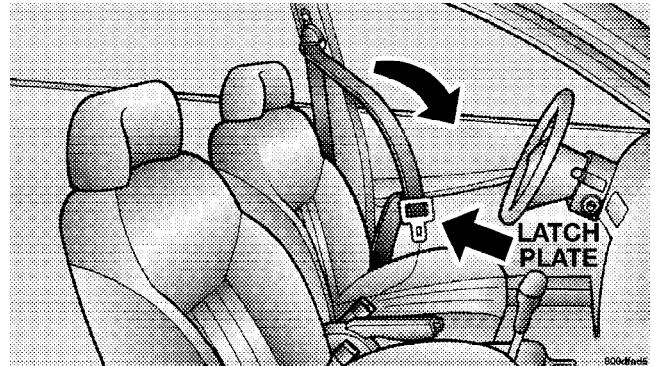
2

Latch Plate To Buckle

3. When the belt is long enough to fit, insert the latch plate into the buckle until you hear a “click.”

WARNING!

- A belt that is buckled into the wrong buckle will not protect you properly. The lap portion could ride too high on your body, possibly causing internal injuries. Always buckle your belt into the buckle nearest you.
- A belt that is too loose will not protect you as well. In a sudden stop you could move too far forward, increasing the possibility of injury. Wear your seat belt snugly.
- A belt that is worn under your arm is very dangerous. Your body could strike the inside surfaces of the vehicle in a collision, increasing head and neck injury. A belt worn under the arm can cause internal injuries. Ribs aren't as strong as shoulder bones. Wear the belt over your shoulder so that your strongest bones will take the force in a collision.
- A shoulder belt placed behind you will not protect you from injury during a collision. You are more likely to hit your head in a collision if you do not wear your shoulder belt. The lap and shoulder belt are meant to be used together.

4. Position the lap belt across your thighs, below your abdomen. To remove slack in the lap belt portion, pull up a bit on the shoulder belt. To loosen the lap belt if it is too tight, tilt the latch plate and pull on the lap belt. A snug belt reduces the risk of sliding under the belt in a collision.

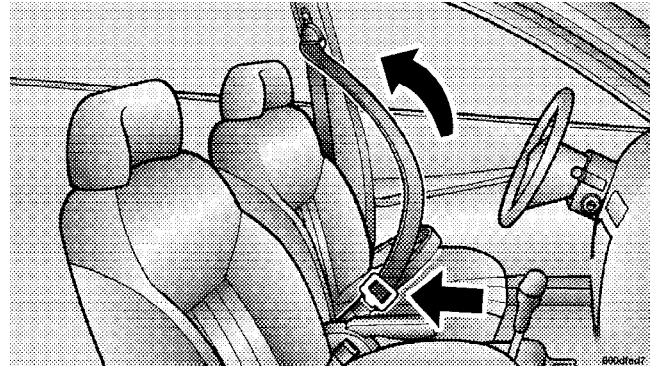

Removing Slack From Belt

WARNING!

- A lap belt worn too high can increase the risk of internal injury in a collision. The belt forces won't be at the strong hip and pelvic bones, but across your abdomen. Always wear the lap belt as low as possible and keep it snug.
- A twisted belt can't do its job as well. In a collision it could even cut into you. Be sure the belt is straight. If you can't straighten a belt in your vehicle, take it to your dealer and have it fixed.

WARNING!

A frayed or torn belt could rip apart in a collision and leave you with no protection. Inspect the belt system periodically, checking for cuts, frays, or loose parts. Damaged parts must be replaced immediately. Do not disassemble or modify the system. Seat belt assemblies must be replaced after a collision if they have been damaged (bent retractor, torn webbing, etc.).

5. Position the shoulder belt on your chest so that it is comfortable and not resting on your neck. The retractor will withdraw any slack in the belt.
6. To release the belt, push the red button on the buckle. The belt will automatically retract to its stowed position. If necessary, slide the latch plate down the webbing to allow the belt to retract fully.

Adjustable Upper Shoulder Belt Anchorage

In the driver and front passenger seats, the shoulder belt can be adjusted upward or downward to position the belt away from your neck. Push and fully depress the button above the webbing to release the anchorage, and then move it up or down to the position that serves you best.

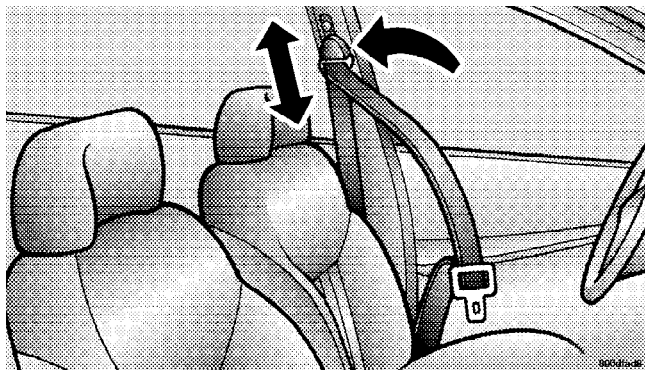
**Adjusting Upper Shoulder Belt**

As a guide, if you are shorter than average, you will prefer a lower position, and if you are taller than average,

you'll prefer a higher position. When you release the anchorage, try to move it up or down to make sure that it is locked in position.

In the rear seat, move toward the center of the seat to position the belt away from your neck.

Seat Belt Pretensioners

The seat belts for both front seating positions are equipped with pretensioning devices that are designed to remove any slack from the seat belts in the event of a collision. These devices improve the performance of the seat belt system by assuring that the belt is tight about the occupant in a collision. Pretensioners work for all size occupants, including those in child restraints.

NOTE: These devices are not a substitute for proper seat belt placement by the occupant. The seat belt still must be worn snugly and positioned properly.

The pretensioners are triggered by the Occupant Restraint Controller (ORC) (refer to information on Airbags in this section). Like the front airbags, the pretensioners

are single use items. After a collision that is severe enough to deploy the airbags and pretensioners, both must be replaced.

Enhanced Seat Belt Reminder System (BeltAlert)

If the driver's or front passenger's seat belt has not been buckled within 60 seconds of starting the vehicle and if the vehicle speed is greater than 5 mph (8 km/h), the Enhanced Warning System (BeltAlert) will alert the driver or front passenger to buckle their seat belt. The driver should also instruct all other occupants to buckle their seat belts. Once the warning is triggered, the Enhanced Warning System (BeltAlert) will continue to chime and flash the Seat Belt Warning Light for 96 seconds or until the driver's or front passenger's seat belt is buckled. The Enhanced Warning System (BeltAlert) will be reactivated if the driver's or front passenger's seat belt is unbuckled for more than 10 seconds and the vehicle speed is greater than 5 mph (8 km/h).

The Enhanced Warning System (BeltAlert) can be enabled or disabled by your authorized dealer or by following these steps:

NOTE: The following steps must occur within the first 60 seconds of the ignition switch being turned to the ON or START position. DaimlerChrysler does not recommend deactivating the Enhanced Warning System (BeltAlert).

1. Turn the ignition switch to the LOCK position and buckle the driver's seat belt.
2. Turn the ignition switch to the ON position and wait for the Seat Belt Warning Light to turn off.
3. Within 60 seconds of turning the ignition switch to the ON position, unbuckle and then re-buckle the driver's seat belt at least three times within 10 seconds, ending with the seat belt buckled.

NOTE: Watch for the Seat Belt Warning Light to turn on while unbuckling and off while re-buckling the seat belt. It may be necessary to retract the seat belt.

4. Turn the ignition switch to the LOCK position. A single chime will sound to signify that you have successfully completed the programming.

The Enhanced Warning System (BeltAlert) can be reactivated by repeating this procedure.

NOTE: Although the Enhanced Warning System (BeltAlert) has been deactivated, the Seat Belt Warning Light will continue to illuminate while the driver's or front passenger's seat belt remains unbuckled.

Seat Belts and Pregnant Women

We recommend that pregnant women use the seat belts throughout their pregnancy. Keeping the mother safe is the best way to keep the baby safe.

Pregnant women should wear the lap part of the belt across the thighs and as snug across the hips as possible. Keep the belt low so that it does not come across the abdomen. That way the strong bones of the hips will take the force if there is a collision.

Seat Belt Extender

If a seat belt is too short, even when fully extended and when the adjustable upper shoulder belt anchorage (if so equipped) is in its lowest position, your dealer can provide you with a seat belt extender. This extender should be used only if the existing belt is not long enough. When it is not required, remove the extender and store it.

WARNING!

Using a seat belt extender when not needed can increase the risk of injury in a collision. Only use when the seat belt is not long enough when it is worn low and snug, and in the recommended seating positions. Remove and store the extender when not needed.

Driver and Right Front Passenger Supplemental Restraint System (SRS) - Airbag

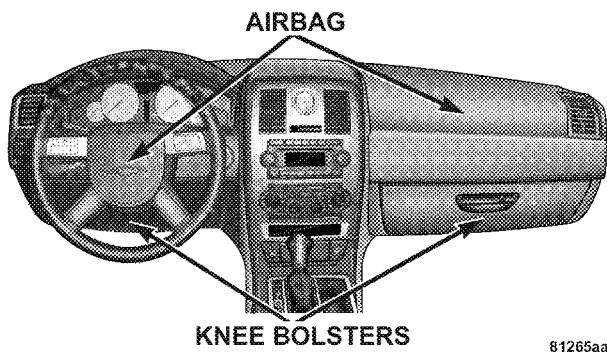

Front Airbag Components

This vehicle has front airbags for both the driver and front passenger as a supplement to the seat belt restraint systems. The driver's airbag is mounted in the center of the steering wheel. The passenger's front airbag is mounted in the instrument panel, above the glove compartment. The words SRS AIRBAG are embossed on the airbag covers.

NOTE: The front airbags are certified to the Federal regulations that allow less forceful deployment.

The front airbags have a multistage inflator design. This may allow the airbag to have different rates of inflation that are based on collision severity and occupant size. Also, the front passenger airbag is certified to the Federal regulations that define Occupant Classification (refer to information on Occupant Classification System in this section).

This vehicle may also be equipped with left and right side curtain airbags to protect the driver and passengers sitting next to a window. If the vehicle is equipped with side curtain airbags, they are located above the side windows. Their covers are also labeled SRS AIRBAG.

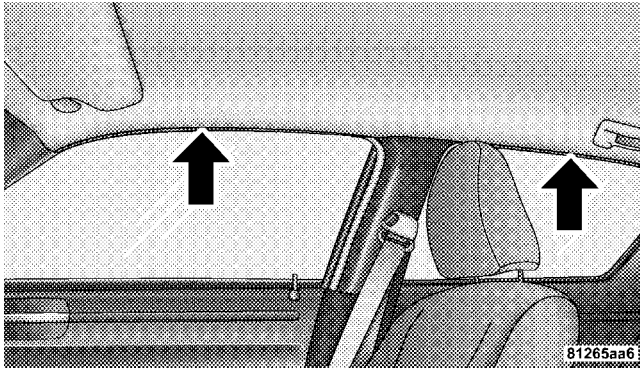

Window Airbag

NOTE: Airbag covers may not be obvious in the interior trim, but they will open to allow airbag deployment.

WARNING!

- Do not put anything on or around the front airbag covers or attempt to manually open them. You may damage the airbags and you could be injured because the airbags are no longer functional. These protective covers for the airbag cushions are designed to open only when the airbags are inflating.
- If your vehicle is equipped with left and right side curtain airbags, do not stack luggage or other cargo up high enough to block the location of the side curtain airbag. The area where the side curtain airbag is located should remain free from any obstructions.
- If your vehicle is equipped with left and right side curtain airbags, do not have any accessory items installed which will alter the roof, including adding a sunroof to your vehicle. Do not add roof racks that require permanent attachments (bolts or screws) for installation on the vehicle roof. Do not drill into the roof of the vehicle for any reason.
- Do not drill, cut or tamper with the knee bolster in any way.
- Do not mount any accessories to the knee bolster such as alarm lights, stereos, citizens band radios etc.

Along with the seat belts, front airbags work with the instrument panel knee bolsters to provide improved protection for the driver and front passenger. Side Curtain Airbags also work with seat belts to improve occupant protection.

The seat belts are designed to protect you in many types of collisions. The front airbags deploy in moderate to severe frontal collisions.

NOTE: The passenger front airbag may not deploy even when the driver front airbag has if the Occupant Classification System (refer to information on Occupant Classification System in this section) has determined the passenger seat is empty or is occupied by someone that is classified in the "small child" category.

If your vehicle is so equipped, the Side Curtain Airbag on the crash side of the vehicle is triggered in moderate to severe side collisions. But even in collisions where the airbags work, you need the seat belts to keep you in the right position for the airbags to protect you properly.

Here are some simple steps you can take to minimize the risk of harm from a deploying airbag.

1. Children 12 years old and under should ride buckled up in the rear seat. Infants in rear-facing child restraints should **NEVER** ride in the front seat of a vehicle with a passenger front airbag. An airbag deployment could cause severe injury or death to infants in that position.

Children that are not big enough to wear the vehicle seat belt properly (refer to information on Child Restraint in this section) should be secured in the rear seat in child restraints or belt-positioning booster seats.

Older children who do not use child restraints or belt-positioning booster seats should ride properly buckled up in the rear seat. Never allow children to slide the shoulder belt behind them or under their arm.

If a child from 1 to 12 years old must ride in the front passenger seat because the vehicle is crowded, move the seat as far back as possible, and use the proper child restraint (refer to information on Child Restraint in this section).

42 THINGS TO KNOW BEFORE STARTING YOUR VEHICLE

2. You should read the instructions provided with your child restraint to make sure that you are using it properly.
3. All occupants should use their seat belts properly.
4. The driver and front passenger seats should be moved back as far as practical to allow the airbags time to inflate.
5. If your vehicle has left and right side curtain airbags, do not lean against the door; airbags will inflate forcefully into the space between you and the door.
6. If the airbag system in this vehicle needs to be modified to accommodate a disabled person, contact the Customer Center. Phone numbers are provided in the "If You Need Customer Assistance" section in this manual.

WARNING!

- Relying on the airbags alone could lead to more severe injuries in a collision. The airbags work with your seat belt to restrain you properly. In some collisions the airbags won't deploy at all. Always wear your seat belts even though you have airbags.
- Being too close to the steering wheel or instrument panel during airbag deployment could cause serious injury. Airbags need room to inflate. Sit back, comfortably extending your arms to reach the steering wheel or instrument panel.
- If the vehicle has left and right side curtain airbags, they also need room to inflate. Do not lean against the door or window. Sit upright in the center of the seat.

Air Bag System Components

The airbag system consists of the following:

- Occupant Restraint Controller
- Airbag Warning Light
- Driver Airbag
- Passenger Airbag
- Side Curtain Airbags above Side Windows (if equipped)
- Side Remote Acceleration Sensors (if equipped)
- Steering Wheel and Column
- Instrument Panel
- Interconnecting Wiring
- Knee Impact Bolsters
- Front Acceleration Sensors
- Driver and Front Passenger Seat Belt Pretensioners
- Occupant Classification System (OCS) for the Front Passenger Seat

- Occupant Classification Module
- Passenger Airbag Disable (PAD) Indicator Light
- Weight Sensors

How The Airbag System Works

- The **Occupant Restraint Controller (ORC)** determines if a frontal collision is severe enough to require the airbags to inflate. The front airbag inflators are designed to provide different rates of airbag inflation from direction provided by the ORC. The ORC may also modify the rate of inflation based on the occupant size provided by the Occupant Classification Module. The ORC will not detect roll over.
- The ORC also monitors the readiness of the electronic parts of the system whenever the ignition switch is in the **START** or **ON** positions. These include all of the items listed above except the knee bolster, the instrument panel, and the steering wheel and column. If the key is in the **LOCK** position, in the **ACC** position, or not in the ignition, the airbags are not on and will not inflate.



- Also, the ORC turns on the airbag warning light and PAD indicator light in the instrument panel for 6 to 8 seconds for a self-check when the ignition is first turned on. After the self-check, the airbag warning light will turn off. The PAD indicator light will function normally (refer to information on Passenger Airbag Disable (PAD) Indicator Light in this section). If the ORC detects a malfunction in any part of the system, it turns on the airbag warning light either momentarily or continuously. A single chime will sound if the light comes on again after initial start up.

WARNING!

Ignoring the AIRBAG light in your instrument panel could mean you won't have the airbags to protect you in a collision. If the light does not come on, stays on after you start the vehicle, or if it comes on as you drive, have the airbag system checked right away.

- The **Occupant Classification System (OCS)** is part of a Federally regulated safety system required for this vehicle. It is designed to turn off the front passenger airbag in the unlikely event that a rear-facing infant seat is in the front passenger seat.

NOTE: Children 12 years and under should always ride buckled up in a rear seat in an appropriate child restraint.

- The **Passenger Air Bag Disable (PAD) Indicator Light** (an amber light located in the center of the instrument panel) tells the driver and front passenger when the front passenger air bag is turned off. The PAD indicator light illuminates the front passenger air bag icon and the words "PASS AIR BAG OFF" to show that the passenger air bag will not inflate during a collision requiring air bags. When the right front passenger seat is empty or when very light objects are placed on the seat, the passenger air bag will not inflate even though the PAD indicator light is not illuminated.



81321cb8

Passenger Airbag Disable Light

The PAD indicator light should not be illuminated when teenagers, most children in a forward-facing child restraint or booster seats, most children that can properly wear the vehicle’s seat belt, and when an adult passenger is properly seated in the front passenger seat. In this case, the air bag is ready to be inflated if a collision requiring an air bag occurs.

For almost all properly installed rear facing child restraints, the PAD indicator light will be illuminated indicating that the front passenger air bag is turned off

and will not inflate. If the PAD indicator light is not illuminated, **DO NOT** assume the air bag is turned off and move the child restraint to the rear seat. A deploying passenger air bag can cause death or serious injury to a child in a rear facing infant seat.

NOTE: Even though this vehicle is equipped with an occupant classification system, children 12 years and under should always ride buckled up in a rear seat in an appropriate child restraint (refer to information on Child Restraint in this section).

Front Passenger Seat Occupant	Passenger Airbag Disable (PAD) Indicator Light	Airbag Status
Adult	OFF	ON
Grocery Bags, Heavy Briefcases and Other Relatively Light Objects	ON	OFF
Empty or Very Small Objects	OFF*	OFF
* Since the system senses weight, some small objects will turn the PAD Indicator Light on.		

The OCS classifies an occupant using weight sensors mounted in the base of the front passenger seat. Any weight on the seat will be sensed by the system. Objects hanging on the seat or other passengers pushing down on the seat will also be sensed. The weight of an adult will cause the system to turn the airbag on. In this case, the OCS has classified the occupant of the seat as an adult. An adult occupant needs to sit in a normal position (with their feet on or near the floor) in order to be properly classified. Reclining the seat back too far may change how an occupant is classified by the OCS.

Drivers and adult passengers should verify that the PAD Indicator Light is not illuminated when an adult is riding in the front passenger seat. If an adult occupant's weight is transferred to another part of the vehicle (like the door or instrument panel), the weight sensors in the seat may not properly classify the occupant. Objects lodged under the seat or between the seat and the center console can prevent the occupant's weight from being measured properly and may result in the occupant being improperly classified. Ensure that the front passenger seat back does not touch anything placed on the back seat because

this can also affect occupant classification. Also, if you fold down the rear seat check to be sure it doesn't touch the front passenger seat.

If the front passenger seat is damaged in any way, it should only be serviced by an authorized dealer. If the seat is removed (or even if the seat attachment bolts are loosened or tightened in any way), take the vehicle to an authorized dealer.

If there is a fault present in the OCS, the Airbag Warning Light (a red light located in the center of the instrument cluster directly in front of the driver) will be turned on. This indicates that you should take the vehicle to an authorized dealer. The Airbag Warning Light is turned on whenever there is a fault that can affect the operation of the airbag system. If there is a fault present in the OCS, both the PAD Indicator Light and the Airbag Warning Light are illuminated to show that the passenger airbag is turned off until the fault is cleared. If an object is lodged under the seat and interferes with operation of the weight sensors, a fault will occur which turns on both the PAD

Indicator Light and the Airbag Warning Light. Once the lodged object is removed, the fault will be automatically cleared after a short period of time.

- The **Driver and Passenger Airbag/Inflator Units** are located in the center of the steering wheel and the right side of the instrument panel. When the ORC detects a collision requiring the airbags, it signals the inflator units. A large quantity of nontoxic gas is generated to inflate the front airbags. Different airbag inflation rates may be possible based on collision severity and occupant size. The steering wheel hub trim cover and the upper right side of the instrument panel separate and fold out of the way as the bags inflate to their full size. The bags fully inflate in about 50 - 70 milliseconds. This is about half of the time it takes to blink your eyes. The bags then quickly deflate while helping to restrain the driver and front passenger. The driver's front airbag gas is vented through vent holes in the sides of the airbag. The passenger's front airbag gas is vented through vent holes in the sides of the airbag. In this way the airbags do not interfere with your control of the vehicle.
- The **Occupant Classification Module (OCM)** is located beneath the front passenger seat. The OCM classifies the occupant into categories based on the measurements made by the seat weight sensors. The OCM communicates with the Occupant Restraint Controller (ORC). The ORC uses the occupant category to determine whether the front passenger airbag should be turned off. It also determines the rate of airbag inflation during a collision.
- Your vehicle has four **Weight Sensors** located between the seat and the floor pan. The weight sensors measure applied weight and transfers that information to the OCM.
- The **Side Impact SRS Side Curtain Airbag** are designed to activate only in certain side collisions. When the ORC (with side impact option) detects a collision requiring the side curtain airbag to inflate, it signals the inflators on the crash side of the vehicle. A quantity of nontoxic gas is generated to inflate the side curtain airbag. The inflating side curtain airbag pushes the outside edge of the headliner out of the way and covers the window. The airbag inflates in about 30

48 THINGS TO KNOW BEFORE STARTING YOUR VEHICLE

milliseconds (about one quarter of the time it takes to blink your eyes) with enough force to injure you if you are not belted and seated properly, or if items are positioned in the area where the side curtain airbag inflates. This especially applies to children. The side curtain airbag is only about 3-1/2 inches (9 cm) thick when it is inflated.

- The **Knee Impact Bolsters** help protect the knees of the driver and the front passenger, and position everyone for the best interaction with the front airbag.

The front passenger seat assembly contains critical components that affect the front passenger airbag deployment. Correctly functioning front passenger seat components are critical for the Occupant Classification System (OCS) to properly classify the front passenger and calculate the proper airbag deployment. Do not make any modifications to the front passenger seat components, assembly, or to the seat cover.

The following requirements must be strictly adhered to:

- Do not modify the front passenger seat assembly or components in any way.
- Do not modify the front seat center console or center position seat in any way.
- Do not use prior or future model year seat covers not designated for the specific model being repaired. Always use the correct seat cover specified for the vehicle.
- Do not replace the seat cover with an aftermarket seat cover.
- Do not add a secondary seat cover other than those approved by DaimlerChrysler/Mopar.[®]
- At no time should any supplemental restraint system (SRS) component or SRS related component or fastener be modified or replaced with any part except those which are approved by DaimlerChrysler/Mopar.[®]

WARNING!

Unapproved modifications or service procedures to the front passenger seat assembly, its related components, or seat cover may inadvertently change the airbag deployment in case of a frontal crash. This could result in death or serious injury to the front seat passenger if the vehicle is involved in an accident. A modified vehicle may not comply with required Federal Motor Vehicle Safety Standards (FMVSS).

If A Deployment Occurs

The airbag system is designed to deploy when the Occupant Restraint Controller detects a moderate-to-severe collision, to help restrain the driver and front passenger, and then to immediately deflate.

NOTE: A frontal collision that is not severe enough to need airbag protection will not activate the system. This does not mean something is wrong with the airbag system.

If you do have a collision which deploys the airbags, any or all of the following may occur:

- The nylon airbag material may sometimes cause abrasions and/or skin reddening to the driver and front passenger as the airbags deploy and unfold. The abrasions are similar to friction rope burns or those you might get sliding along a carpet or gymnasium floor. They are not caused by contact with chemicals. They are not permanent and normally heal quickly. However, if you haven't healed significantly within a few days, or if you have any blistering, see your doctor immediately.
- As the airbags deflate you may see some smoke-like particles. The particles are a normal by-product of the process that generates the nontoxic gas used for airbag inflation. These airborne particles may irritate the skin, eyes, nose, or throat. If you have skin or eye irritation, rinse the area with cool water. For nose or throat irritation, move to fresh air. If the irritation continues, see your doctor. If these particles settle on your clothing, follow the garment manufacturer's instructions for cleaning.

- It is not advisable to drive your vehicle after the airbags have been deployed. If you are involved in another collision, the airbags will not be in place to protect you.

WARNING!

Deployed airbags can't protect you in another collision. Have the airbags replaced by an authorized dealer as soon as possible.

Enhanced Accident Response Feature

If the airbags deploy after an impact and the electrical system remains functional, vehicles equipped with power door locks will unlock automatically. In addition, approximately 5 seconds after the vehicle has stopped moving, the interior lights will illuminate to aid visibility.

NOTE: The interior lights can only be deactivated if the key is removed from the ignition switch or the vehicle is driven.

Maintaining Your Airbag System**WARNING!**

- Modifications to any part of the airbag system could cause it to fail when you need it. You could be injured because the airbags are not there to protect you. Do not modify the components or wiring, including adding any kind of badges or stickers to the steering wheel hub trim cover or the upper right side of the instrument panel. Do not modify the front bumper, vehicle body structure, or frame.
- You need proper knee impact protection in a collision. Do not mount or locate any aftermarket equipment on or behind the knee impact bolster.
- Do not place or hang any items such as add-on video players on the right front passenger seat back. The additional weight may cause the Occupant Classification System to be unable to correctly classify the right front occupant. This could allow the passenger frontal airbag to inflate when it is not desired.
- It is dangerous to try to repair any part of the airbag system yourself. Be sure to tell anyone who works on your vehicle that it has airbags.

Airbag Light



You will want to have the airbags ready to inflate for your protection in an impact. While the airbag system is designed to be maintenance free, if any of the following occurs, have an authorized dealer service the system promptly:

- The airbag light does not come on or flickers during the 6 to 8 seconds when the ignition switch is first turned on.
- The light remains on or flickers after the 6 to 8 second interval.
- The light flickers or comes on and remains on while driving.

Event Data Recorder (EDR)

In the event of an airbag deployment, your vehicle is designed to record up to 2-seconds of specific vehicle data parameters (see list below) in an event data recorder prior to the moment of airbag deployment. Please note that such data are ONLY recorded if an airbag deploys, and are otherwise unavailable. In conjunction with other data gathered during a complete accident investigation,

the electronic data may be used by DaimlerChrysler and others to learn more about the possible causes of crashes and associated injuries in order to assess and improve vehicle performance. In addition to crash investigations initiated by DaimlerChrysler, such investigations may be requested by customers, insurance carriers, government officials, and professional crash researchers, such as those associated with universities, and with hospital and insurance organizations.

In the event that an investigation is undertaken by DaimlerChrysler (regardless of initiative), the company or its designated representative will first obtain permission of the appropriate custodial entity for the vehicle (usually the vehicle owner or lessee) before accessing the electronic data stored, unless ordered to download data by a court with legal jurisdiction (i.e., pursuant to a warrant). A copy of the data will be provided to the custodial entity upon request. General data that does not identify particular vehicles or crashes may be released for incorporation in aggregate crash databases, such as those maintained by the US government and various states. Data of a potentially sensitive nature, such as would identify a particular driver, vehicle, or crash, will be

52 THINGS TO KNOW BEFORE STARTING YOUR VEHICLE

treated confidentially. Confidential data will not be disclosed by DaimlerChrysler to any third party except when:

1. Used for research purposes, such as to match data with a particular crash record in an aggregate database, provided confidentiality of personal data is thereafter preserved
2. Used in defense of litigation involving a DaimlerChrysler product
3. Requested by police under a legal warrant
4. Otherwise required by law

Data Parameters that May Be Recorded:

- Diagnostic trouble code(s) and warning light status for electronically-controlled safety systems, including the airbag system
- Airbag disable light status (if equipped)
- "Time" of airbag deployment (in terms of ignition cycles and vehicle mileage)
- Airbag deployment level (if applicable)

- Seatbelt status
- Brake status (service and parking brakes)
- Accelerator status (including vehicle speed)
- Engine control status (including engine speed)
- Cruise control status
- Traction/stability control status

Child Restraint

Everyone in your vehicle needs to be buckled up all the time, babies and children, too. Every state in the United States and all Canadian provinces require that small children ride in proper restraint systems. This is the law, and you can be prosecuted for ignoring it.

Children 12 years and under should ride properly buckled up in a rear seat, if available. According to crash statistics, children are safer when properly restrained in the rear seats rather than in the front.

WARNING!

In a collision, an unrestrained child, even a tiny baby, can become a missile inside the vehicle. The force required to hold even an infant on your lap could become so great that you could not hold the child, no matter how strong you are. The child and others could be badly injured. Any child riding in your vehicle should be in a proper restraint for the child's size.

There are different sizes and types of restraints for children from newborn size to the child almost large enough for an adult safety belt. Always check the child seat Owner's Manual to ensure you have the right seat for your child. Use the restraint that is correct for your child:

Infants and Child Restraints

- Safety experts recommend that children ride rearward-facing in the vehicle until they are at least one year old **and** weigh at least 20 lbs (9 kg). Two types of child restraints can be used rearward-facing: infant carriers and "convertible" child seats.
- The infant carrier is only used rearward-facing in the vehicle. It is recommended for children who weigh up to about 20 lbs (9 kg). "Convertible" child seats can be used either rearward-facing or forward-facing in the vehicle. Convertible child seats often have a higher weight limit in the rearward-facing direction than infant carriers do, so they can be used rearward-facing by children who weigh more than 20 lbs (9 kg) but are less than one year old. Both types of child restraints are held in the vehicle by the lap/shoulder belt or the LATCH child restraint anchorage system. Refer to "LATCH — Child Seat Anchorage System (Lower Anchors and Tether for Children)" in this section.
- Rearward-facing child seats must **NEVER** be used in the front seat of a vehicle with the front passenger airbag unless the airbag is turned off. An airbag deployment could cause severe injury or death to infants in this position.

WARNING!

- Improper installation can lead to failure of an infant or child restraint. It could come loose in a collision. The child could be badly injured or killed. Follow the manufacturer's directions exactly when installing an infant or child restraint.
- A rearward facing child restraint should only be used in a rear seat. A rearward facing child restraint in the front seat may be struck by a deploying passenger airbag which may cause severe or fatal injury to the infant.

Here are some tips on getting the most out of your child restraint:

- Before buying any restraint system, make sure that it has a label certifying that it meets all applicable Safety Standards. We also recommend that you make sure that you can install the child restraint in the vehicle where you will use it before you buy it.

- The restraint must be appropriate for your child's weight and height. Check the label on the restraint for weight and height limits.
- Carefully follow the instructions that come with the restraint. If you install the restraint improperly, it may not work when you need it.
- Buckle the child into the seat according to the child restraint manufacturer's directions.
- When your child restraint is not in use, secure it in the vehicle with the seat belt or remove it from the vehicle. Do not leave it loose in the vehicle. In a sudden stop or collision, it could strike the occupants or seat backs and cause serious personal injury.

NOTE: For additional information, refer to www.seatcheck.org or call 1-866-SEATCHECK.

Older Children and Child Restraints

Children who weigh more than 20 lbs (9 kg) and who are older than one year can ride forward-facing in the vehicle. Forward-facing child seats and convertible child seats used in the forward-facing direction are for children who weigh 20 to 40 lbs (9 to 18 kg) and who are older than one year. These child seats are also held in the vehicle by the lap/shoulder belt or the LATCH child restraint anchorage system. Refer to “LATCH — Child Seat Anchorage System (Lower Anchors and Tether for Children)” in this section.

The belt-positioning booster seat is for children weighing more than 40 lbs (18 kg), but who are still too small to fit the vehicle’s seat belts properly. If the child cannot sit with knees bent over the vehicle’s seat cushion while the child’s back is against the seat back, they should use a belt-positioning booster seat. The child and belt-positioning booster seat are held in the vehicle by the lap/shoulder belt.

Children Too Large For Booster Seats

Children who are large enough to wear the shoulder belt comfortably, and whose legs are long enough to bend

over the front of the seat when their back is against the seat back, should use the lap/shoulder belt in a rear seat.

- Make sure that the child is upright in the seat.
- The lap portion should be low on the hips and as snug as possible.
- Check belt fit periodically. A child’s squirming or slouching can move the belt out of position.
- If the shoulder belt contacts the face or neck, move the child closer to the center of the vehicle. Never allow a child to put the shoulder belt under an arm or behind their back.

LATCH — Child Seat Anchorage System (Lower Anchors and Tether for Children)

Your vehicle’s rear seat is equipped with the child restraint anchorage system called LATCH. The LATCH system provides for the installation of the child restraint without using the vehicle’s seat belts, instead securing the child restraint using lower anchorages and upper tether straps from the child restraint to the vehicle structure.

LATCH-compatible child restraint systems are now available. However, because the lower anchorages are to be introduced over a period of years, child restraint systems having attachments for those anchorages will continue to also have features for installation using the vehicle's seat belts. Child restraints having tether straps and hooks for connection to the top tether anchorages have been available for some time. For some older child restraints, many child restraint manufacturers offer add-on tether strap kits or retro-fit kits. You are urged to take advantage of all the available attachments provided with your child restraint in any vehicle.

All three rear seating positions have lower anchorages that are capable of accommodating LATCH-compatible child seats. You should **NEVER** install LATCH-compatible child seats such that two seats share a common lower anchorage.

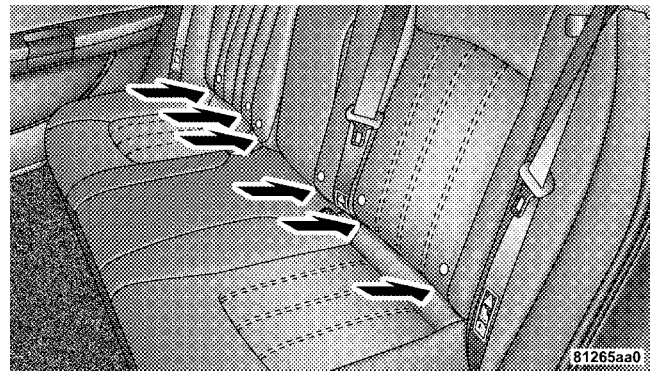

LATCH Anchorages

Installing the LATCH-Compatible Child Restraint System

We urge that you carefully follow the directions of the manufacturer when installing your child restraint. Not all child restraint systems will be installed as described here. Again, carefully follow the installation instructions that were provided with the child restraint system.



The rear seat lower anchorages are round bars, located at the rear of the seat cushion where it meets the seat back. The location of the lower anchorages are identified by a symbol on the seat back. You will easily feel them if you run your finger along the intersection of the seatback and seat cushion surfaces.



In addition, there are tether strap anchorages behind each rear seating position located in the panel between the rear seat back and the rear window. These tether strap anchorages are under a plastic cover with this symbol on it.

Many, but not all restraint systems will be equipped with separate straps on each side, with each having a hook or connector for attachment to the lower anchorage and a means of adjusting the tension in the strap. Forward-facing toddler restraints and some rear-facing infant restraints will also be equipped with a tether strap, a hook for attachment to the tether strap anchorage and a means of adjusting the tension of the strap.

You will first loosen the adjusters on the lower straps and on the tether strap so that you can more easily attach the

hooks or connectors to the vehicle anchorages. Next attach the lower hooks or connectors over the top of the seat cover material. Then rotate the tether anchorage cover directly behind the seat where you are placing the child restraint and attach the tether strap to the anchorage, being careful to route the tether strap to provide the most direct path between the anchor and the child restraint. If your vehicle is equipped with adjustable rear head restraints, raise the head restraint and, where possible, route the tether strap under the head restraint and between the two posts. If not possible, lower the head restraint and route the tether strap around the outboard side of the head restraint. Finally, tighten all three straps as you push the child restraint rearward and downward into the seat, removing slack in the straps according to the child restraint manufacturer's instructions.

NOTE: When using the LATCH attaching system to install a child restraint, please ensure that all seat belts not being used for occupant restraints are stowed and out of reach of children. It is recommended that before installing the child restraint, buckle the seat belt so the seat belt is tucked behind the child restraint and out of reach. If the buckled seat belt interferes with the child

restraint installation, instead of tucking the seat belt behind the child restraint, route the seat belt through the child restraint belt path and then buckle it. This should stow the seat belt out of the reach of an inquisitive child. Remind all children in the vehicle that the seat belts are not toys and should not be played with, and never leave your child unattended in the vehicle.

WARNING!

Improper installation of a child restraint to the LATCH anchorages can lead to failure of an infant or child restraint. The child could be badly injured or killed. Follow the manufacturer's directions exactly when installing an infant or child restraint.

Installing Child Restraints Using the Vehicle Seat belt

The passenger seat belts are equipped with cinching latch plates which are designed to keep the lap portion tight around the child restraint so that it is not necessary to use a locking clip. Pulling up on the shoulder portion of the lap/shoulder belt will tighten the belt. The cinching latch

plate will keep the belt tight, however, any seat belt system will loosen with time, so check the belt occasionally and pull it tight if necessary.

In the rear seat, you may have trouble tightening the lap/shoulder belt on the child restraint because the buckle or latch plate is too close to the belt path opening on the restraint. Disconnect the latch plate from the buckle and twist the short buckle-end belt several times to shorten it. Insert the latch plate into the buckle with the release button facing out.

If the belt still can't be tightened, or if by pulling and pushing on the restraint loosens the belt, you may need to do something more. Disconnect the latch plate from the buckle, turn the buckle around, and insert the latch plate into the buckle again. If you still can't make the child restraint secure, try a different seating position.

To attach a child restraint tether strap:

1. Rotate the cover over the anchor directly behind the seat where you are placing the child restraint.

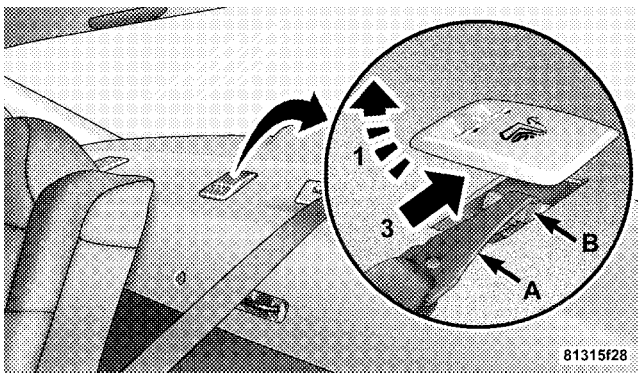

Tether Strap Mounting

2. Route the tether strap to provide the most direct path for the strap between the anchor and the child seat. If your vehicle is equipped with adjustable rear head restraints, raise the head restraint and, where possible, route the tether strap under the head restraint and between the two posts. If not possible, lower the head restraint and pass the tether strap around the outboard side of the head restraint.

3. Attach the tether strap hook (A) of the child restraint to the anchor (B) and remove slack in the tether strap according to the child restraint manufacturer's instructions.

2

WARNING!

An incorrectly anchored tether strap could lead to increased head motion and possible injury to the child. Use only the anchor positions directly behind the child seat to secure a child restraint top tether strap.

Transporting Pets

Airbags deploying in the front seat could harm your pet. An unrestrained pet will be thrown about and possibly injured, or injure a passenger during panic braking or in a collision.

Pets should be restrained in the rear seat in pet harnesses or pet carriers that are secured by seat belts.

ENGINE BREAK-IN RECOMMENDATIONS

A long break-in period is not required for the engine in your new vehicle.

Drive moderately during the first 300 miles (500 km). After the initial 60 miles (100 km), speeds up to 50 or 55 mph (80 or 90 km/h) are desirable.

While cruising, brief full-throttle acceleration, within the limits of local traffic laws, contributes to a good break-in. Wide open throttle acceleration in low gear can be detrimental and should be avoided.

The engine oil installed in the engine at the factory is a high quality energy conserving type lubricant. Oil changes should be consistent with anticipated climate conditions under which vehicle operations will occur. The recommended viscosity and quality grades are shown in Section 7 of this manual. **NON-DETERGENT OR STRAIGHT MINERAL OILS MUST NEVER BE USED.**

A new engine may consume some oil during its first few thousand miles (kilometers) of operation. This should be considered as a normal part of the break-in and not interpreted as an indication of difficulty.

SAFETY TIPS

Exhaust Gas

WARNING!

Exhaust gases can injure or kill. They contain carbon monoxide (CO) which is colorless and odorless. Breathing it can make you unconscious and can eventually poison you. To avoid breathing (CO) follow the safety tips below.

Do not run the engine in a closed garage or in confined areas any longer than needed to move your vehicle in or out of the area.

If it is necessary to sit in a parked vehicle with the engine running, adjust your heating or cooling controls to force outside air into the vehicle. Set the blower at high speed.

WARNING!

If you are required to drive with the trunk open, make sure that all windows are closed, and the climate control blower switch is set at high speed. **DO NOT** use the recirculation mode.

Safety Checks You Should Make Inside The Vehicle**Seat Belts**

Inspect the belt system periodically, checking for cuts, frays and loose parts. Damaged parts must be replaced immediately. Do not disassemble or modify the system.

Front seat belt assemblies must be replaced after a collision. Rear seat belt assemblies must be replaced after a collision if they have been damaged (bent retractor, torn webbing, etc. If there is any question regarding belt or retractor condition, replace the belt.

Airbag Light

The light should come on and remain on for 6 to 8 seconds as a bulb check when the ignition switch is first turned ON. If the LED is not lit during starting, have it checked. If the light stays on or comes on while driving, have the system checked by an authorized dealer.

Defroster

Check operation by selecting the defrost mode and place the blower control on high speed. You should be able to feel the air directed against the windshield.

Periodic Safety Checks You Should Make Outside The Vehicle**Tires**

Examine tires for excessive tread wear or uneven wear patterns. Check for stones, nails, glass, or other objects lodged in the tread. Inspect tread and sidewall for cuts or cracks. Check wheel nuts for tightness, and tires (including spare) for proper pressure.

Lights

Have someone observe the operation of exterior lights while you work the controls. Check turn signal and high beam indicator lights on the instrument panel.

Fluid Leaks

Check area under vehicle after overnight parking for fuel, engine coolant, oil or other fluid leaks. Also, if gasoline fumes are detected or fuel, power steering fluid or brake fluid leaks are suspected, the cause should be located and corrected immediately.

UNDERSTANDING THE FEATURES OF YOUR VEHICLE

CONTENTS

■ Mirrors67	□ Heated Remote Control Mirrors — If Equipped69
□ Inside Day/Night Mirror67	□ Illuminated Vanity Mirrors — If Equipped70
□ Automatic Dimming Inside Mirror — If Equipped67	■ Hands-Free Communication (UConnect™) — If Equipped70
□ Driver's Side Outside Mirror Auto Dimmer — If Equipped68	□ Operations72
□ Tilt In Reverse Feature — If Equipped68	□ Phone Call Features77
□ Exterior Mirrors Folding Feature — If Equipped68	□ UConnect™ System Features79
□ Outside Mirror — Driver's Side68	□ Advanced Phone Connectivity83
□ Outside Mirror — Passenger's Side68	□ Things You Should Know About Your UConnect™ System85
□ Power Remote-Control Mirrors69	■ Seats90

64 UNDERSTANDING THE FEATURES OF YOUR VEHICLE

□ Power Seats	90	□ Headlight Switch	102
□ Power Reclining Seats	91	□ Multi-Function Lever	102
□ Lumbar Support	92	□ Headlights, Parking Lights, Instrument Panel Lights	103
□ Heated Seats — If Equipped	92	□ Automatic Headlights - If Equipped	103
□ Head Restraints	94	□ Headlights On With Wipers (Available With Auto Headlights Only)	103
□ Folding Rear Seat	94	□ Smartbeams — If Equipped	104
■ Driver Memory Seat	95	□ Daytime Running Lights (Canada Only)	104
□ Programming The Remote Keyless Transmitter For The Memory Feature	96	□ Lights-On Reminder	105
□ Easy Entry/Exit Seat (Available With Memory Seat Only)	97	□ Headlight Time Delay	105
■ Adjustable Pedals — If Equipped	98	□ Fog Lights — If Equipped	105
■ To Open And Close The Hood	99	□ Turn Signals	105
■ Lights	100	□ Highbeam/Lowbeam Select Switch	106
□ Overhead Console Map/Reading Lights	100	□ Flash To Pass	106
□ Interior Lights	101	■ Windshield Wipers And Washers	106

<ul style="list-style-type: none"> <input type="checkbox"/> Windshield Washers 107 <input type="checkbox"/> Rain Sensing Wipers—If Equipped 107 <input type="checkbox"/> Mist Feature 108 <input type="checkbox"/> Headlights On With Wipers (Available With Auto Headlights Only) 108 <input type="checkbox"/> Windshield Wiper Operation 109 <input type="checkbox"/> Intermittent Wiper System 109 <input type="checkbox"/> Adding Washer Fluid 109 ■ Headlight Washers — If Equipped 110 <ul style="list-style-type: none"> <input type="checkbox"/> Adding Washer Fluid 110 ■ Tilt/Telescoping Steering Column 111 ■ Power Tilt/Telescoping Steering Column — If Equipped 112 ■ Traction Control System (TCS) — If Equipped 113 ■ Rear Park Assist System — If Equipped 114 ■ Brake Assist System (BAS) — If Equipped 116 	<ul style="list-style-type: none"> ■ Electronic Stability Program (ESP) — If Equipped 117 <ul style="list-style-type: none"> <input type="checkbox"/> Synchronizing ESP 119 ■ Electronic Speed Control 119 <ul style="list-style-type: none"> <input type="checkbox"/> To Activate 120 <input type="checkbox"/> To Set At A Desired Speed 120 <input type="checkbox"/> To Deactivate 120 <input type="checkbox"/> To Resume Speed 120 <input type="checkbox"/> To Vary The Speed Setting 120 <input type="checkbox"/> To Accelerate For Passing 121 ■ Overhead Console — If Equipped 122 <ul style="list-style-type: none"> <input type="checkbox"/> Courtesy/Reading Lights 122 <input type="checkbox"/> Sunglasses Storage 122 ■ Garage Door Opener — If Equipped 123 <ul style="list-style-type: none"> <input type="checkbox"/> Programming HomeLink 124 <input type="checkbox"/> Canadian Programming/Gate Programming . . 126
---	--

66 UNDERSTANDING THE FEATURES OF YOUR VEHICLE

□ Using HomeLink	127	□ Ignition Off Operation	131
□ Erasing HomeLink Buttons	127	□ Sunroof Fully Closed	131
□ Reprogramming a Single HomeLink Button	127	■ Electrical Power Outlets	131
□ Security	128	□ Electrical Outlet Use With Engine Off	133
■ Power Sunroof — If Equipped	128	■ Cup Holders	133
□ Opening Sunroof - Express	129	□ Front Seat Cup Holders — Standard	133
□ Closing Sunroof - Express	129	□ Front Seat Cup Holders — 300 Touring And 300C Models	134
□ Pinch Protect Feature	129	□ Rear Seat Cup Holders	134
□ Pinch Protect Override	130	■ Storage	135
□ Venting Sunroof - Express	130	□ Console Features	135
□ Sunshade Operation	130	□ Cargo Tie-Down Hooks	135
□ Wind Buffeting	130	■ Load Leveling System — If Equipped	136
□ Sunroof Maintenance	130		

MIRRORS

Inside Day/Night Mirror

Adjust the mirror to center on the view through the rear window. A two point pivot system allows for horizontal and vertical adjustment of the mirror.

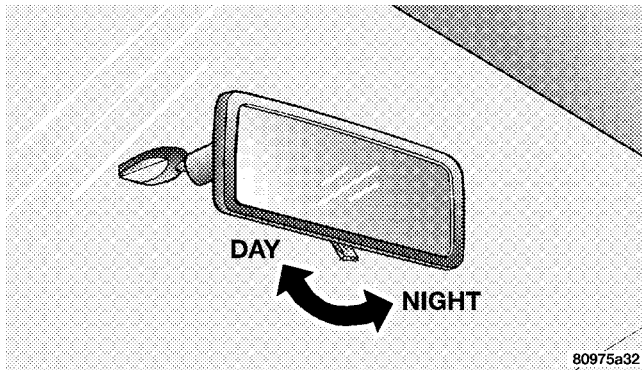

Adjusting Rearview Mirror

Annoying headlight glare can be reduced by moving the small control under the mirror to the night position (toward rear of vehicle). The mirror should be adjusted while set in the day position (toward windshield).

Automatic Dimming Inside Mirror — If Equipped

If the switch is in the “AUTO” position the mirror will automatically adjust for annoying headlight glare from vehicles behind you. The mirror will normally be in the “AUTO” mode unless “OFF” is pressed on the switch at the base of the mirror. A green light in the base of the mirror will illuminate to indicate when this feature is on.

3

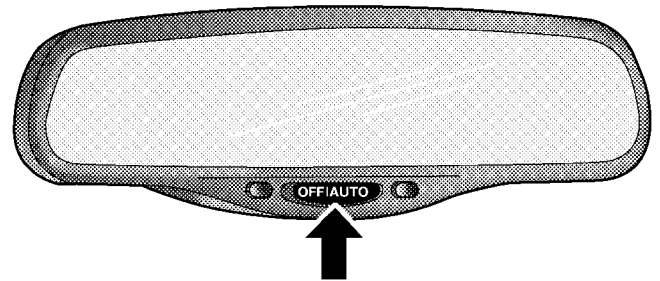

Automatic Dimming Mirror

CAUTION!

To avoid damage to the mirror during cleaning, never spray any cleaning solution directly onto the mirror. Apply the solution onto a clean cloth and wipe the mirror clean.

Driver's Side Outside Mirror Auto Dimmer — If Equipped

The driver's side outside mirror automatically adjusts for annoying headlight glare from vehicles behind you. This feature can be turned on or off by pressing the button at the base of the Inside Rearview Mirror.

Tilt in Reverse Feature — If Equipped

The "Tilt in Reverse" feature tilts the outside rearview mirrors down when the vehicle is shifted into REVERSE with the ignition switch in the ON position. This feature provides the customer with a better view of the ground and vehicle in the area of the rear tires when backing up. The mirrors move back to their previous position when the vehicle is shifted out of REVERSE. This feature is disabled from the factory, but can be enabled by the

electronic vehicle information center (EVIC). Refer to "Electronic Vehicle Information Center (EVIC) — Personal Settings" for details.

Exterior Mirrors Folding Feature — If Equipped

Some models have exterior mirrors that are hinged and may move either forward or rearward to resist damage. The hinges have three detent positions; full forward, full rearward, and normal.

Outside Mirror — Driver's Side

Adjust the outside mirror to center on the adjacent lane of traffic, with a slight overlap of the view obtained on the inside mirror.

Outside Mirror — Passenger's Side

Adjust the convex outside mirror so you can just see the side of your vehicle in the portion of the mirror closest to the vehicle. This type of mirror will give a much wider view to the rear, and especially of the lane next to your vehicle.

WARNING!

Vehicles and other objects seen in the right side convex mirror will look smaller and farther away than they really are. Relying too much on your right side mirror could cause you to collide with another vehicle or other object.

Use your inside mirror when judging the size or distance of a vehicle seen in this convex mirror.

Power Remote-Control Mirrors

The power mirror switch is located on the driver's door trim panel next to the power door lock switch. A rotary knob selects the left mirror, right mirror, or off position.

After selecting a mirror move the knob in the same direction you want the mirror to move. Use the center off position to guard against accidentally moving a mirror position.

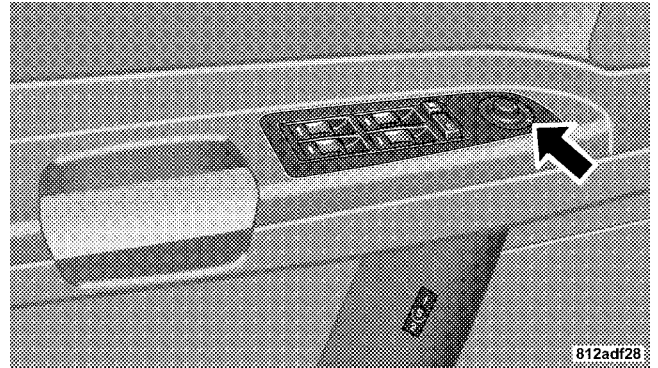
**Power Mirror Controls**

NOTE: For vehicles equipped with Driver Memory Seat, you can use your remote keyless entry transmitter or the memory switch on the driver's door panel to return the power mirrors to pre-programmed positions. Refer to "Driver Memory Seat" in this section for details.

Heated Remote Control Mirrors — If Equipped

These mirrors are heated to melt frost or ice. This feature is activated whenever you turn on the Rear Window Defrost.

Illuminated Vanity Mirrors — If Equipped

An illuminated vanity mirror is on the sun visor. To use the mirror, rotate the sun visor down and swing the mirror cover upward. The light turns on automatically. Closing the mirror cover turns off the lights.

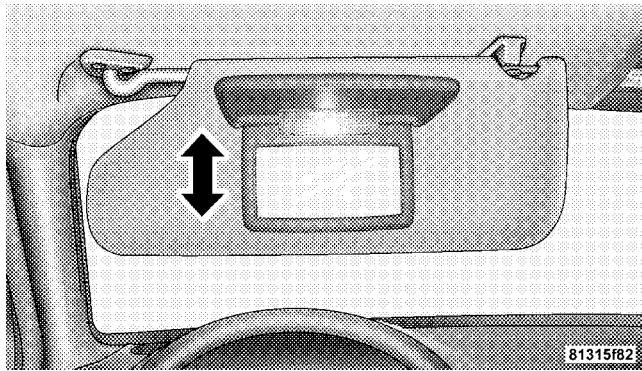

Illuminated Vanity Mirror

HANDS-FREE COMMUNICATION (UConnect™) — IF EQUIPPED

UConnect™ is a voice-activated, hands-free, in-vehicle communications system. UConnect™ allows you to dial a phone number with your cellular phone using simple voice commands (e.g., "Call" ... "Mike" ... "Work" or "Dial" ... "248-555-1212"). Your cellular phone's audio is transmitted through your vehicle's audio system; the system will automatically mute your radio when using the UConnect™ system.

NOTE: The UConnect™ system use requires a cellular phone equipped with the Bluetooth "Hands-Free Profile," version 0.96 or higher. See www.chrysler.com/uconnect for supported phones.

UConnect™ allows you to transfer calls between the system and your cellular phone as you enter or exit your vehicle, and enables you to mute the system's microphone for private conversation.

The UConnect™ phonebook enables you to store up to 32 names and four numbers per name. Each language has a separate 32 name phonebook accessible only in that language. This system is driven through your Bluetooth™ Hands-Free profile cellular phone. UConnect™ features Bluetooth™ technology - the global standard that enables different electronic devices to connect to each other without wires or a docking station, so UConnect works no matter where you stow your cellular phone (be it your purse, pocket, or briefcase), as long as your phone is turned on and has been paired to the vehicle's UConnect™ system. The UConnect™ system allows up to seven cellular phones to be linked to system. Only one linked (or paired) cellular phone can be used with the system at a time. The system is available in English, Spanish, or French languages (as equipped).

The rearview mirror contains the microphone for the system and the control buttons that will enable you to access the system.

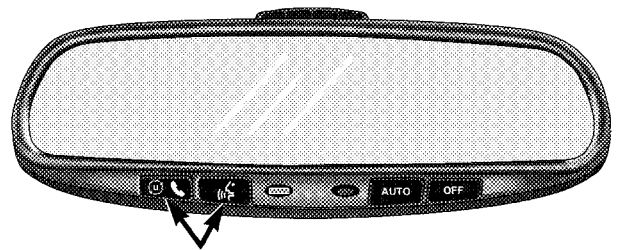

3

8105b20d

UConnect™ Switches

The UConnect™ system can be used with any Hands-Free Profile certified Bluetooth™ cellular phone. See www.chrysler.com/uconnect for supported phones. If your cellular phone supports a different profile (e.g., Headset Profile), you may not be able to use any UConnect™ features. Refer to your cellular service provider or the phone manufacturer for details.

The UConnect™ system is fully integrated with the vehicle's audio system. The volume of the UConnect™

system can either be adjusted from the radio volume control knob, or from the steering wheel radio control (right switch), if so equipped.

The radio display will be used for visual prompts from the UConnect™ system such as "CELL" or caller ID on certain radios.

Operations

Voice commands can be used to operate the UConnect™ system and to navigate through the UConnect™ menu structure. Voice commands are required after most UConnect™ system prompts. You will be prompted for a specific command and then guided through the available options.

- Prior to giving a voice command, one must wait for the voice on beep, which follows the "Ready" prompt or another prompt.
- For certain operations, compound commands can be used. For example, instead of saying "Setup" and then "Phone Pairing," the following compound command can be said: "Setup Phone Pairing."

- For each feature explanation in this section, only the combined form of the voice command is given. You can also break the commands into parts and say each part of the command, when you are asked for it. For example, you can either use the combined form voice command "Phonebook New Entry," or you can break the combined form command into two voice commands: "Phonebook" and "New Entry." Please remember, the UConnect™ system works best when you talk in a normal conversational tone, as if speaking to someone sitting eight feet away from you.

Voice Command Tree

Refer to "Voice Tree" at the end of this section.

Help Command

If you need assistance at any prompt or if you want to know what your options are at any prompt, say "Help" following the voice on beep. The UConnect™ system will play all the options at any prompt if you ask for help.

To activate the UConnect™ system from idle, simply press the 'Phone' button and follow audible prompts for directions. All UConnect™ system sessions begin with a press of the 'Phone' button on the mirror.

Cancel Command

At any prompt, after the voice on beep, you can say "Cancel" and you will be returned to the main menu. However, in a few instances the system will take you back to the previous menu.

Pair (Link) UConnect™ System to a Cellular Phone
To begin using your UConnect™ system, you must pair your compatible Bluetooth™ enabled cellular phone.

NOTE: The UConnect™ system use requires a cellular phone equipped with the Bluetooth "Hands-Free Profile," version 0.96 or higher. See www.chrysler.com/uconnect for supported phones.

To complete the pairing process, you will need to reference your cellular phone owner's manual. One of the following vehicle specific websites may also provide detailed instructions for pairing with the brand of phone that you have:

NOTE:

- www.chrysler.com/uconnect
- www.dodge.com/uconnect

- www.jeep.com/uconnect

The following are general phone to UConnect™ System pairing instructions:

- Press the 'Phone' button to begin.
- After the "Ready" prompt and the following beep, say "Setup Phone Pairing."
- When prompted, after the voice on beep, say "Pair a Phone."
- You will be asked to say a four-digit pin number which you will later need to enter into your cellular. You can enter any four-digit pin number. You will not need to remember this pin number after the initial pairing process.
- The UConnect™ system will then prompt you to begin the cellular phone pairing process on your cellular phone. Before attempting to pair phone, please see your cellular phone's user manual (Bluetooth section) for instructions on how to complete this step.

74 UNDERSTANDING THE FEATURES OF YOUR VEHICLE

- For identification purposes, you will be prompted to give the UConnect™ system a name for your cellular phone. Each cellular phone that is paired should be given a unique phone name.
- You will then be asked to give your cellular phone a priority level between 1 and 7, 1 being the highest priority. You can pair up to seven cellular phones to your UConnect™ system. However, at any given time, only one cellular phone can be in use, connected to your UConnect™ System. The priority allows the UConnect™ system to know which cellular phone to use if multiple cellular phones are in the vehicle at the same time. For example, if priority 3 and priority 5 phones are present in the vehicle, the UConnect™ system will use the priority 3 cellular phone when you make a call. You can select to use a lower priority cellular phone at any time (refer to "Advanced Phone Connectivity").

Dial by Saying a Number

- Press the 'Phone' button to begin.

- After the "Ready" prompt and the following beep, say "Dial."
- System will prompt you to say the number you want call.
- For example, you can say "234-567-8901." The phone number that you enter must be of valid length and combination. The UConnect™ limits the user from dialing invalid combination of numbers. For example, 234-567-890 is nine digits long, which is not a valid phone number - the closest valid phone number has ten digits.
- The UConnect™ system will confirm the phone number and then dial. The number will appear in the display of certain radios.

Call by Saying a Name

- Press the "Phone" button to begin.
- After the "Ready" prompt and the following beep, say "Call."
- System will prompt you to say the name of the person you want call.

- After the "Ready" prompt and the following beep, say the name of the person you want to call. For example, you can say "John Doe," where John Doe is a previously stored name entry in the UConnect™ phonebook. Refer to "Add Names to Your UConnect™ Phonebook," to learn how to store a name in the phonebook.
- The UConnect™ system will confirm the name and then dial the corresponding phone number, which may appear in the display of certain radios.

Add Names to Your UConnect™ Phonebook

NOTE: Adding names to phonebook is recommended when vehicle is not in motion.

- Press the "Phone" button to begin.
- After the "Ready" prompt and the following beep, say "Phonebook New Entry."
- When prompted, say the name of the new entry. Use of long names helps the voice recognition and is recommended. For example, say "Robert Smith" or "Robert" instead of "Bob."

- When prompted, enter the number designation (e.g.: "Home," "Work," "Mobile," or "Pager"). This will allow you to store multiple numbers for each phonebook entry, if desired.
- When prompted, recite the phone number for the phonebook entry that you are adding.

After you are finished adding an entry into the phonebook, you will be given the opportunity to add more phone numbers to the current entry or to return to the main menu.

The UConnect™ system will allow you to enter up to 32 names in the phonebook with each name having up to four associated phone numbers and designations. Each language has a separate 32 name phonebook accessible only in that language.

Edit Entries in the UConnect™ Phonebook

NOTE: Editing phonebook entries is recommended when vehicle is not in motion.

- Press the 'Phone' button to begin.

- After the "Ready" prompt and the following beep, say "Phonebook Edit."
- You will then be asked for the name of the phonebook entry that you wish to edit.
- Next, choose the number designation (home, work, mobile, or pager) that you wish to edit.
- When prompted, recite the new phone number for the phonebook entry that you are editing.

After you are finished editing an entry in the phonebook, you will be given the opportunities to edit another entry in the phonebook, call the number you just edited, or return to the main menu.

"Phonebook Edit" can be used to add another phone number to a name entry that already exists in the phonebook. For example, the entry John Doe may have a mobile and a home number, but you can add John Doe's work number later using the "Phonebook Edit" feature.

Delete Entries in the UConnect™ Phonebook

NOTE: Editing phonebook entries is recommended when vehicle is not in motion.

- Press the 'Phone' button to begin.
- After the "Ready" prompt and the following beep, say "Phonebook Delete."
- After you enter the Phonebook Delete menu, you will then be asked for the name of the entry that you wish to delete. You can either say the name of a phonebook entry that you wish to delete or you can say "List Names" to hear a list of the entries in the phonebook from which you choose. To select one of the entries from the list, press the "Voice Recognition" button while the UConnect™ system is playing the desired entry and say "Delete."
- After you enter the name, the UConnect™ system will ask you which designation you wish to delete: home, work, mobile or pager. Say the designation you wish to delete.
- Note that only the phonebook entry in the current language is deleted.

After confirmation, the phonebook entries will be deleted. Note that only the phonebook in the current language is deleted.

Delete All Entries in the UConnect™ Phonebook

- Press the 'Phone' button to begin.
- After the "Ready" prompt and the following beep, say "Phonebook Erase All."
- The UConnect™ system will ask you to verify that you wish to delete all the entries from the phonebook.
- After confirmation, the phonebook entries will be deleted.

List All Names in the UConnect™ Phonebook

- Press the 'Phone' button to begin.
- After the "Ready" prompt and the following beep, say "Phonebook List Names."
- The UConnect™ system will play the names of all the phonebook entries.
- To call one of the names in the list, press the "Voice Recognition" button during the playing of the desired name and say "Call." NOTE: the user can also exercise "Edit" or "Delete" operations at this point.

- The UConnect™ system will then prompt you as to number designation you wish to call.
- The selected number will be dialed.

Phone Call Features

The following features can be accessed through the UConnect™ system if the feature(s) are available on your cellular service plan. For example, if your cellular service plan provides three-way calling, this feature can be accessed through the UConnect™ system. Check with your cellular service provider for the features that you have.

Answer or Reject an Incoming Call - No Call Currently in Progress

When you receive a call on your cellular phone, the UConnect™ system will interrupt the vehicle audio system, if on, and will ask if you would like to answer the call. To reject the call, press and hold the 'Phone' button until you hear a single beep indicating that the incoming call was rejected.

Answer or Reject an Incoming Call - Call Currently in Progress

If a call is currently in progress and you have another incoming call, you will hear the same network tones for call waiting that you normally hear when using your cell phone. Press the 'Phone' button to place the current call on hold and answer the incoming call. NOTE: The UConnect™ system compatible phones in market today do not support rejecting an incoming call when another call is in progress. Therefore, the user can only either answer an incoming call or ignore it.

Making a Second Call while Current Call in Progress

To make a second call while you are currently in a call, press the 'Voice Recognition' button and say "Dial" or "Call" followed by the phone number or phonebook entry you wish to call. The first call will be on hold while the second call is in progress. To go back to the first call, refer to "Toggling Between Calls." To combine two calls, refer to "Conference Call."

Place/Retrieve a Call from Hold

To put a call on hold, press the 'Phone' button until you hear a single beep which will indicate that the call has been placed on hold. To bring the call back from hold, press and hold the 'Phone' button until you hear a single beep.

Toggling Between Calls

If two calls are in progress (one active and one on hold), press the 'Phone' button until you hear a single beep indicating that the active and hold status of the two calls have switched. Only one call can be placed on hold at one time.

Conference Call

When two calls are in progress (one active and one on hold), press and hold the 'Phone' button until you hear a double beep indicating that the two calls have been joined into one conference call.

Three-Way Calling

To initiate three-way calling, press the 'Voice Recognition' button while a call is in progress and make a second phone call as described under "Making a Second Call while Current Call in Progress." After the second call has

established, press and hold the 'Phone' button until you hear a double beep indicating that the two calls have been joined into one conference call.

Call Termination

To end a call in progress, momentarily press the 'Phone' button. Only the active call(s) will be terminated and if there is a call on hold, it will become the new active call.

Redial

- Press the 'Phone' button to begin.
- After the "Ready" prompt and the following beep, say "Redial."
- The UConnect™ system will call the last number that was dialed on your cellular phone. Note: this may not be the last number dialed from the UConnect™ system.

Call Continuation

Call continuation is progression of a phone call on UConnect™ system after the vehicle ignition key has been switched to off. Call continuation functionality available on the vehicle can be any one of three types:

- After ignition key is switched off, a call can continue on the UConnect™ system either until the call ends or until the vehicle battery condition dictates cessation of the call on the UConnect™ system and transfer of the call to the mobile phone.
- After ignition key is switched to off, a call can continue on the UConnect™ system for certain duration, after which the call is automatically transferred from the UConnect™ system to the mobile phone.
- An active call is automatically transferred to the mobile phone after ignition key is switched to off.

UConnect™ System Features

Language Selection

To change the language that the UConnect™ system is using,

- Press the 'Phone' button to begin.
- After the "Ready" prompt and the following beep, say the name of the language you wish to switch to (English, Espanol, or Francais, if so equipped).

- Continue to follow the system prompts to complete language selection.

After selecting one of the languages, all prompts and voice commands will be in that language.

NOTE: After every UConnect™ language change operation, only the language specific 32 name phonebook is usable. The paired phone name is not language specific and usable across all languages.

Emergency Assistance

If you are in an emergency and the mobile phone is reachable:

- Pick up the phone and manually dial the emergency number for your area.

If the phone is not reachable and the UConnect™ system is operational, you may reach the emergency number as follows:

- Press the 'Phone' button to begin.
- After the "Ready" prompt and the following beep, say "Emergency" and the UConnect™ system will instruct

the paired cellular phone to call the emergency number. This feature is only supported in the USA.

NOTE: The emergency number dialed is based on the Country where the vehicle is purchased (911 for USA and Canada and 060 for Mexico). The number dialed may not be applicable with the available cellular service and area.

The UConnect™ system does slightly lower your chances of successfully making a phone call as to that for the cell phone directly.

Your phone must be turned on and paired to the UConnect™ system to allow use of this vehicle feature in emergency situations when the cell phone has network coverage and stays paired to the UConnect™ system.

Towing Assistance

If you need towing assistance,

- Press the 'Phone' button to begin.
- After the "Ready" prompt and the following beep, say "Towing Assistance."

NOTE: The Towing Assistance number dialed is based on the Country where the vehicle is purchased (1-800-528-2069 for USA, 1-877-213-4525 for Canada, 55-14-3454 for Mexico city and 1-800-712-3040 for outside Mexico city in Mexico).

Please refer to the 24-Hour "Towing Assistance" coverage details in the Warranty information booklet and on the 24-Hour Towing Assistance Card.

Paging

To learn how to page, refer to "Working with Automated Systems." Paging works properly except for pagers of certain companies which time-out a little too soon to work properly with the UConnect™ system.

Voice Mail Calling

To learn how to access your voice mail, refer to "Working with Automated Systems."

Working with Automated Systems

This method is designed to be used in instances where one generally has to press numbers on the cellular phone keypad while navigating through an automated telephone system.

You can use your UConnect™ system to access a voice-mail system or an automated service, such as, paging service or automated customer service. Some services require immediate response selection, in some instances, that may be too quick for use of UConnect™ system.

When calling a number with your UConnect™ system that normally requires you to enter in a touch-tone sequence on your cellular phone keypad, you can push the 'Voice Recognition' button and say the sequence you wish to enter followed by the word "Send." For example, if required to enter your pin number followed with a pound 3 7 4 6 #, you can press the 'Voice Recognition' button and say "3 7 4 6 # Send." Saying a number, or sequence of numbers, followed by "Send" is also to be used to navigate through an automated customer service center menu structure and to leave a number on a pager.

Barge In - Overriding Prompts

The 'Voice Recognition' button can be used when you wish to skip part of a prompt and issue your voice recognition command immediately. For example, if a prompt is playing "Would you like to pair a phone, clear

a...," you could press the 'Voice Recognition' button and say "Pair a Phone" to select that option without having to listen to the rest of the voice prompt.

Turning Confirmation Prompts On/Off

Turning confirmation prompts off will stop the system from confirming your choices (e.g. the UConnect™ system will not repeat a phone number before you dial it).

- Press the 'Phone' button to begin.
- After the "Ready" prompt and the following beep, say "Setup Confirmations." The UConnect™ system will play the current confirmation prompt status and you will be given the choice to change it.

Phone and Network Status Indicators

If available on the radio and/or on a premium display such as the instrument panel cluster, and supported by your cell phone, the UConnect™ system will provide notification to inform you of your phone and network status when you are attempting to make a phone call using UConnect™. The status is given for roaming network signal strength, phone battery strength, etc.

Dialing Using the Cellular Phone Keypad

You can dial a phone number with your cellular phone keypad and still use the UConnect™ system (while dialing via the cell phone keypad, the user must exercise caution and take precautionary safety measures). By dialing a number with your paired Bluetooth™ cellular phone, the audio will be played through your vehicle's audio system. The UConnect™ system will work the same as if you dial the number using voice recognition.

NOTE: Certain brands of mobile phones do not send the dial ring to the UConnect™ system to play it on the vehicle audio system, so you will not hear it. Under this situation, after successfully dialing a number, the user may feel that the call did not go through even though the call is in progress. Once your call is answered, you will hear the audio.

Mute/Un-mute (Mute off)

When you mute the UConnect™ system, you will still be able to hear the conversation coming from the other party, but the other party will not be able to hear you. In order to mute the UConnect™ system:

- Press the 'Voice Recognition' button.

- After the "Ready" prompt and the following beep, say "Mute."

In order to un-mute the UConnect™ system:

- Press the 'Voice Recognition' button.
- After the "Ready" prompt and the following beep, say "Mute-off."

Information Service

When using AT&T Wireless Service, dialing to phone number "#121," you can access voice activated automated system to receive news, weather, stocks, traffic, etc. related information.

Advanced Phone Connectivity

Transfer Call to and from Cellular Phone

The UConnect™ system allows on going calls to be transferred to your cellular phone to the UConnect™ system without terminating the call. To transfer an ongoing call from your UConnect™ paired cellular phone to the UConnect™ system or vice-versa, press the 'Voice Recognition' button and say "Transfer Call."

Connect or Disconnect Link Between the UConnect™ System and Cellular Phone

Your cellular phone can be paired with many different electronic devices, but can only be actively "connected" with one electronic device at a time.

If you would like to connect or disconnect the Bluetooth™ connection between a UConnect™ paired cellular phone and the UConnect™ system, follow the instruction described in your cellular phone user's manual.

List Paired Cellular Phone Names

- Press the 'Phone' button to begin.
- After the "Ready" prompt and the following beep, say "Setup Phone pairing".
- When prompted, say "List Phones."
- The UConnect™ system will play the phone names of all paired cellular phones in order from the highest to the lowest priority. To "select" or "delete" a paired phone being announced, press the 'Voice recognition'

button and say "Select" or "Delete." Also, see the next two sections for an alternate way to "select" or "delete" a paired phone.

Select another Cellular Phone

This feature allows you to select and start using another phone with the UConnect™ system. The phone must have been previously paired to the UConnect™ system that you want to use it with.

- Press the 'Phone' button to begin.
- After the "Ready" prompt and the following beep, say "Setup Select Phone."
- The phone names along with priority numbers will be announced.
- When prompted say the priority number of the cellular phone you wish to select. You can also press the 'Voice Recognition' button anytime while the list is being played, then say the priority number of the phone that you wish to select.

- The selected phone will be used for the next phone call. If the selected phone is not available, the UConnect™ system will return to using the highest priority phone present in or near (approximately within 30 feet) the vehicle.

Delete UConnect™ Paired Cellular Phones

- Press the 'Phone' button to begin.
- After the "Ready" prompt and the following beep, say "Setup Phone Pairing."
- At the next prompt, say "Delete."
- The phone names along with priority numbers will be announced.
- When prompted say the priority number of the cellular phone you wish to delete. You can also press the 'Voice Recognition' button anytime while the list is being played and say the priority number of the phone you wish to delete.

Things You Should Know About Your UConnect™ System

Voice Recognition (VR)

- Always wait for the beep before speaking.
- Speak normally, without pausing, just as you would speak to a person sitting approximately eight (8) feet away from you.
- Make sure that no one other than you is speaking during a voice recognition period.
- Performance is maximized under:
 - low-to-medium blower setting,
 - low-to-medium vehicle speed,
 - low road noise,
 - smooth road surface,
 - fully closed windows,
 - dry weather condition.
- Even though the system is designed for users speaking in North American English, French, and Spanish accents, the system may not always work for some.
- When navigating through an automated system, such as, voice mail, or when sending a page, at the end of speaking the digit string, make sure to say "send."
- Storing names in phonebook when vehicle is not in motion is recommended.
- It is not recommended to store similar sounding names in the UConnect™ phonebook.
- UConnect™ phonebook name tag recognition rate is optimized for the voice of the person who stored the name in the phonebook.
- You can say "O" (letter "O") for "0" (zero). "800" must be spoken "eight-zero-zero."
- Even though international dialing for most number combinations is supported, some shortcut dialing number combinations may not be supported.

Far End Audio Performance

- Audio quality is maximized under:
 - low-to-medium blower setting,
 - low-to-medium vehicle speed,
 - low road noise,
 - smooth road surface,
 - fully closed windows, and
 - dry weather condition.
- Operation from driver seat.
- Performance, such as, audio clarity, echo, and loudness to a large degree, rely on the phone and network, and not the UConnect™ system.

- Echo at far end can sometime be reduced by lowering the in-vehicle audio volume.

Bluetooth Communication Link

Cellular phones have been found to occasionally lose connection to the UConnect™ system. When this happens, the connection can generally be re-established by switching the phone off/on. Your cell phone is recommended to remain in Bluetooth "on" mode.

Power-Up

After switching the ignition key from OFF to either ON or ACC position, or after a reset, you must wait at least five (5) seconds prior to using the system.

Voice Command Tree

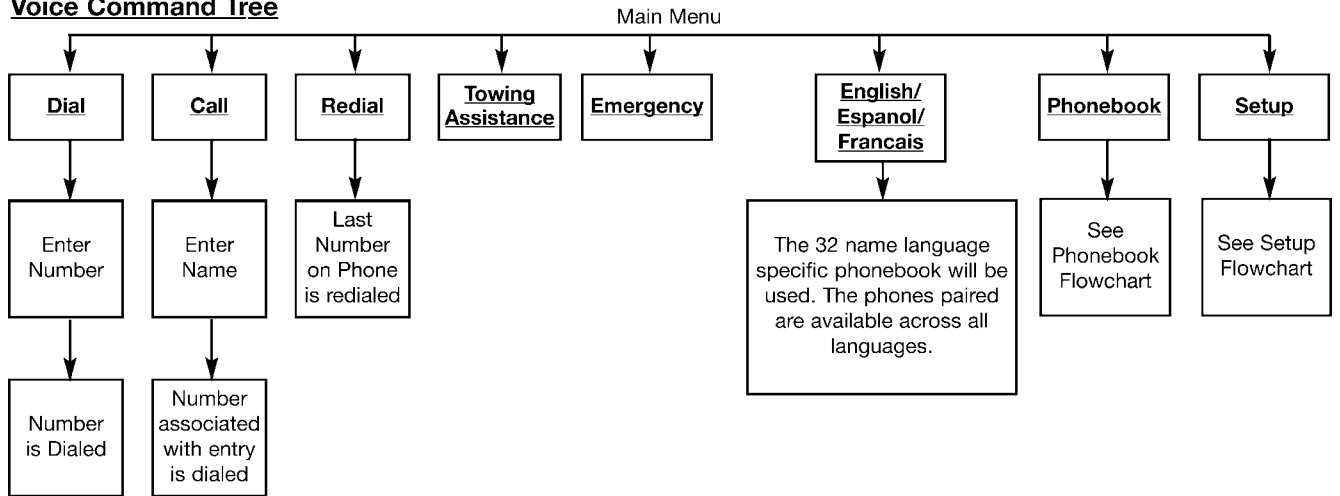

Note: Available Voice commands are shown in bold face and are underlined.

Voice Tree – Phonebook

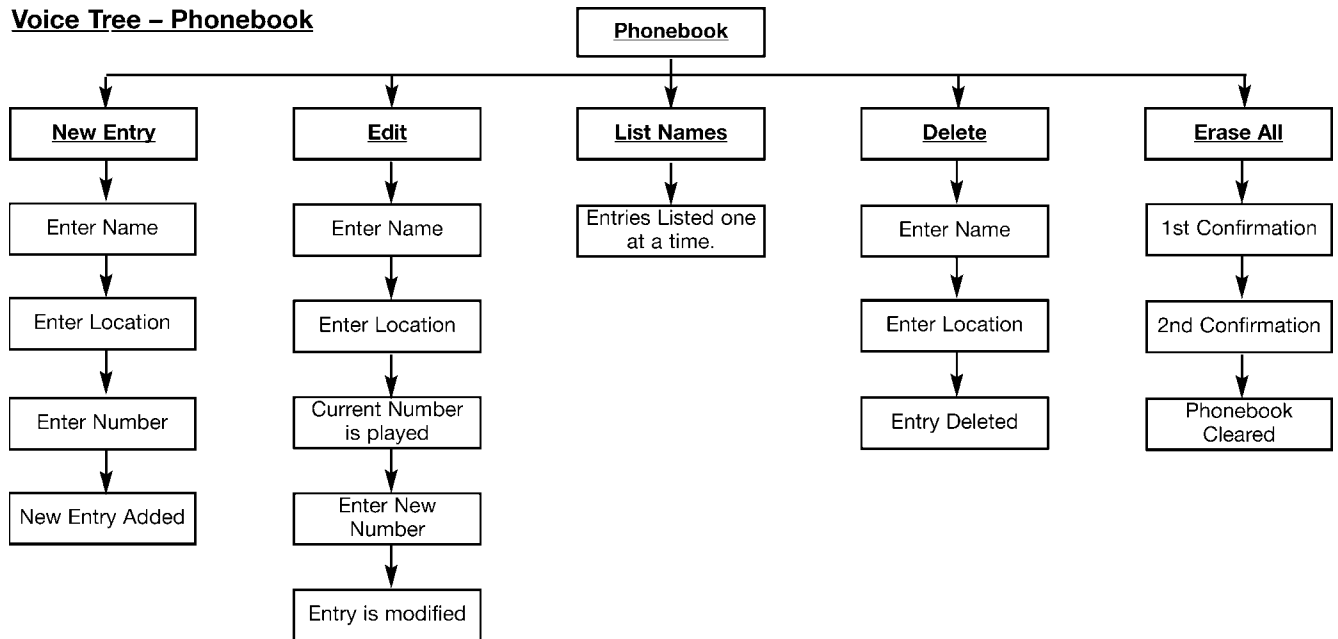

Note: Available Voice commands are shown in bold face and are underlined.

Voice Tree – Setup

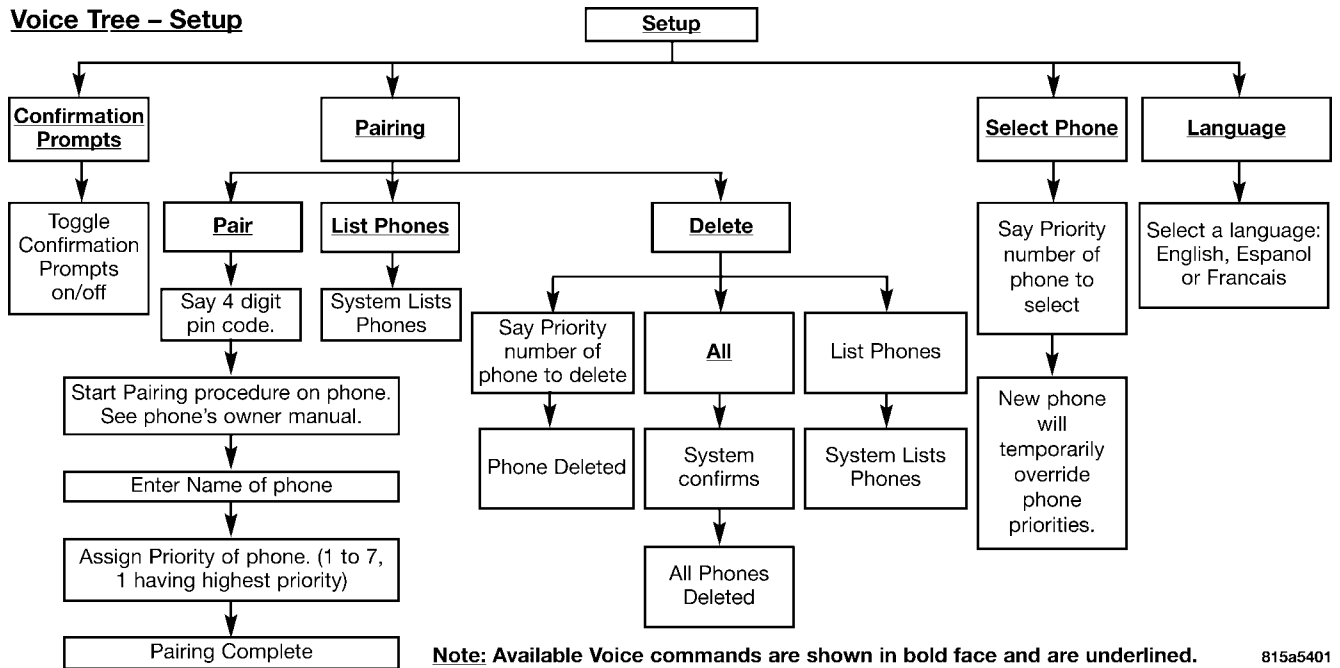

3

Note: Available Voice commands are shown in bold face and are underlined.

	North American English
Primary	Alternate(s)
Zero	Oh
Add location	Add new
All	All of them
Confirmation prompts	Confirmations prompts
Delete a name	Delete
Language	Select language
List names	List all
List paired phones	List phones
Pager	Beeper
Phone pairing	Pairing
Phonebook	Phone book
Return to main menu	Return. Main menu
Select phone	select
Set up	Phone settings phone set up

SEATS

Power Seats

The power seat switch is on the outboard side of the seat near the floor. Use this switch to move the driver's seat up or down, forward or rearward, or to tilt the seat. The passenger's seat will move up or down, forward or rearward.

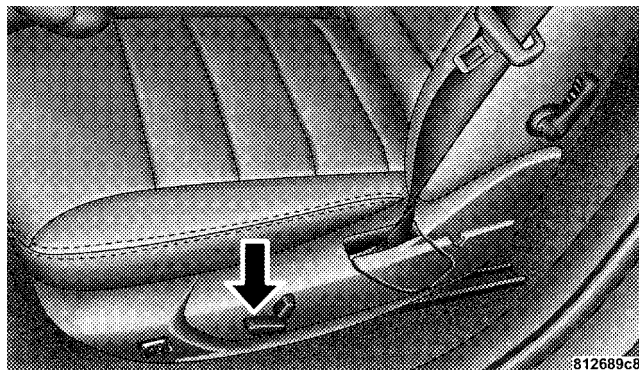

Power Seat Switch

WARNING!

Adjusting a seat while the vehicle is moving is dangerous. The sudden movement of the seat could cause you to lose control. The seat belt might not be properly adjusted and you could be injured. Adjust the seat only while the vehicle is parked.

CAUTION!

Do not place any article under a power seat as it may cause damage to the seat controls.

Power Reclining Seats

The recliner control for both front seats is located on the outboard side of the seat.

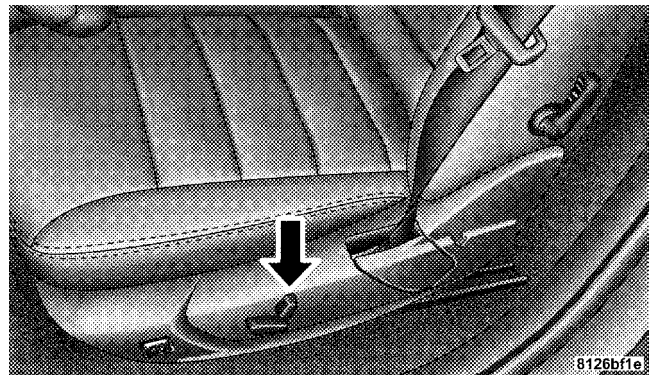

Power Seat Recline Switch

WARNING!

Do not ride with the seatback reclined so that the shoulder belt is no longer resting against your chest. In a collision you could slide under the seat belt and be seriously or even fatally injured. Use the recliner only when the vehicle is parked.

Lumbar Support

This feature allows you to increase or decrease the amount of lumbar support. Turn the control lever forward to increase and rearward to decrease the desired amount of lumbar support.

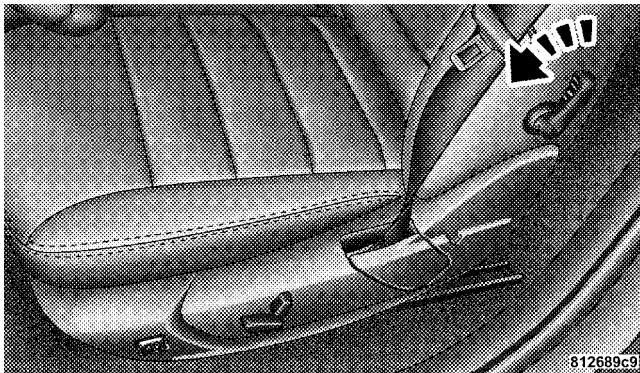

Lumbar Support Control Lever

Heated Seats — If Equipped

Heated seats, which are available only with leather upholstery, provide comfort and warmth on cold days and can help soothe sore muscles and backs. The heaters provide the same heat level for both cushion and back.

The front driver's and passenger seats are heated. The controls for each heater are located near the bottom center of the instrument panel. After turning on the ignition, you can choose from High, Off, or Low heat settings. Amber LEDs in the top portion of each switch indicate the level of heat in use. Two LEDs are illuminated for high, one for low, and none for off. Pressing the switch once will select high-level heating.

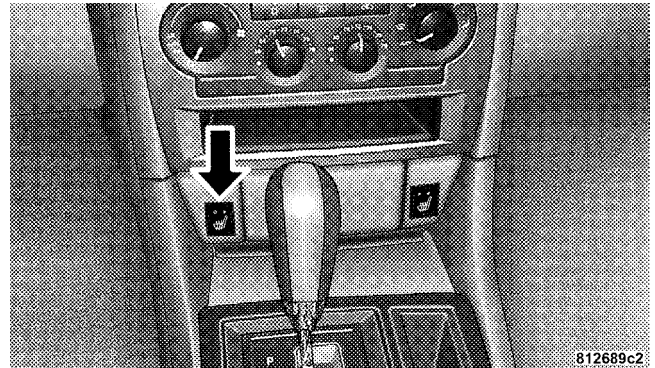

Heated Seat Switch

Pressing the switch a second time will select low-level heating. Pressing the switch a third time will shut the heating elements off.

When high-temperature heating is selected, the heaters provide a boosted heat level during the first four minutes of operation after heating is activated. The heat output then drops to the normal high-temperature level. If high-level heating is selected, the system will automatically switch to the low level after two hours of continuous operation. At that time, the number of illuminated LEDs changes from two to one, indicating the change. Operation on the low setting also turns off automatically after two hours.

NOTE: Once a heat setting is selected, heat will be felt within two to five minutes.

WARNING!

Persons who are unable to feel pain to the skin because of advanced age, chronic illness, diabetes, spinal cord injury, medication, alcohol use, exhaustion or other physical condition must exercise care when using the seat heater. It may cause burns even at low temperatures, especially if used for long periods of time.

Do not place anything on the seat that insulates against heat, such as a blanket or cushion. This may cause the seat heater to overheat.

Head Restraints

Head restraints can reduce the risk of whiplash injury in the event of impact from the rear. Adjustable restraints should be adjusted so that the upper edge is as high as practical.

The head restraints have a locking button which must be pushed in to lower the head restraint. The restraints may be raised without pushing in the button.

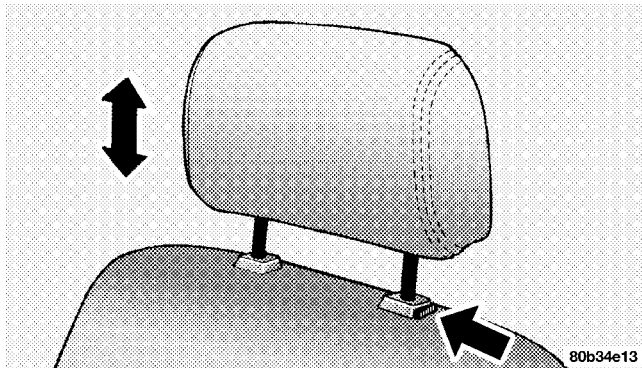

Adjustable Head Restraint

Folding Rear Seat

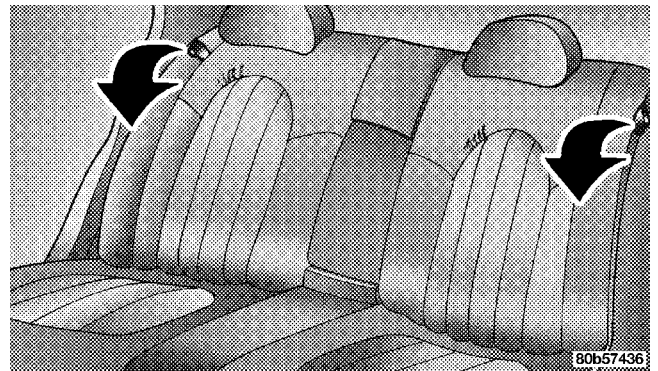

Folding Rear Seats

The rear seatbacks can be folded forward to provide an additional storage area. Pull on the loops shown in the illustration to fold down either or both seatbacks. These loops can be tucked away when not in use.

When the seat back is folded to the upright position make sure it is latched by strongly pulling on the top of the seat back above the seat strap.

WARNING!

The cargo area in the rear of the vehicle (with the rear seatbacks in the locked-up or folded down position) should not be used as a play area by children when the vehicle is in motion. They could be seriously injured in an accident. Children should be seated and using the proper restraint system.

DRIVER MEMORY SEAT

This feature allows the driver to store up to two different memory profiles for easy recall through a memory switch. Each memory profile contains desired driver seat, side mirror, adjustable pedals (if equipped), and power tilt and telescopic steering column (if equipped) position settings, and a set of desired radio station presets.

The memory switch is located on the driver's door panel. The switch contains an (S) button to activate the memory save function. It also contains a rocker switch labeled with the number (1) and the number (2). The rocker

switch allows the driver to recall either of two pre-programmed memory profiles by pressing the appropriate side of the switch.

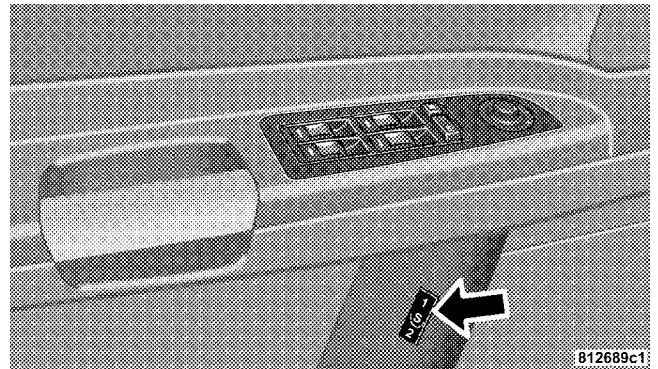

Memory Switch

To Set The Memory Feature Follow These Steps:

NOTE: Saving a new memory profile will erase an existing profile from memory.

1. Adjust all memory profile settings to desired preferences (i.e. seat, side mirror, adjustable pedals [if equipped], power tilt and telescopic steering column [if equipped], and radio station presets).
2. Press and release the Set (S) button on the memory switch, then press the side of the rocker switch labeled (1) within 5 seconds. The Electronic Vehicle Information Center (EVIC) — if equipped will display which memory position is being set.

If desired, a second memory profile can be stored into memory as follows:

1. Adjust all memory profile settings to desired preferences (i.e. seat, side mirror, adjustable pedals [if equipped], power tilt and telescopic steering column [if equipped], and radio station presets).
2. Press and release the Set (S) button on the memory switch, then press the side of the rocker switch labeled (2) within 5 seconds. The Electronic Vehicle Information Center (EVIC) — if equipped will display which memory position is being set.

NOTE: Memory profiles can be set without the vehicle in Park, but the vehicle must be in Park to recall a memory profile.

NOTE: The Recall Memory with Remote Key Unlock feature can be enabled through the Electronic Vehicle Information Center (EVIC) — if equipped. Refer to “Personal Settings (Customer Programmable Features)” under “Electronic Vehicle Information Center (EVIC)” in Section 4 of this manual for details.

Programming the Remote Keyless Transmitter for the Memory Feature

Your Remote Keyless Entry Transmitters can be programmed to recall one of two pre-programmed memory profiles by pressing the UNLOCK button on the Remote Keyless Entry Transmitter.

To program your transmitters, perform the following:

1. Remove key from ignition.
2. Select desired memory profile 1 or 2.

3. Press and release the Set (S) button on the memory switch, then press and release the side of the rocker switch labeled 1 or 2 accordingly. "Memory Profile Set" (1 or 2) will display in the instrument cluster on vehicles equipped with the Electronic Vehicle Information Center (EVIC).

4. Press and release the LOCK button on the transmitter within 10 seconds.

NOTE: Your transmitters can be unlinked to your memory settings by pressing the Set (S) button followed by the UNLOCK button on the transmitter in Step 4 above.

Easy Entry/Exit Seat (Available with Memory Seat Only)

This feature provides automatic driver seat positioning which will enhance driver mobility out of and into the vehicle.

The distance the seat is moved is dependent on the driver's seat location once the key is removed from the ignition.

- The seat cushion will move rearward about 2.4 inches (60 mm) if the starting position of the seat is greater than or equal to 3.5 inches (90 mm) forward of the rear seat stop when the key is removed from the ignition switch. The seat will return to its previously set position when the key is placed into the ignition and turned out of the LOCK position.

- The seat will move to the position located 1.2 inches (30 mm) forward of the rear stop if the starting position is between 2.4 inches to 3.5 inches (60 mm to 90 mm) forward of the rear stop when the key is removed from the ignition switch. The seat will return to its previously set position when the key is placed into the ignition and turned out of the LOCK position.

The Easy Entry/Easy Exit feature will be automatically disabled if the seat is already positioned closer than 2.4 inches (60 mm) forward of the rear stop. At this position there is no benefit to the driver by moving the seat for Easy Exit or Easy Entry.

Each stored memory setting will have an associated Easy Entry and Easy Exit position.

NOTE: The Easy Entry/Easy Exit feature is disabled when the vehicle is delivered from the factory. The Easy Entry/Easy Exit feature can be enabled or disabled through the programmable features in the Electronic Vehicle Information Center (EVIC). Refer to “Automatically Move Seat Back on Exit” under “Personal Settings (Customer Programmable Features)” under “Electronic Vehicle Information Center (EVIC)” in Section 4 of this manual for details.

ADJUSTABLE PEDALS — IF EQUIPPED

This feature allows both the brake and accelerator pedal to move toward or away from the driver to provide improved position with the steering wheel. The adjustable pedal system is designed to allow a greater range of driver comfort for steering wheel tilt and seat position. The switch is located on the front side of the driver’s seat cushion side shield.

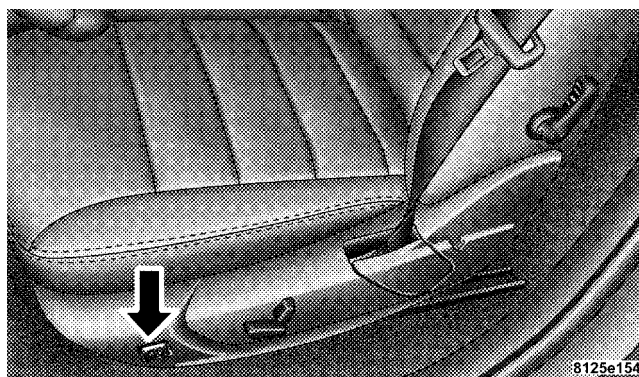

Adjustable Pedal Switch

Press the switch forward to move the pedals forward (toward the front of the vehicle).

Press the switch rearward to move the pedals rearward (toward the driver).

- The pedals can be adjusted with the ignition OFF.
- The pedals can be adjusted while driving.

- The pedals **cannot** be adjusted when the vehicle is in R (Reverse) or when the Speed Control is ON. One of the following messages will display in the Electronic Vehicle Information Center (EVIC) — if equipped if a pedal adjustment is attempted when the system is locked out: “Adjustable Pedal Disabled — Cruise Control Engaged” or “Adjustable Pedal Disabled — Vehicle In Reverse.”

NOTE: For vehicles equipped with Driver Memory Seat, you can use your remote keyless entry transmitter or the memory switch on the driver’s door panel to return the adjustable pedals to pre-programmed positions. Refer to “Driver Memory Seat” in this section for details.

CAUTION!

Do not place any article under the adjustable pedals or impede its ability to move as it may cause damage to the pedal controls. Pedal travel may become limited if movement is stopped by an obstruction in the adjustable pedal’s path.

TO OPEN AND CLOSE THE HOOD

Two latches must be released to open the hood. First, pull the hood release lever located under the left side of the instrument panel.

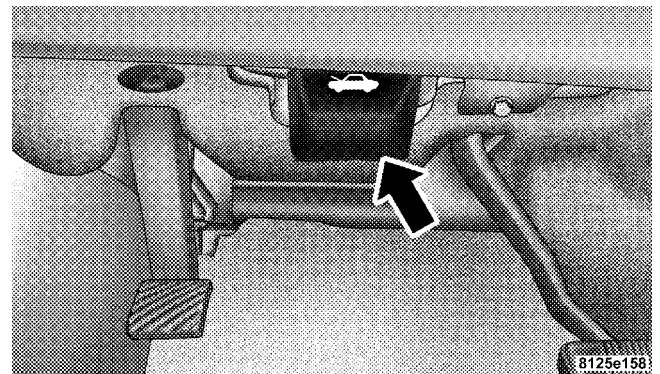

Hood Release Lever

Next, move to the outside of the vehicle and push the safety catch to the left. The safety catch is located under the center front edge of the hood.

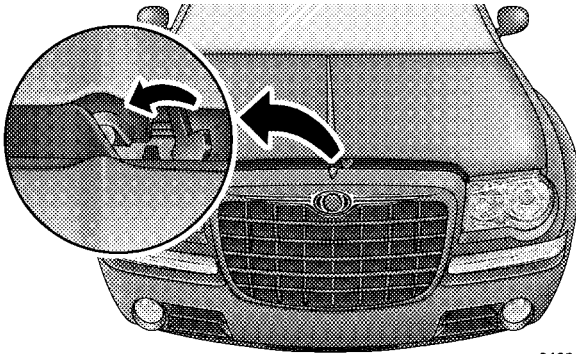

Hood Safety Catch

Use the hood prop rod (if equipped) to secure the hood in the open position.

To prevent possible damage, do not slam the hood to close it. Lower the hood until it is open approximately 6 inches (15 cm) and then drop it. This should secure both latches. Never drive your vehicle unless the hood is fully closed, with both latches engaged.

WARNING!

If the hood is not fully latched, it could fly up when the vehicle is moving and block your forward vision. You could have a collision. Be sure all hood latches are fully latched before driving.

LIGHTS

Overhead Console Map/Reading Lights

These lights are mounted between the sun visors on the overhead console. Each light is turned ON by pressing the lens. Press the lens a second time to turn the light OFF. The lights also turn on when a door is opened or the dimmer control is turned fully upward, past the second detent.

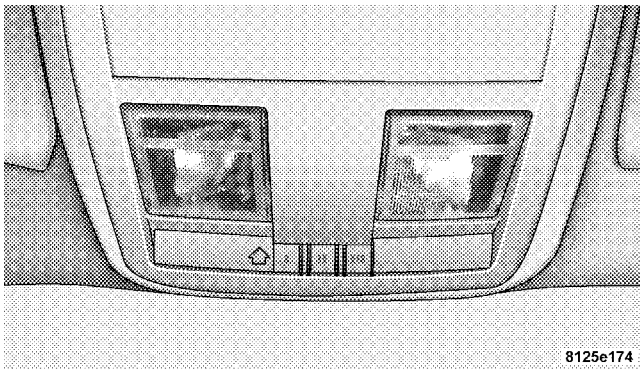

Overhead Console

Interior Lights

The interior lights come on when a door is opened.

To protect the battery, the interior lights will turn off automatically 10 minutes after the ignition switch is moved to the LOCK position. This will occur if the interior lights were switched on manually or are on because a door is open. This includes the glove box, but not the trunk light. To restore interior light operation, either turn the ignition switch ON or cycle the light switch.

Dimmer Control

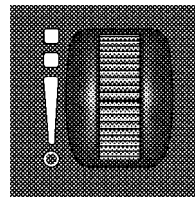

The dimmer control is part of the headlight switch, and is located on the left side of the instrument panel. With the parking lights or headlights on, rotating the dimmer control upward will increase the brightness of the instrument panel lights.

Dome Light Position

Rotate the dimmer control completely upward to the second detent to turn on the interior lights. The interior lights will remain on when the dimmer control is in this position.

Interior light Defeat (OFF)

Rotate the dimmer control to the extreme bottom "OFF" position. The interior lights will remain off when the doors are open.

Parade Mode (Daytime Brightness Feature)

Rotate the dimmer control upward to the first detent. This feature brightens all text displays such as the

odometer, Electronic Vehicle Information Center — if equipped, and radio when the parking lights or headlights are on.

Headlight Switch

The headlight switch is located on the left side of the instrument panel. This switch controls the operation of the headlights, parking lights, instrument panel lights, instrument panel light dimming, interior lights, and fog lights.

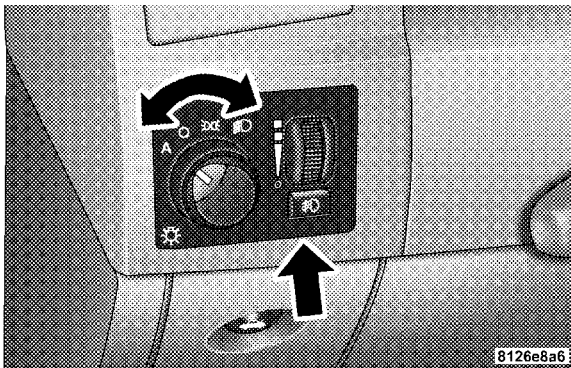

Headlight Switch

Multi-Function Lever

The multi-function lever controls the operation of the turn signals, headlight beam selection, and passing lights. The lever is located on the left side of the steering column.

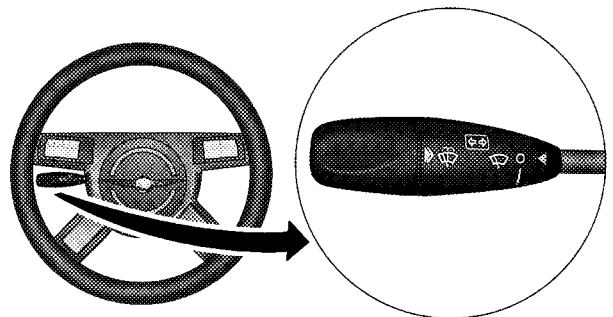

Multi-Function Lever

Headlights, Parking Lights, Instrument Panel Lights

Rotate the headlight switch clockwise to the first detent for parking light and instrument panel light operation. Turn to the second detent for headlight, park light and instrument panel light operation.

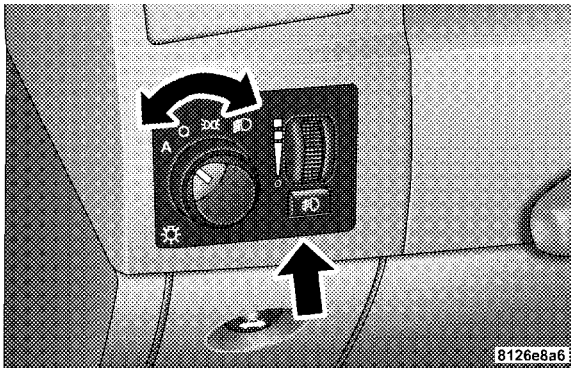

Headlight Switch

Automatic Headlights – If Equipped

This system automatically turns your headlights ON or OFF based on ambient light levels. To turn the system ON, rotate the headlight switch counter-clockwise to the AUTO (A) position. When the system is ON, the Headlight Time Delay feature is also ON. This means your headlights will stay ON for up to 90 seconds after you turn the ignition switch OFF. To turn the Automatic System OFF, move the headlight switch out of the AUTO (A) position.

NOTE: The engine must be running before the headlights will come ON in the Automatic mode.

Headlights On With Wipers (Available with Auto Headlights Only)

The headlights will turn on approximately 10 seconds after the wipers are turned on if the headlight switch is placed in the AUTO position. The headlights will also turn off when the wipers are turned off if they were turned on by this feature. This feature can be turned on or off using the Electronic Vehicle Information Center (EVIC) — If equipped. Refer to "Headlights On With Wipers" in the Electronic Vehicle Information Center section of this manual for details.

SmartBeams — If Equipped

The SmartBeam system provides increased forward lighting at night by automating high beam control through the use of a digital camera mounted on the inside rearview mirror. This camera detects vehicle specific light and automatically switches from high beams to low beams until the approaching vehicle is out of view.

To Activate

1. Select “Automatic High Beams — ON” with the Electronic Vehicle Information Center (EVIC). Refer to “EVIC — Personal Settings” in Section 4 of this manual for details.
2. Rotate the headlight switch counter-clockwise to the AUTO (A) position.
3. Push the Multi-Function Lever away from you to switch the headlights to HIGH BEAM position.

NOTE: This system will not activate until the vehicle is at or above 25 mph (40 km/h).

To Deactivate

Perform either of the following steps to deactivate the SmartBeam system.

1. Pull the Multi-Function Lever towards you to switch the headlights from the HIGH BEAM to the LOW BEAM position.
2. Rotate the headlight switch clockwise from the AUTO (A) to the ON position.

NOTE: Broken, muddy, or obstructed headlights and taillights of vehicles in the field of view will cause headlights to remain on longer (closer to the vehicle). Also, dirt, film, and other obstructions on the windshield or camera lens will cause the system to function improperly.

Daytime Running Lights (Canada Only)

The high beam headlights will come on as Daytime Running Lights whenever the ignition switch is on, the headlights are off, and the parking brake is off. The headlight switch must be used for normal night time driving.

Lights-on Reminder

If the headlights or parking lights are on after the ignition is turned OFF, a chime will sound to alert the driver when the driver's door is opened.

Headlight Time Delay

This feature provides the safety of headlight illumination for 90 seconds (programmable) when leaving your vehicle in an unlighted area.

To activate the delay feature, turn off the ignition switch while the headlights are still on. Then turn off the headlights within 45 seconds. The delay interval begins when headlight switch is turned off. If the headlights or park lights are turned back on or the ignition switch is turned on, the delay will be cancelled.

If the headlights are turned off before the ignition, they will turn off in the normal manner.

NOTE: The lights must be turned off within 45 seconds of turning the ignition off to activate this feature

The Headlight delay time is programmable on vehicles equipped with the Electronic Vehicle Information Center

(EVIC). Refer to "Delay Turning Headlights Off" in the Electronic Vehicle Information Center section for details.

Fog Lights — If Equipped

 The front fog light switch is on the headlight switch below the dimmer control. To activate the front fog lights, turn on the parking lights or the low beam headlights and press the fog light switch.

NOTE: The fog lights will operate with the low beam headlights, or parking lights on. However, selecting the high beam headlights will turn off the fog lights.

Turn Signals

Move the Multi-Function Lever up or down and the arrows on each side of the instrument cluster flash to show proper operation of the front and rear turn signal lights. You can signal a lane change by moving the lever partially up or down without moving beyond the detent. Releasing the lever at the detent will provide 3 flashes.

If either light has a very fast flash rate, check for a defective outside light bulb. If an indicator fails to light when the lever is moved, it would suggest that the fuse or indicator is defective or there may be a circuit failure.

NOTE: The message “Turn Signal On” will appear in the electronic vehicle information center (EVIC) — if equipped, and a continuous chime will be heard when the vehicle has been driven more than 1 mile (1.6 km) with either turn signal on.

Highbeam/Lowbeam Select Switch

Push the Multi-Function Lever away from you to switch the headlights to HIGH beam. Pull the Lever towards you to switch the headlights back to LOW beam.

Flash to Pass

You can signal another vehicle with your headlights by lightly pulling the Multi-Function Lever toward you. This will cause the headlights to turn on at high beam and remain on until the lever is released.

WINDSHIELD WIPERS AND WASHERS



The wipers and washers are operated by the multi-function lever. The lever is located on the left side of the steering column. Rotate the end of the control lever to select the desired wiper speed.

CAUTION!

Turn the windshield wipers off when driving through an automatic car wash. Damage to the windshield wipers may result if the wiper switch is left in any position other than OFF.

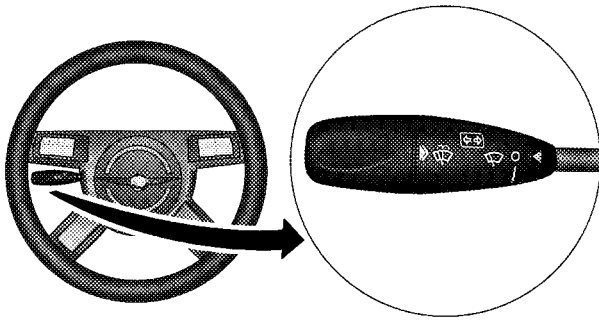

8125e17b

Windshield Wiper/Washer Control

Windshield Washers

To use the front washer, push the lever in and hold while spray is desired. If the lever is released while in the delay range, the wiper will operate for two wipe cycles after the lever is released, and then resume the intermittent interval previously selected.

If the lever is pushed while in the OFF position, the wipers will operate for two wipe cycles, then turn OFF.

Rain Sensing Wipers—If Equipped

This feature senses moisture on the windshield and automatically activates the wipers for the driver. The feature is especially useful for road splash or overspray from the windshield washers of the vehicle ahead. Rotate the end of the multi-function lever to one of six settings to activate this feature.

The sensitivity of the system can be adjusted with the multi-function lever. Wiper delay position 1 is the least sensitive, and wiper delay position 6 is the most sensitive. Settings 3-4 should be used for normal rain conditions. Settings 2 or 1 can be used if the driver desires less wiper sensitivity. Settings 5 and 6 can be used if the driver desires more sensitivity. Place the wiper switch in the OFF position when not using the system.

NOTE:

- The rain sensing feature will not operate when the wiper switch is in the LOW or HIGH speed position.
- On some vehicles the rain sensing feature will not operate when the gear selector is placed in the NEUTRAL position.

- The rain sensing feature may not function properly when ice, or dried salt water is present on the windshield.
- Use of Rain-X® or products containing wax or silicone may reduce rain sensor performance.
- A customer programmable feature in the Electronic Vehicle Information Center (EVIC) allows the Rain Sense feature to be turned off. Refer to “Personal Settings” in the Electronic Vehicle Information Center section of this manual for details.

The rain sensing system has protection features for the wiper blades and arms, and will not operate under the following conditions:

- **Low Temperature Wipe Inhibit** — When the ignition is first switched ON and the vehicle is stationary, and the outside temperature is below 32° F (0° C), the rain sensing feature will be suspended unless the wiper switch is moved, or the vehicle speed becomes greater than 0 mph (0 km/h), or the outside temperature rises above freezing.
- **Neutral Wipe Inhibit** — When the ignition is ON and while the transmission shift lever is in the N (Neutral) position, and the vehicle speed is less than 5 mph (8 k/mh), the rain sensing feature will be suspended unless the wiper switch is moved or the shift lever is moved out of the N (Neutral) position.

Mist Feature

Push the wiper lever in to activate a single wipe to clear off road mist or spray from a passing vehicle. As long as the lever is pushed in, the wipers will continue to operate.

Headlights On With Wipers (Available with Auto Headlights Only)

The headlights will turn on approximately 10 seconds after the wipers are turned on if the headlight switch is placed in the AUTO position. The headlights will also turn off when the wipers are turned off if they were turned on by this feature. This feature can be turned on or off using the Electronic Vehicle Information Center (EVIC) — If equipped. Refer to “Headlights On With Wipers” in the Electronic Vehicle Information Center section of this manual for details.

Windshield Wiper Operation

Rotate the end of the lever to the second detent for Low speed wiper operation, or to the third detent for High speed operation.

Intermittent Wiper System

Use the intermittent wiper when weather conditions make a single wiping cycle, with a variable pause between cycles, desirable. Rotate the end of the lever to the first detent position, then turn the end of the lever to select the desired delay interval. There are 6 possible delay wiper positions. The delay can be regulated from a maximum of approximately 23 seconds between cycles, to a cycle every second.

Adding Washer Fluid

The windshield washer fluid reservoir is located in the front of the engine compartment on the passenger side of the vehicle. Be sure to check for fluid level in the reservoir at regular intervals. Fill the reservoir with windshield washer solvent (not radiator antifreeze) and operate the system for a few seconds to flush out the residual water.

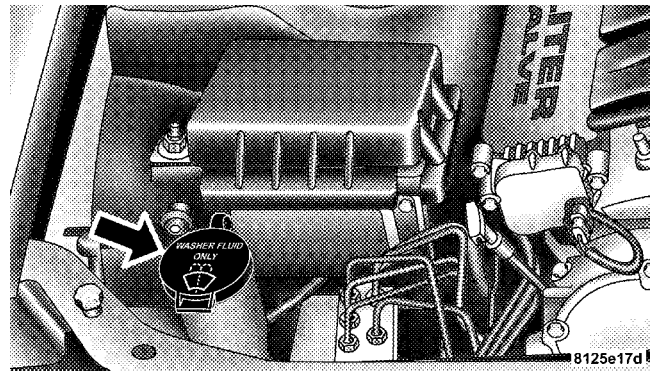

Windshield Washer Fluid Reservoir

The fluid reservoir will hold 1 gallon (3.8L) of washer fluid when the message “Low Washer Fluid” appears in the Electronic Vehicle Information Center (EVIC) — if equipped.

Headlight Washers — If Equipped

This feature operates in combination with the windshield washers. To use the headlight washers, turn the headlights ON and press in on the windshield washer control knob while the engine is running.

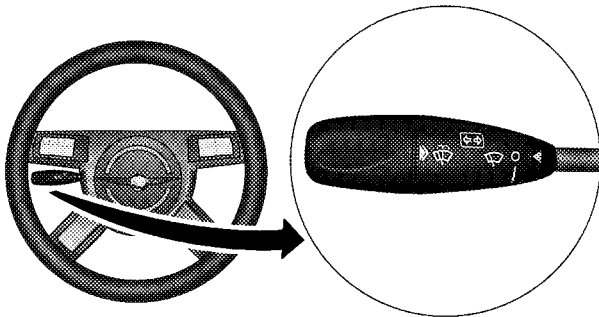

8125e17b

Windshield Wiper/Washer Control

This will operate the windshield washers and direct a timed high pressure spray onto the headlight lens.

NOTE: The headlight washers will operate on the first spray of the windshield washers, then every fourth spray of the windshield washers after that.

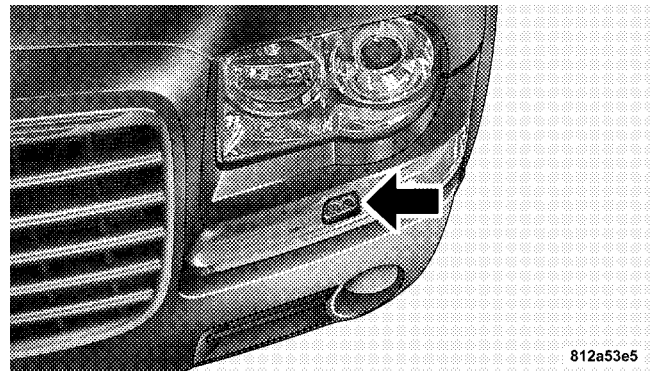

812a53e5

Headlight Washer

Adding Washer Fluid

The headlight washer and windshield washer share the same fluid reservoir. The reservoir is located in the front of the engine compartment on the passenger side of the vehicle. Be sure to check the fluid level in the reservoir at regular intervals. Fill the reservoir with windshield washer solvent (not radiator antifreeze) and operate the system for a few seconds to flush out the residual water.

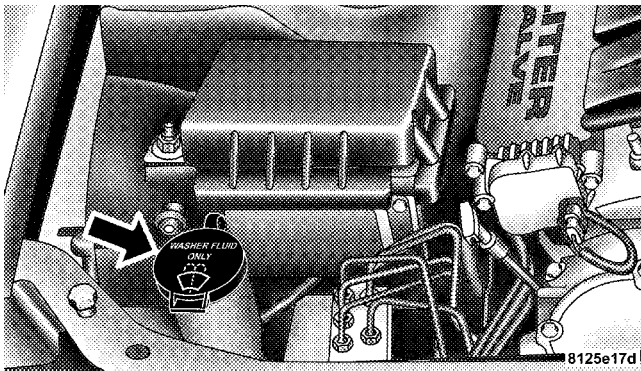

Headlight Washer Fluid Reservoir

TILT/TELESCOPING STEERING COLUMN

Unlock the steering column by pulling out the handle located directly below the column. To tilt the column move the steering wheel up or down as desired. To lengthen or shorten the steering column pull out or push in the steering wheel. Lock the steering column in position by pushing the handle in until it fully engages.

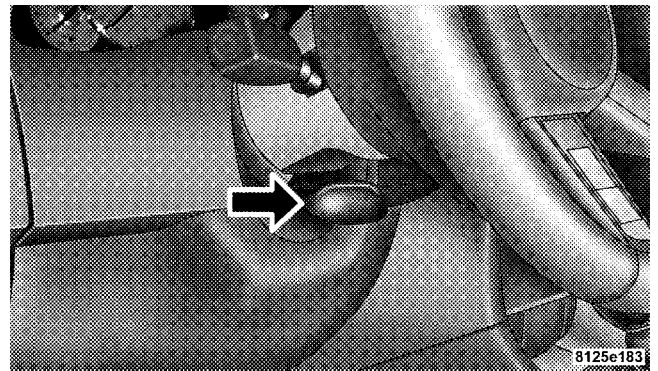

Tilt Steering Column Control

WARNING!

Do not adjust the steering wheel while driving. The telescoping adjustment must be locked while driving. Adjusting the steering wheel while driving, or driving without the telescoping adjustment locked could cause the driver to lose control of the vehicle.

**POWER TILT/TELESCOPING STEERING COLUMN
— IF EQUIPPED**

The power tilt/telescoping steering column lever is located below the multi-function lever on the steering column. To tilt the column move the lever up or down as desired. To lengthen or shorten the steering column pull the lever toward you or push the lever away from you as desired.

NOTE: For vehicles equipped with Driver Memory Seat, you can use your remote keyless entry transmitter or the memory switch on the driver's door panel to return the tilt/telescopic steering column to pre-programmed positions. Refer to "Driver Memory Seat" in this section for details.

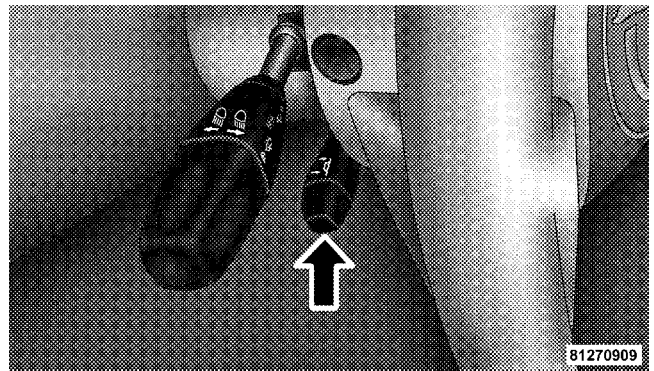

Power Tilt/Telescoping Steering

WARNING!

Moving the steering column while the vehicle is moving is dangerous. Without a stable steering column you could lose control of the vehicle and have an accident. Adjust the column only while the vehicle is stopped.

TRACTION CONTROL SYSTEM (TCS) — IF EQUIPPED**WARNING!**

TCS cannot prevent the natural laws of physics from acting on the vehicle, nor can it increase the traction afforded. The TCS cannot prevent accidents, including those resulting from excessive speed in turns, or hydroplaning. Only a safe, attentive, and skillful driver can prevent accidents. The capabilities of a TCS-equipped vehicle must never be exploited in a reckless or dangerous manner which could jeopardize the user's safety or the safety of others.



The traction control system (TCS) warning light is located in the instrument cluster. The TCS light will flash as soon as the tires lose traction and the wheels begin to spin. This indicates that the TCS system is active. If the TCS warning light begins to flash during acceleration, ease up on the accelerator and apply as little throttle as possible. Be sure to adapt your speed and driving to the prevailing road conditions. When the TCS warning light is illuminated continuously, the TCS is switched off. To return to the enhanced vehicle stability offered by TCS, press the traction control switch (the TCS warning light in the instrument cluster goes out). Avoid spinning one drive wheel. This may cause serious damage to the drive train.

The traction control switch is located on the center of the instrument panel. To turn the traction control system OFF press the traction control switch until the traction control Indicator in the instrument cluster lights up.

To improve the vehicle's traction when driving with snow chains, or starting off in deep snow, sand or gravel, switch off the TCS system by pressing the traction control switch.

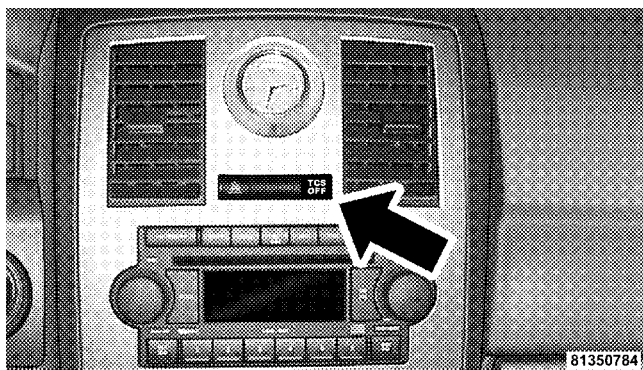

Traction Control Switch

To turn the system back ON, press the traction control switch a second time until the traction control Indicator turns OFF.

NOTE:

- The traction control system comes on each time the ignition switch is turned ON. This will occur even if you used the switch to turn the system OFF.
- The Traction Control system will make buzzing or clicking sounds when in operation.

REAR PARK ASSIST SYSTEM — IF EQUIPPED

This system is used to help drivers determine if an obstacle is in the way of the vehicle while it is backing up in addition to the use of inside rearview and outside mirrors.

When the driver selects Reverse the system scans for objects behind the vehicle using four sensors located in the rear bumper. Objects can be detected from up to 71 inches (180 cm). A warning display above the rear window provides both visible and audible warnings indicating the range of the object.

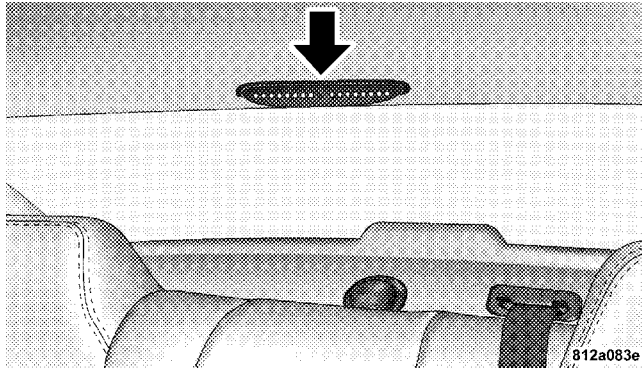

Rear Park Assist Indicator

WARNING!

Drivers must be careful when backing up even when using the Rear Park Assist System. Always check carefully behind your vehicle, look behind you, and be sure to check for pedestrians, other vehicles, obstructions, and blind spots before backing up. Failure to do so can result in serious personal injury or death.

The display contains two sets of yellow and red LEDs that can be viewed from the driver seat using the rear view mirror. Each side of the vehicle has its own warning LEDs. The system provides a visual warning by illuminating one or more yellow LEDs as the vehicle gets closer to the object. As the vehicle continues to approach the object, one red LED is illuminated and the system emits a series of short beeps. The tone will remain constant and both red LEDs are illuminated once the vehicle is within 12 inches (30.5 cm) of the object.

NOTE: The Rear Park Assist System displays the outer most yellow LED's at a slightly dimmer level to indicate that the system is ON.

NOTE: When an audio tone is indicated by the Rear Park Assist display the system will MUTE the radio if it is turned on.

The system can be turned on or off through the Electronic Vehicle Information Center (EVIC) when the vehicle is in PARK. Refer to "Personal Settings" in the Electronic Vehicle Information Center section of this manual for details.

NOTE:

- Ensure that the rear bumper is free of dirt and debris to keep the system operating properly.
- Jackhammers, large trucks, and other vibrations could affect the performance of the system.

If "Service Park Assist System" appears in the EVIC after making sure the rear bumper is clean please see your authorized dealer.

BRAKE ASSIST SYSTEM (BAS) — IF EQUIPPED

BAS is standard on vehicles equipped with electronic stability program (ESP). The BAS is designed to optimize the vehicle's braking capability during emergency braking maneuvers. The system applies optimum pressure to the brakes in emergency braking conditions than might otherwise be afforded solely by the driver's braking style. This can help reduce braking distances. The BAS complements the antilock brake system (ABS). Applying the brakes very quickly results in the best BAS assistance. To receive the benefit of the system, you must apply continuous braking power during the stopping sequence. Do not reduce brake pedal pressure.

WARNING!

BAS cannot prevent the natural laws of physics from acting on the vehicle, nor can it increase braking efficiency beyond that afforded by the condition of the vehicle brakes and tires or the traction afforded. The BAS cannot prevent accidents, including those resulting from excessive speed in turns, following another vehicle too closely, or hydroplaning. Only a safe, attentive, and skillful driver can prevent accidents. The capabilities of a BAS-equipped vehicle must never be exploited in a reckless or dangerous manner which could jeopardize the user's safety or the safety of others.

Once the brake pedal is released, the BAS is deactivated.

**ESP
BAS**

The malfunction indicator light for the ESP is combined with BAS. The yellow ESP/BAS malfunction indicator light and the yellow ESP warning light in the instrument cluster both come on when the ignition switch is turned to the "ON" position. They should go out with the engine running. If

the ESP/BAS malfunction indicator light comes on continuously with the engine running, a malfunction has been detected in either the ESP or the BAS system. If this light stays illuminated, have the ESP and BAS checked at your authorized dealer as soon as possible.

ELECTRONIC STABILITY PROGRAM (ESP) — IF EQUIPPED

WARNING!

ESP cannot prevent the natural laws of physics from acting on the vehicle, nor can it increase the traction afforded. The ESP cannot prevent accidents, including those resulting from excessive speed in turns, or hydroplaning. Only a safe, attentive, and skillful driver can prevent accidents. The capabilities of an ESP-equipped vehicle must never be exploited in a reckless or dangerous manner which could jeopardize the user's safety or the safety of others.

The ESP enhances directional control and reduces driving wheel spin of the vehicle under various driving conditions. The system operates when the vehicle speed is greater than 7.8 mph (12.6 km/h).

The ESP system corrects for over/understeering of the vehicle by applying brakes to the appropriate wheel. Engine torque is also limited.



The ESP warning light, located in the instrument cluster, starts to flash as soon as the ESP system sensor's information varies from the driver's intended path. The ESP warning light also flashes when traction control is activated. If the ESP warning light begins to flash during acceleration, ease up on the accelerator and apply as little throttle as possible. Be sure to adapt your speed and driving to the prevailing road conditions. When the ESP warning light is illuminated continuously, the ESP is switched off. To return to the enhanced vehicle stability offered by ESP, press the ESP switch (the ESP warning light in the instrument cluster goes out). Avoid spinning one drive wheel. This may cause serious damage to the drive train.

To improve the vehicle's traction when driving with snow chains, or starting off in deep snow, sand or gravel, switch off the ESP system by pressing the ESP switch.

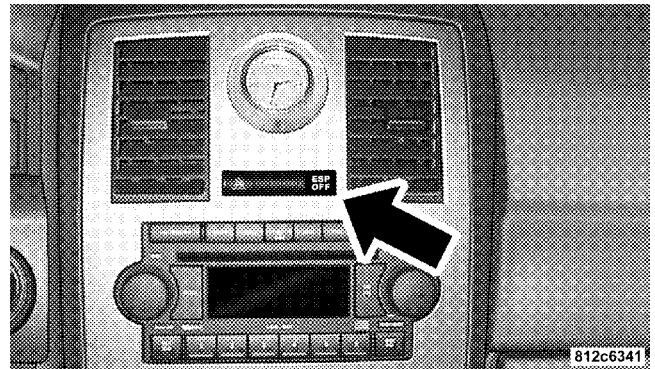

ESP OFF Button

With the ESP system switched off, the engine torque reduction feature is cancelled. Therefore, the enhanced vehicle stability offered by ESP is unavailable. ESP always operates under braking, even with the switch in the OFF position. When the ESP system is disabled (if one drive wheel loses traction and begins to spin) the brake is applied by the ESP system to control wheel slip. This

wheel slip control is active at vehicle speeds between approximately 24 mph (40 km/h) and 50 mph (80 km/h).

CAUTION!

If the vehicle is towed with the front axle raised, the engine must be shut off (key in the ignition switch to the OFF/LOCK or ACC position). Otherwise the ESP will immediately be engaged and will apply the rear wheel brakes.

Synchronizing ESP

ESP
BAS The malfunction indicator light for the ESP is combined with BAS. If the power supply was interrupted (battery disconnected or discharged), the ESP/BAS malfunction indicator light may be illuminated with the engine running. Turn the steering wheel completely to the left and then to the right. The ESP/BAS malfunction indicator light should go out.

ELECTRONIC SPEED CONTROL

When engaged, this device takes over the accelerator operation at speeds greater than 25 mph (40 km/h). The speed control switch consists of a stalk mounted lever located on the steering column.

3

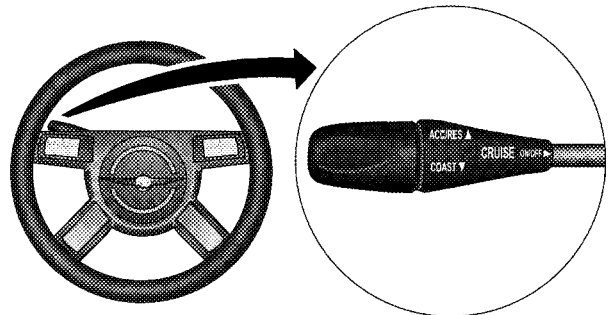

8125e18c

Speed Control Lever

To Activate:

Push and release the speed control lever (“ON/OFF”) once and the electronic speed control indicator light in the instrument cluster will illuminate indicating that the electronic speed control is ON. To turn the system OFF, Push and release the lever (“ON/OFF”) again and the system and indicator will turn off.

To Set At A Desired Speed:

When the vehicle has reached the desired speed, pull the lever toward you and release. Release the accelerator and the vehicle will operate at the selected speed.

NOTE: Speed control will only function in third, fourth, or fifth gear when in the Autostick Mode — if equipped.

NOTE: The speed control may not engage if a different size tire is installed on one wheel, such as the compact spare tire.

To Deactivate:

A soft tap on the brake pedal, pushing the lever away from you (“CANCEL”) or normal braking while slowing the vehicle will deactivate the speed control without erasing the memory. Pushing and releasing the lever (“ON/OFF”) or turning off the ignition erases the speed memory.

To Resume Speed:

To resume a previously set speed, push the lever up and release (“ACC/RES”). Resume can be used at any speed above 20 mph (32 km/h).

To Vary the Speed Setting:

When the speed control is set, speed can be increased by pushing the lever up and holding (“ACC/RES”). When the lever is released, a new set speed will be established.

Pushing the lever up and releasing (“ACC/RES”) once will result in a 1 mph (1.6 km/h) speed increase. Each time the lever is pushed up and released, speed increases so that pushing the lever up and releasing three times will increase speed by 3 mph (4.8 km/h), etc.

To decrease speed while speed control is set, push the lever down and hold (“COAST”). Release the lever when the desired speed is reached, and the new speed will be set.

Pushing down and releasing the lever (“COAST”) once will result in a 1 mph (2 km/h) speed decrease. Each time the lever is pushed down and released, speed decreases.

To Accelerate For Passing:

Depress the accelerator as you would normally. When the pedal is released, the vehicle will return to the set speed.

NOTE: The speed control system maintains speed up and down hills. A slight speed change on moderate hills is normal.

Four speed automatic transmissions will experience a downshift to 3rd gear while climbing uphill or descending downhill. This downshift to 3rd gear is necessary to maintain vehicle set speed.

On steep hills a greater speed loss or gain may occur so it may be preferable to drive without speed control.

WARNING!

Speed Control can be dangerous where the system can't maintain a constant speed. Your vehicle could go too fast for the conditions, and you could lose control. An accident could be the result. Don't use Speed Control in heavy traffic or on roads that are winding, icy, snow-covered, or slippery.

OVERHEAD CONSOLE — IF EQUIPPED

The overhead console contains courtesy/reading lights, an optional universal garage door opener (HomeLink®), storage for sunglasses, and an optional power sunroof switch.

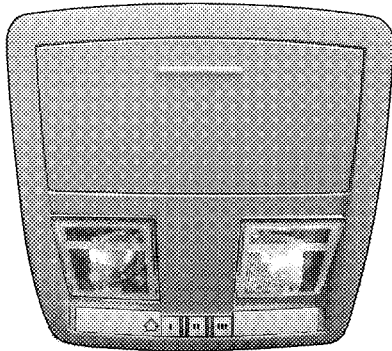

Overhead Console

8125e191

Courtesy/Reading Lights

At the forward end of the console are two courtesy/reading lights.

Press the lens to turn these lights on. Press a second time to turn the lights off.

The lights also turn on when a front door or rear door is opened. The lights will also turn on when the unlock button on the remote keyless entry transmitter is pressed.

Sunglasses Storage

At the rear of the console a compartment is provided for the storage of a pair of sunglasses.

The storage compartment access is a "push/push" design. Push the finger depression on the overhead console to open. Push the finger depression to close.

GARAGE DOOR OPENER — IF EQUIPPED

The HomeLink® Universal Transceiver replaces up to three remote controls (hand held transmitters) that operate devices such as garage door openers, motorized gates, or home lighting. It triggers these devices at the push of a button. The Universal Transceiver operates off your vehicle's battery and charging system; no batteries are needed.

NOTE: The HomeLink® Universal Transceiver is disabled when the Vehicle Theft Alarm is active.

For additional information on HomeLink®, call 1-800-355-3515, or on the internet at www.homelink.com.

WARNING!

Vehicle exhaust contains carbon monoxide, a dangerous gas. Do not run the vehicle's exhaust while training the transceiver. Exhaust gas can cause serious injury or death.

WARNING!

Your motorized door or gate will open and close while you are training the Universal Transceiver. Do not train the transceiver if people or pets are in the path of the door or gate. A moving door or gate can cause serious injury or death to people and pets or damage to objects.

WARNING!

A moving garage door can cause injury to people and pets in the path of the door. People or pets could be seriously or fatally injured. Only use this transceiver with a garage door opener that has a "stop and reverse" feature as required by federal safety standards. This includes most garage door opener models manufactured after 1982. Do not use a garage door opener without these safety features it could cause injury or death. Call toll-free 1-800-355-3515 or, on the Internet at www.homelink.com for safety information or assistance.

Programming HomeLink

NOTE: When programming a garage door opener, it is advised to park outside the garage. It is also recommended that a new battery be placed in the hand-held transmitter of the device being programmed to HomeLink for quicker training and accurate transmission of the radio-frequency signal.

The Electronic Vehicle Information Center (EVIC) features a driver-interactive display which includes HomeLink system messages. The EVIC is located in the upper part of the cluster between the speedometer and tachometer.

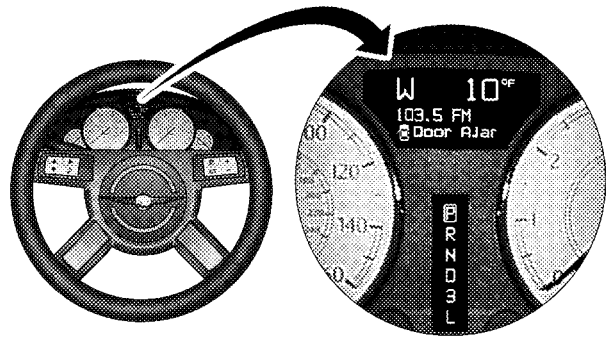

812c4479

Electronic Vehicle Information Center

1. Press and hold the two outer HomeLink buttons, and release only when the EVIC display shows "Channels Cleared" (after 20 seconds). Do not hold the buttons for longer than 30 seconds and do not repeat step one to program a second and/or third hand-held transmitter to the remaining two HomeLink buttons.

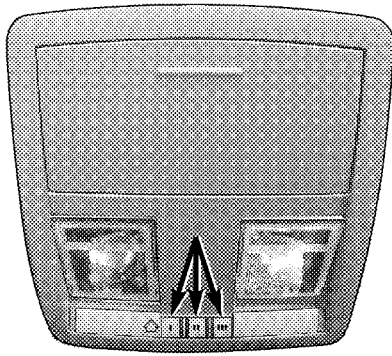

8125e19b

HomeLink Buttons

2. Position the end of your hand-held transmitter 1-3 inches (3-8 cm) away from the HomeLink buttons.
3. Simultaneously press and hold both the HomeLink button that you want to train and the hand-held transmitter buttons. **Do not release the buttons until step 4 has been completed.**

NOTE: Some gate operators and garage door openers may require you to replace this Programming Step 3 with procedures noted in the "Gate Operator/Canadian Programming" section.

4. The EVIC display will show "Channel X Training" (where X is Channel 1, 2, or 3). Release both buttons after the EVIC display shows "Channel X Trained".

NOTE: If the EVIC display shows "Did Not Train" repeat steps 2-4.

5. Press and hold the just trained HomeLink button and observe the EVIC display. If the EVIC display shows "Channel X Transmit" (where X is Channel 1, 2, or 3), programming is complete and your device should activate when the HomeLink button is pressed and released.

NOTE: To program the remaining two HomeLink buttons, begin with "Programming" step two. **Do not repeat step one.**

NOTE: If your hand-held transmitter appears to program the universal transceiver, but your garage door does not operate using the transmitter and your garage door opener was manufactured after 1995, your garage

door opener may have a multiple security code system (rolling code system). Please proceed to steps 6–8 to complete the programming of a rolling code equipped device (most common garage door openers require this step).

6. At the garage door opener receiver (motor-head unit) in the garage, locate the "learn" or "smart" button. This can usually be found where the hanging antenna wire is attached to the motor-head unit.

7. Firmly press and release the "learn" or "smart" button. (The name and color of the button may vary by manufacturer.)

NOTE: There are 30 seconds in which to initiate step eight.

8. Return to the vehicle and firmly **press, hold for two seconds and release** the programmed HomeLink button. Repeat the "press/hold/release" sequence a second time, and, depending on the brand of the garage door opener (or other rolling code equipped device), repeat this sequence a third time to complete the programming.

HomeLink should now activate your rolling code equipped device.

NOTE: To program the remaining two HomeLink buttons, begin with "Programming" **step two**. **Do not repeat step one**. For questions or comments, please contact HomeLink at www.homelink.com or 1-800-355-3515.

Canadian Programming/Gate Programming

Canadian radio-frequency laws require transmitter signals to "time-out" (or quit) after several seconds of transmission which may not be long enough for HomeLink to pick up the signal during programming. Similar to this Canadian law, some U.S. gate operators are designed to "time-out" in the same manner.

If you live in Canada or you are having difficulties programming a gate operator by using the "Programming" procedures (regardless of where you live), **replace "Programming HomeLink" step 3** with the following:

NOTE: If programming a garage door opener or gate operator, it is advised to unplug the device during the "cycling" process to prevent possible overheating.

3. Continue to press and hold the HomeLink button while you **press and release every two seconds** ("cycle") your hand-held transmitter until the frequency signal has successfully been accepted by HomeLink. The EVIC display will show "Channel X Trained" (where X is Channel 1, 2, or 3). Proceed with "Programming" step four to complete.

Using HomeLink

To operate, simply press and release the programmed HomeLink button. Activation will now occur for the trained device (i.e. garage door opener, gate operator, security system, entry door lock, home/office lighting, etc.). For convenience, the hand-held transmitter of the device may also be used at any time. In the event that there are still programming difficulties or questions, contact HomeLink at: www.homelink.com or 1-800-355-3515.

Erasing HomeLink Buttons

To erase programming from the three buttons (individual buttons cannot be erased but can be "reprogrammed" - note below), follow the step noted:

- Press and hold the two outer HomeLink buttons and release only when the EVIC display shows "Channels Cleared" (after 20 seconds). Release both buttons. Do not hold for longer than 30 seconds. HomeLink is now in the train (or learning) mode and can be programmed at any time beginning with "Programming" - step 2.

Reprogramming a Single HomeLink Button

To program a device to HomeLink using a HomeLink button previously trained, follow these steps:

1. Press and hold the desired HomeLink button. Do **NOT** release the button.
2. The EVIC display will show "Channel X Transmit" (where X is Channel 1, 2, or 3) for 20 seconds and then change to "Channel X Training". Without releasing the HomeLink button, proceed with "Programming" step 2.

For questions or comments, contact HomeLink at: www.homelink.com or 1-800-355-3515.

Security

If you sell your vehicle, be sure to erase the frequencies by following the “Erasing HomeLink Buttons” instructions in this section.

This device complies with part 15 of FCC rules and with RSS-210 of Industry Canada. Operation is subject to the following conditions:

- This device may not cause harmful interference.
- This device must accept any interference that may be received including interference that may cause undesired operation.

NOTE: Changes or modifications not expressly approved by the party responsible for compliance could void the user’s authority to operate the equipment.

HomeLink® is a trademark owned by Johnson Controls, Inc.

POWER SUNROOF — IF EQUIPPED

The power sunroof is located between the sun visors on the overhead console.

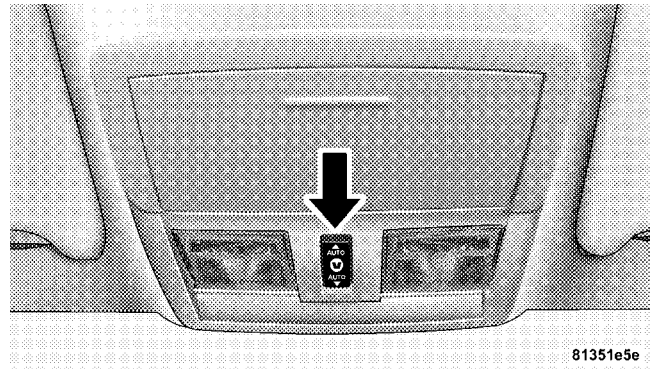

81351e9e

Power Sunroof Controls

WARNING!

- Never leave children in a vehicle, with the keys in the ignition switch. Occupants, particularly unattended children, can become entrapped by the power sunroof while operating the power sunroof switch. Such entrapment may result in serious injury or death.
- In an accident, there is a greater risk of being thrown from a vehicle with an open sunroof. You could also be seriously injured or killed. Always fasten your seat belt properly and make sure all passengers are properly secured too.
- Do not allow small children to operate the sunroof. Never allow fingers or other body parts, or any object to project through the sunroof opening. Injury may result.

Opening Sunroof - Express

Press the switch rearward and release, and the sunroof will open automatically from any position. The sunroof will open fully, then stop automatically. This is called Express Open. During Express Open operation, any movement of the sunroof switch will stop the sunroof.

Closing Sunroof - Express

Press the switch forward and release, and the sunroof will close automatically from any position. The sunroof will close fully and stop automatically. This is called Express Close. During Express Close operation, any movement of the switch will stop the sunroof.

Pinch Protect Feature

This feature will detect an obstruction in the opening of the sunroof during Express Close operation. If an obstruction in the path of the sunroof is detected, the sunroof will automatically retract. Remove the obstruction if this occurs. Next, press the switch forward and release to Express Close.

Pinch Protect Override

If a known obstruction (ice, debris, etc.) prevents closing, press the switch forward and hold for two seconds after the reversal occurs. This allows the sunroof to move towards the closed position.

NOTE: Pinch protection is disabled while the switch is pressed.

Venting Sunroof - Express

Press and release the "V" button, and the sunroof will open to the vent position. This is called Express Vent, and will occur regardless of sunroof position. During Express Vent operation, any movement of the switch will stop the sunroof.

Sunshade Operation

The sunshade can be opened manually. However, the sunshade will open automatically as the sunroof opens.

NOTE: The sunshade cannot be closed if the sunroof is open.

Wind Buffeting

Wind buffeting can be described as the perception of pressure on the ears or a helicopter type sound in the ears. Your vehicle may exhibit wind buffeting with the windows down, or the sunroof (if equipped) in certain open or partially open positions. This is a normal occurrence and can be minimized. If the buffeting occurs with the rear windows open, then open the front and rear windows together to minimize the buffeting. If the buffeting occurs with the sunroof open, then adjust the sunroof opening to minimize the buffeting or open any window.

Sunroof Maintenance

Use only a non-abrasive cleaner and a soft cloth to clean the glass panel.

Ignition Off Operation

For vehicles not equipped with the Electronic Vehicle Information Center (EVIC), the power sunroof switch will remain active for 10 minutes after the ignition switch is turned off. Opening either front door will cancel this feature.

For vehicles equipped with the EVIC, the power sunroof switch will remain active for up to 60 minutes after the ignition switch is turned off. Opening either front door will cancel this feature. The time is programmable through the EVIC. Refer to “Delay Power Off to Accessories Until Exit” under “Personal Settings (Customer Programmable Features)” under “Electronic Vehicle Information Center (EVIC)” in Section 4 of this manual for details.

Sunroof Fully Closed

Press the switch forward and release to ensure that the sunroof is fully closed.

ELECTRICAL POWER OUTLETS

There are two 12-volt electrical outlets on this vehicle. Both of the outlets are protected by a fuse.

The 12 volt power outlet next to the ash receiver tray (if equipped with an optional Smoker’s Package) has power available only when the ignition is on. This outlet will also operate a conventional cigar lighter unit.

3

WARNING!
Do not place ashes inside the cubby bin located on the center console on vehicles not equipped with the ash receiver tray. A fire leading to bodily injury could result.

NOTE: If desired, the power outlet next to the ash receiver tray (if equipped) can be converted by your authorized dealer to provide power with the ignition switch in the LOCK position.

The center console outlet is powered directly from the battery (power available at all times). Items plugged into this outlet may discharge the battery and/or prevent engine starting.

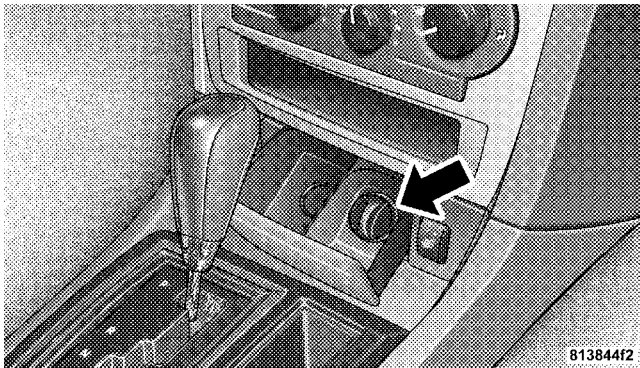

Front Power Outlet

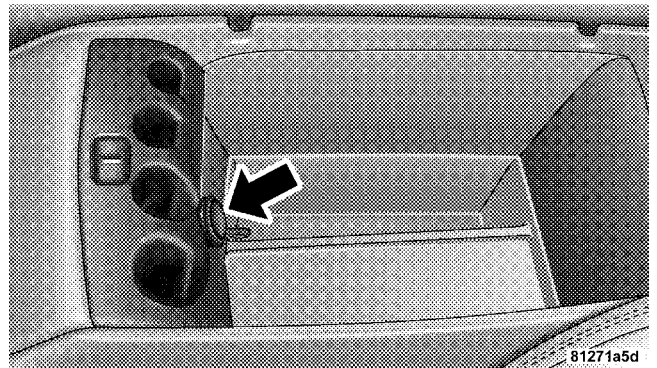

Center Console Power Outlet

Electrical Outlet Use With Engine Off**CAUTION!**

- Many accessories that can be plugged in draw power from the vehicle's battery, even when not in use (i.e. cellular phones, etc.). Eventually, if plugged in long enough, the vehicle's battery will discharge sufficiently to degrade battery life and/or prevent engine starting.
- Accessories that draw higher power (i.e. coolers, vacuum cleaners, lights, etc.), will degrade the battery even more quickly. Only use these intermittently and with greater caution.
- After the use of high power draw accessories, or long periods of the vehicle not being started (with accessories still plugged in), the vehicle must be driven a sufficient length of time to allow the alternator to recharge the vehicle's battery.
- Power outlets are designed for accessory plugs only. Do not hang any type of accessory or accessory bracket from the plug. Improper use of the power outlet can cause damage.

CUP HOLDERS**Front Seat Cup Holders — Standard**

The cup holders are located in the forward edge of the center console.

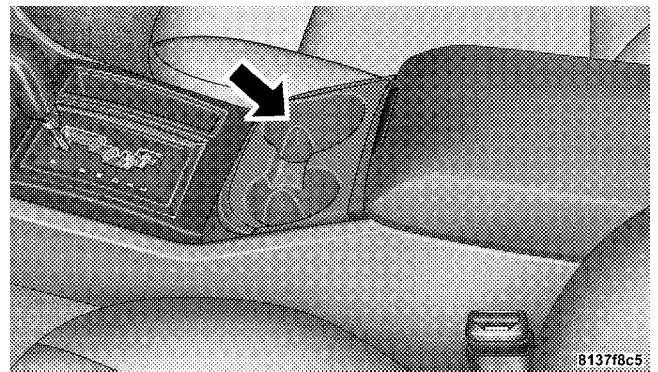

Front Seat Cup Holders

Front Seat Cup Holders — 300 Touring and 300C Models

The cup holders are located in the forward edge of the center console.

Push down on the cover as shown to expose the cup holders. Close the cover when the cup holders are no longer needed.

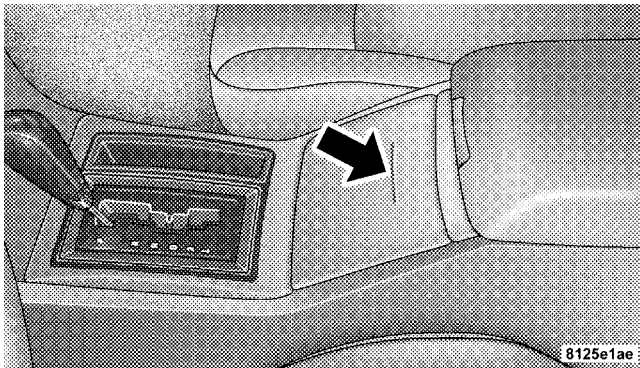

Front Seat Cup Holders

Rear Seat Cup Holders

The rear seat cup holders are located in the center armrest between the rear seats. The cup holders are positioned forward in the armrest and side-by-side to provide convenient access to beverage cans or bottles while maintaining a resting place for the rear occupants' elbows.

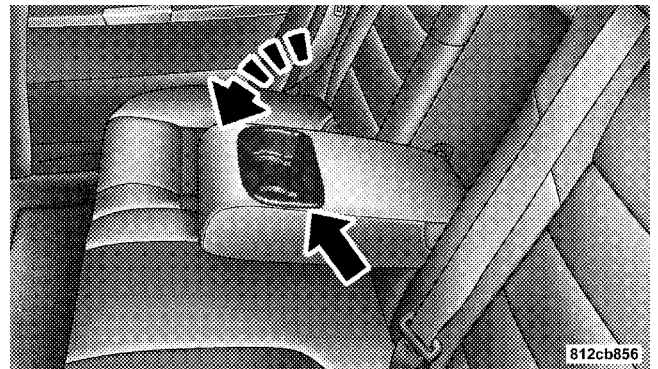

Rear Seat Cup Holders

STORAGE

Console Features

The center console contains a large storage bin. The storage bin contains a four-slot coin holder (designed to hold various size coins) and a rubber mat at the bottom of the bin for noise control. The bin is large enough to hold a portable AC/DC converter to power laptops, games, or other electrical equipment. Two slots at the top right side of the bin provide clearance for power cords to pass conveniently out of the bin with the lid closed. This feature is ideal for games, laptops, cell phones, or other electrical equipment. The console's front-opening lid allows for easy access to the storage bin for the both the driver and the front passenger. The inside portion of the arm rest lid contains a penholder, a tissue holder, and a tire gauge holder.

In addition to the internal storage, the console contains two shift bezel cubby bins with rubber mats for holding small items. For vehicles not equipped with navigation radio, the console also contains an extra storage bin located below the climate control, which holds up to four CD jewel cases.

Cargo Tie-Down Hooks

The tie-downs located on cargo area floor and on the rear trim panels should be used to safely secure loads when vehicle is moving.

WARNING!

- Cargo tie-down hooks are not safe anchors for a child seat tether strap. In a sudden stop or collision a hook could pull loose and allow the child seat to come loose. A child could be badly injured. Use only the anchors provided for child seat tethers.
- The weight and position of cargo and passengers can change the vehicle center of gravity and vehicle handling. To avoid loss of control resulting in personal injury, follow these guidelines for loading your vehicle:

- Always place cargo evenly on the cargo floor. Put heavier objects as low and as far forward as possible.
- Place as much cargo as possible in front of the rear axle. Too much weight or improperly placed weight over or behind the rear axle can cause the rear of the vehicle to sway.
- Do not pile luggage or cargo higher than the top of the seatback. This could impair visibility or become a dangerous projectile in a sudden stop or collision.

WARNING!

To help protect against personal injury, passengers should not be seated in the rear cargo area. The rear cargo space is intended for load carrying purposes only, not for passengers, who should sit in seats and use seat belts.

LOAD LEVELING SYSTEM — IF EQUIPPED

The automatic load leveling system will provide a level riding vehicle under most passenger and cargo loading conditions.

A hydraulic pump contained within the shock absorbers raises the rear of the vehicle to the correct height. It takes approximately 1 mile (1.6 km) of driving for the leveling to complete depending on road surface conditions.

If the leveled vehicle is not moved for approximately 15 hours, the leveling system will bleed itself down. The vehicle must be driven to reset the system.

UNDERSTANDING YOUR INSTRUMENT PANEL

CONTENTS

■ Instruments And Controls	140	□ Personal Settings (Customer Programmable Features)	158
■ Standard Instrument Cluster	141	■ Setting The Analog Clock	162
■ Premium Instrument Cluster	142	■ Radio General Information	163
■ Instrument Cluster Descriptions	143	□ Radio Broadcast Signals	163
■ Electronic Vehicle Information Center (EVIC)	150	□ Two Types Of Signals	163
□ Electronic Vehicle Information Center (EVIC) Displays	151	□ Electrical Disturbances	163
□ Trip Functions	153	□ AM Reception	163
□ Compass Display	154	□ FM Reception	163
□ Telephone — If Equipped	156	■ Sales Code REF — AM/FM/CD (Single Disc) Radio With Optional Satellite Radio And Hands Free Phone Capability	164
□ Navigation — If Equipped	157		

138 UNDERSTANDING YOUR INSTRUMENT PANEL

□ Operating Instructions - Radio Mode	165	□ Changing Tape Direction	176
□ Operation Instructions - CD Mode	168	□ Metal Tape Selection	176
□ Operation Instructions - Auxiliary Mode	169	□ Pinch Roller Release	176
□ Operating Instructions - Hands Free Phone — If Equipped	170	□ Noise Reduction	176
□ Operating Instructions - Satellite Radio — If Equipped	170	□ Operation Instructions - (CD Mode For CD Audio Play)	176
■ Sales Code RAK – AM/FM/Cassette/CD (6-Disc) Radio With Optional Satellite Radio, Hands Free Phone, Video, MP3, And WMA Capabilities . . .	171	□ Load/Eject Button (CD Mode For CD Audio Play)	177
□ Operating Instructions - Radio Mode	171	□ Notes On Playing MP3 Files	179
□ Operating Instructions — Tape Player	175	□ Operation Instructions - (CD Mode For MP3 And WMA Audio Play) . . .	181
□ Seek Button	175	□ Load/Eject Button (CD Mode For MP3 And WMA Play)	181
□ Fast Forward (FF)	175	■ Satellite Radio — If Equipped	183
□ Rewind (RW)	175	□ System Activation	183
□ Tape Eject	175	□ Electronic Serial Number/Sirius Identification Number (ESN/SID)	183
□ Scan Button	175	□ Selecting Satellite Mode In REF, RAQ, And RAK Radios	184

□ Selecting a Channel	184	□ Satellite Radio Operation	191
□ Storing And Selecting Pre-Set Channels	185	■ Cassette Tape And Player Maintenance	191
□ Using The PTY (Program Type) Button (If Equipped)	185	■ CD/DVD Disc Maintenance	192
□ PTY Button "Scan"	185	■ Radio Operation And Cellular Phones	192
□ PTY Button "Seek"	185	■ Climate Controls	192
□ Satellite Antenna	185	□ Climate Controls — Manual	192
□ Reception Quality	186	□ Automatic Temperature Control — If Equipped	196
■ Video Entertainment System (Sales Code XRV) — If Equipped	186	□ Summer Operation	201
■ Navigation System (Sales Code REC) — If Equipped	188	□ Winter Operation	202
□ Clock Setting Procedure	188	□ Vacation Storage	202
■ Remote Sound System Controls	189	□ Window Fogging	202
□ Radio Operation	190	□ Outside Air Intake	202
□ Tape Player Operation	190	□ A/C Air Filter — If Equipped	202
□ CD Player Operation	190	□ Operating Tips	203

INSTRUMENTS AND CONTROLS

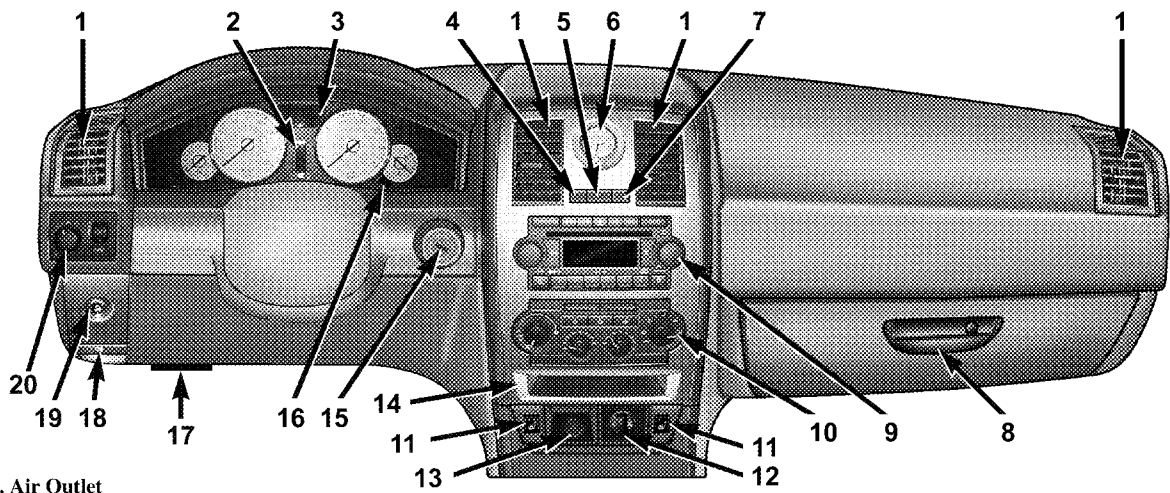

- 1. Air Outlet
- 2. Instrument Cluster
- 3. Electronic Vehicle Information Center
- 4. Hazard Switch
- 5. Passenger Air Bag Off Light
- 6. Analog Clock
- 7. Electronic Stability Program Off Button/
Traction Control System Off Button*

- 8. Glove Box
- 9. Radio
- 10. Climate Controls
- 11. Heated Seat Switch*
- 12. Power Outlet
- 13. Ash Tray*
- 14. Storage Compartment

- 15. Ignition Switch
- 16. Trip Odometer Button
- 17. Hood Release
- 18. Parking Brake Release Lever
- 19. Trunk Release Switch
- 20. Headlamp Switch
- * If Equipped

STANDARD INSTRUMENT CLUSTER

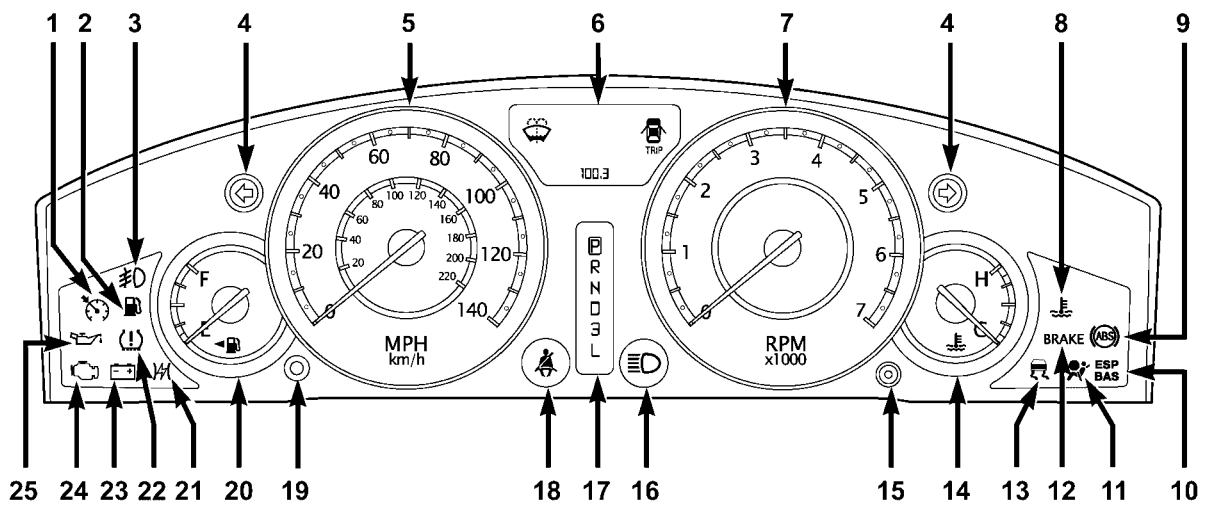

4

PREMIUM INSTRUMENT CLUSTER

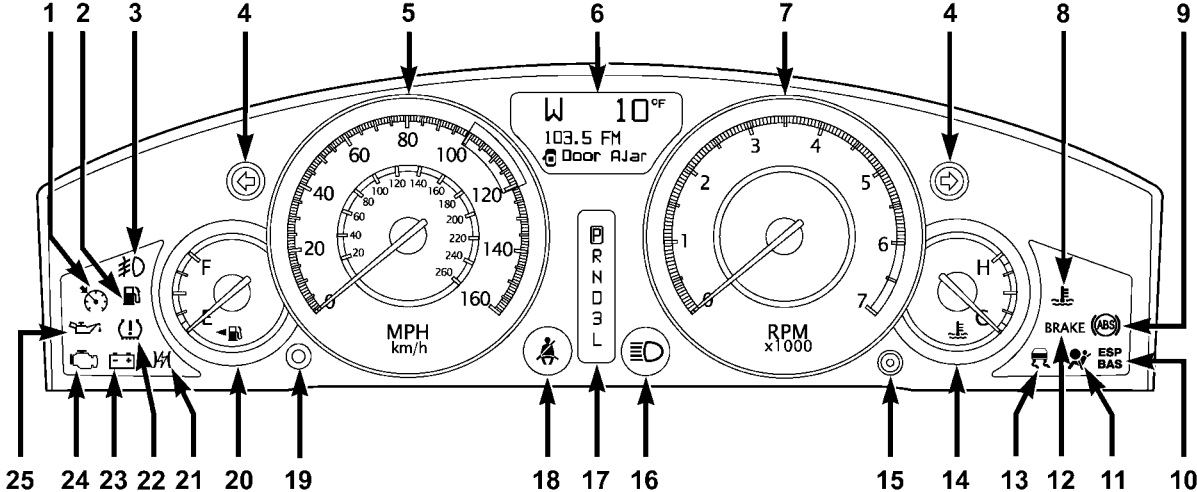

INSTRUMENT CLUSTER DESCRIPTIONS**1. Electronic Speed Control Indicator Light — If Equipped**

This light will illuminate when the electronic speed control is ON.

2. Low Fuel Indicator Light

When the fuel level drops to 1/8 tank, the fuel symbol will light and a single chime will sound.

3. Front Fog Light Indicator — If Equipped

This light shows the front fog lights are ON. (See page 105 for more information.)

4. Turn Signal Indicators

The arrow will flash with the exterior turn signal when the turn signal lever is operated.

If the vehicle electronics sense that the vehicle has traveled about one mile with the turn signals on, a chime will sound to alert you to turn the signals off. If either indicator flashes at a rapid rate, check for a defective outside light bulb. (See page 105 for more information.)

5. Speedometer

Indicates vehicle speed.

6. Electronic Vehicle Information Center Display

When the appropriate conditions exist, this display shows the Electronic Vehicle Information Center (EVIC) messages. (See page 150 for more information.) (only on vehicles equipped with steering wheel mounted switches).

NOTE: On non-EVIC equipped vehicles the odometer is located here.

7. Tachometer

The red segments indicate the maximum permissible engine revolutions-per-minute (r.p.m. x 1000) for each gear range. Before reaching the red area, ease up on the accelerator.

8. Engine Temperature Warning Light

This light illuminates, and will be accompanied by a single chime to warn of an overheated engine condition. The engine temperature is critically hot, and the vehicle should be turned off immediately. The vehicle should be serviced as soon as possible.

9. Anti-Lock Brake Light

 This light monitors the Anti-Lock Brake System. The light will turn on when the ignition switch is turned to the ON position and may stay on for as long as four seconds.

If the ABS light remains on or turns on while driving, it indicates that the Anti-Lock portion of the brake system is not functioning and that service is required. However, the conventional brake system will continue to operate normally if the BRAKE warning light is not on.

If the ABS light is on, the brake system should be serviced as soon as possible to restore the benefits of Anti-Lock brakes. If the ABS light does not turn on when the Ignition switch is turned to the ON position, have the light inspected by an authorized dealer.

10. Electronic Stability Program (ESP) Warning Light/Brake Assist System (BAS) Warning Light — If Equipped

ESP
BAS

The yellow ESP/BAS warning light in the instrument cluster comes on when the ignition switch is turned to the “ON” position. The light should go out with the engine

running. If this light comes on continuously with the engine running, a malfunction has been detected in either the ESP or the BAS system. If the light stays illuminated, have the ESP and BAS checked at your authorized dealer as soon as possible. (See page 119 for more information.)

11. Airbag Light



This light turns on and remains on for 6 to 8 seconds as a bulb check when the ignition switch is first turned ON. If the light is not on during starting, stays on, or turns on while driving, have the system inspected by an authorized dealer as soon as possible. (See page 51 for more information.)

12. Brake System Warning Light

BRAKE This light monitors various brake functions, including brake fluid level and parking brake application. If the brake light turns on, it may indicate that the parking brake is applied, there is a low brake fluid level or there is a problem with the anti-lock brake system.

The dual brake system provides a reserve braking capacity in the event of a failure to a portion of the hydraulic system. Failure of either half of the dual brake system is indicated by the Brake Warning Light which will turn on when the brake fluid level in the master cylinder has dropped below a specified level.

The light will remain on until the cause is corrected.

NOTE: The light may flash momentarily during sharp cornering maneuvers which change fluid level conditions. The vehicle should have service performed, and the brake fluid level checked.

If brake failure is indicated, immediate repair is necessary.

WARNING!

Driving a vehicle with the brake light on is dangerous. Part of the brake system may have failed. It will take longer to stop the vehicle. You could have an accident. Have the vehicle checked immediately.

Vehicles equipped with Anti-Lock brakes (ABS), are also equipped with Electronic Brake Force Distribution (EBD). In the event of an EBD failure, the Brake Warning Light will turn on along with the ABS Light. Immediate repair to the ABS system is required.

The operation of the Brake Warning Light can be checked by turning the ignition switch from the OFF position to the ON position. The light should illuminate for approximately two seconds. The light should then turn off unless the parking brake is applied or a brake fault is detected. If the light does not illuminate, have the light inspected by an authorized dealer.

The light also will turn on when the parking brake is applied with the ignition switch in the ON position.

NOTE: This light shows only that the parking brake is applied. It does not show the degree of brake application.

13. Electronic Stability Program (ESP) Indicator Light/Traction Control System (TCS) Indicator Light — If Equipped



If this indicator light flashes during acceleration, apply as little throttle as possible. While driving, ease up on the accelerator. Adapt your speed and driving to the prevailing road conditions, and do not switch off the ESP, or TCS — if equipped. (See page 117 for more information.)

14. Temperature Gauge

The temperature gauge shows engine coolant temperature. Any reading within the normal range indicates that the engine cooling system is operating satisfactorily.

The gauge pointer will likely indicate a higher temperature when driving in hot weather, up mountain grades, or when towing a trailer. It should not be allowed to exceed the upper limits of the normal operating range.

CAUTION!

Driving with a hot engine cooling system could damage your vehicle. If temperature gauge reads (H), pull over and stop the vehicle. Idle the vehicle with the air conditioner turned off until the pointer drops back into the normal range. If the pointer remains on the "H", and you hear continuous chimes, turn the engine off immediately, and call for service.

WARNING!

A hot engine cooling system is dangerous. You or others could be badly burned by steam or boiling coolant. You may want to call a service center if your vehicle overheats. If you decide to look under the hood yourself, see Section 7 of this manual. Follow the warnings under the Cooling System Pressure Cap paragraph.

15. Trip Odometer Button

Trip Odometer Button — Standard Cluster

The word "TRIP" will appear when this button is pressed. Push in and hold the button for two seconds when the trip odometer is displayed to reset it to 0 miles or kilometers. A second press of the button will display the outside temperature in the odometer.

Trip Odometer Button — Premium Cluster

Press this button to change the display from odometer to either of the two trip odometer settings. The letter "A" or "B" will appear when in the trip odometer mode. Push in and hold the button for two seconds to reset the trip odometer to 0 miles or kilometers. The odometer must be in trip mode to reset.

16. High Beam Light

 This light shows that the headlights are on high beam. Push the Multi-Function lever away from the steering wheel to switch the headlights to high beam.

17. Transmission Range Indicator

This display indicator shows the automatic transmission gear selection.

18. Seat Belt Reminder Light

 When the ignition switch is first turned ON, this light will turn on for 5 to 8 seconds as a bulb check. During the bulb check, if the driver's or front passenger's seat belt is unbuckled, a chime will sound. After the bulb check or when driving, if the driver's or front passenger's seat belt remains unbuckled, the Seat Belt Warning Light will flash or remain on continuously. (See page 37 for more information.)

19. Vehicle Theft Alarm (VTA) Indicator Light — If Equipped

The VTA indicator Light flashes rapidly when the VTA is arming, and slowly when the VTA is armed. (See page 25 for more information.)

20. Fuel Gauge

The pointer shows the level of fuel in the fuel tank when the ignition switch is in the ON position.

21. Electronic Throttle Control (ETC) Light

 This light informs you of a problem with the Electronic Throttle Control system. If a problem is detected the light will come on while the engine is running. Cycle the ignition key when the vehicle has completely stopped and the gear selector is placed in the PARK position. The light should turn off. If the light remains lit with the engine running your vehicle will usually be drivable, however, see your dealer for service as soon as possible. If the light is flashing when the engine is running, immediate service is required and you may experience reduced performance, an elevated/rough idle or engine stall and your vehicle may require towing. The light will come on when the ignition is first turned on and remain on briefly as a bulb check. If the light does not come on during starting, have the system checked by an authorized dealer.

22. Tire Pressure Monitoring Telltale Light — If Equipped

 Each tire, including the spare (if provided), should be checked monthly when cold and inflated to the inflation pressure recommended by the vehicle manufacturer on the vehicle placard or tire inflation pressure label. (If your vehicle has tires of a different size than the size indicated on the vehicle placard or tire inflation pressure label, you should determine the proper tire inflation pressure for those tires.)

As an added safety feature, your vehicle has been equipped with a tire pressure monitoring system (TPMS) that illuminates a low tire pressure telltale when one or more of your tires is significantly under-inflated. Accordingly, when the low tire pressure telltale illuminates, you should stop and check your tires as soon as possible, and inflate them to the proper pressure. Driving on a significantly under-inflated tire causes the tire to overheat and can lead to tire failure. Under-inflation also reduces fuel efficiency and tire tread life, and may affect the vehicle's handling and stopping ability.

Please note that the TPMS is not a substitute for proper tire maintenance, and it is the driver's responsibility to maintain correct tire pressure, even if under-inflation has not reached the level to trigger illumination of the TPMS low tire pressure telltale.

23. Voltage Light



This light monitors the electrical system voltage. The light should turn on momentarily as the engine is started. If the light stays on or turns on while driving, it indicates a problem with the charging system. Immediate service should be obtained.

24. Malfunction Indicator Light



This light is part of an onboard diagnostic system called OBD that monitors engine and automatic transmission control systems. The light will illuminate when the key is in the ON position before engine start. If the bulb does not come on when turning the key from OFF to ON, have the condition checked promptly.

Certain conditions such as a loose or missing gas cap, poor fuel quality, etc. may illuminate the light after engine start. The vehicle should be serviced if the light

stays on through several of your typical driving cycles. In most situations the vehicle will drive normally and will not require towing.

The Malfunction Indicator Light flashes to alert you to serious conditions that could lead to immediate loss of power or severe catalytic converter damage. The vehicle should be serviced as soon as possible if this occurs. (See page 295 for more information.)

25. Oil Pressure Warning Light



This light shows low engine oil pressure. The light should turn on momentarily when the engine is started. If the light turns on while driving, stop the vehicle and shut off the engine as soon as possible. A single chime will sound when this light turns on.

Do not operate the vehicle until the cause is corrected. This light does not show how much oil is in the engine. The engine oil level must be checked using the procedure shown in section 7. (See page 298 for more information.)

ELECTRONIC VEHICLE INFORMATION CENTER (EVIC)

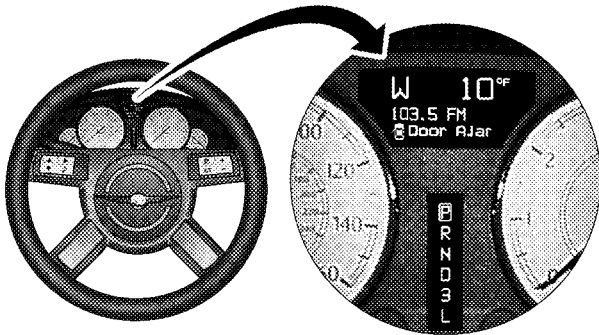

812c4479

Electronic Vehicle Information Center

The Electronic Vehicle Information Center (EVIC) features a driver-interactive display. It is located in the upper part of the cluster between the speedometer and tachometer. Vehicles equipped with steering wheel mounted buttons (described in this section) are also equipped with the EVIC. The EVIC consists of the following:

- System Status

- Vehicle information warning message displays
- Tire Pressure Monitor System (if equipped)
- Personal Settings (customer programmable features)
- Compass display
- Outside temperature display
- Trip computer functions
- UConnect™ hands-free communication system displays (if equipped)
- Navigation system screens (if equipped)
- Audio mode display

The system allows the driver to select information by pressing the following buttons mounted on the steering wheel:



**MENU
Button**

Press and release the MENU button and the mode displayed will change between Trip Functions, Navigation (if equipped), System Status, Personal Settings, and Telephone (if equipped).

**FUNCTION
 SELECT
 Button**

Press the FUNCTION SELECT button to accept a selection. The FUNCTION SELECT button also advances the radio to the next preset station, changes the side of the tape being played (if so equipped), or changes the current CD track being played (if so equipped) when the EVIC is in the Compass/Temp/Audio screen.

**SCROLL
 Button**

Press the SCROLL button to scroll through Trip Functions, Navigation (if equipped), System Status Messages, and Personal Settings (Customer Programmable Features). The SCROLL button also seeks up and down the radio stations, CD track numbers (if so equipped), or satellite radio channels (if so equipped) when the EVIC is in the Compass/Temp/Audio screen.

**AUDIO
 MODE
 Button**

Press the AUDIO MODE button to select the Compass/Temp/Audio screen. This screen displays radio station frequencies, any one of twelve radio station preset frequencies, CD disc number, CD track number, tape, or any one of 200 Satellite radio channels depending on which radio is in the vehicle.

If Compass/Temp/Audio is already displayed when the AUDIO MODE button is pressed, then the radio mode will change from AM to FM, to Tape, to CD, or to Satellite (SAT) accordingly.

Electronic Vehicle Information Center (EVIC) Displays

When the appropriate conditions exist, the Electronic Vehicle Information Center (EVIC) displays the following messages:

- Turn Signal On (with a continuous warning chime)
- Left Front Turn Signal Light Out (with a single chime)
- Left Rear Turn Signal Light Out (with a single chime)
- Right Front Turn Signal Light Out (with a single chime)
- Right Rear Turn Signal Light Out (with a single chime)
- RKE Battery Low (with a single chime)
- Memory #1/#2 Profile Set
- Memory #1/#2 Profile Recall

- Memory System Disabled – Vehicle Not In Park (with a single chime)
- Memory System Disabled – Seat Belt Buckled (with a single chime)
- Personal Settings Not Available – Vehicle Not in Park
- Left/Right Front Door Ajar (one or more, with a single chime if speed is above 1 mph)
- Left/Right Rear Door Ajar (one or more, with a single chime if speed is above 1 mph)
- Door(s) Ajar (with a single chime if vehicle is in motion)
- Trunk Ajar (with a single chime)
- Low Washer Fluid (with a single chime)
- Adjustable Pedals Disabled – Cruise Engaged (with a single chime) — only available on vehicles equipped with memory seats.
- Adjustable Pedals Disabled – Vehicle In Reverse (with a single chime) — only available on vehicles equipped with memory seats.
- Channel 1, 2, OR 3 Transmit
- Channel 1, 2, OR 3 Training
- Channel 1, 2, OR 3 Trained
- Clearing Channels
- Channels Cleared
- Channels Defaulted
- Did Not Train
- Left Front Low Pressure (with a single chime). Refer to “Starting And Operating, Tire Section”
- Left Rear Low Pressure (with a single chime). Refer to “Starting And Operating, Tire Section”
- Right Front Low Pressure (with a single chime). Refer to “Starting And Operating, Tire Section”
- Right Rear Low Pressure (with a single chime). Refer to “Starting And Operating, Tire Section”
- Check TPM System (with a single chime). Refer to “Starting And Operating, Tire Section”

- Check Gascap (refer to “Adding Fuel” in Section 5 of this manual for more details)
- Service Park Assist System (with a single chime)

Trip Functions

Press and release the MENU button until one of the following Trip Functions displays in the EVIC:

- Average Fuel Economy
- Distance To Empty
- Trip A
- Trip B
- Elapsed Time
- Display Units of Measure in

Press the SCROLL button to cycle through all the Trip Computer functions.

The Trip Functions mode displays the following information:

- *Average Fuel Economy*

Shows the average fuel economy since the last reset. When the fuel economy is reset, the display will read “RESET” or show dashes for two seconds. Then, the history information will be erased, and the averaging will continue from the last fuel average reading before the reset.

- *Distance To Empty (DTE)*

Shows the estimated distance that can be travelled with the fuel remaining in the tank. This estimated distance is determined by a weighted average of the instantaneous and average fuel economy, according to the current fuel tank level. DTE cannot be reset through the FUNCTION SELECT button.

NOTE: Significant changes in driving style or vehicle loading will greatly affect the actual drivable distance of the vehicle, regardless of the DTE displayed value.

- When the DTE value is less than 30 miles (48 km) estimated driving distance, the DTE display will change to a text display of "LOW FUEL." This display will continue until the vehicle runs out of fuel. Adding a significant amount of fuel to the vehicle will turn off the "LOW FUEL" text and a new DTE value will display.
- *Trip A*
Shows the total distance travelled for trip A since the last reset.
- *Trip B*
Shows the total distance travelled for trip B since the last reset.
- *Elapsed Time*
Shows the total elapsed time of travel since the last reset when the ignition switch is in the ACC position. Elapsed time will increment when the ignition switch is in the ON or START position.
- *Display Units of Measure in:*
To make your selection, press and release the FUNCTION SELECT button until "US" or "METRIC" appears.

To Reset The Display

Reset will only occur while a resettable function is being displayed. Press and release the FUNCTION SELECT button once to clear the resettable function being displayed. To reset all resettable functions, press and release the FUNCTION SELECT button a second time within 3 seconds of resetting the currently displayed function (>Reset ALL will display during this 3 second window).

Compass Display



The compass readings indicate the direction the vehicle is facing. Press and release the compass button to display one of eight compass readings and the outside temperature.

Automatic Compass Calibration

This compass is self calibrating, which eliminates the need to manually set the compass. When the vehicle is new, the compass may appear erratic and the EVIC will display "CAL" until the compass is calibrated. You may also calibrate the compass by completing one or more 360° turns (in an area free from large metal or metallic objects) until the "CAL" message displayed in the EVIC turns off. The compass will now function normally.

Manual Compass Calibration

If the compass appears erratic and the “CAL” message does not appear in the EVIC display, you must put the compass into the Calibration Mode manually as follows:

To put into a Calibration Mode: Turn on the ignition switch. Then, press and hold the compass button for approximately 2 seconds. Then, press the SCROLL button until “Calibrate Compass” displays in the EVIC. Then, press and release the FUNCTION SELECT button to start the calibration. The message “CAL” will display in the EVIC. Complete one or more 360° turns (in an area free from large metal or metallic objects) until the “CAL” message turns off. The compass will now function normally.

Compass Variance

Compass Variance is the difference between magnetic North and Geographic North. In some areas of the country, the difference between magnetic and geographic North is great enough to cause the compass to give false readings. If this occurs, the compass variance must be set.

NOTE: Magnetic materials should be kept away from the overhead console. This is where the compass sensor is located.

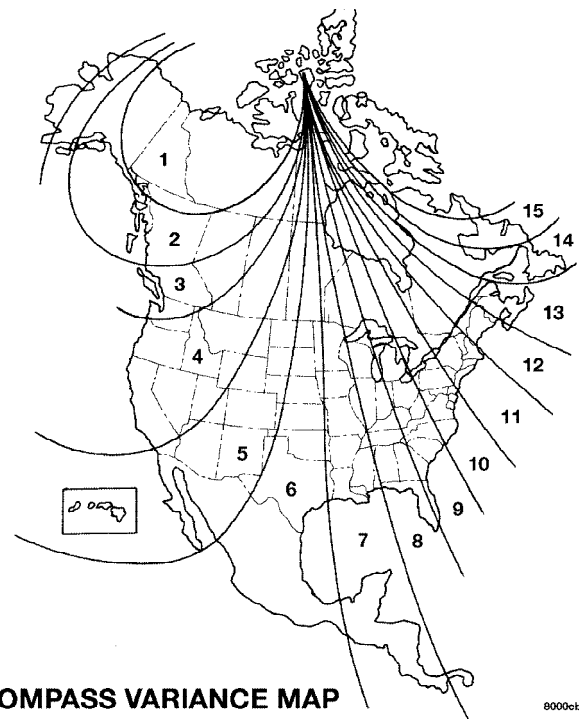

To set the variance: Turn the ignition switch ON. Then, press and hold the compass button for approximately 2 seconds. Then, press the SCROLL button until “Compass Variance” displays in the EVIC. Both the “Compass Variance” message and the last variance zone number will display in the EVIC. Then, press and release FUNCTION SELECT button until the proper variance zone is selected according to the map. Finally, press and release the compass button to exit.

Telephone — If Equipped

Press and release the MENU button until “Telephone” displays in the EVIC.

When the appropriate conditions exist the EVIC provides the following telephone information:

- Phone status: idle, voice mail, roaming, battery strength and signal strength in increments of 20 percent.
- Call status: Incoming call, connecting, connected, air time in minutes and seconds, call ended, call failed, roaming and no phone connection.
- UConnect Active.
- Caller ID phone number display.

When the appropriate conditions exist, and if supported by the cell phone, the EVIC will display the following telephone symbols:



Signal Strength

The EVIC displays this symbol to indicate the signal strength of the UConnect™ phone. The number of horizontal bars increase as the strength of the UConnect™ phone signal increases.



Incoming Call

The EVIC displays this symbol to indicate an incoming call.



Analog

The EVIC displays this symbol to indicate that the UConnect™ phone is currently in analog mode.



Roaming

The EVIC displays this symbol to indicate that the UConnect™ phone is currently roaming.



The EVIC displays this symbol to indicate that you have voice mail.

Voice Mail



The EVIC displays this symbol to indicate a text message.

Text Message



The EVIC displays this symbol to indicate the battery strength of the UConnect™ phone.

Battery Strength



The EVIC displays this symbol to indicate that a phone connection has been made.

Call in Progress



The EVIC displays this symbol to indicate that the UConnect™ phone is currently not available.

Phone Not Available

Navigation — If Equipped

Navigation Display Control

Press and release the MENU button until Navigation displays in the EVIC. When the Navigation System is On, the steering wheel buttons can be used to select the Map or Menu display on the Navigation Unit. When the Menu display is active, the SCROLL button can be used to scroll through the list, the FUNCTION SELECT button can be used to select an item, and the AUDIO MODE button can be used to return to the previous menu. When the Map display is active, pressing the FUNCTION SELECT button will change the Navigation Unit Display to the Menu.

Turn By Turn Directions

The EVIC displays turn-by-turn directions to a programmed destination when Turn by Turn Navigation is enabled through Personal Settings. When enabled, the EVIC displays the name of the approaching road at the top of the screen, followed by an arrow to indicate the direction to turn the vehicle, and a count down to indicate the distance to the turn.

NOTE: Refer to your “Navigation User’s Manual” for detailed operating instructions.

Personal Settings (Customer Programmable Features)

Personal Settings allows the driver to set and recall features when the transmission is in PARK.

Press and release the MENU button until Personal Settings displays in the EVIC.

Use the SCROLL button to display one of the following choices:

“Language”

When in this display you may select one of five languages for all display nomenclature, including the trip

functions and the navigation system (if equipped). Press the FUNCTION SELECT button while in this display to select English, Espanol, Deutsch, Italiano, or Francais. Then, as you continue, the information will display in the selected language.

NOTE: The EVIC will not change the UConnect™ language selection. Please refer to “Language Selection” in the HANDS-FREE COMMUNICATION (UConnect™) section of this manual for details.

“Lock Doors Automatically at 15 mph (24 Km/h)”

When ON is selected, all doors will lock automatically when the vehicle reaches a speed of 15 mph (24 km/h). To make your selection, press and release the FUNCTION SELECT button until “ON” or “OFF” appears.

“Unlock Doors Automatically on Exit”

When ON is selected, all doors will unlock when the vehicle is stopped and the transmission is in the P (Park) or N (Neutral) position and the driver’s door is opened. To make your selection, press and release the FUNCTION SELECT button until “ON” or “OFF” appears.

“Remote Key Unlock”

When **Driver Door 1st Press** is selected, only the driver’s door will unlock on the first press of the remote keyless entry unlock button. When **Driver Door 1st Press** is selected, you must press of the remote keyless entry unlock button twice to unlock the passenger’s doors. When **All Doors 1st Press** is selected, all of the doors will unlock on the first press of the remote keyless entry unlock button. To make your selection, press and release the **FUNCTION SELECT** button until “Driver Door 1st Press” or “All Doors 1st Press” appears.

“Sound Horn with Remote Key Lock”

When **ON** is selected, a short horn sound will occur when the remote keyless entry “Lock” button is pressed. This feature may be selected with or without the flash lights on lock/unlock feature. To make your selection, press and release the **FUNCTION SELECT** button until “ON” or “OFF” appears.

“Flash Lights with Remote Key Lock”

When **ON** is selected, the front and rear turn signals will flash when the doors are locked or unlocked with the remote keyless entry transmitter. This feature may be selected with or without the sound horn on lock feature selected. To make your selection, press and release the **FUNCTION SELECT** button until “ON” or “OFF” appears.

“Delay Turning Headlights Off”

When this feature is selected, the driver can choose to have the headlights remain on for 0, 30, 60, or 90 seconds when exiting the vehicle. To make your selection, press and release the **FUNCTION SELECT** button until “0,” “30,” “60,” or “90” appears.

“Turn Headlights On with Remote Key Unlock”

When this feature is selected, the headlights will activate and remain on for up to 90 seconds when the doors are unlocked with the remote keyless entry transmitter. To make your selection, press and release the **FUNCTION SELECT** button until “OFF,” “30 sec.,” “60 sec.,” or “90 sec.” appears.

“Delay Power Off to Accessories Until Exit”

When this feature is selected, the power window switches, radio, hands-free system (if equipped), DVD video system (if equipped), power sunroof (if equipped), and power outlets will remain active for up to 60 minutes after the ignition switch is turned off. Opening a vehicle door will cancel this feature. To make your selection, press and release the FUNCTION SELECT button until “Off,” “45 sec.,” “5 min.,” “10 min.,” “30 min.,” or “60 min.” appears.

“Confirmation of Voice Commands” — If Equipped

When ON is selected, all voice commands from the UConnect™ system are confirmed. To make your selection, press and release the FUNCTION SELECT button until “ON” or “OFF” appears.

“Turn by Turn Navigation” — If Equipped

When ON is selected, the Turn-by-Turn directions will appear in the display as the vehicle approaches a designated turn within a programmed route. To make your selection, press and release the FUNCTION SELECT button until “ON” or “OFF” appears.

“Display Units of Measure in”

The EVIC, odometer, and navigation system (if equipped) can be changed between English and Metric units of measure. To make your selection, press and release the FUNCTION SELECT button until “US” or “METRIC” appears.

“Recall Memory with Remote Key Unlock” — If Equipped

When ON is selected, you can use your Remote Keyless Entry Transmitter to recall one of two pre-programmed memory profiles. Each memory profile contains desired driver seat, side mirror, adjustable pedals (if equipped), and power tilt and telescopic steering column (if equipped) position settings, and a set of desired radio station presets. When OFF is selected, only the memory switch on the driver’s door panel will recall memory profiles. To make your selection, press and release the FUNCTION SELECT button until “ON” or “OFF” appears. Refer to “Driver Memory Seat” in Section 3 of this manual for more information.

“Rain Sensing Intermittent Wipers” — If Equipped

When ON is selected, the system will automatically activate the windshield wipers if it senses moisture on the windshield. To make your selection, press and release the FUNCTION SELECT button until “ON” or “OFF” appears. When OFF is selected, the system reverts to the standard intermittent wiper operation.

“Automatically Move Seat Back on Exit” — If Equipped

This feature provides automatic driver seat positioning to enhance driver mobility when entering and exiting the vehicle. This feature is turned OFF when the vehicle is delivered from the factory. To make your selection, press and release the FUNCTION SELECT button until “ON” or “OFF” appears.

NOTE: The seat will return to the memorized seat location (if Recall Memory with Remote Key Unlock is set to ON) when the remote keyless entry transmitter is used to unlock the door. Refer to “Easy Entry/Exit Seat” under “Driver Memory Seat” in Section 3 of this manual for more information.

“Tilt Mirrors Down in Reverse” — If Equipped

When ON is selected, the outside rearview mirrors will tilt downward when the ignition switch is in the ON position and the transmission is in the R (Reverse) position. The mirrors will move back to their previous position when the transmission is shifted out of R (Reverse). To make your selection, press and release the FUNCTION SELECT button until “ON” or “OFF” appears.

“Park Assist System” — If Equipped

When ON is selected, the system will scan for objects behind the vehicle when the transmission is in the R (Reverse) or N (Neutral) position. To make your selection, press and release the FUNCTION SELECT button until “ON” or “OFF” appears.

“Headlights On With Wipers” (Available with Auto Headlights Only)

When ON is selected, and the headlight switch is in the AUTO position, the headlights will turn on approximately 10 seconds after the wipers are turned on. The headlights will also turn off when the wipers are turned off if they were turned on by this feature. To make your selection, press and release the FUNCTION SELECT button until “ON” or “OFF” appears.

NOTE: Turning the headlights on during the daytime causes the instrument panel lights to dim. To increase the brightness, refer to “Lights” in Section 3 of this manual.

“Automatic High Beams” — If Equipped

When this feature is selected, the high beam headlights will deactivate automatically under certain conditions. To make your selection, press and release the FUNCTION SELECT button until “ON” or “OFF” appears. Refer to “SmartBeams” in section 3 of this manual for more information.

SETTING THE ANALOG CLOCK

To set the analog clock at the top center of the instrument panel, press and hold the button until the setting is correct.

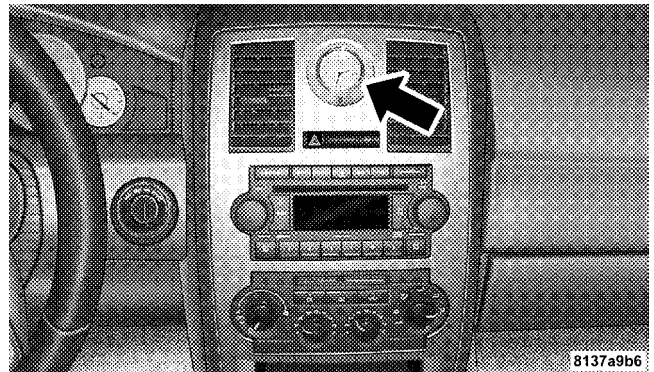

Analog Clock

RADIO GENERAL INFORMATION

Radio Broadcast Signals

Your new radio will provide excellent reception under most operating conditions. Like any system, however, car radios have performance limitations, due to mobile operation and natural phenomena, which might lead you to believe your sound system is malfunctioning. To help you understand and save you concern about these “apparent” malfunctions, you must understand a point or two about the transmission and reception of radio signals.

Two Types of Signals

There are two basic types of radio signals... AM or Amplitude Modulation, in which the transmitted sound causes the amplitude, or height, of the radio waves to vary... and FM or Frequency Modulation, in which the frequency of the wave is varied to carry the sound.

Electrical Disturbances

Radio waves may pick up electrical disturbances during transmission. They mainly affect the wave amplitude,

and thus remain a part of the AM reception. They interfere very little with the frequency variations that carry the FM signal.

AM Reception

AM sound is based on wave amplitude, so AM reception can be disrupted by such things as lightning, power lines and neon signs.

FM Reception

Because FM transmission is based on frequency variations, interference that consists of amplitude variations can be filtered out, leaving the reception relatively clear, which is the major feature of FM radio.

NOTE: For vehicles not equipped with the Electronic Vehicle Information Center (EVIC), the radio, steering wheel radio controls (if equipped), and 6 disc CD/DVD changer (if equipped) will remain active for 10 minutes after the ignition switch is turned off. Opening either front door will cancel this feature.

NOTE: For vehicles equipped with the Electronic Vehicle Information Center (EVIC), the radio, steering wheel radio controls (if equipped), and 6 disc CD/DVD changer (if equipped) will remain active for up to 60 minutes after the ignition switch is turned off. Opening either front door will cancel this feature. The time is programmable through the Electronic Vehicle Information Center (EVIC). Refer to “Delay Power Off to Accessories Until Exit” under “Personal Settings (Customer Programmable Features)” under “Electronic Vehicle Information Center (EVIC)” in Section 4 of this manual for details.

SALES CODE REF — AM/FM/CD (SINGLE DISC) RADIO WITH OPTIONAL SATELLITE RADIO AND HANDS FREE PHONE CAPABILITY

NOTE: The radio sales code is located on the lower right side of your radio faceplate.

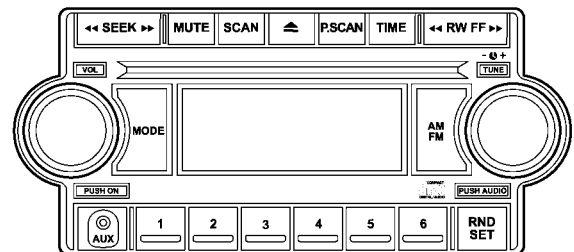

815eb156

REF Radio

Operating Instructions - Radio Mode

NOTE: The ignition switch must be in the ON or ACC position to operate the radio.

Power Switch/Volume Control (Rotary)

Press the ON/VOL control to turn the radio ON. Press the ON/VOL a second time to turn OFF the radio.

Electronic Volume Control

The electronic volume control turns continuously (360 degrees) in either direction without stopping. Turning the volume control to the right increases the volume and to the left decreases it.

When the audio system is turned on, the sound will be set at the same volume level as last played.

For your convenience, the volume can be turned down, but not up, when the audio system is off and the ignition is ON.

Mode Button (Radio Mode)

Press the mode button repeatedly to select between the CD player or Satellite Radio (if equipped).

SEEK Button (Radio Mode)

Press and release the SEEK button to search for the next listenable station in either AM/FM or Satellite (if equipped) mode. Press the right side of the button to seek up and the left side to seek down. The radio will remain tuned to the new station until you make another selection. Holding the button will bypass stations without stopping until you release it.

MUTE Button (Radio Mode)

Press the MUTE button to cancel the sound from the speakers. "MUTE" will be displayed. Press the MUTE button a second time and the sound from the speakers will return. Rotating the volume control, turning the radio ON/OFF, or turning ON/OFF the ignition, will cancel the MUTE feature.

NOTE: In Hands Free Phone (if equipped) mode, the MUTE button mutes the microphone.

SCAN Button (Radio Mode)

Pressing the SCAN button causes the tuner to search for the next listenable station, in either AM, FM or Satellite (if

equipped) frequencies, pausing for 5 seconds at each listenable station before continuing to the next. To stop the search, press SCAN a second time.

PSCAN Button (Radio Mode)

Pressing the PSCAN button, causes the tuner to scan through preset stations, in either AM, FM or Satellite (if equipped) frequencies, pausing for 5 seconds at each preset station before continuing to the next. To stop the search, press PSCAN a second time.

Time Button

Press the time button and the time of day will be displayed for 5 seconds.

Clock Setting Procedure

1. Press and hold the time button until the hours blink.
2. Adjust the hours by turning the right side Tune/Audio control.
3. After the hours are adjusted, press the right side Tune/Audio control to set the minutes. The minutes will begin to blink.

4. Adjust the minutes using the right side Tune/Audio control.

5. To exit, press any button/knob or wait 5 seconds.

RW/FF (Radio Mode)

Pressing the rewind/fast forward button causes the tuner to search for the next frequency in the direction of the arrows. This feature operates in either AM, FM or Satellite (if equipped) frequencies.

TUNE Control (Radio Mode)

Turn the right side rotary control clockwise to increase or counter-clockwise to decrease the frequency.

AM/FM Button (Radio Mode)

Press the button to select AM or FM Modes.

Setting the Tone, Balance, and Fade

Press the rotary TUNE control and BASS will be displayed. Turn the TUNE control to the right or left to increase or decrease the Bass tones.

Press the rotary TUNE control a second time and MID will be displayed. Turn the TUNE control to the right or left to increase or decrease the Mid Range tones.

Press the rotary TUNE control a third time and TREB will be displayed. Turn the TUNE control to the right or left to increase or decrease the Treble tones.

Press the rotary TUNE control a fourth time and BAL will be displayed. Turn the TUNE control to the right or left to adjust the sound level from the right or left side speakers.

Press the rotary TUNE control a fifth time and FADE will be displayed. Turn the TUNE control to the left or right to adjust the sound level between the front and rear speakers.

Press the tune control again or wait 5 seconds to exit setting tone, balance, and fade.

RND/SET Button (Radio Mode) To SET The Push-Button Memory

When you are receiving a station that you wish to commit to push-button memory, press the SET button. The symbol SET 1 will now show in the display window. Select the button (1-6) you wish to lock onto this station and press and release that button. If a button is not

selected within 5 seconds after pressing the SET button, the station will continue to play but will not be stored into push-button memory.

You may add a second station to each push-button by repeating the above procedure with this exception: Press the SET button twice and SET 2 will show in the display window. Each button can be set for SET 1 and SET 2 in both AM and FM. This allows a total of 12 AM, 12 FM and 12 Satellite (if equipped) stations to be stored into push-button memory. The stations stored in SET 2 memory can be selected by pressing the push-button twice.

Every time a preset button is used a corresponding button number will be displayed.

Preset Buttons 1 - 6 (Radio Mode)

These buttons tune the Radio to the stations that you commit to push-button memory {12 AM, 12 FM, and 12 Satellite (if equipped) stations}.

Operation Instructions - CD Mode

NOTE: The ignition switch must be in the ON or ACC position to operate the radio.

Inserting The Compact Disc (Single CD Player)

Gently insert one CD into the CD player with the CD label facing up. The CD will automatically be pulled into the CD Player and the CD icon will illuminate on the radio display.

If the volume control is ON, the unit will switch to CD mode and begin to play. The display will show the track number and play time in minutes and seconds. Play will begin at the start of track one.

NOTE:

- On some vehicles you may insert or eject a disc with the radio or ignition switch OFF.
- If you insert a disc with the ignition ON and the radio OFF, the CD will automatically be pulled into the CD Player.
- This radio does not play discs with MP3 tracks.

SEEK Button (CD Mode)

Press the right side of the SEEK button for the next track on the CD. Press the left side of the button to return to the beginning of the current track, or return to the beginning of the previous track if the CD is within the first 10 seconds of the current selection.

MUTE Button (CD Mode)

Press the MUTE button to cancel the sound from the speakers. "MUTE" will be displayed. Press the MUTE button a second time and the sound from the speakers will return. Rotating the volume control or turning OFF the ignition will also return the sound from the speakers.

SCAN Button (CD Mode)

Press this button to play the first 10 seconds of each track. To stop the scan function, press the button a second time.

EJECT Button (CD Mode)

Press this button and the disc will unload and move to the entrance for easy removal. The unit will switch to the last selected mode.

If you do not remove the disc within 15 seconds, it will be reloaded. The radio mode will continue to appear.

TIME Button (CD Mode)

Press this button to change the display from elapsed CD playing time to time of day. The time of day will be displayed for 5 seconds.

RW/FF (CD Mode)

Press and hold the FF (Fast Forward) and the CD player will begin to fast forward until FF is released. The RW (Reverse) button works in a similar manner.

RND/SET Button (Random Play Button) (CD Mode)

Press this button while the CD is playing to activate Random Play. This feature plays the selections on the compact disc in random order to provide an interesting change of pace.

Press the SEEK button to move to the next randomly selected track.

Press and hold the FF button to fast forward through the tracks. Release the FF button to stop the fast forward feature. If the RW button is pressed, the current track will reverse to the beginning of the track and begin playing.

Press the RND button a second time to stop Random Play.

Operation Instructions - Auxiliary Mode

The auxiliary (AUX) jack is an audio input jack, which allows the user to plug in a portable device such as an MP3 player, cassette player or microphone and utilize the vehicle's audio system to amplify the source and play through the vehicle speakers.

The auxiliary mode becomes active when an electrical device is plugged into the AUX jack using a standard 3.5 mm stereo audio cable and the user presses and releases the MODE button until AUX appears on the display.

NOTE: The radio will return to the last stored mode if the ignition switch is turned from the OFF/LOCK position to the ACC position, the radio is turned on, and the radio was previously in the AUX mode.

SEEK Button (Auxiliary Mode)

No function.

MUTE Button (Auxiliary Mode)

Press the MUTE button to cancel the sound from the speakers. "MUTE" will be displayed. Press the MUTE button a second time and the sound from the speakers will return. Rotating the volume control or turning OFF the ignition will also return the sound from the speakers.

SCAN Button (Auxiliary Mode)

No function.

EJECT Button (Auxiliary Mode)

No function.



PSCAN Button (Auxiliary Mode)

No function.

TIME Button (Auxiliary Mode)

Press this button to change the display from elapsed playing time to time of day. The time of day will be displayed for 5 seconds.

RW/FF (Auxiliary Mode)

No function.

RND/SET Button (Auxiliary Mode)

No function.

Mode Button (Auxiliary Mode)

Press the mode button repeatedly to select between the CD player or Satellite Radio (if equipped).

Operating Instructions - Hands Free Phone — If Equipped

Refer to the HANDS FREE PHONE (UConnect™) section of the Owner's Manual.

Operating Instructions - Satellite Radio — If Equipped

Refer to the Satellite Radio section of the Owner's Manual.

SALES CODE RAK – AM/FM/CASSETTE/CD (6-DISC) RADIO WITH OPTIONAL SATELLITE RADIO, HANDS FREE PHONE, VIDEO, MP3, and WMA CAPABILITIES

NOTE: The radio sales code is located on the lower right side of your radio faceplate.

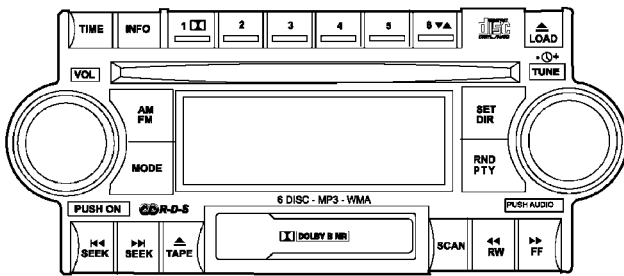

8132a436

RAK Radio

Operating Instructions - Radio Mode

NOTE: The ignition switch must be in the ON or ACC position to operate the radio.

Power Switch/Volume Control (Rotary)

Press the ON/VOL control to turn the radio ON. Press the ON/VOL a second time to turn OFF the radio.

Electronic Volume Control

The electronic volume control turns continuously (360 degrees) in either direction without stopping. Turning the volume control to the right increases the volume and to the left decreases it.

When the audio system is turned on, the sound will be set at the same volume level as last played.

Mode Button (Radio Mode)

Press the mode button repeatedly to select between the CD player, Cassette, Satellite, or Vehicle Entertainment System (VES) (if equipped).

SEEK Button (Radio Mode)

Press and release the SEEK button to search for the next station in either AM/FM or Satellite (if equipped) mode. Press the right side of the button to seek up and the left side to seek down. The radio will remain tuned to the new station until you make another selection. Holding the button and will bypass stations without stopping until you release it.

SCAN Button (Radio Mode)

Pressing the SCAN button causes the tuner to search for the next station, in either AM, FM or Satellite (if equipped) frequencies, pausing for 5 seconds (satellite scan 8 seconds) at each listenable station before continuing to the next. To stop the search, press SCAN a second time.

Time Button

Press the time button and the time of day will be displayed for 5 seconds.

Clock Setting Procedure

1. Press and hold the time button until the hours blink.
2. Adjust the hours by turning the right side Tune/Audio control.
3. After the hours are adjusted, press the right side Tune/Audio control to set the minutes. The minutes will begin to blink.
4. Adjust the minutes using the right side Tune/Audio control.
5. To exit, press any button/knob or wait 5 seconds.

INFO Button (Radio Mode)

Press the INFO button for an RBDS station (one with call letters displayed). The radio will return a Radio Text message broadcast (if available) from an FM station (FM mode only).

RW/FF (Radio Mode)

Pressing the rewind/fast forward button causes the tuner to search for the next frequency in the direction of the arrows. This feature operates in either AM, FM or Satellite (if equipped) frequencies.

TUNE Control (Radio Mode)

Turn the right side rotary control to increase or decrease the frequency.

AM/FM Button (Radio Mode)

Press the button to select AM or FM Modes.

Setting the Tone, Balance, and Fade

Press the rotary TUNE control and BASS will display. Turn the TUNE control to the right or left to increase or decrease the Bass tones.

Press the rotary TUNE control a second time and MID will display. Turn the TUNE control to the right or left to increase or decrease the Mid Range tones.

Press the rotary TUNE control a third time and TREBLE will display. Turn the TUNE control to the right or left to increase or decrease the Treble tones.

Press the rotary TUNE control a fourth time and BAL will display. Turn the TUNE control to the right or left to adjust the sound level from the right or left side speakers.

Press the rotary TUNE control a fifth time and FADE will display. Turn the TUNE control to the right or left to adjust the sound level between the front and rear speakers.

Press the rotary TUNE control again to exit setting tone, balance and fade.

RND/PTY Button (Radio Mode)

Pressing this button once will turn on the PTY mode for 5 seconds. If no action is taken during the 5 second time out the PTY icon will turn off. Turning the tune knob within 5 seconds will allow the program format type to be selected. Many radio stations do not currently broadcast PTY information.

Turn the tune knob to select the following format types:

Program Type	16 Digit-Character Display
No program type or undefined	None
News	News
Information	Information
Sports	Sports
Talk	Talk
Rock	Rock
Classic Rock	Classic_Rock
Adult Hits	Adult_Hits
Soft Rock	Soft_Rock
Top 40	Top_40
Country	Country
Oldies	Oldies
Soft	Soft
Nostalgia	Nostalgia
Jazz	Jazz
Classical	Classical
Rhythm and Blues	Rhythm_and_Blues

Soft Rhythm and Blues	Soft_R_&_B
Foreign Language	Foreign_Language
Religious Music	Religious_Music
Religious Talk	Religious_Talk
Personality	Personality
Public	Public
College	College
Unassigned	
Weather	Weather

By pressing the SEEK button when the PTY icon is displayed, the radio will be tuned to the next frequency station with the same selected PTY name. The PTY function only operates when in the FM mode.

If a preset button is activated while in the PTY (Program Type) mode, the PTY mode will be exited and the radio will tune to the preset station.

NOTE: If you have selected a PTY with the tune knob, simply pressing the tune button in will go directly to a "PTY seek".

Buttons 1 - 6 (Radio Mode)

These buttons tune the Radio to the stations that you commit to push-button memory {12 AM, 12 FM, and 12 Satellite (if equipped) stations}.

Operating Instructions — Tape Player

Insert the cassette with the exposed tape side toward the left and the mechanical action of the player will gently pull the cassette into the play position.

NOTE: When subjected to extremely cold temperatures, the tape mechanism may require a few minutes to warm up for proper operation. Sometimes poor playback may be experienced due to a defective cassette tape. Clean and demagnetize the tape heads at least twice a year.

Seek Button

Press the SEEK button up for the next selection on the tape and down to return to the beginning of the current selection.

Press the SEEK button up or down to move the track number to skip forward or backward 1 to 6 selections. Press the SEEK button once to move 1 selection, twice to move 2 selections, etc.

Fast Forward (FF)

Press the FF button momentarily to advance the tape in the direction that it is playing. The tape will advance until the button is pressed again or the end of the tape is reached. At the end of the tape, the tape will play in the opposite direction.

Rewind (RW)

Press the RW button momentarily to reverse the tape direction. The tape will reverse until the button is pressed again or until the end of the tape is reached. At the end of the tape, the tape will play in the opposite direction.

Tape Eject

Press this button and the cassette will disengage and eject from the radio.

Scan Button

Press this button to play 10 seconds of each selection. Press the scan button a second time to cancel the feature.

Changing Tape Direction

If you wish to change the direction of tape travel (side being played), press Preset 6. The lighted arrow in the display window will show the new direction.

Metal Tape Selection

If a standard metal tape is inserted into the player, the player will automatically select the correct equalization.

Pinch Roller Release

If ignition power or the radio ON/OFF switch are turned off, the pinch roller will automatically retract to protect the tape from any damage. When power is restored to the tape player, the pinch roller will automatically reengage and the tape will resume play.

Noise Reduction

The Dolby Noise Reduction System* is on whenever the tape player is on, but may be switched off.

To turn off the Dolby Noise reduction System: Press Preset 1 after you insert the tape. The NR light in the display will go off when the Dolby System is off.

* "Dolby" noise reduction manufactured under license from Dolby Laboratories Licensing Corporation. Dolby and the double-D symbol are trademarks of Dolby Laboratories Licensing Corporation.

Operation Instructions - (CD MODE for CD Audio Play)

NOTE: The ignition switch must be in the ON or ACC position to operate the radio.

NOTE: Note: This Radio is capable of playing compact discs (CD), recordable compact discs (CD-R), rewritable compact discs (CD-RW) compact discs with MP3 tracks and multisession compact discs with CD and MP3 tracks and WMA.

Inserting Compact Disc(s)

CAUTION!

This CD player will accept 4 3/4 inch (12 cm) discs only. The use of other sized discs may damage the CD player mechanism.

You may eject a disc with the radio OFF.

If you insert a disc with the ignition ON and the radio ON, the unit will switch from radio to CD mode and begin to play when you insert the disc. The display will show the disc number, the track number, and index time in minutes and seconds. Play will begin at the start of track 1.

SEEK Button (CD MODE for CD Audio Play)

Press the right side of the SEEK button for the next selection on the CD. Press the left side of the button to return to the beginning of the current selection, or return to the beginning of the previous selection if the CD is within the first 5 seconds of the current selection.

SCAN Button (CD MODE for CD Audio Play)

Press the Scan button to scan through each track on the CD currently playing.

LOAD/EJECT Button (CD Mode for CD Audio Play)

LOAD/EJECT - Load



LOAD

Press the LOAD/EJT button and the push-button with the corresponding number where the CD is being loaded. The radio will display PLEASE WAIT and prompt when to INSERT DISC. After the radio displays "INSERT DISC" insert the CD into the player.

Radio display will show "LOADING DISC" when the disc is loading, and "READING DISC" when the radio is reading the disc.

LOAD/EJT - Eject



LOAD

Press the LOAD/EJT button and the push-button with the corresponding number where the CD was loaded and the disc will unload and move to the entrance for easy removal.

Radio display will show "EJECTING DISC" when the disc is being ejected and prompt the user to remove the disc.

Press and hold the LOAD/EJT button for 5 seconds and all CDs will be ejected from the radio.

If you have ejected a disc and have not removed it within 15 seconds, it will be reloaded. If the CD is not removed, the radio will continue to play the non-removed CD. If the CD is removed and there are other CD's in the radio, the radio will play the next CD after a 2 minute timeout. If the CD is removed and there are no other CD's in the radio, the radio will remain in CD mode and display "INSERT DISC" for 2 minutes. After 2 minutes the radio will go to the previous tuner mode.

The disc can be ejected with the radio and ignition OFF.

TIME Button (CD MODE for CD Audio Play)

Press this button to change the display from a large CD playing time display to a small CD playing time display.

RW/FF (CD MODE for CD Audio Play)

Press and hold FF (Fast Forward) and the CD player will begin to fast forward until FF is released or RW or another CD button is pressed. The RW (Reverse) button works in a similar manner.

TUNE Control (CD MODE for CD Audio Play)

Pressing the TUNE control allows the setting of the Tone, Fade, and Balance. See Radio Mode.

AM/FM Button (CD MODE for CD Audio Play)

Switches the Radio to the Radio mode.

RND/PTY Button (Random Play Button) (CD MODE for CD Audio Play)

Press this button while the CD is playing to activate Random Play. This feature plays the selections on the compact disc in random order to provide an interesting change of pace.

NOTE: MP3 and WMA Random Play are for file folders only.

Press the SEEK button to move to the next randomly selected track.

Press and hold the FF button to fast forward through the tracks. Release the FF button to stop the fast forward feature. If the RW button is pressed, the current track will reverse to the beginning of the track and begin playing.

Press the RND button a second time to stop Random Play.

Buttons 1 - 6 (CD MODE for CD Audio Play)

Selects disc positions 1 - 6 for Play/Load/Eject.

Notes On Playing MP3 Files

The radio can play MP3 files, however, acceptable MP3 file recording media and formats are limited. When writing MP3 files, pay attention to the following restrictions.

Supported Media (Disc Types)

The MP3 file recording media supported by the radio are CD-ROM, CD-R and CD-RW.

Supported Medium Formats (File Systems)

The medium formats supported by the radio are ISO 9660 Level 1 and Level 2 and includes the Joliet extension. When reading discs recorded using formats other than ISO 9660 Level 1 and Level 2, the radio may fail to read files properly and may be unable to play the file normally. UDF and Apple HFS formats are not supported.

The radio uses the following limits for file systems:

- Maximum number of directory levels: 15
- Maximum number of files: 255
- Maximum number of folders: 100
- Maximum number of characters in file/folder names:
 - Level 1: 12 (including a separator "." and a 3-character extension)
 - Level 2: 31 (including a separator "." and a 3-character extension)

Multisession disc formats are supported by the radio. Multisession discs may contain combinations of normal CD audio tracks and computer files (including MP3 files). Discs created with an option such as "keep disc open after writing" are most likely multisession discs. The use of multisession for CD audio or MP3 playback may result in longer disc loading times.

Supported MP3 File Formats

The radio will recognize only files with the *.mp3 extension as MP3 files. Non-MP3 files named with the *.mp3 extension may cause playback problems. The radio is designed to recognize the file as an invalid MP3 and will not play the file.

When using the MP3 encoder to compress audio data to an MP3 file, the bit rate and sampling frequencies in the following table are supported. In addition, variable bit rates (VBR) are also supported. The majority of MP3 files use a 44.1 kHz sampling rate and a 192, 160, 128, 96 or VBR bit rates.

MPEG Specification	Sampling Frequency (kHz)	Bit rate (kbps)
MPEG-1 Audio Layer 3	48, 44.1, 32	320, 256, 224, 192, 160, 128, 112, 96, 80, 64, 56, 48, 40, 32
MPEG-2 Audio Layer 3	24, 22.05, 16	160, 128, 144, 112, 96, 80, 64, 56, 48, 40, 32, 24, 16, 8

ID3 Tag information for artist, song title and album title are supported for version 1 ID3 tags. ID3 version 2 is not supported by the radios.

Playlist files are not supported. MP3 Pro files are not supported.

Playback of MP3 and WMA Files

When a medium containing MP3 data is loaded, the radio checks all files on the medium. If the medium contains a lot of folders or files, the radio will take more time to start playing the MP3 files.

Loading times for playback of MP3 and WMA files may be affected by the following:

- Media - CD-RW media may take longer to load than CD-R media
- Medium formats - Multisession discs may take longer to load than non-multisession discs
- Number of files and folders - Loading times will increase with more files and folders

To increase the speed of disc loading, it is recommended to use CD-R media and single-session discs. To create a single-session disc, enable the Disc at Once option before writing to the disc.

Operation Instructions - (CD Mode for MP3 and WMA Audio Play)

SEEK Button (CD Mode for MP3 and WMA Play)

Pressing the right side of the SEEK button plays the next file. Pressing the left side of the SEEK button plays the beginning of the file. Pressing the button within the first ten seconds plays the previous file.

LOAD/EJECT Button (CD Mode for MP3 and WMA Play)

LOAD/EJT - Load



Press the LOAD/EJT button and the push-button with the corresponding number where the CD is being loaded. The radio will display PLEASE WAIT and prompt when to INSERT DISC. After the radio displays "INSERT DISC" insert the CD into the player.

The radio display will show "LOADING DISC" when the disc is loading.

LOAD/EJT - Eject



Press the LOAD/EJT button and the push-button with the corresponding number where the CD was loaded and the disc will unload and move to the entrance for easy removal. Radio display will show "EJECTING DISC" when the disc is being ejected and prompt the user to remove the disc.

If you have ejected a disc and have not removed it within 15 seconds, it will be reloaded. If the CD is not removed, the radio will continue to play the non-removed CD. If the CD is removed and there are other CD's in the radio, the radio will play the next CD after a 2 minute timeout. If the CD is removed and there are no other CD's in the radio, the radio will remain in CD mode and display "INSERT DISC" for 2 minutes. After 2 minutes the radio will go to the previous tuner mode.

INFO Button (CD Mode for MP3 Play)

Press and INFO button while playing MP3 or WMA disc. The radio scrolls through the following TAG information: Song Title, Artist, File Name, and Folder Name (if available).

Press the INFO button once more to return to "elapsed time" priority mode.

Press and hold the INFO button while in the message display priority mode or elapsed time display priority mode will display the song title for each file.

RW/FF (CD Mode for MP3 and WMA Play)

Press the FF side of the button to move forward through the file or MP3 and WMA selection.

TUNE Control (CD Mode for MP3 Play)

Pressing the TUNE Control allows the adjustment of Tone, Balance, and Fade.

AM/FM Button (CD Mode for MP3 Play)

Switches back to Radio mode.

RND/PTY Button (CD Mode for MP3 Play)

Pressing this button plays files randomly.

SET/DIR Button (CD Mode for MP3 Play)

Press the SET/DIR Button to display folders, when playing an MP3 discs that have a file/folder structure. Turn the TUNE control to display available folders or move through available folders. Press the TUNE control to select a folder.

Buttons 1 - 6 (CD Mode for MP3 Play)

Selects disc positions 1 - 6 for Play/Load/Eject.

Operating Instructions - Hands Free Phone (If Equipped)

Refer to "Hands-Free Phone" in Section 3 of the Owner's Manual.

Operating Instructions - Satellite Radio Mode (If Equipped)

Refer to the "Satellite Radio" section of the Owner's Manual.

Operating Instructions - Video Entertainment System (VES) (If Equipped)

Refer to separate “Video Entertainment System (VES) Guide.”

SATELLITE RADIO — IF EQUIPPED

Satellite radio uses direct satellite to receiver broadcasting technology to provide clear digital sound, coast to coast. The subscription service provider is Sirius™ Satellite Radio. This service offers over 100 channels of music, sports, news, entertainment, and programming for children, directly from its satellites and broadcasting studios.

System Activation

NOTE: Your vehicle’s radio must be on and in satellite mode when the activation process takes place.

To activate your Sirius Satellite Radio service, call the toll-free number 888-539-7474, or visit the Sirius web site at www.sirius.com. Please have the following information available when activating your system:

1. The Electronic Serial Number/Sirius Identification Number (ESN/SID).

2. Credit card information.
3. Your Vehicle Identification Number.

Electronic Serial Number/Sirius Identification Number (ESN/SID)

The Electronic Serial Number/Sirius Identification Number is needed to activate your Sirius Satellite Radio system. To access the ESN/SID, refer to the following steps:

ESN/SID Access With REF Radios

With the ignition switch in the ACCESSORY position and the radio OFF, press the CD Eject and Time buttons simultaneously for 3 seconds. The first four digits of the twelve-digit ESN/SID number will be displayed. Press the SEEK UP button to display the next four digits. Continue to press the SEEK UP button until all twelve ESN/SID digits have been displayed. The SEEK DOWN will page down until the first four digits are displayed. The radio will exit the ESN/SID mode when any other button is pushed, the ignition is turned OFF, or 5 minutes has passed since any button was pushed.

ESN/SID Access With RAQ and RAK Radios

With the ignition switch in the ACCESSORY position and the radio OFF, press the CD Eject and TIME buttons simultaneously for 3 seconds. All twelve ESN/SID numbers will be displayed. The radio will exit the ESN/SID mode when any other button is pushed, the ignition is turned OFF, or 5 minutes has passed since any button was pushed.

ESN/SID Access With REC Navigation Radios

Please refer to your Navigation User's Manual.

With the ignition in the ACCESSORY position and the radio off, press the CD Eject and Set buttons simultaneously until the 12 digits of the ESN/SID appear on the screen.

Selecting Satellite Mode in REF, RAQ, and RAK Radios**Selecting Satellite Mode — REF Radio**

Press the MODE button repeatedly until the word "SAT" appears in the display.

A CD may remain in the radio while in the Satellite radio mode.

Selecting Satellite Mode — RAQ and RAK Radio

Press the MODE button repeatedly until the word "SAT" appears in the display.

These radios will also display the current station name and program type. For more information such as song title and artist press the MSG or INFO button.

A CD or tape may remain in the radio while in the Satellite radio mode.

Selecting a Channel

Press and release the SEEK or TUNE knob to search for the next channel. Press the top of the button to search up and the bottom of the button to search down. Holding the TUNE button causes the radio to bypass channels until the button is released.

Press and release the SCAN button (if equipped) to automatically change channels every 7 seconds. The radio will pause on each channel for 7 seconds before moving on to the next channel. The word "SCAN" will appear in the display between each channel change. Press the SCAN button a second time to stop the search.

NOTE: Channels that may contain objectionable content can be blocked. Contact Sirius Customer Care at 888-539-7474 to discuss options for channel blocking or unblocking. Please have your ESN/SID information available.

Storing and Selecting Pre-Set Channels

In addition to the 12 AM and 12 FM pre-set stations, you may also commit 12 satellite stations to push button memory. These satellite channel pre-set stations will not erase any AM or FM pre-set memory stations. Follow the memory pre-set procedures that apply to your radio.

Using the PTY (Program Type) Button (if equipped)

Follow the PTY button instructions that apply to your radio.

PTY Button "SCAN"

When the desired program type is obtained, press the "SCAN" button within five seconds. The radio will play 7 seconds of the selected channel before moving to the next channel of the selected program type. Press the "SCAN" button a second time to stop the search.

NOTE: Pressing the "SEEK" or "SCAN" button while performing a music type scan will change the channel by one and stop the search. Pressing a pre-set memory button during a music type scan, will call up the memory channel and stop the search.

PTY Button "SEEK"

When the desired program is obtained, press the "SEEK" button within five seconds. The channel will change to the next channel that matches the program type selected.

Satellite Antenna

To ensure optimum reception, do not place items on the roof around the rooftop antenna location. Metal objects placed within the line of sight of the antenna will cause decreased performance. Larger luggage items should be placed as far forward as possible. Do not place items directly on or above the antenna.

Reception Quality

Satellite reception may be interrupted due to one of the following reasons.

- The vehicle is parked in an underground parking structure or under a physical obstacle.
- Dense tree coverage may interrupt reception in the form of short audio mutes.
- Driving under wide bridges or along tall buildings can cause intermittent reception.
- Placing objects over or too close to the antenna can cause signal blockage.

VIDEO ENTERTAINMENT SYSTEM (SALES CODE XRV) — IF EQUIPPED

The optional VES™ (Video Entertainment System) consists of a DVD player and LCD (liquid crystal display) screen, a battery-powered remote control, and two headsets. The system is located in the center console storage bin under the armrest lid. Refer to your VES™ User's Manual for detailed operating instructions.

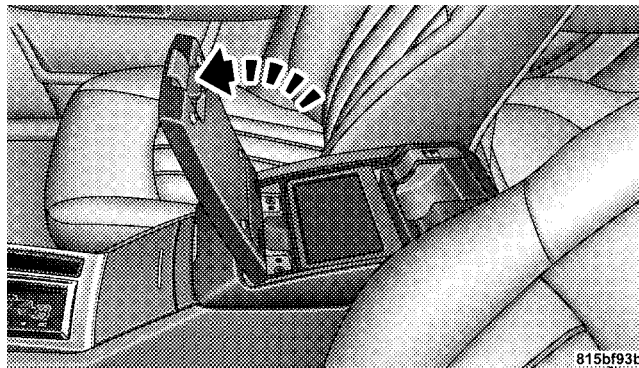

Accessing The VES

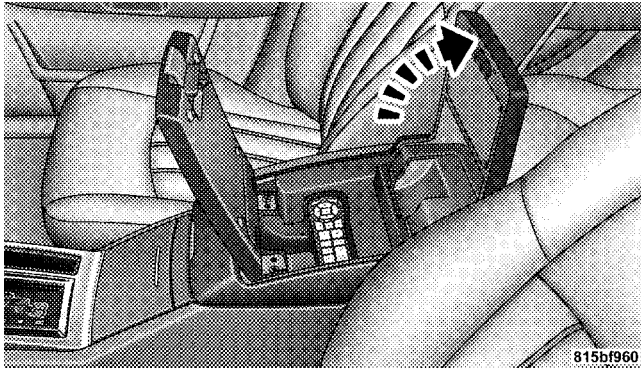

Raising The DVD Screen

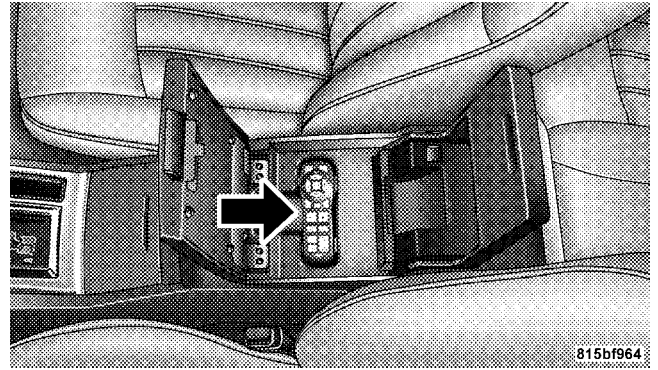

Remote Control Location

NAVIGATION SYSTEM (SALES CODE REC) — IF EQUIPPED

NOTE: The radio sales code is located on the lower right side of your radio faceplate.

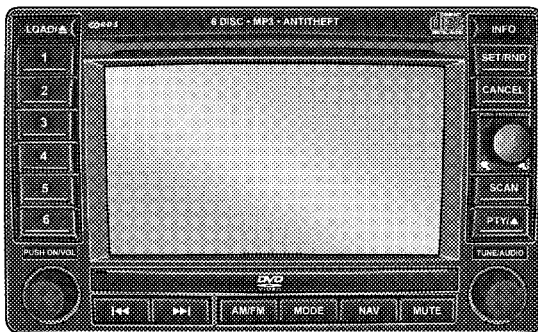

8125e256

Navigation Radio with CD Player and MP3 Capability (REC) - combines a Global-Positioning System-based navigation system with a color screen to provide maps, turn identification, selection menus and instructions for selecting a variety of destinations and routes. The unit also provides an AM/FM stereo radio and six-disc CD changer with MP3 capability.

Mapping information for navigation is supplied on a DVD that is loaded into the unit. One map DVD covers all of North America. Refer to your "Navigation User's Manual" for detailed operating instructions.

Clock Setting Procedure

Refer to "Setting the Clock" under "System Settings" in your Navigation User's Manual for details about setting the clock.

REMOTE SOUND SYSTEM CONTROLS

The remote sound system controls are located on the surface of the steering wheel at the 3 and 9 o'clock positions.

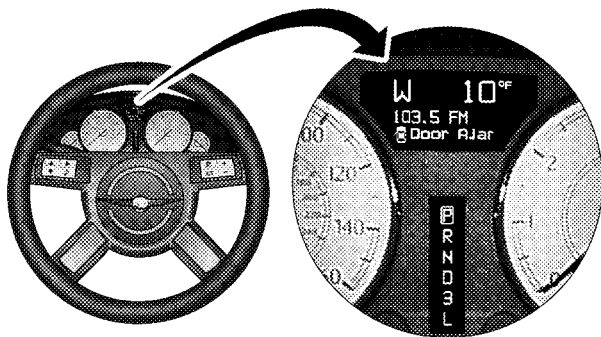

812c4479

Electronic Vehicle Information Center

Vehicles equipped with steering wheel mounted buttons are also equipped with the Electronic Vehicle Information Center (EVIC). The EVIC features a driver-interactive display. This is located in the upper part of the instrument cluster between the speedometer and tachometer.



VOLUME Button

The VOLUME button controls the sound level of the sound system. Press the top of the VOLUME button to increase the sound level. Press the bottom of the VOLUME button to decrease the sound level.



AUDIO MODE Button

Press the AUDIO MODE button to select the Compass/Temp/Audio screen. This screen displays radio station frequencies, any one of twelve radio station preset frequencies, CD disc number, CD track number, tape, or any one of 200 Satellite radio channels depending on which radio is in the vehicle.

If Compass/Temp/Audio is already displayed when the AUDIO MODE button is pressed, then the radio mode will change from AM to FM, to Tape, to CD, or to Satellite (SAT) accordingly.

 When the EVIC is in the Compass/Temp/Audio screen, press the **FUNCTION SELECT** button to advance the radio to the next preset station, to change the side of the tape being played (if so equipped), or to change the current CD track being played (if so equipped).

 when the EVIC is in the Compass/Temp/Audio screen, press the **SCROLL** button to seek up and down the radio stations, CD track numbers (if so equipped), or satellite radio channels (if so equipped).

The following describes the operation of the **SCROLL** button in each mode:

Radio Operation

Press the top of the **SCROLL** button once to **SEEK** the next listenable station up from the current setting. Press the bottom of the **SCROLL** button once to **SEEK** the next listenable station down from the current setting.

Tape Player Operation

Press the top of the **SCROLL** button once to listen to the next track on the cassette. Press the bottom of the **SCROLL** button once to either listen to the beginning of the current track or to listen to the beginning of the previous track if it is within 5 seconds after the current track begins to play.

Press either the top or bottom of the **SCROLL** button twice to listen to the second track on the tape, three times to listen to the third track, and so forth.

Press the **FUNCTION SELECT** button to change the side of the tape being played.

CD Player Operation

Press the top of the **SCROLL** button once to listen to the next track on the CD. Press the bottom of the **SCROLL** button once to either listen to the beginning of the current track or to listen to the beginning of the previous track if it is within one second after the current track begins to play.

Press either the top or bottom of the SCROLL button twice to listen to the second track on the CD, three times to listen to the third track, and so forth.

Satellite Radio Operation

Press the top of the SCROLL button once to SEEK the next listenable station up from the current setting. Press the bottom of the SCROLL button once to SEEK the next listenable station down from the current setting.

CASSETTE TAPE AND PLAYER MAINTENANCE

To keep the cassette tapes and player in good condition, take the following precautions:

1. Do not use cassette tapes longer than C-90; otherwise, sound quality and tape durability will be greatly diminished.
2. Keep the cassette tape in its case to protect from slackness and dust when it is not in use.
3. Keep the cassette tape away from direct sunlight, heat and magnetic fields such as the radio speakers.

4. Before inserting a tape, make sure that the label is adhering flatly to the cassette.

5. A loose tape should be corrected before use. To rewind a loose tape, insert the eraser end of a pencil into the tape drive gear and twist the pencil in the required directions.

Maintain your cassette tape player. The head and capstan shaft in the cassette player can pick up dirt or tape deposits each time a cassette is played. The result of deposits on the capstan shaft may cause the tape to wrap around and become lodged in the tape transport. The other adverse condition is low or "muddy" sound from one or both channels, as if the treble tone control were turned all the way down. To prevent this, you should periodically clean the head with a commercially available WET cleaning cassette.

As preventive maintenance, clean the head about every 30 hours of use. If you wait until the head becomes very dirty (noticeably poor sound), it may not be possible to remove all deposits with a simple WET cleaning cassette.

CD/DVD DISC MAINTENANCE

To keep the CD/DVD discs in good condition, take the following precautions:

1. Handle the disc by its edge; avoid touching the surface.
2. If the disc is stained, clean the surface with a soft cloth, wiping from center to edge.
3. Do not apply paper, paper CD labels, or tape to the disc; avoid scratching the disc.
4. Do not use solvents such as benzine, thinner, cleaners, or antistatic sprays.
5. Store the disc in its case after playing.
6. Do not expose the disc to direct sunlight.
7. Do not store the disc where temperatures may become too high.

RADIO OPERATION AND CELLULAR PHONES

Under certain conditions, the cellular phone being On in your vehicle can cause erratic or noisy performance from your radio. This condition may be lessened or eliminated by relocating the cellular phone antenna. This condition is not harmful to the radio. If your radio performance does not satisfactorily “clear” by the repositioning of the antenna, it is recommended that the radio volume be turned down or off during cellular phone operation.

CLIMATE CONTROLS

Climate Controls — Manual

Air Conditioning

The controls for the heating/air conditioning and ventilation system in this vehicle consist of a series of rotary knobs. These comfort controls can be set to obtain desired interior conditions.

The instrument panel features four dual-vane airflow registers. Two registers are located on the outer ends of the instrument panel and two are located in the center of the instrument panel. These registers can be closed to partially block airflow.

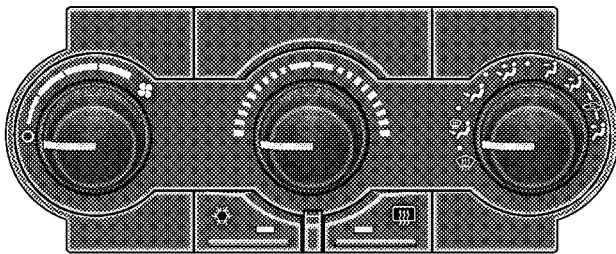

81350206

Manual Temperature Controls



Press this button to turn on and off the air conditioning. Cool dehumidified air comes through the outlets selected by the mode selector. Press the button a

second time to turn off the air conditioning. The button includes an LED that illuminates when compressor operation is selected.

Electric Rear Window Defroster



Press this button to turn on the rear window defroster and the heated side mirrors (if equipped). An LED in the button will illuminate to indicate the rear window defroster is ON. The defroster automatically turns off after about 10 minutes of operation.

4

CAUTION!

To avoid damaging the electrical conductors of the rear window defroster, do not use scrapers, sharp instruments, or abrasive window cleaners on the interior surface of the window.

Labels can be peeled off after soaking with warm water.

Blower Control

812d1942

The rotary knob on the left controls the blower and can be set in one of four speeds and OFF. The blower fan motor will remain on until the system is turned to the OFF position or the ignition is turned OFF.

Temperature Control

812d193c

The temperature of air can be selected by rotating the temperature control knob in the center. The coldest temperature setting is on the extreme left and the warmest setting on the extreme right of the rotation. The knob can be positioned at any point on the dial.

Mode Selection

812d192f

The mode selector (the right rotary knob) can be placed in several positions. Dots between each of the mode selections identify intermediate modes that allow the occupants to fine tune airflow distribution.

Defrost

Air is directed to the windshield through the outlets at the base of the windshield. Air is also directed to the front door windows through the side window demister grilles.

NOTE: To improve fuel economy, leave in defrost only when necessary.

Defrost/Floor

 Air flows through the front and rear floor outlets and the outlets at the base of the windshield. Air is also directed to the front door windows through the side window demister grilles.

Floor

 Air flows through the floor outlets located under the instrument panel and into the rear seating area through vents under the front seats.

Bi-Level

 Air flows both through the outlets located in the instrument panel and those located on the floor. Air flows through the registers in the back of the center console to the rear seat passengers. These registers can be closed to partially block airflow.

Panel

 Air flows through the outlets located in the instrument panel. Air flows through the registers in the back of the center console to the rear seat passengers. These registers can be closed to block airflow.

Recirculation

The recirculation feature can be selected with the mode control knob. You may choose between Bi-Level Recirculation and Panel Recirculation air outlets while in this mode.

Normally, air enters from outside the vehicle. However, when in Recirculation mode air inside the vehicle is re-used. Use this mode to rapidly cool the inside of the vehicle. The Recirculation mode can also be used to temporarily block out outside odors, smoke, and dust.

Window Fogging

Interior fogging on the windshield can be quickly removed by turning the mode selector to Defrost. The Defrost/Floor mode can be used to maintain a clear windshield and provide sufficient heating. If side window fogging becomes a problem increase blower speed. Vehicle windows tend to fog on the inside in mild but rainy or humid weather.

NOTE: Recirculate without A/C should not be used for long periods as fogging may occur.

Automatic Temperature Control — If Equipped

The Infrared Dual-Zone Climate Control System automatically maintains the interior comfort level desired by the driver and passenger. This is accomplished by a dual sun-sensor in the top of the instrument panel, and an infrared sensor located in the face of the control unit. There are also various sensors monitored by this system which take account for vehicle speed, A/C pressure, outside temperature, and engine cooling temperature. The infrared sensor independently measures the surface temperature of the driver and passenger. Based on the sensor input, the system automatically adjusts the air flow temperature, the air flow volume, and amount of outside air recirculation. This maintains a comfortable temperature even under changing conditions.

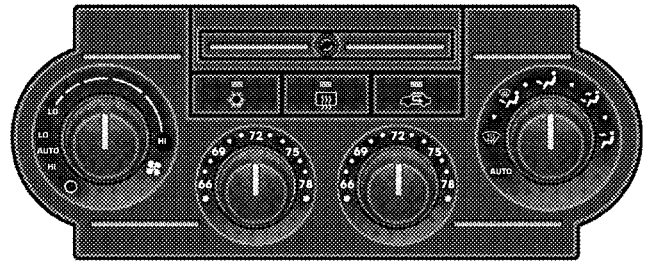

8135020a

Automatic Temperature Controls

Operation of the system is quite simple. Begin by turning the right mode knob to AUTO, and place the blower control (left knob) to either LO AUTO or HI AUTO. The LO AUTO position should be used for front seat occupants only. The HI AUTO position should be used when more air flow is desired, or when rear seat occupants are present. Dial in the temperature you would like the system to maintain by rotating the driver's or passenger's control knob. Once the comfort level is selected the system will maintain that level automatically using the heating system. Should the desired comfort level require air conditioning, the system will automatically make the adjustment.

You will experience the greatest efficiency by simply allowing the system to function automatically. Selecting the OFF position on the fan control stops the system completely and closes the outside air intake.

72°F (22°C) is the recommended setting for maximum comfort for the average person, however, this may vary.

NOTE: The temperature setting can be adjusted at any time without affecting automatic control operation.



The air conditioning in this system is automatic. Pressing this button while in AUTO mode will cause the LED to flash three times and remain off. This indicates that the system is in AUTO and requesting the air conditioning is not necessary.



The system will automatically control recirculation. However, pressing this button will temporarily put the system in recirculation mode (ten minutes). This can be used when outside conditions such as smoke, odors, dust, or high humidity are present. This will cause the LED to illuminate. After ten minutes the system will return to normal AUTO mode function and the LED will turn off.

NOTE:

- The surface of the climate control panel, and the top center of the instrument panel should be kept free of debris due to the location of the climate control sensors. Mud on the windshield may also cause poor operation of this system.

- Most of the time, when in Automatic operation, you can temporarily put the system into recirculation mode by pressing the Recirc button. However, under certain conditions in automatic the system is blowing air out of the defrost vents. When these conditions are present and the Recirc button is pressed the indicator will flash and remain off. This tells you that you are unable to go into recirculation mode at this time. If you would like to go to Recirculation mode, you must first move your mode knob to panel, panel/floor or floor, then hit the recirc button. This feature will reduce the possibility of window fogging.

Manual Operation

This system offers a full complement of manual override features which consist of Blower Preferred Automatic, Mode Preferred Automatic, or Blower and Mode Preferred Automatic. This means the customer can override the blower, the mode, or both. There is a manual blower range used when the AUTO setting is not desired. The left control can be set to any fixed blower speed by rotating the knob.

NOTE: Please read the Automatic Temperature Control Operation Chart below for details.

Automatic Temperature Control Operation		The system will...				
Operation	How	Blower Control	Mode Control	Air Temperature Control	Air Recirculation Control	A/C Operation
Full Automatic Operation	Set blower knob to either Hi or Lo Auto. Set mode knob to Auto. Set temperature knobs for comfort.	Automatic	Automatic	Automatic	Automatic but can be overridden for 10 minutes at a time.	Automatic
Blower Preferred Automatic	Set blower knob to any desired airflow level other than Hi or Lo Auto. Set mode knob to Auto. Set temperature knobs for comfort.	User selectable to any speed.	Automatic	Automatic	Automatic but can be overridden for 10 minutes at a time.	Automatic
Mode Preferred Automatic	Set mode knob to any desired air delivery point other than Auto. Set blower knob to either Hi or Lo Auto. Set temperature knobs for comfort.	Automatic	User selectable to any air delivery point.	Automatic	User selectable outside or recirculated.	User selectable A/C on or off.
Blower and Mode Preferred Automatic	Set blower knob to any desired airflow level other than Hi or Lo Auto. Set mode knob to any desired air delivery point other than Auto. Set temperature knobs for comfort.	User selectable to any speed.	User selectable to any air delivery point.	Automatic	User selectable outside or recirculated.	User selectable A/C on or off.

The operator can override the AUTO mode setting and select the direction of the air by rotating the right mode knob to one of the following positions.

- *Defrost*



Air is directed to the windshield through the outlets at the base of the windshield. Air is also directed to the front door windows through the side window demister grilles.

- *Defrost/Floor*



Air flows through the front and rear floor outlets and the outlets at the base of the windshield. Air is also directed to the front door windows through the side window demister grilles.

- *Floor*



Air flows through the floor outlets located under the instrument panel and into the rear seating area through vents under the front seats.

- *Bi-Level*



Air flows both through the outlets located in the instrument panel and those located on the

floor. Air flows through the registers in the back of the center console to the rear seat passengers. These registers can be closed to block airflow.

- *Panel*



Air flows through the outlets located in the instrument panel. Air flows through the registers in the back of the center console to the rear seat passengers. These registers can be closed to block airflow.



Depress this button to turn on and off the air conditioning during manual operation only. Conditioned outside air is then directed through the outlets selected on the mode control dial. The button includes an LED that illuminates when manual operation is selected.

NOTE: To manually control the air conditioning the mode selector must be moved out of the AUTO position.



Press this button to turn on the rear window defroster and the heated side mirrors (if equipped). An LED in the button will illuminate when

the rear window defroster is ON. The defroster automatically turns off after approximately 10 minutes of operation for the first push of the button, and will turn off after approximately 5 minutes for the second push of the button.

CAUTION!

To avoid damaging the electrical conductors of the rear window defroster, do not use scrapers, sharp instruments, or abrasive window cleaners on the interior surface of the window.

Labels can be peeled off after soaking with warm water.



This button can be used to block out smoke, odors, dust, high humidity, or if rapid cooling is desired. The recirculation mode should only be used temporarily. The button includes an LED that illuminates when the recirculation mode is active. You may use this feature separately.

NOTE: Extended use of recirculation may cause the windows to fog. If the interior of the windows begins to fog, press the “Recirculate” icon button to return to outside air. Some temp./humidity conditions will cause captured interior air to condense on windows and hamper visibility. For this reason, the system will not allow “Recirculate” to be selected while in the defrost or defrost/floor modes. Attempting to use the recirculation while in these modes will cause the LED in the button to blink and then turn off.

Summer Operation

The engine cooling system in air conditioned vehicles must be protected with a high-quality antifreeze coolant to provide proper corrosion protection and to protect against engine overheating. A 50% solution of ethylene glycol antifreeze coolant in water is recommended. Refer to section 7, Maintenance Procedures, of this manual for proper coolant selection.

Winter Operation

Use of the air Recirculation mode during winter months is not recommended because it may cause window fogging.

NOTE: See Operating Tips chart (for Manual A/C Control) at the end of this section for suggested control settings in different weather conditions.

Vacation Storage

Anytime you store your vehicle, or keep it out of service (i.e. vacation) for two weeks or more, run the air conditioning system at idle for about five minutes in the fresh air and high blower setting. This will insure adequate system lubrication to minimize the possibility of compressor damage when the system is started again.

Window Fogging

Interior fogging on the windshield can be quickly removed by turning the mode selector to Defrost. The Defrost/Floor mode can be used to maintain a clear windshield and provide sufficient heating. If side window fogging becomes a problem increase blower speed. Vehicle windows tend to fog on the inside in mild but rainy or humid weather.

NOTE: Recirculate without A/C should not be used for long periods as fogging may occur.















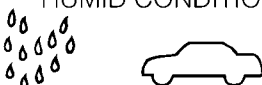

Outside Air Intake

Make sure the air intake, located directly in front of the windshield, is free of obstructions such as leaves. Leaves collected in the air intake may reduce airflow and if they enter the plenum they could plug the water drains. In winter months make sure the air intake is clear of ice, slush and snow.

A/C Air Filter — If Equipped

The climate control system filters outside air containing dust, pollen and some odors. Strong odors cannot be totally filtered out. Refer to “Maintenance Procedures” in your Owner’s Manual for filter replacement instructions.

Operating Tips

WEATHER	CONTROL SETTINGS
<p>HOT WEATHER AND VEHICLE INTERIOR IS VERY HOT</p> 	<p>Open the windows, start the vehicle, set the Mode control to Panel  or Bi-Level , and turn on A/C. Set the Fan control to the High position (full clockwise). Set the temperature control to full cool. After the hot air is flushed from the vehicle, set the Mode control to Recirculate  with A/C on and roll up the windows. Once you are comfortable, set the Mode control to Panel  or Bi-Level  with A/C on.</p>
<p>WARM WEATHER</p> 	<p>If it's sunny, set the Mode control to Panel  and turn on A/C. If it's cloudy or dark, set the Mode control to Bi-Level  with A/C on. Adjust Temperature control for comfort.</p>
<p>COOL OR COLD HUMID CONDITIONS</p> 	<p>Set the Mode control to Defrost/Floor  or Defrost . Set the Fan Control to the High position (full clockwise). Adjust Fan and Temperature control for comfort if windows are clear.</p>
<p>COLD DRY CONDITIONS</p> 	<p>Set the Mode control to Floor . If it's sunny, you may want more upper air. In this case, set the Mode control to Bi-Level . In very cold weather, if you need extra heat at the windshield, set the Mode control to Defrost/Floor  or Defrost  as needed. Adjust Fan and Temperature control for comfort.</p>

81352266

STARTING AND OPERATING

CONTENTS

■ Starting Procedures	208	□ Anti-Lock Brake System	225
□ Normal Starting	208	■ Power Steering	228
■ Engine Block Heater — If Equipped	210	■ Multi Displacement System (MDS) - 5.7L Engine Only	229
■ Transmission Shifting	210	■ All Wheel Drive — If Equipped	229
□ 4 Speed Automatic Transmission	210	■ Self-Sealing Tires — If Equipped	229
□ 5 Speed Automatic Transmission	215	■ Tire Pressure Monitor System — If Equipped	230
□ Automatic Transmission — General Information	220	□ Tire Pressure Monitoring — Base System	230
■ AutoStick — If Equipped	222	□ Tire Pressure Monitoring — Premium System	231
□ AutoStick Operation	222	□ General Information	234
■ Parking Brake	223	■ Tire Safety Information	234
■ Brake System	225	□ Tire Markings	234

□ Tire Identification Number (TIN)	238	■ Fuel Requirements	253
□ Tire Loading And Tire Pressure	239	□ 2.7L Engines	253
■ Tires—General Information	243	□ 3.5L And 5.7L Engines	253
□ Tire Pressure	243	□ Spark Knock	254
□ Tire Inflation Pressures	244	□ Reformulated Gasoline	254
□ Radial-Ply Tires	246	□ Gasoline/Oxygenate Blends	254
□ Compact Spare Tire — If Equipped	246	□ MMT In Gasoline	255
□ Limited Use Spare — If Equipped	247	□ Materials Added To Fuel	255
□ Tire Spinning	247	□ Fuel System Cautions	256
□ Tread Wear Indicators	248	□ Carbon Monoxide Warnings	256
□ Life Of Tire	249	■ Adding Fuel	257
□ Replacement Tires	249	□ Fuel Filler Cap (Gas Cap)	257
□ Alignment And Balance	250	■ Vehicle Loading	260
■ Tire Chains	251	□ Vehicle Certification Label	260
■ Snow Tires	252	□ Gross Vehicle Weight Rating (GVWR)	260
■ Tire Rotation Recommendations	252	□ Gross Axle Weight Rating (GAWR)	260

- Overloading261
- Loading261
- Trailer Towing262
 - Common Towing Definitions262
 - Trailer Hitch Classification264
 - Trailer Towing Weights (Maximum Trailer Weight Ratings)264
 - Trailer And Tongue Weight266
- Towing Requirements267
- Towing Tips271
- Recreational Towing (Behind Motorhome, Etc.)272
 - Towing This Vehicle Behind Another Vehicle (Flat Towing With All Four Wheels On The Ground)272

STARTING PROCEDURES**CAUTION!**

Long periods of engine idling, especially at high engine speeds, can cause excessive exhaust temperatures which can damage your vehicle. Do not leave your vehicle unattended with the engine running.

WARNING!

Do not leave animals or children inside parked vehicles in hot weather; interior heat build up may cause serious injury or death.

The gear selector must be in the NEUTRAL or PARK position before you can start the engine. Apply the brakes before shifting into any driving gear.

Normal Starting

Normal Starting of either a cold or a warm engine is obtained without pumping or depressing the accelerator pedal. Turn the key to the "START" position and release when the engine starts. If the engine has not started within 3 seconds, slightly depress the accelerator pedal while continuing to crank. If the engine fails to start within 15 seconds, turn the key to the "OFF" position, wait 10 to 15 seconds, then repeat the normal starting procedure.

Extremely Cold Weather (below -20°F or -29°C) To insure reliable starting at these temperatures, use of an externally powered electric engine block heater (available from your dealer) is recommended.

WARNING!

- Do not attempt to push or tow your vehicle to get it started. Vehicles equipped with an automatic transmission cannot be started this way. Unburned fuel could enter the catalytic converter and once the engine has started, ignite and damage the converter and vehicle. If the vehicle has a discharged battery, booster cables may be used to obtain a start from a booster battery or the battery in another vehicle. This type of start can be dangerous if done improperly. See section 6 of this manual for the proper jump starting procedures and follow them carefully.
- Never pour fuel or other flammable liquid into the throttle body air inlet opening in an attempt to start the vehicle. This could result in flash fire causing serious personal injury.

If Engine Fails to Start

If the engine fails to start after you have followed the “NORMAL STARTING” procedure, it may be flooded.

Push the accelerator pedal all the way to the floor and hold it there while cranking the engine. This should clear any excess fuel in case the engine is flooded.

CAUTION!

To prevent damage to the starter, do not crank the engine for more than 15 seconds at a time. Wait 10 to 15 seconds before trying again.

5

If the engine has been flooded, it may start to run, but not have enough power to continue running when the key is released. If this occurs, continue cranking up to 15 seconds with the accelerator pedal pushed all the way to the floor. Release the accelerator pedal and the key once the engine is running smoothly. Do not overspeed engine.

If the engine shows no sign of starting after two 15 second periods of cranking with the accelerator pedal held to the floor, the “NORMAL STARTING” procedure should be repeated.

After Starting

The idle speed will automatically decrease as the engine warms up.

ENGINE BLOCK HEATER — IF EQUIPPED

The engine block heater warms engine coolant and permits quicker starts in cold weather. Connect the cord to a standard 110-115 volt AC electrical outlet with a grounded, three-wire extension cord.

The engine block heater cord is routed under the hood on the driver side of the vehicle. It has a removable cap that is located on the driver side of the Integrated Power Module.

WARNING!

Remember to disconnect the cord before driving. Damage to the 110-115 volt electrical cord could cause electrocution.

TRANSMISSION SHIFTING

4 Speed Automatic Transmission

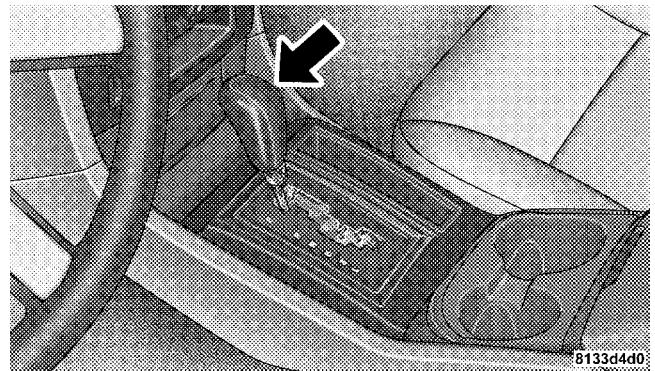

Gear Selector

Shifting from D (Drive) to P (Park) or R (Reverse) (or from P or R to D) should be done only after the accelerator pedal is released and the vehicle is stopped. Be sure to keep your foot on the brake when moving the shift lever between these gears.

WARNING!

It is dangerous to shift the selector lever out of "P" or "N" if the engine speed is higher than idle speed. If your foot is not firmly on the brake pedal, the vehicle could accelerate quickly forward or in reverse. You could lose control of the vehicle and hit someone or something. Only shift into gear when the engine is idling normally and when your right foot is firmly on the brake pedal.

Gear Ranges***P (Park)***

P (Park) supplements the parking brake by locking the transmission. The engine can be started in this range. Never use P (Park) while the vehicle is in motion. Apply the parking brake when leaving the vehicle in this range.

When parking on a flat surface, place the gear selector in the P (Park) position first, and then apply the parking brake.

When parking on a hill, it is important to set the parking brake before placing the gear selector in P (Park), otherwise the load on the transmission locking mechanism may make it difficult to move the selector out of park. As an added precaution, turn the front wheels toward the curb on a downhill grade and away from the curb on an uphill grade.

WARNING!

Unintended movement of a vehicle could injure those in and near the vehicle. As with all vehicles, you should never exit a vehicle while the engine is running. Before exiting a vehicle, you should always shift the vehicle into P (Park), remove the key from the ignition, and apply the parking brake. Once the key is removed from the ignition, the transmission shift lever is locked in the P (Park) position, securing the vehicle against unwanted movement. Furthermore, you should never leave children unattended inside a vehicle.

The following indicators should be used to ensure that you have engaged the transmission shift lever into the P (Park) position:

- When shifting into P (Park) move the lever all the way forward until it stops, and is fully seated.
- Look at the shift indicator display on the instrument panel to ensure it is in the P (Park) position.

CAUTION!

Before moving the shift lever out of P (Park), you must turn the ignition from LOCK to ON so the shift lever is released. Otherwise, damage to the shifter could result.

R (Reverse)

For moving the vehicle rearward. Always stop before moving the lever to R (Reverse), except when rocking the vehicle.

N (Neutral)

Engine may be started in this range.

WARNING!

Do not coast in N (Neutral) and never turn off the ignition to coast down a hill. These are unsafe practices that limit your response to changing traffic or road conditions. You might lose control of the vehicle.

D (Overdrive)

This range should be used for most city and highway driving. It provides smoothest up shifts and down shifts and best fuel economy. Select the “3” range when frequent transmission shifting occurs when using the Overdrive range, such as when operating the vehicle under heavy loading conditions (in hilly terrain, traveling into strong head winds, or while towing heavy trailers).

NOTE: If the vehicle is started in cold outside temperatures, shifts into Overdrive may be delayed. Normal

Overdrive and shifting operation will resume when the temperature of the transmission reaches the appropriate temperature. Refer to the “Note” under “Torque Converter Clutch” later in this section.

If the transmission temperature gets too hot, the transmission may downshift out of Overdrive or engage overdrive at higher vehicle speeds until the transmission cools down. After cooldown, Overdrive will resume normal operation.

3 (Third)

This range eliminates shifts into Overdrive. The transmission will operate normally in First, Second and Third while in this range. The “3” position should also be used when descending steep grades to prevent brake system distress.

NOTE: Using the “3” range while operating the vehicle under heavy operating conditions will improve performance and extend transmission life by reducing excessive shifting and heat build up.

L (Low)

This range should be used for engine braking when descending very steep grades. In this range, upshifts will occur only to prevent engine overspeed while downshifts occur earlier than other gear range selections.

CAUTION!

- Never race the engine with the brakes on and the vehicle in gear, and never hold the vehicle on an incline without applying the brakes. These practices can cause overheating and damage to the transmission.
- When “rocking” a stuck vehicle by moving between “First” and R (Reverse), do not spin the wheels faster than 15 mph (24 km/h), or drivetrain damage may result.

Torque Converter Clutch

A feature designed to improve fuel economy has been added to the automatic transmission of this vehicle. A clutch within the torque converter engages automatically at calibrated speeds. This may result in a slightly different feeling or response during normal operation in high gear. When the vehicle speed drops or during acceleration, the clutch automatically and smoothly disengages.

NOTE:

- The torque converter clutch will not engage until the transmission fluid and engine coolant is warm (usually after 1–3 miles (1.6–4.8 km) of driving). Because engine speed is higher when the torque converter clutch is not engaged, it may seem as if the transmission is not shifting into “Overdrive” when cold. This is considered a normal condition. Pulling the shift lever into the “3” position will show that the transmission is able to shift into and out of “Overdrive.”
- If the vehicle has not been driven for several days, the first few seconds of operation after shifting the transmission into gear may seem sluggish. This is due to the transmission fluid partially draining from the torque

converter into the transmission. This is considered a normal condition and will not cause damage to the transmission. The torque converter will refill within 5 seconds of shifting from P (Park) into any other gear position.

Transmission Limp Home Mode

The transmission is monitored for abnormal conditions. If a condition is detected that could cause damage, the transmission automatically shifts into second gear. The transmission remains in second gear despite the forward gear selected. Park (P), Reverse (R), and Neutral (N) will continue to operate. This Reset feature allows the vehicle to be driven to a dealer for service without damaging the transmission.

If the problem has been momentary, the transmission can be reset to regain all forward gears.

- Stop the vehicle and shift into PARK (P).
- Turn the key to LOCK then start the engine.
- Shift into “D” and resume driving.

NOTE: Even if the transmission can be reset, we recommend that you visit a dealer at your earliest possible convenience. Your dealer has diagnostic equipment to determine if the problem could recur.

If the transmission cannot be reset, dealer service is required.

5 Speed Automatic Transmission

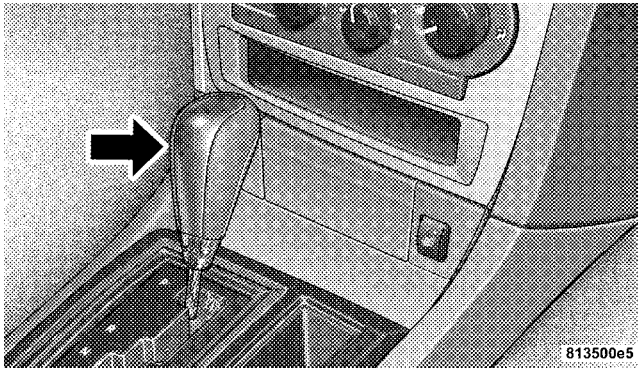

Gear Selector

WARNING!

Unintended movement of a vehicle could injure those in and near the vehicle. As with all vehicles, you should never exit a vehicle while the engine is running. Before exiting a vehicle you should shift the transmission into Park, remove the key from the ignition, and apply the park brake. Once the key is removed from the ignition the transmission shift lever is locked in the Park position, securing the vehicle against unwanted movement. Furthermore, you should never leave children unattended inside a vehicle. The following indicators should be used to ensure that you have engaged the transmission shift lever into the "Park" position:

- When shifting into Park move the lever all the way forward until it stops, and is fully seated.
- Look at the shift indicator window on the console to ensure it is in the "P" position.

Park Position

The PARK position is to be used when parking the vehicle. Engage only with the vehicle stopped. The PARK position is not intended to serve as a brake when the vehicle is parked. Rather, the driver should always use the parking brake in addition to placing the selector lever in PARK to secure the vehicle.

PARK supplements the parking brake by locking the transmission. The engine can be started in this range. Never attempt to use PARK while the vehicle is in motion.

NOTE:

- If the key is in the ACC or ON position, you must press the brake pedal to shift out of the PARK position.
- The key can be removed from the ignition switch only with the selector lever in the PARK position. With the key removed, the selector lever is locked in the PARK position.

For electrical system malfunctions there is an override for the interlock system. In order to override this system the key must be in the ignition with the switch in the ACC or

ON positions. Remove the rubber storage tray from the bin located to the right of the shifter lever. The override can be activated by pressing the pink-colored tab, which can be accessed through a hole inside the bin. While the override is pressed, the shifter can be moved out of the park position without pressing the brake. After operation return rubber storage tray to its original position.

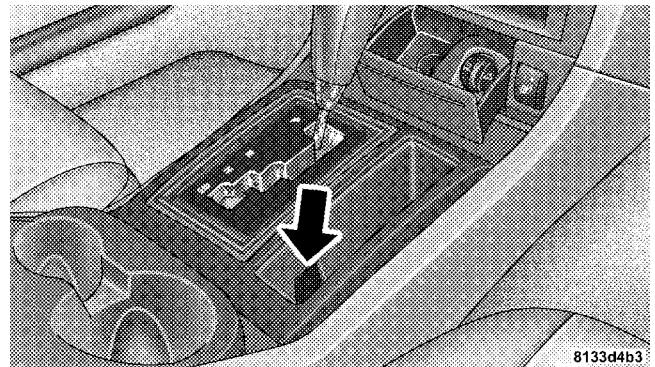

Brake Interlock Override

Reverse

Shift into REVERSE gear only when the vehicle is completely stopped.

Neutral

No power is transmitted from the engine to the drive axle. When the brakes are released, the vehicle can be moved freely (pushed or towed). Do not engage in NEUTRAL position while driving except to coast when the vehicle is in danger of skidding (e.g., on icy roads).

The engine may be started in this range. Use this range for starting your vehicle if it is moving or being towed.

CAUTION!

Coasting the vehicle, or driving for any other reason with selector lever in NEUTRAL can result in transmission damage.

Drive

This range should be used for most city and highway driving. It provides the smoothest upshifts and downshifts and best fuel economy.

The transmission automatically upshifts through fifth gear. The DRIVE position provides optimum driving characteristics under all normal operating conditions.

When frequent transmission shifting occurs when using the Overdrive range, such as when operating the vehicle under heavy loading conditions (in hilly terrain, traveling into strong head winds, or while towing heavy trailers, use the AutoStick mode and select the “3” range.

AutoStick® Gear selection

The transmission gear can be selected by pressing the selector lever to the right or the left with the selector lever in the DRIVE position. The gear currently selected is indicated in the instrument cluster display. Briefly press selector lever in the “D -” direction. The transmission will shift from the current gear to the next lower gear. Shifting into another gear that allows for quicker acceleration or to slow the vehicle down is possible. Downshifts can also be performed.

Press and hold the selector lever in the “D-” direction. The transmission will shift from the current gear directly to the best gear for acceleration.

NOTE: To avoid overrevving the engine when the selector lever is moved in “D -” direction, the transmission will not shift to a lower gear if the engine’s revolutions per minute limit would be exceeded.

Briefly press the selector lever in the “D +” direction. The transmission will shift from the current gear to the next higher gear.

Press and hold the selector lever in the “D +” direction. The transmission will shift from the current gear directly to gear “D”.

WARNING!

On slippery road surfaces, never downshift in order to obtain braking action. This could result in drive wheel slip and reduced vehicle control. Your vehicle’s ABS will not prevent this type of loss of control. You could lose control of your vehicle and have an accident.

Delayed Shifts in Cold Temperatures

During cold temperature operation you may notice delayed upshifts depending on engine and transmission temperature as well as vehicle speed. This feature improves warm up time of the engine and transmission to achieve maximum efficiency.

Temporary Transmission Limp Home Mode

The transmission is monitored for abnormal conditions. If a condition is detected that could result in transmission damage, the transmission will engage Limp Home Mode. If vehicle acceleration worsens, or the transmission no longer shifts, the transmission is most likely operating in the Limp Home Mode. In this mode, the transmission will remain in the current gear until the vehicle is brought to a stop. After the vehicle has stopped, PARK (P), REVERSE (R), and NEUTRAL (N) will continue to operate. SECOND gear will operate in the DRIVE (D) shifter position. The Malfunction Indicator Light may be illuminated.

A reset feature is available to allow the vehicle to be driven to a dealer for service. To reset the transmission, use the following procedure:

1. Stop the vehicle.
2. Move the selector lever to the PARK position.
3. Turn off the engine.
4. Wait approximately 10 seconds.
5. Restart the engine.
6. Move the shift lever to the desired range. If the problem is no longer detected, the transmission will return to normal operation.

NOTE: Even if the transmission can be reset, we recommend that you visit a dealer at your earliest possible convenience. Your dealer has diagnostic equipment to determine if the problem could recur.

Have the transmission checked at your authorized dealer as soon as possible.

If the problem has been momentary, the transmission can be reset to regain all forward gears.

Permanent Transmission Limp Home Mode

Permanent Limp Home Mode will be activated if the transmission enters temporary Limp Home Mode three times. Follow the reset procedure described under “Temporary Transmission Limp Home Mode” in this section. In Permanent Limp Home Mode, PARK (P), REVERSE (R) and NEUTRAL (N) will continue to operate. SECOND gear will operate in the DRIVE (D) shifter position. The malfunction indicator light may illuminate.

Automatic Transmission — General Information**CAUTION!**

Damage to the transmission may occur if the following precautions are not observed:

- Shift into **PARK** only after the vehicle has come to a complete stop.
- Shift into or out of **REVERSE** only after the vehicle has come to a complete stop and the engine is at idle speed.
- Do not shift from **REVERSE, PARK** or **NEUTRAL** into any forward gear when the engine is above idle speed.
- Before shifting into any gear, make sure your foot is firmly on the brake pedal.

The automatic transmission selects individual gears automatically, dependent upon:

- Altitude
- Vehicle Loading
- Driving Style
- Selector lever position
- Accelerator position
- Vehicle speed

The gear shifting process is continuously adapted, dependent on the driving style, the driving situation and the road characteristics.

NOTE:

- After selecting any driving position, wait a moment to allow the gear to fully engage before accelerating, especially when the engine is cold.

- If there is a need to restart your engine be sure to cycle the key to the LOCK position before restarting. Transmission engagement may be delayed up to 10 seconds after restart if the key is not cycled to the LOCK position first.
- The electronically controlled transmission provides a precise shift schedule. The transmission electronics are self-calibrating. Therefore, the first few shifts on a new vehicle may be somewhat abrupt or soft until after the break-in period. This is a normal condition, and precision shifts will develop within a few shift cycles.

WARNING!

It is dangerous to shift the selector lever out of PARK or NEUTRAL if the engine speed is higher than idle speed. If your foot is not firmly on the brake pedal, the vehicle could accelerate quickly forward or in reverse. You could lose control of the vehicle and hit someone or something. Only shift into gear when the engine is idling normally and when your foot is firmly on the brake pedal.

The selector lever is automatically locked while in the PARK position. To move the selector lever out of the PARK position, the brake pedal must be firmly depressed before the shift lock will release.

Shift the selector lever to the desired position only when the engine is idling normally and the brake pedal is applied. Do not release the brake until ready to drive. The vehicle may otherwise accelerate quickly when the selector lever is in DRIVE or REVERSE position.

Stopping

For brief stops, leave the transmission in gear and hold the vehicle with the brake pedal. For longer stops with the engine idling, shift into the NEUTRAL or PARK position and hold the vehicle with the parking brake. When stopping the vehicle uphill, do not hold it with the accelerator; use the brake. This avoids unnecessary transmission heat build-up.

Maneuvering

To maneuver in tight areas, control the vehicle speed by gradually releasing the brakes. Accelerate gently and never abruptly step on the accelerator.

To rock a vehicle out of soft ground (mud or snow), alternately shift from forward to reverse, while applying only slight acceleration. Rocking a vehicle free in this manner may cause the ABS or traction system malfunction indicator light to come on. Turn off the engine and restart the engine to clear the malfunction indication.

Brake Transmission Shift Interlock System

This vehicle is equipped with a brake transmission shift interlock system (BTSI) that holds the gearshift lever in the P (Park) position when the ignition switch is in the LOCK position. To move the gear selector lever out of the P (Park) position, the ignition switch must be turned to the ON position, and the brake pedal must be depressed.

Over Temperature Mode

The transmission electronics constantly monitor the transmission oil temperature. If the transmission exceeds normal operating temperature, the transmission will change the way it shifts to help control the condition. This may result in a slightly different feeling or response during normal operation in D (Drive) position. After the transmission cools down, it will return to normal operation.

AUTOSTICK — If Equipped

Autostick is a driver-interactive transmission that offers manual gear shifting to provide you with more control. Autostick allows you to maximize engine braking, eliminate undesirable upshifts and downshifts, and improve overall vehicle performance. This system can also provide you with more control during passing, city driving, cold slippery conditions, mountain driving, trailer towing, and many other situations.

Autostick Operation

By placing the shift lever in the DRIVE position it can be moved from side to side. This allows the driver to select a higher or lower range of gears. Moving the lever to the left (-) triggers a downshift and to the right (+) an upshift. The gear position will be shown in the transmission gear display, located in the instrument cluster.

You can shift in or out of the autostick mode at any time without taking your foot off the accelerator pedal. If you choose the Overdrive mode, the transmission will operate automatically; shifting between the five available gears. When you wish to engage autostick, simply move the shift lever to the Right or Left (D+/D-) position while in DRIVE. The transmission will remain in the current gear until an upshift or downshift is chosen.

PARKING BRAKE

When the parking brake is applied with the ignition switch on, the brake light in the instrument cluster will turn on.

NOTE: This light only shows that the parking brake is applied. It does not show the degree of brake application.

Before leaving the vehicle, make sure that the parking brake is fully applied and place the gear selector in the Park position.

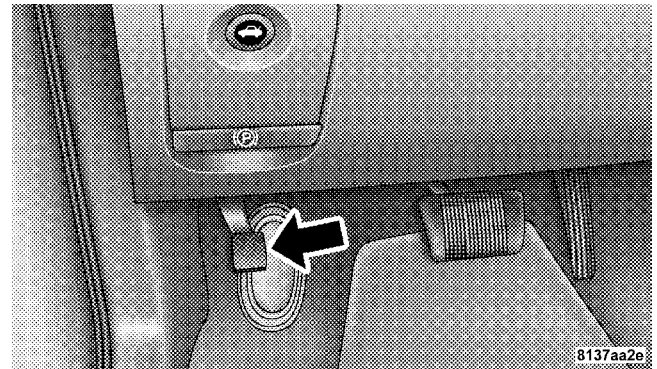

Parking Brake

To release the parking brake, pull out on the parking brake release located on the left side of the instrument panel.

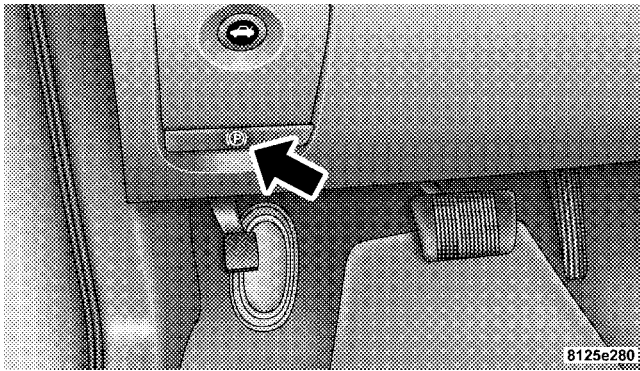

Parking Brake Release

When parking on a hill, it is important to set the parking brake before placing the gear selector in Park, otherwise the load on the transmission locking mechanism may make it difficult to move the selector out of park. As an added precaution, turn the front wheels toward the curb on a downhill grade and away from the curb on an uphill grade.

The parking brake should always be applied when the driver is not in the vehicle.

WARNING!

- Leaving children in a vehicle unattended is dangerous for a number of reasons. A child or others could be injured. Children should be warned not to touch the parking brake, brake pedal or the gear selector lever. Don't leave the keys in the ignition. A child could operate power windows, other controls, or move the vehicle.
- Be sure the parking brake is fully disengaged before driving: failure to do so can lead to brake failure, and an accident.

BRAKE SYSTEM

In the event power assist is lost for any reason (for example, repeated brake applications with the engine off), the brakes will still function. The effort required to brake the vehicle will be much greater than that required with the power system operating.

BRAKE Your vehicle is equipped with dual hydraulic brake systems. If either of the two hydraulic systems lose normal capability, the remaining system will still function. There will be some loss of overall braking effectiveness. This may be evident by increased pedal travel during application, greater pedal force required to slow or stop, and potential activation of the Brake Warning Light.

Anti-Lock Brake System

The Anti-Lock Brake System provides increased vehicle stability and brake performance under most braking conditions. The system automatically “pumps” the brakes during severe braking conditions to prevent wheel lock-up.

The electronic brake force distribution (EBD) prevents the rear wheels from over-braking and provides greater control of available braking forces applied to the rear axle.

WARNING!

Pumping of the Anti-Lock Brakes will diminish their effectiveness and may lead to an accident. Pumping makes the stopping distance longer. Just press firmly on your brake pedal when you need to slow down or stop.

WARNING!

- Anti-lock system (ABS) cannot prevent the natural laws of physics from acting on the vehicle, nor can it increase braking or steering efficiency beyond that afforded by the condition of the vehicle brakes and tires or the traction afforded.
- The ABS cannot prevent accidents, including those resulting from excessive speed in turns, following another vehicle too closely, or hydroplaning. Only a safe, attentive, and skillful driver can prevent accidents.
- The capabilities of an ABS equipped vehicle must never be exploited in a reckless or dangerous manner which could jeopardize the user's safety or the safety of others.

 The ABS light monitors the Anti-Lock Brake System. The light will come on when the ignition switch is turned to the ON position and may stay on for as long as four seconds.

If the ABS light remains on or comes on while driving, it indicates that the Anti-Lock portion of the brake system is not functioning and that service is required. However, the conventional brake system will continue to operate normally if the BRAKE warning light is not on.

If the ABS light is on, the brake system should be serviced as soon as possible to restore the benefits of Anti-Lock brakes. If the ABS light does not come on when the Ignition switch is turned to the ON position, have the bulb repaired as soon as possible.

If both the Brake Warning Light and the ABS Light remain on, the Anti-Lock brakes (ABS) and Electronic Brake Force Distribution (EBD) systems are not functioning. Immediate repair to the ABS system is required.

When the vehicle is driven over 7 mph (11 km/h), you may also hear a slight clicking sound as well as some related motor noises. These noises are the system performing its self check cycle to ensure that the ABS system is working properly. This self check occurs each time the vehicle is started and accelerated past 7 mph (11 km/h).

ABS is activated during braking under certain road or stopping conditions. ABS-inducing conditions can include ice, snow, gravel, bumps, railroad tracks, loose debris, or panic stops.

You also may experience the following when the brake system goes into Anti-lock:

- The ABS motor running (it may continue to run for a short time after the stop),
- the clicking sound of solenoid valves,
- brake pedal pulsations,
- and a slight drop or fall away of the brake pedal at the end of the stop.

These are all normal characteristics of ABS.

WARNING!

The Anti-Lock Brake System contains sophisticated electronic equipment that may be susceptible to interference caused by improperly installed or high output radio transmitting equipment. This interference can cause possible loss of anti-lock braking capability. Installation of such equipment should be performed by qualified professionals.

All vehicle wheels and tires must be the same size and type and tires must be properly inflated to produce accurate signals for the computer.

POWER STEERING

The standard power steering system will give you good vehicle response and increased ease of maneuverability in tight spaces. The system will provide mechanical steering capability if power assist is lost.

If for some reason, the power assist is interrupted, it will still be possible to steer your vehicle. Under these conditions you will observe a substantial increase in steering effort, especially at very low vehicle speeds and during parking maneuvers.

NOTE: Increased noise levels at the end of the steering wheel travel are considered normal and does not indicate that there is a problem with the power steering system.

Upon initial start-up in cold weather, the power steering pump may make noise for a short period of time. This is due to the cold, thick fluid in the steering system. This noise should be considered normal, and does not in any way damage the steering system.

WARNING!

Continued operation with reduced power steering assist could pose a safety risk to yourself and others. Service should be obtained as soon as possible.

CAUTION!

Prolong operation of the steering system at the end of the steering wheel travel will increase the steering fluid temperature and should be avoided when possible. Damage to the power steering pump may occur.

MULTI DISPLACEMENT SYSTEM (MDS) - 5.7L Engine Only

This feature offers improved fuel economy by shutting off four of the engine's eight cylinders during light load and cruise conditions. The system is automatic with no driver inputs or additional driving skills required.

NOTE: The MDS system may take some time to return to full functionality after a battery disconnect.

ALL WHEEL DRIVE — IF EQUIPPED

This feature provides full time All Wheel Drive (AWD) with Antilock Brake System (ABS)/Traction Control. The front wheels provide 38% of the torque, and the rear wheels provide 62% of the torque. The system is automatic with no driver inputs or additional driving skills required.

CAUTION!

All wheels must have the same size and type tires. Unequal tire sizes must not be used. Unequal tire size may cause failure of the front differential and/or the transfer case.

SELF-SEALING TIRES — IF EQUIPPED

A non-hardening viscous sealant applied to the inner liner of each tire fills punctures up to 0.19 in. (5 mm) to minimize the loss of air pressure. This contributes to the safety of the vehicle by significantly reducing the probability of a roadside stop due to a flat tire.

TIRE PRESSURE MONITOR SYSTEM — IF EQUIPPED

Tire Pressure Monitoring — Base System

The Tire Pressure Monitor System (TPMS) uses wireless technology with wheel rim mounted electronic sensors to monitor tire pressure levels (EXCLUDING THE SPARE TIRE). Sensors, mounted to each wheel as part of the valve stem, transmit tire pressure readings to the Receiver Module.

NOTE: It is particularly important, for you to check the tire pressure in all of your tires regularly and to maintain the proper pressure.

 The Tire Pressure Monitoring Telltale Light will illuminate in the instrument cluster, and an audible chime will be activated when one or more tire pressures is low. The Tire Pressure Monitoring Telltale Light will flash on and off for 10 to 60 seconds when a system fault is detected. The flash cycle will repeat every ten minutes or until the fault condition is removed and reset.

The Tire Pressure Monitoring System consists of the following components:

- Receiver Module
- 4 Wheel Sensors
- Tire Pressure Monitoring Telltale Light

NOTE: For vehicles with optional wheel/tire sizes and significantly different tire placard pressures, the placard pressure value and the low-pressure threshold value is re-programmable at your authorized dealer to accommodate the customer selected wheel/tire combinations recommended by DaimlerChrysler.

CAUTION!

The TPMS has been optimized for the original equipment tires and wheels. TPMS pressures have been established for the tire size equipped on your vehicle. Undesirable system operation or sensor damage may result when using replacement equipment that is not of the same size, type, and/or style. After-market wheels can cause sensor damage. Do not use tire sealant from a can, or balance beads if your vehicle is equipped with a TPMS, as damage to the sensors may result.

CAUTION!

After inspecting or adjusting the tire pressure always reinstall the valve stem cap. This will prevent moisture and dirt from entering the valve stem, which could damage the wheel rim sensor.

NOTE:

- The TPMS can inform the driver of a low tire pressure condition.
- The TPMS is not intended to replace normal tire care and maintenance, nor to provide warning of a tire failure or condition.
- The TPMS should not be used as a tire pressure gauge while adjusting your tire pressure.

Tire Pressure Monitoring — Premium System

The Tire Pressure Monitor System (TPMS) uses wireless technology with wheel rim mounted electronic sensors to monitor tire pressure levels. Sensors mounted to each wheel as part of the valve stem transmit tire pressure readings to the Receiver Module. The wheel sensors monitor tire pressure, and status for all four active road tires.

NOTE: It is particularly important, for you to check the tire pressure in all of your tires regularly and to maintain the proper pressure.



The Tire Pressure Monitoring Telltale Light will illuminate in the instrument cluster, and an audible chime will be activated when one or more tire pressures is low. The Tire Pressure Monitoring Telltale Light will flash on and off for 10 to 60 seconds when a system fault is detected. The flash cycle will repeat every ten minutes or until the fault condition is removed and reset.

The Tire Pressure Monitoring System consists of the following components:

- Receiver Module
- 4 Wheel Sensors
- 4 Wheel Sensor Trigger Modules
- Tire Pressure Monitoring System Display Messages in the EVIC
- Tire Pressure Monitoring Telltale Light

The system consists of tire pressure monitoring sensors attached to each wheel through the valve stem mounting hole, a central receiver module, Wheel Sensor Trigger

Modules mounted in three of the four wheel wells, various Tire Pressure Monitoring System Display Messages in the EVIC, and Telltale Light.

NOTE: For vehicles with optional wheel/tire sizes and significantly different tire placard pressures, the placard pressure value and the low-pressure threshold value is re-programmable at your authorized dealer to accommodate the customer selected wheel/tire combinations recommended by DaimlerChrysler.

The following "warnings" will cause a text message to be displayed, an audible chime to sound and the tire pressure Telltale Light to illuminate. The audible chime will occur once every ignition cycle for each "warning" detected. The tire pressure Telltale Light will illuminate continuously (solid) and will remain illuminated until the warning condition is removed/reset.

When the appropriate conditions exist, the Electronic Vehicle Information Center (EVIC) displays the following messages.

**LEFT FRONT, LEFT REAR, RIGHT FRONT,
RIGHT REAR LOW PRESSURE**

One or more of these messages will be displayed in the EVIC if a low tire pressure condition exists in one or more tires.

Inspect all tires for proper inflation pressure, once the proper tire pressure has been set, the TPMS warning will reset automatically when the vehicle has been driven for at least 2 minutes at or above 15 mph (24 km/h).

CHECK TPM SYSTEM

See your authorized dealer when this message appears in the EVIC. This message indicates that a system fault condition has been detected.

CAUTION!

The TPMS has been optimized for the original equipment tires and wheels. TPMS pressures have been established for the tire size equipped on your vehicle. Undesirable system operation or sensor damage may result when using replacement equipment that is not of the same size, type, and/or style. After-market wheels can cause sensor damage. Do not use tire sealant from a can, or balance beads if your vehicle is equipped with a TPMS, as damage to the sensors may result.

CAUTION!

After inspecting or adjusting the tire pressure always reinstall the valve stem cap. This will prevent moisture and dirt from entering the valve stem, which could damage the wheel rim sensor.

NOTE:

- The TPMS can inform the driver of a low tire pressure condition.
- The TPMS is not intended to replace normal tire care and maintenance, nor to provide warning of a tire failure or condition.
- The TPMS should not be used as a tire pressure gauge while adjusting your tire pressure.

General Information

This device complies with part 15 of the FCC rules and RSS 210 of Industry Canada. Operation is subject to the following conditions:

- This device may not cause harmful interference.
- This device must accept any interference received, including interference that may cause undesired operation.

The tire pressure sensors are covered under one of the following licenses:

United States KR5S120123
 Canada 2671-S120123

TIRE SAFETY INFORMATION

Tire Markings

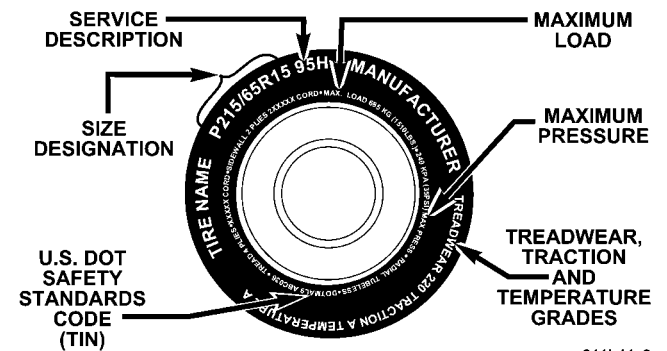

811b44e8

NOTE:

- P (Passenger)-Metric tire sizing is based on U.S. design standards. P-Metric tires have the letter “P” molded into the sidewall preceding the size designation. Example: P215/65R15 95H.

- European Metric tire sizing is based on European design standards. Tires designed to this standard have the tire size molded into the sidewall beginning with the section width. The letter "P" is absent from this tire size designation. Example: 215/65R15 96H
- LT (Light Truck)-Metric tire sizing is based on U.S. design standards. The size designation for LT-Metric tires is the same as for P-Metric tires except for the letters "LT" that are molded into the sidewall preceding the size designation. Example: LT235/85R16.
- Temporary Spare tires are high pressure compact spares designed for temporary emergency use only. Tires designed to this standard have the letter "T" molded into the sidewall preceding the size designation. Example: T145/80D18 103M.
- High Flotation tire sizing is based on U.S. design standards and begins with the tire diameter molded into the sidewall. Example: 31x10.5 R15 LT.

Tire Sizing Chart

EXAMPLE:	
Size Designation:	
	P = Passenger car tire size based on U.S. design standards
	"...blank..." = Passenger car tire based on European design standards
	LT = Light Truck tire based on U.S. design standards
	T = Temporary Spare tire
	31 = Overall Diameter in Inches (in)
	215 = Section Width in Millimeters (mm)
	65 = Aspect Ratio in Percent (%) —Ratio of section height to section width of tire.
	10.5 = Section Width in Inches (in)
	R = Construction Code —"R" means Radial Construction. —"D" means Diagonal or Bias Construction.
	15 = Rim Diameter in Inches (in)

EXAMPLE:	
Service Description:	
95 = Load Index	—A numerical code associated with the maximum load a tire can carry.
H = Speed Symbol	—A symbol indicating the range of speeds at which a tire can carry a load corresponding to its load index under certain operating conditions. —The maximum speed corresponding to the Speed Symbol should only be achieved under specified operating conditions. (i.e. tire pressure, vehicle loading, road conditions and posted speed limits).
Load Identification:	
"....blank...."	= Absence of any text on sidewall of the tire indicates a Standard Load (SL) Tire
Extra Load (XL)	= Extra Load (or Reinforced) Tire
Light Load	= Light Load Tire
C,D,E	= Load range associated with the maximum load a tire can carry at a specified pressure
Maximum Load — Maximum Load indicates the maximum load this tire is designed to carry.	
Maximum Pressure — Maximum Pressure indicates the maximum permissible cold tire inflation pressure for this tire.	

Tire Identification Number (TIN)

The TIN may be found on one or both sides of the tire however the date code may only be on one side. Tires with white sidewalls will have the full TIN including date code located on the white sidewall side of the tire.

Look for the TIN on the outboard side of black sidewall tires as mounted on the vehicle. If the TIN is not found on the outboard side then you will find it on the inboard side of the tire.

EXAMPLE:
DOT MA L9 ABCD 0301
DOT = Department of Transportation —This symbol certifies that the tire is in compliance with the U.S. Department of Transportation tire safety standards, and is approved for highway use.
MA = Code representing the tire manufacturing location. (2 digits)
L9 = Code representing the tire size. (2 digits)
ABCD = Code used by tire manufacturer. (1 to 4 digits)
03 = Number representing the week in which the tire was manufactured. (2 digits) —03 means the 3rd week.
01 = Number representing the year in which the tire was manufactured. (2 digits) —01 means the year 2001. —Prior to July 2000, tire manufacturers were only required to have 1 number to represent the year in which the tire was manufactured. Example: 031 could represent the 3rd week of 1981 or 1991.

Tire Loading and Tire Pressure

Tire Placard Location

NOTE: The proper cold tire inflation pressure is listed on either the face of the driver's door or the driver's side "B" pillar.

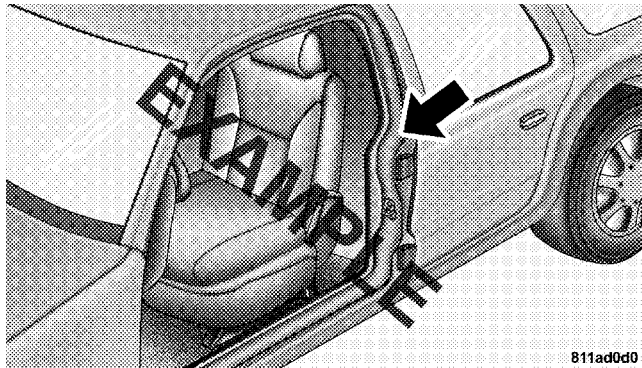

Tire Placard Location

Tire and Loading Information Placard

TIRE AND LOADING INFORMATION

SEATING CAPACITY - TOTAL 5 FRONT 2 REAR 3

THE COMBINED WEIGHT OF OCCUPANTS AND CARGO SHOULD NEVER EXCEED XXX KG OR XXX LBS

TIRE	FRONT	REAR	SPARE
ORIGINAL TIRE SIZE	P195/70R14	P195/70R14	T125/70D15
COLD TIRE INFLATION PRESSURE	200kPa, 29PSI	200kPa, 29PSI	420kPa, 60PSI

SEE OWNER'S MANUAL FOR ADDITIONAL INFORMATION

4N109268

811b5a9a

Tire and Loading Information

This placard tells you important information about the:

- 1) number of people that can be carried in the vehicle
- 2) the total weight your vehicle can carry
- 3) the tire size designed for your vehicle
- 4) the cold tire inflation pressures for the front, rear and spare tires.

Loading

The vehicle maximum load on the tire must not exceed the load carrying capacity of the tire on your vehicle. You will not exceed the tire's load carrying capacity if you adhere to the loading conditions, tire size, and cold tire inflation pressures specified on the "Tire and Loading Information" placard and in the "Vehicle Loading" section of this manual.

NOTE: Under a maximum loaded vehicle condition, gross axle weight ratings (GAWR's) for the front and rear axles must not be exceeded. For further information on GAWR's, vehicle loading, and trailer towing, refer to the "Vehicle Loading" section of this manual.

To determine the maximum loading conditions of your vehicle, locate the statement "The combined weight of occupants and cargo should never exceed XXX kg or XXX lbs." on the Tire and Loading Information placard. The combined weight of occupants, cargo/luggage and trailer tongue weight (if applicable) should never exceed the weight referenced here.

Steps for Determining Correct Load Limit

1. Locate the statement "The combined weight of occupants and cargo should never exceed XXX pounds" on your vehicle's placard.
2. Determine the combined weight of the driver and passengers that will be riding in your vehicle.
3. Subtract the combined weight of the driver and passengers from XXX kilograms or XXX pounds.
4. The resulting figure equals the available amount of cargo and luggage load capacity. For example, if "XXX" amount equals 1400 lbs. and there will be five 150 lb. passengers in your vehicle, the amount of available cargo and luggage load capacity is 650 lb. (since $5 \times 150 = 750$, and $1400 - 750 = 650$ lb.)

5. Determine the combined weight of luggage and cargo being loaded on the vehicle. That weight may not safely exceed the available cargo and luggage load capacity calculated in Step 4.
6. If your vehicle will be towing a trailer, load from your trailer will be transferred to your vehicle. Consult this manual to determine how this reduces the available cargo and luggage load capacity of your vehicle.

NOTE: The following table shows examples on how to calculate total load, cargo/luggage and towing capacities of your vehicle with varying seating configurations and number and size of occupants. This table is for illustration purposes only and may not be accurate for the seating and load carry capacity of your vehicle.

NOTE: For the following example the combined weight of occupants and cargo should never exceed 865 lbs. (392 Kg).

242 STARTING AND OPERATING

Occupants			Combined weight of occupants and cargo from Tire Placard	MINUS	Combined Occupant's weight	=	AVAILABLE Cargo/Luggage and Trailer Tongue Weight
TOTAL	FRONT	REAR					
EXAMPLE 1			865 lbs	minus	670 lbs	=	195 lbs
5	2	3					
EXAMPLE 2			865 lbs	minus	540 lbs	=	325 lbs
3	2	1					
EXAMPLE 3			865 lbs	minus	400 lbs	=	465 lbs
2	2	0					

EXAMPLE

Occupant 1: 200 lbs
 Occupant 2: 130 lbs
 Occupant 3: 160 lbs
 Occupant 4: 100 lbs
 Occupant 5: 80 lbs
 TOTAL WEIGHT: 670 lbs

Occupant 1: 210 lbs
 Occupant 2: 180 lbs
 Occupant 3: 150 lbs
 TOTAL WEIGHT: 540 lbs

Occupant 1: 200 lbs
 Occupant 2: 200 lbs
 TOTAL WEIGHT: 400 lbs

WARNING!

Overloading of your tires is dangerous. Overloading can cause tire failure, affect vehicle handling, and increase your stopping distance. Use tires of the recommended load capacity for your vehicle. Never overload them.

TIRES—GENERAL INFORMATION**Tire Pressure**

Proper tire inflation pressure is essential to the safe and satisfactory operation of your vehicle. Three primary areas are affected by improper tire pressure:

*1. Safety—***WARNING!**

Improperly inflated tires are dangerous and can cause accidents.

- Under inflation increases tire flexing and can result in tire failure.
- Over inflation reduces a tire's ability to cushion shock. Objects on the road and chuck holes can cause damage that results in tire failure.
- Unequal tire pressures can cause steering problems. You could lose control of your vehicle.
- Over inflated or under inflated tires can affect vehicle handling and can fail suddenly, resulting in loss of vehicle control.
- Unequal tire pressures from one side of the vehicle to the other can cause the vehicle to drift to the right or left.

Always drive with each tire inflated to the recommended cold tire inflation pressure.

2. *Economy*—

Improper inflation pressures can cause uneven wear patterns to develop across the tire tread. These abnormal wear patterns will reduce tread life resulting in a need for earlier tire replacement. Underinflation also increases tire rolling resistance and results in higher fuel consumption.

3. *Ride Comfort and Vehicle Stability*—

Proper tire inflation contributes to a comfortable ride. Overinflation produces a jarring and uncomfortable ride.

Tire Inflation Pressures

The proper cold tire inflation pressure is listed on either the face of the driver's door or the driver's side "B" pillar.

Some vehicles may have Supplemental Tire Pressure Information for vehicle loads that are less than the maximum loaded vehicle condition. These pressure conditions will be found in the "Supplemental Tire Pressure Information" section of this manual.

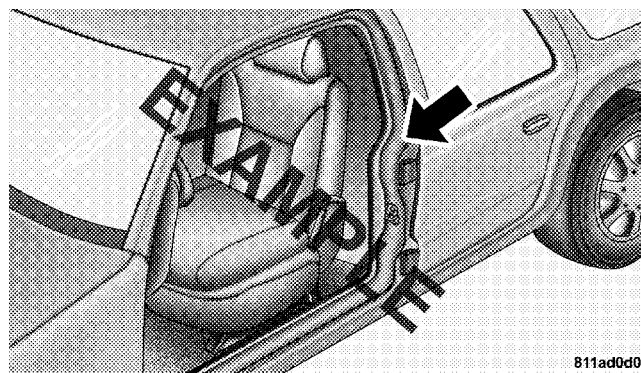

Tire Placard Location

The pressure should be checked and adjusted as well as inspecting for signs of tire wear or visible damage at least once a month. Use a good quality pocket-type gauge to check tire pressure. Do not make a visual judgement when determining proper inflation. Radial tires may look properly inflated even when they are under inflated.

CAUTION!

After inspecting or adjusting the tire pressure, always reinstall the valve stem cap—if equipped. This will prevent moisture and dirt from entering the valve stem, which could damage the valve stem.

Inflation pressures specified on the placard are always “cold tire inflation pressure”. Cold tire inflation pressure is defined as the tire pressure after the vehicle has not been driven for at least 3 hours, or driven less than 1 mile (1 km) after a 3 hour period. The cold tire inflation pressure must not exceed the maximum inflation pressure molded into the tire side wall.

Check tire pressures more often if subject to a wide range of outdoor temperatures, as tire pressures vary with temperature changes.

Tire pressures change by approximately 1 psi (7 kPa) per 12° F (7° C) of air temperature change. Keep this in mind when checking tire pressure inside a garage, especially in the winter.

Example: If garage temperature = 68° F (20° C) and the outside temperature = 32° F (0° C) then the cold tire inflation pressure should be increased by 3 psi (21 kPa), which equals 1 psi (7 kPa) for every 12° F (7° C) for this outside temperature condition.

Tire pressure may increase from 2 to 6 psi (13 to 40 kPa) during operation. DO NOT reduce this normal pressure build up or your tire pressure will be too low.

Tire Pressures for High Speed Operation

The manufacturer advocates driving at safe speeds within posted speed limits. Where speed limits or conditions are such that the vehicle can be driven at high speeds, maintaining correct tire inflation pressure is very important. Increased tire pressure and reduced vehicle loading may be required for high speed vehicle operation. Refer to original equipment or an authorized tire dealer for recommended safe operating speeds, loading and cold tire inflation pressures.

WARNING!

High speed driving with your vehicle under maximum load is dangerous. The added strain on your tires could cause them to fail. You could have a serious accident. Don't drive a vehicle loaded to the maximum capacity at continuous speeds above 75 mph (120 km/h).

Radial-Ply Tires**WARNING!**

Combining radial ply tires with other types of tires on your vehicle will cause your vehicle to handle poorly. The instability could cause an accident. Always use radial ply tires in sets of four (or 6, in case of trucks with dual rear wheels). Never combine them with other types of tires.

Cuts and punctures in radial tires are repairable only in the tread area because of sidewall flexing. Consult your authorized tire dealer for radial tire repairs.

Compact Spare Tire — If Equipped

The compact spare is for temporary emergency use with radial tires. It is engineered to be used on your style vehicle only. Since this tire has limited tread life, the original tire should be repaired (or replaced) and reinstalled at the first opportunity.

WARNING!

Temporary use spare tires are for emergency use only. With these tires, do not drive more than 50 mph (80 km/h). Temporary-use spare tires have limited tread life. When the tread is worn to the tread wear indicators, the temporary use spare tire needs to be replaced. Be sure to follow the warnings which apply to your spare. Failure to do so could result in spare tire failure and loss of vehicle control.

Do not install a wheel cover or attempt to mount a conventional tire on the compact spare wheel, since the wheel is designed specifically for the compact spare.

Do not install more than one compact spare tire/wheel on the vehicle at any given time.

CAUTION!

Because of the reduced ground clearance, do not take your vehicle through an automatic car wash with the compact spare installed. Damage to the vehicle may result.

Limited Use Spare — If Equipped

The limited use spare tire is for temporary emergency use on your vehicle. This tire is identified by a limited use spare tire warning label located on the limited use spare tire and wheel assembly. This tire may look like the original equipped tire on the front or rear axle of your vehicle, but it is not. Installation of this limited use spare

tire affects vehicle handling. Since it is not the same tire, replace (or repair) the original tire and reinstall on the vehicle at the first opportunity.

WARNING!

The limited use spare tires are for emergency use only. Installation of this limited use spare tire affects vehicle handling. With this tire, do not drive more than 60 mph (100 km/h). Keep inflated to the cold tire inflation pressure listed on either your tire placard or limited use spare tire and wheel assembly. Replace (or repair) the original tire at the first opportunity and reinstall it on your vehicle. Failure to do so could result in loss of vehicle control.

5

Tire Spinning

When stuck in mud, sand, snow, or ice conditions, do not spin your vehicle's wheels above 35 mph (55 km/h).

See the paragraph on Freeing A Stuck Vehicle in Section 6 of this manual.

WARNING!

Fast spinning tires can be dangerous. Forces generated by excessive wheel speeds may cause tire damage or failure. A tire could explode and injure someone. Do not spin your vehicle's wheels faster than 35 mph (55 km/h) when you are stuck. And don't let anyone near a spinning wheel, no matter what the speed.

Tread Wear Indicators

Tread wear indicators are in the original equipment tires to help you in determining when your tires should be replaced.

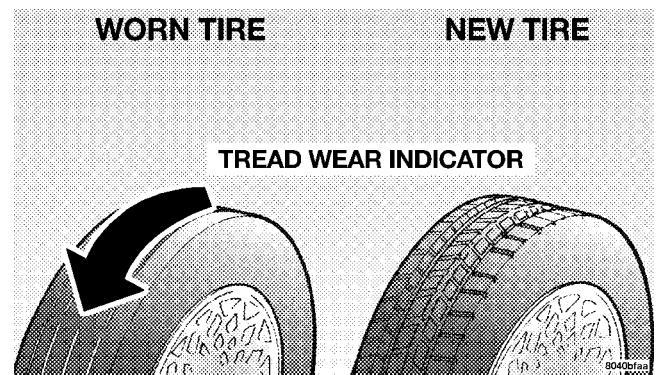

These indicators are molded into the bottom of the tread grooves and will appear as bands when the tread depth becomes 1/16 inch (2 mm). When the tread is worn to the tread wear indicators, the tire should be replaced.

Many states have laws requiring tire replacement at this point.

Life of Tire

The service life of a tire is dependent upon varying factors including but not limited to:

- Driving style
- Tire pressure
- Distance driven

WARNING!

Tires and spare tire should be replaced after six years, regardless of the remaining tread. Failure to follow this warning can result in sudden tire failure. You could lose control and have an accident resulting in serious injury or death.

Keep unmounted tires in a cool, dry place with as little exposure to light as possible. Protect tires from contact with oil, grease and gasoline.

Replacement Tires

The tires on your new vehicle provide a balance of many characteristics. They should be inspected regularly for wear and correct cold tire inflation pressure. The manufacturer strongly recommends that you use tires equivalent to the originals in size, quality and performance when replacement is needed (see the paragraph on tread wear indicators). Refer to the Tire and Loading Information placard for the size designation of your tire. The service description and load identification will be found on the original equipment tire. Failure to use equivalent replacement tires may adversely affect the safety, handling, and ride of your vehicle. We recommend that you contact your original equipment or an authorized tire dealer with any questions you may have on tire specifications or capability.

WARNING!

- Do not use a tire, wheel size or rating other than that specified for your vehicle. Some combinations of unapproved tires and wheels may change suspension dimensions and performance characteristics, resulting in changes to steering, handling, and braking of your vehicle. This can cause unpredictable handling and stress to steering and suspension components. You could lose control and have an accident resulting in serious injury or death. Use only the tire and wheel sizes with load ratings approved for your vehicle.
- Never use a tire with a smaller load index or capacity, other than what was originally equipped on your vehicle. Using a tire with a smaller load index could result in tire overloading and failure. You could lose control and have an accident.
- Failure to equip your vehicle with tires having adequate speed capability can result in sudden tire failure and loss of vehicle control.

CAUTION!

Replacing original tires with tires of a different size may result in false speedometer and odometer readings.

Alignment And Balance

Poor suspension alignment may result in:

- Fast tire wear.
- Uneven tire wear, such as feathering and one-sided wear.
- Vehicle pull to right or left.

Tires may also cause the vehicle to pull to the left or right. Alignment will not correct this condition. See your dealer for proper diagnosis.

Improper alignment will not cause vehicle vibration. Vibration may be a result of tire and wheel out-of-balance. Proper balancing will reduce vibration and avoid tire cupping and spotty wear.

TIRE CHAINS

Use only compact chains, or other traction aids that meet SAE type “Class S” specifications. Chains must be the proper size for the vehicle, as recommended by the chain manufacturer.

NOTE: Do not use tire chains on a compact spare tire.

CAUTION!

To avoid damage to your vehicle or tires, observe the following precautions:

- Because of restricted chain clearance between tires and other suspension components, it is important that only chains in good condition are used. Broken chains can cause serious damage. Stop the vehicle immediately if noise occurs that could indicate chain breakage. Remove the damaged parts of the chain before further use.
- Install chains on the rear wheels as tightly as possible and then retighten after driving about ½ mile (0.8 km).
- Do not exceed 30 mph (48 km/h).
- Drive cautiously and avoid severe turns and large bumps, especially with a loaded vehicle.
- Use on Rear Wheels only.
- Do not drive for prolonged period on dry pavement.
- Observe the tire chain manufacturer’s instructions on the method of installation, operating speed, and conditions for use. Always use the lower suggested operating speed of the chain manufacturer if different than the speed recommended by the manufacture.

NOTE: In order to avoid damage to tires, chains, and your vehicle do not drive for a prolonged period of time on dry pavement. Observe the tire chain manufacturer's instructions on method of installation, operating speed, and conditions for usage.

Always use the lower suggested operating speed if both the chain manufacturer and vehicle manufacture suggest a maximum speed. This notice applies to all chain traction devices, including link and cable (radial) chains.

SNOW TIRES

Some areas of the country require the use of snow tires during winter. Standard tires are of the all season type and satisfy this requirement as indicated by the M+S designation on the tire side wall.

If you need snow tires, select tires equivalent in size and type to the original equipment tires. Use snow tires only in sets of 4, failure to do so may adversely affect the safety and handling of your vehicle.

Snow tires generally have lower speed ratings than what was originally equipped with your vehicle and should not be operated at sustained speeds over 75 mph (120 km/h).

TIRE ROTATION RECOMMENDATIONS

Tires on the front and rear axles of vehicles operate at different loads and perform different steering, driving, and braking functions. For these reasons, they wear at unequal rates, and tend to develop irregular wear patterns.

These effects can be reduced by timely rotation of tires. The benefits of rotation are especially worthwhile with aggressive tread designs such as those on all season type tires. Rotation will increase tread life, help to maintain mud, snow, and wet traction levels, and contribute to a smooth, quiet ride.

Follow the recommended tire rotation frequency for your type of driving found in the “Maintenance Schedules” Section of this manual. More frequent rotation is permissible if desired. The reasons for any rapid or unusual wear should be corrected prior to rotation being performed.

The suggested rotation method is the “forward-cross” shown in the following diagram.

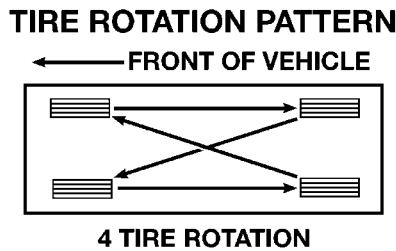

80ba79fe

FUEL REQUIREMENTS

2.7L Engines



Your vehicle is designed to meet all emissions regulations and provide satisfactory fuel economy and performance when using high quality unleaded gasoline having an octane of 87.

3.5L and 5.7L Engines



The 3.5L and 5.7L engines are designed to meet all emissions regulations and provide satisfactory fuel economy and performance when using high-quality unleaded gasoline with an octane rating of 87 to 89.

The manufacturer recommends the use of 89-octane for optimum performance. The routine use of premium gasoline is not recommended. The use of premium gasoline will provide no benefit over high-quality regular gasoline or mid-grade gasoline and in some circumstances may result in poorer performance.

Spark Knock

Light spark knock at low engine speeds is not harmful to your engine. However, continued heavy spark knock at high speeds can cause damage and immediate service is required.

Poor quality gasoline can cause problems such as hard starting, stalling and hesitations. If you experience these symptoms, try another brand of “regular” gasoline before considering service for the vehicle.

Over 40 automobile manufacturers around the world have issued and endorsed consistent gasoline specifications (the World Wide Fuel Charter, WWFC) to define fuel properties necessary to deliver enhanced emissions, engine performance, and durability for your vehicle. The manufacturer recommends the use of gasolines that meet the WWFC specifications if they are available.

Reformulated Gasoline

Many areas of the country require the use of cleaner burning gasoline referred to as “Reformulated Gasoline”.

Reformulated gasolines contain oxygenates, and are specifically blended to reduce vehicle emissions and improve air quality.

The manufacturer supports the use of reformulated gasolines. Properly blended reformulated gasolines will provide excellent performance and durability of engine and fuel system components.

Gasoline/Oxygenate Blends

Some fuel suppliers blend unleaded gasoline with oxygenates such as 10% ethanol, MTBE, and ETBE. Oxygenates are required in some areas of the country during the winter months to reduce carbon monoxide emissions. Fuels blended with these oxygenates may be used in your vehicle.

CAUTION!

DO NOT use gasolines containing Methanol. Use of these blends may result in starting and driveability problems and may damage critical fuel system components.

Problems that result from using methanol/gasoline blends are not the responsibility of the manufacturer. While MTBE is an oxygenate made from Methanol, it does not have the negative effects of Methanol.

MMT In Gasoline

MMT is a manganese containing metallic additive that is blended into some gasoline to increase the octane number. Gasolines blended with MMT offer no performance advantage beyond gasolines of the same octane number without MMT. Gasolines blended with MMT have shown to reduce spark plug life and reduce emission system performance in some vehicles. The manufacturer recommends using gasolines without MMT. Since the MMT

content of gasoline may not be indicated on the pump, you should ask your gasoline retailer whether or not his/her gasoline contains MMT.

It is even more important to look for gasolines without MMT in Canada, because MMT can be used at levels higher than those allowed in the United States.

MMT is prohibited in Federal and California reformulated gasolines.

Materials Added to Fuel

All gasoline sold in the United States is required to contain effective detergent additives. Use of additional detergents or other additives are not needed under normal conditions and would result in additional cost. Therefore you should not have to add anything to the fuel.

Fuel System Cautions**CAUTION!**

Follow these guidelines to maintain your vehicle's performance:

- The use of leaded gas is prohibited by Federal law. Using leaded gasoline can impair engine performance, or damage the emission control system.
- An out-of-tune engine, or certain fuel or ignition malfunctions, can cause the catalytic converter to overheat. If you notice a pungent burning odor or some light smoke, your engine may be out-of-tune or malfunctioning and may require immediate service. Contact your dealer for service assistance.

- The use of fuel additives which are now being sold as octane enhancers are not recommended. Most of these products contain high concentrations of methanol. Fuel system damage or vehicle performance problems resulting from the use of such fuels or additives are not the responsibility of the manufacturer.

NOTE: Intentional tampering with emissions control systems can result in civil penalties being assessed against you.

Carbon Monoxide Warnings**WARNING!**

Carbon monoxide (CO) in exhaust gases is deadly. Follow the precautions below to prevent carbon monoxide poisoning:

- Do not inhale exhaust gases. They contain carbon monoxide, a colorless and odorless gas which can kill. Never run the engine in a closed area, such as a garage, and never sit in a parked vehicle with the engine running for an extended period. If the vehicle is stopped in an open area with the engine running for more than a short period, adjust the ventilation system to force fresh, outside air into the vehicle.
- Guard against carbon monoxide with proper maintenance. Have the exhaust system inspected every time the vehicle is raised. Have any abnormal conditions repaired promptly. Until repaired, drive with all side windows fully open.
- Keep the trunk closed when driving your vehicle to prevent carbon monoxide and other poisonous exhaust gases from entering the vehicle.

ADDING FUEL

Fuel Filler Cap (Gas Cap)

The gas cap is located behind the fuel filler door on the left side of the vehicle. Push in on the left side (near the edge) of the fuel filler door to access the fuel filler cap. If the gas cap is lost or damaged, be sure the replacement cap is for use with this vehicle.

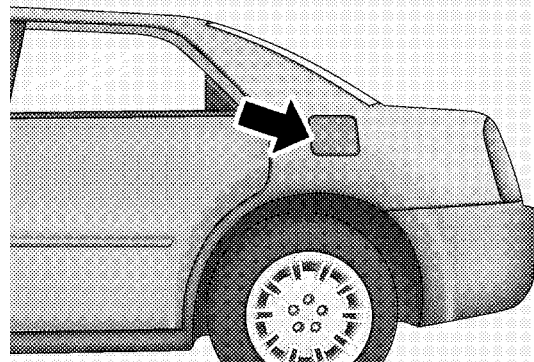

81368080

Fuel Filler Door

NOTE: When removing the fuel filler cap, lay the cap tether in the hook, located on the fuel filler cap door reinforcement.

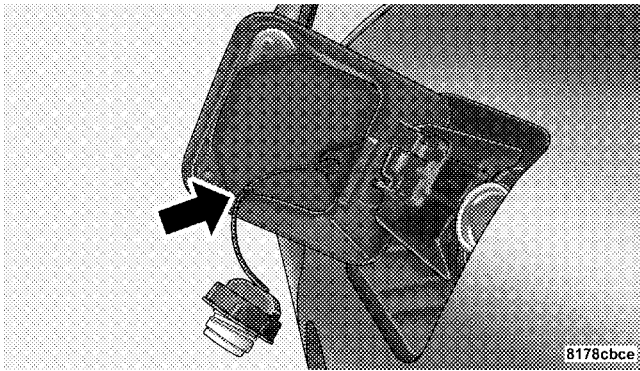

Gas Cap Tether Hook

CAUTION!

Damage to the fuel system or emission control system could result from using an improper fuel tank filler tube cap (gas cap), and may result in a malfunction indicator light on the instrument cluster. A poorly fitting cap could let impurities into the fuel system.

CAUTION!

To avoid fuel spillage and overfilling, do not “top off” the fuel tank after filling. When the fuel nozzle “clicks” or shuts off, the fuel tank is full.

NOTE:

- Tighten the gas cap until you hear a “clicking” sound. This is an indication that the gas cap is properly tightened. If the gas cap is not secured properly the Malfunction Indicator Light in the instrument cluster will turn on. Make sure that the gas cap is tightened each time the vehicle is refueled.
- When the fuel nozzle “clicks” or shuts off, the fuel tank is full.

Loose Fuel Filler Cap Message

If the vehicle diagnostic system determines that the fuel filler cap is loose, improperly installed, or damaged, a “Check Gascap” message will display in the Electronic Vehicle Information Center (EVIC) — if equipped. Refer to “Electronic Vehicle Information Center (EVIC)” in Section 4 of this manual. Tighten the fuel filler cap properly and press the odometer reset button to turn the message off. If the problem continues, the message will appear the next time the vehicle is started. Refer to “Onboard Diagnostic System” in Section 7 of this manual for more information.

WARNING!

- Remove the fuel tank filler tube cap (gas cap) slowly to prevent fuel spray from the filler neck which may cause injury.
- The volatility of some gasolines may cause a buildup of pressure in the fuel tank that may increase while you drive. This pressure can result in a spray of gasoline and/or vapors when the cap is removed from a hot vehicle. Removing the cap slowly allows the pressure to vent and prevents fuel spray.
- Never have any smoking materials lit in or near the vehicle when the gas cap is removed or the tank filled.
- Never add fuel to the vehicle when the engine is running.
- A fire may result if gasoline is pumped into a portable container that is inside of a vehicle. You could be burned. Always place gas containers on the ground while filling.

VEHICLE LOADING

The load carrying capacity of your vehicle is shown in the charts that follow. This information should be used for passenger and luggage loading as indicated.

If the seatbacks are folded for carrying cargo, do not exceed the specified GVWR and GAWR.

Vehicle Certification Label

Your vehicle has a certification label attached to the rear of the driver's door.

The label contains the following information:

- Name of manufacturer
- Month and year of manufacture
- Gross Vehicle Weight Rating (GVWR)
- Gross Axle Weight Rating (GAWR) front
- Gross Axle Weight Rating (GAWR) rear
- Vehicle Identification Number (VIN)
- Type of Vehicle
- Month Day and Hour of Manufacture (MDH)

The bar code allows a computer scanner to read the Vehicle Identification Number (VIN).

Gross Vehicle Weight Rating (GVWR)

The GVWR is the total allowable weight of your vehicle. This includes driver, passengers, and cargo. The total load must be limited so that you do not exceed the GVWR.

Gross Axle Weight Rating (GAWR)

The GAWR is the maximum capacity of the front and rear axles. Distribute the load over the front and rear axles evenly. Make sure that you do not exceed either front or rear GAWR.

WARNING!

Because the front wheels steer the vehicle, it is important that you do not exceed the maximum front or rear GAWR. A dangerous driving condition can result if either rating is exceeded. You could lose control of the vehicle and have an accident.

Overloading

The load carrying components (axle, springs, tires, wheels, etc.) of your vehicle will provide satisfactory service as long as you do not exceed the GVWR and front and rear GAWR.

The best way to figure out the total weight of your vehicle is to weigh it when it is fully loaded and ready for operation. Weigh it on a commercial scale to insure that it is not over the GVWR.

Figure out the weight on the front and rear of the vehicle separately. It is important that you distribute the load evenly over the front and rear axles.

Overloading can cause potential safety hazards and shorten useful service life. Heavier axles or suspension components do not necessarily increase the vehicle's GVWR.

Loading

To load your vehicle properly, first figure out its empty weight, axle by axle and side by side. Store heavier items down low and be sure you distribute their weight as evenly as possible. Stow all loose items securely before

driving. If weighing the loaded vehicle shows that you have exceeded either GAWR, but the total load is within the specified GVWR, you must redistribute the weight. Improper weight distribution can have an adverse effect on the way your vehicle steers and handles and the way the brakes operate.

A loaded vehicle is shown in the illustration. Note that neither the GVWR or the GAWR capacities have been exceeded.

GROSS VEHICLE WEIGHT RATING (GVWR) 2177 KG (4800 LBS)
(Example Only)

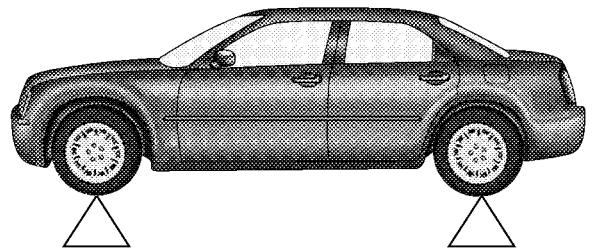

812cb8da

	Front Axle	Rear Axle
Empty Weight	2054 lbs (932 kg)	1805 lbs (819 kg)
Load (Including driver, passengers and cargo)	271 lbs (123 kg)	579 lbs (263 kg)
Total	2325 lbs (1055 kg)	2384 lbs (1081 kg)
GAWR	2546 lbs (1155 kg)	2708 lbs (1228 kg)

NOTE: Refer to the Vehicle Certification Label attached to the rear of the driver's door for your vehicle's GVWR and GAWRs. This table is only an example.

TRAILER TOWING

In this section you will find safety tips and information on limits to the type of towing you can reasonably do with your vehicle. Before towing a trailer carefully review this information to tow your load as efficiently and safely as possible.

To maintain warranty coverage, follow the requirements and recommendations in this manual concerning vehicles used for trailer towing.

Common Towing Definitions

The following trailer towing related definitions will assist you in understanding the following information:

Gross Vehicle Weight Rating (GVWR)

The GVWR is the total allowable weight of your vehicle. This includes driver, passengers, cargo and tongue weight. The total load must be limited so that you do not exceed the GVWR.

Gross Trailer Weight (GTW)

The gross trailer weight (GTW) is the weight of the trailer plus the weight of all cargo, consumables and equipment (permanent or temporary) loaded in or on the trailer in its "loaded and ready for operation" condition. The recommended way to measure GTW is to put your fully loaded trailer on a vehicle scale. The entire weight of the trailer must be supported by the scale.

Gross Axle Weight Rating (GAWR)

The GAWR is the maximum capacity of the front and rear axles. Distribute the load over the front and rear axles evenly. Make sure that you do not exceed either front or rear GAWR.

WARNING!

It is important that you do not exceed the maximum front or rear GAWR. A dangerous driving condition can result if either rating is exceeded. You could lose control of the vehicle and have an accident.

Tongue Weight (TW)

The downward force exerted on the hitch ball by the trailer. In most cases it should not be less than 10% or more than 15% of the trailer load. You must consider this as part of the load on your vehicle.

Frontal Area

The maximum height and maximum width of the front of a trailer.

Trailer Sway Control

The trailer sway control is a telescoping link that can be installed between the hitch receiver and the trailer tongue that typically provides adjustable friction associated with the telescoping motion to dampen any unwanted trailer swaying motions while traveling.

Weight-Carrying Hitch

A weight-carrying hitch supports the trailer tongue weight, just as if it were luggage located at a hitch ball or some other connecting point of the vehicle. These kind of hitches are the most popular on the market today and they're commonly used to tow small- and medium-sized trailers. See your authorized dealer for a trailer hitch engineered specifically for your vehicle.

Weight-Distributing Hitch

A weight-distributing hitch includes a receiver attached to the tow vehicle, plus a removable hitch head and spring bar assembly that fits into the receiver opening and hook up brackets that connect the spring bars to the trailer frame. See your authorized dealer for a trailer hitch engineered specifically for your vehicle.

Trailer Hitch Classification

Your vehicle may be factory equipped for safe towing of trailers weighing over 2,000 lbs (907 kg) with the optional Trailer Tow Prep Package. See your authorized dealer for package content and for a trailer hitch engineered specifically for your vehicle.

The following chart provides the industry standard for the maximum trailer weight a given trailer hitch class can tow and should be used to assist you in selecting the correct trailer hitch for your intended towing condition. Refer to the Trailer Towing Weights (Maximum Trailer Weight Ratings) chart for the Max. GTW towable for your given drivetrain.

Trailer Hitch Classification	
Class	Max. GTW (Gross Trailer Wt.)
Class I - Light Duty	2,000 lbs (907 kg)
Class II - Medium Duty	3,500 lbs (1587 kg)
Class III - Heavy Duty	5,000 lbs (2268 kg)
Class IV - Extra Heavy Duty	10,000 lbs (4540 kg)

All trailer hitches should be professionally installed on your vehicle. See your authorized dealer for a trailer hitch engineered specifically for your vehicle.

Trailer Towing Weights (Maximum Trailer Weight Ratings)

The following chart provides the maximum trailer weight ratings towable for your given drivetrain.

Engine/Transmission	Frontal Area	Max. GTW (Gross Trailer Wt.)	Max. Tongue Wt.
2.7L Automatic	22 SQ. FT. (2.04 square meters)	Up to 2 persons & Luggage 1,000 lbs (454 kg)	100 lbs (45 kg)
	22 SQ. FT. (2.04 square meters)	Up to 3 persons & Luggage 1,000 lbs (454 kg)	100 lbs (45 kg)
	22 SQ. FT. (2.04 square meters)	Up to 4 persons & Luggage 1,000 lbs (454 kg)	100 lbs (45 kg)
	22 SQ. FT. (2.04 square meters)	Up to 5 persons & NO Luggage 1,000 lbs (454 kg)	100 lbs (45 kg)
3.5L & 5.7L Automatic	32 SQ. FT. (2.97 square meters)	Up to 2 persons & Luggage 2,000 lbs (907 kg)	200 lbs (91 kg)
	32 SQ. FT. (2.97 square meters)	Up to 3 persons & Luggage 2,000 lbs (907 kg)	200 lbs (91 kg)
	32 SQ. FT. (2.97 square meters)	Up to 4 persons & Luggage 1,500 lbs (680 kg)	150 lbs (68 kg)
	32 SQ. FT. (2.97 square meters)	Up to 5 persons & NO Luggage 1,000 lbs (454 kg)	100 lbs (45 kg)
Refer to local laws for maximum trailer towing speeds.			

NOTE: The trailer tongue weight must be considered as part of the combined weight of occupants and cargo, and should never exceed the weight referenced on the Tire

and Loading Information placard. Refer to the Tire-Safety Information Section in this manual.

Trailer and Tongue Weight

Always load a trailer with 60% to 65% of the weight in the front of the trailer. This places 10% to 15% of the Gross Trailer Weight (GTW) on the tow hitch of your vehicle. Loads balanced over the wheels or heavier in the rear can cause the trailer to sway severely side to side which will cause loss of control of the vehicle and trailer. Failure to load trailers heavier in front is the cause of many trailer accidents.

Never exceed the maximum tongue weight stamped on your bumper or trailer hitch.

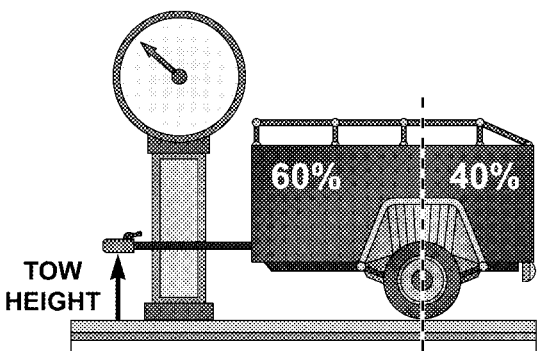

81546c40

Consider the following items when computing the weight on the rear axle of the vehicle:

- The tongue weight of the trailer.
- The weight of any other type of cargo or equipment put in or on your vehicle.
- The weight of the driver and all passengers.

NOTE: Remember that everything put into or on the trailer adds to the load on your vehicle. Also, additional factory-installed options, or dealer-installed options, must be considered as part of the total load on your vehicle. Refer to the Tire and Loading Information placard in the Tire Safety Information Section of this manual for the maximum combined weight of occupants and cargo for your vehicle.

Towing Requirements

To promote proper break-in of your new vehicle drivetrain components the following guidelines are recommended:

CAUTION!

- Avoid towing a trailer for the first 500 miles (805 km) of vehicle operation. Doing so may damage your vehicle.
- During the first 500 miles (805 km) of trailer towing, limit your speed to 50 mph (80 km/h).

Perform the maintenance listed in Section 8 of this manual. When towing a trailer, never exceed the GAWR, or GCWR, ratings.

WARNING!

Improper towing can lead to an injury accident. Follow these guidelines to make your trailer towing as safe as possible:

Make certain that the load is secured in the trailer and will not shift during travel. When trailering cargo that is not fully secured, dynamic load shifts can occur that may be difficult for the driver to control. You could lose control of your vehicle and have an accident.

- When hauling cargo or towing a trailer, do not overload your vehicle or trailer. Overloading can cause a loss of control, poor performance or damage to brakes, axle, engine, transmission, steering, suspension, chassis structure or tires.
- Safety chains must always be used between your vehicle and trailer. Always connect the chains to the frame or hook retainers of the vehicle hitch. Cross the chains under the trailer tongue and allow enough slack for turning corners.

- Vehicles with trailers should not be parked on a grade. When parking, apply the parking brake on the tow vehicle. Put the tow vehicle automatic transmission in P for Park. Always, block or "chock" the trailer wheels.
 - GCWR must not be exceeded.
 - **Total weight must be distributed between the tow vehicle and the trailer such that the following four ratings are not exceeded:**
 1. GVWR
 2. GTW
 3. GAWR
 4. Tongue weight rating for the trailer hitch utilized (This requirement may limit the ability to always achieve the 10% to 15% range of tongue weight as a percentage of total trailer weight).
- Proper tire inflation pressures are essential to the safe and satisfactory operation of your vehicle. Refer to the Tires-General Information section of this manual on Tire Pressures for proper tire inflation procedures.
 - Also, check the trailer tires for proper tire inflation pressures before trailer usage.
 - Check for signs of tire wear or visible tire damage before towing a trailer. Refer to the Tires-General Information section of this manual on Tread Wear Indicators for the proper inspection procedure.
 - When replacing tires refer to the Tires-General Information section of this manual on Replacement Tires for proper tire replacement procedures. Replacing tires with a higher load carrying capacity will not increase the vehicle's GVWR and GAWR limits.

Towing Requirements — Trailer Brakes

- Do not attempt to tow a trailer while using a compact spare tire.
- Do **not** interconnect the hydraulic brake system or vacuum system of your vehicle with that of the trailer. This could cause inadequate braking and possible personal injury.

- An electronically actuated trailer brake controller is required when towing a trailer with electronically actuated brakes. When towing a trailer equipped with a hydraulic surge actuated brake system, an electronic brake controller is not required.
- Trailer brakes are recommended for trailers over 1,000 lbs (454 kg) and required for trailers in excess of 2,000 lbs (907 kg).

CAUTION!

If the trailer weighs more than 1,000 lbs (454 kg) loaded, it should have its own brakes and they should be of adequate capacity. Failure to do this could lead to accelerated brake lining wear, higher brake pedal effort, and longer stopping distances.

WARNING!

Do not connect trailer brakes to your vehicle's hydraulic brake lines. It can overload your brake system and cause it to fail. You might not have brakes when you need them and could have an accident.

Towing any trailer will increase your stopping distance. When towing you should allow for additional space between your vehicle and the vehicle in front of you. Failure to do so could result in an accident.

5

Towing Requirements — Trailer Lights & Wiring

Whenever you pull a trailer, regardless of the trailer size, stop lights and turn signals on the trailer are required for motoring safety.

The Trailer Tow Package may include a 4 and 7 pin wiring harness. Use a factory approved trailer harness and connector.

NOTE: Do not cut or splice wiring into the vehicles wiring harness.

The electrical connections are all complete to the vehicle but you must mate the harness to a trailer connector. Refer to the following illustrations.

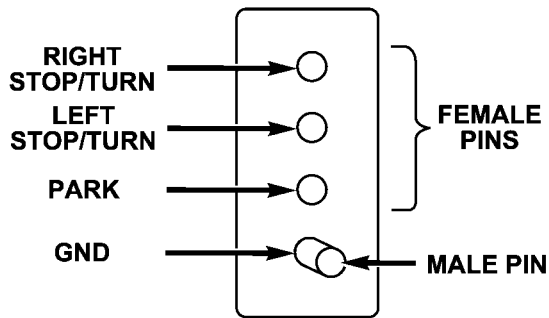

4 - Pin Connector

813262be

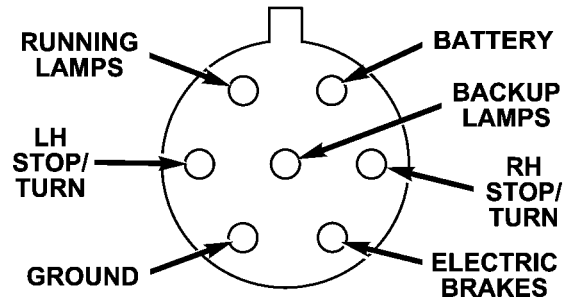

7 - Pin Connector

812634c6

Towing Tips

Before setting out on a trip, practice turning, stopping and backing the trailer in an area away from heavy traffic.

Towing Tips — Automatic Transmission

The “D” range can be selected when towing. However, if frequent shifting occurs while in this range, the “3” range should be selected.

NOTE: Using the “3” range while operating the vehicle under heavy operating conditions will improve performance and extend transmission life by reducing excessive shifting and heat build up. This action will also provide better engine braking.

The automatic transmission fluid and filter should be changed if you REGULARLY tow a trailer for more than 45 minutes of continuous operation. See Schedule “B” in section 8 of this manual for transmission fluid change intervals.

NOTE: Check the automatic transmission fluid level before towing.

Towing Tips — Electronic Speed Control (If Equipped)

- Don’t use in hilly terrain or with heavy loads.
- When using the speed control, if you experience speed drops greater than 10 mph (16 km/h), disengage until you can get back to cruising speed.
- Use speed control in flat terrain and with light loads to maximize fuel efficiency.

Towing Tips — Autostick (If Equipped)

- For vehicles equipped with Autostick. By using the Autostick modes, and selecting a specific gear range, frequent shifting can be avoided. The highest gear range should be selected that allows for adequate performance. For example, choose “4” if the desired speed can be maintained. Choose “3” or “2” if needed to maintain the desired speed.

- Extended driving at high RPM should be avoided to prevent excess heat generation. A reduction in vehicle speed may be required to avoid extended driving at high RPM. Return to a higher gear range or vehicle speed when road conditions and RPM level allows.

Towing Tips — Cooling System

To reduce potential for engine and transmission overheating, take the following actions:

- *City Driving*

When stopped for short periods of time, put transmission in neutral and increase engine idle speed.

- *Highway Driving*

Reduce speed.

- *Air Conditioning*

Turn off temporarily.

- refer to Cooling System Operating information in the Maintenance section of this manual for more information.

RECREATIONAL TOWING (BEHIND MOTORHOME, ETC.)

TOWING THIS VEHICLE BEHIND ANOTHER VEHICLE (Flat towing with all four wheels on the ground)

Recreational towing for this vehicle is not recommended.

NOTE: If the vehicle requires towing make sure all four wheels are off the ground.

WHAT TO DO IN EMERGENCIES

CONTENTS

■ Hazard Warning Flasher	274	□ Acceleration	284
■ If Your Engine Overheats	274	□ Traction	285
■ Jacking And Tire Changing	275	■ Freeing A Stuck Vehicle	285
□ Preparations For Jacking	276	■ Towing A Disabled Vehicle	286
□ Jack Location/Spare Tire Stowage	277	□ With Ignition Key	286
□ Jacking And Changing a Tire	278	□ Without The Ignition Key	287
□ Compact Spare Tire	281	□ Towing This Vehicle Behind Another Vehicle (Flat Towing With All Four Wheels On The Ground)	287
□ Wheel Cover Installation (If Required)	282	□ Towing This Vehicle Behind Another Vehicle With A Tow Dolly	287
■ Jump-Starting Procedures If Battery Is Low	282		
■ Driving On Slippery Surfaces	284		

HAZARD WARNING FLASHER

The hazard flasher switch is located in the center of the instrument panel between the center air outlets.

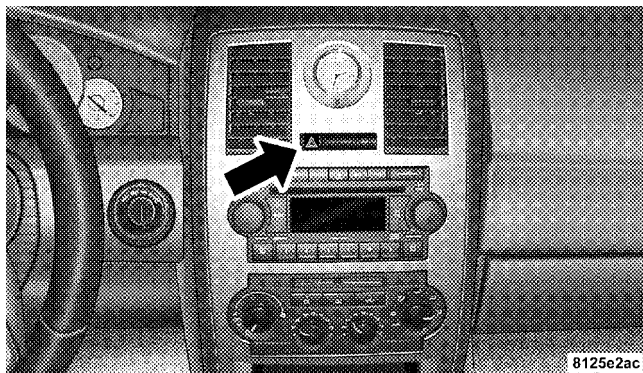

Hazard Flasher Switch

To engage the Hazard Warning Flashers, depress the switch on the instrument panel. When the Hazard Warning Switch is activated, all directional turn signals will flash on and off to warn oncoming traffic of an emergency. Push the switch a second time to turn off the flashers.

This is an emergency warning system and should not be used when the vehicle is in motion. Use it when your vehicle is disabled and is creating a safety hazard for other motorists.

When you must leave the vehicle to seek assistance, the Hazard Warning Flashers will continue to operate even though the ignition switch is OFF.

NOTE: With extended use, the Hazard Warning Flashers may wear down your battery.

IF YOUR ENGINE OVERHEATS

In any of the following situations, you can reduce the potential for overheating by taking the appropriate action.

- On the highways — Slow down.
- In city traffic — While stopped, put transmission in neutral, but do not increase engine idle speed.

NOTE: There are steps that you can take to slow down an impending overheating condition. If your air conditioner is on, turn it off. The air conditioning system adds heat to the engine cooling system and turning off the A/C removes this heat. You can also turn the Temperature control to maximum heat, the Mode control to floor, and the fan control to HI. This allows the heater core to act as a supplement to the radiator and aids in removing heat from the engine cooling system.

CAUTION!

Driving with a hot cooling system could damage your vehicle. If temperature gauge reads "H", pull over and stop the vehicle. Idle the vehicle with the air conditioner turned off until the pointer drops back into the normal range. If the pointer remains on the "H", turn the engine off immediately, and call for service.

WARNING!

A hot engine cooling system is dangerous. You or others could be badly burned by steam or boiling coolant. You may want to call a service center if your vehicle overheats. If you decide to look under the hood yourself, see Section 7, Maintenance, of this manual. Follow the warnings under the Cooling System Pressure Cap paragraph.

JACKING AND TIRE CHANGING

WARNING!

Do not attempt to change a tire on the side of the vehicle close to moving traffic. Pull far enough off the road to avoid the danger of being hit when operating the jack or changing the wheel.

WARNING!

Getting under a jacked-up vehicle is dangerous. The vehicle could slip off the jack and fall on you. You could be crushed. Never get any part of your body under a vehicle that is on a jack. Never start or run the engine while the vehicle is on a jack. If you need to get under a raised vehicle, take it to a service center where it can be raised on a lift.

Preparations For Jacking

- Park the vehicle on a firm level surface, avoid ice or slippery areas, set the parking brake and place the gear selector in PARK. Turn OFF the ignition.
- Turn on the Hazard Warning Flasher.

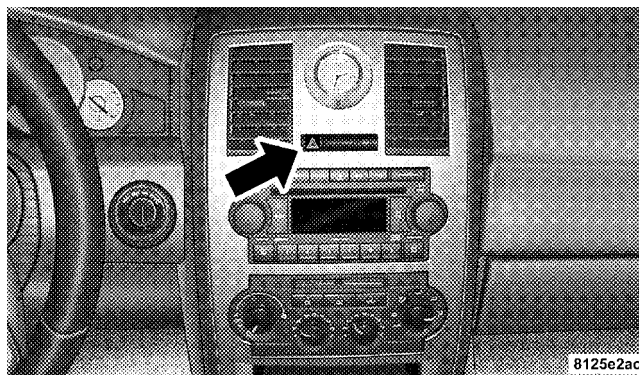
**Hazard Flasher Switch**

- Passengers should not remain in the vehicle when the vehicle is being jacked.
- Block both the front and rear of the wheel diagonally opposite the jacking position. For example, if changing the right front tire, block the left rear wheel.

Jack Location/Spare Tire Stowage

The jack and spare tire are both stowed under an access cover in the trunk. Follow these steps to access the jack and spare tire.

NOTE: The spare tire must be removed in order to access the jack.

- Open the trunk.
- Lift the access cover using the pull strap.

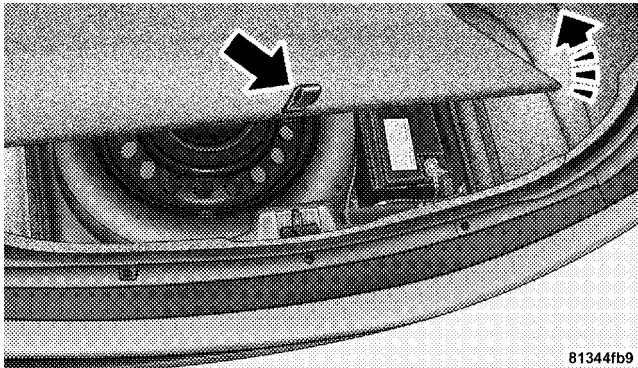

Opening The Access Panel

- Remove the fastener securing the spare tire.

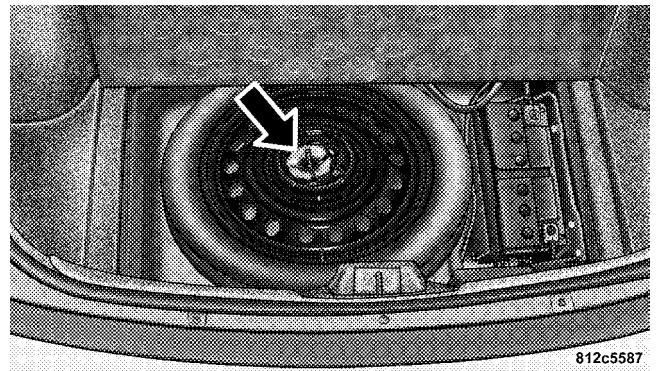

Spare Tire Fastener

- Remove the spare tire.
- Remove the fastener securing the jack.

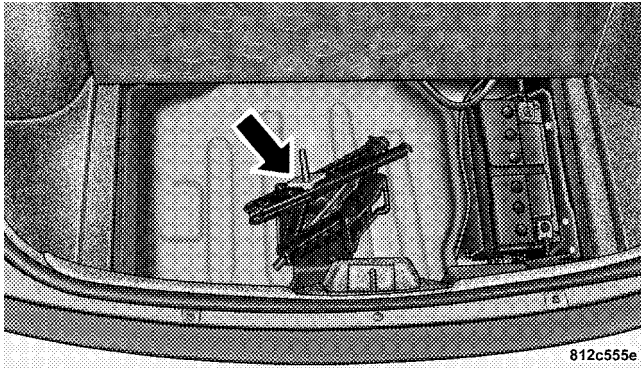

Jack Fastener

Jacking and Changing a Tire

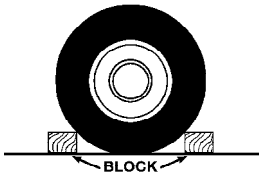

1. Block the wheel diagonally opposite the flat tire. Passengers should not remain in the vehicle when the vehicle is being jacked.

2. Remove the spare tire, jack and lug wrench.
3. Before raising the vehicle, use lug wrench to carefully pry off wheel cover (if equipped with steel wheels) or center cap (if equipped with aluminum wheels).

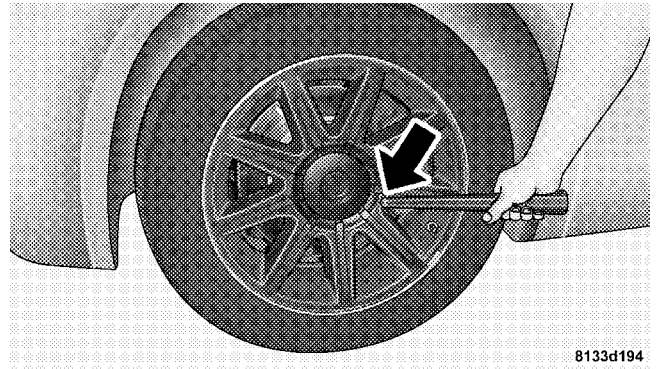

Center Cap Removal

WARNING!

To avoid possible personal injury, handle the wheel covers with care to avoid contact with the metal edges and retention teeth.

4. Before raising the vehicle loosen, but do not remove, the lug nuts of the flat tire using the lug wrench. Turn the wheel nuts counterclockwise one turn while the wheel is still on the ground.

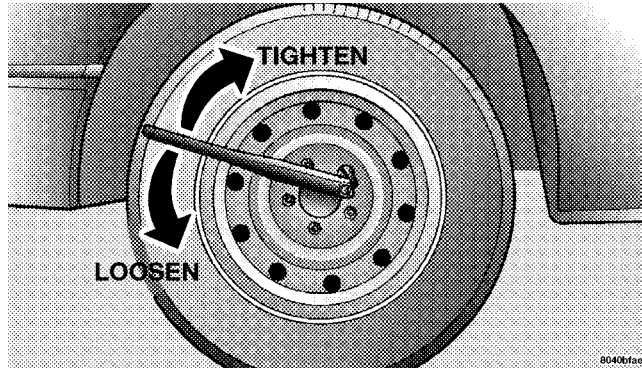

5. Turn the jack screw clockwise to firmly engage the jack saddle with the lift area of the sill flange, use the lift area closest to the flat tire.

6. Raise the vehicle just enough to remove the flat tire and install the spare tire.

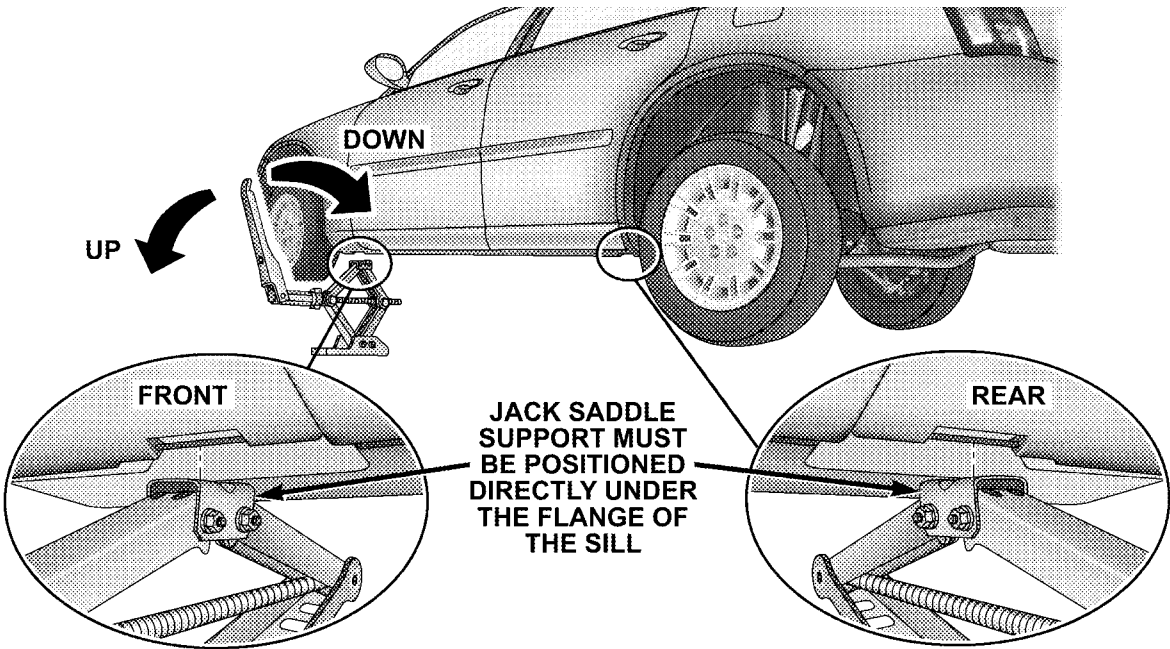

812dab8b

Jack Engagement Locations

7. Remove the lug nuts, wheel cover (if equipped) and tire. Remove the cover by hand, do not pry off.
8. Mount the spare tire. For vehicles equipped with wheel covers, see the wheel cover installation instructions. Do not attempt to install a wheel cover on a compact spare.
9. Tighten all the lug nuts on the mounting studs.
10. Lower the vehicle to the ground by turning the jack handle counterclockwise.
11. Fully tighten the lug nuts. Torque the wheel lug nuts to 100 ft/lb. (135 N. m).
12. Store the flat tire, jack and tools.

WARNING!

Raising the vehicle higher than necessary can make the vehicle less stable. It could slip off the jack and hurt someone near it. Raise the vehicle only enough to remove the tire.

WARNING!

A loose tire or jack thrown forward in a collision or hard stop could endanger the occupants of the vehicle. Always stow the jack parts and the spare tire in the places provided.

Compact Spare Tire

The compact spare tire is for temporary emergency use with radial tires. It is engineered to be used on your style vehicle only. Since this tire has limited tread life, the original tire should be repaired (or replaced) and reinstalled at the first opportunity.

- Keep tire inflated to 60 PSI (414 KPa) Cold Inflation Pressure.
- Avoid driving more than 50 miles (80 km) before replacing tire and wheel.
- This tire is designed as an emergency spare only-do not exceed 50 MPH (80 km/h) speed.

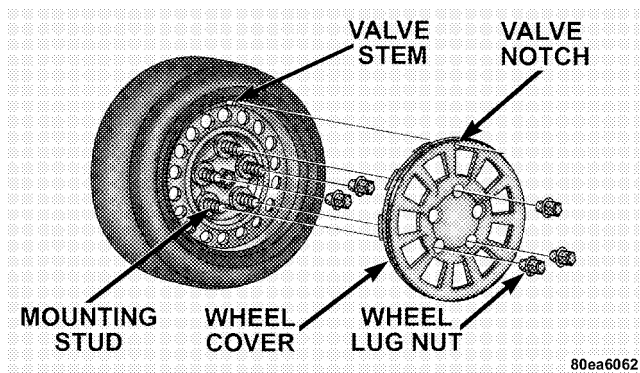
Wheel Cover Installation (If Required)

1. Tighten the two lug nuts on the mounting studs on each side of the stud which is in alignment with the valve stem.

2. Align the valve notch in the wheel cover with the valve stem on the wheel.

3. Install the cover by hand, snapping the cover over the two lug nuts. Do not use a hammer or excessive force to install the cover.

4. Return to Changing a Tire Section, Item #9 above.

JUMP-STARTING PROCEDURES IF BATTERY IS LOW**WARNING!**

Take care to avoid the radiator cooling fan whenever the hood is raised. It can start anytime the ignition switch is on. You can be hurt by the fan.

WARNING!

- Do not attempt to push or tow your vehicle to get it started. Vehicles equipped with an automatic transmission cannot be started this way. Unburned fuel could enter the catalytic converter and once the engine has started, ignite and damage the converter and vehicle. If the vehicle has a discharged battery, booster cables may be used to obtain a start from another vehicle. This type of start can be dangerous if done improperly, so follow this procedure carefully.
- Battery fluid is a corrosive acid solution; do not allow battery fluid to contact eyes, skin or clothing. Don't lean over battery when attaching clamps or allow the clamps to touch each other. If acid splashes in eyes or on skin, flush contaminated area immediately with large quantities of water.
- A battery generates hydrogen gas which is flammable and explosive. Keep flame or spark away from the vent holes. Do not use a booster battery or any other booster source with an output that exceeds 12 volts.

NOTE: The battery is stored under an access cover in the trunk. Remote battery terminals are located in the engine compartment for jump starting.

NOTE: The battery in this vehicle has a vent hose that should not be disconnected and should only be replaced with a battery of the same type (vented).

1. Wear eye protection and remove any metal jewelry such as watch bands or bracelets that might make an inadvertent electrical contact.
2. When boost is provided by a battery in another vehicle, park that vehicle within booster cable reach and without letting the vehicles touch. Set the parking brake, place the automatic transmission in PARK and turn the ignition switch to the OFF (or LOCK) position for both vehicles.
3. Turn off the heater, radio and all unnecessary electrical loads.

4. Connect one end of the jumper cable to the remote jump start positive battery post (A) in the engine compartment. Connect the other end of the same cable to the positive terminal of the booster battery. Refer to the following illustration for jump starting connections.

5. Connect the other cable, first to the negative terminal of the booster battery and then to the engine ground (B) of the vehicle with the discharged battery. Make sure you have a good contact on the engine ground. Refer to the following illustration for jump starting connections.

6. Start the engine in the vehicle which has the booster battery, let the engine idle a few minutes, then start the engine in the vehicle with the discharged battery.

7. When removing the jumper cables, reverse the above sequence exactly. Be careful of the moving belts and fan.

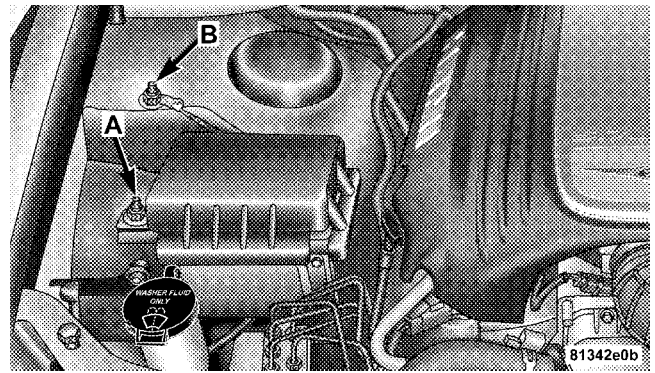

Jump Starting

DRIVING ON SLIPPERY SURFACES

Acceleration

Rapid acceleration on snow covered, wet, or other slippery surfaces may cause the rear wheels to pull erratically to the right or left. This phenomenon occurs when there is a difference in the surface traction under the rear (driving) wheels.

WARNING!

Rapid acceleration on slippery surfaces is dangerous. Unequal traction can cause sudden pulling of the rear wheels. You could lose control of the vehicle and possibly have an accident. Accelerate slowly and carefully whenever there is likely to be poor traction (ice, snow, wet mud, loose sand, etc.).

Traction

When driving on wet or slushy roads, it is possible for a wedge of water to build up between the tire and road surface. This is known as hydroplaning and may cause partial or complete loss of vehicle control and stopping ability. To reduce this possibility, the following precautions should be observed:

1. Slow down during rainstorms or when roads are slushy.
2. Slow down if road has standing water or puddles.
3. Replace tires when tread wear indicators first become visible.

4. Keep tires properly inflated.

5. Maintain sufficient distance between your vehicle and the vehicle in front to avoid a collision in a sudden stop.

FREEING A STUCK VEHICLE

If your vehicle becomes stuck in mud, sand or snow, it can often be moved by a rocking motion. Turn your steering wheel right and left to clear the area around the front wheels. Then shift back and forth between Reverse and Drive. Usually the least accelerator pedal pressure to maintain the rocking motion without spinning the wheels is most effective.

NOTE: Turn off the Electronic Stability Program (ESP) — if equipped, or Traction Control System (TCS) — if equipped before rocking the vehicle. Refer to “Electronic Stability Program,” or “Traction Control System” in Section 3 of this manual for details.

WARNING!

Fast spinning tires can be dangerous. Forces generated by excessive wheel speeds may cause tire damage or failure. A tire could explode and injure someone. Do not spin your vehicle's wheels faster than 35 mph (55 km/h) when you are stuck. And don't let anyone near a spinning wheel, no matter what the speed.

CAUTION!

Racing the engine or spinning the wheels too fast may lead to transmission overheating and failure. It can also damage the tires. Do not spin the wheels above 35 mph (55 km/h).

TOWING A DISABLED VEHICLE**With Ignition Key**

Your vehicle may be towed under the following conditions: The gear selector must be in NEUTRAL, the distance to be traveled must not exceed 30 miles (48 km), and the towing speed must not exceed 30 mph (48 km/h). Exceeding these towing limits may cause a transmission geartrain failure. If the transmission is not operative, or if the vehicle is to be towed more than 30 miles (48 km), the vehicle must be transported using a flat bed or the drive shaft disconnected at the rear axle drive flange.

CAUTION!

- Do not attempt to tow this vehicle from the front with sling type towing equipment. Damage to the front fascia will result.
- The only approved method of towing is with a flat bed truck.
- Do not tow the vehicle from the rear. Damage to the rear sheet metal, and fascia will occur.
- Do not push or tow this vehicle with another vehicle as damage to the bumper fascia and transmission may result.

If it is necessary to use the accessories while being towed (wipers, defrosters, etc.), the key must be in the ON position, not the ACCESSORY position. Make certain the transmission remains in NEUTRAL.

Without The Ignition Key

Special care must be taken when the vehicle is towed with the ignition in the LOCK position. The only approved method of towing with out the ignition key is with a flat bed truck. Proper towing equipment is necessary to prevent damage to the vehicle.

TOWING THIS VEHICLE BEHIND ANOTHER VEHICLE (Flat towing with all four wheels on the ground)

Flat towing of vehicles equipped with an automatic transmission, is only permitted within the limitations described in this section.

TOWING THIS VEHICLE BEHIND ANOTHER VEHICLE WITH A TOW DOLLY

The manufacture does not recommend that you tow this vehicle on a tow dolly. Vehicle damage may occur.

MAINTAINING YOUR VEHICLE

CONTENTS

■ 2.7L Engine	292	□ Drive Belts — Check Condition And Tensioner	303
■ 3.5L Engine	293	□ Spark Plugs	303
■ 5.7L Engine	294	□ Engine Air Cleaner Filter	304
■ Onboard Diagnostic System — OBD II	295	□ Fuel Filter	304
■ Emissions Inspection And Maintenance Programs	296	□ Catalytic Converter	304
■ Replacement Parts	297	□ Maintenance-Free Battery	306
■ Dealer Service	297	□ Air Conditioner Maintenance	307
■ Maintenance Procedures	298	□ A/C Air Filter — If Equipped	308
□ Engine Oil	298	□ Power Steering — Fluid Check	309
□ Engine Oil Filter	303	□ Front & Rear Suspension Ball Joints	309
		□ Steering Linkage	309

- Body Lubrication 309
- Windshield Wiper Blades 310
- Windshield Washers/Headlight Washers —
If Equipped 310
- Exhaust System 311
- Cooling System 312
- Hoses And Vacuum/Vapor Harnesses 316
- Brakes 317
- Brake Fluid Level Check 318
- Fuel System Hoses 319
- Automatic Transmission 319
- All Wheel Drive (AWD) — If Equipped 320
- Front And Rear Wheel Bearings 321
- Appearance Care And Protection From
Corrosion 321
- Cleaning The Center Console Cup Holders —
300 Models 324
- Cleaning The Center Console Cup Holders —
300C And 300 Touring Models 325
- Power Distribution Centers 325
 - Front Power Distribution Center 325
 - Rear Power Distribution Center 328
- Vehicle Storage 332
- Replacement Light Bulbs 332
- Bulb Replacement 334
 - Low Beam Headlight, High Beam Headlight,
Park/Turn Light, Inner Park Light, And Outer
Park Light - 300 Models 334
 - Low Beam Headlight, High Beam Headlight,
And Park/Turn Light - 300C 336
 - Backup Light, Side Marker Light, And Tail/Stop
Turn Light — 300 Models 338
 - Tail/Stop, Tail, Turn Signal Light, And Backup
Light — 300C Models 340
 - License Light 343

■ Fluids And Capacities	344	□ Engine	345
■ Fluids, Lubricants And Genuine Parts	345	□ Chassis	346

2.7L ENGINE

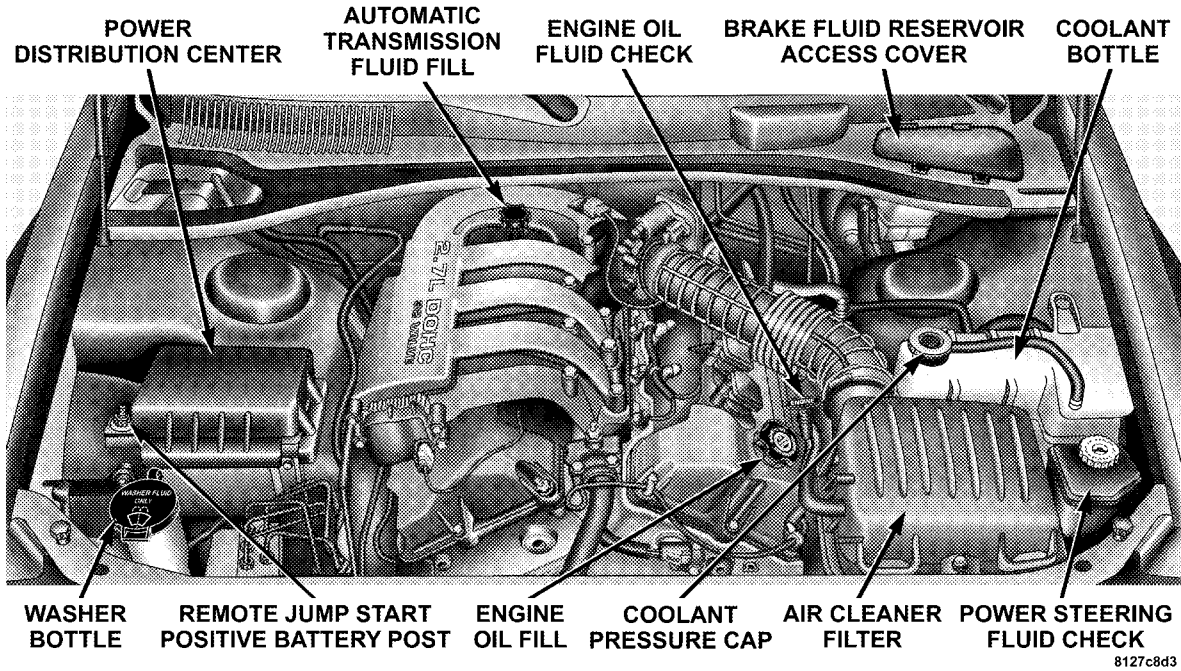

2.7L Engine Compartment

3.5L ENGINE

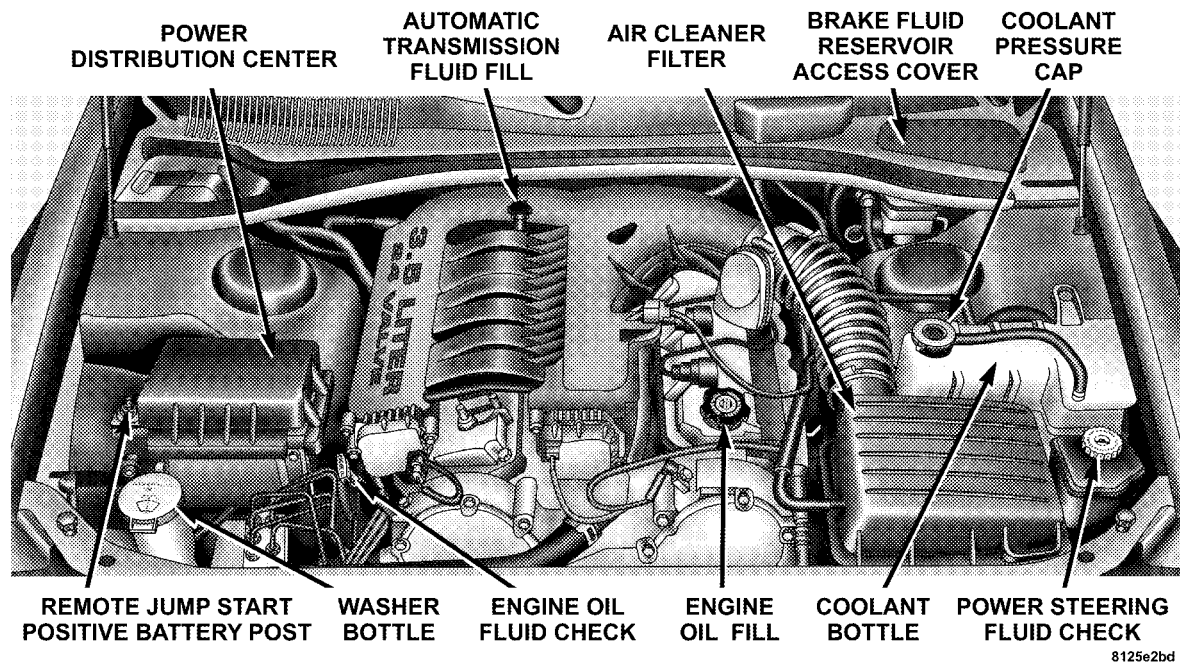

3.5L Engine Compartment

5.7L ENGINE

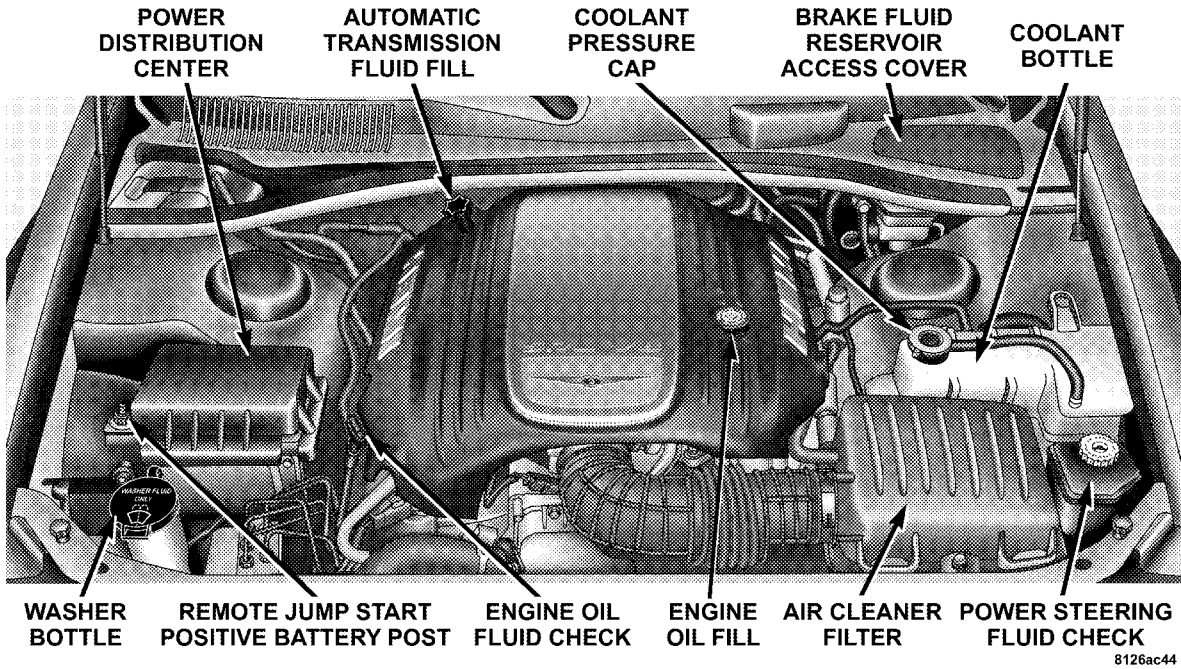

5.7L Engine Compartment

ONBOARD DIAGNOSTIC SYSTEM — OBD II

Your vehicle is equipped with a sophisticated onboard diagnostic system called OBD II. This system monitors the performance of the emissions, engine, and automatic transmission control systems. When these systems are operating properly, your vehicle will provide excellent performance and fuel economy, as well as engine emissions well within current government regulations.

If any of these systems require service, the OBD II system will turn on the “Malfunction Indicator Light.” It will also store diagnostic codes and other information to assist your service technician in making repairs. Although your vehicle will usually be drivable and not need towing, see your dealer for service as soon as possible.

CAUTION!

Prolonged driving with the “Malfunction Indicator Light” on could cause further damage to the emission control system. It could also affect fuel economy and driveability. The vehicle must be serviced before any emissions tests can be performed.

If the “Malfunction Indicator Light” is flashing while the engine is running, severe catalytic converter damage and power loss will soon occur. Immediate service is required.

EMISSIONS INSPECTION AND MAINTENANCE PROGRAMS

In some localities, it may be a legal requirement to pass an inspection of your vehicle's emissions control system. Failure to pass could prevent vehicle registration.



For states which have an I/M (Inspection and Maintenance) requirement, this check verifies the following: the MIL (Malfunction Indicator Light) is functioning and is not on when the engine is running, and that the OBD (On Board Diagnostic) system is ready for testing.

Normally, the OBD system will be ready. The OBD system may **not** be ready if your vehicle was recently serviced, if you recently had a dead battery, or a battery replacement. If the OBD system should be determined not ready for the I/M test, your vehicle may fail the test.

Your vehicle has a simple ignition key actuated test which you can use prior to going to the test station. To check if your vehicle's OBD system is ready, you must do the following:

1. Insert your ignition key into the ignition switch.

2. Turn the ignition to the ON position, but do not crank or start the engine.

3. If you crank or start the engine, you will have to start this test over.

4. As soon as you turn your key to the ON position, you will see your MIL symbol come on as part of a normal bulb check.

5. Approximately 15 seconds later, one of two things will happen:

a. The MIL will flash for about 10 seconds and then return to being fully illuminated until you turn off the ignition key or start the engine. This means that your vehicle's OBD system is **not ready** and you should **not** proceed to the I/M station.

b. The MIL will not flash at all and will remain fully illuminated until you turn off the ignition key or start the engine. This means that your vehicle's OBD system is **ready** and you can proceed to the I/M station.

If your OBD system is **not ready**, you should see your authorized dealer or repair facility. If your vehicle was recently serviced or had a battery failure or replacement, you may need to do nothing more than drive your vehicle as you normally would in order for your OBD system to update. A recheck with the above test routine may then indicate that the system is now ready.

Regardless of whether your vehicle's OBD system is ready or not ready, if the MIL symbol is illuminated during normal vehicle operation, you should have your vehicle serviced before going to the I/M station. The I/M station can fail your vehicle because the MIL symbol is on with the engine running.

REPLACEMENT PARTS

Use of genuine Mopar® parts for normal/scheduled maintenance and repairs is highly recommended to insure the designed performance. Damage or failures caused by the use of non-Mopar® parts for maintenance and repairs will not be covered by the manufacturer's warranty.

DEALER SERVICE

Your dealer has the qualified service personnel, special tools and equipment to perform all service operations in an expert manner. Service Manuals are available which include detailed service information for your vehicle. Refer to these manuals before attempting any procedure yourself.

NOTE: Intentional tampering with emissions control systems can result in civil penalties being assessed against you.

WARNING!

You can be badly injured working on or around a motor vehicle. Do only that service work for which you have the knowledge and the proper equipment. If you have any doubt about your ability to perform a service job, take your vehicle to a competent mechanic.

MAINTENANCE PROCEDURES

The pages that follow contain the required maintenance services determined by the engineers who designed your vehicle.

Besides the maintenance items for which there are fixed maintenance intervals, there are other items that should operate satisfactorily without periodic maintenance. However, if a malfunction of these items does occur, it could adversely affect the engine or vehicle performance. These items should be inspected if a malfunction is observed or suspected.

Engine Oil**Checking Oil Level — 2.7L, 3.5L Engines**

To assure proper engine lubrication, the engine oil must be maintained at the correct level. Check the oil level at regular intervals, such as every fuel stop.

The best time to check the engine oil level is about 5 minutes after a fully warmed engine is shut off or before starting the engine after it has sat overnight.

Checking the oil while the vehicle is on level ground will improve the accuracy of the oil level readings. Maintain the oil level between the MIN and MAX markings on the dipstick. Adding one quart (.9L) of oil when the reading is at the MIN mark will result in a MAX reading on these engines.

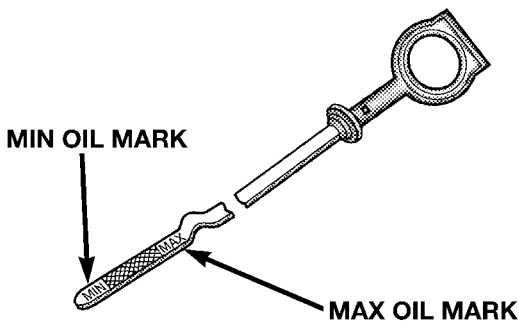

809744ab

Engine Oil Dipstick

CAUTION!

Overfilling or underfilling will cause oil aeration or loss of oil pressure. This could damage your engine.

Checking Oil Level — 5.7L Engines

To assure proper engine lubrication, the engine oil must be maintained at the correct level. Check the oil level at regular intervals, such as every fuel stop.

The best time to check the engine oil level is about 5 minutes after a fully warmed engine is shut off or before starting the engine after it has sat overnight.

Checking the oil while the vehicle is on level ground will improve the accuracy of the oil level readings. Maintain the oil level in the “SAFE” range. Adding one quart (.9L) of oil when the reading is at the bottom of the “SAFE” range will result in an oil level at the top of the “SAFE” range on these engines.

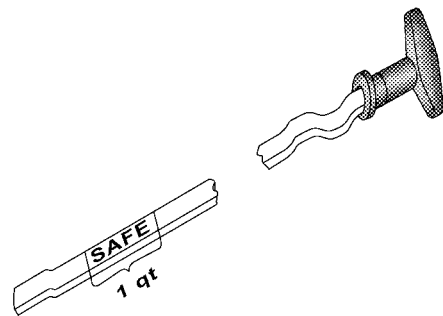

8131ee6a

Engine Oil Dipstick

CAUTION!

Overfilling or underfilling will cause oil aeration or loss of oil pressure. This could damage your engine.

CAUTION!

Operating the engine with the oil levels below the safe zone, or operating with oil levels that exceed the top of the safe zone may cause engine damage.

Change Engine Oil

Road conditions and your kind of driving affects the interval at which your oil should be changed. Check the following list to see if any apply to you.

- Day or night temperatures are below 32°F (0°C).
- Stop and Go driving.
- Extensive engine idling.
- Driving in dusty conditions.

- Short trips of less than 10 miles (16 km).
- More than 50% of your driving is at sustained high speeds during hot weather, above 90°F (32°C).
- Trailer towing.
- Taxi, Police or delivery service (commercial service).
- Off-Road or desert operation.

NOTE: If ANY of these apply to you then change your engine oil every 3,000 miles (5 000 km) or 3 months, whichever comes first and follow schedule "B" of the "Maintenance Schedules" section of this manual.

If none of these apply to you, then change your engine oil at every interval shown on schedule "A" of the "Maintenance Schedules" section of this manual.

NOTE: Under no circumstances should oil change intervals exceed 6,000 miles (10 000 km) or 6 months whichever comes first.

Engine Oil Selection

For best performance and maximum protection under all types of operating conditions, the manufacture only

recommends engine oils that are API certified and meet the requirements of DaimlerChrysler Material Standard MS-6395. Use Mopar® or an equivalent oil meeting the specification MS-6395.

American Petroleum Institute (API) Engine Oil Identification Symbol



This symbol means that the oil has been certified by the American Petroleum Institute (API). The manufacturer only recommends API Certified engine oils that meet the requirements of DaimlerChrysler Material Standard MS-6395. Use Mopar® or an equivalent oil meeting the specifi-

cation MS-6395.

Engine Oil Viscosity (SAE Grade) — 2.7L and 5.7L Engines

SAE 5W-20 engine oil is recommended for all operating temperatures. This engine oil improves low temperature starting and vehicle fuel economy.

The engine oil filler cap also shows the recommended engine oil viscosity for your engine. For information on engine oil filler cap location, refer to the Engine Compartment illustration in this section.

NOTE: Vehicles equipped with 5.7L engines must use SAE 5W-20 oil. Failure to do so may result in improper operation of the Multiple Displacement System (MDS). Refer to Multi Displacement System under Starting and Operating for details.

In areas where these grades are not generally available, higher SAE grades may be used. Lubricants which have both an SAE grade number and the API Certification Symbol or ACEA category shown on the container should be used.

Lubricants which do not have both, the engine oil certification mark and the correct SAE viscosity grade number should not be used.

Engine Oil Viscosity Chart — 3.5L Engines

SAE 10W-30 engine oil is preferred for use in 3.5L Engines within the operating temperatures shown in the

engine oil viscosity chart. SAE 5W-30 Engine Oil is allowed for use in the 3.5L Engine during cold weather only to improve cold weather starting.

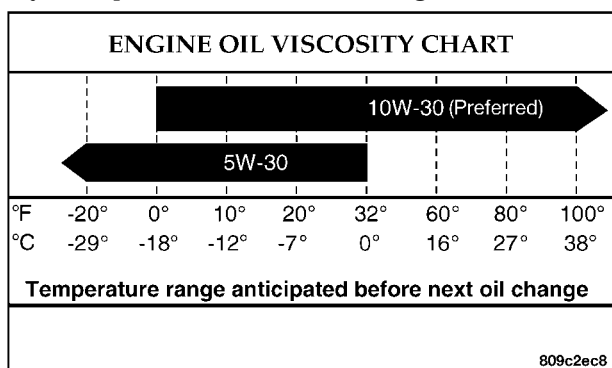

10W-30 OIL VISCOSITY CHART

The engine oil filler cap also shows the recommended engine oil viscosity for your engine. For information on engine oil filler cap location, refer to the Engine Compartment illustration in this section.

In areas where these grades are not generally available, higher SAE grades may be used. Lubricants which have

both an SAE grade number and the API Certification Symbol or ACEA category shown on the container should be used.

Lubricants which do not have both, the engine oil certification mark and the correct SAE viscosity grade number should not be used.

Synthetic Engine Oils

You may use synthetic engine oils provided that the recommended oil quality requirements are met and the recommended maintenance intervals for oil and filter changes are followed.

Materials Added to Engine Oil

The manufacture strongly recommends against the addition of any additives (other than leak detection dyes) to the engine oil. Engine oil is an engineered product and it's performance may be impaired by supplemental additives.

Disposing of Used Engine Oil And Oil Filters

Care should be taken in disposing of used engine oil and oil filters from your vehicle. Used oil and oil filters, indiscriminately discarded, can present a problem to the

environment. Contact your dealer, service station, or governmental agency for advice on how and where used oil and oil filters can be safely discarded in your area.

Engine Oil Filter

The engine oil filter should be replaced at every engine oil change.

Engine Oil Filter Selection

This manufacturer's engines have a full-flow type oil filter. Use a filter of this type for replacement. The quality of replacement filters varies considerably. Only high quality filters should be used to assure most efficient service. Mopar® Engine Oil Filters are a high quality oil filter and are recommended.

Drive Belts — Check Condition and Tensioner

Belt tension is controlled by means of an automatic tensioner. No belt tension adjustments are required. However, belt and belt tensioner condition should be inspected at the specified intervals, and replaced if required. See your authorized dealer for service.

At the mileage indicated in the maintenance schedule, all belts and tensioner should be checked for condition. Improper belt tension can cause belt slippage and failure.

Belts should be inspected for evidence of cuts, cracks, glazing, or frayed cords and replaced if there is indication of damage which could result in belt failure. Low generator belt tension can cause battery failure.

Also check belt routing to make sure there is no interference between the belts and other engine components.

Spark Plugs

Spark plugs must fire properly to assure engine performance and emission control. New plugs should be installed at the specified mileage. The entire set should be replaced if there is any malfunction due to a faulty spark plug. Malfunctioning spark plugs can damage the catalytic converter. For proper type of replacement spark plugs, refer to the "Vehicle Emission Control Information" label in the engine compartment.

Engine Air Cleaner Filter

Under normal driving conditions, replace the air filter at the intervals shown on Schedule "A." If, however, you drive the vehicle frequently under dusty or severe conditions, the filter element should be inspected periodically and replaced if necessary at the intervals shown on Schedule "B."

WARNING!

The air cleaner can provide a measure of protection in the case of engine backfire. Do not remove the air cleaner unless such removal is necessary for repair or maintenance. Make sure that no one is near the engine compartment before starting the vehicle with the air cleaner removed. Failure to do so can result in serious personal injury.

Fuel Filter

A plugged fuel filter can cause stalling, limit the speed at which a vehicle can be driven or cause hard starting. Should an excessive amount of dirt accumulate in the fuel tank, filter replacement may be necessary. See your local dealer for service.

Catalytic Converter

The catalytic converter requires the use of unleaded fuel only. Leaded gasoline will destroy the effectiveness of the catalyst as an emission control device.

Under normal operating conditions, the catalytic converter will not require maintenance. However, it is important to keep the engine properly tuned to assure proper catalyst operation and prevent possible catalyst damage.

CAUTION!

Damage to the catalytic converter can result if your vehicle is not kept in proper operating condition. In the event of engine malfunction, particularly involving engine misfire or other apparent loss of performance, have your vehicle serviced promptly. Continued operation of your vehicle with a severe malfunction could cause the converter to overheat, resulting in possible damage to the converter and the vehicle.

NOTE: Intentional tampering with emissions control systems can result in civil penalties being assessed against you.

WARNING!

A hot exhaust system can start a fire if you park over materials that can burn. Such materials might be grass or leaves coming into contact with your exhaust system. Do not park or operate your vehicle in areas where your exhaust system can contact anything that can burn.

In unusual situations involving grossly malfunctioning engine operation, a scorching odor may indicate severe and abnormal catalyst overheating. If this occurs, the vehicle should be stopped, the engine shut off and the vehicle allowed to cool. Thereafter, service, including a tune-up to manufacturer's specifications, should be obtained immediately.

To minimize the possibility of catalyst damage:

- Do not shut off the engine or interrupt the ignition when the transmission is in gear and the vehicle is in motion.
- Do not try to start engine by pushing or towing the vehicle.
- Do not idle the engine with any spark plug wires disconnected or removed, such as when diagnostic testing, or for prolonged periods during very rough idling or malfunctioning operating conditions.

Maintenance-Free Battery

The top of the MAINTENANCE-FREE battery is permanently sealed. You will never have to add water, nor is periodic maintenance required.

NOTE: The battery is stored under an access cover in the trunk. Remote battery terminals are located in the engine compartment for jump starting.

NOTE: The battery in this vehicle has a vent hose that should not be disconnected and should only be replaced with a battery of the same type (vented).

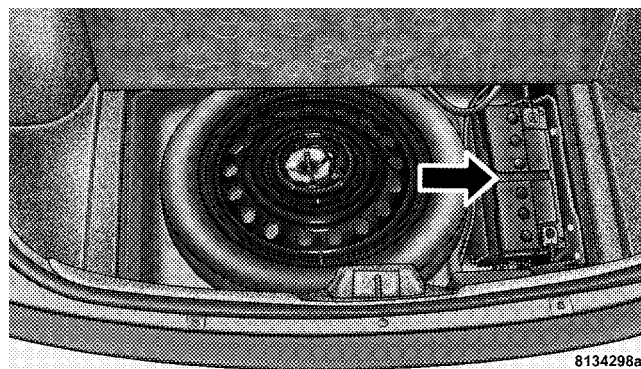

Battery Location

WARNING!

- Battery fluid is a corrosive acid solution and can burn or even blind you. Don't allow battery fluid to contact your eyes, skin or clothing. Don't lean over a battery when attaching clamps. If acid splashes in eyes or on skin, flush the area immediately with large amounts of water.
- Battery gas is flammable and explosive. Keep flame or sparks away from the battery. Don't use a booster battery or any other booster source with an output greater than 12 volts. Don't allow cable clamps to touch each other.
- Battery posts, terminals and related accessories contain lead and lead compounds. Wash hands after handling.

CAUTION!

- It is essential when replacing the cables on the battery that the positive cable is attached to the positive post and the negative cable is attached to the negative post. Battery posts are marked positive (+) and negative (-) and identified on the battery case. Cable clamps should be tight on the terminal posts and free of corrosion.
- If a "fast charger" is used while battery is in vehicle, disconnect both vehicle battery cables before connecting the charger to battery. Do not use a "fast charger" to provide starting voltage.

Air Conditioner Maintenance

For best possible performance, your air conditioner should be checked and serviced by an Authorized Dealer at the start of each warm season. This service should include cleaning of the condenser fins and a performance test. Drive belt tension should also be checked at this time.

WARNING!

- Use only refrigerants and compressor lubricants approved by the manufacturer for your air conditioning system. Some unapproved refrigerants are flammable and can explode, injuring you. Other unapproved refrigerants or lubricants can cause the system to fail, requiring costly repairs. Refer to Section 3 of the Warranty Information book for further warranty information.
- The air conditioning system contains refrigerant under high pressure. To avoid risk of personal injury or damage to the system, adding refrigerant or any repair requiring lines to be disconnected should be done by an experienced repairman.

Refrigerant Recovery and Recycling

R-134a Air Conditioning Refrigerant is a hydrofluorocarbon (HFC) that is endorsed by the Environmental Protection Agency and is an ozone-saving product. However, the manufacturer recommends that air conditioning service be performed by dealers or other service facilities using recovery and recycling equipment.

NOTE: Use only manufacturer approved A/C System Sealers, Stop Leak Products, Seal Conditioners, Compressor Oil, or Refrigerants.

A/C Air Filter — If Equipped

The filter is located in the fresh air inlet under the hood, behind a removable panel in the cowl on the passenger side of the vehicle, next to the windshield wipers. When installing a new filter, ensure its proper orientation. To replace the filter remove the access door in the cowl screen by pressing the retaining clips. Slide the lid on the filter adapter forward and down and remove used filter. Install new filter with arrows pointing in the direction of airflow, which is toward the rear of the vehicle (text and arrows on the filter indicate this).

Refer to the “Maintenance Schedules” section of this manual for the recommended air conditioning filter replacement intervals.

Power Steering — Fluid Check

Checking the power steering fluid level at a defined service interval is not required. The fluid should only be checked if a leak is suspected, abnormal noises are apparent, and/or the system is not functioning as anticipated. Coordinate inspection efforts through a certified DaimlerChrysler Dealership.

WARNING!

Fluid level should be checked on a level surface and with the engine off to prevent injury from moving parts and to insure accurate fluid level reading. Do not overfill. Use only manufacturers recommended power steering fluid.

If necessary, add fluid to restore to the proper indicated level. With a clean cloth, wipe any spilled fluid from all surfaces. Refer to Fluids, Lubricants, and Genuine Parts for correct fluid type.

Front & Rear Suspension Ball Joints

The suspension ball joints should be inspected for external leakage or damage when other maintenance is performed.

Steering Linkage

The tie rod end ball joints should be inspected for external leakage or damage when other maintenance is performed.

Body Lubrication

Locks and all body pivot points, including such items as seat tracks, doors, trunk and hood hinges, should be lubricated periodically to assure quiet, easy operation and to protect against rust and wear. Prior to the application of any lubricant, the parts concerned should be wiped clean to remove dust and grit; after lubricating excess oil and grease should be removed. Particular attention should also be given to hood latching components to insure proper function. When performing other

underhood services, the hood latch, release mechanism and safety catch should be cleaned and lubricated.

The external lock cylinders should be lubricated twice a year, preferably in the fall and spring. Apply a small amount of a high quality lubricant such as Mopar® Lock Cylinder Lubricant or equivalent directly into the lock cylinder.

Windshield Wiper Blades

The rubber edges of the wiper blades and the windshield should be cleaned periodically with a sponge or soft cloth and a mild nonabrasive cleaner. This will remove accumulations of salt or road film.

Operation of the wipers on dry glass for long periods may cause deterioration of the wiper blades. Always use washer fluid when using the wipers to remove salt or dirt from a dry windshield.

Avoid using the wiper blades to remove frost or ice from the windshield. Keep the blade rubber out of contact with petroleum products such as engine oil, gasoline, etc.

Windshield Washers/Headlight Washers — If Equipped

The windshield washer and the headlight washer (if equipped) share the same fluid reservoir. The reservoir is located in the front of the engine compartment on the passenger side of the vehicle. Be sure to check the fluid level in the reservoir at regular intervals. Fill the reservoir with windshield washer solvent (not radiator antifreeze) and operate the system for a few seconds to flush out the residual water.

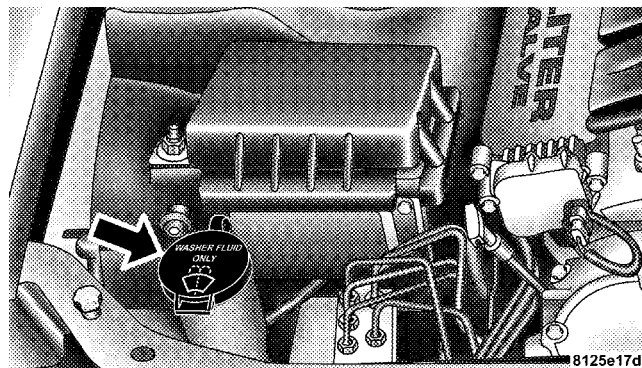

Washer Fluid Reservoir

The fluid reservoir will hold 1 gallon (3.8L) of washer fluid when the message “Low Washer Fluid” appears in the Electronic Vehicle Information Center (EVIC) — if equipped.

Exhaust System

The best protection against carbon monoxide entry into the vehicle body is a properly maintained engine exhaust system.

Whenever a change is noticed in the sound of the exhaust system, when exhaust fumes can be detected inside the vehicle, or when the underside or rear of the vehicle is damaged, have a competent mechanic inspect the complete exhaust system and adjacent body areas for broken, damaged, deteriorated, or mispositioned parts. Open seams or loose connections could permit exhaust fumes to seep into the passenger compartment. In addition, inspect the exhaust system each time the vehicle is raised for lubrication or oil change. Replace as required.

WARNING!

Exhaust gases can injure or kill. They contain carbon monoxide (CO) which is colorless and odorless. Breathing it can make you unconscious and can eventually poison you. To avoid breathing CO, refer to Exhaust Gas in the Safety Tips section of this manual.

Cooling System

WARNING!

- When working near the radiator cooling fan, disconnect the fan motor lead or turn the ignition switch to the OFF position. The fan is temperature controlled and can start at any time the ignition switch is in the ON position.
- You or others can be badly burned by hot coolant or steam from your radiator. If you see or hear steam coming from under the hood, don't open the hood until the radiator has had time to cool. Never try to open a cooling system pressure cap when the radiator is hot.

Coolant Checks

Check engine coolant (antifreeze) protection every 12 months (before the onset of freezing weather, where applicable). If coolant is dirty or rusty in appearance, the system should be drained, flushed and refilled with fresh coolant. Check the front of the A/C condenser for any accumulation of bugs, leaves, etc. If dirty, clean by gently spraying water from a garden hose vertically down the face of the condenser.

Check the coolant recovery bottle tubing for brittle rubber, cracking, tears, cuts and tightness of the connection at the bottle and radiator. Inspect the entire system for leaks.

With the engine at normal operating temperature (but not running), check the cooling system pressure cap for proper vacuum sealing by draining a small amount of coolant from the radiator drain cock. If the cap is sealing properly, the engine coolant (antifreeze) will begin to drain from the coolant recovery bottle. **DO NOT REMOVE THE COOLANT PRESSURE CAP WHEN THE COOLING SYSTEM IS HOT.**

Cooling System — Drain, Flush and Refill

At the intervals shown on the Maintenance Schedules, the system should be drained, flushed and refilled.

If the solution is dirty or contains a considerable amount of sediment, clean and flush with a reliable cooling system cleaner. Follow with a thorough rinsing to remove all deposits and chemicals. Properly dispose of old antifreeze solution.

Selection Of Coolant

Use only the manufacturer's recommended coolant, refer to Fluids, Lubricants and Genuine Parts for correct coolant type.

CAUTION!

Mixing of coolants other than specified HOAT engine coolants, may result in engine damage and may decrease corrosion protection. If a non-HOAT coolant is introduced into the cooling system in an emergency, it should be replaced with the specified coolant as soon as possible.

Do not use plain water alone or alcohol base engine coolant (antifreeze) products. Do not use additional rust inhibitors or antirust products, as they may not be compatible with the radiator engine coolant and may plug the radiator.

This vehicle has not been designed for use with Propylene Glycol based coolants. Use of Propylene Glycol based coolants is not recommended.

Adding Coolant

Your vehicle has been built with an improved engine coolant that allows extended maintenance intervals. This coolant can be used up to 5 Years or 100,000 miles (160 000 km) before replacement. To prevent reducing this extended maintenance period, it is important that you use the same coolant throughout the life of your vehicle. Please review these recommendations for using Hybrid Organic Additive Technology (HOAT) coolant.

When adding coolant, a minimum solution of 50% recommended Mopar® Antifreeze/Coolant 5 Year/100,000 Mile Formula HOAT (Hybrid Organic Additive Technology), or equivalent, in water should be used. Use higher concentrations (not to exceed 70%) if temperatures below -34°F (-37°C) are anticipated.

Use only high purity water such as distilled or deionized water when mixing the water/engine coolant solution. The use of lower quality water will reduce the amount of corrosion protection in the engine cooling system.

Please note that it is the owner's responsibility to maintain the proper level of protection against freezing according to the temperatures occurring in the area where the vehicle is operated.

NOTE: Mixing coolant types will decrease the life of the engine coolant and will require more frequent coolant changes.

Cooling System Pressure Cap

The cap must be fully tightened to prevent loss of coolant, and to insure that coolant will return to the radiator from the coolant recovery bottle.

The cap should be inspected and cleaned if there is any accumulation of foreign material on the sealing surfaces.

WARNING!

- The warning words “DO NOT OPEN HOT” on the cooling system pressure cap are a safety precaution. Never add coolant when the engine is overheated. Do not loosen or remove the cap to cool an overheated engine. Heat causes pressure to build up in the cooling system. To prevent scalding or injury, do not remove the pressure cap while the system is hot or under pressure.
- Do not use a pressure cap other than the one specified for your vehicle. Personal injury or engine damage may result.

Disposal of Used Engine Coolant

Used ethylene glycol based engine coolant is a regulated substance requiring proper disposal. Check with your local authorities to determine the disposal rules for your community. To prevent ingestion by animals or children do not store ethylene glycol based engine coolant in open containers or allow it to remain in puddles on the

ground. If ingested by a child, contact a physician immediately. Clean up any ground spills immediately.

Coolant Level

The coolant bottle provides a quick visual method for determining that the coolant level is adequate. With the engine off and cold, the level of the coolant in the bottle should be between the ranges indicated on the bottle.

The radiator normally remains completely full, so there is no need to remove the radiator cap unless checking for coolant freeze point or replacing coolant. Advise your service attendant of this. As long as the engine operating temperature is satisfactory, the coolant bottle need only be checked once a month.

When additional coolant is needed to maintain the proper level, it should be added to the coolant bottle. Do not overfill.

Points To Remember

NOTE: When the vehicle is stopped after a few miles (kilometers) of operation, you may observe vapor coming from the front of the engine compartment. This is normally a result of moisture from rain, snow, or high humidity accumulating on the radiator and being vaporized when the thermostat opens, allowing hot coolant to enter the radiator.

If an examination of your engine compartment shows no evidence of radiator or hose leaks, the vehicle may be safely driven. The vapor will soon dissipate.

- Do not overfill the coolant recovery bottle.
- Check coolant freeze point in the radiator and in the coolant recovery bottle. If antifreeze needs to be added, contents of coolant recovery bottle must also be protected against freezing.
- If frequent coolant additions are required, or if the level in the coolant recovery bottle does not drop when the engine cools, the cooling system should be pressure tested for leaks.

- Maintain coolant concentration at 50% HOAT engine coolant (minimum) and distilled water for proper corrosion protection of your engine which contains aluminum components.
- Make sure that the radiator and coolant recovery bottle overflow hoses are not kinked or obstructed.
- Keep the front of the radiator clean. If your vehicle is equipped with air conditioning, keep the front of the condenser clean, also.
- Do not change the thermostat for summer or winter operation. If replacement is ever necessary, install **ONLY** the correct type thermostat. Other designs may result in unsatisfactory coolant performance, poor gas mileage, and increased emissions.

Hoses And Vacuum/Vapor Harnesses

Inspect surfaces of hoses and nylon tubing for evidence of heat and mechanical damage. Hard or soft spots, brittle rubber, cracking, tears, cuts, abrasions, and excessive swelling indicate deterioration of the rubber.

Pay particular attention to those hoses nearest to high heat sources such as the exhaust manifold. Inspect hose routing to be sure hoses do not come in contact with any heat source or moving component which may cause heat damage or mechanical wear.

Insure nylon tubing in these areas has not melted or collapsed.

Inspect all hose connections such as clamps and couplings to make sure they are secure and no leaks are present.

Components should be replaced immediately if there is any evidence of wear or damage that could cause failure.

Brakes

In order to assure brake system performance, all brake system components should be inspected periodically. Suggested service intervals can be found in the Maintenance Schedules section of this manual.

WARNING!

Riding the brakes can lead to brake failure and possibly an accident. Driving with your foot resting or riding on the brake pedal can result in abnormally high brake temperatures, excessive lining wear, and possible brake damage. You wouldn't have your full braking capacity in an emergency.

Brake And Power Steering Hoses

When the vehicle is serviced for scheduled maintenance, inspect surface of hoses and nylon tubing for evidence of heat and mechanical damage. Hard and brittle rubber, cracking, tears, cuts, abrasion, and excessive swelling indicate deterioration of the rubber. Particular attention should be made to examining those hose surfaces nearest to high heat sources, such as the exhaust manifold.

Insure nylon tubing in these areas has not melted or collapsed.

Inspect all hose connections such as clamps and couplings to make sure they are secure and no leaks are present.

NOTE: Often, fluid such as oil, power steering fluid, and brake fluid are used during assembly plant operations to facilitate the assembly of hoses to couplings. Therefore, oil wetness at the hose-coupling area is not necessarily an indication of leakage. Actual dripping of hot fluid when systems are under pressure (during vehicle operation), should be noted before a hose is replaced based on leakage.

NOTE: Inspection of brake hoses should be performed whenever the brake system is serviced and at every engine oil change. Inspect hydraulic brake hoses for surface cracking, scuffing, or worn spots. If there is any evidence of cracking, scuffing, or worn spots, the hose should be replaced immediately! Eventual deterioration of the hose can take place resulting in a possibility of a burst failure.

WARNING!

Worn brake hoses can burst and cause brake failure. You could have an accident. If you see any signs of cracking, scuffing, or worn spots, have the brake hoses replaced immediately.

Brake Fluid Level Check

The fluid level in the master cylinder should be checked when performing underhood services, or immediately if the brake system warning light indicates system failure.

Clean the top of the master cylinder area before removing the cap. Add fluid to bring the level up to the top of the "FULL" mark on the side of the master cylinder reservoir.

Overfilling of fluid is not recommended because it may cause leaking in the system.

Add enough fluid to bring the level up to the requirements described on the brake fluid reservoir. With disc brakes, fluid level can be expected to fall as the brake pads wear. However, low fluid level may be caused by a leak and a checkup may be needed.

Use only manufacturers recommended brake fluid, refer to Fluids, Lubricants and Genuine Parts for correct fluid type.

WARNING!

- Overfilling the brake fluid reservoir can result in spilling brake fluid on hot engine parts and the brake fluid catching fire.
- Use of a brake fluid that has a lower initial boiling point than the recommended MOPAR® DOT 3 product or a brake fluid that is unidentified as to FMVSS specification may result in sudden brake failure during hard prolonged braking. You could have an accident.

Use only brake fluid that has been in a tightly closed container to avoid contamination from foreign matter or moisture.

CAUTION!

Do not allow petroleum base fluid to contaminate the brake fluid, all brake seal components could be damaged causing partial or complete brake failure.

Fuel System Hoses

Electronic Fuel Injection high pressure fuel systems are designed with hoses and quick connect fittings which have unique material characteristics to provide adequate sealing and resist attack by deteriorated gasoline.

You are urged to use only the manufacture specified hoses with quick connect fittings, or their equivalent in material and specification, in any fuel system servicing. It is mandatory to replace any damaged hoses or quick connect fittings that have been removed during service. Care should be taken in installing quick connect fittings to insure they are properly installed and fully connected. See your authorized dealer for service.

Automatic Transmission

Fluid Level Check

Regular automatic transmission fluid level checks are not required. For this reason the dipstick is omitted.

If you notice fluid loss or gear shift malfunction, have your authorized dealer check the transmission fluid level.

CAUTION!

Using a transmission fluid other than the manufacturer's recommended fluid may cause deterioration in transmission shift quality and/or torque converter shudder. Using a transmission fluid other than that recommended by the manufacturer will result in more frequent fluid and filter changes. Refer to the Fluids, Lubricants and Genuine Parts section for correct fluid type.

CAUTION!

The fluid level is preset at the factory and does not require adjustment under normal operating conditions. If a transmission fluid leak occurs, visit your authorized dealer immediately. Severe damage to the transmission may occur. Your authorized dealer has the proper tools to accurately adjust the fluid level.

Fluid and Filter Changes

Automatic transmission fluid and filter should be changed as follows:

Normal Usage — No change necessary

Severe Usage (fluid and filter) — Refer to Maintenance Schedule "B"

Severe Usage is defined as:

- Police, taxi, limousine, commercial type operation, or trailer towing where the vehicle is driven regularly for more than 45 minutes of continuous operation.

If the transmission is disassembled for any reason, the fluid and filter should be changed.

All Wheel Drive (AWD) — If Equipped

The all wheel drive system consists of a Transfer Case, and Front Differential. The exterior surface of these components should be inspected for evidence of fluid leaks. Confirmed leaks should be repaired as soon as possible.

The transfer case fill plug is located on the rear housing near the output shaft. The level can be verified by the service plug in the middle of the rear housing, even with the bottom of the hole. The front differential fill plug is on the outer cover near the halfshaft attachment. The level can be verified by removing the plug and inspecting the level. The level should be even with or slightly below the bottom of the hole.

Fluid Changes

The fluid should be changed as follows:

Normal Usage	No Service Required
Severe Usage	
Front Differential	No Service Required
Transfer Case	Refer to Maintenance Schedule "B"

Severe Usage is defined as:

1. More than 50% of vehicle operation in stop and go traffic where vehicle is driven regularly for more than 45 minutes of continuous operation, such as in heavy city or in construction zone traffic.
2. Police, taxi, limousine, commercial type operation, or trailer towing where the vehicle driven regularly for more than 45 minutes of continuous operation.

Front And Rear Wheel Bearings

Front and rear wheel bearings are permanently sealed. No regular maintenance is required for these components.

Appearance Care and Protection from Corrosion

Protection of Body and Paint from Corrosion

Vehicle body care requirements vary according to geographic locations and usage. Chemicals that make roads passable in snow and ice, and those that are sprayed on trees and road surfaces during other seasons, are highly corrosive to the metal in your vehicle. Outside parking, which exposes your vehicle to airborne contaminants, road surfaces on which the vehicle is operated, extreme

hot or cold weather and other extreme conditions will have an adverse effect on paint, metal trim, and underbody protection.

The following maintenance recommendations will enable you to obtain maximum benefit from the corrosion resistance built into your vehicle.

What Causes Corrosion?

Corrosion is the result of deterioration or removal of paint and protective coatings from your vehicle.

The most common causes are:

- Road salt, dirt and moisture accumulation.
- Stone and gravel impact.
- Insects, tree sap and tar.
- Salt in the air near seacoast localities.
- Atmospheric fallout/industrial pollutants.

Washing

- Wash your vehicle regularly. Always wash your vehicle in the shade using Mopar® Car Wash or a mild car wash soap, and rinse the panels completely with clear water.
- If insects, tar or other similar deposits have accumulated on your vehicle, use Mopar® Super Kleen Bug and Tar Remover to remove.
- Use Mopar® Cleaner Wax to remove road film, stains and to protect your paint finish. Take care never to scratch the paint.
- Avoid using abrasive compounds and power buffing that may diminish the gloss or thin out the paint finish.

CAUTION!

Do not use abrasive or strong cleaning materials such as steel wool or scouring powder, which will scratch metal and painted surfaces.

Special Care

- If you drive on salted or dusty roads or if you drive near the ocean, hose off the undercarriage at least once a month.
- It is important that the drain holes in the lower edges of the doors, rocker panels and trunk be kept clear and open.
- If you detect any stone chips or scratches in the paint, touch them up immediately. The cost of such repairs is considered the responsibility of the owner.
- If your vehicle is damaged due to an accident or similar cause which destroys the paint and protective coating have your vehicle repaired as soon as possible. The cost of such repairs is considered the responsibility of the owner.
- All wheels and wheel trim, especially aluminum and chrome plated wheels should be cleaned regularly with a mild soap and water to prevent corrosion. To remove heavy soil, use Mopar® Wheel Cleaner or select a nonabrasive, non-acidic cleaner. Do not use scouring pads, steel wool, a bristle brush or metal

polishes. Only Mopar® cleaners are recommended. Do not use oven cleaner. Avoid automatic car washes that use acidic solutions or harsh brushes that may damage the wheels' protective finish.

- If you carry special cargo such as chemicals, fertilizers, de-icer salt, etc., be sure that such materials are well packaged and sealed.
- If a lot of driving is done on gravel roads, consider mud or stone shields behind each wheel.
- Use Mopar® touch up paint or equivalent on scratches as soon as possible. Your dealer has touch up paint to match the color of your vehicle.

Interior Care

Use Mopar® Fabric Cleaner or equivalent to clean fabric upholstery and Mopar® Carpet Cleaner for carpeting.

Interior Trim should be cleaned starting with a damp cloth, or Mopar® Satin Select. Do not use harsh cleaners or Armorall. Use Mopar® Total Clean to clean vinyl upholstery.

Mopar® Total Clean is specifically recommended for leather upholstery.

Your leather upholstery can be best preserved by regular cleaning with a damp soft cloth. Small particles of dirt can act as an abrasive and damage the leather upholstery and should be removed promptly with a damp cloth. Stubborn soils can be removed easily with a soft cloth and Mopar® Total Clean or equivalent. Care should be taken to avoid soaking your leather upholstery with any liquid. Please do not use polishes, oils, cleaning fluids, solvents, detergents, or ammonia based cleaners to clean your leather upholstery. Application of a leather conditioner is not required to maintain the original condition.

WARNING!

Do not use volatile solvents for cleaning purposes. Many are potentially flammable, and if used in closed areas they may cause respiratory harm.

Glass Surfaces

All glass surfaces should be cleaned on a regular basis with Mopar® Glass Cleaner or any commercial household-type glass cleaner. Never use an abrasive type cleaner. Use caution when cleaning the inside rear window equipped with electric defrosters or the right rear quarter window equipped with the radio antenna. Do not use scrapers or other sharp instruments which may scratch the elements.

When cleaning the rear view mirror, spray cleaner on the towel or rag that you are using. Do not spray cleaner directly on the mirror.

Cleaning Plastic Instrument Cluster Lenses

The lenses in front of the instruments in this vehicle are molded in clear plastic. When cleaning the lenses, care must be taken to avoid scratching the plastic.

1. Clean with a wet soft rag or microfiber towel. A mild soap solution may be used, but do not use high alcohol content or abrasive cleaners. If soap is used, wipe clean with a clean damp rag.
2. Dry with a soft tissue.

Seat Belt Maintenance

Do not bleach, dye or clean the belts with chemical solvents or abrasive cleaners. This will weaken the fabric. Sun damage can also weaken the fabric.

If the belts need cleaning use Mopar® Total Clean, a mild soap solution, or lukewarm water. Do not remove the belts from the vehicle to wash them.

Replace the belts if they appear frayed or worn or if the buckles do not work properly.

Cleaning The Center Console Cup Holders — 300 Models

Perform the following steps to clean the center console cup holders:

- Grab the center of the rubber portion of the cup holder firmly and lift upward to remove.
- Soak the rubber cup holder liner in a mixture of medium hot tap water and one teaspoon of mild liquid dish soap. Let soak for approximately one hour.

- After one hour pull the liner from the water and dip it back into the water about six times. This will loosen any remaining debris.
- Rinse the liner thoroughly under warm running water. Shake the excess water from the liner and dry the outer surfaces with a clean soft cloth.
- Carefully tuck the front, followed by the rear, then side edges of the cup holder into the center console.

Cleaning The Center Console Cup Holders — 300C and 300 Touring Models

Clean with a damp cloth or towel using a mild detergent with the cup holder in the center console.

NOTE: The cup holder cannot be removed.

Power Distribution Centers

Front Power Distribution Center

A power distribution center is located in the engine compartment. This center contains fuses and relays.

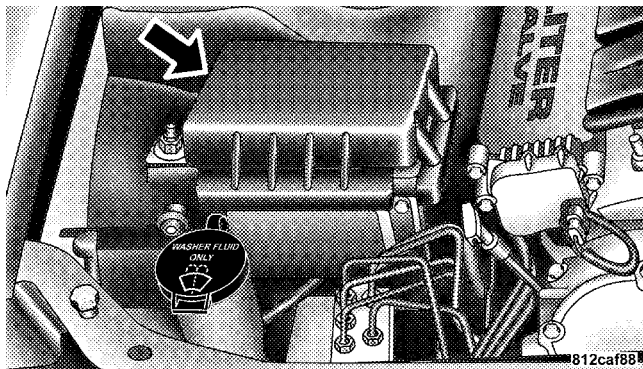

Front Power Distribution Center

CAUTION!

- When installing the Power Distribution Center cover, it is important to ensure the cover is properly positioned and fully latched. Failure to do so may allow water to get into the Power Distribution Center, and possibly result in a electrical system failure.
- When replacing a blown fuse, it is important to use only a fuse having the correct amperage rating. The use of a fuse with a rating other than indicated may result in a dangerous electrical system overload. If a properly rated fuse continues to blow, it indicates a problem in the circuit that must be corrected.

Front Power Distribution Center Fuses

Cavity	Fuse	Circuits
1	20 Amp Yellow	Left High Intensity Discharge Headlight - if equipped
2	20 Amp Yellow	Right High Intensity Discharge Headlight - if equipped
3	15 Amp Blue	Adjustable Pedals - if equipped
4	20 Amp Yellow	AC Clutch/Horn
5	20 Amp Yellow	Headlight Washer - If Equipped
6	15 Amp Blue	Front Control Module (FCM)
7	20 Amp Yellow	Fog Lights
8	15 Amp Blue	Lights - License, Park, Side Marker, Stop, Turn
9	15 Amp Blue	Front Control Module (FCM)
10	5 Amp Orange	Powertrain Control Module (PCM)/Starter

Cavity	Fuse	Circuits
11	20 Amp Yellow	Auto Shutdown/Powertrain Control Module (PCM)
12	—	—
13	—	—
14	25 Amp Clear	Powertrain Control Module (PCM)
15	25 Amp Clear	Injectors, Ignition Coils
16	—	—
17	30 Amp Pink	Antilock Brakes System (ABS) Valves/Powertrain Control Module (PCM)
18	30 Amp Pink	Windshield Wiper/Washer
19	50 Amp Red	Radiator Fan
20	20 Amp Blue	Starter
21	50 Amp Red	Antilock Brakes System (ABS) Pump Motor

Cavity	Fuse	Circuits
22	40 Amp Green	AC Clutch/Radiator Fan High — Low
23	50 Amp Red	High Intensity Lighting - if equipped
24	60 Amp Yellow	Radiator Fan - AWD
25	30 Amp Pink	Front Control Module (FCM)
26	20 Amp Blue	Transmission - RLE
27	30 Amp Pink	Front Control Module (FCM)

Rear Power Distribution Center

There is also a power distribution center located in the trunk under the spare tire access panel. This center contains fuses and relays.

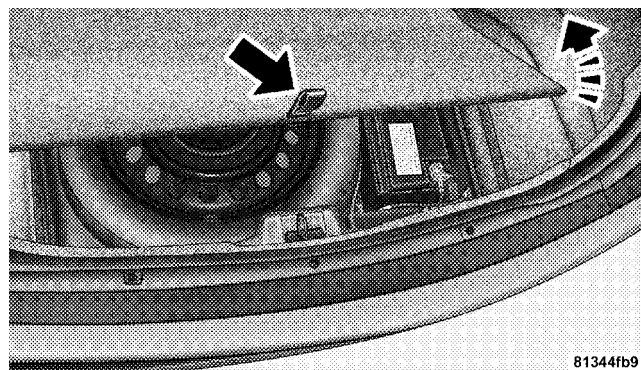

81344fb9

Opening The Access Panel

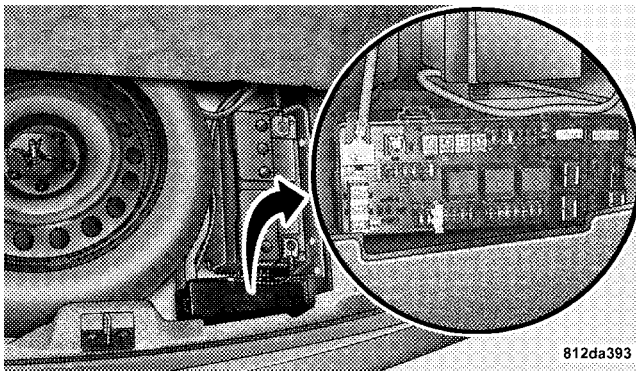

Rear Power Distribution Center

CAUTION!

- When installing the Power Distribution Center cover, it is important to ensure the cover is properly positioned and fully latched. Failure to do so may allow water to get into the Power Distribution Center, and possibly result in a electrical system failure.
- When replacing a blown fuse, it is important to use only a fuse having the correct amperage rating. The use of a fuse with a rating other than indicated may result in a dangerous electrical system overload. If a properly rated fuse continues to blow, it indicates a problem in the circuit that must be corrected.

Rear Power Distribution Center Fuses

Cavity	Fuse	Circuits
1	60 Amp Yellow	Ignition Off Draw (IOD)
2	40 Amp Green	Battery
3	—	—
4	40 Amp Green	Battery
5	30 Amp Pink	Heated Seats - if equipped
6	20 Amp Yellow	Fuel Pump
7	—	—
8	15 Amp Blue	Ignition Switch/Occupant Classification Module (OCM)
9	20 Amp Yellow	Console Power Outlet
10	—	—

Cavity	Fuse	Circuits
11	25 Amp C/BRKR	Cluster - without power memory seat/Driver Seat Switch - with power memory seat/Memory Module - if equipped
12	25 Amp C/BRKR	Passenger Seat Switch
13	25 Amp C/BRKR	Door Modules - except base/ Driver Door Lock Switch - base/Driver Express Power Window Switch - if equipped/ Passenger Door Lock Switch - base
14	10 Amp Red	AC Heater Control/Cluster/ Sentry Key Remote Keyless Entry
15	20 Amp Yellow	Trailer Tow Brake Module - if equipped
16	—	—
17	20 Amp Yellow	Cluster

Cavity	Fuse	Circuits
18	20 Amp Yellow	Selectable Power Outlet
19	10 Amp Red	Stop Lights
20	—	—
21	—	—
22	—	—
23	—	—
24	—	—
25	—	—
26	—	—
27	10 Amp Red	Airbag/Occupant Classification Module
28	10 Amp Red	Curtain Airbag - if equipped
29	5 Amp Orange	Antilock Brakes Module/Cluster/Front Control Module (FCM)/Powertrain Control Module (PCM)/Sentry Key Remote Keyless Entry/Stop Lights

Cavity	Fuse	Circuits
30	10 Amp Red	Door Modules/Power Mirrors - if equipped/Steering Control Module
31	—	—
32	—	—
33	—	—
34	—	—
35	5 Amp Orange	Amplifier - if equipped/ Antenna/Ignition Delay/ Overhead Console - if equipped/Passenger Door Lock & Express Power Window Switch - if equipped/Power Mirrors - if equipped/Rain Sensor - if equipped/Rear Defrost
36	20 Amp Yellow	Hands Free Phone - if equipped/Media System Monitor DVD - if equipped/Radio/Satellite Receiver - if equipped

Cavity	Fuse	Circuits
37	15 Amp Blue	Transmission - NAG1
38	5 Amp Orange	Analog Clock/Cargo Light/ Overhead Console - if equipped
39	10 Amp Red	Heated Mirrors - if equipped
40	5 Amp Orange	Heated Seats - if equipped/ Inside Rearview Mirror/ Manual Temperature Control (early build) - if equipped
41	10 Amp Red	AC Heater Control (except early build MTC)/Park Assist - if equipped/Tire Pressure Monitoring - if equipped
42	30 Amp Pink	Front Blower Motor
43	30 Amp Pink	Amplifier - if equipped/ Antenna/Rear Defrost
44	20 Amp Blue	Amplifier - if equipped/Front Control Module (FCM)/ Sunroof - if equipped

VEHICLE STORAGE

If you are leaving your vehicle dormant for more than 21 days you may want to take steps to protect your battery. You may:

- Disconnect the negative cable from the battery.
- Anytime you store your vehicle, or keep it out of service (i.e. vacation) for two weeks or more, run the air conditioning system at idle for about five minutes in the fresh air and high blower setting. This will insure adequate system lubrication to minimize the possibility of compressor damage when the system is started again.

REPLACEMENT LIGHT BULBS

LIGHT BULBS — Interior	Bulb Number
Rear Courtesy/Reading Lights	W5W
Rear Compartment (Trunk) Light	579
Overhead Console Reading Lights	578
Visor Vanity Lights	A6220
Glove Box Light	194
Door Courtesy	562
Shift Indicator Light	JKLE14140

NOTE: For lighted switches, see your dealer for replacement instructions.

All of the interior bulbs are glass wedge base or glass cartridge types. Aluminum base bulbs are not approved and should not be used for replacement.

**LIGHT BULBS — Exterior
(300, 300 Touring Models)**

	Bulb Number
Low Beam Headlight	9006
High Beam Headlight	9005
Front Park/Turn Light	3757AK
Front Inner Park Light	194NA
Front Outer Park Light	194NA
Front Fog Light— If Equipped	9145/H10 (Serviced at Dealer)
Front Sidemarker	W5W (Serviced at Dealer)
Tail/Stop/Turn Light	3057
Rear Sidemarker	168
Backup Light	3057
Center High Mount Stop Light (CHMSL)	LED
License	168

LIGHT BULBS —

Exterior (300C Models)	Bulb Number
Low Beam Headlight (Standard Halogen)	9006XS
Low Beam Headlight – High Intensity Discharge (HID)	D1S (Serviced at Dealer)
High Beam Headlight	9005
Front Park/Turn Light	3157AK
Front Fog Light	9145/H10 (Serviced at Dealer)
Front Sidemarker	W5W (Serviced at Dealer)
Tail/Stop Light	3057
Tail Light	3057
Turn Signal Light	3057
Backup Light	3057
Center High Mount Stop Light (CHMSL)	LED
License	W5W

BULB REPLACEMENT**Low Beam Headlight, High Beam Headlight, Park/Turn Light, Inner Park Light, and Outer Park Light – 300 Models**

- Open the hood.
- Twist the appropriate bulb socket assembly counter-clockwise and pull out. Pull the bulb out of the socket assembly.

NOTE: Removal of the air cleaner filter housing may be necessary prior to replacing bulbs on the headlight assembly on the driver side of the vehicle.

- Replace the bulb and push into socket assembly. Reinstall the socket assembly, and turn clockwise.

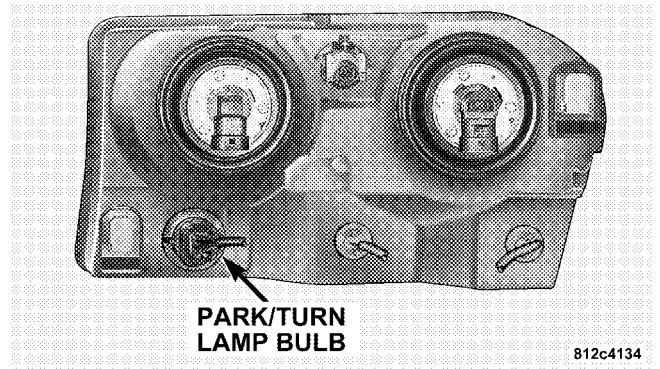
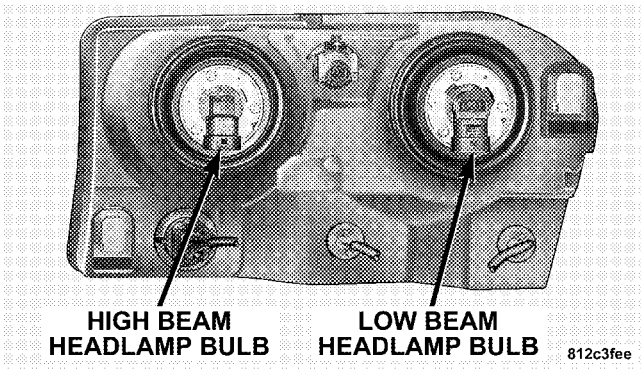

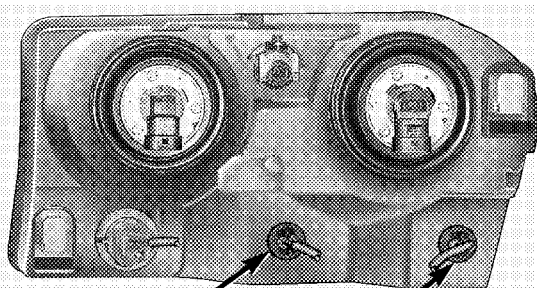
INNER PARK
LAMP BULBOUTER PARK
LAMP BULB

812c419e

CAUTION!

Do not touch the new bulb with your fingers. Oil contamination will severely shorten bulb life. If the bulb comes in contact with an oily surface, clean the bulb with rubbing alcohol.

Low Beam Headlight, High Beam Headlight, and Park/Turn Light – 300C**High Intensity Discharge Headlights (HID) — If Equipped**

The headlights are a type of high voltage discharge tube. High voltage can remain in the circuit even with the headlight switch off and the key removed. **Because of this, you should not attempt to service a headlight bulb yourself. If a headlight bulb fails, take your vehicle to an authorized dealer for service.**

WARNING!

A transient high tension occurs at the bulb sockets of High Intensity Discharge (HID) headlights when the headlight switch is turned ON. It may cause serious electrical shock or electrocution if not serviced properly. See your authorized dealer for service.

NOTE: On vehicles equipped with High Intensity Discharge Headlights (HID), when the headlights are turned on there is a blue hue to the lights. This diminishes and becomes more white after approximately 10 seconds, as the system charges.

- Open the hood.
- Twist the appropriate bulb socket assembly counter-clockwise and pull out. Pull the bulb out of the socket assembly.

NOTE: Removal of the air cleaner filter housing may be necessary prior to replacing bulbs on the headlight assembly on the driver side of the vehicle.

- Replace the bulb and push into socket assembly. Reinstall the socket assembly, and turn clockwise.

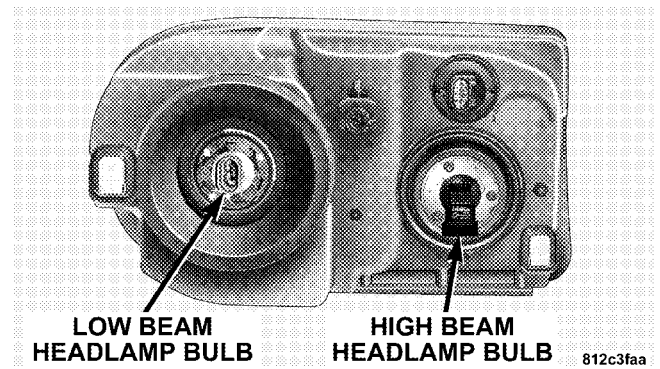

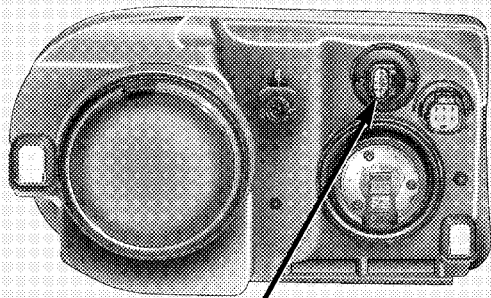

**PARK/TURN
LAMP BULB**

812c4103

CAUTION!

Do not touch the new bulb with your fingers. Oil contamination will severely shorten bulb life. If the bulb comes in contact with an oily surface, clean the bulb with rubbing alcohol.

**Backup Light, Side Marker Light, and Tail/Stop
Turn Light — 300 Models**

1. Open the Trunk.
2. Remove two fasteners from the back of the tail light assembly.

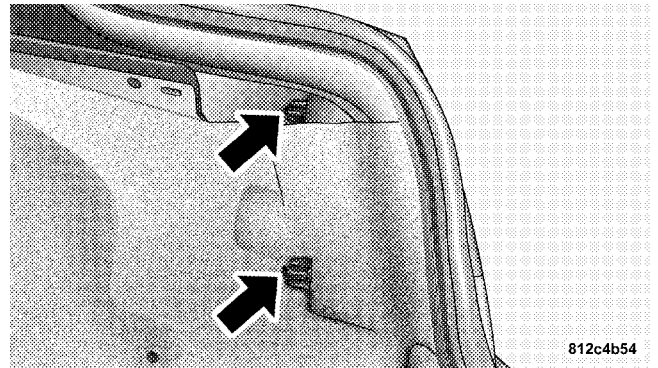

812c4b54

3. Pull back the trunk liner.
4. Remove the remaining fastener from the back of the tail light assembly.
5. Push the electrical connector locking tab to the side.
6. Disconnect the electrical connector.

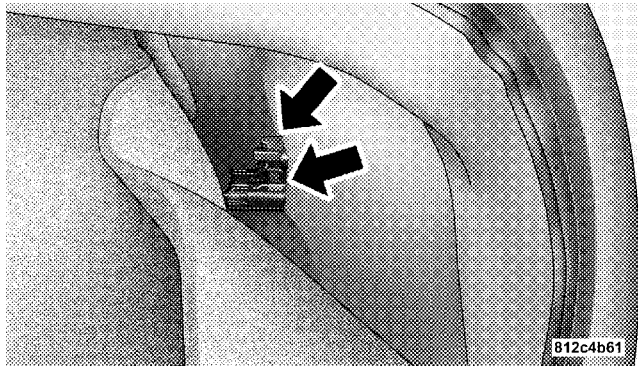

7. Pull tail light assembly clear from vehicle to access bulbs. Turn bulb sockets counter-clockwise to remove.

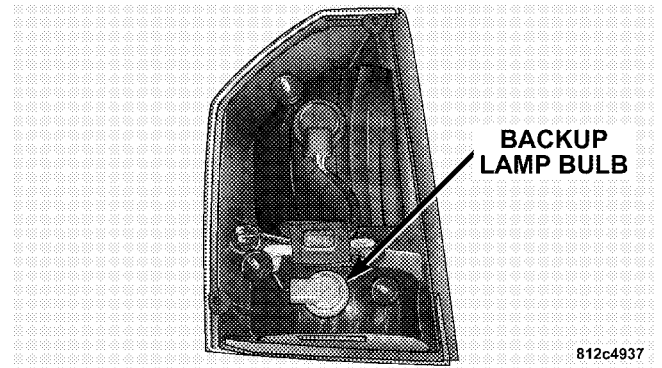

**SIDE MARKER
LAMP BULB**

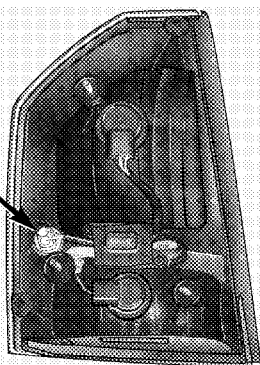

812c4933

**TAIL/STOP/TURN
LAMP BULB**

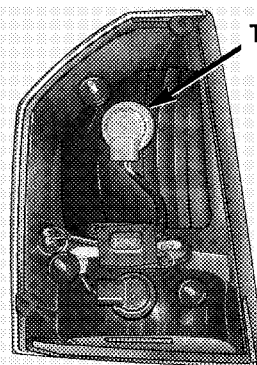

812c492f

8. Pull the appropriate bulb to remove it from the socket.
9. Replace the bulb, reinstall the socket, and reattach the tail light assembly.
10. Close the trunk.

Tail/Stop, Tail, Turn Signal Light, and Backup Light — 300C Models

1. Open the Trunk.
2. Remove two fasteners from the back of the tail light assembly.

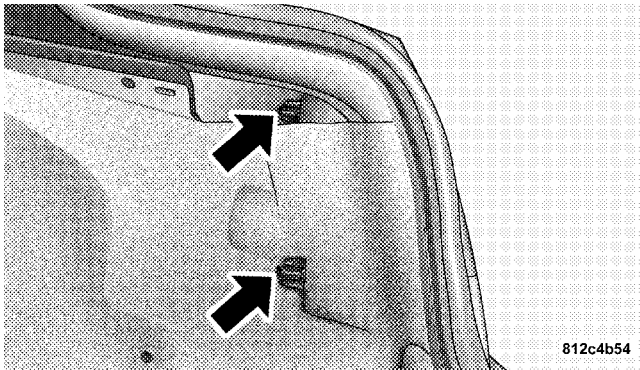

3. Pull back the trunk liner.
4. Remove the remaining fastener from the back of the tail light assembly.
5. Push the electrical connector locking tab to the side.
6. Disconnect the electrical connector.

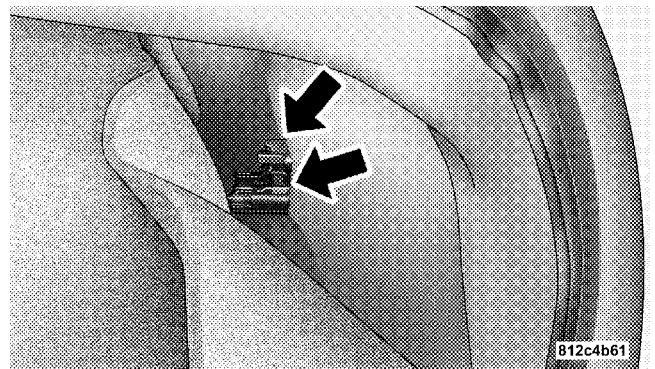

7. Pull tail light assembly clear from vehicle to access bulbs. Turn bulb sockets counter-clockwise to remove.

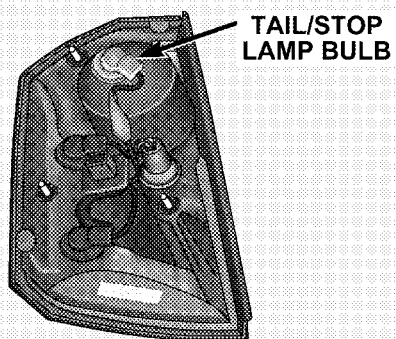

812c48da

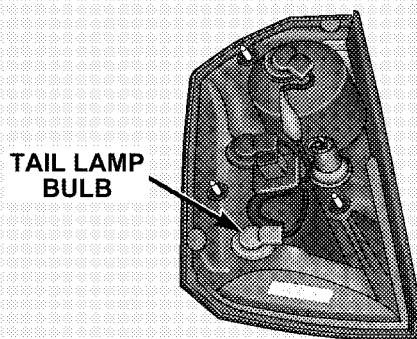

812c4925

TURN SIGNAL
LAMP BULB

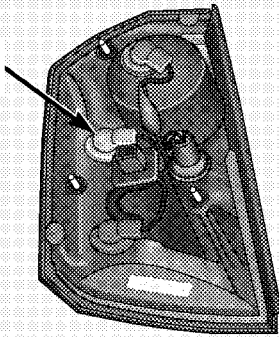

812c48e1

BACKUP
LAMP BULB

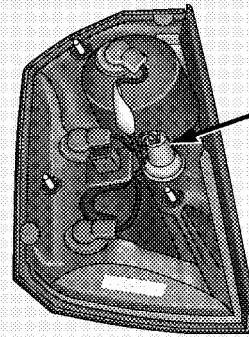

812c491d

8. Pull the appropriate bulb to remove it from the socket.
9. Replace the bulb, reinstall the socket, and reattach the tail light assembly.
10. Close the trunk.

License Light

1. Remove the screws securing the light to the rear fascia.
2. Remove the bulb and socket assembly and pull the bulb from the socket.

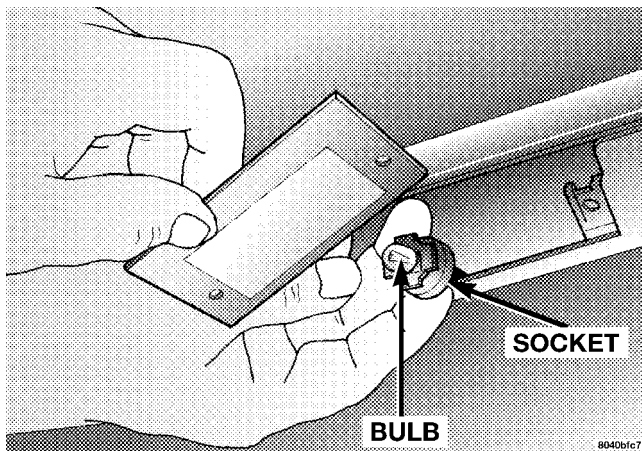

3. Replace the bulb and reinstall the bulb and socket assembly.
4. Reattach the light to the rear fascia.

FLUIDS AND CAPACITIES

	U.S.	Metric
Fuel (approximate)		
2.7 Liter Engines (87 Octane)	18 gal- lons	68 liters
3.5 Liter Engines (87 to 89 Oc- tane)	18 gal- lons	68 liters
5.7 Liter Engines (87 to 89 Oc- tane)	19 gal- lons	72 liters
Engine Oil-With Filter		
2.7 Liter Engines (SAE 5W-20, API Certified)	6.0 qts.	5.7 liters
3.5 Liter Engines (SAE 10W-30, API Certified)	6.0 qts.	5.7 liters
5.7 Liter Engines (SAE 5W-20, API Certified)	7.0 qts.	6.6 liters

Cooling System *

2.7 Liter Engines (Mopar® Antifreeze/Coolant 5 Year/100,000 Mile Formula) or equivalent.	9.7 qts	9.2 liters
3.5 Liter Engines (Mopar® Antifreeze/Coolant 5 Year/100,000 Mile Formula) or equivalent.	10.6 qts	10.0 liters
5.7 Liter Engines (Mopar® Antifreeze/Coolant 5 Year/100,000 Mile Formula) or equivalent.	14.6 qts	13.8 liters

* Includes heater and coolant recovery bottle filled to MAX level.

FLUIDS, LUBRICANTS AND GENUINE PARTS**Engine**

Component	Fluids, Lubricants and Genuine Parts
Engine Coolant	Mopar® Antifreeze/Coolant 5 Year/100,000 Mile Formula HOAT (Hybrid Organic Additive Technology)
Engine Oil (2.7 Liter)	Use API Certified engine oil. SAE 5W-20 is recommended. Refer to the engine oil fill cap for the correct SAE grade meeting DaimlerChrysler Material Standard MS-6395.
Engine Oil (3.5 Liter)	Use API Certified engine oil. SAE 10W-30 is recommended. Refer to the engine oil viscosity chart for the correct SAE grade meeting DaimlerChrysler Material Standard MS-6395.
Engine Oil (5.7 Liter)	Use API Certified engine oil. SAE 5W-20 is recommended. Refer to the engine oil fill cap for the correct SAE grade meeting DaimlerChrysler Material Standard MS-6395.
Spark Plugs	Refer to the Vehicle Emission Control Information label in the engine compartment.
Oil Filter (2.7 Liter)	Mopar® 05281090 or equivalent.
Oil Filter (3.5 Liter)	Mopar® 05281090 or equivalent.
Oil Filter (5.7 Liter)	Mopar® 05281090 or equivalent.
Fuel Selection (2.7 Liter)	87 Octane
Fuel Selection (3.5 Liter)	87 to 89 Octane
Fuel Selection (5.7 Liter)	87 to 89 Octane

Chassis

Component	Fluids, Lubricants and Genuine Parts
Automatic Transmission	Mopar® ATF+4 Automatic Transmission Fluid or equivalent.
Brake Master Cylinder	Mopar® DOT 3, SAE J1703 should be used. If DOT 3, SAE J1703 brake fluid is not available, then DOT 4 is acceptable. Use only recommended brake fluids.
Front Axle	API Certified GL-5 SAE 75W90 Gear Lubricant or equivalent.
Power Steering Reservoir	Mopar® Power Steering Fluid + 4, Mopar® ATF+4 Automatic Transmission Fluid or equivalent.
Rear Axle	API Certified GL-5 SAE 75W140 Synthetic Gear Lubricant or equivalent.
Transfer Case	Mopar® Transfer Case Lubricant LX, P/N 05170055EA, or equivalent.

MAINTENANCE SCHEDULES

CONTENTS

■ Emission Control System Maintenance	350	□ Schedule "B"	353
■ Maintenance Schedules	350	□ Schedule "A"	361

EMISSION CONTROL SYSTEM MAINTENANCE

The “Scheduled” maintenance services, listed in **bold type** must be done at the times or mileages specified to assure the continued proper functioning of the emission control system. These, and all other maintenance services included in this manual, should be done to provide best vehicle performance and reliability. More frequent maintenance may be needed for vehicles in severe operating conditions such as dusty areas and very short trip driving.

Inspection and service also should be done any time a malfunction is suspected.

NOTE: Maintenance, replacement, or repair of the emission control devices and systems on your vehicle may be performed by any automotive repair establishment or individual using any automotive part which has been certified pursuant to U.S. EPA or, in the State of California, California Air Resources Board regulations.

MAINTENANCE SCHEDULES

NOTE:

- For 2.7L engines with Federal Certified Emission Control Systems, and all 6.1L engines, follow Schedule “A” from 0 to 102,000 miles, or Schedule “B” from 0 to 105,000 miles.
- For 2.7L engines with California Certified Emission Control Systems, and all 3.5L and 5.7L engines follow Schedule “A” or “B” from 0 to 120,000 miles.

There are two maintenance schedules that show the **required** service for your vehicle.

First is Schedule “B.” It is for vehicles that are operated under the conditions that are listed below and at the beginning of the schedule.

Change the automatic transmission fluid and filter every 60,000 miles (100 000 km) if the vehicle is usually operated under one or more of the conditions marked with an ◇.

- Day or night temperatures are below 32°F (0°C).
- Stop and go driving.

- Extensive engine idling.
- Driving in dusty conditions.
- Short trips of less than 10 miles (16.2 km).
- More than 50% of your driving is at sustained high speeds during hot weather, above 90°F (32°C).
- Trailer towing. ◇
- Taxi, police, or delivery service (commercial service). ◇
- Off-road or desert operation.

NOTE: If ANY of these apply to you, then change your engine oil every 3,000 miles (5 000 km) or 3 months, whichever comes first, and follow the maintenance recommendations in Schedule "B" in this section.

NOTE: If ANY of these apply to you, then flush and replace the engine coolant every 102,000 miles (170 000 km) or 60 months, whichever comes first, and follow the maintenance recommendations in Schedule "B" in this section.

NOTE: Most vehicles are operated under the conditions listed for Schedule "B."

Second is Schedule "A." It is for vehicles that are not operated under any of the conditions listed under Schedule "B."

Use the schedule that best describes your driving conditions. Where time and mileage are listed, follow the interval that occurs first.

NOTE: Under no circumstances should oil change intervals exceed 6,000 miles (10 000 km) or 6 months whichever comes first.

CAUTION!

Failure to perform the required maintenance items may result in damage to the vehicle.

352 MAINTENANCE SCHEDULES

At Each Stop for Fuel

- Check the engine oil level about 5 minutes after a fully warmed engine is shut off. Checking the oil level while the vehicle is on level ground will improve the accuracy of the oil level reading. Add oil only when the level is at or below the ADD or MIN mark.
- Check the windshield washer solvent and add if required.

Once a Month

- Check tire pressure and look for unusual wear or damage.
- Inspect the battery and clean and tighten the terminals as required.
- Check the fluid levels of coolant reservoir and brake master cylinder, and add as needed.

- Check all lights and all other electrical items for correct operation.
- Check rubber seals on each side of the radiator for proper fit.

At Each Oil Change

- Change the engine oil filter.
- Inspect the exhaust system.
- Inspect the brake hoses.
- Inspect the CV joints and front and rear suspension components.
- Check the coolant level, hoses, and clamps.

SCHEDULE "B"

Follow Schedule "B" if you usually operate your vehicle under one or more of the following conditions. Change the automatic transmission fluid and filter every 60,000 miles (100 000 km) if the vehicle is usually operated under one or more of the conditions marked with an ◇.

- Day or night temperatures are below 32°F (0°C).
- Stop and go driving.
- Extensive engine idling.
- Driving in dusty conditions.
- Short trips of less than 10 miles (16.2 km).
- More than 50% of your driving is at sustained high speeds during hot weather, above 90°F (32°C).
- Trailer towing. ◇

- Taxi, police or delivery service (commercial services). ◇
- Off-road or desert operation.
- If equipped for and operating with E-85 (ethanol) fuel.

NOTE: If ANY of these apply to you, then change your engine oil every 3,000 miles (5 000 km) or 3 months, whichever comes first, and follow the maintenance recommendations in Schedule "B" in this section.

NOTE: If ANY of these apply to you, then flush and replace the engine coolant every 102,000 miles (170 000 km) or 60 months, whichever comes first, and follow the maintenance recommendations in Schedule "B" in this section.

354 SCHEDULE "B"

Miles (Kilometers)	3,000 (5 000)	6,000 (10 000)	9,000 (15 000)	12,000 (20 000)	15,000 (25 000)	18,000 (30 000)
Change engine oil and engine oil filter, if not replaced at 3 months.	X	X	X	X	X	X
Inspect the air cleaner filter and replace if required.*	X	X	X	X		X
Replace the air cleaner filter.					X	
Inspect the front and rear brake linings and rotors.				X		
Replace the air conditioning filter.				X		
Rotate the tires.		X		X		X

Miles (Kilometers)	21,000 (35 000)	24,000 (40 000)	27,000 (45 000)	30,000 (50 000)	33,000 (55 000)	36,000 (60 000)
Change engine oil and engine oil filter, if not replaced at 3 months.	X	X	X	X	X	X
Inspect the air cleaner filter and replace if required.*	X	X	X		X	X
Replace the air cleaner filter.				X		
Replace the spark plugs. 5.7L Engine.				X		
Inspect the front and rear brake linings and rotors.		X				X
Check and replace, if necessary, the PCV valve.*				X		
Replace the air conditioning filter.		X				X
Rotate the tires.		X		X		X

356 SCHEDULE "B"

Miles (Kilometers)	39,000 (65 000)	42,000 (70 000)	45,000 (75 000)	48,000 (80 000)	51,000 (85 000)	54,000 (90 000)
Change engine oil and engine oil filter, if not replaced at 3 months.	X	X	X	X	X	X
Inspect the air cleaner filter and replace if required.*	X	X		X	X	X
Replace the air cleaner filter.			X			
Inspect the front and rear brake linings and rotors.				X		
Change the rear axle fluid.				X		
Replace the air conditioning filter.				X		
Rotate the tires.		X		X		X
Change the Transfer Case Fluid - All Wheel Drive (AWD) only.				X		

Miles (Kilometers)	57,000 (95 000)	60,000 (100 000)	63,000 (105 000)	66,000 (110 000)	69,000 (115 000)	72,000 (120 000)
Change engine oil and engine oil filter, if not replaced at 3 months.	X	X	X	X	X	X
Inspect the air cleaner filter and replace if required.*	X		X	X	X	X
Replace the air cleaner filter.		X				
Replace the spark plugs. 5.7L Engine.		X				
Inspect the front and rear brake linings and rotors.		X				X
Check and Inspect the accessory drive belt and tensioner. Replace if required.						X
Check and replace, if necessary, the PCV valve. * ‡		X				
Change the automatic transmission fluid and filter.		X				
Replace the air conditioning filter.		X				X
Flush and replace engine coolant at 60 months if not done at 102,000 miles.		X				
Rotate the tires.		X		X		X

358 SCHEDULE "B"

Miles (Kilometers)	75,000 (125 000)	78,000 (130 000)	81,000 (135 000)	84,000 (140 000)	87,000 (145 000)	90,000 (150 000)
Change engine oil and engine oil filter, if not replaced at 3 months.	X	X	X	X	X	X
Inspect the air cleaner filter and replace if required.*		X	X	X	X	
Replace the air cleaner filter.	X					X
Replace the spark plugs. 5.7L Engine.						X
Inspect the front and rear brake linings and rotors.				X		
Check and replace, if necessary, the PCV valve. * ‡						X
Replace the air conditioning filter.				X		
Rotate the tires.		X		X		X

Miles (Kilometers)	93,000 (155 000)	96,000 (160 000)	99,000 (165 000)	102,000 (170 000)	105,000 (175 000)
Change engine oil and engine oil filter, if not replaced at 3 months.	X	X	X	X	X
Inspect the air cleaner filter and replace if required.*	X	X	X	X	
Replace the air cleaner filter.					X
Inspect the front and rear brake linings and rotors.		X			
Replace the engine timing belt. 3.5L Engine.					X
Replace the spark plugs. 2.7L, 3.5L Engines.			X		
Check and Inspect the accessory drive belt and tensioner. Replace if required.				X	
Change the rear axle fluid.		X			
Replace the air conditioning filter.		X			
Change the Transfer Case Fluid - All Wheel Drive (AWD) only.		X			
Flush and replace engine coolant at 102,000 miles if not done at 60 months.				X	
Rotate the tires.		X		X	

360 SCHEDULE "B"

Miles (Kilometers)	108,000 (180 000)	111,000 (185 000)	114,000 (190 000)	117,000 (195 000)	120,000 (200 000)
Change engine oil and engine oil filter, if not replaced at 3 months.	X	X	X	X	X
Inspect the air cleaner filter and replace if required.*	X	X	X	X	
Replace the air cleaner filter.					X
Inspect the front and rear brake linings and rotors.	X				X
Replace the spark plugs. 5.7L Engine.					X
Check and replace, if necessary, the PCV valve. *					X
Change the automatic transmission fluid and filter.					X
Replace the air conditioning filter.	X				X
Flush and replace the engine coolant at 120 months, if not replaced at 102,000 miles.					X
Rotate the tires.	X		X		X

* This maintenance is recommended by the manufacture to the owner but is not required to maintain the emissions warranty.

‡ This maintenance is not required if previously replaced.

Inspection and service should also be performed anytime a malfunction is observed or suspected. Retain all receipts.

SCHEDULE "A"

Miles (Kilometers) [Months]	6,000 (10 000) [6]	12,000 (20 000) [12]	18,000 (30 000) [18]	24,000 (40 000) [24]	30,000 (50 000) [30]	36,000 (60 000) [36]
Change engine oil and engine oil filter.	X	X	X	X	X	X
Inspect the air cleaner filter and replace if required.*	X	X	X	X		X
Replace the air cleaner filter.					X	
Replace the spark plugs. 5.7L Engine.					X	
Inspect the front and rear brake linings and rotors.			X			X
Replace the air conditioning filter.		X		X		X
Rotate the tires.	X	X	X	X	X	X

362 SCHEDULE "A"

Miles (Kilometers)	42,000 (70 000)	48,000 (80 000)	54,000 (90 000)	60,000 (100 000)	66,000 (110 000)	72,000 (120 000)
[Months]	[42]	[48]	[54]	[60]	[66]	[72]
Change engine oil and engine oil filter.	X	X	X	X	X	X
Inspect the air cleaner filter and replace if required.*	X	X	X		X	X
Replace the air cleaner filter.				X		
Inspect the front and rear brake linings and rotors.			X			X
Replace the spark plugs. 5.7L Engine.				X		
Check and inspect the accessory drive belt and tensioner. Replace if required.						X
Flush and replace engine coolant at 60 months if not done at 102,000 miles.				X		
Check and replace, if necessary, the PCV valve.*				X		
Replace the air conditioning filter.		X		X		X
Rotate the tires.	X	X	X	X	X	X

Miles (Kilometers)	78,000 (130 000)	84,000 (140 000)	90,000 (150 000)	96,000 (160 000)	102,000 (170 000)
[Months]	[78]	[84]	[90]	[96]	[102]
Change engine oil and engine oil filter.	X	X	X	X	X
Inspect the air cleaner filter and replace if required.*	X	X		X	X
Replace the air cleaner filter.			X		
Inspect the front and rear brake linings and rotors.			X		
Check and Inspect the accessory drive belt and tensioner. Replace if required.					X
Replace the spark plugs. 2.7L, 3.5L Engines.				X	
Replace the spark plugs. 5.7L Engine.			X		
Check and replace, if necessary, the PCV valve. *‡			X		
Replace the engine timing belt. 3.5L Engine.					X
Flush and replace the engine coolant at 102,000 miles if not done at 60 months.					X
Replace the air conditioning filter.		X		X	
Rotate the tires.	X	X	X	X	X

364 SCHEDULE "A"

Miles (Kilometers)	108,000 (180 000)	114,000 (190 000)	120,000 (200 000)
[Months]	[108]	[114]	[120]
Change engine oil and engine oil filter.	X	X	X
Inspect the air cleaner filter and replace if required.*	X	X	
Replace the air cleaner filter.			X
Inspect the front and rear brake linings and rotors.	X		
Replace the spark plugs. 5.7L Engine.			X
Check and replace, if necessary, the PCV valve. *			X
Replace the air conditioning filter.	X		X
Flush and replace the engine coolant at 120 months, if not replaced at 102,000 miles.			X
Rotate the tires.	X	X	X

* This maintenance is recommended by the manufacturer to the owner but is not required to maintain the emissions warranty.

‡ This maintenance is not required if previously replaced.

Inspection and service should also be performed anytime a malfunction is observed or suspected. Retain all receipts.

WARNING!

You can be badly injured working on or around a motor vehicle. Do only that service work for which you have the knowledge and the right equipment. If you have any doubt about your ability to perform a service job, take your vehicle to a competent mechanic.

IF YOU NEED CONSUMER ASSISTANCE

CONTENTS

■ Suggestions For Obtaining Service For Your Vehicle	366	■ Reporting Safety Defects	369
□ Prepare For The Appointment	366	□ In Canada	369
□ Prepare A List	366	■ Publication Order Forms	369
□ Be Reasonable With Requests	366	■ Department Of Transportation Uniform Tire Quality Grades	371
■ If You Need Assistance	366	□ Treadwear	371
■ Warranty Information (U.S. Vehicles Only)	368	□ Traction Grades	371
■ Mopar® Parts	368	□ Temperature Grades	372

SUGGESTIONS FOR OBTAINING SERVICE FOR YOUR VEHICLE**Prepare For The Appointment**

If you're having warranty work done, be sure to have the right papers with you. Take your warranty folder. All work to be performed may not be covered by the warranty, discuss additional charges with the service manager. Keep a maintenance log of your vehicle's service history. This can often provide a clue to the current problem.

Prepare A List

Make a written list of your vehicle's problems or the specific work you want done. If you've had an accident, or work done that is not on your maintenance log, let the service advisor know.

Be Reasonable With Requests

If you list a number of items, and you must have your vehicle by the end of the day, discuss the situation with the service advisor and list the items in order of priority. At many dealers you may obtain a rental vehicle at a

minimal daily charge. If you need a rental, it is advisable to make these arrangements when you call for an appointment.

IF YOU NEED ASSISTANCE

The manufacturer and its dealers are vitally interested in your satisfaction. We want you to be happy with our products and services.

Warranty service must be done by an authorized Chrysler, Dodge, or Jeep dealer. We strongly recommend that you take your vehicle to your selling dealer. They know you and your vehicle best, and are most concerned that you get prompt and high quality service. The manufacturer's dealers have the facilities, factory-trained technicians, special tools, and the latest information to assure your vehicle is fixed correctly and in a timely manner.

This is why you should always talk to your dealer's service manager first. Most matters can be resolved with this process.

- If for some reason you are still not satisfied, talk to the general manager or owner of the dealership. They want to know if you need assistance.
- If your dealership is unable to resolve the concern, you may contact the Manufacturer's Customer Center.

Any communication to the Manufacturer's Customer Center should include the following information:

- Owner's name and address
- Owner's telephone number (home and office)
- Dealership name
- Vehicle identification number
- Vehicle delivery date and mileage

DaimlerChrysler Motors Corporation Customer Center

P.O. Box 21-8004
Auburn Hills, MI 48321-8004
Phone: (800) 992-1997

DaimlerChrysler Canada Inc. Customer Center

P.O. Box 1621
Windsor, Ontario N9A 4H6
Phone —(800) 465-2001

In Mexico contact:

Av. Prolongacion Paseo de la Reforma, 1240
Sante Fe C.P. 05109
Mexico, D. F.

In Mexico (915) 729-1248 or 729-1240

Outside Mexico (525) 729-1248 or 729-1240

Customer Assistance For The Hearing Or Speech Impaired (TDD/TTY)

To assist customers who have hearing difficulties, the manufacturer has installed special TDD (Telecommunication Devices for the Deaf) equipment at its Customer Center. Any hearing or speech impaired customer who has access to a TDD or a conventional teletypewriter (TTY) in the United States can communicate with the manufacturer by dialing 1-800-380-CHRY.

Service Contract

You may have purchased a service contract for your vehicle to help protect you from the high cost of unexpected repairs after your manufacturer's new vehicle limited warranty expires. The manufacturer stands behind only the manufacturer's Service Contracts. If you purchased a manufacturer's Service Contract, you will receive Plan Provisions and an Owner Identification Card in the mail within three weeks of your vehicle delivery date. If you have any questions about your service contract, call the manufacturer's Service Contract National Customer Hotline at 1-800-521-9922.

The manufacturer will not stand behind any service contract that is not the manufacturer's Service Contract. It is not responsible for any service contract other than the manufacturer's Service Contract. If you purchased a service contract that is not a manufacturer's Service Contract, and you require service after your manufacturer's new vehicle limited warranty expires, please refer to your contract documents, and contact the person listed in those documents.

We appreciate that you have made a major investment when you purchased your new vehicle. Your dealer has also made a major investment in facilities, tools, and training to assure that you are absolutely delighted with your ownership experience. You'll be pleased with their sincere efforts to resolve any warranty issues or related concerns.

WARRANTY INFORMATION (U.S. Vehicles Only)

See the Warranty Information Booklet for the terms and provisions of DaimlerChrysler's warranties applicable to this vehicle.

MOPAR® PARTS

Mopar® fluids, lubricants, parts, and accessories are available from your dealer. They will help you keep your vehicle operating at its best.

REPORTING SAFETY DEFECTS

In the 50 United States and Washington D.C.: If you believe that your vehicle has a defect which could cause a crash or cause injury or death, you should immediately inform the National Highway Traffic Safety Administration (NHTSA) in addition to notifying the manufacturer.

If NHTSA receives similar complaints, it may open an investigation, and if it finds that a safety defect exists in a group of vehicles, it may order a recall and remedy campaign. However, NHTSA cannot become involved in individual problems between you, your dealer, and the manufacturer.

To contact NHTSA, you may either call the Auto Safety Hotline toll free at 1-888-327-4236 (TTY: 1-800-424-9153), or go to <http://www.NHTSA.gov>. or write to: NHTSA, U.S. Dept. of Transportation, Washington DC 20590. You can also obtain other information about motor vehicle safety from the Hotline.

In Canada:

If you believe that your vehicle has a safety defect, you should contact the Customer Service Department immediately. Canadian customers who wish to report a safety defect to the Canadian government should write to Transport Canada, Motor Vehicle Defect Investigations and Recalls, 2780 Sheffield Road, Ottawa, Ontario K1B 3V9.

PUBLICATION ORDER FORMS

To order the following manuals, you may use either the website or the phone numbers listed below. Visa, Mastercard, American Express, and Discover orders are accepted. If you prefer mailing your payment, please call for an order form.

NOTE: A street address is required when ordering manuals. (No P.O. Boxes).

- *Service Manuals.*

These comprehensive service manuals provide the information that students and professional technicians need in diagnosing/troubleshooting, problem solving, maintaining, servicing and repairing DaimlerChrysler Corporation vehicles. A complete working knowledge of the vehicle, system and/or components is written in straightforward language with illustrations, diagrams and charts.

- *Diagnostic Procedure Manuals.*

Filled with diagrams, charts and detailed illustrations, these practical manuals make it easy for students and technicians to find and fix problems on computer-controlled vehicle systems and features. They show exactly how to find and correct problems the first time, using step-by-step troubleshooting and driveability procedures, proven diagnostic tests and a complete list of all tools and equipment.

- *Owner's Manuals.*

These manuals have been prepared with the assistance of service and engineering specialists to acquaint you with specific Chrysler group vehicles. Included are starting, operating, emergency and maintenance procedures as well as specifications, capabilities and safety tips.

Call Toll Free at:

- 1-800-890-4038 (U.S.)
- 1-800-387-1143 (Canada)

Or

Visit us on the World Wide Web at:

- www.techauthority.daimlerchrysler.com
- www.daimlerchrysler.ca/manuals

DEPARTMENT OF TRANSPORTATION UNIFORM TIRE QUALITY GRADES

The following describes the tire grading categories established by the National Highway Traffic Safety Administration. The specific grade rating assigned by the tire's manufacturer in each category is shown on the sidewall of the tires on your car.

All Passenger Car Tires Must Conform to Federal Safety Requirements in Addition to These Grades.

Treadwear

The treadwear grade is a comparative rating based on the wear rate of the tire when tested under controlled conditions on a specified government test course. For example, a tire graded 150 would wear one and a half (1 1/2) times as well on the government course as a tire graded 100. The relative performance of tires depends upon the actual conditions of their use, however, and may depart significantly from the norm due to variations in driving habits, service practices and differences in road characteristics and climate.

Traction Grades

The traction grades, from highest to lowest, are AA, A, B, and C. Those grades represent the tire's ability to stop on wet pavement as measured under controlled conditions on specified government test surfaces of asphalt and concrete. A tire marked C may have poor traction performance.

WARNING!

The traction grade assigned to this tire is based on straight-ahead braking traction tests, and does not include acceleration, cornering, hydroplaning, or peak traction characteristics.

Temperature Grades

The temperature grades are A (the highest), B, and C, representing the tire's resistance to the generation of heat and its ability to dissipate heat when tested under controlled conditions on a specified indoor laboratory test wheel. Sustained high temperature can cause the material of the tire to degenerate and reduce tire life, and excessive temperature can lead to sudden tire failure. The grade C corresponds to a level of performance which all passenger car tires must meet under the Federal Motor Vehicle Safety Standard No. 109. Grades B and A represent higher levels of performance on the laboratory test wheel than the minimum required by law.

WARNING!

The temperature grade for this tire is established for a tire that is properly inflated and not overloaded. Excessive speed, underinflation, or excessive loading, either separately or in combination, can cause heat buildup and possible tire failure.

INDEX

- ABS (Anti-Lock Brake System) 225
- Adding Engine Coolant (Antifreeze) 314
- Adding Fuel 257
- Adding Washer Fluid 109,110,310
- Additives, Fuel 255
- Adjustable Pedals 98
- Air Conditioner Maintenance 307
- Air Conditioning 192
- Air Conditioning Filter 202,308
- Air Conditioning, Operating Tips 203
- Air Conditioning Refrigerant 308
- Air Conditioning System 192
- Air Pressure, Tires 244
- Airbag 39
- Airbag Deployment 43,49
- Airbag Light 44,51,61,144
- Airbag Maintenance 50
- Airbag, Side 47
- Airbag, Window (Side Curtain) 40,47
- Alarm System (Security Alarm) 25
- Alignment and Balance 250
- All Wheel Drive (AWD) 229,321
- Alterations/Modifications, Vehicle 7
- Antenna, Satellite Radio 185
- Antifreeze (Engine Coolant) 313,344
- Disposal 315
- Anti-Lock Brake System (ABS) 225
- Anti-Lock Warning Light 144
- Anti-Theft Security Alarm (Theft Alarm) 25
- Appearance Care 321
- Auto Down Power Windows 27
- Auto Up Power Windows 28
- Automatic Dimming Mirror 67
- Automatic Door Locks 17,18
- Automatic Headlights 103
- Automatic Temperature Control (ATC) 196
- Automatic Transmission 210,215,320
- Adding Fluid 320,347
- Fluid and Filter Changes 320
- Fluid Change 320
- Fluid Level Check 320
- Fluid Type 347
- Gear Ranges 211
- Torque Converter 214
- Automatic Transmission Limp Home Mode 214
- Autostick 217,222

- Ball Joints 309
 Battery 306
 Jump Starting 282
 Keyless Transmitter Replacement (RKE) 24
 Location 283,306
 Bearings 321
 Belts, Drive 303
 Body Mechanism Lubrication 309
 B-Pillar Location 239
 Brake Assist System 116
 Brake, Parking 223
 Brake System 225,317
 Anti-Lock (ABS) 225
 Fluid Check 318,347
 Hoses 317
 Warning Light 144
 Brake/Transmission Interlock 222
 Break-In Recommendations, New Vehicle 60
 Bulb Replacement 334
 Bulbs, Light 333

 Calibration, Compass 155
 Capacities, Fluid 344

 Caps, Filler
 Fuel 257
 Radiator (Coolant Pressure) 314
 Car Washes 322
 Carbon Monoxide Warning 60,256
 Cargo Tie-Downs 135
 Cassette Tape and Player Maintenance 191
 Catalytic Converter 304
 CD (Compact Disc) Player 164,171
 Cellular Phone 70
 Chains, Tire 251
 Changing A Flat Tire 275
 Chart, Tire Sizing 236
 Child Restraint 52,55,56,58
 Child Restraint Tether Anchors 56
 Child Safety Locks 19
 Clean Air Gasoline 254
 Climate Control 192
 Clock 162,166,172,188
 Compact Disc (CD) Maintenance 192
 Compact Spare Tire 246
 Compass 154
 Compass Calibration 155

- Compass Variance 155
- Computer, Trip/Travel 153
- Console 135
- Console, Floor 135
- Console, Overhead 122
- Contract, Service 368
- Coolant Pressure Cap 314
- Cooling System 312
 - Adding Coolant (Antifreeze) 314
 - Coolant Capacity 344
 - Coolant Level 312,315
 - Disposal of Used Coolant 315
 - Drain, Flush, and Refill 313
 - Inspection 315
 - Points to Remember 316
 - Pressure Cap 314
 - Radiator Cap 314
 - Selection of Coolant (Antifreeze) 313,344,346
- Cruise Control (Speed Control) 119
- Cup Holder 133,325
- Customer Assistance 366
- Data Recorder, Event 51
- Dealer Service 297
- Defroster, Rear Window 193
- Defroster, Windshield 61,195,200
- Delay (Intermittent) Wipers 109
- Diagnostic System, Onboard 295
- Dimmer Switch, Headlight 106
- Disposal
 - Antifreeze (Engine Coolant) 315
- Door Locks 15
- Door Locks, Automatic 17
- Door Opener, Garage 123
- Drive Belts 303
- Driving
 - On Slippery Surfaces 284
- DVD Player (Video Entertainment System) 186
- Electric Remote Mirrors 69
- Electrical Power Outlets 131
- Electronic Speed Control (Cruise Control) 119
- Electronic Stability Program (ESP) 117
- Electronic Vehicle Information Center (EVIC) 150
- Emergency, In Case of
 - Freeing Vehicle When Stuck 285

- Hazard Warning Flasher 274
- Jacking 275
- Jump Starting 282
- Overheating 274
- Towing 286
- Emission Control System Maintenance 296,350
- Engine 292,293,294
 - Air Cleaner 304
 - Air Cleaner Filter 304
 - Block Heater 210
 - Break-In Recommendations 60
 - Checking Oil Level 298,299
 - Compartment 292,293,294
 - Coolant (Antifreeze) 312,346
 - Cooling 312
 - Exhaust Gas Caution 60,256
 - Fails to Start 209
 - Fuel Requirements 253,344
 - Oil 298,344,346
 - Oil Change Interval 300
 - Oil Selection 300,344
 - Oil Synthetic 302
 - Overheating 274
 - Temperature Gauge 146
- Enhanced Accident Response Feature 50
- Event Data Recorder 51
- Exhaust Gas Caution 60,256,311
- Exhaust System 311
- Exterior Folding Mirrors 68
- Filters
 - Air Cleaner 304
 - Air Conditioning 202,308
 - Engine Fuel 304
 - Engine Oil 303,346
 - Engine Oil Disposal 302
- Flashers
 - Hazard Warning 274
 - Turn Signal 143
- Flash-To-Pass 106
- Flat Tire Changing 275
- Floor Console 135
- Fluid Capacities 344
- Fluid Leaks 61
- Fluid Level Checks
 - Brake 318

- Cooling System 312
- Engine Oil 298,299
- Power Steering 309
- Fluids 346
- Fluids, Lubricants and Genuine Parts 346
- Fog Lights 105,143
- Folding Rear Seat 94
- Freeing A Stuck Vehicle 285
- Fuel 253
 - Adding 257
 - Additives 255
 - Clean Air 254
 - Filler Cap (Gas Cap) 257
 - Filter 304
 - Gasoline 253
 - Gauge 147
 - Hoses 319
 - Octane Rating 253,346
 - Requirements 253,344
 - Tank Capacity 344
- Fueling 257
- Fuses 326
- Garage Door Opener (HomeLink®) 123
- Gas Cap (Fuel Filler Cap) 257
- Gasoline, Clean Air 254
- Gasoline (Fuel) 253
- Gasoline, Reformulated 254
- Gauges
 - Coolant Temperature 146
 - Fuel 147
 - Speedometer 143
 - Tachometer 143
- Gear Ranges 211
- General Information 15,23,234
- Glass Cleaning 324
- Gross Axle Weight Rating 260,263
- Gross Vehicle Weight Rating 260,262
- Hands-Free Phone (UConnect™) 70
- Hazard Warning Flasher 274
- Head Restraints 94
- Headlight Washers 110,310
- Headlights 336
 - High Beam 106
 - High Beam/Low Beam Select Switch 106

On With Wipers	103,108	Information Center, Vehicle	150
Passing	106	Instrument Cluster	141,142,143
Switch	102,103	Instrument Panel and Controls	140
Time Delay	105	Instrument Panel Lens Cleaning	324
Washers	110,310	Interior Appearance Care	323
Heated Seats	92	Interior Fuses	326
Heater, Engine Block	210	Interior Lights	101
High Beam/Low Beam Select (Dimmer) Switch	106	Intermittent Wipers (Delay Wipers)	109
Hitches		Introduction	4
Trailer Towing	264	Jack Location	277
Holder, Cup	133	Jack Operation	278
HomeLink® (Garage Door Opener) Transmitter	123	Jacking Instructions	278
Hood Release	99	Jump Starting	282
Horn	12	Key, Programming	14
Hoses	316,319	Key, Replacement	13
Ignition		Key, Sentry (Immobilizer)	12
Key	11	Key-In Reminder	12
Illuminated Entry	15	Keyless Entry System	20
Immobilizer (Sentry Key)	12	Keys	11
Infant Restraint	53	Knee Bolster	39

- Lap/Shoulder Belts 32
LATCH
(Lower Anchors and Tether for CHildren) 56
Latch Plate 33
Latches
 Hood 99
Lead Free Gasoline 253
Life of Tires 249
Lights 61,100
 Airbag 44,51,61,144
 Anti-Lock 144
 Automatic Headlights 103
 Brake Warning 144
 Bulb Replacement 333
 Courtesy/Reading 100
 Daytime Running 104
 Dimmer Switch, Headlight 102,106
 Engine Temperature Warning 143
 Fog 105,143
 Hazard Warning Flasher 274
 Headlight Switch 103
 Headlights 103,336
 Headlights On With Wipers 103,108
 High Beam 106
 High Beam Indicator 147
 Illuminated Entry 15
 Instrument Cluster 103
 Interior 101
 License 344
 Lights On Reminder 105
 Malfunction Indicator (Check Engine) 149
 Oil Pressure 149
 Reading 122
 Seat Belt Reminder 147
 Service 333,334
 Service Engine Soon
 (Malfunction Indicator) 149
 SmartBeams 104
 Turn Signal 102,105
 Voltage 149
Load Leveling System 136
Loading Vehicle 260,261
 Capacities 261
 Tires 239
Locks
 Door 15

Lower Anchors and Tether for Children (LATCH)	56	Rearview	67
Lubrication, Body	309	Vanity	70
Lumbar Support	92	Modifications/Alterations, Vehicle	7
Maintenance Free Battery	306	Monitor, Tire Pressure System	230
Maintenance Procedures	298	Mopar Parts	297,368
Maintenance Schedule	350	Multi-Displacement Engine System	229
Schedule "A"	361	Multi-Function Control Lever	102
Schedule "B"	353	Navigation System	188
Malfunction Indicator Light (Check Engine)	149,296	New Vehicle Break-In Period	60
Manual, Service	369	Occupant Restraints	31
Memory Feature (Memory Seat)	95	Octane Rating, Gasoline (Fuel)	253
Memory Seat	95	Oil, Engine	298,346
Memory Seats and Radio	95	Capacity	344
Mini-Trip Computer	153	Change Interval	300
Mirrors	67	Checking	298,299
Automatic Dimming	67	Disposal	302
Electric Remote	69	Filter	303,346
Exterior Folding	68	Filter Disposal	302
Heated	69	Identification Logo	301
Outside	68	Materials Added to	302
		Recommendation	300,344

- Synthetic 302
- Viscosity 301,344
- Onboard Diagnostic System 295,296
- Opener, Garage Door (HomeLink®) 123
- Operator Manual (Owner's Manual) 4
- Overhead Console 122
- Overheating, Engine 146,274
- Owner's Manual (Operator Manual) 4,369

- Panic Alarm 22
- Park Assist System, Rear 114
- Parking Brake 223
- Parking On Hill 224
- Passing Light 106
- Pedals, Adjustable 98
- Personal Settings 158
- Pets 59
- Phone, Cellular 70
- Phone, Hands-Free (UConnect™) 70
- Placard, Tire and Loading Information 239
- Power
 - Brakes 225
 - Distribution Center 326
 - Door Locks 16
 - Mirrors 69
 - Outlet (Auxiliary Electrical Outlet) 131
 - Seats 90
 - Steering 228
 - Steering, Checking 309
 - Sunroof 128
 - Tilt/Telescoping Steering Column 112
 - Windows 26
- Pregnant Women and Seat Belts 38
- Preparation for Jacking 276
- Pretensioners
 - Seat Belts 36
- Programmable Electronic Features 124,127,158
- Programming Transmitters (Remote Keyless Entry) 124,127

- Radial Ply Tires 246
- Radiator Cap (Coolant Pressure Cap) 314
- Radio Broadcast Signals 163
- Radio Operation 164,171,192
- Radio Remote Controls 189
- Radio, Satellite 183

Radio (Sound Systems)	164,171	Safety Defects, Reporting	369
Rain Sensitive Wiper System	107	Safety Information, Tire	234
Rear Park Assist System	114	Safety Tips	60
Rear Seat, Folding	94	Satellite Radio	183
Rear Window Defroster	193	Satellite Radio Antenna	185
Rearview Mirrors	67	Schedule, Maintenance	350
Reclining Front Seats	91	Seat Belt Maintenance	325
Recorder, Event Data	51	Seat Belt Reminder	37
Recreational Towing	272	Seat Belts	32
Refrigerant	308	Adjustable Upper Shoulder Anchorage	36
Reminder, Seat Belt	37	And Pregnant Women	38
Remote Keyless Entry (RKE)	20	Child Restraint	52,53,58
Remote Sound System (Radio) Controls	189	Extender	38
Remote Trunk Release	29	Front Seat	33
Replacement Tires	249	Operating Instructions	33
Reporting Safety Defects	369	Pretensioners	36
Restraint, Head	94	Reminder	147
Restraints, Occupant	31	Seats	90
Rocking Vehicle When Stuck	285	Easy Entry	97
Rotation, Tires	252	Heated	92
Safety Checks Inside Vehicle	61	Lumbar Support	92
Safety Checks Outside Vehicle	61	Memory	95
		Power	90

- Rear Folding 94
Reclining 91
Security Alarm (Theft Alarm) 25
Selection of Coolant (Antifreeze) 313,346
Self-Sealing Tires 229
Sentry Key (Immobilizer) 12
Service Assistance 366
Service Contract 368
Service Engine Soon Light
(Malfunction Indicator) 149
Service Manuals 369
Setting the Clock 162,166,172,188
Settings, Personal 158
Shift Speeds 210
Shoulder Belt Upper Anchorage 36
Side Airbag 47
Signals, Turn 143
Slippery Surfaces, Driving On 284
SmartBeams 104
Snow Chains (Tire Chains) 251
Snow Tires 252
Spare Tire 246,247,277
Spark Plugs 303
Speed Control (Cruise Control) 119
Speedometer 143
Starting 208
 Engine Fails to Start 209
Starting and Operating 208
Steering
 Linkage 309
 Power 228,309
 Tilt Column 111,112
 Wheel, Tilt 111,112
Steering Wheel Mounted Sound System
 Controls 189
Storage 135,332
Storage, Vehicle 202,332
Storing Your Vehicle 332
Sun Roof 128
Sunglasses Storage 122
Supplemental Restraint System - Airbag 39
System, Navigation 188
Tachometer 143
Telescoping Steering Column 111,112
Temperature Control, Automatic (ATC) 196

Temperature Gauge, Engine Coolant	146,275	Pressure Monitor System (TPMS)	230
Theft Alarm (Security Alarm)	25	Quality Grading	371
Theft System (Security Alarm)	25	Radial	246
Tie Down Hooks, Cargo	135	Replacement	249
Tilt Steering Column	111,112	Rotation	252
Tire and Loading Information Placard	239	Safety	234,243
Tire Identification Number (TIN)	238	Self-Sealing	229
Tire Markings	234	Sizes	236
Tire Safety Information	234	Snow Tires	252
Tires	61,243,371	Spare Tire	277
Aging (Life of Tires)	249	Spinning	247
Air Pressure	243	Tread Wear Indicators	248
Alignment	250	Tongue Weight/Trailer Weight	266
Chains	251	Torque Converter Clutch	214
Changing	275,278	Towing	262
Compact Spare	246	Behind a Motor Home	272
Flat Changing	275	Disabled Vehicle	286
General Information	243	Guide	264
High Speed	245	Recreational	272
Inflation Pressures	244	Weight	264
Jacking	276,278	Towing Vehicle Behind a Motor Home	272
Life of Tires	249	Traction Control	113
Load Capacity	239,240	Traction Control Switch	113

- Trailer Towing 262
 Cooling System Tips 272
 Hitches 264
 Minimum Requirements 267
 Trailer and Tongue Weight 266
 Wiring 269
Trailer Towing Guide 264
Trailer Weight 264
Transmission 320
 Automatic 210,215,320
 Fluid 347
 Shifting 210
Transmitter Battery Service
(Remote Keyless Entry) 24
Transmitter, Garage Door Opener
(HomeLink®) 123
Transmitter, Remote Keyless Entry (RKE) 20
Transporting Pets 59
Tread Wear Indicators 248
Trip Odometer Reset Button 147
Trunk Release, Emergency 31
Trunk Release Remote Control 29
Turn Signals 105,143
Uniform Tire Quality Grades 371
Universal Transmitter 123
Unleaded Gasoline 253
Vanity Mirrors 70
Variance, Compass 155
Vehicle Certification Label 260
Vehicle Identification Number (VIN) 6
Vehicle Loading 240,260,261
Vehicle Modifications/Alterations 7
Vehicle Storage 202,332
Vehicle Theft Alarm (Security Alarm) 25
Video Entertainment System
(Rear Seat Video System) 186
Warning Flasher, Hazard 274
Warnings and Cautions 6
Warranty Information 368
Washer, Adding Fluid 109,110,310
Washers, Headlight 110
Washers, Windshield 107
Washing Vehicle 322
Wheel Alignment and Balance 250

Wheel and Wheel Trim	323
Wheel Bearings	321
Wind Buffeting	29,130
Window Airbag (Side Curtain)	40,47
Window Fogging	195,202
Windows	26
Power	26
Windshield Defroster	195,200
Windshield Washers	106,107,310
Windshield Wiper Blades	310
Windshield Wipers	106
Wiper Blade Replacement	310
Wipers, Intermittent	109
Wipers, Rain Sensitive	107

