

# 2014 Chevrolet SS Sedan Owner Manual

<b>In Brief</b> .....	1-1	<b>Storage</b> .....	4-1	<b>Climate Controls</b> .....	8-1
Instrument Panel .....	1-2	Storage Compartments .....	4-1	Climate Control Systems .....	8-1
Initial Drive Information .....	1-4	Additional Storage Features .....	4-3	Air Vents .....	8-6
Vehicle Features .....	1-13	<b>Instruments and Controls</b> .....	5-1	Maintenance .....	8-6
Performance and		Controls .....	5-2	<b>Driving and Operating</b> .....	9-1
Maintenance .....	1-17	Warning Lights, Gauges, and		Driving Information .....	9-2
<b>Keys, Doors, and</b>		Indicators .....	5-6	Starting and Operating .....	9-15
<b>Windows</b> .....	2-1	Information Displays .....	5-21	Engine Exhaust .....	9-21
Keys and Locks .....	2-1	Vehicle Messages .....	5-26	Automatic Transmission .....	9-22
Doors .....	2-12	Vehicle Personalization .....	5-33	Brakes .....	9-26
Vehicle Security .....	2-14	<b>Lighting</b> .....	6-1	Ride Control Systems .....	9-30
Exterior Mirrors .....	2-16	Exterior Lighting .....	6-1	Cruise Control .....	9-32
Interior Mirrors .....	2-17	Interior Lighting .....	6-4	Driver Assistance Systems .....	9-35
Windows .....	2-18	Lighting Features .....	6-5	Fuel .....	9-46
Roof .....	2-20	<b>Infotainment System</b> .....	7-1	Trailer Towing .....	9-50
<b>Seats and Restraints</b> .....	3-1	Introduction .....	7-2	Conversions and Add-Ons .....	9-50
Head Restraints .....	3-2	Radio .....	7-11	<b>Vehicle Care</b> .....	10-1
Front Seats .....	3-3	Audio Players .....	7-32	General Information .....	10-2
Rear Seats .....	3-7	Navigation .....	7-42	Vehicle Checks .....	10-3
Safety Belts .....	3-8	Voice Recognition .....	7-68	Headlamp Aiming .....	10-24
Airbag System .....	3-14	Bluetooth Phone/Devices .....	7-75	Bulb Replacement .....	10-24
Child Restraints .....	3-26	Trademarks and License		Electrical System .....	10-26
		Agreements .....	7-85	Wheels and Tires .....	10-34
				Jump Starting .....	10-69

# 2014 Chevrolet SS Sedan Owner Manual

---

Towing the Vehicle .....	10-71	<b>Customer Information</b> .....	13-1
Appearance Care .....	10-72	Customer Information .....	13-1
<b>Service and Maintenance</b> ...	11-1	Reporting Safety Defects ....	13-12
General Information .....	11-1	Vehicle Data Recording and	
Maintenance Schedule .....	11-2	Privacy .....	13-13
Special Application		<b>OnStar</b> .....	14-1
Services .....	11-8	OnStar Overview .....	14-1
Additional Maintenance		OnStar Services .....	14-2
and Care .....	11-8	OnStar Additional	
Recommended Fluids .....	11-12	Information .....	14-5
Maintenance Records .....	11-14	<b>Index</b> .....	i-1
<b>Technical Data</b> .....	12-1		
Vehicle Identification .....	12-1		
Vehicle Data .....	12-2		



The names, logos, emblems, slogans, vehicle model names, and vehicle body designs appearing in this manual including, but not limited to, GM, the GM logo, CHEVROLET, the CHEVROLET Emblem, SS, and the SS Emblem are trademarks and/or service marks of General Motors LLC, its subsidiaries, affiliates, or licensors.

This manual describes features that may or may not be on your specific vehicle either because they are options that you did not purchase or due to changes subsequent to the printing of this owner manual. Please refer to the purchase documentation relating to your

specific vehicle to confirm each of the features found on your vehicle.

Keep this manual in the vehicle for quick reference.

## Using this Manual

To quickly locate information about the vehicle, use the Index in the back of the manual. It is an alphabetical list of what is in the manual and the page number where it can be found.

## Danger, Warnings, and Cautions

### **Danger**

Text marked  **Danger** provides information on risk of fatal injury. Disregarding this information may endanger life.

### **Warning**

Text marked  **Warning** provides information on risk of accident or injury. Disregarding this information may lead to injury.

### **Caution**

Text marked  **Caution** provides information that may indicate a hazard that could result in injury or death. It could also result in possible damage to the vehicle.



## iv Introduction

---

A circle with a slash through it is a safety symbol which means “Do Not,” “Do not do this,” or “Do not let this happen.”

### Symbols

The vehicle has components and labels that use symbols instead of text. Symbols are shown along with the text describing the operation or information relating to a specific component, control, message, gauge, or indicator.

 : This symbol is shown when you need to see your owner manual for additional instructions or information.

 : This symbol is shown when you need to see a service manual for additional instructions or information.

### Vehicle Symbol Chart

Here are some additional symbols that may be found on the vehicle and what they mean. For more information on the symbol, refer to the Index.

 : Airbag Readiness Light

 : Air Conditioning

 : Antilock Brake System (ABS)

 : Audio Steering Wheel Controls or OnStar® (if equipped)

 : Brake System Warning Light

 : Charging System

 : Cruise Control

 : Engine Coolant Temperature

 : Exterior Lamps

 : Fog Lamps

 : Fuel Gauge

 : Fuses

 : Headlamp High/Low-Beam Changer

 : LATCH System Child Restraints

 : Malfunction Indicator Lamp

 : Oil Pressure

 : Power

 : Remote Vehicle Start

 : Safety Belt Reminders

 : Tire Pressure Monitor

 : Traction Control/StabiliTrak®

 : Windshield Washer Fluid

## In Brief

### Instrument Panel

Instrument Panel Overview .... 1-2

### Initial Drive Information

Initial Drive Information ..... 1-4

Remote Keyless Entry (RKE)

System ..... 1-4

Remote Vehicle Start ..... 1-5

Door Locks ..... 1-5

Windows ..... 1-6

Seat Adjustment ..... 1-6

Memory Features ..... 1-7

Heated and Ventilated

Seats ..... 1-8

Head Restraint Adjustment .... 1-8

Safety Belts ..... 1-8

Passenger Sensing System ... 1-9

Mirror Adjustment ..... 1-9

Steering Wheel

Adjustment ..... 1-10

Interior Lighting ..... 1-10

Exterior Lighting ..... 1-11

Windshield Wiper/Washer .... 1-11

Climate Controls ..... 1-12

Transmission ..... 1-13

### Vehicle Features

Steering Wheel Controls ..... 1-13

Cruise Control ..... 1-14

Driver Information

Center (DIC) ..... 1-14

Forward Collision Alert (FCA)

System ..... 1-15

Lane Departure

Warning (LDW) ..... 1-15

Side Blind Zone

Alert (SBZA) ..... 1-15

Rear Vision

Camera (RVC) ..... 1-15

Ultrasonic Parking Assist .... 1-15

Automatic Parking

Assist (APA) ..... 1-16

Power Outlets ..... 1-16

Sunroof ..... 1-16

### Performance and Maintenance

Traction Control/Electronic

Stability Control ..... 1-17

Tire Pressure Monitor ..... 1-17

Engine Oil Life System ..... 1-18

Driving for Better Fuel

Economy ..... 1-18

Battery ..... 1-19

Roadside Assistance

Program ..... 1-19

OnStar® ..... 1-19

## Instrument Panel

### Instrument Panel Overview

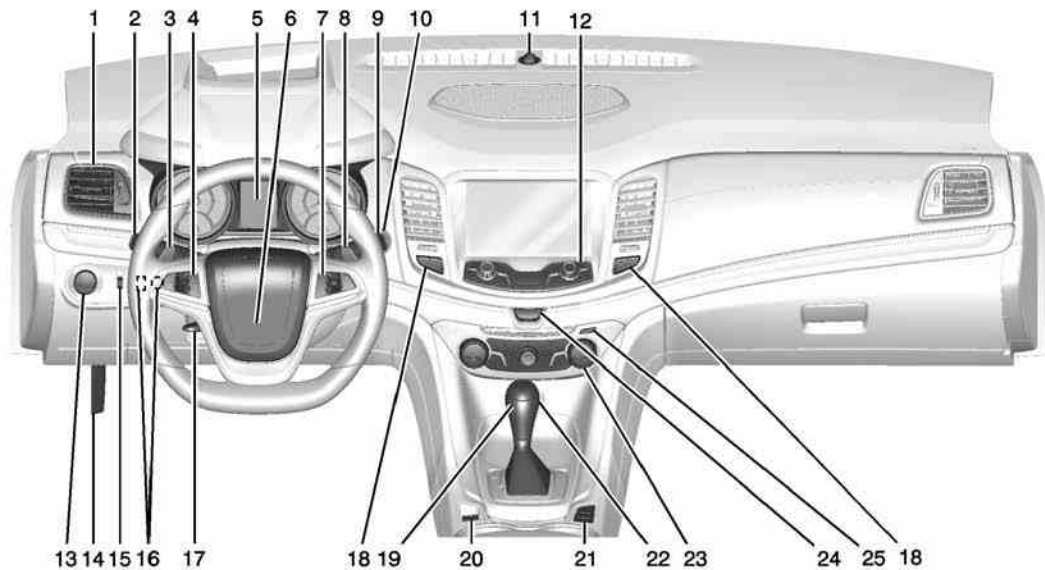

1. *Air Vents on page 8-6.*
2. *Turn Signal Lever. See Turn and Lane-Change Signals on page 6-3.*  
*Driver Information Center (DIC) Controls. See Driver Information Center (DIC) on page 5-21.*
3. *Paddle Shifter Up. See Manual Mode on page 9-24.*
4. *Cruise Control on page 9-32.*  
*Lane Departure Warning (LDW) on page 9-44 (If Equipped).*  
*Forward Collision Alert (FCA) System on page 9-40 (If Equipped).*
5. *Instrument Cluster on page 5-7.*
6. *Horn on page 5-3.*
7. *Steering Wheel Controls on page 5-2.*
8. *Paddle Shifter Down. See Manual Mode on page 9-24.*
9. *Windshield Wiper/Washer on page 5-3.*
10. *Ignition. See Ignition Positions on page 9-15.*
11. *Solar Sensor. See Dual Automatic Climate Control System on page 8-1.*
12. *Infotainment. See Overview on page 7-2.*
13. *Exterior Lamp Controls on page 6-1.*
14. *Hood Release. See Hood on page 10-4.*
15. *Instrument Panel Illumination Control on page 6-4.*
16. *Head-Up Display (HUD) on page 5-23.*
17. *Steering Wheel Adjustment on page 5-2.*
18. *Heated and Ventilated Front Seats on page 3-6.*
19. *Shift Lever. See Automatic Transmission on page 9-22.*
20. *Electric Parking Brake on page 9-27.*
21. *Traction Control/Electronic Stability Control on page 9-30.*  
*Front and Rear Parking Assist Button. See Assistance Systems for Parking or Backing on page 9-36.*  
*Automatic Parking Assist (APA) Button (If Equipped). See Assistance Systems for Parking or Backing on page 9-36.*
22. *Power Outlets on page 5-4 (Out of View).*
23. *Dual Automatic Climate Control System on page 8-1.*
24. *Hazard Warning Flashers on page 6-3.*
25. *CD Player Eject Button. See CD Player on page 7-32.*

### Initial Drive Information

This section provides a brief overview about some of the important features that may or may not be on your specific vehicle.

For more detailed information, refer to each of the features which can be found later in this owner manual.

### Remote Keyless Entry (RKE) System

The Remote Keyless Entry (RKE) transmitter may work up to 60 m (197 ft) away from the vehicle.

The RKE transmitter can have one of the two symbols for the remote trunk release.



Press this button to extend the key.  
The key can be used for all locks.





 : Press to unlock the driver door or all doors.



 : Press to lock all doors.

Lock and unlock feedback can be personalized.

 or **HOLD** : Press and hold until the trunk begins to move.

 : Press and release to initiate vehicle locator. Press and hold for at least three seconds to sound the panic alarm. Press  again to cancel the panic alarm.





 : Press  and release and then immediately press and hold  for four seconds to start the engine from outside the vehicle.

See *Keys on page 2-1* and *Remote Keyless Entry (RKE) System Operation on page 2-3*.

## Remote Vehicle Start

With this feature the engine can be started from outside the vehicle.

### Starting the Vehicle

1. Aim the RKE transmitter at the vehicle.
2. Press and release .
3. Immediately after completing Step 2, press and hold  for at least four seconds or until the turn signal lamps flash.

When the engine starts, the parking lamps will turn on and remain on as long as the engine is running. The doors will be locked and the climate control system may come on.

The engine will continue to run for 10 minutes. Repeat the steps for a 10-minute time extension. Remote start can be extended only once.

### Canceling a Remote Start



To cancel a remote start, do one of the following:

- Aim the RKE transmitter at the vehicle and press and hold  until the parking lamps turn off.
- Turn on the hazard warning flashers.
- Turn the vehicle on and then off.

See *Remote Vehicle Start on page 2-8*.

## Door Locks



To lock or unlock the doors from the outside:

- Press  or  on the Remote Keyless Entry (RKE) transmitter. See *Remote Keyless Entry (RKE) System Operation on page 2-3*.

- Use the key in the driver door. Turn the key toward the rear to lock all doors. Turn the key toward the front to unlock the driver door. Turn the key again toward the front to unlock all doors.

To lock or unlock the doors from the inside:



- Press  or .
- Push the door lock knob on the top of the door to lock.

## 1-6 In Brief

- Pull the door handle once to unlock the door. Pulling the handle again unlatches the door.

See *Door Locks* on page 2-10 or *Power Door Locks* on page 2-11.

### Windows



Press the switch down to open the window. Pull the switch up to close it.

The power windows only operate with the ignition in ACC/ACCESSORY or ON/RUN/START, or when Retained Accessory Power (RAP) is active. See *Retained Accessory Power (RAP)* on page 9-18.

### Express Window Operation

Windows with an express-down or express-up feature allow the window to be lowered or raised without holding the switch. Pull a window switch up or press it down all the way, release it, and the window goes up or down automatically. Stop the window by pressing or pulling the switch in the same direction a second time, or by briefly operating the switch to the first detent in either direction.

See *Power Windows* on page 2-18.

## Seat Adjustment

### Power Seats



To adjust the seat:

- Move the seat forward or rearward by sliding the control forward or rearward.
- Raise or lower the seat by moving the rear of the control up or down.
- Raise or lower the front part of the seat cushion by moving the front of the control up or down.

See *Power Seat Adjustment* on page 3-3.

### Lumbar Adjustment



To increase or decrease lumbar support, slide the switch forward or rearward.

See *Lumbar Adjustment* on page 3-4.

### Reclining Seatbacks

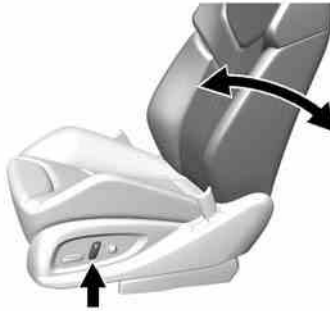

To adjust the seatback:

- Tilt the top of the control rearward to recline.
- Tilt the top of the control forward to raise.

See *Reclining Seatbacks* on page 3-4.

### Memory Features

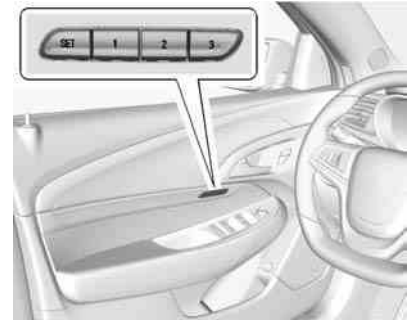



The SET, "1," "2," and "3" buttons on the driver door are used to manually save and recall memory settings for the driver seat and outside mirrors. These manually stored positions are referred to as Button Memory positions.

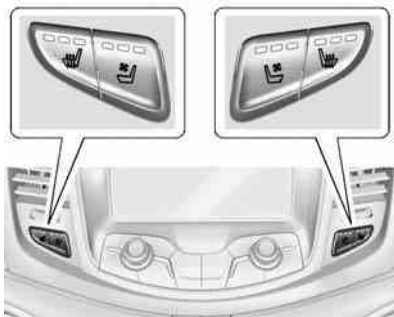

See *Memory Seats* on page 3-5 and *Vehicle Personalization* on page 5-33.

### Heated and Ventilated Seats



The buttons are below the air vents on the center stack. To operate, the engine must be running.

Press  or  to heat the driver or passenger seat.

Press  or  to ventilate the driver or passenger seat. A ventilated seat has a fan that pulls or pushes air through the seat. The air is not cooled.

See *Heated and Ventilated Front Seats* on page 3-6.

### Head Restraint Adjustment

Do not drive until the head restraints for all occupants are installed and adjusted properly.

To achieve a comfortable seating position, change the seatback recline angle as little as necessary while keeping the seat and the head restraint height in the proper position.

See *Head Restraints* on page 3-2 and *Power Seat Adjustment* on page 3-3.

### Safety Belts



Refer to the following sections for important information on how to use safety belts properly.

- *Safety Belts* on page 3-8.
- *How to Wear Safety Belts Properly* on page 3-9.
- *Lap-Shoulder Belt* on page 3-10.
- *Lower Anchors and Tethers for Children (LATCH System)* on page 3-34.

## Passenger Sensing System



The passenger sensing system will turn off the front outboard passenger frontal airbag and knee airbag under certain conditions. No other airbag is affected by the passenger sensing system. See *Passenger Sensing System* on page 3-20.

The passenger airbag status indicator lights in the rearview mirror are visible when the vehicle is started. See *Passenger Airbag Status Indicator* on page 5-11.

## Mirror Adjustment

### Manual Rearview Mirror

Adjust the rearview mirror to view the area behind the vehicle.

Push the tab forward for daytime use and pull it for nighttime use to reduce glare.

### Exterior Mirrors



To adjust the mirrors:

1. With the ignition on, press the switch (2) to select the left or right mirror.

2. Press the arrows (1) to adjust the mirror.
3. Adjust the mirror to see a little of the vehicle, and the area behind the vehicle.

Keep the switch (2) in the center when not adjusting the mirrors.

### Folding Mirrors

Manually fold the mirrors inward to prevent damage when going through an automatic car wash. To fold, push the mirror toward the vehicle. Push the mirror outward to return it to its original position.

## Steering Wheel Adjustment



To adjust the steering wheel:

1. Pull the lever down.
2. Move the steering wheel up or down and in or out for a comfortable position.
3. Pull the lever up to lock the steering wheel in place.

Do not adjust the tilt and telescope lever while driving.

## Interior Lighting

### Dome Lamps

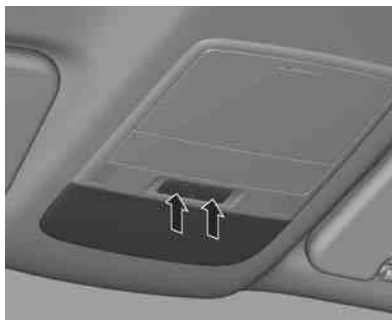

The dome lamps are in the overhead console.



 : Press to turn the lamp on or off.

 : Press to automatically turn on the lamps when a door is opened, the vehicle is unlocked, or the ignition is turned off.

### Reading Lamps



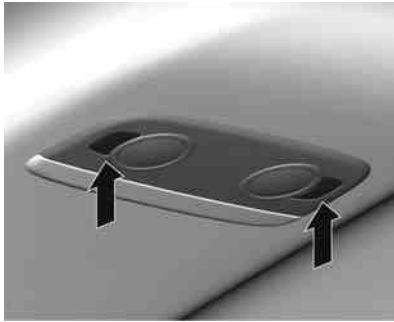

The front reading lamps are in the overhead console.

Press  or  to turn the lamp on or off.



The rear reading lamps are in the headliner.

Press  or  to turn the lamp on or off.

For more information on interior lamps, see:

- *Dome Lamps on page 6-4*
- *Instrument Panel Illumination Control on page 6-4*

## Exterior Lighting

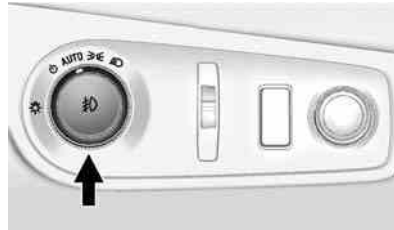

The exterior lamp control is on the instrument panel to the left of the steering wheel.

 : Briefly turn to this position to turn the automatic light control off or on again.

**AUTO:** Automatic operation of the headlamps at normal brightness and other exterior lamps.

 : Turns on the parking lamps including all lamps, except the headlamps.

 : Turns on the headlamps together with the parking lamps and instrument panel lights.

See:

- *Exterior Lamp Controls on page 6-1*
- *Daytime Running Lamps (DRL) on page 6-2*
- *Fog Lamps on page 6-3*

## Windshield Wiper/Washer



With the ignition in ACC/ACCESSORY or ON/RUN/START, move the lever to select the wiper speed.

**HI:** Use for fast wipes.

**LO:** Use for slow wipes.



**INT:** Move the windshield wiper lever to INT. Turn the  INT band on the wiper lever to adjust the sensitivity.

**OFF:** Use to turn the wipers off.

 : For a single wipe, briefly move the lever down. For several wipes, hold the lever down.

↓  : Pull the lever toward you to spray windshield washer fluid and activate the wipers.

See *Windshield Wiper/Washer* on page 5-3.

## Climate Controls

The heating, cooling, and ventilation for the vehicle can be controlled with this system.

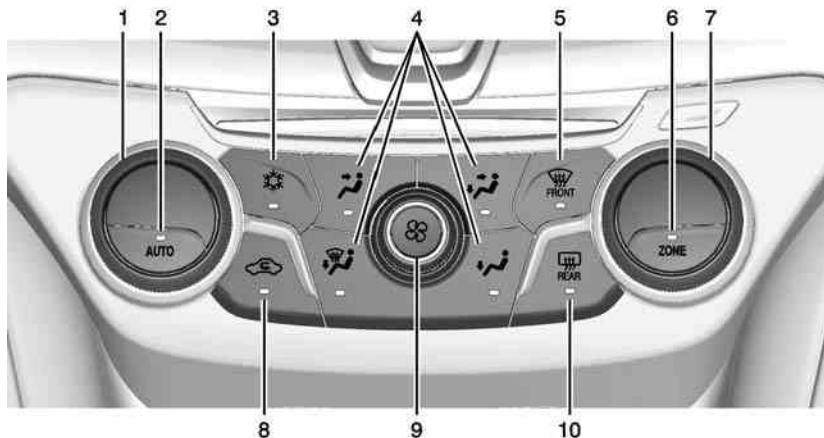

- |                               |                                  |
|-------------------------------|----------------------------------|
| 1. Driver Temperature Control | 5. Front Defrost                 |
| 2. AUTO (Automatic Operation) | 6. ZONE                          |
| 3. Air Conditioning           | 7. Passenger Temperature Control |
| 4. Air Delivery Mode Controls | 8. Recirculation                 |



9. Fan Control

10. Rear Window Defogger

See *Dual Automatic Climate Control System* on page 8-1.

## Transmission

### Automatic Transmission



P (Park)

R (Reverse)

N (Neutral)

D (Drive)

+ (Plus)/- (Minus): For Sport Shift mode, move the shift lever to D (Drive), then push to the right.

While in Sport Shift mode, move the shift lever to the + (Plus) or - (Minus) position to enable Active Select mode.



See *Automatic Transmission* on page 9-22.



## Vehicle Features



### Steering Wheel Controls



Some audio functions can be controlled through the steering wheel controls.

  : Press to interact with Bluetooth or voice recognition. See *Bluetooth* on page 7-75, *OnStar Overview* on page 14-1, or *Voice Recognition* on page 7-68.

 /  : Press to decline an incoming call, or to end a current call. Press to silence the vehicle speakers while using the infotainment system. Press again to turn the sound on. Press to cancel voice recognition.

 **SRC**  : Press to select an audio source.

Use the thumbwheel to select the next or previous favorite radio station, CD track, MP3 track, USB track, and Bluetooth Audio track.

Use  SRC to skip to the next song or show using Pandora or Stitcher. See *Pandora Internet Radio* on page 7-22 or *Stitcher Internet Radio* on page 7-27.

+  -: Press + to increase the volume. Press - to decrease.

See *Steering Wheel Controls* on page 5-2.

## Cruise Control



 : Press to turn the cruise control system on and off.

 : Press to disengage cruise control without erasing the set speed from memory.

**RES/+**: Move the thumbwheel up briefly to make the vehicle resume to a previously set speed or hold upwards to accelerate. If cruise control is already active, use to increase vehicle speed.

**SET/-**: Move the thumbwheel down briefly to set the speed and activate cruise control. If cruise control is already active, use to decrease speed.

See *Cruise Control* on page 9-32.

## Driver Information Center (DIC)

The DIC display is in the center of the instrument cluster. It shows the status of many vehicle systems. The controls for the DIC are on the turn signal lever.

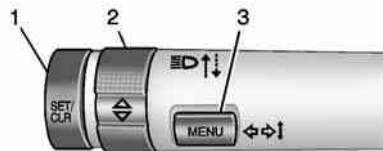

1. **SET/CLR**: Press to set, or press and hold to clear, the menu item displayed.
2. : Use the band to scroll through the items in each menu.

3. **MENU:** Press to display the DIC menus. This button is also used to return to or exit the last screen displayed on the DIC.

See *Driver Information Center (DIC)* on page 5-21.

### Forward Collision Alert (FCA) System

If equipped, FCA may help avoid or reduce the harm caused by front-end crashes. FCA provides a green indicator when a vehicle is detected ahead. This indicator displays amber if you follow a vehicle much too closely. When approaching a vehicle ahead too quickly, FCA provides a red flashing alert on the windshield and rapidly beeps.

See *Forward Collision Alert (FCA) System* on page 9-40.

### Lane Departure Warning (LDW)

If equipped, LDW is intended to help avoid unintentional lane departures at speeds of 56 km/h (35 mph) or greater. LDW uses a camera sensor to detect the lane markings. The LDW indicator, , appears green if a lane marking is detected. If the vehicle departs the lane, the indicator will change to amber and flash. In addition, beeps will sound.

See *Lane Departure Warning (LDW)* on page 9-44.

### Side Blind Zone Alert (SBZA)

If equipped, SBZA will detect vehicles in the next lane over in the vehicle's side blind zone area. When this happens, the SBZA display will light up in the corresponding outside side mirror and will flash if the turn signal is on.

See *Side Blind Zone Alert (SBZA)* on page 9-42.

### Rear Vision Camera (RVC)

If equipped, RVC displays a view of the area behind the vehicle, on the center stack display, when the vehicle is shifted into R (Reverse).

See *Assistance Systems for Parking or Backing* on page 9-36.

### Ultrasonic Parking Assist

If equipped, Ultrasonic Rear Parking Assist (URPA) uses sensors on the rear bumper to assist with parking and avoiding objects while in R (Reverse). It operates at speeds less than 8 km/h (5 mph). URPA uses audible beeps to provide distance and system information.

The vehicle may also be equipped with Front Parking Assist.

See *Driver Assistance Systems* on page 9-35.

### Automatic Parking Assist (APA)

If equipped, the APA system helps to search for and maneuver the vehicle into parallel parking spots using automatic steering, DIC displays, and beeps. When the vehicle speed is below 30 km/h (18 mph), press the APA button,  to enable the system.

See the “Automatic Parking Assist (APA)” information under *Assistance Systems for Parking or Backing on page 9-36*.

### Power Outlets

The accessory power outlets can be used to plug in electrical equipment, such as a cell phone or MP3 player.

The vehicle has an accessory power outlet on the center stack and inside the center console storage.

To use the outlet, the ignition must be in ON/RUN or ACC/ACCESSORY. Remove the cover to access the outlet and replace when not in use.

See *Power Outlets on page 5-4*.

### Sunroof

If equipped, the sunroof switches are on the overhead console. The ignition must be in ON/RUN or ACC/ACCESSORY, or in Retained Accessory Power (RAP) to operate the sunroof. See *Ignition Positions on page 9-15* and *Retained Accessory Power (RAP) on page 9-18*.



**Open/Close:** Press and hold the front or rear of the switch (1) to open or close the sunroof. The sunshade automatically opens with the sunroof, but must be closed manually.

**Express Open:** Press and release the front of the switch (1) to express-open the sunroof.

**Vent/Close:** Press and hold the rear of the switch (2) to vent the sunroof. Press and hold the front of the switch (2) to close.

The sunroof cannot be opened or closed if the vehicle has an electrical failure.

### Anti-Pinch Feature

If an object is in the path of the sunroof when it is closing, the anti-pinch feature detects the object and stops the sunroof from closing at the point of the obstruction. The sunroof then returns to the full-open position.



See *Sunroof* on page 2-20.



## Performance and Maintenance

### Traction Control/ Electronic Stability Control

The traction control system limits wheel spin. The system turns on automatically every time the vehicle is started.

The StabiliTrak system assists with directional control of the vehicle in difficult driving conditions. The system turns on automatically every time the vehicle is started.

- To turn off traction control, press and release the TCS/StabiliTrak button  on the center console.  illuminates in the instrument cluster.
- Press and release the TCS/StabiliTrak button again to turn on traction control.

- To turn off both traction control and StabiliTrak, press and hold the TCS/StabiliTrak button  on the center console, until  and  illuminate in the instrument cluster.
- Press and release the TCS/StabiliTrak button again to turn on both systems.

See *Traction Control/Electronic Stability Control* on page 9-30.

### Tire Pressure Monitor

This vehicle may have a Tire Pressure Monitor System (TPMS).



The low tire pressure warning light alerts to a significant loss in pressure of one of the vehicle's tires. If the warning light comes on,

stop as soon as possible and inflate the tires to the recommended pressure shown on the Tire and Loading Information label. See *Vehicle Load Limits* on page 9-10. The warning light will remain on until the tire pressure is corrected.

The low tire pressure warning light may come on in cool weather when the vehicle is first started, and then turn off as the vehicle is driven. This may be an early indicator that the tire pressures are getting low and the tires need to be inflated to the proper pressure.

The TPMS does not replace normal monthly tire maintenance. Maintain the correct tire pressures.

See *Tire Pressure Monitor System* on page 10-42.

### Engine Oil Life System

The engine oil life system calculates engine oil life based on vehicle use and displays the CHANGE ENGINE OIL SOON message when it is time to change the engine oil and filter.

The oil life system should be reset to 100% only following an oil change.

#### Resetting the Oil Life System

1. Display the REMAINING OIL LIFE on the DIC. See *Driver Information Center (DIC)* on page 5-21.
2. Press and hold the SET/CLR button on the DIC while the Oil Life display is active. The oil life will change to 100%.

The oil life system can also be reset as follows:

1. Turn the ignition to ON/RUN with the engine off.
2. Fully press and release the accelerator pedal three times within five seconds.

See *Engine Oil Life System* on page 10-8.

### Driving for Better Fuel Economy

Driving habits can affect fuel mileage. Here are some driving tips to get the best fuel economy possible.

- Avoid fast starts and accelerate smoothly.
- Brake gradually and avoid abrupt stops.
- Avoid idling the engine for long periods of time.
- When road and weather conditions are appropriate, use cruise control.
- Always follow posted speed limits or drive more slowly when conditions require.
- Keep vehicle tires properly inflated.
- Combine several trips into a single trip.

- Replace the vehicle's tires with the same TPC Spec number molded into the tire's sidewall near the size.
- Follow recommended scheduled maintenance.

## Battery

The battery is located in the trunk, behind a trim panel, on the driver side. When it is time for a new battery, see your dealer for one that has the replacement number shown on the original battery's label.

See *Battery on page 10-20*.

## Roadside Assistance Program

U.S.: 1-800-243-8872

TTY Users (U.S. Only):  
1-888-889-2438

As the owner of a new Chevrolet, you are automatically enrolled in the Roadside Assistance program.

See *Roadside Assistance Program on page 13-5*.

## OnStar®

If equipped, this vehicle has a comprehensive, in-vehicle system that can connect to a live Advisor for Emergency, Security, Navigation, Connection, and Diagnostic Services. See *OnStar Overview on page 14-1*.





# Keys, Doors, and Windows

## Keys and Locks

- Keys ..... 2-1
- Remote Keyless Entry (RKE) System ..... 2-2
- Remote Keyless Entry (RKE) System Operation ..... 2-3
- Remote Vehicle Start ..... 2-8
- Door Locks ..... 2-10
- Power Door Locks ..... 2-11
- Delayed Locking ..... 2-11
- Automatic Door Locks ..... 2-11
- Lockout Protection ..... 2-11
- Safety Locks ..... 2-12

## Doors

- Trunk ..... 2-12

## Vehicle Security

- Vehicle Security ..... 2-14
- Vehicle Alarm System ..... 2-14
- Immobilizer ..... 2-15
- Immobilizer Operation ..... 2-15

## Exterior Mirrors

- Convex Mirrors ..... 2-16
- Power Mirrors ..... 2-16
- Folding Mirrors ..... 2-17
- Heated Mirrors ..... 2-17
- Automatic Dimming Mirror ... 2-17
- Reverse Tilt Mirrors ..... 2-17

## Interior Mirrors

- Interior Rearview Mirrors ..... 2-17
- Automatic Dimming Rearview Mirror ..... 2-17

## Windows

- Windows ..... 2-18
- Power Windows ..... 2-18
- Sun Visors ..... 2-19

## Roof

- Sunroof ..... 2-20

# Keys and Locks

## Keys

 **Warning**

Leaving children in a vehicle with the ignition key is dangerous and children or others could be seriously injured or killed. They could operate the power windows or other controls or make the vehicle move. The windows will function with the keys in the ignition, and children or others could be caught in the path of a closing window. Do not leave children in a vehicle with the ignition key.

## 2-2 Keys, Doors, and Windows



The key that is part of the Remote Keyless Entry (RKE) transmitter can be used for all locks.



Press the button on the RKE transmitter to extend the key. Press the button to retract the key.

See your dealer if a new key is needed.

If it becomes difficult to turn the key, inspect the key blade for debris. Periodically clean with a brush or pick.

If locked out of the vehicle, see *Roadside Assistance Program on page 13-5*.

With an active OnStar subscription, an OnStar Advisor may remotely unlock the vehicle. See *OnStar Overview on page 14-1*.

### Remote Keyless Entry (RKE) System

See *Radio Frequency Statement on page 13-15*.

If there is a decrease in the RKE operating range:

- Check the distance. The transmitter may be too far from the vehicle.
- Check the location. Other vehicles or objects may be blocking the signal.
- Check the transmitter's battery. See "Battery Replacement" later in this section.
- If the transmitter is still not working correctly, see your dealer or a qualified technician for service.

## Remote Keyless Entry (RKE) System Operation

The RKE transmitter may work up to 60 m (197 ft) away from the vehicle.

Other conditions can affect the performance of the transmitter. See *Remote Keyless Entry (RKE) System on page 2-2*.

The RKE transmitter can have one of these two symbols for the remote trunk release.



**🔒 (Lock):** Press to lock all doors. The turn signal indicators may flash and/or the horn may sound to indicate locking. See “Remote Lock Feedback” under *Vehicle Personalization on page 5-33*. If a passenger door is open when 🔒 is pressed, all doors lock. If the driver door is open when 🔒 is pressed, all doors lock except the driver door. These settings can be modified. See “Open Door Anti Lock Out” under *Vehicle Personalization on page 5-33*.

Pressing 🔒 may also arm the theft-deterrent system. See *Vehicle Alarm System on page 2-14*.

**🔓 (Unlock):** Press to unlock the driver door or all doors. See “Remote Door Unlock” under *Vehicle Personalization on page 5-33*. The turn signal indicators flash to indicate unlocking has occurred. See “Remote Unlock Feedback” under *Vehicle Personalization on page 5-33*.



Pressing 🔓 may also disarm the theft-deterrent system. See *Vehicle Alarm System on page 2-14*.

**🚗 or HOLD (Remote Trunk Release):** Press and hold until the trunk begins to move.

**📡 (Vehicle Locator/Panic Alarm):** Press and release one time to initiate vehicle locator. The exterior lamps flash and the horn chirps three times. Press and hold 📡 for at least three seconds to sound the panic alarm. The horn sounds and the turn signals flash

## 2-4 Keys, Doors, and Windows

until  is pressed again or the key is placed in the ignition and turned to ON/RUN.

 **(Remote Vehicle Start):** Press and release  then immediately press and hold  for at least four seconds to start the engine from outside the vehicle using the RKE transmitter. See *Remote Vehicle Start on page 2-8*.

### Keyless Access Operation

Some vehicles have a Keyless Access system that lets you lock and unlock the doors without removing the RKE transmitter from your pocket, purse, briefcase, etc. The RKE transmitter should be within 1 m (3 ft) of the door being opened. If the vehicle has this feature, there will be buttons on the outside door handles.

The vehicle can be customized to always unlock all doors on the first lock/unlock button press. See *Vehicle Personalization on page 5-33*.

### Keyless Unlocking/Locking from the Driver Door

When the doors are locked and the RKE transmitter is within 1 m (3 ft) of the driver door handle, pressing the lock/unlock button on the driver door handle will unlock the driver door. If the lock/unlock button is pressed again within five seconds, all passenger doors will unlock. Pull the door handle to unlatch the door.

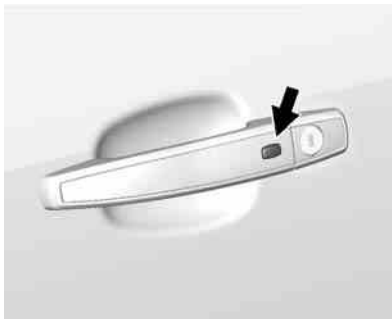

Pressing the lock/unlock button will cause all doors to lock if any of the following occur:

- It has been more than five seconds since the first lock/unlock button press.
- Two lock/unlock button presses were used to unlock all doors.
- Any vehicle door has been opened and all doors are now closed.

### Keyless Unlocking/Locking from the Passenger Doors

When the doors are locked and the RKE transmitter is within 1 m (3 ft) of the door handle, pressing the lock/unlock button on a passenger door handle will unlock all doors. Pressing the lock/unlock button will cause all doors to lock if any of the following occur:



- The lock/unlock button was used to unlock all doors.

- Any vehicle door has been opened and all doors are now closed.

### Passive Locking

This feature will lock the vehicle several seconds after all doors are closed, if the vehicle is off and at least one RKE transmitter has been removed from the interior or none remain in the interior.

### Temporary Disable of Passive Locking Feature

Temporarily disable the passive locking by pressing and holding  on the interior door switch with a door open for at least four seconds, or until three chimes are heard. Passive locking will then remain disabled until  on the interior door is pressed, or until the vehicle is turned on.

To customize the doors to automatically lock when exiting the vehicle, see “Remote Lock/Unlock/Start” under *Vehicle Personalization* on page 5-33.

### Keyed Access

To access a vehicle with a dead transmitter battery, see *Door Locks* on page 2-10.

### Programming Transmitters to the Vehicle

Only RKE transmitters programmed to the vehicle will work. If a transmitter is lost or stolen, a replacement can be purchased and programmed through your dealer. The vehicle can be reprogrammed so that lost or stolen transmitters no longer work. Any remaining transmitters will need to be reprogrammed. Each vehicle can have up to eight transmitters matched to it.

### Programming with a Recognized Transmitter

A new transmitter can be programmed to the vehicle when there is one recognized transmitter. To program, the vehicle must be off

and all of the transmitters, both currently recognized and new, must be with you.

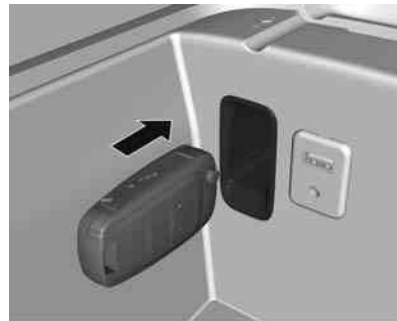

- Place the recognized transmitter in the transmitter pocket. The transmitter pocket is inside the center console storage area.

## 2-6 Keys, Doors, and Windows

---

2. Insert the new vehicle key into the key lock cylinder on the driver door handle and turn the key, counterclockwise, to the unlock position five times within 10 seconds.

The Driver Information Center (DIC) displays READY FOR REMOTE #2, 3, 4 or 5.

3. Remove the recognized transmitter and place the new transmitter into the transmitter pocket.
4. Press the ENGINE START/STOP button. When the transmitter is learned, the DIC will show that it is ready to program the next transmitter.

5. Remove the transmitter from the transmitter pocket and press .

To program additional transmitters, repeat Steps 3–5.

When all additional transmitters are programmed, press and hold the ENGINE START/STOP button for 10 seconds to exit programming mode.

### **Programming without a Recognized Transmitter**

If there are no currently recognized transmitters available, follow this procedure to program up to eight transmitters. This procedure will take approximately 30 minutes to complete. The vehicle must be off and all of the transmitters you wish to program must be with you.

1. Insert the vehicle key into the key lock cylinder on the driver door handle and turn the key, counterclockwise, to the unlock position five times within 10 seconds.

The Driver Information Center (DIC) displays REMOTE LEARN PENDING, PLEASE WAIT.

2. Wait for 10 minutes until the DIC displays PRESS ENGINE START BUTTON TO LEARN and then press the ENGINE START/STOP button.

The DIC displays will again show REMOTE LEARN PENDING, PLEASE WAIT.

- Repeat Step 2 two additional times. After the third time, all previously known transmitters will no longer work with the vehicle. Remaining transmitters can be relearned during the next steps.

The DIC display should now show READY FOR REMOTE # 1.

- Place the new transmitter into the transmitter pocket. The transmitter pocket is inside the center console storage area.
- Press the ENGINE START/STOP button. When the transmitter is learned the DIC will show that it is ready to program the next transmitter.

- Remove the transmitter from the transmitter pocket and press .

To program additional transmitters, repeat Steps 4–6.

When all additional transmitters are programmed, press and hold the ENGINE START/STOP button for 10 seconds to exit programming mode.

### Starting the Vehicle with a Low Transmitter Battery

If the transmitter battery is weak, the DIC may display NO REMOTE DETECTED when you try to start the vehicle. The REPLACE BATTERY IN REMOTE KEY message may also be displayed at this time.

To start the vehicle:

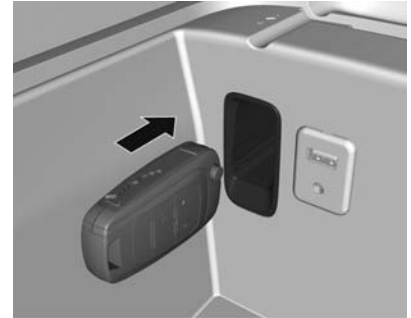

- Open the center console storage and place the transmitter in the transmitter pocket.
- With the vehicle in P (Park) or N (Neutral), press the brake pedal and press the ENGINE START/STOP button.

See *Starting the Engine* on page 9-17

Replace the transmitter battery as soon as possible.

## 2-8 Keys, Doors, and Windows

### Battery Replacement

Replace the battery if the REPLACE BATTERY IN REMOTE KEY message displays in the DIC. See *Key and Lock Messages on page 5-29*.

#### Caution

When replacing the battery, do not touch any of the circuitry on the transmitter. Static from your body could damage the transmitter.

The battery is not rechargeable. To replace the battery:



1. Press the button on the transmitter to extend the key.
2. Remove the battery cover by prying with a finger.
3. Remove the battery by pushing on the battery and sliding it toward the key blade.
4. Insert the new battery, positive side facing up. Push the battery down until it is held in place. Replace with a CR2032 or equivalent battery.

5. Snap the battery cover back on to the transmitter.

### Remote Vehicle Start

Remote start allows the engine to be started from outside the vehicle.

**Ⓚ (Remote Vehicle Start):** The remote start button is on the RKE transmitter.

The climate control system will use the previous settings during a remote start.



Laws in some local communities may restrict the use of remote starters. For example, some laws require a person using remote start to have the vehicle in view. Check local regulations for any requirements.

Other conditions can affect the performance of the transmitter. See *Remote Keyless Entry (RKE) System on page 2-2*.



### Starting the Vehicle

To start the engine using the remote start feature:

1. Aim the RKE transmitter at the vehicle.
2. Press and release .
3. Immediately after completing Step 2, press and hold  for at least four seconds or until the turn signal lamps flash. The turn signal lamps flashing confirms the request to remote start the vehicle has been received.

When the engine starts, the parking lamps will turn on and remain on as long as the engine is running. The doors will be locked and the climate control system may come on.

The engine will continue to run for 10 minutes. Repeat the steps to extend to 20 minutes. Remote start can be extended only once.

Start the vehicle before driving.

### Extending Engine Run Time

To extend to 20 minutes, repeat Steps 1–3 while the engine is still running. The remote start can be extended once.

For example, if the engine has been running for five minutes, and the remote start is extended, the engine will run for a total of 20 minutes.

A maximum of two remote starts, or a single start with an extension, is allowed between ignition cycles.

The vehicle's ignition must be turned on and then back off before the remote start procedure can be used again.

### Canceling a Remote Start

To cancel a remote start, do one of the following:

- Aim the RKE transmitter at the vehicle and press and hold  until the parking lamps turn off.
- Turn on the hazard warning flashers.

- Turn the vehicle on and then off.

### Conditions in Which Remote Start Will Not Work

The remote vehicle start feature will not operate if:

- The vehicle is unlocked.
- The hood is not closed.
- The hazard warning flashers are on.
- The malfunction indicator lamp is on.
- The engine coolant temperature is too high.
- The oil pressure is low.
- Two remote vehicle starts, or a single remote start with an extension, have already been used.
- The vehicle is not in P (Park).

### Door Locks

#### Warning

Unlocked doors can be dangerous.

- Passengers, especially children, can easily open the doors and fall out of a moving vehicle. When a door is locked, the handle will not open it. The chance of being thrown out of the vehicle in a crash is increased if the doors are not locked. So, all passengers should wear safety belts properly and the doors should be locked whenever the vehicle is driven.
- Young children who get into unlocked vehicles may be unable to get out. A child can be overcome by extreme heat and can suffer permanent



(Continued)

#### Warning (Continued)



injuries or even death from heat stroke. Always lock the vehicle whenever leaving it.

- Outsiders can easily enter through an unlocked door when you slow down or stop the vehicle. Locking the doors can help prevent this from happening.

To lock or unlock the doors from the outside:

- Press  or  on the Remote Keyless Entry (RKE) transmitter. See *Remote Keyless Entry (RKE) System Operation on page 2-3*.
- Use the key in the driver door. Turn the key toward the rear to lock all doors. Turn the key toward the front to unlock the driver door. Turn the key again toward the front to unlock all doors.

To lock or unlock the doors from the inside:

- Pushing down the manual lock knob on the driver door will lock all doors. Pushing down the manual lock knob on a passenger door will lock that door only.
- Pull the door handle once to unlock the door. Pulling the handle again unlatches the door.
- Press  or  on the power door lock switch.

## Power Door Locks

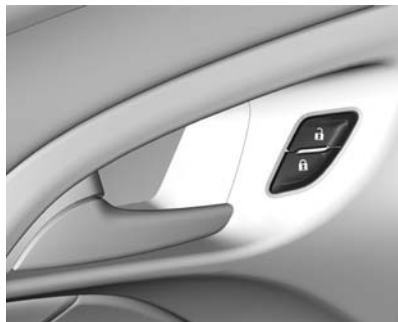

**🔓 (Unlock):** Press to unlock the doors.

**🔒 (Lock):** Press to lock the doors.

## Delayed Locking

This feature will delay the actual locking of the doors and arming of the theft-deterrent system for five seconds when the door lock switch or Remote Keyless Entry (RKE) transmitter is used to lock the vehicle.

If any door is open when locking the vehicle, three chimes will signal that the delayed locking feature is active. Five seconds after the last door is closed, all of the doors will lock. To cancel the delay and lock the doors immediately, press **🔒** on the RKE transmitter or the power door lock switch a second time. The theft-deterrent system will arm after 30 seconds.

## Automatic Door Locks

The vehicle is programmed to lock all doors automatically when the following are met:

- All doors are closed.
- The ignition is on.
- The vehicle is shifted out of P (Park).

All doors will unlock when the vehicle is shifted into P (Park).

## Lockout Protection

If the vehicle is in ACC/ACCESSORY or ON/RUN/START and the power door lock switch is pressed with the driver door open, all the doors will lock and only the driver door will unlock.



If Open Door Anti Lockout is turned on and the vehicle is off, the driver door is open, and locking is requested, all the doors will lock and only the driver door will unlock. The Open Door Anti Lockout feature can be turned on or off using the vehicle personalization menus. See *Vehicle Personalization on page 5-33*.

Lockout Protection can be manually overridden with the driver door open by pressing and holding **🔒** on the power door lock switch.



### Safety Locks



The rear door safety locks prevent passengers from opening the rear doors from inside the vehicle.

Press   to activate the safety locks on the rear doors. The indicator light in the switch will illuminate when activated.

The rear door power windows are also disabled. See *Power Windows* on page 2-18.

Press   again to deactivate the lockout switch.

If an inside rear door handle is being pulled when the safety lock is deactivated, that door will remain locked and the indicator light may flash. Release the handle, then press the safety lock twice to deactivate the safety locks.

### Doors

#### Trunk

#### Warning

Exhaust gases can enter the vehicle if it is driven with the liftgate or trunk/hatch open, or with any objects that pass through the seal between the body and the trunk/hatch or liftgate. Engine exhaust contains carbon monoxide (CO) which cannot be seen or smelled. It can cause unconsciousness and even death.

If the vehicle must be driven with the liftgate or trunk/hatch open:

- Close all of the windows.
- Fully open the air outlets on or under the instrument panel.

(Continued)

**Warning (Continued)**

- Adjust the climate control system to a setting that brings in only outside air and set the fan speed to the highest setting. See “Climate Control Systems” in the Index.
- If the vehicle is equipped with a power liftgate, disable the power liftgate function.

See *Engine Exhaust* on page 9-21.

**Trunk Release**

To open the trunk the vehicle must be off or the shift lever must be in P (Park).

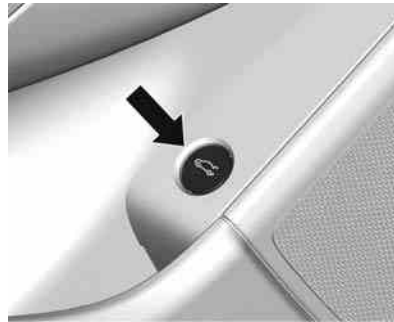

From inside the vehicle, press  on the driver door.

**Remote Trunk Release**

From outside the vehicle, press and hold  or **HOLD** on the RKE transmitter.

**Emergency Trunk Release Handle**

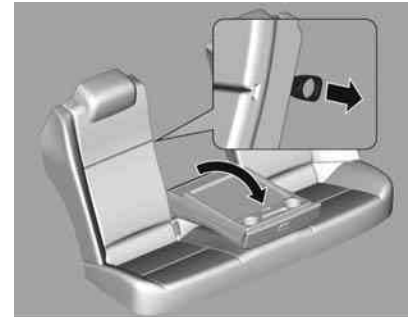

 **Caution**

Do not use the emergency trunk release handle as a tie-down or anchor point when securing items in the trunk as it could damage the handle.

The emergency trunk release handle is behind the center rear seat. To access, press the button at the top of the center seat to unlock

## 2-14 Keys, Doors, and Windows

---

the seatback and fold down. Pull the release handle sideways to open the trunk from the inside.

### Vehicle Security

This vehicle has theft-deterrent features; however, they do not make the vehicle impossible to steal.

### Vehicle Alarm System

This vehicle has an anti-theft alarm system.

The security light, on the instrument panel near the windshield, indicates the status of the system:

**Off:** Alarm system is disarmed.

**On Solid:** Vehicle is secured during the delay to arm the system.

**Fast Flash:** Vehicle is unsecured. A door, the hood, or the trunk is open.

**Slow Flash:** Alarm system is armed.

### Arming the Alarm System

1. Turn off the vehicle.

2. Lock the vehicle with one of the following:

- Use the RKE transmitter.
- With a door open, press  on the interior of the door.

3. After 30 seconds the alarm system will arm, and the indicator light will begin to slowly flash indicating the alarm system is operating. Pressing  on the RKE transmitter a second time will bypass the 30-second delay and immediately arm the alarm system.

The vehicle alarm system will not arm if the doors are locked with the key.

If the driver door is opened without first unlocking with the RKE transmitter, the horn will chirp and the lights will flash to indicate a pre-alarm. If the vehicle is not started, or the door is not unlocked by pressing  on the RKE

transmitter during the 10-second pre-alarm, the alarm will be activated.

The alarm will also be activated if the passenger door, the trunk, or the hood is opened without first disarming the system. When the alarm is activated, the turn signals flash and the horn sounds for about 30 seconds. The alarm system will then re-arm to monitor for the next unauthorized event.

### Disarming the System

To disarm the system, do one of the following:

- Press  on the RKE transmitter.
- Start the engine.

### To avoid setting off the alarm by accident:

- Lock the vehicle with the RKE transmitter after all occupants have exited.

- Always unlock the vehicle with the RKE transmitter, or use the Keyless Access system. Unlocking the driver door with the key will not disarm the system or turn off the alarm.

## Immobilizer

See *Radio Frequency Statement on page 13-15.*

### Immobilizer Operation

This vehicle has a passive theft-deterrent system.

The system does not have to be manually armed or disarmed.

The immobilizer activates itself automatically after the key has been removed from the ignition switch, if equipped with Keyless Access, when the engine is switched off by pressing the ENGINE START/STOP button.

The system checks whether the vehicle is allowed to start with the key used. If the transponder in the key is recognized, the vehicle can be started.



The security light in the instrument cluster comes on when there is a problem with arming or disarming the theft-deterrent system.

The system has one or more transmitters matched to an immobilizer control unit in your vehicle. Only a correctly matched transmitter will start the vehicle. If the transmitter is ever damaged, you may not be able to start your vehicle.

When trying to start the vehicle, the security light comes on briefly when the ignition is turned on.

## 2-16 Keys, Doors, and Windows

If the vehicle does not start and the security light stays on, there is a problem with the system. Turn the vehicle off and try again.

If the RKE transmitter appears to be undamaged, try another transmitter or if equipped with Keyless Access, place the transmitter in the transmitter pocket in the center console. See “Starting the Vehicle with a Low Transmitter Battery” under *Remote Keyless Entry (RKE) System Operation* on page 2-3.

If the vehicle does not start with the other transmitter or when the transmitter is in the pocket in the center console, see your dealer.

Do not leave the transmitter that disarms or deactivates the theft-deterrent system, in the vehicle.

## Exterior Mirrors

### Convex Mirrors

#### Warning

A convex mirror can make things, like other vehicles, look farther away than they really are. If you cut too sharply into the right lane, you could hit a vehicle on the right. Check the inside mirror or glance over your shoulder before changing lanes.

The passenger side mirror is convex shaped. A convex mirror's surface is curved so more can be seen from the driver seat.

## Power Mirrors



To adjust the mirrors:

1. With the ignition on, press the switch (2) to select the left or right mirror.
2. Press the arrows (1) to adjust the mirror.
3. Adjust the mirror to see a little of the vehicle, and the area behind the vehicle.

Keep the switch (2) in the center when not adjusting the mirrors.



## Folding Mirrors

### Manual Folding Mirrors

The vehicle has manual folding mirrors. These mirrors can be folded inward to prevent damage when going through an automatic car wash. To fold, pull the mirror toward the vehicle. Push the mirror outward to return it to the original position.

### Heated Mirrors

The vehicle has heated outside rearview mirrors.

 **(Rear Window Defogger):**  
Press to heat the mirrors.

See *Dual Automatic Climate Control System* on page 8-1.

### Automatic Dimming Mirror

The driver outside mirror automatically adjusts for the glare of headlamps behind you.

## Reverse Tilt Mirrors

If equipped with memory seats, the outside mirrors have a reverse tilt feature. This feature tilts the outside mirrors to a preselected position when the vehicle is in R (Reverse). This allows the driver to view the curb for parallel parking. The mirrors return to their original position when the vehicle is shifted out of R (Reverse), the ignition is turned off, or if the vehicle reverse speed exceeds 10 km/h (6 mph).

This feature can be turned on or off through the Driver Information Center (DIC). See *Vehicle Personalization* on page 5-33. See *Memory Seats* on page 3-5.

## Interior Mirrors

### Interior Rearview Mirrors

Adjust the rearview mirror for a clear view of the area behind your vehicle.

If equipped with OnStar, there are three buttons at the bottom of the mirror. See your dealer for more information on the system and how to subscribe to OnStar. See *OnStar Overview* on page 14-1.

Do not spray glass cleaner directly on the mirror. Use a soft towel dampened with water.

### Automatic Dimming Rearview Mirror

The rearview mirror automatically dims to reduce the glare of the headlamps from behind. This feature comes on when the vehicle is started.

### Windows

#### Warning

Never leave a child, a helpless adult, or a pet alone in a vehicle, especially with the windows closed in warm or hot weather. They can be overcome by the extreme heat and suffer permanent injuries or even death from heat stroke.



### Power Windows

#### Warning

Children could be seriously injured or killed if caught in the path of a closing window. Never leave keys in a vehicle with children. When there are children in the rear seat, use the window lockout button to prevent operation of the windows. See *Keys on page 2-1*.



The power window switches on the driver door control all the windows. Each passenger door has a switch that controls only that window.

Power window switches work when the ignition is in ON/RUN, ACC/ACCESSORY, or Retained Accessory Power (RAP). See *Retained Accessory Power (RAP) on page 9-18*.

Press the switch to lower the window. Pull the switch to raise the window.

#### Express Window Operation

Windows with an express-down or express-up feature allow the window to be lowered or raised without holding the switch. Pull a window switch up or press it down all the way, release it, and the window goes up or down automatically. Stop the window by pressing or pulling the switch in the same direction a second time, or by briefly operating the switch to the first detent in either direction.

### Express Window Anti-Pinch Feature

If an object is in the path of the window when the express-up is active, the window will stop at the obstruction and auto-reverse to a preset factory position. Weather conditions such as severe icing may cause the window to auto-reverse. The window will return to normal operation after the obstruction or condition is removed.

### Rear Window Lockout



Press  to prevent rear seat passengers from operating the windows. The indicator light illuminates when on. Press again to turn the feature off. This also activates the safety locks on the rear passenger doors.

### Programming the Power Windows

If the battery on the vehicle has been recharged or disconnected and the windows cannot be closed automatically, a warning message will display in the Driver Information Center (DIC). To reprogram the windows:

1. The ignition must be in ON/RUN or ACC/ACCESSORY, or Retained Accessory Power (RAP).
2. Press and hold the power window switch until the window is fully open.

3. Pull the power window switch up until the window is fully closed and keep holding the switch up for an additional two seconds.
4. Repeat for each window.

### Sun Visors

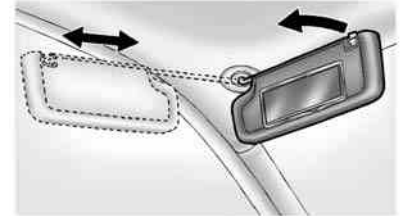

Pull the sun visor down to block glare. If equipped, detach the sun visor from the center mount to pivot to the side window or to extend along the rod.

### Roof

#### Sunroof

On vehicles with a sunroof, the switches used to operate it are on the overhead console. The ignition must be in ON/RUN or ACC/ACCESSORY, or in Retained Accessory Power (RAP) to operate the sunroof. See *Ignition Positions* on page 9-15 and *Retained Accessory Power (RAP)* on page 9-18.



**Open/Close:** Press and hold the front or rear of the switch (1) to open or close the sunroof. The sunshade automatically opens with the sunroof, but must be closed manually.

**Express Open/Close:** Press and release the front or rear of the switch (1) to express-open or express-close the sunroof.

**Vent/Close:** Press and hold the rear of the switch (2) to vent the sunroof. Press and hold the front of the switch (2) to close.

The sunroof cannot be opened or closed if the vehicle has an electrical failure.

#### Anti-Pinch Feature

If an object is in the path of the sunroof when it is closing, the anti-pinch feature detects the object and stops the sunroof from closing at the point of the obstruction. The sunroof then returns to the full-open position.



Dirt and debris may collect on the sunroof seal or in the track. This could cause an issue with sunroof operation or noise. It could also plug the water drainage system. Periodically open the sunroof and remove any obstacles or loose debris. Wipe the sunroof seal and roof sealing area using a clean cloth, mild soap, and water. Do not remove grease from the sunroof.

## Seats and Restraints

### Head Restraints

Head Restraints ..... 3-2

### Front Seats

Power Seat Adjustment ..... 3-3  
 Lumbar Adjustment ..... 3-4  
 Reclining Seatbacks ..... 3-4  
 Memory Seats ..... 3-5  
 Heated and Ventilated Front  
 Seats ..... 3-6

### Rear Seats

Rear Seat  
 Pass-Through Door ..... 3-7

### Safety Belts

Safety Belts ..... 3-8  
 How to Wear Safety Belts  
 Properly ..... 3-9

Lap-Shoulder Belt ..... 3-10  
 Safety Belt Use During  
 Pregnancy ..... 3-12  
 Safety Belt Extender ..... 3-12  
 Safety System Check ..... 3-12  
 Safety Belt Care ..... 3-13  
 Replacing Safety Belt System  
 Parts after a Crash ..... 3-13

### Airbag System

Airbag System ..... 3-14  
 Where Are the Airbags? .... 3-15  
 When Should an Airbag  
 Inflate? ..... 3-17  
 What Makes an Airbag  
 Inflate? ..... 3-18  
 How Does an Airbag  
 Restrain? ..... 3-18  
 What Will You See after an  
 Airbag Inflates? ..... 3-19  
 Passenger Sensing  
 System ..... 3-20

Servicing the Airbag-Equipped  
 Vehicle ..... 3-24  
 Adding Equipment to the  
 Airbag-Equipped Vehicle ... 3-25  
 Airbag System Check ..... 3-25  
 Replacing Airbag System  
 Parts after a Crash ..... 3-26

### Child Restraints

Older Children ..... 3-26  
 Infants and Young  
 Children ..... 3-28  
 Child Restraint Systems .... 3-31  
 Where to Put the Restraint ... 3-32  
 Lower Anchors and Tethers  
 for Children (LATCH  
 System) ..... 3-34  
 Replacing LATCH System  
 Parts After a Crash ..... 3-39  
 Securing Child Restraints  
 (Rear Seat) ..... 3-39  
 Securing Child Restraints  
 (Front Passenger Seat) .... 3-41

### Head Restraints

#### Front Seats

 **Warning**

With head restraints that are not installed and adjusted properly, there is a greater chance that occupants will suffer a neck/spinal injury in a crash. Do not drive until the head restraints for all occupants are installed and adjusted properly.

The vehicle's front seats have adjustable head restraints in the outboard seating positions.



Adjust the head restraint so that the top of the restraint is at the same height as the top of the occupant's head. This position reduces the chance of a neck injury in a crash.

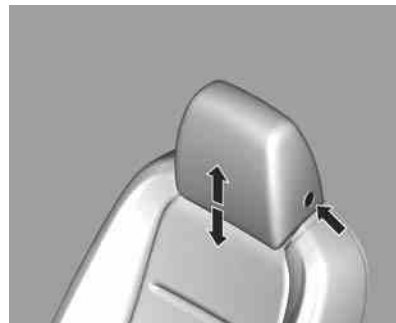

To raise or lower the head restraint, press the button located on the side of the head restraint, and pull up or push the head restraint down, and release the button. Pull and push on the head restraint after the button is released to make sure that it is locked in place.

The front seat outboard head restraints are not designed to be removed.

### Rear Seats

The vehicle's rear seats have head restraints in the outboard seating positions that cannot be adjusted.

The rear seat outboard head restraints are not designed to be removed.

### Front Seats

#### Power Seat Adjustment

**⚠ Warning**

You can lose control of the vehicle if you try to adjust a driver seat while the vehicle is moving. Adjust the driver seat only when the vehicle is not moving.



To adjust the seat:

- Move the seat forward or rearward by sliding the control forward or rearward.
- Raise or lower the seat by moving the rear of the control up or down.
- Raise or lower the front part of the seat cushion by moving the front of the control up or down.

To adjust the seatback, see *Reclining Seatbacks on page 3-4*.

To adjust the lumbar support, see *Lumbar Adjustment on page 3-4*.

## 3-4 Seats and Restraints

### Lumbar Adjustment

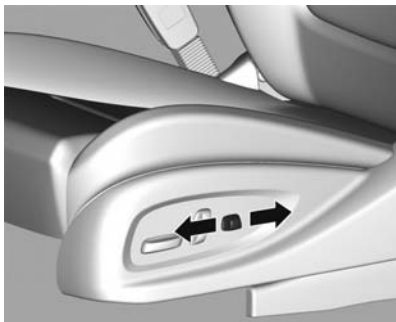

To increase or decrease lumbar support, slide the control forward or rearward.

### Reclining Seatbacks

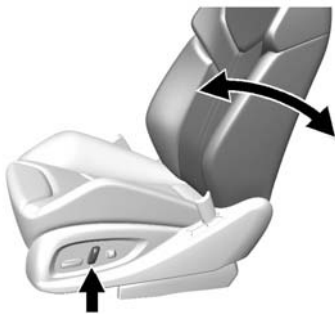

To adjust the seatback:

- Tilt the top of the control rearward to recline.
- Tilt the top of the control forward to raise.

### Warning

Sitting in a reclined position when the vehicle is in motion can be dangerous. Even when buckled up, the safety belts cannot do their job.

The shoulder belt will not be against your body. Instead, it will be in front of you. In a crash, you could go into it, receiving neck or other injuries.

The lap belt could go up over your abdomen. The belt forces would be there, not at your pelvic bones. This could cause serious internal injuries.

For proper protection when the vehicle is in motion, have the seatback upright. Then sit well back in the seat and wear the safety belt properly.





Do not have a seatback reclined if the vehicle is moving.

## Memory Seats

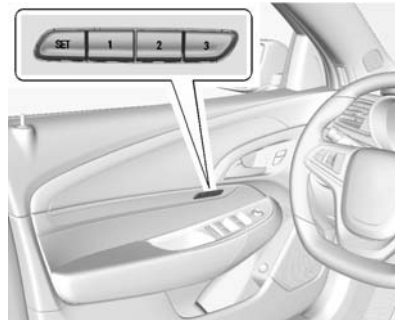

The SET, "1," "2," and "3" buttons on the driver door are used to manually save and recall memory settings for the driver seat and outside mirrors. These manually stored positions are referred to as Button Memory positions.

## Storing Button Memory Positions

To save positions into Button Memory for the "1," "2," or "3" driving positions:

1. Adjust the driver seat and outside mirrors to the desired driving positions.
2. Press and release SET, then immediately press and hold "1" until a beep sounds.
3. Repeat Steps 1 and 2 for a second driver using "2" and/or a third driver using "3."

## Recalling Button Memory Positions

Press and hold "1," "2," or "3" to recall the manually saved Button Memory positions. Releasing "1," "2," or "3" before the stored positions are reached stops the recall.

If the ignition is in ON/RUN/START and the vehicle is parked, briefly press and release "1," "2," or "3" to recall the Button Memory positions.

## 3-6 Seats and Restraints

Turning the vehicle off before the stored positions are reached stops the recall.

If something has blocked the driver seat while recalling a memory position, the recall may stop. Remove the obstruction; then press and hold the appropriate manual control for the memory item that is not recalling for two seconds. Try recalling the memory position again by pressing the appropriate memory button. If the memory position is still not recalling, see your dealer for service.

### Heated and Ventilated Front Seats

#### Warning

If you cannot feel temperature change or pain to the skin, the seat heater may cause burns. To reduce the risk of burns, people with such a condition should use



(Continued)

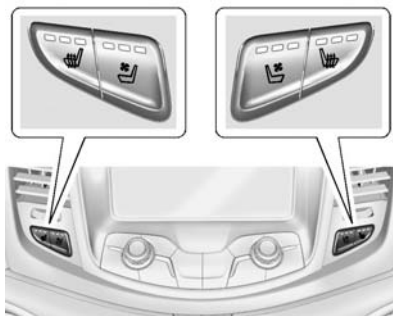

#### Warning (Continued)

care when using the seat heater, especially for long periods of time. Do not place anything on the seat that insulates against heat, such as a blanket, cushion, cover, or similar item. This may cause the seat heater to overheat. An overheated seat heater may cause a burn or may damage the seat.



The buttons are below the air vents on the center stack. To operate, the engine must be running.

Press  or  to heat the driver or passenger seat.

Press  or  to ventilate the driver or passenger seat. A ventilated seat has a fan that pulls or pushes air through the seat. The air is not cooled.

Press the button once for the highest setting. With each press of the button, the seat will change to the next lower setting, and then to the off setting. The indicator lights on the buttons indicate three for the highest setting and one for the lowest. If the heated seats are on high, the level may automatically be lowered after approximately 30 minutes.

The passenger seat may take longer to heat up.

### Remote Start Heated and Ventilated Seats

During a remote start, the heated or ventilated seats can be turned on automatically. When it is cold outside, the heated seats turn on, and when it is hot outside the ventilated seats turn on. The heated or ventilated seats are canceled when the ignition is turned on. Press the heated or ventilated seat button to use the heated or ventilated seats after the vehicle is started.

The heated or ventilated seat indicator lights do not turn on during a remote start.

The temperature performance of an unoccupied seat may be reduced. This is normal.

The heated or ventilated seats will not turn on during a remote start unless they are enabled in the vehicle personalization menu. See *Remote Vehicle Start* on page 2-8 and *Vehicle Personalization* on page 5-33.

## Rear Seats

### Rear Seat Pass-Through Door

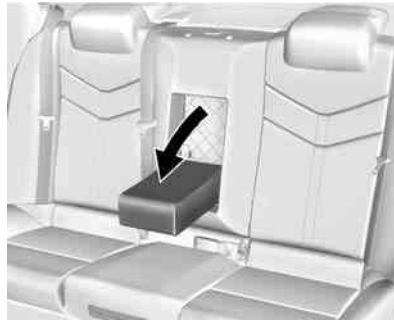

The rear seat has an armrest in the center of the seatback. Pull the armrest down to lower it. To fold, lift the armrest up and push it rearward until it is flush with the seatback.



The rear seat has a rear seat pass-through door in the center of the rear seatback. Press the button on top of the seatback and fold the center part of the seatback down to access the trunk. There are two cupholders on the door. To close, lift the pass-through door and push it rearward until it locks into place.

### Safety Belts

This section of the manual describes how to use safety belts properly. It also describes some things not to do with safety belts.

#### Warning

Do not let anyone ride where a safety belt cannot be worn properly. In a crash, if you or your passenger(s) are not wearing safety belts, injuries can be much worse than if you are wearing safety belts. You can be seriously injured or killed by hitting things inside the vehicle harder or by being ejected from the vehicle. In addition, anyone who is not buckled up can strike other passengers in the vehicle.

(Continued)

#### Warning (Continued)

It is extremely dangerous to ride in a cargo area, inside or outside of a vehicle. In a collision, passengers riding in these areas are more likely to be seriously injured or killed. Do not allow passengers to ride in any area of the vehicle that is not equipped with seats and safety belts.

Always wear a safety belt, and check that all passenger(s) are restrained properly too.

This vehicle has indicators as a reminder to buckle the safety belts. See *Safety Belt Reminders* on page 5-9.

### Why Safety Belts Work



When riding in a vehicle, you travel as fast as the vehicle does. If the vehicle stops suddenly, you keep going until something stops you. It could be the windshield, the instrument panel, or the safety belts!

When you wear a safety belt, you and the vehicle slow down together. There is more time to stop because you stop over a longer distance and, when worn properly, your strongest bones take the forces from the

safety belts. That is why wearing safety belts makes such good sense.

### Questions and Answers About Safety Belts

**Q: Will I be trapped in the vehicle after a crash if I am wearing a safety belt?**

**A:** You *could* be — whether you are wearing a safety belt or not. Your chance of being conscious during and after a crash, so you *can* unbuckle and get out, is *much* greater if you are belted.

**Q: If my vehicle has airbags, why should I have to wear safety belts?**

**A:** Airbags are supplemental systems only; so they work *with* safety belts — not instead of them. Whether or not an airbag is provided, all occupants still have to buckle up to get the most protection.

Also, in nearly all states and in all Canadian provinces, the law requires wearing safety belts.

### How to Wear Safety Belts Properly

This section is only for people of adult size.

There are special things to know about safety belts and children. And there are different rules for smaller children and infants. If a child will be riding in the vehicle, see *Older Children on page 3-26* or *Infants and Young Children on page 3-28*. Follow those rules for everyone's protection.

It is very important for all occupants to buckle up. Statistics show that unbelted people are hurt more often in crashes than those who are wearing safety belts.

There are important things to know about wearing a safety belt properly.

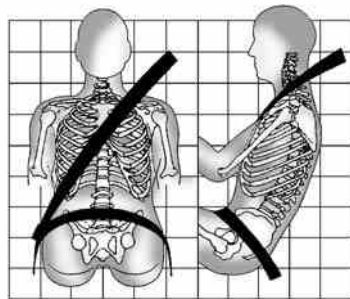

- Sit up straight and always keep your feet on the floor in front of you.
- Always use the correct buckle for your seating position.
- Wear the lap part of the belt low and snug on the hips, just touching the thighs. In a crash, this applies force to the strong pelvic bones and you would be less likely to slide under the lap belt. If you slid under it, the belt would apply force on your abdomen. This could cause serious or even fatal injuries.

## 3-10 Seats and Restraints

- Wear the shoulder belt over the shoulder and across the chest. These parts of the body are best able to take belt restraining forces. The shoulder belt locks if there is a sudden stop or crash.

### Warning

You can be seriously injured, or even killed, by not wearing your safety belt properly.

- Never allow the lap or shoulder belt to become loose or twisted.
- Never wear the shoulder belt under both arms or behind your back.
- Never route the lap or shoulder belt over an armrest.

### Lap-Shoulder Belt

All seating positions in the vehicle have a lap-shoulder belt.

The following instructions explain how to wear a lap-shoulder belt properly.

- Adjust the seat, if the seat is adjustable, so you can sit up straight. To see how, see “Seats” in the Index.

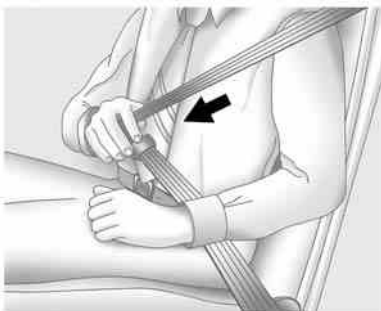

- Pick up the latch plate and pull the belt across you. Do not let it get twisted.

The lap-shoulder belt may lock if you pull the belt across you very quickly. If this happens, let the belt go back slightly to unlock it. Then pull the belt across you more slowly.

If the shoulder portion of a rear seat passenger belt is pulled out all the way, the child restraint locking feature may be engaged. If this happens, let the belt go back all the way and start again.



If the webbing locks in the latch plate before it reaches the buckle, tilt the latch plate flat to unlock.

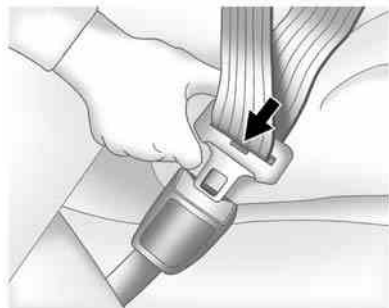

3. Push the latch plate into the buckle until it clicks.

Pull up on the latch plate to make sure it is secure. If the belt is not long enough, see *Safety Belt Extender* on page 3-12.

Position the release button on the buckle so that the safety belt could be quickly unbuckled if necessary.



4. To make the lap part tight, pull up on the shoulder belt.



To unlatch the belt, push the button on the buckle. The belt should return to its stowed position.

Before a door is closed, be sure the safety belt is out of the way. If a door is slammed against a safety belt, damage can occur to both the safety belt and the vehicle.

### Safety Belt Pretensioners

This vehicle has safety belt pretensioners for the front outboard occupants. Although the safety belt pretensioners cannot be seen, they are part of the safety belt assembly. They can help tighten the safety belts during the early stages of a moderate to severe frontal, near-frontal, or rear crash if the threshold conditions for pretensioner activation are met. And, if the vehicle has side impact airbags, safety belt pretensioners can help tighten the safety belts in a side crash or a rollover event.

Pretensioners work only once. If the pretensioners activate in a crash, the pretensioners and probably

## 3-12 Seats and Restraints

---

other parts of the vehicle's safety belt system will need to be replaced. See *Replacing Safety Belt System Parts after a Crash* on page 3-13.

### Safety Belt Use During Pregnancy

Safety belts work for everyone, including pregnant women. Like all occupants, they are more likely to be seriously injured if they do not wear safety belts.



A pregnant woman should wear a lap-shoulder belt, and the lap portion should be worn as low as possible, below the rounding, throughout the pregnancy.

The best way to protect the fetus is to protect the mother. When a safety belt is worn properly, it is more likely that the fetus will not be hurt in a crash. For pregnant women, as for anyone, the key to making safety belts effective is wearing them properly.

### Safety Belt Extender

If the vehicle's safety belt will fasten around you, you should use it.

But if a safety belt is not long enough, your dealer will order you an extender. When you go in to order it, take the heaviest coat you will wear, so the extender will be long enough for you. To help avoid personal injury, do not let someone else use it, and use it only for the seat it is made to fit. The extender has been designed for adults. Never

use it for securing child seats. To wear it, attach it to the regular safety belt. See the instruction sheet that comes with the extender.

### Safety System Check

Now and then, check that the safety belt reminder light, safety belts, buckles, latch plates, retractors, and anchorages are all working properly. Look for any other loose or damaged safety belt system parts that might keep a safety belt system from doing its job. See your dealer to have it repaired. Torn or frayed safety belts may not protect you in a crash. They can rip apart under impact forces. If a belt is torn or frayed, get a new one right away.

Make sure the safety belt reminder light is working. See *Safety Belt Reminders* on page 5-9.

Keep safety belts clean and dry. See *Safety Belt Care* on page 3-13.



## Safety Belt Care

Keep belts clean and dry.

### Warning

Do not bleach or dye safety belts. It may severely weaken them. In a crash, they might not be able to provide adequate protection. Clean safety belts only with mild soap and lukewarm water.

## Replacing Safety Belt System Parts after a Crash

### Warning

A crash can damage the safety belt system in the vehicle. A damaged safety belt system may not properly protect the person using it, resulting in serious injury or even death in a  
(Continued)

### Warning (Continued)

crash. To help make sure the safety belt systems are working properly after a crash, have them inspected and any necessary replacements made as soon as possible.

After a minor crash, replacement of safety belts may not be necessary. But the safety belt assemblies that were used during any crash may have been stressed or damaged. See your dealer to have the safety belt assemblies inspected or replaced.

New parts and repairs may be necessary even if the safety belt system was not being used at the time of the crash.

Have the safety belt pretensioners checked if the vehicle has been in a crash, or if the airbag readiness light stays on after you start the vehicle or while you are driving. See *Airbag Readiness Light on page 5-10*.

### Airbag System

The vehicle has the following airbags:

- A frontal airbag for the driver.
- A frontal airbag for the front outboard passenger.
- A knee airbag for the driver.
- A knee airbag for the front outboard passenger.
- A seat-mounted side impact airbag for the driver.
- A seat-mounted side impact airbag for the front outboard passenger.
- A roof-rail airbag for the driver and the passenger seated directly behind the driver.
- A roof-rail airbag for the front outboard passenger and the passenger seated directly behind the front outboard passenger.

All vehicle airbags have the word AIRBAG on the trim or on a label near the deployment opening.

For frontal airbags, the word AIRBAG is on the center of the steering wheel for the driver and on the instrument panel for the front outboard passenger.

For knee airbags, the word AIRBAG is on the lower part of the instrument panel.

For seat-mounted side impact airbags, the word AIRBAG is on the side of the seatback closest to the door.

For roof-rail airbags, the word AIRBAG is on the ceiling or trim.

Airbags are designed to supplement the protection provided by safety belts. Even though today's airbags are also designed to help reduce the risk of injury from the force of an inflating bag, all airbags must inflate very quickly to do their job.

Here are the most important things to know about the airbag system:



#### Warning

You can be severely injured or killed in a crash if you are not wearing your safety belt, even with airbags. Airbags are designed to work with safety belts, not replace them. Also, airbags are not designed to inflate in every crash. In some crashes safety belts are the only restraint. See *When Should an Airbag Inflate?* on page 3-17.

Wearing your safety belt during a crash helps reduce the chance of hitting things inside the vehicle or being ejected from it. Airbags are "supplemental restraints" to the safety belts. Everyone in the vehicle should wear a safety belt properly, whether or not there is an airbag for that person.

**⚠ Warning**

Because airbags inflate with great force and faster than the blink of an eye, anyone who is up against, or very close to any airbag when it inflates can be seriously injured or killed. Do not sit unnecessarily close to any airbag, as you would be if sitting on the edge of the seat or leaning forward. Safety belts help keep you in position before and during a crash. Always wear a safety belt, even with airbags. The driver should sit as far back as possible while still maintaining control of the vehicle.

Occupants should not lean on or sleep against the door or side windows in seating positions with seat-mounted side impact airbags and/or roof-rail airbags.

**⚠ Warning**

Children who are up against, or very close to, any airbag when it inflates can be seriously injured or killed. Always secure children properly in the vehicle. To read how, see *Older Children on page 3-26* or *Infants and Young Children on page 3-28*.



There is an airbag readiness light on the instrument cluster, which shows the airbag symbol. The system checks the airbag electrical system for malfunctions. The light tells you if there is an electrical problem. See *Airbag Readiness Light on page 5-10*.

**Where Are the Airbags?**

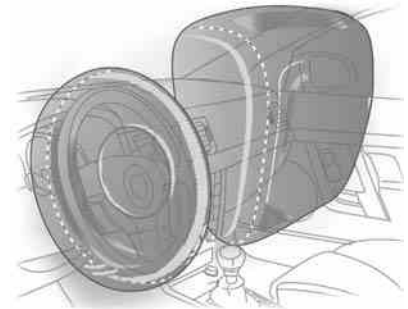

The driver frontal airbag is in the center of the steering wheel.

The front outboard passenger frontal airbag is in the passenger side instrument panel.

## 3-16 Seats and Restraints

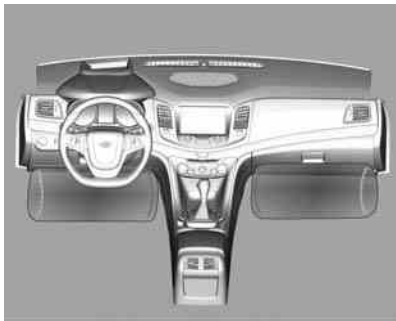

The driver knee airbag is below the steering column. The front outboard passenger knee airbag is below the glove box.

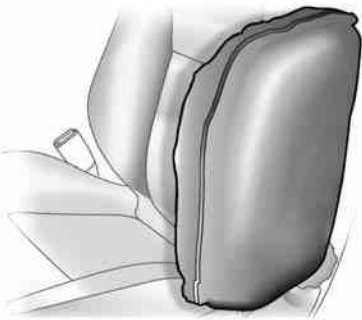

**Driver Side Shown, Passenger Side Similar**

The seat-mounted side impact airbags for the driver and front outboard passenger are in the side of the seatbacks closest to the door.

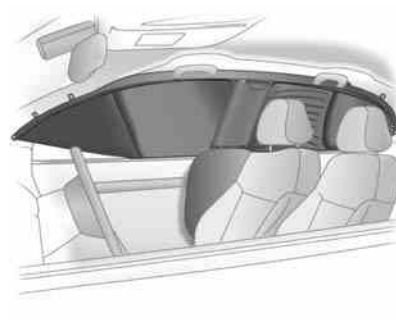

**Passenger Side Shown, Driver Side Similar**

The roof-rail airbags for the driver, front outboard passenger, and second row outboard passengers are in the ceiling above the side windows.

 **Warning**

If something is between an occupant and an airbag, the airbag might not inflate properly or it might force the object into

(Continued)

**Warning (Continued)**

that person causing severe injury or even death. The path of an inflating airbag must be kept clear. Do not put anything between an occupant and an airbag, and do not attach or put anything on the steering wheel hub or on or near any other airbag covering.

Do not use seat accessories that block the inflation path of a seat-mounted side impact airbag.

Never secure anything to the roof of a vehicle with roof-rail airbags by routing a rope or tie-down through any door or window opening. If you do, the path of an inflating roof-rail airbag will be blocked.

**When Should an Airbag Inflate?**

This vehicle is equipped with airbags. See *Airbag System on page 3-14*. Airbags are designed to inflate if the impact exceeds the specific airbag system's deployment threshold. Deployment thresholds are used to predict how severe a crash is likely to be in time for the airbags to inflate and help restrain the occupants. The vehicle has electronic frontal sensors that help the airbag system determine the severity of the impact. Deployment thresholds can vary with specific vehicle design.

Frontal airbags are designed to inflate in moderate to severe frontal or near-frontal crashes to help reduce the potential for severe injuries, mainly to the driver's or front outboard passenger's head and chest.

Whether the frontal airbags will or should inflate is not based primarily on how fast the vehicle is traveling.

It depends on what is hit, the direction of the impact, and how quickly the vehicle slows down.

Frontal airbags may inflate at different crash speeds depending on whether the vehicle hits an object straight on or at an angle, and whether the object is fixed or moving, rigid or deformable, narrow or wide.

Frontal airbags are not intended to inflate during vehicle rollovers, in rear impacts, or in many side impacts.

In addition, the vehicle has advanced technology frontal airbags. Advanced technology frontal airbags adjust the restraint according to crash severity.

The vehicle also has seat position sensors that enable the sensing system to monitor the position of the driver seat and the front outboard passenger seat. Seat position sensors provide information that is used to adjust the deployment of the frontal airbags.

## 3-18 Seats and Restraints

---

Knee airbags are designed to inflate in moderate to severe frontal impacts. Knee airbags are not designed to inflate during vehicle rollovers, in rear impacts, or in many side impacts.

Seat-mounted side impact airbags are designed to inflate in moderate to severe side crashes, depending on the location of the impact.

Seat-mounted side impact airbags are not designed to inflate in frontal impacts, near-frontal impacts, rollovers, or rear impacts.

A seat-mounted side impact airbag is designed to inflate on the side of the vehicle that is struck.

Roof-rail airbags are designed to inflate in moderate to severe side crashes, depending on the location of the impact. In addition, these roof-rail airbags are designed to inflate during a rollover or in a severe frontal impact. Roof-rail airbags are not designed to inflate in rear impacts. Both roof-rail airbags will inflate when either side of the vehicle is struck or if the sensing

system predicts that the vehicle is about to roll over on its side, or in a severe frontal impact.

In any particular crash, no one can say whether an airbag should have inflated simply because of the vehicle damage or repair costs.

### What Makes an Airbag Inflate?

In a deployment event, the sensing system sends an electrical signal triggering a release of gas from the inflator. Gas from the inflator fills the airbag causing the bag to break out of the cover. The inflator, the airbag, and related hardware are all part of the airbag module.

For airbag locations, see *Where Are the Airbags?* on page 3-15.

### How Does an Airbag Restrain?

In moderate to severe frontal or near frontal collisions, even belted occupants can contact the steering

wheel or the instrument panel. In moderate to severe side collisions, even belted occupants can contact the inside of the vehicle.

Airbags supplement the protection provided by safety belts by distributing the force of the impact more evenly over the occupant's body.

Rollover capable roof-rail airbags are designed to help contain the head and chest of occupants in the outboard seating positions in the first and second rows. The rollover capable roof-rail airbags are designed to help reduce the risk of full or partial ejection in rollover events, although no system can prevent all such ejections.

But airbags would not help in many types of collisions, primarily because the occupant's motion is not toward those airbags. See *When Should an Airbag Inflate?* on page 3-17.

Airbags should never be regarded as anything more than a supplement to safety belts.

### What Will You See after an Airbag Inflates?

After the frontal airbags and seat-mounted side impact airbags inflate, they quickly deflate, so quickly that some people may not even realize an airbag inflated. Roof-rail airbags may still be at least partially inflated for some time after they inflate. Some components of the airbag module may be hot for several minutes. For location of the airbags, see *Where Are the Airbags?* on page 3-15.

The parts of the airbag that come into contact with you may be warm, but not too hot to touch. There may be some smoke and dust coming from the vents in the deflated airbags. Airbag inflation does not prevent the driver from seeing out of

the windshield or being able to steer the vehicle, nor does it prevent people from leaving the vehicle.

 **Warning**

When an airbag inflates, there may be dust in the air. This dust could cause breathing problems for people with a history of asthma or other breathing trouble. To avoid this, everyone in the vehicle should get out as soon as it is safe to do so. If you have breathing problems but cannot get out of the vehicle after an airbag inflates, then get fresh air by opening a window or a door. If you experience breathing problems following an airbag deployment, you should seek medical attention.

The vehicle has a feature that may automatically unlock the doors, turn on the interior lamps, turn on the hazard warning flashers, and shut

off the fuel system after the airbags inflate. You can lock the doors, turn off the interior lamps, and turn off the hazard warning flashers by using the controls for those features.

 **Warning**

A crash severe enough to inflate the airbags may have also damaged important functions in the vehicle, such as the fuel system, brake and steering systems, etc. Even if the vehicle appears to be drivable after a moderate crash, there may be concealed damage that could make it difficult to safely operate the vehicle.

Use caution if you should attempt to restart the engine after a crash has occurred.

In many crashes severe enough to inflate the airbag, windshields are broken by vehicle deformation.

## 3-20 Seats and Restraints

Additional windshield breakage may also occur from the front outboard passenger airbag.

- Airbags are designed to inflate only once. After an airbag inflates, you will need some new parts for the airbag system. If you do not get them, the airbag system will not be there to help protect you in another crash. A new system will include airbag modules and possibly other parts. The service manual for the vehicle covers the need to replace other parts.
- The vehicle has a crash sensing and diagnostic module which records information after a crash. See *Vehicle Data Recording and Privacy on page 13-13* and *Event Data Recorders on page 13-14*.
- Let only qualified technicians work on the airbag systems. Improper service can mean that

an airbag system will not work properly. See your dealer for service.

### Passenger Sensing System

The vehicle has a passenger sensing system for the front outboard passenger position. The passenger airbag status indicator will light in the rearview mirror when the vehicle is started.



The words ON and OFF will be visible during the system check. When the system check is complete, either the word ON or OFF will be visible. See *Passenger Airbag Status Indicator on page 5-11*.

The passenger sensing system turns off the front outboard passenger frontal airbag and knee airbag under certain conditions. No other airbag is affected by the passenger sensing system.

The passenger sensing system works with sensors that are part of the front outboard passenger seat. The sensors are designed to detect the presence of a properly-seated occupant and determine if the front outboard passenger frontal airbag and knee airbag should be allowed to inflate or not.

According to accident statistics, children are safer when properly secured in a rear seat in the correct child restraint for their weight and size.

Whenever possible, children age 12 and under should be secured in a rear seating position.

Never put a rear-facing child seat in the front. This is because the risk to the rear-facing child is so great, if the airbag inflates.



 **Warning**

A child in a rear-facing child restraint can be seriously injured or killed if the passenger frontal airbag inflates. This is because the back of the rear-facing child restraint would be very close to the inflating airbag. A child in a forward-facing child restraint can be seriously injured or killed if the passenger frontal airbag inflates and the passenger seat is in a forward position.

Even if the passenger sensing system has turned off the front outboard passenger airbag(s), no system is fail-safe. No one can guarantee that an airbag will not inflate under some unusual circumstance, even though the airbag(s) are off.

(Continued)

**Warning (Continued)**

Secure rear-facing child restraints in a rear seat, even if the airbag(s) are off. If you secure a forward-facing child restraint in the front outboard passenger seat, always move the seat as far back as it will go. It is better to secure the child restraint in a rear seat.

The passenger sensing system is designed to turn off the front outboard passenger airbag and knee airbag if:

- The front outboard passenger seat is unoccupied.
- The system determines that an infant is present in a child restraint.
- A front outboard passenger takes his/her weight off of the seat for a period of time.

- There is a critical problem with the airbag system or the passenger sensing system.

When the passenger sensing system has turned off the front outboard passenger frontal airbag and knee airbag, the off indicator will light and stay lit to remind you that the airbags are off. See *Passenger Airbag Status Indicator on page 5-11*.

The passenger sensing system is designed to turn on the front outboard passenger frontal airbag and knee airbag anytime the system senses that a person of adult size is sitting properly in the front outboard passenger seat.

When the passenger sensing system has allowed the airbags to be enabled, the on indicator will light and stay lit as a reminder that the airbags are active.

For some children, including children in child restraints, and for very small adults, the passenger sensing system may or may not turn

## 3-22 Seats and Restraints

off the front outboard passenger frontal airbag and knee airbag, depending upon the person's seating posture and body build. Everyone in the vehicle who has outgrown child restraints should wear a safety belt properly — whether or not there is an airbag for that person.

### **Warning**

If the airbag readiness light ever comes on and stays on, it means that something may be wrong with the airbag system. To help avoid injury to yourself or others, have the vehicle serviced right away. See *Airbag Readiness Light* on page 5-10 for more information, including important safety information.

### **If the On Indicator Is Lit for a Child Restraint**

The passenger sensing system is designed to turn off the front outboard passenger frontal airbag and knee airbag if the system determines that an infant is present in a child restraint. If a child restraint has been installed and the on indicator is lit:

1. Turn the vehicle off.
2. Remove the child restraint from the vehicle.
3. Remove any additional items from the seat such as blankets, cushions, seat covers, seat heaters, or seat massagers.
4. Reinstall the child restraint following the directions provided by the child restraint manufacturer and refer to *Securing Child Restraints (Rear Seat)* on page 3-39 or *Securing Child Restraints (Front Passenger Seat)* on page 3-41.
5. If, after reinstalling the child restraint and restarting the vehicle, the on indicator is still lit, turn the vehicle off. Then slightly recline the vehicle seatback and adjust the seat cushion, if adjustable, to make sure that the vehicle seatback is not pushing the child restraint into the seat cushion.  
  
Also make sure the child restraint is not trapped under the vehicle head restraint. If this happens, adjust the head restraint. See *Head Restraints* on page 3-2.
6. Restart the vehicle.  
  
The passenger sensing system may or may not turn off the airbags for a child in a child restraint depending upon the child's size. It is better to secure a child restraint in a rear seat.

**If the Off Indicator Is Lit for an Adult-Sized Occupant**



If a person of adult-size is sitting in the front outboard passenger seat, but the off indicator is lit, it could be because that person is not sitting properly in the seat. Use the following steps to allow the system to detect that person and enable the front outboard passenger frontal and knee airbags:

1. Turn the vehicle off.

2. Remove any additional material from the seat, such as blankets, cushions, seat covers, seat heaters, or seat massagers. Also remove laptops or other electronic devices.
3. Place the seatback in the fully upright position.
4. Have the person sit upright in the seat, centered on the seat cushion, with legs comfortably extended.
5. Restart the vehicle and have the person remain in this position for two to three minutes after the on indicator is lit.

**Warning**

If the front outboard passenger airbag is turned off for an adult-sized occupant, the airbag will not be able to inflate and help protect that person in a crash, resulting in an increased risk of

(Continued)

**Warning (Continued)**

serious injury or even death. An adult-sized occupant should not ride in the front outboard passenger seat, if the passenger airbag off indicator is lit.

**Additional Factors Affecting System Operation**

Safety belts help keep the passenger in position on the seat during vehicle maneuvers and braking, which helps the passenger sensing system maintain the passenger airbag status. See “Safety Belts” and “Child Restraints” in the Index for additional information about the importance of proper restraint use.

A thick layer of additional material, such as a blanket or cushion, or aftermarket equipment such as seat covers, seat heaters, and seat massagers can affect how well the passenger sensing system

## 3-24 Seats and Restraints

operates. We recommend that you not use seat covers or other aftermarket equipment except when approved by GM for your specific vehicle. See *Adding Equipment to the Airbag-Equipped Vehicle on page 3-25* for more information about modifications that can affect how the system operates.

A wet seat can affect the performance of the passenger sensing system. Here's how:

- The passenger sensing system may turn off the passenger airbag when liquid is soaked into the seat. If this happens, the off indicator will be lit, and the airbag readiness light will also be lit.
- Liquid pooled on the seat that has not soaked in may make it more likely that the passenger sensing system will turn on the passenger airbag while a child restraint or child occupant is on

the seat. If the passenger airbag is turned on, the on indicator will be lit.

If the front passenger seat gets wet, dry it immediately. If the airbag readiness light is lit, do not install a child restraint or allow anyone to occupy the seat. See *Airbag Readiness Light on page 5-10* for important safety information.

The on indicator may be lit if an object, such as a briefcase, handbag, grocery bag, laptop, or other electronic device, is put on an unoccupied seat. If this is not desired, remove the object from the seat.

### Warning

Stowing of articles under the passenger seat or between the passenger seat cushion and seatback may interfere with the proper operation of the passenger sensing system.

## Servicing the Airbag-Equipped Vehicle

Airbags affect how the vehicle should be serviced. There are parts of the airbag system in several places around the vehicle. Your dealer and the service manual have information about servicing the vehicle and the airbag system. To purchase a service manual, see *Service Publications Ordering Information on page 13-11*.

### Warning

For up to 10 seconds after the vehicle is turned off and the battery is disconnected, an airbag can still inflate during improper service. You can be injured if you are close to an airbag when it inflates. Avoid yellow connectors. They are probably part of the airbag system. Be sure to follow

(Continued)

**Warning (Continued)**

proper service procedures, and make sure the person performing work for you is qualified to do so.

## Adding Equipment to the Airbag-Equipped Vehicle

Adding accessories that change the vehicle's frame, bumper system, height, front end or side sheet metal, may keep the airbag system from working properly. The operation of the airbag system can also be affected by changing or moving any parts of the front seats, safety belts, the airbag sensing and diagnostic module, steering wheel, instrument panel, any airbag module, ceiling or pillar garnish trim, the inside rearview mirror, front sensors, side impact sensors, or airbag wiring.

Your dealer and the service manual have information about the location of the airbag sensors, sensing and diagnostic module, and airbag wiring.

In addition, the vehicle has a passenger sensing system for the front outboard passenger seat. The passenger sensing system may not operate properly if the original seat trim is replaced with non-GM covers, upholstery or trim, or with GM covers, upholstery or trim designed for a different vehicle. Any object, such as an aftermarket seat heater or a comfort enhancing pad or device, installed under or on top of the seat fabric, could also interfere with the operation of the passenger sensing system. This could either prevent proper deployment of the passenger airbag(s) or prevent the passenger sensing system from properly turning off the passenger airbag(s). See *Passenger Sensing System* on page 3-20.

If the vehicle has rollover roof-rail airbags, see *Different Size Tires and Wheels* on page 10-50 for additional important information.

If you have to modify your vehicle because you have a disability and have questions about whether the modifications will affect the vehicle's airbag system, or if you have questions about whether the airbag system will be affected if the vehicle is modified for any other reason, call Customer Assistance. See *Customer Assistance Offices* on page 13-3.

## Airbag System Check

The airbag system does not need regularly scheduled maintenance or replacement. Make sure the airbag readiness light is working. See *Airbag Readiness Light* on page 5-10.

### Caution

If an airbag covering is damaged, opened, or broken, the airbag may not work properly. Do not open or break the airbag coverings. If there are any opened or broken airbag coverings, have the airbag covering and/or airbag module replaced. For the location of the airbags, see *Where Are the Airbags?* on page 3-15. See your dealer for service.

## Replacing Airbag System Parts after a Crash

### Warning

A crash can damage the airbag systems in the vehicle.

A damaged airbag system may not work properly and may not

(Continued)

### Warning (Continued)

protect you and your passenger(s) in a crash, resulting in serious injury or even death. To help make sure the airbag systems are working properly after a crash, have them inspected and any necessary replacements made as soon as possible.

If an airbag inflates, you will need to replace airbag system parts. See your dealer for service.

If the airbag readiness light stays on after the vehicle is started or comes on when you are driving, the airbag system may not work properly. Have the vehicle serviced right away. See *Airbag Readiness Light* on page 5-10.

## Child Restraints

### Older Children

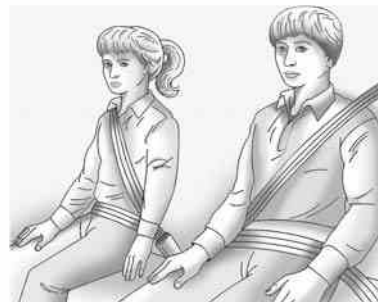

Older children who have outgrown booster seats should wear the vehicle safety belts.

The manufacturer's instructions that come with the booster seat state the weight and height limitations for that booster. Use a booster seat with a lap-shoulder belt until the child passes the fit test below:

- Sit all the way back on the seat. Do the knees bend at the seat edge? If yes, continue. If no, return to the booster seat.
- Buckle the lap-shoulder belt. Does the shoulder belt rest on the shoulder? If yes, continue. If no, return to the booster seat.
- Does the lap belt fit low and snug on the hips, touching the thighs? If yes, continue. If no, return to the booster seat.
- Can proper safety belt fit be maintained for the length of the trip? If yes, continue. If no, return to the booster seat.

**Q: What is the proper way to wear safety belts?**

**A:** An older child should wear a lap-shoulder belt and get the additional restraint a shoulder belt can provide. The shoulder belt should not cross the face or neck. The lap belt should fit snugly below the hips, just touching the top of the thighs. This applies belt force to the child's pelvic bones in a crash. It should never be worn over the abdomen, which could cause severe or even fatal internal injuries in a crash.

According to accident statistics, children are safer when properly restrained in a rear seating position.

In a crash, children who are not buckled up can strike other people who are buckled up, or can be thrown out of the vehicle. Older children need to use safety belts properly.

**Warning**

Never allow more than one child to wear the same safety belt. The safety belt cannot properly spread the impact forces. In a crash, they can be crushed together and seriously injured. A safety belt must be used by only one person at a time.



### Warning

Never allow a child to wear the safety belt with the shoulder belt behind their back. A child can be seriously injured by not wearing the lap-shoulder belt properly. In a crash, the child would not be restrained by the shoulder belt. The child could move too far forward increasing the chance of head and neck injury. The child might also slide under the lap belt. The belt force would then be applied right on the abdomen. That could cause serious or fatal injuries. The shoulder belt should go over the shoulder and across the chest.



### Infants and Young Children

Everyone in a vehicle needs protection! This includes infants and all other children. Neither the distance traveled nor the age and size of the traveler changes the need, for everyone, to use safety restraints. In fact, the law in every state in the United States and in every Canadian province says children up to some age must be restrained while in a vehicle.

### Warning

Children can be seriously injured or strangled if a shoulder belt is wrapped around their neck and the safety belt continues to tighten. Never leave children unattended in a vehicle and never allow children to play with the safety belts.

Every time infants and young children ride in vehicles, they should have the protection provided by appropriate child restraints. Neither the vehicle's safety belt system nor its airbag system is designed for them.

Children who are not restrained properly can strike other people, or can be thrown out of the vehicle.



**⚠ Warning**

Never hold an infant or a child while riding in a vehicle. Due to crash forces, an infant or a child will become so heavy it is not possible to hold it during a crash. For example, in a crash at only 40 km/h (25 mph), a 5.5 kg (12 lb) infant will suddenly become a 110 kg (240 lb) force on a person's arms. An infant should be secured in an appropriate restraint.



**⚠ Warning**

Children who are up against, or very close to, any airbag when it inflates can be seriously injured or killed. Never put a rear-facing child restraint in the right front seat. Secure a rear-facing child restraint in a rear seat. It is also better to secure a forward-facing child restraint in a rear seat. If you must secure a forward-facing child restraint in the right front

(Continued)

**Warning (Continued)**

seat, always move the front passenger seat as far back as it will go.



**Q: What are the different types of add-on child restraints?**

**A:** Add-on child restraints, which are purchased by the vehicle owner, are available in four basic types. Selection of a particular restraint should take into consideration not only the child's

## 3-30 Seats and Restraints

weight, height, and age but also whether or not the restraint will be compatible with the motor vehicle in which it will be used.

For most basic types of child restraints, there are many different models available. When purchasing a child restraint, be sure it is designed to be used in a motor vehicle. If it is, the restraint will have a label saying that it meets federal motor vehicle safety standards.

The restraint manufacturer instructions that come with the restraint state the weight and height limitations for a particular child restraint. In addition, there are many kinds of restraints available for children with special needs.

### **Warning**

To reduce the risk of neck and head injury during a crash, infants need complete support. In a crash, if an infant is in a rear-facing child restraint, the crash forces can be distributed across the strongest part of an infant's body, the back and shoulders. Infants should always be secured in rear-facing child restraints.

### **Warning**

A young child's hip bones are still so small that the vehicle's regular safety belt may not remain low on the hip bones, as it should. Instead, it may settle up around the child's abdomen. In a crash, the belt would apply force on a body area that is unprotected by

(Continued)

### **Warning (Continued)**

any bony structure. This alone could cause serious or fatal injuries. To reduce the risk of serious or fatal injuries during a crash, young children should always be secured in appropriate child restraints.

## Child Restraint Systems



### Rear-Facing Infant Seat

A rear-facing infant seat provides restraint with the seating surface against the back of the infant.

The harness system holds the infant in place and, in a crash, acts to keep the infant positioned in the restraint.



### Forward-Facing Child Seat

A forward-facing child seat provides restraint for the child's body with the harness.

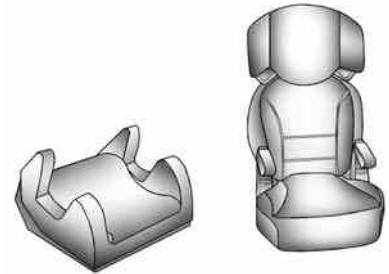

### Booster Seats

A booster seat is a child restraint designed to improve the fit of the vehicle's safety belt system. A booster seat can also help a child to see out the window.

### Securing an Add-On Child Restraint in the Vehicle

#### Warning

A child can be seriously injured or killed in a crash if the child restraint is not properly secured in the vehicle. Secure the child restraint properly in the vehicle using the vehicle safety belt or LATCH system, following the instructions that came with that child restraint and the instructions in this manual.

To help reduce the chance of injury, the child restraint must be secured in the vehicle. Child restraint systems must be secured in vehicle seats by lap belts or the lap belt portion of a lap-shoulder belt, or by the LATCH system. See *Lower Anchors and Tethers for Children (LATCH System)* on page 3-34.

Children can be endangered in a crash if the child restraint is not properly secured in the vehicle.

When securing an add-on child restraint, refer to the instructions that come with the restraint which may be on the restraint itself or in a booklet, or both, and to this manual. The child restraint instructions are important, so if they are not available, obtain a replacement copy from the manufacturer.

Keep in mind that an unsecured child restraint can move around in a collision or sudden stop and injure people in the vehicle. Be sure to properly secure any child restraint in the vehicle — even when no child is in it.

In some areas of the United States and Canada, Certified Child Passenger Safety Technicians (CPSTs) are available to inspect and demonstrate how to correctly use and install child restraints. In the U.S., refer to the National Highway Traffic Safety

Administration (NHTSA) website to locate the nearest child safety seat inspection station. For CPST availability in Canada, check with Transport Canada or the Provincial Ministry of Transportation office.

### Securing the Child Within the Child Restraint

#### Warning

A child can be seriously injured or killed in a crash if the child is not properly secured in the child restraint. Secure the child properly following the instructions that came with that child restraint.

### Where to Put the Restraint

According to accident statistics, children and infants are safer when properly restrained in a child restraint system or infant restraint system secured in a rear seating position.

Whenever possible, children aged 12 and under should be secured in a rear seating position.

Never put a rear-facing child seat in the front. This is because the risk to the rear-facing child is so great if the airbag deploys.

 **Warning**

A child in a rear-facing child restraint can be seriously injured or killed if the front passenger airbag inflates. This is because the back of the rear-facing child restraint would be very close to the inflating airbag. A child in a forward-facing child restraint can be seriously injured or killed if the front passenger airbag inflates and the passenger seat is in a forward position.

Even if the passenger sensing system has turned off the front passenger frontal airbag, no

(Continued)

**Warning (Continued)**

system is fail-safe. No one can guarantee that an airbag will not deploy under some unusual circumstance, even though it is turned off.

Secure rear-facing child restraints in a rear seat, even if the airbag is off. If you secure a forward-facing child restraint in the front seat, always move the front passenger seat as far back as it will go. It is better to secure the child restraint in a rear seat.

See *Passenger Sensing System on page 3-20* for additional information.

When securing a child restraint in a rear seating position, study the instructions that came with the child restraint to make sure it is compatible with this vehicle.

Child restraints and booster seats vary considerably in size, and some may fit in certain seating positions better than others. Always make sure the child restraint is properly secured.

Depending on where you place the child restraint and the size of the child restraint, you may not be able to access adjacent safety belt assemblies or LATCH anchors for additional passengers or child restraints. Adjacent seating positions should not be used if the child restraint prevents access to or interferes with the routing of the safety belt.

Wherever a child restraint is installed, be sure to secure the child restraint properly.

Keep in mind that an unsecured child restraint can move around in a collision or sudden stop and injure people in the vehicle. Be sure to properly secure any child restraint in the vehicle — even when no child is in it.

### Lower Anchors and Tethers for Children (LATCH System)

The LATCH system secures a child restraint during driving or in a crash. LATCH attachments on the child restraint are used to attach the child restraint to the anchors in the vehicle. The LATCH system is designed to make installation of a child restraint easier.

In order to use the LATCH system in your vehicle, you need a child restraint that has LATCH attachments. LATCH-compatible rear-facing and forward-facing child seats can be properly installed using either the LATCH anchors or the vehicle's safety belts. Do not use both the safety belts and the LATCH anchorage system to secure a rear-facing or forward-facing child seat.

Booster seats use the vehicle's safety belts to secure the child in the booster seat. If the manufacturer

recommends that the booster seat be secured with the LATCH system, this can be done as long as the booster seat can be positioned properly and there is no interference with the proper positioning of the lap-shoulder belt on the child.

Make sure to follow the instructions that came with the child restraint, and also the instructions in this manual.

When installing a child restraint with a top tether, you must also use either the lower anchors or the safety belts to properly secure the child restraint. A child restraint must never be installed using only the top tether and anchor.

The LATCH anchorage system can be used until the combined weight of the child plus the child restraint is 29.5 kg (65 lbs). Use the safety belt alone instead of the LATCH anchorage system once the combined weight is more than 29.5 kg (65 lbs).

The following explains how to attach a child restraint with these attachments in the vehicle.

Not all vehicle seating positions or child restraints have lower anchors and attachments or top tether anchors and attachments.

### Lower Anchors

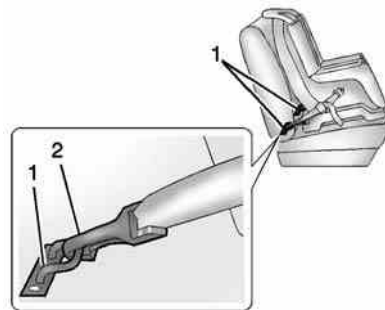

Lower anchors (1) are metal bars built into the vehicle. There are two lower anchors for each LATCH seating position that will accommodate a child restraint with lower attachments (2).

### Top Tether Anchor

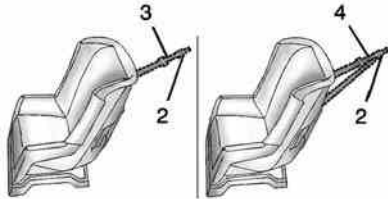

A top tether (3, 4) anchors the top of the child restraint to the vehicle. A top tether anchor is built into the vehicle. The top tether attachment (2) on the child restraint connects to the top tether anchor in the vehicle in order to reduce the forward movement and rotation of the child restraint during driving or in a crash.

The child restraint may have a single tether (3) or a dual tether (4). Either will have a single attachment (2) to secure the top tether to the anchor.

Some child restraints with top tethers are designed for use with or without the top tether being attached. Others require the top tether always to be attached. Be sure to read and follow the instructions for your child restraint.

### Lower Anchor and Top Tether Anchor Locations

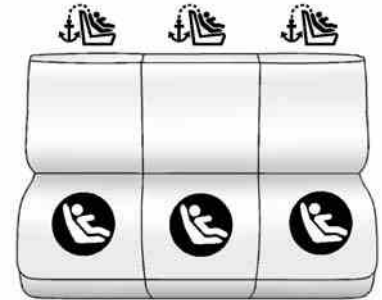

#### Rear Seat

 **(Top Tether Anchor):** Seating positions with top tether anchors.

 **(Lower Anchor):** Seating positions with two lower anchors.



## 3-36 Seats and Restraints

To assist in locating the lower anchors, each seating position with lower anchors has two labels, near the crease between the seatback and the seat cushion and the seat cushion.



To assist in locating the top tether anchors, the top tether anchor symbol is near the anchor.

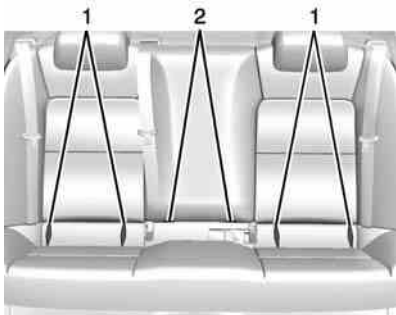

1. Outboard Lower Anchors
2. Center Lower Anchors

The outboard lower anchors (1) are behind the vertical openings in the seat trim. The center lower anchors (2) are in the crease between the seatback and the seat cushion.

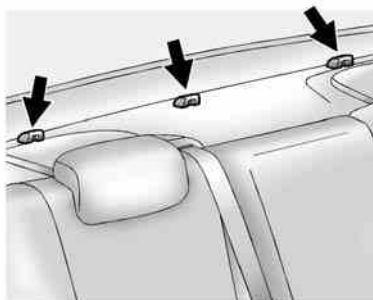

The top tether anchors are on the rear seatback filler panel. Be sure to use an anchor on the same side of the vehicle as the seating position where the child restraint will be placed.

Do not secure a child restraint in a position without a top tether anchor if a national or local law requires that the top tether be attached, or if the instructions that come with the child restraint say that the top tether must be attached.

According to accident statistics, children and infants are safer when properly restrained in a child restraint system or infant restraint system secured in a rear seating position. See *Where to Put the Restraint* on page 3-32 for additional information.

### Securing a Child Restraint Designed for the LATCH System

#### **Warning**

If a LATCH-type child restraint is not attached to anchors, the child restraint will not be able to protect the child correctly. In a crash, the

(Continued)



**Warning (Continued)**

child could be seriously injured or killed. Install a LATCH-type child restraint properly using the anchors, or use the vehicle safety belts to secure the restraint, following the instructions that came with the child restraint and the instructions in this manual.

 **Warning**

Do not attach more than one child restraint to a single anchor. Attaching more than one child restraint to a single anchor could cause the anchor or attachment to come loose or even break during a crash. A child or others could be injured. To reduce the risk of serious or fatal injuries during a crash, attach only one child restraint per anchor.

 **Warning**

Children can be seriously injured or strangled if a shoulder belt is wrapped around their neck and the safety belt continues to tighten. Buckle any unused safety belts behind the child restraint so children cannot reach them. Pull the shoulder belt all the way out of the retractor to set the lock, if the vehicle has one, after the child restraint has been installed.

 **Caution**

Do not let the LATCH attachments rub against the vehicle's safety belts. This may damage these parts. If necessary, move buckled safety belts to avoid rubbing the LATCH attachments.

If you need to secure more than one child restraint in the rear seat, see *Where to Put the Restraint on page 3-32*.

This system is designed to make the installation of child restraints easier. When using lower anchors, do not use the vehicle's safety belts. Instead, use the vehicle's anchors and child restraint attachments to secure the restraints. Some restraints also use another vehicle anchor to secure a top tether.

1. Attach and tighten the lower attachments to the lower anchors. If the child restraint does not have lower attachments or the desired seating position does not have lower anchors, secure the child restraint with the top tether and the safety belts. Refer to your child restraint manufacturer instructions and the instructions in this manual.

## 3-38 Seats and Restraints

- 1.1. Find the lower anchors for the desired seating position.
  - 1.2. Put the child restraint on the seat.
  - 1.3. Attach and tighten the lower attachments on the child restraint to the lower anchors.
2. If the child restraint manufacturer recommends that the top tether be attached, attach and tighten the top tether to the top tether anchor, if equipped. Refer to the child restraint instructions and the following steps:
- 2.1. Find the top tether anchor.

- 2.2. Route, attach, and tighten the top tether according to your child restraint instructions and the following instructions:

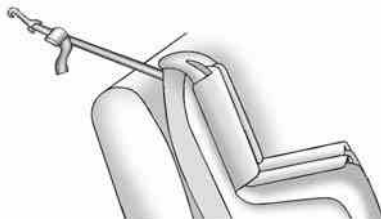

If the position you are using does not have a head restraint and you are using a single tether, route the tether over the seatback.

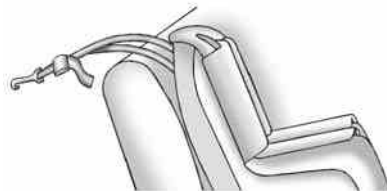

If the position you are using does not have a head restraint and you are using a dual tether, route the tether over the seatback.

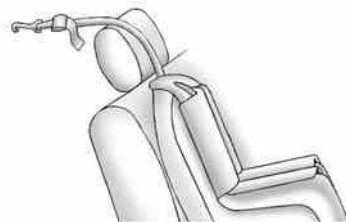

If the position you are using has a fixed head restraint and you are using a single tether, route the tether over the head restraint.



If the position you are using has a fixed head restraint and you are using a dual tether, route the tether around the head restraint.

3. Before placing a child in the child restraint, make sure it is securely held in place. To check, grasp the child restraint at the LATCH path and attempt to move it side to side and back

and forth. There should be no more than 2.5 cm (1 in) of movement for proper installation.

### Replacing LATCH System Parts After a Crash

#### Warning

A crash can damage the LATCH system in the vehicle. A damaged LATCH system may not properly secure the child restraint, resulting in serious injury or even death in a crash. To help make sure the LATCH system is working properly after a crash, see your dealer to have the system inspected and any necessary replacements made as soon as possible.

If the vehicle has the LATCH system and it was being used during a crash, new LATCH system parts may be needed.

New parts and repairs may be necessary even if the LATCH system was not being used at the time of the crash.

### Securing Child Restraints (Rear Seat)

When securing a child restraint in a rear seating position, study the instructions that came with the child restraint to make sure it is compatible with this vehicle.

If the child restraint has the LATCH system, see *Lower Anchors and Tethers for Children (LATCH System)* on page 3-34 for how and where to install the child restraint using LATCH. If a child restraint is secured in the vehicle using a safety belt and it uses a top tether, see *Lower Anchors and Tethers for Children (LATCH System)* on page 3-34 for top tether anchor locations.

Do not secure a child seat in a position without a top tether anchor if a national or local law requires

## 3-40 Seats and Restraints

that the top tether be anchored, or if the instructions that come with the child restraint say that the top strap must be anchored.

In Canada, the law requires that forward-facing child restraints have a top tether, and that the tether be attached.

If the child restraint does not have the LATCH system, you will be using the safety belt to secure the child restraint in this position. Be sure to follow the instructions that came with the child restraint. Secure the child in the child restraint when and as the instructions say.

If more than one child restraint needs to be installed in the rear seat, be sure to read *Where to Put the Restraint on page 3-32*.

1. Put the child restraint on the seat.
2. Pick up the latch plate, and run the lap and shoulder portions of the vehicle safety belt through or

around the restraint. The child restraint instructions will show you how.



3. Push the latch plate into the buckle until it clicks.

Position the release button on the buckle so that the safety belt could be quickly unbuckled if necessary.



4. Pull the shoulder belt all the way out of the retractor to set the lock. When the retractor lock is set, the belt can be tightened but not pulled out of the retractor.

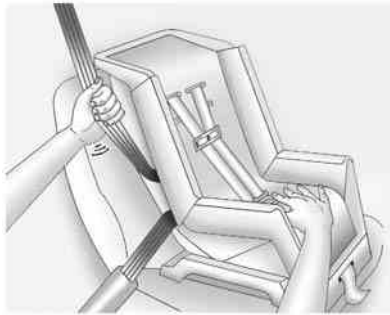

5. To tighten the belt, push down on the child restraint, pull the shoulder portion of the belt to tighten the lap portion of the belt, and feed the shoulder belt back into the retractor. When installing a forward-facing child restraint, it may be helpful to use your knee to push down on the child restraint as you tighten the belt. Try to pull the belt out of the retractor to make sure the retractor is locked. If the retractor is not locked, repeat Steps 4 and 5.
  6. If the child restraint has a top tether, follow the child restraint manufacturer's instructions regarding the use of the top tether. See *Lower Anchors and Tethers for Children (LATCH System)* on page 3-34 for more information.
  7. Before placing a child in the child restraint, make sure it is securely held in place. To check, grasp the child restraint at the safety belt path and attempt to move it side to side and back and forth. When the child restraint is properly installed, there should be no more than 2.5 cm (1 in) of movement.
- To remove the child restraint, unbuckle the vehicle safety belt and let it return to the stowed position. If the top tether is attached to a top tether anchor, disconnect it.

## Securing Child Restraints (Front Passenger Seat)

This vehicle has airbags. A rear seat is a safer place to secure a forward-facing child restraint. See *Where to Put the Restraint* on page 3-32.

In addition, the vehicle has a passenger sensing system which is designed to turn off the front outboard passenger frontal airbag and knee airbag under certain conditions. See *Passenger Sensing System* on page 3-20 and *Passenger Airbag Status Indicator* on page 5-11 for more information, including important safety information.

Never put a rear-facing child seat in the front. This is because the risk to the rear-facing child is so great, if the airbag deploys.

### Warning

A child in a rear-facing child restraint can be seriously injured or killed if the passenger frontal airbag inflates. This is because the back of the rear-facing child restraint would be very close to the inflating airbag. A child in a forward-facing child restraint can be seriously injured or killed if the passenger frontal airbag inflates and the passenger seat is in a forward position.

Even if the passenger sensing system has turned off the front outboard passenger airbag(s), no system is fail-safe. No one can guarantee that an airbag will not inflate under some unusual circumstance, even though the airbag(s) are off.

(Continued)

### Warning (Continued)

Secure rear-facing child restraints in a rear seat, even if the airbag(s) are off. If you secure a forward-facing child restraint in the front outboard passenger seat, always move the seat as far back as it will go. It is better to secure the child restraint in a rear seat.

If the child restraint has the LATCH system, see *Lower Anchors and Tethers for Children (LATCH System)* on page 3-34 for how and where to install the child restraint using LATCH. If a child restraint is secured using a safety belt and it uses a top tether, see for top tether anchor locations.

Do not secure a child seat in a position without a top tether anchor if a national or local law requires that the top tether be anchored, or if

the instructions that come with the child restraint say that the top strap must be anchored.

In Canada, the law requires that forward-facing child restraints have a top tether, and that the tether be attached.

You will be using the lap-shoulder belt to secure the child restraint in this position. Follow the instructions that came with the child restraint.

1. Move the seat as far back as it will go before securing the forward-facing child restraint.

When the passenger sensing system has turned off the front outboard passenger frontal and knee airbags, the off indicator on the passenger airbag status indicator should light and stay lit when the vehicle is started. See *Passenger Airbag Status Indicator* on page 5-11.

2. Put the child restraint on the seat.

- Pick up the latch plate, and run the lap and shoulder portions of the vehicle's safety belt through or around the restraint. The child restraint instructions will show you how.



- Push the latch plate into the buckle until it clicks.  
Position the release button on the buckle so that the safety belt could be quickly unbuckled if necessary.



- Pull the shoulder belt all the way out of the retractor to set the lock. When the retractor lock is set, the belt can be tightened but not pulled out of the retractor.

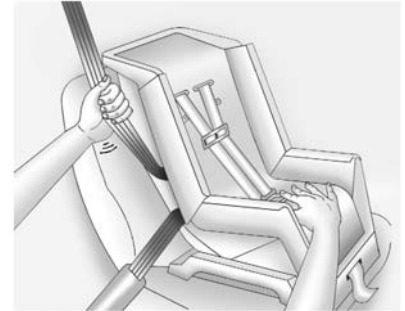

- To tighten the belt, push down on the child restraint, pull the shoulder portion of the belt to tighten the lap portion of the belt, and feed the shoulder belt back into the retractor. When installing a forward-facing child restraint, it may be helpful to use your knee to push down on the child restraint as you tighten the belt.

Try to pull the belt out of the retractor to make sure the retractor is locked. If the retractor is not locked, repeat Steps 5 and 6.

## 3-44 Seats and Restraints

---

7. Before placing a child in the child restraint, make sure it is securely held in place. To check, grasp the child restraint at the safety belt path and attempt to move it side to side and back and forth. When the child restraint is properly installed, there should be no more than 2.5 cm (1 in) of movement.

If the airbags are off, the off indicator in the passenger airbag status indicator will come on and stay on when the vehicle is started.

If a child restraint has been installed and the on indicator is lit, see “If the On Indicator Is Lit for a Child Restraint” under *Passenger Sensing System* on page 3-20 for more information.

To remove the child restraint, unbuckle the vehicle safety belt and let it return to the stowed position.



## Storage

### Storage Compartments

- Storage Compartments ..... 4-1
- Glove Box ..... 4-1
- Cupholders ..... 4-1
- Center Console Storage ..... 4-2

### Additional Storage Features

- Convenience Net ..... 4-3

## Storage Compartments

 **Warning**

Do not store heavy or sharp objects in storage compartments. In a crash, these objects may cause the cover to open and could result in injury.

### Glove Box

Lift up on the glove box lever to open it.

## Cupholders



The front cupholders are in the center console.

## 4-2 Storage

---

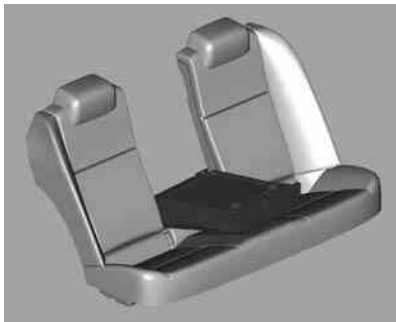

Pull the rear armrest down to access the rear cupholders.



The vehicle has cupholders in front of the center seat.

To open, push in the front of the cover and release it.

To close, slide the cupholder back into the seat until the latch engages.

### Center Console Storage



There is storage under the center console armrest. To open, press the latch and lift up. Do not force the lid backwards. There is a power outlet inside.

See *Power Outlets* on page 5-4.

## Additional Storage Features

### Convenience Net

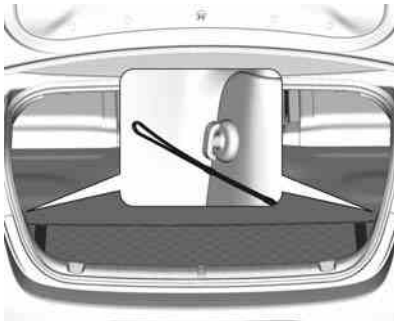

If equipped, the convenience net is in the rear. Put small loads behind the net. It can also be positioned into an envelope style to hold smaller items. The net is not for heavier loads. Store items as far forward as you can.

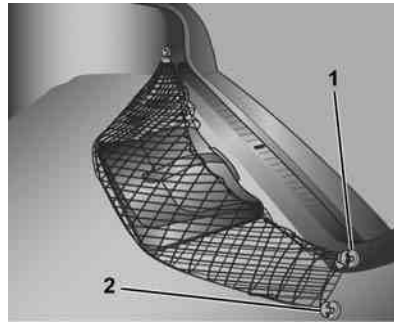

Attach four corner loops (1) to the top two hooks on the vehicle (two loops on one side, two loops on the other) and attach the two center loops (2) to the bottom hooks on the vehicle.

The net can be opened and objects placed inside.

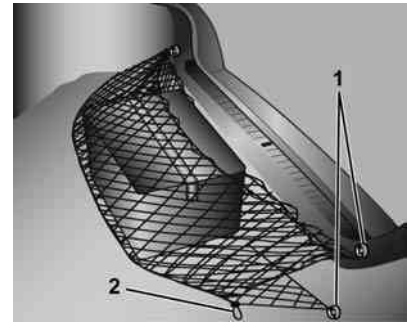

For larger objects, place a corner loop (1) on each hook.



# Instruments and Controls

## Controls

Steering Wheel Adjustment ...	5-2
Steering Wheel Controls .....	5-2
Horn .....	5-3
Windshield Wiper/Washer .....	5-3
Clock .....	5-4
Power Outlets .....	5-4

## Warning Lights, Gauges, and Indicators

Warning Lights, Gauges, and Indicators .....	5-6
Instrument Cluster .....	5-7
Speedometer .....	5-8
Odometer .....	5-8
Trip Odometer .....	5-8
Tachometer .....	5-8
Fuel Gauge .....	5-8
Engine Coolant Temperature Gauge .....	5-9
Safety Belt Reminders .....	5-9
Airbag Readiness Light .....	5-10
Passenger Airbag Status Indicator .....	5-11

Charging System Light .....	5-11
Malfunction Indicator Lamp .....	5-12
Service Vehicle Soon Light .....	5-14
Brake System Warning Light .....	5-14
Electric Parking Brake Light .....	5-15
Service Electric Parking Brake Light .....	5-15
Antilock Brake System (ABS) Warning Light .....	5-16
Lane Departure Warning (LDW) Light .....	5-16
Forward Collision Alert (FCA) Warning Light .....	5-16
Vehicle Ahead Indicator .....	5-17
Traction Off Light .....	5-17
StabiliTrak <sup>®</sup> OFF Light .....	5-17
Traction Control System (TCS)/StabiliTrak <sup>®</sup> Light .....	5-18
Tire Pressure Light .....	5-18
Engine Oil Pressure Light .....	5-18
Low Fuel Warning Light .....	5-19
Security Light .....	5-19
High-Beam On Light .....	5-20
Front Fog Lamp Light .....	5-20

Lamps On Reminder .....	5-20
Cruise Control Light .....	5-20
Door Ajar Light .....	5-20

## Information Displays

Driver Information Center (DIC) .....	5-21
Head-Up Display (HUD) .....	5-23

## Vehicle Messages

Vehicle Messages .....	5-26
Battery Voltage and Charging Messages .....	5-26
Brake System Messages .....	5-26
Cruise Control Messages .....	5-27
Door Ajar Messages .....	5-27
Engine Cooling System Messages .....	5-27
Engine Oil Messages .....	5-28
Engine Power Messages .....	5-28
Fuel System Messages .....	5-28
Key and Lock Messages .....	5-29
Lamp Messages .....	5-29
Object Detection System Messages .....	5-29
Ride Control System Messages .....	5-31
Security Messages .....	5-31
Service Vehicle Messages .....	5-31

## 5-2 Instruments and Controls

Tire Messages .....	5-31
Transmission Messages .....	5-32
Vehicle Reminder Messages .....	5-32
Washer Fluid Messages .....	5-32
Window Messages .....	5-32

### Vehicle Personalization

Vehicle Personalization .....	5-33
-------------------------------	------

## Controls

### Steering Wheel Adjustment



To adjust the steering wheel:

1. Pull the lever down.
2. Move the steering wheel up or down and in or out for a comfortable position.
3. Pull the lever up to lock the steering wheel in place.

Do not adjust the tilt and telescope lever while driving.



### Steering Wheel Controls



Some audio functions can be controlled through the steering wheel controls.

**☎ / 🎤 (Push to Talk):** Press to interact with Bluetooth or voice recognition. See *Bluetooth* on page 7-75, *OnStar Overview* on page 14-1, or *Voice Recognition* on page 7-68.

 (Mute/End Call): Press to decline an incoming call, or to end a current call. Press to silence the vehicle speakers while using the infotainment system. Press again to turn the sound on. Press to cancel voice recognition.

 **SRC**  (Thumbwheel Control): Press to select an audio source.

Use the thumbwheel to select the next or previous favorite radio station, CD track, MP3 track, USB track, and Bluetooth Audio track.

Use  SRC to skip to the next song or show using Pandora or Stitcher. See *Pandora Internet Radio on page 7-22* or *Stitcher Internet Radio on page 7-27*.

+  - (Volume): Press + to increase the volume. Press - to decrease.

## Horn

Press  on the steering wheel pad to sound the horn.

## Windshield Wiper/Washer



With the ignition in ACC/ACCESSORY or ON/RUN/START, move the windshield wiper lever to select the wiper speed.

**HI:** Use for fast wipes.

**LO:** Use for slow wipes.



**INT (Rainsense Wipe Sensitivity Control):** Move the windshield wiper lever to INT. Turn the  INT band on the wiper lever to adjust the sensitivity.

**OFF:** Use to turn the wipers off.

 (Mist): For a single wipe, briefly move the wiper lever down. For several wipes, hold the wiper lever down.

Clear snow and ice from the wiper blades and windshield before using them. If frozen to the windshield, carefully loosen or thaw them. Damaged blades should be replaced. See *Wiper Blade Replacement on page 10-23*.

Heavy snow or ice can overload the wiper motor.

## Rainsense™

With Rainsense, a sensor near the top center of the windshield detects the amount of water on the windshield and controls the frequency of the windshield wiper.

## 5-4 Instruments and Controls

Keep this area of the windshield clear of debris to allow for best system performance.

### INT (Rainsense Wipe Sensitivity Control):

Move the windshield wiper lever to INT. Turn the  INT band on the wiper lever to adjust the sensitivity.



- Turn the band up for more sensitivity to moisture.
- Turn the band down for less sensitivity to moisture.
- Move the windshield wiper lever out of the INT position to deactivate Rainsense.

 **(Windshield Washer):** Pull the windshield wiper lever toward you to spray windshield washer fluid and activate the wipers. The wipers

will continue until the lever is released or the maximum wash time is reached. When the windshield wiper lever is released, additional wipes may occur depending on how long the windshield washer had been activated. See *Washer Fluid on page 10-17* for information on filling the windshield washer fluid reservoir.

### Warning

In freezing weather, do not use the washer until the windshield is warmed. Otherwise the washer fluid can form ice on the windshield, blocking your vision.

## Clock

### Time and Date

1. Press HOME on the radio faceplate.
2. Press the Config screen button on the Home Page.

3. Select Time and Date.
4. Select the desired setting to change.

**Set Time:** Press + or – to increase or decrease the hours and minutes.

If auto timing is set, the time displayed on the clock may not update immediately when driving into a new time zone.

**Set Date:** Press + or – to increase or decrease the year, month, and day.

**12hr/24hr Format:** Press to select 12 hour or 24 hour time format.

Press the Back screen button to save.

## Power Outlets

The accessory power outlets can be used to plug in electrical equipment, such as a cell phone or MP3 player.

The vehicle has an accessory power outlet on the center stack and inside the center console storage.



To use the outlet, the ignition must be in ON/RUN or ACC/ACCESSORY. Remove the cover to access the outlet and replace when not in use.

 **Caution**

Leaving electrical equipment on for extended periods will drain the battery. Always turn off electrical equipment when not in use and do not plug in equipment that exceeds the maximum amperage rating.

This circuit is protected by a fuse and has a maximum current level. Do not use equipment exceeding the maximum amperage rating.

Certain power accessory plugs may not be compatible with the accessory power outlet and could overload vehicle or adapter fuses. If a problem is experienced, see your dealer.

 **Caution**

Adding any electrical equipment to the vehicle may damage it or keep other components from working as they should. The repairs would not be covered by the vehicle warranty. Do not use equipment exceeding maximum amperage rating of 10 amperes. Check with your dealer before adding electrical equipment.

When adding electrical equipment, be sure to follow the proper installation instructions included with the equipment. See *Add-On Electrical Equipment* on page 9-50.

 **Caution**

Hanging heavy equipment from the power outlet can cause damage not covered by the vehicle warranty. The power outlets are designed for accessory power plugs only, such as cell phone charge cords.

### Warning Lights, Gauges, and Indicators

Warning lights and gauges can signal that something is wrong before it becomes serious enough to cause an expensive repair or replacement. Paying attention to the warning lights and gauges could prevent injury.

Warning lights come on when there could be a problem with a vehicle function. Some warning lights come on briefly when the engine is started to indicate they are working.

Gauges can indicate when there could be a problem with a vehicle function. Often gauges and warning lights work together to indicate a problem with the vehicle.

When one of the warning lights comes on and stays on while driving, or when one of the gauges shows there may be a problem, check the section that explains what to do. Follow this manual's advice. Waiting to do repairs can be costly and even dangerous.

## Instrument Cluster

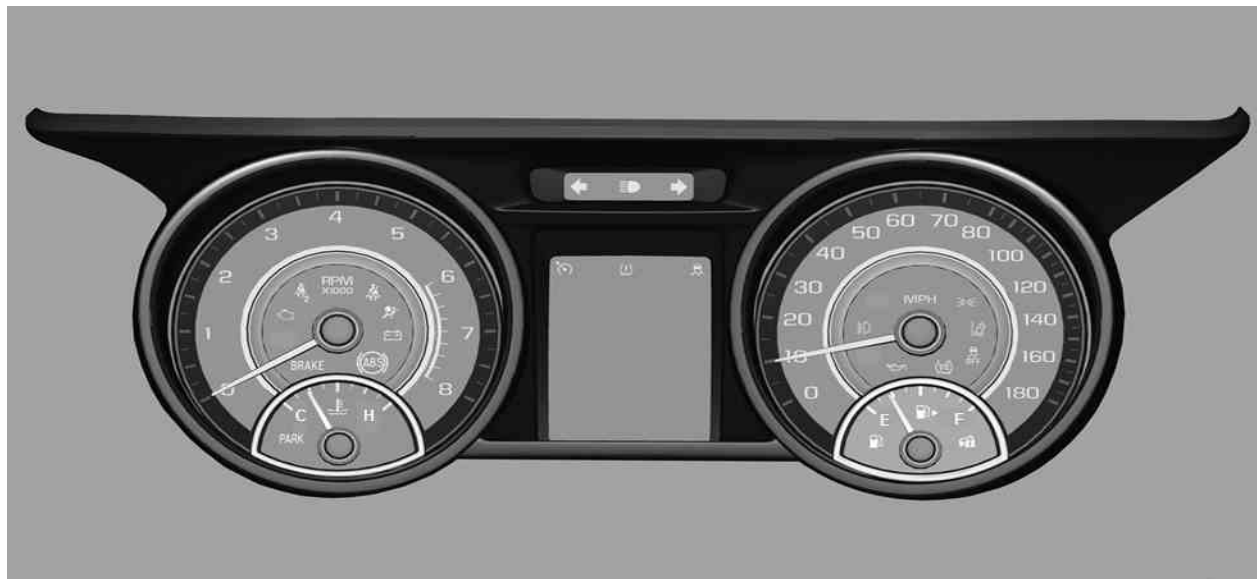

## 5-8 Instruments and Controls

### Speedometer

The speedometer shows the vehicle's speed in either kilometers per hour (km/h) or miles per hour (mph).

### Odometer

The odometer shows how far the vehicle has been driven, in either kilometers or miles.

### Trip Odometer

The trip odometer can show how far the vehicle has been driven since the trip odometer was last reset.

The trip odometer is accessed and reset through the Driver Information Center (DIC). See *Driver Information Center (DIC)* on page 5-21.

### Tachometer

The tachometer displays the engine speed in revolutions per minute (rpm).

#### Caution

If the engine is operated with the tachometer in the shaded warning area, the vehicle could be damaged, and the damages would not be covered by the vehicle warranty. Do not operate the engine with the tachometer in the shaded warning area.

### Fuel Gauge

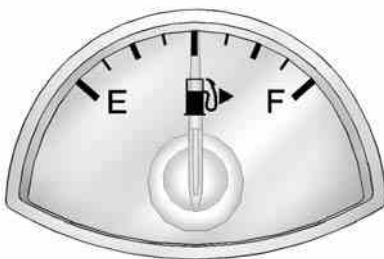

When the ignition is on, the fuel gauge shows how much fuel is left in the fuel tank. When the indicator nears empty, a message in the Driver Information Center (DIC) displays. See *Fuel System Messages* on page 5-28. The vehicle still has a little fuel left, but the vehicle should be fueled soon. An arrow on the fuel gauge indicates the side of the vehicle the fuel door is on.

Here are four things that some owners ask about. These are normal and do not indicate a problem with the fuel gauge:

- At the service station, the gas pump shuts off before the gauge reads full.
- It takes a little more or less fuel to fill up than the gauge indicated. For example, the gauge may have indicated the fuel tank was half full, but it actually took a little more or less than half the fuel tank's capacity to fill it.

- The indicator moves a little while turning a corner or speeding up.
- The gauge goes back to empty when the ignition is turned off.

## Engine Coolant Temperature Gauge

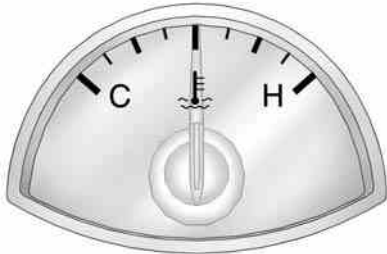

This gauge shows the engine coolant temperature.

If the indicator needle moves to the hot side of the gauge, the engine is too hot.

If the vehicle has been operated under normal driving conditions, pull off the road, stop the vehicle, and turn off the engine as soon as possible.

## Safety Belt Reminders

### Driver Safety Belt Reminder Light

There is a driver safety belt reminder light on the instrument cluster.



When the vehicle is started this light flashes and a chime comes on to remind drivers to fasten their safety belt. Then the light stays on solid until the belt is buckled. This cycle may continue several times if the

driver remains or becomes unbuckled while the vehicle is moving.

If the driver safety belt is buckled, neither the light nor chime comes on.

### Passenger Safety Belt Reminder Light



When the vehicle is started this light flashes and a chime may come on to remind the front passenger to fasten their safety belt. Then the light stays on solid until the belt is buckled. This cycle may continue several times if the passenger remains or becomes unbuckled while the vehicle is moving.

If the front passenger safety belt is buckled, neither the chime nor the light comes on.

## 5-10 Instruments and Controls

The front passenger safety belt warning light and chime may turn on if an object is put on the seat such as a briefcase, handbag, grocery bag, laptop, or other electronic device. To turn off the warning light and/or chime, remove the object from the seat or buckle the safety belt.

### Second Row Passenger Belt Reminder Light



Second row seating positions monitored for safety belt use are represented by a colored symbol in the Driver Information Center (DIC) indicating safety belt status. When the vehicle is started, three safety belt symbols come on and stay on for several seconds in the instrument cluster to alert the driver

that passengers may need to fasten their safety belts. After the passenger safety belt is buckled, the corresponding safety belt symbol in the instrument cluster turns green. If a safety belt is not initially buckled, the instrument cluster displays a gray safety belt symbol. While the vehicle is moving, if a second row passenger that was previously buckled becomes unbuckled, the corresponding safety belt symbol will change to flashing red and a chime may sound.

### Airbag Readiness Light

This light shows if there is an electrical problem with the airbag system. The system check includes the airbag sensor(s), passenger sensing system, the pretensioners, the airbag modules, the wiring, and the crash sensing and diagnostic module. For more information on the airbag system, see *Airbag System* on page 3-14.



The airbag readiness light comes on for several seconds when the vehicle is started. If the light does not come on then, have it fixed immediately.



#### Warning

If the airbag readiness light stays on after the vehicle is started or comes on while driving, it means the airbag system might not be working properly. The airbags in the vehicle might not inflate in a crash, or they could even inflate without a crash. To help avoid injury, have the vehicle serviced right away.

## Passenger Airbag Status Indicator

This vehicle has a passenger sensing system. See *Passenger Sensing System* on page 3-20 for important safety information. The rearview mirror has a passenger airbag status indicator.



When the vehicle is started, the passenger airbag status indicator will light ON and OFF for several seconds as a system check. Then, after several more seconds, the status indicator will light either ON or OFF to let you know the status of the front outboard passenger frontal airbag and knee airbag.

If the word ON is lit on the passenger airbag status indicator, it means that the front outboard passenger frontal airbag and knee airbag are allowed to inflate.

If the word OFF is lit on the passenger airbag status indicator, it means that the passenger sensing system has turned off the front outboard passenger frontal airbag and knee airbag.

If, after several seconds, both status indicator lights remain on, or if there are no lights at all, there may be a problem with the lights or the passenger sensing system. See your dealer for service.

### Warning

If the airbag readiness light ever comes on and stays on, it means that something may be wrong with the airbag system. To help avoid injury to yourself or others, have the vehicle serviced right

(Continued)

### Warning (Continued)

away. See *Airbag Readiness Light* on page 5-10 for more information, including important safety information.

## Charging System Light

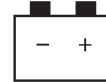

The charging system light comes on briefly when the ignition is turned on, but the engine is not running, as a check to show the light is working. The light turns off when the engine is started. If it does not, have the vehicle serviced by your dealer.

If the light stays on, or comes on while driving, there could be a problem with the electrical charging

## 5-12 Instruments and Controls

system. Have it checked by your dealer. Driving while this light is on could drain the battery.

If a short distance must be driven with the light on, be sure to turn off all accessories, such as the radio and air conditioner.

### Malfunction Indicator Lamp

A computer system called OBD II (On-Board Diagnostics-Second Generation) monitors the operation of the vehicle to ensure emissions are at acceptable levels, helping to maintain a clean environment. The malfunction indicator lamp comes on when the vehicle is placed in Service Only Mode, as a check to show it is working. If it does not, have the vehicle serviced by your dealer. See *Ignition Positions* on page 9-15.



If the malfunction indicator lamp comes on while the engine is running, this indicates that the OBD II system has detected a problem and diagnosis and service might be required.

Malfunctions often are indicated by the system before any problem is apparent. Being aware of the light can prevent more serious damage to the vehicle. This system also assists the service technician in correctly diagnosing any malfunction.

#### **Caution**

If the vehicle is continually driven with this light on, the emission controls might not work as well,

(Continued)

#### **Caution (Continued)**

the vehicle fuel economy might not be as good, and the engine might not run as smoothly. This could lead to costly repairs that might not be covered by the vehicle warranty.

#### **Caution**

Modifications made to the engine, transmission, exhaust, intake, or fuel system of the vehicle or the replacement of the original tires with other than those of the same Tire Performance Criteria (TPC) can affect the vehicle's emission controls and can cause this light to come on.

Modifications to these systems could lead to costly repairs not covered by the vehicle warranty. This could also result in a failure

(Continued)



**Caution (Continued)**

to pass a required Emission Inspection/Maintenance test. See *Accessories and Modifications on page 10-2*.

This light comes on during a malfunction in one of two ways:

**Light Flashing:** A misfire condition has been detected. A misfire increases vehicle emissions and could damage the emission control system on the vehicle. Diagnosis and service might be required.

To prevent more serious damage to the vehicle:

- Reduce vehicle speed.
- Avoid hard accelerations.
- Avoid steep uphill grades.

If the light continues to flash, find a safe place to stop and park the vehicle. Turn the vehicle off, wait at least 10 seconds, and restart the engine. If the light is still flashing,

follow the previous steps and see your dealer for service as soon as possible.

**Light On Steady:** An emission control system malfunction has been detected on the vehicle. Diagnosis and service might be required.

The following may correct an emission control system malfunction:

- Check that the fuel cap is fully installed. See *Filling the Tank on page 9-48*. The diagnostic system can determine if the fuel cap has been left off or improperly installed. A loose or missing fuel cap allows fuel to evaporate into the atmosphere. A few driving trips with the cap properly installed should turn the light off.
- Check that good quality fuel is used. Poor fuel quality causes the engine not to run as efficiently as designed and may cause stalling after start-up,

stalling when the vehicle is changed into gear, misfiring, hesitation on acceleration, or stumbling on acceleration. These conditions might go away once the engine is warmed up.

If one or more of these conditions occurs, change the fuel brand used. It may require at least one full tank of the proper fuel to turn the light off.

See *Recommended Fuel on page 9-46*.

If none of the above have made the light turn off, your dealer can check the vehicle. The dealer has the proper test equipment and diagnostic tools to fix any mechanical or electrical problems that might have developed.

### **Emissions Inspection and Maintenance Programs**

Depending on where you live, your vehicle may be required to participate in an emission control system inspection and maintenance program. For the inspection, the

## 5-14 Instruments and Controls

emission system test equipment will likely connect to the vehicle's Data Link Connector (DLC).

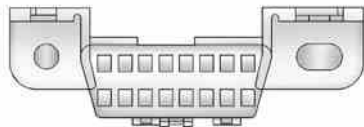

The DLC is under the instrument panel to the left of the steering wheel. See your dealer if assistance is needed.

The vehicle may not pass inspection if:

- The malfunction indicator lamp is on with the engine running, or if the vehicle is placed in Service Only Mode and the malfunction indicator lamp does not come on. See your dealer for assistance in verifying proper operation of the malfunction indicator lamp.

- The OBD II (On-Board Diagnostics) system determines that critical emission control systems have not been completely diagnosed. The vehicle would be considered not ready for inspection. This can happen if the 12-volt battery has recently been replaced or run down. The diagnostic system is designed to evaluate critical emission control systems during normal driving. This can take several days of routine driving. If this has been done and the vehicle still does not pass the inspection for lack of OBD II system readiness, your dealer can prepare the vehicle for inspection.

### Service Vehicle Soon Light



For vehicles with this light, it comes on if a condition exists that may require the vehicle to be taken in for service.

If the light comes on, take the vehicle to your dealer for service as soon as possible.

### Brake System Warning Light

The vehicle brake system consists of two hydraulic circuits. If one circuit is not working, the remaining circuit can still work to stop the vehicle. For normal braking performance, both circuits need to be working.

If the warning light comes on, there is a brake problem. Have the brake system inspected right away.

## BRAKE

This light comes on briefly when the vehicle is turned on. If it does not come on then, have it fixed so it will be ready to warn if there is a problem.

If the light comes on and stays on, there is a base brake problem.

### Warning

The brake system might not be working properly if the brake system warning light is on. Driving with the brake system warning light on can lead to a crash. If the light is still on after

(Continued)

### Warning (Continued)

the vehicle has been pulled off the road and carefully stopped, have the vehicle towed for service.

## Electric Parking Brake Light

## PARK

The parking brake status light comes on when the brake is applied. If the light continues flashing after the parking brake is released, or while driving, there is a problem with the electric parking brake system. A message may also display on the Driver Information

Center (DIC). See *Brake System Messages on page 5-26* for more information.

If the light does not come on, or remains flashing, see your dealer.

## Service Electric Parking Brake Light



The service electric parking brake light should come on briefly when the vehicle is in ON/RUN. If it does not come on, have the vehicle serviced by your dealer.

If this light stays on, there is a problem with a system on the vehicle that is causing the parking brake system to work at a reduced level. The vehicle can still be driven, but should be taken to a dealer as soon as possible. See *Electric*

## 5-16 Instruments and Controls

*Parking Brake on page 9-27. If a message displays in the Driver Information Center (DIC), see [Brake System Messages on page 5-26](#).*

### Antilock Brake System (ABS) Warning Light



This light comes on briefly when the engine is started.

If it does not, have the vehicle serviced by your dealer.

If the ABS light stays on, turn the ignition off.

If the light comes on while driving, stop as soon as it is safely possible and turn off the vehicle. Then start the engine again to reset the system. If the ABS light stays on, or comes on again while driving, the

vehicle needs service. A chime may also sound when the light comes on steady.

If the ABS light is the only light on, the vehicle has regular brakes, but the antilock brakes are not functioning.

If both the ABS and the brake system warning light are on, the vehicle's antilock brakes are not functioning and there is a problem with the regular brakes. See your dealer for service.

*See [Brake System Warning Light on page 5-14](#) and [Brake System Messages on page 5-26](#).*

### Lane Departure Warning (LDW) Light



This light comes on green when the system is on and ready to operate. When the system determines that the vehicle is leaving its lane without using the turn signal, this light will change to amber and flash.

*See [Lane Departure Warning \(LDW\) on page 9-44](#).*

### Forward Collision Alert (FCA) Warning Light

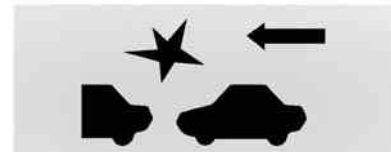

The forward collision alert comes on and warns when a vehicle is being rapidly approached.

*See [Forward Collision Alert \(FCA\) System on page 9-40](#) for more information.*

## Vehicle Ahead Indicator



If equipped, this light displays green when a vehicle is detected ahead.

This light will display amber when you are following a vehicle ahead much too closely.

See *Forward Collision Alert (FCA) System* on page 9-40.

## Traction Off Light



This light comes on briefly while starting the engine. If it does not, have the vehicle serviced by your dealer. If the system is working normally, the indicator light then turns off.

The traction off light comes on when the Traction Control System (TCS) has been turned off by pressing and releasing the TCS/StabiliTrak button.

This light and the StabiliTrak OFF light come on when StabiliTrak is turned off.

If the TCS is off, wheel spin is not limited. Adjust driving accordingly.

See *Traction Control/Electronic Stability Control* on page 9-30.

## StabiliTrak<sup>®</sup> OFF Light



This light comes on briefly while starting the engine. If it does not, have the vehicle serviced by your dealer.

This light comes on when the StabiliTrak system is turned off. If StabiliTrak is off, the Traction Control System (TCS) is also off.

If the StabiliTrak and TCS are off, the system does not assist in controlling the vehicle. Turn on the TCS and the StabiliTrak systems and the warning light turns off.

See *Traction Control/Electronic Stability Control* on page 9-30.

### Traction Control System (TCS)/StabiliTrak<sup>®</sup> Light



This light comes on briefly when the engine is started.

If the light does not come on, have the vehicle serviced by your dealer. If the system is working normally, the indicator light turns off.

If the light is on and not flashing, the TCS, and potentially the StabiliTrak system have been disabled. A DIC message may display. Check the DIC messages to determine which feature(s) is no longer functioning and whether the vehicle requires service.

If the indicator/warning light is on and flashing, the TCS and/or the StabiliTrak system is actively working.

See *Traction Control/Electronic Stability Control* on page 9-30.

### Tire Pressure Light



For vehicles with the Tire Pressure Monitor System (TPMS), this light comes on briefly when the engine is started. It provides information about tire pressures and the TPMS.

#### When the Light Is On Steady

This indicates that one or more of the tires are significantly underinflated.

A Driver Information Center (DIC) tire pressure message may also display. See *Tire Messages* on page 5-31. Stop as soon as possible, and inflate the tires to the pressure value shown on the Tire and Loading Information label. See *Tire Pressure* on page 10-41.

#### When the Light Flashes First and Then Is On Steady

If the light flashes for about a minute and then stays on, there may be a problem with the TPMS. If the problem is not corrected, the light will come on at every ignition cycle. See *Tire Pressure Monitor Operation* on page 10-43.

### Engine Oil Pressure Light



Lack of proper engine oil maintenance can damage the engine. Driving with the engine

(Continued)

**Caution (Continued)**

oil low can also damage the engine. The repairs would not be covered by the vehicle warranty. Check the oil level as soon as possible. Add oil if required, but if the oil level is within the operating range and the oil pressure is still low, have the vehicle serviced. Always follow the maintenance schedule for changing engine oil.



This light should come on briefly as the engine is started. If it does not come on, have the vehicle serviced by your dealer.

If the light comes on and stays on, it means that oil is not flowing through the engine properly. The vehicle

could be low on oil and might have some other system problem. See your dealer.

**Low Fuel Warning Light**

This light is near the fuel gauge and comes on briefly when the ignition is turned on as a check to show it is working.

It also comes on when the fuel tank is low on fuel. The light turns off when fuel is added. If it does not, have the vehicle serviced.

**Security Light**

The security light should come on briefly as the engine is started. If it does not come on, have the vehicle serviced by your dealer. If the system is working normally, the indicator light turns off.

If the light stays on and the engine does not start, there could be a problem with the theft-deterrent system. See *Immobilizer Operation* on page 2-15.

## High-Beam On Light



This light comes on when the high-beam headlamps are in use.

See *Headlamp High/Low-Beam Changer* on page 6-1.

## Front Fog Lamp Light



For vehicles with fog lamps, this light comes on when the fog lamps are on.

The light goes out when the fog lamps are turned off. See *Fog Lamps* on page 6-3 for more information.

## Lamps On Reminder



This light comes on when the exterior lamps are in use. See *Exterior Lamp Controls* on page 6-1.

## Cruise Control Light



For vehicles with cruise control, the cruise control light is white when the cruise control is on and ready, and turns green when the cruise control is set and active.

The light turns off when the cruise control is turned off. See *Cruise Control* on page 9-32.

## Door Ajar Light



If equipped, this light comes on when a door is open or not securely latched. Before driving, check that all doors are properly closed. See *Door Ajar Messages* on page 5-27.



## Information Displays

### Driver Information Center (DIC)

The DIC displays information about the vehicle. It also displays warning messages if a system problem is detected. See *Vehicle Messages on page 5-26*. All messages appear in the DIC display in the center of the instrument cluster.

The vehicle may also have features that can be customized through the controls on the radio. See *Vehicle Personalization on page 5-33*.

#### DIC Operation and Displays

The DIC has different displays, which can be accessed by using the DIC buttons on the turn signal lever to the left of the steering wheel. The DIC displays trip, fuel, vehicle system information, and warning messages if a system problem is detected.

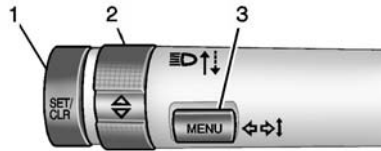

1. **SET/CLR:** Press to set, or press and hold to clear, the menu item displayed.
2. : Use the band to scroll through the items in each menu.
3. **MENU:** Press to display the DIC menus. This button is also used to return to or exit the last screen displayed on the DIC.

#### Trip/Fuel Menu Items

Press MENU on the turn signal lever until Trip/Fuel Menu is displayed. Use  to scroll through the following possible menu items:

- Digital Speedometer
- Trip
- Fuel Range
- Average Fuel Economy

- Instantaneous Fuel Economy
- Average Vehicle Speed
- Navigation

#### Digital Speedometer

The speedometer, available on some vehicles, shows how fast the vehicle is moving in either kilometers per hour (km/h) or miles per hour (mph). The speedometer cannot be reset.

#### Trip

This display shows the current distance traveled in either kilometers (km) or miles (mi), since the last reset for the trip odometer. The trip odometer can be reset to zero by pressing SET/CLR while the trip odometer display is showing.

#### Fuel Range

This display shows the approximate distance the vehicle can be driven without refueling. The fuel range estimate is based on an average of the vehicle's fuel economy over

## 5-22 Instruments and Controls

---

recent driving history and the amount of fuel remaining in the fuel tank. Fuel range cannot be reset.

### Average Fuel Economy

This display shows the approximate average liters per 100 kilometers (L/100 km) or miles per gallon (mpg). This number is calculated based on the number of L/100 km (mpg) recorded since the last time this menu item was reset. The fuel economy can be reset by pressing SET/CLR while the Average Fuel Economy display is showing. On some models, this display is shown on the same page with the instantaneous fuel consumption display.

### Instantaneous Fuel Economy

The instantaneous fuel consumption display shows the current fuel economy in liters per 100 kilometers (L/100 km) or miles per gallon (mpg). This number reflects only the fuel economy that the vehicle has right now and changes frequently as driving

conditions change. Unlike average fuel economy, this display cannot be reset. On some models, this display is shown on the same page with the average fuel economy display.

### Average Vehicle Speed

This display shows the average speed of the vehicle in kilometers per hour (km/h) or miles per hour (mph). This average is calculated based on the various vehicle speeds recorded since the last reset of this value. The average speed can be reset by pressing SET/CLR while the Average Vehicle Speed display is showing.

### Navigation

This display shows the Navigation information when guidance is selected.

### Vehicle Information Menu Items

Press MENU on the turn signal lever until Vehicle Information menu is displayed. Use  to scroll through the following possible menu items:

- Battery Voltage
- Speed Warning
- Tire Pressure Monitoring
- Remaining Oil Life
- Units

### Battery Voltage

This display, available on some vehicles, shows the current battery voltage. If the voltage is in the normal range, the value will display. For example, the display may read Battery Voltage 15.0 Volts. The vehicle's charging system regulates voltage based on the state of the battery. The battery voltage can fluctuate while viewing this information on the DIC. This is normal. See *Charging System Light*

on page 5-11. If there is a problem with the battery charging system, the DIC will display a message.

### Speed Warning

This display is used to set the vehicle speed at which the speed warning chime sounds and the alert is displayed. The speed can be set by pressing SET/CLR while the speed warning display is showing.

### Tire Pressure Monitoring

This display will show a vehicle with the approximate pressures of all four tires. Tire pressure is displayed in either kilopascal (kPa) or pounds per square inch (psi). See *Tire Pressure Monitor Operation* on page 10-43.

### Remaining Oil Life

This display shows an estimate of the oil's remaining useful life. If 99% is displayed, that means 99% of the current oil life remains.

When the remaining oil life is low, the CHANGE ENGINE OIL SOON message will appear on the display.

See *Engine Oil Messages* on page 5-28. The oil should be changed as soon as possible. See *Engine Oil* on page 10-6. In addition to the engine oil life system monitoring the oil life, additional maintenance is recommended in the Maintenance Schedule. See *Maintenance Schedule* on page 11-2.

Remember, the Remaining Oil Life display must be reset after each oil change. It will not reset itself. Also, be careful not to reset the Oil Life display accidentally at any time other than when the oil has just been changed. It cannot be reset accurately until the next oil change. To reset the engine oil life system, press SET/CLR while the Oil Life display is active. See *Engine Oil Life System* on page 10-8.

### Units

Move  to switch between metric or US when the Units display is active. Press SET/CLR to confirm the setting. This will change the

displays on the cluster and DIC to either metric or English (US) measurements.

## Head-Up Display (HUD)

### Warning

If the HUD image is too bright or too high in your field of view, it may take you more time to see things you need to see when it is dark outside. Be sure to keep the HUD image dim and placed low in your field of view.

With HUD, some information concerning the operation of the vehicle is projected onto the windshield. The image is projected through the HUD lens on top of the instrument panel. The information appears as an image focused out toward the front of the vehicle.

## 5-24 Instruments and Controls

### Caution

If you try to use the HUD image as a parking aid, you may misjudge the distance and damage your vehicle. Do not use the HUD image as a parking aid.

The HUD may display some of the following alerts or information for vehicles equipped with these features:

- Speedometer
- Tachometer
- High Beam Indicator Symbol
- Forward Collision Alert Warnings
- Audio Functions
- Navigation
- Transmission Position
- Shift Up Meter
- Cruise Control Active



The HUD control is to the left of the steering wheel.

To adjust the HUD image:

1. Adjust the driver seat.
2. Start the engine.

Use the following settings to adjust the HUD.

**HUD (Image Adjustment):** Press down or up to center the HUD image. The HUD image can only be adjusted up and down, not side to side.

**PAGE (Display View):** Press to select the display view. Turn clockwise or counterclockwise to

brighten or dim the display. Turn completely counterclockwise to turn the display off.

The HUD image will automatically dim and brighten to compensate for outside lighting. The HUD brightness control can also be adjusted as needed.

The HUD image can temporarily light up depending on the angle and position of the sunlight on the HUD display. This is normal.

Polarized sunglasses could make the HUD image harder to see.

### HUD Views

There are four HUD pages that can be viewed in the HUD display.

Page one displays:



Page two displays:



Page three displays:



Page four displays:



### Care of the HUD

Clean the inside of the windshield to remove any dirt or film that could reduce the sharpness or clarity of the HUD image.

Clean the HUD lens with a soft cloth sprayed with glass cleaner. Wipe the lens gently, then dry it.

### HUD Troubleshooting

Check that:

- Nothing is covering the HUD lens.
- HUD brightness setting is not too dim or too bright.
- HUD is adjusted to the proper height.
- Polarized sunglasses are not worn.
- Windshield and HUD lens are clean.

If the HUD image is not correct, contact your dealer.

The windshield is part of the HUD system. See *Windshield Replacement* on page 10-24.

## Vehicle Messages

Messages displayed on the DIC indicate the status of the vehicle or some action that may be needed to correct a condition. Multiple messages may display one after the other.

The messages that do not require immediate action can be acknowledged and cleared by pressing SET/CLR. The messages that require immediate action cannot be cleared until that action is performed. All messages should be taken seriously and clearing the messages does not correct the problem.

The following are some of the vehicle messages that may be displayed depending on your vehicle content.

## Battery Voltage and Charging Messages

### BATTERY SAVER ACTIVE

This message displays when the vehicle has detected that the battery voltage is dropping beyond a reasonable point. The battery saver system starts reducing features of the vehicle that may be noticed. At the point that features are disabled, this message displays. Turn off unnecessary accessories to allow the battery to recharge.

### LOW BATTERY

This message is displayed when the battery voltage is low. See *Battery on page 10-20*.

### SERVICE BATTERY CHARGING SYSTEM

This message is displayed when there is a fault in the battery charging system. Take the vehicle to your dealer for service.

## Brake System Messages

### BRAKE FLUID LOW

This message displays when the brake fluid level is low. See *Brake Fluid on page 10-19*.

### RELEASE PARKING BRAKE

This message displays if the electric parking brake is on while the vehicle is in motion. Release it before attempting to drive. See *Electric Parking Brake on page 9-27*.

### SERVICE BRAKE ASSIST

This message displays when there is a problem with the brake boost system. When this message displays, the brake pedal may be harder to push and the stopping distance may be longer. Take the vehicle to your dealer for service.

### SERVICE PARKING BRAKE

This message displays when there is a problem with the parking brake. Take the vehicle to your dealer for service.

## **STEP ON BRAKE TO RELEASE PARK BRAKE**

This message displays when attempting to release the electric parking brake without the brake pedal applied. See *Electric Parking Brake* on page 9-27.

## **Cruise Control Messages**

### **CRUISE SET TO XXX**

This message displays when the cruise control is set and shows the speed it was set to. See *Cruise Control* on page 9-32.

## **Door Ajar Messages**

### **DRIVER DOOR OPEN**

This message will display when the driver door is open. Close the door completely.

### **HOOD OPEN**

This message will display when the hood is open. Close the hood completely.

### **LEFT REAR DOOR OPEN**

This message will display when the driver side rear door is open. Close the door completely.

### **PASSENGER DOOR OPEN**

This message will display when the front passenger door is open. Close the door completely.

### **RIGHT REAR DOOR OPEN**

This message will display when the passenger side rear door is open. Close the door completely.

### **TRUNK OPEN**

This message will display when the trunk is open. Close the trunk completely.

## **Engine Cooling System Messages**

### **A/C OFF DUE TO HIGH ENGINE TEMP**

This message displays when the engine coolant becomes hotter than the normal operating temperature. To avoid added strain on a hot engine, the air conditioning compressor automatically turns off. When the coolant temperature returns to normal, the air conditioning compressor turns back on. The vehicle can continue to be driven.

If this message continues to appear, have the system repaired by your dealer as soon as possible to avoid damage to the engine.

### **ENGINE OVERHEATED — IDLE ENGINE**

This message displays when the engine coolant temperature is too hot. Stop and allow the vehicle to idle until it cools down.

### **ENGINE OVERHEATED — STOP ENGINE**

This message displays and a continuous chime sounds if the engine cooling system reaches unsafe temperatures for operation. Stop and turn off the vehicle as soon as it is safe to do so to avoid severe damage. This message clears when the engine has cooled to a safe operating temperature.

### **Engine Oil Messages**

#### **CHANGE ENGINE OIL SOON**

This message displays when service is required for the vehicle. See your dealer. See *Engine Oil on page 10-6* and *Maintenance Schedule on page 11-2*.

Acknowledging the CHANGE ENGINE OIL SOON message will not reset the system. See “Remaining Oil Life” under *Driver Information Center (DIC) on page 5-21* and *Engine Oil Life System on page 10-8*.

### **ENGINE OIL LOW — ADD OIL**

On some vehicles, this message displays when the engine oil level may be too low. Check the oil level before filling to the recommended level. If the oil is not low and this message remains on, take the vehicle to your dealer for service. See *Engine Oil on page 10-6*.

### **OIL PRESSURE LOW STOP ENGINE**

This message displays when the vehicle's engine oil pressure is low. The oil pressure light also appears on the instrument cluster. See *Engine Oil Pressure Light on page 5-18*.

Stop the vehicle immediately, as engine damage can result from driving a vehicle with low oil pressure. Have the vehicle serviced by your dealer as soon as possible when this message is displayed.

### **Engine Power Messages**

#### **ENGINE POWER IS REDUCED**

This message displays when the vehicle's engine power is reduced. Reduced engine power can affect the vehicle's ability to accelerate. If this message is on, but there is no reduction in performance, proceed to your destination. The performance may be reduced the next time the vehicle is driven. The vehicle may be driven at a reduced speed while this message is on, but maximum acceleration and speed may be reduced. Anytime this message stays on, the vehicle should be taken to your dealer for service as soon as possible.

### **Fuel System Messages**

#### **FUEL LEVEL LOW**

This message displays when the vehicle is low on fuel. Refuel as soon as possible.



## Key and Lock Messages

### NO REMOTE DETECTED

This message displays when the transmitter battery is weak on vehicles with Keyless Access. See “Starting the Vehicle with a Low Transmitter Battery” under *Remote Keyless Entry (RKE) System Operation on page 2-3*.

### REPLACE BATTERY IN REMOTE KEY

This message displays when the battery in the Remote Keyless Entry (RKE) transmitter needs to be replaced. See “Battery Replacement” under *Remote Keyless Entry (RKE) System Operation on page 2-3*.

### USE TRANSMITTER POCKET TO START

This message displays when trying to start the vehicle if an RKE transmitter is not detected. The transmitter battery may be weak. See “Starting the Vehicle with a Low

Transmitter Battery” under *Remote Keyless Entry (RKE) System Operation on page 2-3*.

## Lamp Messages

### AUTOMATIC LIGHT CONTROL ON/OFF

This message is displayed when the automatic light control has been turned on or off. See *Automatic Headlamp System on page 6-2*.

### CHECK XXX TURN SIGNAL LAMP

When one of the turn signals is out, this message displays to show which bulb needs to be replaced. See *Bulb Replacement on page 10-24* and *Replacement Bulbs on page 10-25*.

### TURN SIGNAL ON

This message is displayed if the turn signal has been left on. Turn off the turn signal.

## Object Detection System Messages

### FORWARD COLLISION ALERT OFF

This message displays when the Forward Collision Alert has been turned off.

### FRONT CAMERA BLOCKED CLEAN WINDSHIELD

This message displays when the camera is blocked. Cleaning the outside of the windshield behind the rearview mirror may correct the issue. The Lane Departure Warning system will not operate. Forward Collision Alert (FCA) may not work or may not work as well.

### LANE DEPARTURE WARNING UNAVAILABLE

This message displays when attempting to activate the Lane Departure Warning (LDW) system

when it is temporarily unavailable. The LDW system does not need service.

This message could be due to the camera being blocked. Cleaning the outside of the windshield behind the rearview mirror may correct the issue.

### **PARK ASSIST OFF**

This message displays when the Parking Assist system has been turned off or when there is a temporary condition causing the system to be disabled.

### **REAR CROSS TRAFFIC ALERT OFF**

This message displays when the Rear Cross Traffic Alert has been turned off.

### **SERVICE FRONT CAMERA**

If this message remains on after continued driving, the vehicle needs service. Do not use the Lane Departure Warning (LDW) and

Forward Collision Alert (FCA) features. Take the vehicle to your dealer.

### **SERVICE PARKING ASSIST**

This message displays if there is a problem with the Parking Assist system. Do not use this system to help you park. See your dealer for service.

### **SERVICE SIDE DETECTION SYSTEM**

If this message remains on after continued driving, the vehicle needs service. Side Blind Zone Alert (SBZA) and Rear Cross Traffic Alert (RCTA) features will not work. Take the vehicle to your dealer.

### **SIDE BLIND ZONE ALERT OFF**

This message indicates that the driver has turned the Side Blind Zone Alert (SBZA) system off.

### **SIDE DETECTION SYSTEM UNAVAILABLE**

This message indicates that Side Blind Zone Alert (SBZA) and Rear Cross Traffic Alert (RCTA) are disabled either because the sensor is blocked and cannot detect vehicles in the blind zone, or the vehicle is passing through an open area, such as the desert, where there is insufficient data for operation. This message may also activate during heavy rain or due to road spray. The vehicle does not need service. For cleaning, see "Washing the Vehicle" under *Exterior Care on page 10-72*.

## Ride Control System Messages

### SERVICE TRACTION CONTROL

This message displays when there is a problem with the Traction Control System (TCS). See *Traction Control/Electronic Stability Control* on page 9-30.

### SERVICE STABILITRAK

This message displays if there is a problem with the StabiliTrak system. See *Traction Control/Electronic Stability Control* on page 9-30.

## Security Messages

### THEFT ATTEMPTED

This message displays if the vehicle detects a tamper condition.

## Service Vehicle Messages

### SERVICE AC SYSTEM

This message displays if there is a problem with the air conditioning system. Take the vehicle to your dealer for service.

### SERVICE POWER STEERING

This message displays if there is a problem with the power steering system. Take the vehicle to your dealer for service.

### SERVICE VEHICLE SOON

This message displays if there is a problem with the vehicle. Take the vehicle to your dealer for service.

## Tire Messages

### SERVICE TIRE MONITOR SYSTEM

This message displays if there is a problem with the Tire Pressure Monitor System (TPMS). See *Tire Pressure Monitor Operation* on page 10-43 for more information.

### TIRE LEARNING ACTIVE

This message displays when the system is learning new tires. See *Tire Pressure Monitor Operation* on page 10-43 for more information.

### TIRE PRESSURE LOW ADD AIR TO TIRE

On vehicles with the Tire Pressure Monitor System (TPMS), this message displays when the pressure in one or more of the vehicle's tires is low.

There is also an icon with the warning that will indicate the location of the low tire.

The low tire pressure warning light will also come on. See *Tire Pressure Light* on page 5-18.

If a tire pressure message displays, inflate the tires until the tire pressure is equal to the values shown on the Tire and Loading Information label. See *Tires* on page 10-34, *Vehicle Load Limits* on page 9-10, and *Tire Pressure* on page 10-41.

More than one tire pressure message can be received at a time. To read the other messages that may have been sent at the same time, press the SET/CLR button. The DIC also shows the tire pressure values. See *Driver Information Center (DIC)* on page 5-21.

### Transmission Messages

#### SERVICE TRANSMISSION

This message displays if there is a problem with the transmission. See your dealer.

#### SHIFT DENIED

This message displays when using the Active Select mode and attempting to shift to a gear not appropriate for the vehicle speed and engine revolutions per minute (rpm). See *Manual Mode* on page 9-24.

#### SHIFT TO PARK

This message displays when the transmission needs to be shifted to P (Park). This may appear when attempting to remove the RKE transmitter from the vehicle if the vehicle is not in P (Park).

#### TRANSMISSION HOT — IDLE ENGINE

This message displays and a chime sounds if the transmission fluid in the vehicle gets hot. Driving with the transmission fluid temperature high can cause damage to the vehicle. Stop the vehicle and let it idle to allow the transmission to cool. This message clears when the fluid temperature reaches a safe level.

#### Vehicle Reminder Messages

#### ICE POSSIBLE DRIVE WITH CARE

This message displays when ice conditions are possible.

### Washer Fluid Messages

#### WASHER FLUID LOW ADD FLUID

This message may display when the washer fluid level is low. See *Washer Fluid* on page 10-17.

### Window Messages

#### OPEN, THEN CLOSE DRIVER/PASSENGER WINDOW

This message is displayed when the window needs to be reprogrammed. If the vehicle's battery has been recharged or disconnected, you will need to program each front window for the express-up feature to work. See *Power Windows* on page 2-18.

## Vehicle Personalization

Use the audio system controls to access the personalization menus for customizing vehicle features.

The following are all possible personalization features. Depending on the vehicle, some may not be available.

**HOME:** Press to display the Home Page screen.

**TUNE/MENU:** Press to enter menus and select menu items. Turn to scroll through the menus.

⬅ **BACK:** Press to exit or move backward in a menu.

### Entering the Personalization Menus

The ignition must be in the ON position.

1. Press HOME.
2. Select the Config screen button.

3. Turn the TUNE/MENU knob to highlight the desired setting.
4. Press the TUNE/MENU knob to select the desired setting menu.

The following list of menu items may be available:

- Languages
- Time and Date
- Radio Settings
- Phone Settings
- Navigation Settings
- Display Settings
- Vehicle Settings

Each menu is detailed in the following information. Alternatively, the touch screen may be used to select.

### Languages

Select Languages, then select from the available language(s).

### Time and Date

To adjust the time and date settings, see *Clock on page 5-4*.

### Radio Settings

Select and the following may display:

- Auto Volume
- Gracenote Options
- XM Channel Art
- Max Startup Volume
- Number of Favorite Pages
- XM Categories
- Software Version Menu

### Auto Volume

When selected, this feature will automatically adjust the volume to minimize the effects of unwanted background noise that can result from changing road surfaces, driving speeds, or open windows. This feature works best at lower volume

## 5-34 Instruments and Controls

---

settings where background noise is typically louder than the sound system volume.

Select OFF, Low, Medium, or High.

### Gracenote Options

Select to improve voice recognition and media groupings.

Select to enable or disable. See *CD Player on page 7-32, USB on page 7-34, Auxiliary Devices on page 7-40, and Bluetooth Audio on page 7-41.*

### XM Channel Art

When on, the radio will automatically update the XM screen and background graphics.

Select On or Off.

### Max Startup Volume

Select the maximum volume level at startup even if a higher volume had been set when the radio was turned off.

### Number of Favorite Pages

Select to set the number of FAV pages to be displayed.

### XM Categories

Select or deselect any category to be used in XM mode.

### Software Version Menu

Select to display information about the system and software.

### Phone Settings

See "Phone" in *Configure Menu on page 7-60.*

### Navigation Settings

See *Configure Menu on page 7-60.*

### Display Settings

Select and the following may display:

- Home Page Menu
- Rear Camera Options
- Display Off
- Map Settings

### Home Page Menu

Select to customize the first page of the Home Page.

### Rear Camera Options

Select to adjust the rear camera options.

### Display Off

Select to turn off the display. The display will return when any button is pressed or the screen is touched.

### Map Settings

Select to enter the submenu to change Automatic Zoom, enable Speed Limit display on map, and change Map Display settings.

- **Map Display:** Select to change the screen background.

To change the overall brightness setting for the display, use the vehicle interior lighting instrument panel illumination control.

- The Automatic setting adjusts the screen background automatically depending on the exterior lighting conditions.
- The Day setting brightens the map background.
- The Night setting darkens the map background.
- **Speed Limits:** Select to display the posted speed limit on the map, when available.

### Vehicle Settings

Select and the following may display:

- Climate and Air Quality
- Comfort and Convenience
- Collision/Detection Systems
- Lighting
- Power Door Locks
- Remote Lock/Unlock/Start
- Return to Factory Settings?

### Climate and Air Quality

Select and the following may display:

- Auto Fan Speed
- Remote Start Auto Cool Seat
- Remote Start Auto Heat Seat

### Auto Fan Speed

This feature sets the climate control fan speed to maintain the interior temperature.

Select High, Medium, or Low.

### Remote Start Auto Cool Seat

When on and it is hot outside, the ventilated seats will turn on automatically.

Select to turn on or off.

### Remote Start Auto Heat Seat

When on and it is cold outside, the heated seats will turn on automatically.

Select to turn on or off.

### Comfort and Convenience

Select and the following may display:

- Chime Volume
- Button Chime
- Reverse Mirror Tilt

### Chime Volume

This allows the selection of the chime volume level.

Select Normal or High.

### Button Chime

This allows the button chimes to be turned on or off.

Select On or Off.

### Reverse Mirror Tilt

This allows the reverse mirror tilt to be set to on or off.

Select On or Off.

## 5-36 Instruments and Controls

---

### Collision/Detection Systems

Select and the following may display, if equipped:

- Park Assist
- Side Blind Zone Alert
- Rear Cross Traffic Alert

### Park Assist

This allows the Parking Assist feature to be turned on or off. See *Driver Assistance Systems on page 9-35*.

Select On or Off.

### Side Blind Zone Alert

This allows the Side Blind Zone Alert feature to be turned on or off. See *Side Blind Zone Alert (SBZA) on page 9-42*.

Select On or Off.

### Rear Cross Traffic Alert

This allows the Rear Cross Traffic Alert feature to be turned on or off. See *Assistance Systems for Parking or Backing on page 9-36*.

Select On or Off.

### Lighting

Select and the following may display:

- Vehicle Locator Lights
- Exit Lighting

### Vehicle Locator Lights

When on, the headlamps and back-up lamps will flash when  is pressed.

Select On or Off.

### Exit Lighting

This allows the selection of how long the exterior lamps stay on when leaving the vehicle when it is dark outside.

Select Off, 30 Seconds, 1 Minute, or 2 Minutes.

### Power Door Locks

Select and the following may display:

- Open Door Anti Lock Out

- Auto Door Unlock
- Delayed Door Lock

### Open Door Anti Lock Out

When on, this feature will keep the driver door from locking when the door is open. If off, the Delayed Door Lock menu will be available.

Select On or Off.

### Auto Door Unlock

This allows the selection of which doors will automatically unlock when the vehicle is shifted into P (Park).

Select All Doors, Driver Door, or Off.

### Delayed Door Lock

When on, this feature will delay the locking of the doors. To override the delay, press the power door lock switch on the door.

Select On or Off.

### Remote Lock/Unlock/Start

Select and the following may display:

- Remote Unlock Feedback



- Remote Lock Feedback
- Remote Door Unlock
- Passive Door Unlock
- Passive Door Lock
- Remote Left in Veh. Reminder

### Remote Unlock Feedback

If equipped, this allows the selection of what type of feedback is given when unlocking the vehicle with the RKE transmitter.

Select On or Off.



### Remote Lock Feedback

This allows the selection of what type of feedback is given when locking the vehicle with the Remote Keyless Entry (RKE) transmitter.

Select Lights and Horn, Lights Only, Horn Only, or Off.

### Remote Door Unlock

This allows the selection of which doors will unlock when pressing  on the RKE transmitter.

Select All Doors or Driver Door Only. When set to Driver Door Only, the driver door will unlock the first time  is pressed and all doors will unlock when  is pressed a second time. When set to All Doors, all of the doors will unlock with the first press of .

### Passive Door Unlock

This allows the selection of what doors will unlock when using the button on the driver door to unlock the vehicle.

Select All Doors or Driver Door Only.

### Passive Door Lock

This allows passive locking to be turned on or off and selects feedback. See *Remote Keyless Entry (RKE) System Operation on page 2-3*.

Select On with Horn Chirp, On, or OFF.

### Remote Left in Veh. Reminder

This feature sounds an alert when the RKE transmitter is left in the vehicle.

Select On or Off.

### Return to Factory Settings?

Select to return all vehicle personalization to the default settings.

Select Yes or No.



## Lighting

### Exterior Lighting

Exterior Lamp Controls .....	6-1
Headlamp High/Low-Beam Changer .....	6-1
Flash-to-Pass .....	6-1
Daytime Running Lamps (DRL) .....	6-2
Automatic Headlamp System .....	6-2
Hazard Warning Flashers .....	6-3
Turn and Lane-Change Signals .....	6-3
Fog Lamps .....	6-3

### Interior Lighting

Instrument Panel Illumination Control .....	6-4
Dome Lamps .....	6-4
Reading Lamps .....	6-4

### Lighting Features

Entry Lighting .....	6-5
Exit Lighting .....	6-5
Battery Power Protection .....	6-5

## Exterior Lighting

### Exterior Lamp Controls

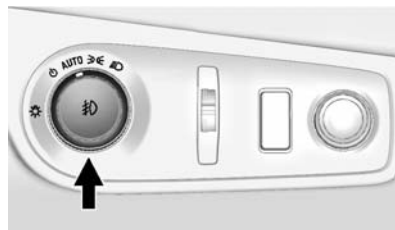

The exterior lamp control is on the instrument panel to the left of the steering wheel.

There are four positions:

**OFF** (Off): Briefly turn to this position to turn the automatic light control off or on again.

**AUTO (Automatic):** Automatic operation of the headlamps at normal brightness and other exterior lamps.

**⏏ (Parking Lamps):** Turns on the parking lamps including all lamps, except the headlamps.

**☞ (Headlamps):** Turns on the headlamps together with the parking lamps and instrument panel lights.

### Headlamp High/Low-Beam Changer

The headlamps must be on for this feature to work.

Push the turn signal lever away from you to turn the high beams on.

The  indicator light turns on in the instrument cluster when the high-beam headlamps are on.

Push the lever away from you to return to low beams.

### Flash-to-Pass

To flash the high beams, pull the lever toward you. The lamps remain on high beam as long as the lever is held.

## 6-2 Lighting

### Daytime Running Lamps (DRL)

DRL can make it easier for others to see the front of your vehicle during the day.

The DRL system makes the headlamps come on at a reduced brightness when the following conditions are met:

- The engine is running.
- The exterior lamp control is in AUTO.
- Shift lever is out of (P) position.
- The light sensor determines it is daytime.

When the DRL are on, the taillamps, instrument panel lights, and other lamps will not be on.

The headlamps automatically switch from DRL to the regular headlamps depending on the darkness of the surroundings. See “Automatic Headlamp System” following.

To turn off the DRL, turn the exterior lamp control to  and then release.

### Automatic Headlamp System

When it is dark enough outside and the exterior lamp control is in the automatic position, the headlamps and parking lamps will turn on and off automatically. See *Exterior Lamp Controls* on page 6-1.



There is a light sensor on top of the instrument panel. Do not cover the sensor; otherwise the headlamps will come on when they are not needed.

The system may also turn on the headlamps when driving through a parking garage or tunnel.

When it is bright enough outside, the headlamps turn off.

The automatic headlamp system turns off when the exterior lamp control is turned to  or the ignition is off.

The automatic headlamp system defaults to on with each ignition cycle.

## Hazard Warning Flashers

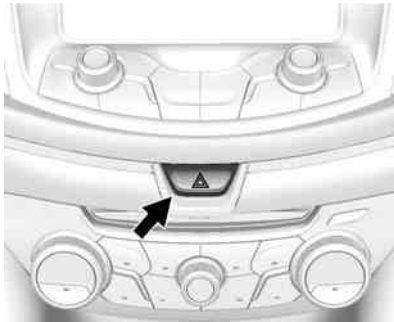

**⚠ (Hazard Warning Flasher):** Press this button on the center stack near the audio system, to make the front and rear turn signal lamps flash on and off. Press again to turn the flashers off.

## Turn and Lane-Change Signals

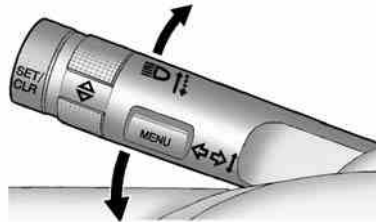

Move the turn signal lever all the way up or down to signal a turn.

An arrow on the instrument cluster flashes in the direction of the turn or lane change.

Raise or lower the lever until the arrow starts to flash to signal a lane change. Hold it there until the lane change is completed. If the lever is briefly pressed and released, the turn signal flashes three times.

The turn signal can be turned off manually by moving the lever back to its original position.

If after signaling a turn or lane change, the arrow flashes rapidly or does not come on, a signal bulb may be burned out.

Have any burned out bulbs replaced. If a bulb is not burned out, check the fuse. See *Fuses on page 10-26*.

## Fog Lamps

To turn on the fog lamps, the ignition and the headlamps or parking lamps must be on.

If the fog lamps are turned on while the exterior lamp control is in the AUTO position, the headlamps come on automatically.

**ⓘ (Fog Lamps):** Press to turn on or off. An indicator light on the instrument cluster comes on when the fog lamps are on.

Some localities have laws that require the headlamps to be on along with the fog lamps.

### Interior Lighting

#### Instrument Panel Illumination Control



This feature controls the brightness of the instrument panel controls and infotainment display screen. The thumbwheel is to the left of the steering column on the instrument panel.

 **(Instrument Panel Brightness):** Move the thumbwheel up or down to brighten or dim the instrument panel controls and infotainment display screen.

#### Dome Lamps

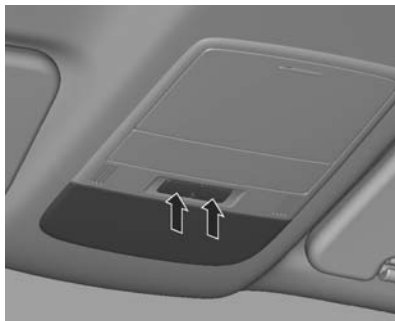

The dome lamps are in the overhead console.

 **(On/Off):** Press to turn the lamp on or off.

 **(Door):** Press to automatically turn on the lamps when a door is opened, the vehicle is unlocked, or the ignition is turned off.

When the interior lamps are set to door activated, they operate automatically only when it is dark.



The lamps dim to off after all doors are closed. They turn off about 10 minutes after the ignition is turned off. They turn off immediately if the ignition is turned on and all doors are closed.

#### Reading Lamps

##### Front Reading Lamps





The front reading lamps are in the overhead console.

Press  or  to turn the lamp on or off.

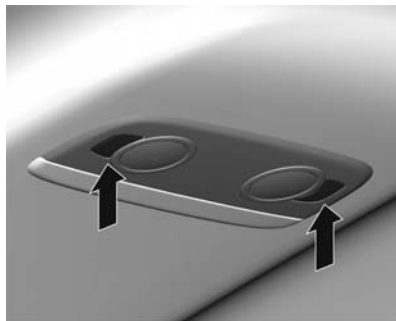
## Rear Reading Lamps



The rear reading lamps are in the headliner.

Press  or  to turn the lamp on or off.

## Lighting Features

### Entry Lighting

The headlamps, parking lamps, taillamps, back-up lamps, and most of the interior lamps turn on briefly when  is pressed on the Remote Keyless Entry (RKE) transmitter. After about 30 seconds the exterior lamps turn off, and then the dome and remaining interior lamps will dim to off.

This feature can be changed. See “Vehicle Locator Lights” under *Vehicle Personalization on page 5-33*.

### Exit Lighting

The exterior lamps will illuminate an area with limited lighting for a set amount of time when the ignition is turned to LOCK/OFF.

This feature can be changed. See *Vehicle Personalization on page 5-33*.

## Battery Power Protection

To prevent the battery from being drained, the glove box, trunk, and reading lamps automatically turn off 10 minutes after the ignition is turned off.

The lamps are reactivated if any of the following occur:

- The ignition is turned on.
- The vehicle is unlocked.
- The trunk is opened.





# Infotainment System

## Introduction

Infotainment .....	7-2
Overview .....	7-2
Using the System .....	7-6
Software Updates .....	7-11

## Radio

AM-FM Radio .....	7-11
Radio Data System (RDS) ...	7-14
Satellite Radio .....	7-15
Radio Reception .....	7-20
Backglass Antenna .....	7-21
Multi-Band Antenna .....	7-21
Quick Info .....	7-22

Pandora Internet Radio .....	7-22
Stitcher Internet Radio .....	7-27
Pictures .....	7-31

## Audio Players

CD Player .....	7-32
USB .....	7-34
Auxiliary Devices .....	7-40
Bluetooth Audio .....	7-41

## Navigation

Using the Navigation	
System .....	7-42
Maps .....	7-46
Navigation Symbols .....	7-46
Destination .....	7-48
OnStar <sup>®</sup> Destination	
Download .....	7-59
Configure Menu .....	7-60
Global Positioning	
System (GPS) .....	7-66

Vehicle Positioning .....	7-66
Problems with Route	
Guidance .....	7-67
If the System Needs	
Service .....	7-68
Map Data Updates .....	7-68
Database Coverage	
Explanations .....	7-68

## Voice Recognition

Voice Recognition .....	7-68
-------------------------	------

## Bluetooth Phone/Devices

Bluetooth .....	7-75
Text Messaging .....	7-82

## Trademarks and License Agreements

Trademarks and License	
Agreements .....	7-85

### Introduction

#### Infotainment

Read the following pages to become familiar with the infotainment system features.

#### Warning

Taking your eyes off the road for extended periods could cause a crash resulting in injury or death to you or others. Do not give extended attention to infotainment tasks while driving.

This system provides access to many audio and non-audio listings.

To minimize taking your eyes off the road while driving, do the following while the vehicle is parked:

- Become familiar with the operation and controls of the audio system.

- Set up the tone, speaker adjustments, and preset radio stations.

For more information, see *Defensive Driving* on page 9-3.

#### Caution

Contact your dealer before adding any equipment.

Adding audio or communication equipment could interfere with the operation of the engine, radio, or other systems, and could damage them. Follow federal rules covering mobile radio and telephone equipment.

The vehicle has Retained Accessory Power (RAP). With RAP, the audio system can be played even after the ignition is turned off. See *Retained Accessory Power (RAP)* on page 9-18 for more information.

### Overview

Read the following pages to become familiar with the infotainment system features.

The infotainment system has built-in features intended to help with this by disabling some functions when driving. A grayed out function is not available when the vehicle is moving.

All functions are available when the vehicle is parked. Before driving:

- Become familiar with the infotainment system operation, buttons on the faceplate, and touch-sensitive screen buttons.
- Set up the audio by presetting favorite stations, setting the tone, and adjusting the speakers.
- Set up phone numbers in advance so they can be called easily by pressing a single button or by using a single voice command for vehicles equipped with phone capability.

 **Warning**

Taking your eyes off the road for too long or too often while using the infotainment or navigation system could cause a crash.

You or others could be injured or killed. Do not give extended attention to these tasks while driving. Limit glances at the vehicle displays and focus your attention on driving. Use voice commands whenever possible.

See *Defensive Driving* on page 9-3

The vehicle has Retained Accessory Power (RAP). With RAP, the audio system can be played even after the ignition is turned off. See *Retained Accessory Power (RAP)* on page 9-18

**Customer Assistance**

Assistance is available to help with Bluetooth pairing, application downloading and installation, other mobile device interface, and operation support of the infotainment system. Specialists are available when calling this Customer Assistance number: U.S. (855) 4 SUPPORT (478-7767).

## 7-4 Infotainment System

### Infotainment System Overview

The infotainment system is controlled by using the buttons, touch screen, steering wheel controls, and voice recognition.

See *Using the System on page 7-6*.

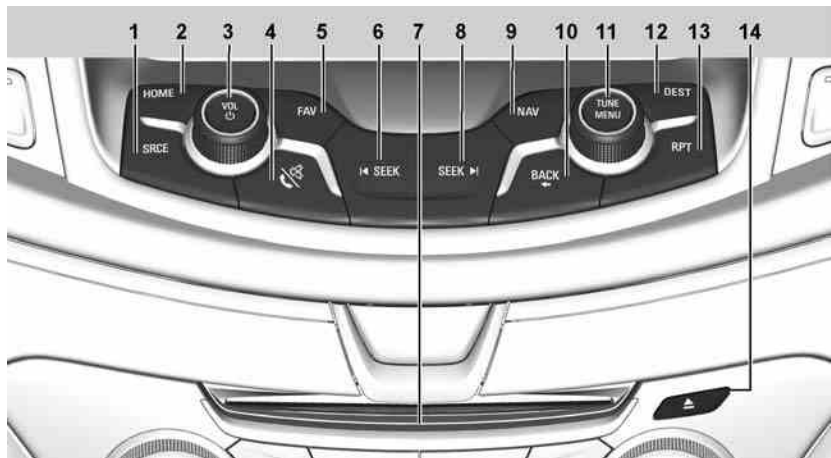

1. SRCE (Source)
2. HOME
3. VOL/⏻ (Volume/Power)
4. 📞/🔇 (Phone/Mute)
5. FAV (Favorites)
6. ⏪ SEEK
7. Disc Slot (CD)
8. SEEK ⏩
9. NAV (Navigation)
10. BACK ↶
11. TUNE/MENU
12. DEST (Destination)
13. RPT (Repeat)
14. ⏏ Eject

### Infotainment Control Buttons

The buttons on the faceplate are used to start primary functions while using the infotainment system.

**SRCE (Source):** Press to change the audio sources such as AM-FM Radio, SiriusXM® (if equipped), and AUX.

**HOME:** Press to go to the Home Page. See “Home Page” in this section.

**VOL/⏻ (Volume/Power):**

- Turn to adjust the volume.
- Press to turn the system on and off.

**📞/🔇 (Phone/Mute):**

- Press to enter the phone main screen.
- Press and hold to mute or unmute the infotainment system. See *Bluetooth on page 7-75*.

**FAV (Favorites):** Press to display the current favorite page number above the preset buttons. Keep pressing to scroll through the favorites pages. The stored stations for each list display on the bottom of the screen. The number of preset Favorite Pages can be changed by

pressing the Config button on the Home Page, then pressing Radio Settings, and then pressing Number of Favorite Pages.

**⏮ SEEK:**

- USB or Bluetooth Audio: Press to seek to the beginning of the current or previous track. If the track has been playing for less than five seconds, it seeks the previous track. If longer than five seconds, the current track starts from the beginning.
- USB or Bluetooth Audio: Press and hold to quickly reverse through a track. Release the button to return to playing speed. See *USB on page 7-34*.
- AM, FM, or SiriusXM (if equipped): Press to seek to the previous strong station.

**⏭ SEEK:**

- USB or Bluetooth Audio: Press to seek the next track.

- USB or Bluetooth Audio: Press and hold to fast forward through a track.
- AM, FM, or SiriusXM (if equipped): Press to seek to the next strong station.

**NAV (Navigation):**

- Press to view the vehicle's current position on the map screen.
- Continue pressing to cycle through the full map and split screens.

**BACK** ⏪: Press to return to the previous screen in a menu.

**TUNE/MENU:**

- Turn to manually tune to a radio station.
- Turn to highlight a feature. Press to activate the highlighted feature.

**DEST (Destination):**

- Press to enter a destination.

## 7-6 Infotainment System

- If a destination has already been entered, press to access the Destination Menu. See *Destination on page 7-48*.

**RPT (Repeat):** Press to repeat the last voice guidance prompt.



### Touch Screen Buttons

Touch screen buttons are on the screen and highlighted when a feature is available. Some toggle screen buttons highlight when active and gray out when inactive.

### Using the System

The infotainment system is controlled by touching the screen, and by using the knobs and other buttons.

Voice recognition, through the steering wheel controls, can be used to control the infotainment features.

Press  /  on the steering wheel controls to begin voice recognition. See *Voice Recognition on page 7-68*.

### Home Page

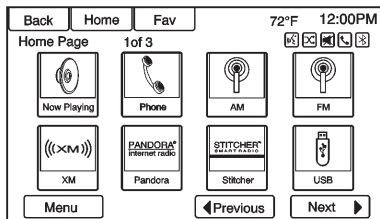

### Touch Screen Buttons

The Home Page allows access to many of the features.

**Back:** Press to return to the previous page.

**Home:** Press to go back to the Home Page.

**Fav:** Press to display a page of stored favorite AM, FM, or SiriusXM® (if equipped) stations. Keep pressing Fav to scroll through the favorite pages.

**More ▶ :** This button may display depending on the number of options stored on Home Page. Press to go to the next page.

**◀ Previous:** Press to go to the previous page.

**Next▶ :** Press to go to the next page.

### Home Page Customization

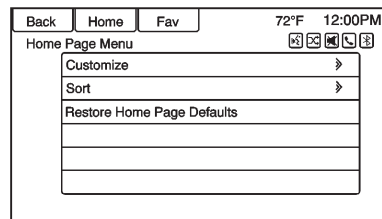

The first Home Page can be customized.

To add screen buttons:

1. Press Menu.
2. Press Customize.
3. Press a screen button to add or remove from the first Home Page. A ● indicates it will be displayed. The maximum number of buttons on Home Page 1 is eight.
4. Press Done.

To move screen buttons:

1. Press Sort.
2. Press an icon to move.
3. Press an icon to swap with.
4. Press Done.

To restore Home Page 1 defaults:

1. Press Menu.
2. Press Restore Home Page Defaults.
3. Press Yes or Cancel.

## Home Page Features

Touch screen buttons are highlighted when a feature is available.

Various functions are disabled when the vehicle is moving.



Press the Now Playing screen button to display the active source page. The sources available are AM, FM, SiriusXM® (if equipped), USB/iPod, Pandora (if equipped), Stitcher, and AUX.

See *AM-FM Radio on page 7-11*, *Satellite Radio on page 7-15*, *Pandora Internet Radio on page 7-22*, *Stitcher Internet Radio on page 7-27*, and *Auxiliary Devices on page 7-40*.



Press the Navigation screen button to display a map of your current vehicle position. See *Using the Navigation System on page 7-42*, *Maps on page 7-46*, *Navigation Symbols on page 7-46*, and *Configure Menu on page 7-60*.



Press the Destination screen button to display the Destination Entry home page or the Destination Menu. The available screen buttons provide easy access to a variety of ways to enter a destination. See *Destination on page 7-48*.

## 7-8 Infotainment System

---

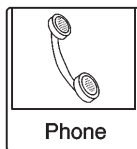

Press the Phone screen button to display the Phone main page. See *Bluetooth* on page 7-75.

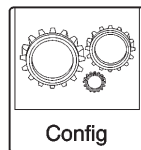

Press the Config screen button to display the Config main page. From this display, adjust features such as time and date, radio, phone, navigation, vehicle, and display. See *Configure Menu* on page 7-60.

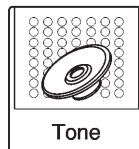

Press the Tone screen button to display the Tone main page. Adjust the tone and speakers by pressing the screen buttons to change the levels of sound for treble, midrange, bass, fade, and balance. See *AM-FM Radio* on page 7-11.

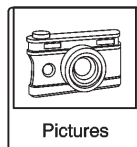

Press the Pictures screen button to view pictures on your USB drive or SD card. Pictures on the SD card can only be viewed through a USB adapter.

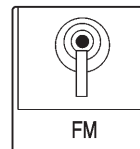

Press the FM screen button to display the FM main page and play the current or last tuned FM station. See *AM-FM Radio* on page 7-11.

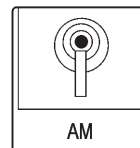

Press the AM screen button to display the AM main page and play the current or last tuned AM station. See *AM-FM Radio* on page 7-11.

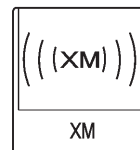



Press the XM screen button (if equipped) to display the XM main page and play the current or last tuned SiriusXM channel. See *AM-FM Radio* on page 7-11 and *Satellite Radio* on page 7-15.



Press the Pandora screen button (if equipped) to display the Pandora home page and stream personalized radio stations based on artists, songs, genres, and comedians. See *Pandora Internet Radio* on page 7-22.



Press the Stitcher screen button (if equipped) to display the Stitcher home page and stream news, sports, and entertainment shows through the audio system. See *Stitcher Internet Radio* on page 7-27.

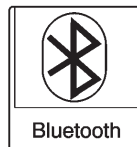

Press the Bluetooth screen button to display the Bluetooth Audio main page to play music through a Bluetooth device. See *Bluetooth Audio* on page 7-41.

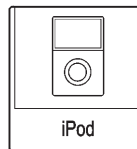

Press the iPod screen button to display the iPod main page and play the current or last track selected. See *Auxiliary Devices* on page 7-40.

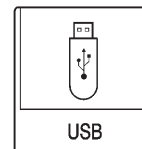

Press the USB screen button to display the USB main page and play the current or last track selected. See *Auxiliary Devices* on page 7-40.

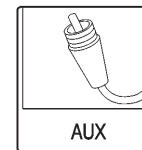

Press the AUX screen button to access any connected auxiliary device. See *Auxiliary Devices* on page 7-40.

## 7-10 Infotainment System

---

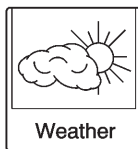

Press the Weather screen button (if equipped) to display the weather main page. Select other weather-related options from that list. See “SiriusXM Travel Link Weather” under *Satellite Radio on page 7-15*.

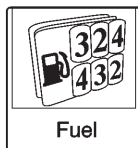

Press the Fuel screen button (if equipped) to display detailed nationwide fuel price. See “SiriusXM Travel Link Fuel Prices” under *Satellite Radio on page 7-15*



Press the Movies screen button (if equipped) to show detailed local movie theater listings, start times, and ratings if available. See “SiriusXM Travel Link Movie Listings” in *Satellite Radio on page 7-15*.



Press the Quick Info screen button to access information on Audio playing. See *Quick Info on page 7-22*.

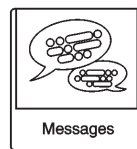

Press the Messages screen button (if equipped) to display the Text Message Inbox. See *Text Messaging on page 7-82*.

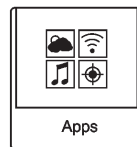

If equipped, this feature is available through the Apps button on the radio Home Page. Downloading and using Apps requires a Wi-Fi Internet connection as part of a smartphone or other mobile device data service plan. On most smartphones, activation is in the Settings menu under Mobile Network Sharing, Personal Hotspot, Mobile Hotspot, Wi-Fi Hotspot, or similar. After

activation of Wi-Fi on the smartphone, press the Apps button on the radio Home Page. Follow the prompts to configure the Internet connection and set up an account. See [www.chevrolet.com/mylink](http://www.chevrolet.com/mylink) (U.S.) or [www.mylink.chevrolet.ca](http://www.mylink.chevrolet.ca) (Canada).

### Cleaning High Gloss Surfaces and Vehicle Information and Radio Displays

For vehicles with high gloss surfaces or vehicle displays, use a microfiber cloth to wipe surfaces. Before wiping the surface with the microfiber cloth, use a soft bristle brush to remove dirt that could scratch the surface. Then use the microfiber cloth by gently rubbing to clean. Never use window cleaners or solvents. Periodically hand wash the microfiber cloth separately, using mild soap. Do not use bleach or fabric softener. Rinse thoroughly and air dry before next use.

#### Caution

Do not attach a device with a suction cup to the display. This may cause damage and would not be covered by the warranty.

### Software Updates

See the websites for more information.

### Website Information

In the U.S., see [www.chevrolet.com](http://www.chevrolet.com)

In Canada, see [www.chevrolet.gm.ca](http://www.chevrolet.gm.ca)

## Radio

### AM-FM Radio

#### Playing the Radio

#### VOL/ (Volume/Power):

- Press to turn the radio on or off.
- Turn to increase or decrease the volume of the active source.

The steering wheel controls can also be used to adjust the volume. See *Steering Wheel Controls* on page 5-2.

#### Radio Operation

The radio will work when the key is in ON/RUN or ACC/ACCESSORY. When the key is turned from ON/RUN to LOCK/OFF, the radio will continue to work for 10 minutes or until the driver door is opened.

The radio can be turned on by pressing the power button on the radio and will stay on for

## 7-12 Infotainment System

10 minutes. Opening the driver door will not turn the radio off when pressing the power button.

Some radios may stay on longer and reset the time for 10 minutes if there are any additional presses of any radio button.

The radio can be turned off at any time by pressing the power button.

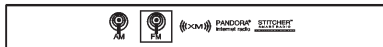

### Audio Source

Press SRCE or SRC on the steering wheel controls to display and scroll through the available sources AM, FM, XM (if equipped), Pandora (if equipped), Stitcher, USB, AUX, and Bluetooth Audio.

### Infotainment System Settings

#### Tone Settings

To access the tone settings, press the Tone Settings button on the Home Page. Tone settings are specific to each source.

To adjust the settings:

- Bass: Press + or – to change the level.
- Mid (Midrange): Press + or – to change the level.
- Treble: Press + or – to change the level.
- EQ: Press or turn the TUNE/MENU knob to cycle through the preset EQ options.
- Fade: Press the F or R button for more sound from the front or rear speakers. The middle position balances the sound between the front and rear speakers.

- Balance: Press the L or R button for more sound from the left or right speakers. The middle position balances the sound between the left and right speakers.

#### Finding a Station

Press SRCE or SRC on the steering wheel controls to select AM, FM, XM, Pandora (if equipped), Stitcher, USB, AUX, and Bluetooth Audio.

Turn the TUNE/MENU knob to find a radio station. To select a preset station, press FAV to scroll through the favorite pages and then press a preset button on the radio or the screen button.

#### Seeking a Station

Press  $\leftarrow$  SEEK or SEEK  $\rightarrow$  to search for a station.

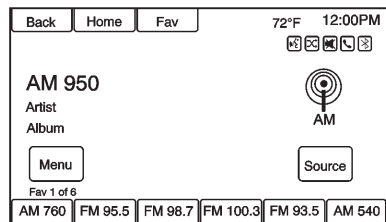

## AM

1. Press the AM screen button on the Home Page or select AM by pressing SRCE or SRC on the steering wheel controls, or say "Tune AM" or "AM" through voice recognition.
2. Press the Menu screen button to display the AM stations or categories.
3. Press to select an option. To update the station list, press Refresh.

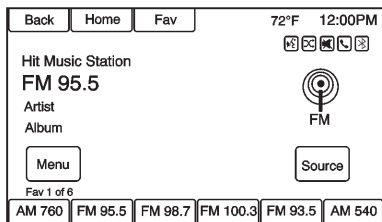

## FM

1. Press the FM screen button on the Home Page or select FM by pressing SRCE or SRC on the steering wheel controls, or say "Tune FM" or "FM" through voice recognition.
2. Press the Menu screen button to display the FM stations or categories.
3. Press to select an option. To update the station list, press Refresh.

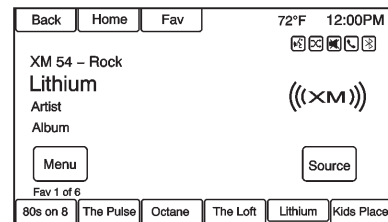

## XM (If Equipped)

1. Press the XM screen button on the Home Page or select XM by pressing SRCE or SRC on the steering wheel controls, or say "Tune XM" or "XM" through voice recognition.
2. Press the Menu screen button to display the SiriusXM categories.
3. Press a category and then turn the TUNE/MENU knob to scroll the station list. Press to select an option.

### Storing Radio Station Presets

Up to 36 preset stations can be stored. AM, FM, and XM can be mixed.

1. From the AM, FM, or XM main page, press and hold any of the 1–6 buttons or one of the preset screen buttons at the bottom of the screen. After a few seconds, a beep is heard and the new preset information displays on that screen button.
2. Repeat for each preset.

### Mixed-Band Presets

Each favorite page can store six preset stations. The presets within a page can be different radio bands.

To scroll through the pages, press the Fav screen button on the top bar. The current page number displays above the preset buttons. The stored stations for each favorite page display on the preset buttons.

To change the number of favorite pages displayed:

1. Press Config on the Home Page.
2. Press Radio Settings.
3. Press Number of Favorite Pages.

### Recalling a Preset Station

To recall a preset station from a favorites page, do one of the following:

- Press the Fav screen button at the top bar to display the preset pop-up. Press one of the preset screen buttons to go to the selected preset station.
- In the AM, FM, or XM main page, press one of the preset screen buttons to go to the selected preset station.

### Radio Data System (RDS)

RDS features are available for use only on FM stations that broadcast RDS information. With RDS, the radio can:

- Seek to stations broadcasting the selected type of programming.
- Receive announcements concerning local and national emergencies.
- Display messages from radio stations.

This system relies on receiving specific information from these stations and only works when the information is available. It is possible that a radio station could broadcast incorrect information that causes the radio features to work improperly. If this happens, contact the radio station.

When information is broadcast from the current FM station, the station name or call letters display on the audio screen. RDS can provide a

program type (PTY) for current programming and the name of the program being broadcasted.

## Satellite Radio

### SiriusXM® Satellite Radio

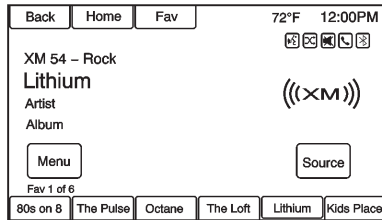

Vehicles with a valid SiriusXM satellite radio subscription can receive SiriusXM programming.

SiriusXM satellite radio has a wide variety of programming and commercial-free music, coast to coast, and in digital-quality sound. See [www.siriusxm.com](http://www.siriusxm.com) or call 1-866-635-2349 (U.S.) and [www.xmradio.ca](http://www.xmradio.ca) or call 1-877-209-0079 (Canada).

When SiriusXM is active, the channel name, number, category name, song title, and artist display on the screen. SiriusXM may update the background picture at any time.

Press the XM icon on the Home Page to access the XM Audio Menu.

### TuneSelect

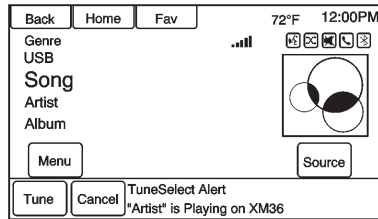

An alert will be sent when the radio sees that search criteria on any XM channel is met and offer the option to tune to that song or artist. Up to 10 artists and songs can be saved in the TuneSelect list.

To store an Artist or Song:

1. Press Menu when the Artist or Song is on XM.
2. Select TuneSelect to access the TuneSelect Menu.

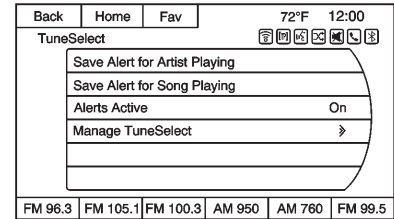

3. Select Save Alert for Artist Playing or Save Alert for Song Playing.
4. Press OK to confirm.

To turn TuneSelect on or off:

1. Press Menu when in XM.
2. Select TuneSelect.
3. Select Alerts Active to turn the alerts on or off.

## 7-16 Infotainment System

To delete TuneSelect Alerts:

1. Press Menu when in XM.
2. Press Manage TuneSelect.
3. Press Delete Alerts.
4. Select the alert to delete.
5. Press OK to confirm.

### SiriusXM Categories

SiriusXM channels are organized in categories.

### Adding or Removing XM Categories

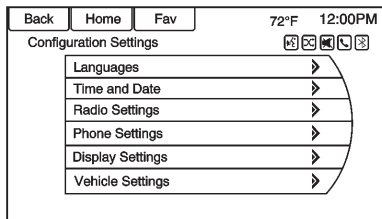

To customize which SiriusXM categories are used and displayed in the system:

1. Press CONFIG on the faceplate or the Config screen button on the Home Page.
2. Select Radio Settings from the Settings Menu list.
3. Select XM Categories.
4. Select or deselect any category to be used in XM mode. A checkmark will indicate that the category is selected.

Press Show All XM Categories to restore all SiriusXM categories.

### SiriusXM Channel Graphics

SiriusXM provides updated category background graphics and the radio will automatically update the screen. SiriusXM may send updated category graphics to the vehicle. When this happens, the background graphics may appear to be incorrect

but the radio will update once all of the graphics have been downloaded from SiriusXM.

To turn SiriusXM channel graphics on or off:

1. Press HOME on the faceplate.
2. Select XM.
3. Press Menu on the XM Now Playing Screen.
4. Press the XM Channel Art to turn on or off.

### NavTraffic® (If Equipped)

The navigation system might have a SiriusXM NavTraffic receiver. It is a subscription service provided through SiriusXM Satellite Radio. A service fee is required to receive the SiriusXM NavTraffic service. Real-time traffic information is provided to fully integrate the navigation system to display current traffic conditions for the chosen route. See "Traffic Settings" in this section for more information.



A screen displays to indicate that the SiriusXM NavTraffic subscription is not activated.

If activated, traffic information displays:

- Unscheduled traffic incident data, such as accidents and disabled vehicles.
- Scheduled traffic incident data, such as road construction and road closures.
- Traffic flow information (rate of speed data). Flow data might not be available in all markets.

Traffic information is delivered to the vehicle by the SiriusXM Radio satellites. SiriusXM NavTraffic provides continuously updated traffic information.

SiriusXM NavTraffic currently broadcasts the traffic information for many markets nationally. The service may be available in more cities in the future. Visit [www.xmnavtraffic.com](http://www.xmnavtraffic.com) for more details on local coverage.

To access the traffic features, press the Traffic button from the Navigation Menu or map screen.

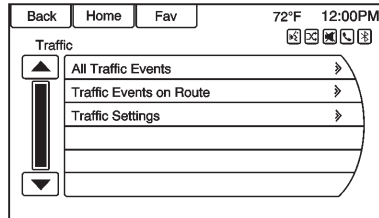

**All Traffic Events:** Press to view a list of reported traffic conditions for up to approximately 100 km (70 mi). It could take some time to display the information received.

The information is displayed with an arrow and distance. The arrow indicates the distance in a straight line and the direction of the event from the vehicle's current position.

**Traffic Events on Route:** Press to display a list of reported traffic conditions on the current route. The button is toned down if no route is active.

**Traffic Settings:** Press to customize traffic options.

### SiriusXM Travel Link (If Equipped)

The infotainment system may have SiriusXM<sup>®</sup> Travel Link. It is a subscription service provided through SiriusXM Satellite Radio. A service fee is required to receive the SiriusXM Travel Link service. When subscribed to SiriusXM Travel Link, one or more services may be available.

- **Travel Link Fuel Prices:** Detailed nation wide fuel price information may be available.
- **Travel Link Movie Listings:** Detailed local movie theater listings, start times, and ratings may be available.

## 7-18 Infotainment System

---

- Travel Link Weather: National and Local Weather gives current and forecasted weather.

For more detailed information and coverage details on SiriusXM Travel Link go to [www.siriusxm.com](http://www.siriusxm.com).

### SiriusXM Travel Link Fuel Prices

When SiriusXM Travel Link information is available, the system will display a list of fuel stations close to the vehicle location. The list will include fuel station name, direction, distance and price. The list can be sorted by distance or price and there are four different fuel types to choose from. As the vehicle is moving, a direction arrow and distance to fuel station will update. The arrow represents the direction to the gas station from the current vehicle position. The distance represents the straight line distance between the vehicle location and the fuel station.

From the Home Page, press the Fuel button.

To change the fuel information on the screen press the Fuel Menu Button to:

- Sort Fuel Stations By Price or By Distance: The default sort method is by distance.
- Choose Fuel Type: The available fuel types are Regular (unleaded), Mid-Range, Premium, and Diesel.

For more information on the fuel station, select the fuel station name. The screen will show the fuel station name, address, phone number, distance, amenities, and the last time the fuel price was updated. If a fuel station does not appear in the list, it may be new or the price may not have been updated in the past 24 hours.

If equipped with Navigation when the fuel station is selected, see *Destination on page 7-48* for more information of navigation routing features.

Allow up to five minutes after turning on the vehicle for the fuel information to appear.

### SiriusXM Travel Link Movie Listings

When SiriusXM Travel Link information is available the movie feature provides movie showtimes and theater information for movies close to the vehicle location. The Movie feature provides detailed theater and movie information including showtimes.

From the Home Page, press the SiriusXM<sup>®</sup> Movie button. The system displays the Movie and Theater search page.

To search movies:

- Select the Movie field to choose a movie name.
- Select the Theater field to choose a specific theater.
- Select the Date field to choose which date to search movies and/or theaters.

- Press the Search button to view a list of movies or theaters.

When searching by movie, a list will display movies to select. When a movie is selected, a theater list will appear with a direction arrow and distance from the current vehicle location. The direction and distance will update every 10 seconds as the vehicle is moving. The direction arrow represents the location of the theater from the current vehicle location. The distance represents the straight line distance between the vehicle location and the theater.

Movie details are available when a movie is selected. The details include Cast, Synopsis, and Theater Information. Select the appropriate button to display more information.

Cast and Synopsis:

- Playtime
- Rating (G, PG-13, R, etc.)
- Theater Name
- Showtimes

Theater information includes address, phone number, distance, and amenities.

### SiriusXM Travel Link Weather

Whether near home or on a long road trip, detailed weather information is available. SiriusXM Travel Link Weather uses the same sources that professional pilots and mariners rely on.

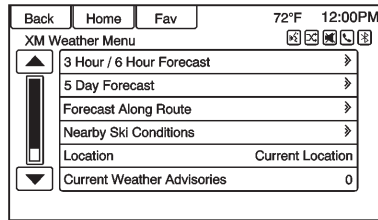

From the Home Page, press the Weather screen button. The system displays the XM Weather Menu. Some options may only be present on vehicles equipped with navigation.

### 3 Hour/6 Hour Forecast

The 3 Hour/6 Hour Forecast page shows the current weather condition in the city of the vehicle's current position.

Allow up to 15 minutes for the current weather in the area to display.

### 5 Day Forecast

Press to show the extended 5 Day forecast.

### Forecast Along the Route

If a destination is set, weather conditions can be viewed for up to three locations along the route:

- Current vehicle position.
- Midway point from current position to final destination.
- Current weather condition of the destination city.

### Nearby Ski Conditions

Select this option to view ski conditions surrounding or nearby the vehicle's current location.

### Location

Select this option to view weather conditions around or in a specific city entered by name or selected from the map.

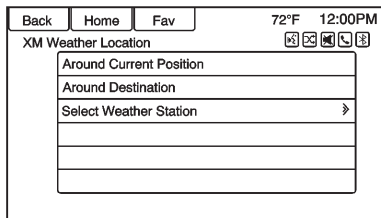

The options available are:

- Around Current Position
- Around Destination
- Select Weather Station

### Current Weather Advisories

From the XM Weather Menu, press the Current Weather Advisories screen button to display any current weather advisory warnings in effect near the current position.

### Troubleshooting

XM Travel Link services use the SiriusXM<sup>®</sup> Satellite Signal and GPS Satellite Signal to provide this feature.

When the vehicle is started, it can take up to five minutes for the radio to receive the Travel Link services.

### Travel Link Messages

**No GPS signal:** Move the vehicle into a position that is visible to the sky.

**Acquiring Signal:** Radio is downloading the activation information or not receiving a good signal. Move the vehicle to open sky and restart the vehicle.

**No XM Signal:** Reception is blocked. Move the vehicle into open sky.

### Radio Reception

Frequency interference, and static can occur during normal radio reception if items such as cell phone chargers, vehicle convenience accessories, and external electronic devices are plugged into the accessory power outlet. If there is interference or static, unplug the item from the accessory power outlet.

### FM

FM signals only reach about 16 to 65 km (10 to 40 mi). Although the radio has a built-in electronic circuit that automatically works to reduce interference, some static can occur, especially around tall buildings or hills, causing the sound to fade in and out.

## AM

The range for most AM stations is greater than for FM, especially at night. The longer range can cause station frequencies to interfere with each other. Static can occur when things like storms and power lines interfere with radio reception. When this happens, try reducing the treble on the radio.

## SiriusXM Satellite Radio Service

SiriusXM Satellite Radio Service gives digital radio reception from coast to coast in the 48 contiguous United States, and in Canada. Just as with FM, tall buildings or hills can interfere with satellite radio signals, causing the sound to fade in and out. In addition, traveling or standing under heavy foliage, bridges, garages, or tunnels may cause loss of the SiriusXM signal for a period of time.

## Cellular Phone Usage

Cellular phone usage can cause interference with the vehicle's radio.

## Backglass Antenna

The AM-FM antenna is integrated with the rear window defogger in the rear window. Do not scratch the inside surface or damage the lines in the glass. If the inside surface is damaged, it could interfere with radio reception. For proper radio reception, the antenna connector needs to be properly attached to the post on the glass.

If attaching a cell phone antenna to the glass, attach it between the grid lines.

### Caution

Using a razor blade or sharp object to clear the inside rear window can damage the rear window antenna and/or the rear  
(Continued)

### Caution (Continued)

window defogger. Repairs would not be covered by the vehicle warranty. Do not clear the inside rear window with sharp objects.

### Caution

Do not apply aftermarket glass tinting with metallic film. The metallic film in some tinting materials will interfere with or distort the incoming radio reception. Any damage caused to the backglass antenna due to metallic tinting materials will not be covered by the vehicle warranty.

## Multi-Band Antenna

The roof antenna is for SiriusXM Satellite Radio Service, OnStar<sup>®</sup> (if equipped), and GPS (Global Positioning System). Keep clear of

obstructions for clear reception. If the vehicle has a sunroof, and it is open, reception can also be affected.

### Quick Info

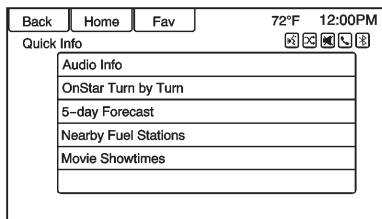

Quick Info gives access to quick information on Audio playing, OnStar Turn-by-Turn route (if equipped), 5-day forecast, Nearby Fuel Stations, and Movie Show Times.

To access, press Quick Info on the Home Page or the INFO button on the faceplate. Depending on the system and if the options are available for that region, some options may be grayed out.

**Audio Info:** Displays information on the current item playing.



**OnStar Turn by Turn:** Displays the next maneuver in a route. See *OnStar® Destination Download on page 7-59*.

**5-day Forecast:** Displays the 5-day forecast for the weather station closest to the current location. See “SiriusXM Travel Link Weather” in *Satellite Radio on page 7-15*.

**Nearby Fuel Stations:** Displays fuel prices and distances for close fuel stations. See “SiriusXM Travel Link Fuel Prices” under “SiriusXM Travel Link (If Available)” in *Satellite Radio on page 7-15*.

**Movie Showtimes:** Displays a list of movies playing in the theaters closest to the current location. See “SiriusXM Travel Link Movie Listings” under “SiriusXM Travel Link (If Available)” in *Satellite Radio on page 7-15*.

### Pandora Internet Radio

Pandora (if equipped) is a free Internet radio service that streams personalized radio stations based on artists, songs, genres, and comedians. Create stations using the Pandora website or smartphone application, then use  (thumbs up) or  (thumbs down) to personalize stations. To set up an account, or for more information, go to [www.pandora.com](http://www.pandora.com).

A phone or tablet with Internet connection and the Pandora application installed is required. Personal cell phone data plans are used. Make sure the latest version is installed on the device and the volume is turned up.

To install Pandora:

- On an Android™ phone or Android Tablet, go to the Android Play Store, and search for Pandora. Install to the phone, not to the SD card.

- On a BlackBerry® phone, go to the BlackBerry App World™ and search for Pandora.
- On an iPhone®, iPad®, or iPod touch®, go to the iTunes® Store and search for Pandora.



### Launching Pandora

Connect the iPhone, iPad, or iPod touch to the USB port, or connect an Android or BlackBerry through Bluetooth. See *Auxiliary Devices on page 7-40* or *Bluetooth on page 7-75*. For first-time use, set up stations before connecting to the vehicle. The Pandora icon will be available on the Home Page and the source pop-up displays if the latest application is installed on the device.

### Using the iPhone, iPod Touch, or iPad

1. Plug the device into the USB port. The phone screen must be unlocked.

2. To launch, do one of the following:

- Launch the application on the device.
- Press Pandora on the Home Page.
- Press  /  and say “Pandora” or “Tune Pandora.”
- Accept any notification on the screen of the device.

To relaunch Pandora, press SRCE or SRC on the steering wheel controls.

If nothing happens when the available Pandora screen button is pressed, download the latest Pandora application and retry.

Pandora will always be highlighted on the Home Page when an iPhone, iPad, or iPod touch is connected using the USB port. To use, log into your account.

If the “Please See Device” message is shown, the login screen may display on the device.

If the “Please Unlock the Phone or Restart the App and Try Again” message is shown, then the phone may be locked. Unlock the phone, close the app, then restart the app and make sure the Home Page is visible on the phone/device.



If the vehicle is shut off while tuned to Pandora and the iPhone, iPad, or iPod touch is left connected to the USB port before the next ignition cycle, the radio will start playing Pandora when the vehicle is started.

If Pandora is shut down on the phone or another audio app is used, Pandora may not start on the next ignition cycle. If iPod source is selected, it may show iPod and then switch to Pandora.

### Using an Android Phone

1. Pair the Android phone using Bluetooth.

## 7-24 Infotainment System

- Use one of the following to launch:
  - Launch the application on the device.
  - Press Pandora on the Home Page.
  - Press  /  and say "Pandora" or "Tune Pandora."

After Pandora has been launched, press SRCE or SRC on the steering wheel controls to access Pandora features.

If nothing happens when the available Pandora screen button is pressed, download the latest Pandora application and retry.



If the "Please See Device" message is shown, the login screen may display on the device.

If the "Please unlock your phone or restart the app" message is shown, then the phone may be locked.

Unlock the phone, close the app, then restart the app to ensure proper communication.

### Using a BlackBerry Phone

The phone must be unlocked. To launch Pandora service:

- Pair the BlackBerry phone using Bluetooth.
- Use one of the following to launch:
  - Launch the application on the device.
  - Press Pandora on the Home Page.
  - Press  /  and say "Pandora" or "Tune Pandora."

After Pandora has been launched, press SRCE or SRC on the steering wheel controls to access Pandora features.

If nothing happens when the available Pandora screen button is pressed, download the latest Pandora application and retry.

If the "Please See Device" message is shown, the login screen may display on the device.

If the "Please unlock your phone or restart the app" message is shown, then the phone may be locked. Unlock the phone, close the app, and then restart the app to ensure proper communication.

### Pandora Menus

Press Menu on the Pandora main page.

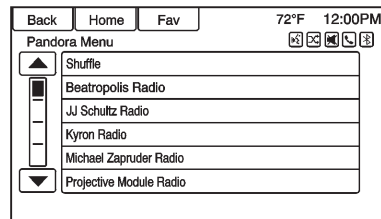



Pandora has a menu system with the following:

**Shuffle:** Press to play the stations in random order.

**User-Created Stations:** Press to play a user-created station.

**Pandora Features**

Pandora has features to rate tracks, skip tracks, or change stations.

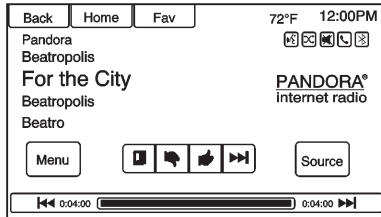

**Bookmarks:** Press while playing a track to bookmark either the track or the artist. Bookmarks are viewable on [www.pandora.com](http://www.pandora.com).

**Thumbs Down:** When pressed, Pandora stores the information, changes to the next track, and does not play the track on this station again. This helps Pandora choose which tracks should not play on this station. This feature is only available on user-created stations.

**Thumbs Up:** When pressed, Pandora stores this information and **Thumbs Up** is highlighted for the remainder of the track. This helps Pandora choose which tracks should play on this station.

**Next Track:** When pressed, Pandora changes to the next track.

**Play/Pause:** Press on the radio to pause playback. Press again to resume.

**Tuning Pandora Stations:** When Pandora is playing, use the **Thumbs Up / Thumbs Down** button on the steering wheel to tune to any Pandora Station on the device.

1. Press the **Thumbs Up / Thumbs Down** button on the steering wheel.
2. Say "Tune Pandora <Classic Rock> Radio."

Pandora voice control will not work until Pandora is launched the first time during that ignition cycle.

**Pandora Skip Limit**

Pandora limits the number of skips allowed on their service. When the skip limit is reached, **Thumbs Down** will not skip the currently playing track, but **Thumbs Down** feedback will be recorded.

**Pandora Advertisement**

Pandora may display advertisements. Artist name and track title will not be displayed and the skip track button is not available.

**Switching Between Pandora and Stitcher**

To switch between Pandora and Stitcher, press the application icon on the iPhone, iPod touch, or iPad.

## 7-26 Infotainment System

---

This is not required for Android devices. See *Stitcher Internet Radio* on page 7-27.

### Pandora Troubleshooting

#### Unable to Connect Device to Vehicle

If the device is unable to connect to the USB or Bluetooth:

1. Turn the vehicle off.
2. Remove the key from the ignition.
3. Open and close the driver door, wait about 30 seconds, and try to connect the device again.



#### Unable to Start Pandora

If the device is unable to launch Pandora:

- Check that the latest version of Pandora is installed.
- Check that there is an active account logged into Pandora.
- Have at least one station created.

- For Android and BlackBerry devices, check that the device is paired with the vehicle, and the Bluetooth icon on the display is highlighted.
- For iPhone, iPod touch, or iPad devices, check that the USB cable is connected to the USB port and the screen is unlocked.
- Close Pandora on the device and launch again. Devices that allow multitasking may require an extra step to quit the Pandora application. See the cell phone manufacturer's user guide.

#### Thumbs Up or Thumbs Down Error

If there is an error trying to rate a track with the  or  buttons, an error message will display. Press OK to retry.

#### Loss of Audio

Loss of Pandora audio can happen in different ways:

- Weak or lost data connection.

- Device needs to be charged.
- Application needs to be relaunched.
- Connection between phone and radio lost.
- If any iPhone, iPod touch, or iPad is connected to Bluetooth and the dock connector, go to the Airplay icon on the device and select dock connector or disconnect and reconnect the dock connector on the device.
- The volume is too low. Turn up the volume on the device.
- The battery saver and task manager applications on the phone can cause Pandora to function incorrectly. Remove those apps from the phone or remove Pandora and Bluetooth from the task lists.

If the connection is lost between the application and device, a message "Please unlock your phone or restart the phone app and try again" will display. Press OK to retry.

If pressing OK does not clear the issue on the phone, see "Please Unlock Your Phone or Restart Phone App and Try Again" under "Common Pandora Messages" following.

**Common Pandora Messages**

**Please See Device:** When not logged in or when authentication failed, see the device. Press OK to continue.

**Paused or Audio Paused:** Playback is paused on the radio or the device. Press ▷/|| or play on the device.

**No Stations Found:** Logged in but no stations have been created. Press OK to continue.

**Please Unlock Your Phone or Restart Phone App and Try Again:** Communication failure between the radio and the phone application, or the device is locked.

Devices that allow multitasking may require an extra step to quit the Pandora application. Close Pandora on the device and launch again.

Unlock the phone and check that Home Page is displayed on the phone/device.

See the cell phone manufacturer's user guide.

See [www.pandora.com/help](http://www.pandora.com/help) for more information. If the service will not work, see your dealer for assistance.

**Stitcher Internet Radio**

Stitcher SmartRadio™ is an Internet radio service that streams news, sports, and entertainment shows through the audio system. Create personalized, on-demand stations or discover new shows through

Stitcher's preset stations. To set up an account, download the application from the Android Market or iTunes Store, or go to [www.stitcher.com](http://www.stitcher.com).

A phone or tablet with Internet connection is required for this application. Personal cell phone data plans are used. Make sure the latest version is installed on the device and the volume on the device is turned up.

BlackBerry phones are not supported for this application.

To install Stitcher:



- On an Android phone or Tablet with Internet connection, go to the Android Play Store, search for Stitcher, and install to the phone, not to the SD card.
- On an iPhone, iPad, or iPod touch, go to the iTunes Store and search for Stitcher.

### Launching Stitcher

Connect the iPhone, iPad, or iPod touch to the USB port, or connect Android through Bluetooth. See *Auxiliary Devices on page 7-40* or *Bluetooth on page 7-75*. For first-time use, set up the stations before connecting to the vehicle. The Stitcher icon will be available on the Home Page and source pop-up displays if the latest application is installed on the device.

### Using the iPhone, iPod Touch, or iPad

1. Plug the device into the USB port. The phone screen must be unlocked.
2. Use one of the following to launch:
  - Press the application on the device.
  - Press Stitcher on the Home Page.

- Press  /  and say "Stitcher" or "Tune Stitcher."
- Accept any notification on the screen of the device.

3. If Stitcher does not begin playing, select a category and then a station.

After Stitcher has been launched, press SRCE or SRC on the steering wheel controls to access Stitcher features.

If nothing happens when the available Stitcher screen button is pressed, download the latest Stitcher application and retry.



Stitcher will always be highlighted on the Home Page when an iPhone, iPad, or iPod touch is connected using the USB port. To use, log into your account.

If the "Please See Device" message is shown, the login screen may display on the device.

If the "Please unlock your phone or restart the app" message is shown, then the phone may be locked.

Unlock the phone, close the app, then restart the app to make sure the Home Page is visible on the phone/device.

### Using an Android Phone

1. Pair the Android phone using Bluetooth.
2. Use one of the following to launch:
  - Press the application on the device.
  - Press Stitcher on the Home Page.
  - Press  /  and say "Stitcher" or "Tune Stitcher."
3. If Stitcher does not begin playing, select a category and then a station.

After Stitcher has been launched, press SRCE or SRC on the steering wheel controls to access Stitcher features.

If nothing happens when the available Stitcher screen button is pressed, download the latest Stitcher application and retry.

If the “Please See Device” message is shown, the login screen may display on the device.

If the “Please unlock your phone or restart the app” message is shown, then the phone may be locked. Unlock the phone, close the app, then restart the app to ensure proper communication.

### Stitcher Menus

Press Menu on the Stitcher main page.

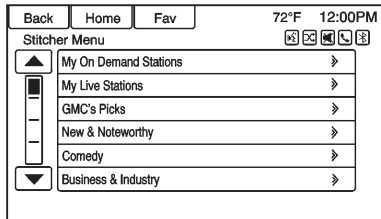

Stitcher has a menu system with the following:

**My On Demand Stations:** Displays a list of favorite stations and shows.

Select and store programs as favorites on the device. Favorite station lists can be created to include favorite shows which can be accessed through My On Demand Stations.

**Stitcher Station Categories:** Displays categories by topic.

When a category then sub-category is selected, the radio will start playing the first program in that sub-category.

Turn the TUNE/MENU knob to display the first 24 stations of that sub-category.

**Current Station Playlist:** While listening to a show, turn the TUNE/Menu knob to display the menu list of shows available for the current station.

### Stitcher Features

Stitcher service has features to rate or skip shows, or change stations.

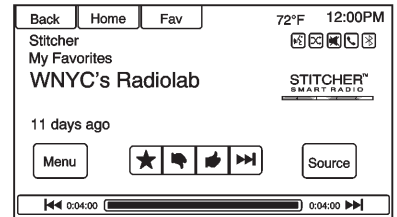

★ **(Favorites):** When pressed, the current show is added to the favorites station.

👎 **(Thumbs Down):** When pressed, Stitcher changes to the next show. This helps Stitcher provide a personalized listening experience.

👍 **(Thumbs Up):** When pressed, Stitcher stores this information and 👍 is highlighted for the remainder of

## 7-30 Infotainment System

---

the show. This helps Stitcher provide a personalized listening experience.

▶▶ **(Next Show):** When pressed, Stitcher changes to the next show.

▷/|| **(Play/Pause):** Press on the radio to pause playback. Press again to resume.

### Stitcher Advertisement

Stitcher may display advertisements. Artist name and title may not display and the skip track button is not available.

### Stitcher Troubleshooting

#### Unable to Connect Device to Vehicle

If the device is unable to connect to the USB or Bluetooth:

1. Turn the vehicle off.
2. Remove the key from the ignition.
3. Open and close the driver door, wait about 30 seconds, and try to connect the device again.

The battery saver and task manager applications on the phone can cause Stitcher to function incorrectly. Remove those apps from the phone or remove Stitcher and Bluetooth from the task lists.

#### Unable to Start Stitcher

If the device is unable to launch Stitcher:

- Check that the latest version of Stitcher is installed.
- Check that there is an active account logged into Stitcher.
- For Android devices, check that the device is paired with the vehicle, and the Bluetooth icon on the display is highlighted.
- For iPhone, iPod touch, or iPad devices, check that the USB cable is connected to the USB port and the screen is unlocked and the Home Page is showing.
- Close Stitcher on the device and launch again. Devices that allow multitasking may require an

extra step to quit the Stitcher application. See the cell phone manufacturer's user guide.

#### Loss of Audio

Loss of Stitcher audio can happen due to:

- Weak or lost data connection.
- Device needs to be charged.
- Application needs to be relaunched.
- Connection between phone and radio is lost.
- If any iPhone, iPod touch, or iPad is connected to Bluetooth and the dock connector, go to the Airplay icon on the device and select dock connector or disconnect and reconnect the dock connector on the device.
- The volume is too low. Turn up the volume on the device.

If the connection is lost between the application and device, a message “Please unlock your phone or restart the phone app and try again” will display. Press OK to retry.

If pressing OK does not clear the issue, see “Please Unlock Your Phone or Restart Phone App and Try Again” under “Common Stitcher Messages” following.

**Common Stitcher Messages**

**Please Try Again Later:** A general error has occurred. A data connection may be unavailable due to a weak or lost signal or the Stitcher service being temporarily down. Press OK to continue.

**Paused or Audio Paused:** Playback is paused on the radio or the device. Press  $\triangleright$ /|| or play on the device.

**Please See Device:** When the user is not logged in or when authentication failed, see the device. Press OK to continue.

Disconnect the phone from the radio and follow the Stitcher account login process on the phone.

**No Stations Found:** Logged in but no stations have been created. Press OK to continue.

**Please Choose a New Station:** The end of the station has been reached and there is no more content to play. Select a new station through the Stitcher menu.

**Please Unlock Your Phone or Restart Phone App and Try Again:** Communication failure between the radio and the phone application or the device is locked.

See [www.stitcher.com/help](http://www.stitcher.com/help) for more information. If the service will not work, send an e-mail to [feedback@stitcher.com](mailto:feedback@stitcher.com) or see your dealer for assistance.

**Pictures**

Pictures can only be viewed using USB devices. If pictures are on an SD card, transfer to a USB device

or use a USB-SD adapter. A maximum 5Mb uncompressed photo size is supported, however to achieve this, use a 4 Megapixel or lower resolution camera setting. Only jpeg, bmp, gif, and png files are supported.

1. Press the Pictures screen button on the Home Page.
2. The system does a search to find the picture folders. A “Please wait” message displays until the search is finished.

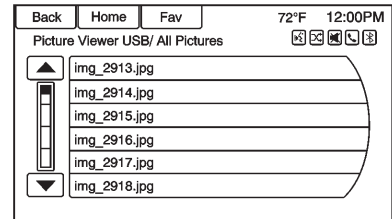

3. A list displays. Select a picture to view.

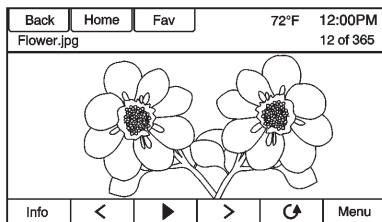

4. Once a picture displays, the following options are available:

**Info:** Press to turn file name information on or off.

**<:** Press to display a previous picture if not in slide show mode.

**▶:** Press to toggle between slide show mode and manual mode.

**>:** Press to display a next picture if not in slide show mode.

**↻:** Press to manually turn a picture 90 degrees counterclockwise.

**Menu:** Press to open the Picture Viewer Settings screen. Slide Picture Viewer Main, Slideshow Timer, and Shuffle Images display as options for configuring the view of images stored in the system.

If the displayed picture screen is not used within six seconds, the upper and lower bar options will disappear. Touch-tap the screen to re-display the upper and lower bar.

## Audio Players

### CD Player

The CD player is capable of playing:

- Most audio CDs
- CD-R
- CD-RW
- MP3, unprotected WMA, and AAC formats

When playing any compatible recordable disc, the sound quality may be reduced due to the disc, the method of recording, the quality of the music recorded, or how the disc has been handled.

There may be increased skipping, difficulty reading recorded tracks, finding tracks, and/or loading and ejecting. If these problems occur, check the disc for damage or try a known good disc.

To avoid damage to the CD player:

- Do not use scratched or damaged discs.



- Do not apply labels to discs. The labels could get caught in the player.
- Insert only one disc at a time.
- Keep the loading slot free of foreign materials, liquids, and debris.
- Use a marking pen to label the top of the disc.

### Loading and Ejecting Discs

To load a disc:

1. Turn the infotainment system on.
2. Insert a disc into the slot, right side up. The player pulls it in the rest of the way. If the disc is damaged or improperly loaded, there is an error and the disc ejects.

The disc automatically plays once loaded.

Press  to eject a disc from the CD player. If the disc is not removed within a short period of time, it is automatically pulled back into the player.

### Playing an Audio CD

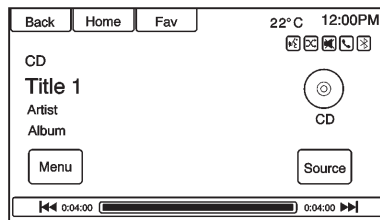

1. Press the CD screen button on the Home Page or select CD from the source pop-up to display the CD main page.
2. Press the Menu screen button to display the menu options.
3. Press to select the option.

On the CD main page, the track number displays and the Song, Artist, and Album information displays when available.

Use the following radio controls to play the disc:

 **(Play/Pause):** Use to pause or resume play.

This is not available on vehicles with Navigation.

 **SEEK:**

- Press to seek to the beginning of the current or previous track. If the track has been playing for fewer than five seconds, it seeks to the previous track. If longer than five seconds, the current track starts from the beginning.
- Press and hold to fast reverse through a track. Release the button to return to playing speed. Elapsed time displays.

 **SEEK:**

- Press to seek to the next track.

## 7-34 Infotainment System

---

- Press and hold to fast forward through a track. Release the button to return to playing speed. Elapsed time displays.

**TUNE/MENU Knob:** Turn to the right or left to select the next or previous track. Press the knob to select from the list. If a track is selected from the menu, the system plays the track and returns to the CD screen.

### Error Messages

If Disc Error displays and/or the disc comes out, it could be due to:

- The disc has an invalid or unknown format.
- The disc is very hot. Try the disc again when the temperature returns to normal.
- The road is very rough. Try the disc again when the road is smoother.
- The disc is dirty, scratched, wet, or upside down.

- The air is very humid. Try the disc again later.
- There was a problem while burning the disc.
- The label is caught in the CD player.

If the CD is not playing correctly, try a known good CD.

If any error continues, contact your dealer.

## USB

### Playing from a USB

A USB mass storage or Certified Windows Vista<sup>®</sup>/Media Transfer Protocol (MTP) device can be connected to the USB port.

The USB port is in the center console under the armrest.

The USB icon displays when the USB device is connected.

### USB Media Formats

The USB port will support the following media formats:

- MP3
- Unprotected WMA
- Unprotected AAC

Other formats may be supported.

### Gracenote<sup>®</sup>

Gracenote technology embedded into the radio helps manage and navigate the USB device music collection. When a USB device is connected to the radio, Gracenote identifies the music collection and delivers the correct album, artist name, genres, and cover art on the screen. If information is missing, Gracenote will fill it in.

### Searching Music Library Using Voice Recognition

**Voice Recognition:** Gracenote improves music search and navigation by identifying bands, artists, and albums names that may

be hard to pronounce, irregular spellings, and nicknames. For example, Gracenote helps the system understand artist names like “INXS” or “Mötley Crüe.” It also allows the use of names like: “The Boss,” “G.N.R.,” “The Fab Four,” and thousands of other famous artist nicknames as voice commands to access music. See *Voice Recognition on page 7-68*.

**Normalization:** Normalization helps to improve the voice recognition accuracy for titles that sound similar. It also helps group long lists of genres into 10 common genres. For example, there may be multiple rock genres in the media library; normalization will group all those into one rock genre. Normalization default is off.

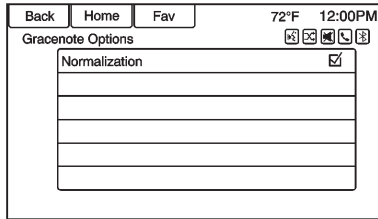

To turn Normalization on:

1. Press CONFIG or Config on the Home Page.
2. Press Radio Settings, then press Gracenote Options.
3. Press Normalization to turn on or off.

**Cover Art:** The Gracenote embedded database contains cover art or album art information for the music on the USB device. If the music is recognized by Gracenote and does have cover art, Gracenote will use the cover art found in the embedded database and display it on the radio. User predefined cover art will always be used first. If no

cover art is found Gracenote will use generic Genre graphics or images of artists.

**More Like This**

The Gracenote database contains attributes for Music, such as genre, era of music, region, artist type, mood, etc. Use this to create a playlist of up to 30 songs "more like" currently listened to song. This playlist will be stored in the Playlist Menu when the device is reconnected. If songs are removed from the device, the system will simply skip over those songs and play the next available song.

Use the touch screen or voice recognition to create a More Like This Playlist. See “Voice Recognition Commands” in *Voice Recognition on page 7-68*.

**Gracenote Indexing**

While Gracenote is indexing, infotainment features are available including selecting music from the menu. Voice recognition music will

## 7-36 Infotainment System

---

not be available until the radio has completed indexing the device. Devices with more music may take longer to index. The device will index when plugged into the radio for the first time. When Indexing is removed from the screen, the radio is ready to support music search. On the next connection or ignition cycle, Indexing will show briefly on the screen. The radio is searching for changes to the device and preparing the music list. If there are no changes, the voice recognition music search will be available. The radio will index and store two devices with up to 10,000 songs on each device.



### USB MP3 Player and USB Drives

- The USB MP3 players and USB drives connected must comply with the USB Mass Storage Class specification (USB MSC).
- Hard disk drives are not supported.
- The radio will not be able to play back write-protected music.

- File system supported: FAT32.
- The following restrictions apply for the data stored on a USB MP3 player or USB device:
  - Maximum folder structure depth: eight levels.
  - Maximum number of MP3/WMA files that can be displayed: 10,000.
  - Playlist entries must be in the form of relative paths.
  - The system attribute for folders/files that contain audio data must not be set.

To play a USB device, do one of the following:

- Connect the USB and it begins to play.
- Press the Now Playing screen button on the Home Page.
- Press SRCE to scroll until the USB source screen is available.

- Press  /  on the steering wheel controls to select songs by Artist, Album, Song Title, or Song Genre. See *Voice Recognition on page 7-68*.

The following playlist formats are supported:

- M3U (Standard and Extended)
- iTunes
- PLS (Standard)
- WAX
- ASX
- RMP

The radio supports plugging a cell phone in as a USB drive as long as the cell phone supports USB mass storage class or has USB disc drive support enabled.

While the USB source is active, use the following to operate USB function:

**TUNE/MENU Knob:** Turn to scroll through the list. Turn quickly to fast scroll alphabetically through large lists.

▷/|| (**Play/Pause**): Press to start, pause, or resume play of the current media source.

◀ (**SEEK (Previous/Reverse)**):

- Press to seek to the beginning of the current or previous track. If the track has been playing for less than five seconds, the previous track plays. If playing longer than five seconds, the current track restarts.
- Press and hold to reverse quickly through playback. Release to return to playing speed. Elapsed time displays.

▷ (**SEEK (Next/Forward)**):

- Press to seek to the next track.

- Press and hold to advance quickly through playback. Release to return to playing speed. Elapsed time displays.

**USB Menu**

The following are available through the USB Menu:

**Shuffle:** Press to play the tracks randomly. Press again to stop shuffle.

**Play More Like This:**

1. Press to automatically create a playlist of songs that are like the song currently playing.
2. The radio will show “Playlist Creation Succeeded” and continue playing the current song.

Playlist Creation Failed may appear if a song is not found in the Gracenote Database.

**Delete Automatic Playlist:** Press to delete a More Like this playlist.

**Folders:** Press to open a folder list to access the files within the folder structure.

**Playlists:**

1. Press to view the playlists on the USB.
2. Select a playlist to view the list of all songs in that playlist.
3. Select a song from the list to begin playback.

**Artists:**

1. Press to view the list of artists on the USB.
2. Select an artist name to view a list of all albums by the artist.
3. To select a song, press Songs List or press an album and then select a song from the list.

**Albums:**

1. Press to view the albums on the USB.
2. Select the album to view a list of all songs on the album.

## 7-38 Infotainment System

3. Select a song from the list to begin playback.

### Genres:

1. Press to view the genres on the USB.
2. Select a genre to view a list of all songs of that genre.
3. Select a song from the list to begin playback.

### Songs:

1. Press to display a list of all songs on the USB.
2. Songs are displayed as they are stored on the disc. To begin playback, select a song from the list.

### File System and Naming

The songs, artists, albums, and genres are taken from the file's song information and are only displayed if present. The radio displays the file name as the track name if the song information is not available.

### Playing from an iPod®

This feature supports the following iPod models:

- iPod classic® (6th generation)
- iPod nano® (3G, 4G, 5G, and 6G)
- iPod touch® (1G, 2G, 3G, and 4G)

There may be problems with the operation and function in the following situations:

- When connecting an iPod on which a more recent version of the firmware is installed than is supported by the infotainment system.
- When connecting an iPod on which firmware from other providers is installed.

To connect an iPod:

1. Connect one end of the standard iPod USB cable to the iPod's dock connector.

2. Connect the other end to the USB port in the center console.

iPod music information displays on the radio's display and begins playing through the vehicle's audio system.

The iPod battery recharges automatically while the vehicle is on. The iPod shuts off and stops charging when the vehicle is shut off.

If the iPod is an unsupported model, it can still be listened to in the vehicle by connecting to the auxiliary input jack using a standard 3.5 mm (1/8 in) stereo cable.

### iPod Menu

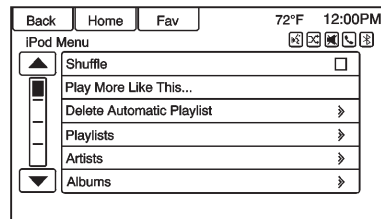

Use the iPod Menu to select:

**Shuffle:** Press to play the tracks randomly. Press again to stop shuffle.

**Play More Like This:** Allows the radio to create playlists with songs/tracks that are similar to what is being listen to. The radio will create a playlist with up to 30 similar songs. The playlist will appear in the Playlist category of the menu for future listening.

1. Press to automatically create a playlist of songs that are like the song currently playing.
2. The radio will show "Playlist Creation Succeeded" and continue playing the current song.

**Delete Automatic Playlists:** Press to delete a More Like This playlist.

**Playlists:**

1. Press to view the playlists on the iPod.

2. Select a playlist name to view a list of all songs in the playlist.
3. Select the song from the list to begin playback.

**Artists:**

1. Press to view the artists on the iPod.
2. Select an artist name to view a list of all albums with songs by the artist.
3. Select an album.
4. Select the song from the list to begin playback.

**Albums:**

1. Press to view the albums on the iPod.
2. Select an album name to view a list of all songs on the album.
3. Select the song from the list to begin playback.

**Songs:**

1. Press to view a list of all songs on the iPod.

2. Select the song from the list to begin playback.

**Genres:**

1. Press to view the genres on the iPod.
2. Select a genre name to view a list of artists of that genre.
3. Select an artist to view all albums of that genre.

**Podcast:**

1. Press to view the podcasts on the iPod.
2. Select a podcast name to begin playback.

**Composers:**

1. Press to view the composers on the iPod.
2. Select the composer to view a list of songs by that composer.
3. Select a song from the list to begin playback.

### Audio Books:

1. Press to view the audio books on the iPod.
2. Select the audio book from the list to begin playback.

### Playing from an iPhone or iPad

This feature supports the following iPhone or iPad models:

- iPhone® (2G, 3G, 3GS, 4, 4S, and 5)
- iPad® (1G, 2G)

Follow the same instructions as stated earlier for using an iPod. To use voice recognition to play music, say “Play USB,” “Play Artist,” “Play Album,” “Play Song,” or “Play Genre.” See *Voice Recognition on page 7-68*.

### iPhone, iPod Touch and iPad Troubleshooting

When an iPhone, iPod touch, or iPad are connected through USB and Bluetooth, the audio may not be heard when the iPod source on the

radio is selected. If a phone call is received while listening to the iPod source and there is no audio for the iPod after the source, then go to the Airplay icon on the device and select dock connector or disconnect and reconnect the dock connector on the device.

Some functionality may differ based on operating system version on device.

### USB Troubleshooting

If the device is not being recognized or the music is missing screen information, restore the radio defaults:

1. Press Config.
2. Press Vehicle Settings.
3. Press Return to Factory Settings.
4. Press Yes.

Pair the phone again and the device will have to index again.

### Bluetooth Audio and Voice Recognition

See *Bluetooth Audio on page 7-41* and *Voice Recognition on page 7-68* for information using voice recognition with Bluetooth audio.

Make sure all devices have the latest software downloaded.

### Auxiliary Devices

This vehicle has an auxiliary input jack in the center console. Possible auxiliary audio sources include:

- Laptop computer
- MP3 player
- Tape player

This jack is not an audio output. Do not plug headphones into the auxiliary input jack. Set up any auxiliary device while the vehicle is in P (Park).

Connect a 3.5 mm (1/8 in) cable from the auxiliary device to the auxiliary input jack. When a device is connected, the system



automatically begins playing audio from the device over the vehicle speakers.

If an auxiliary device has already been connected, but a different source is currently active, do one of the following:

- Press SRCE to scroll all of the available audio source screens, until the AUX source screen is selected.
- Say “Play Front AUX” using voice recognition to play the auxiliary device. See *Voice Recognition on page 7-68*.

## Bluetooth Audio

If equipped, music may be played from a paired Bluetooth device. See “Pairing a Phone/Device” under *Bluetooth on page 7-75*.

To play music through a Bluetooth device:

1. Power on the device, pair, and connect the device.

2. Music can be launched by doing one of the following:

- Press the Bluetooth Audio screen button on the Home Page.
- Press SRCE until Bluetooth Audio is selected.
- Press the SRC button on the steering wheel controls until Bluetooth Audio is selected. See *Steering Wheel Controls on page 5-2*.
- Use voice recognition. See *Voice Recognition on page 7-68*.

The music can be controlled by either the infotainment controls or the controls on the device.

When a phone is connected to the system through Bluetooth Audio the phone notifications and sounds may not be heard on the phone until Bluetooth is disconnected. Notification features may vary based

on the phone. Check the phone’s manufacture information for notification support.

### Bluetooth Audio Menu

Press the Menu screen button and the following may display:

**Shuffle:** Press the TUNE/MENU knob to turn shuffle on or off. Not all devices support the shuffle feature.

When selecting Bluetooth audio, the Bluetooth device internal music player may not open depending on the status of the device. All devices launch and play back audio differently. Make sure the correct audio source is playing on the device for Bluetooth audio playback on the radio. When the vehicle is not moving, use the device to begin playback.

When selecting Bluetooth audio as a source, the radio may source to Bluetooth Audio Paused screen and no audio playing. Press play on the device or press ▷/|| to begin

## 7-42 Infotainment System

playback. This may happen depending on how the device communicates over Bluetooth.

Some phones support sending Bluetooth music information to display on the radio. When the radio receives this information, it will check to see if any album art is available and display it.

When playing music on the radio from a Bluetooth device, make sure the Bluetooth device is unlocked and the intended music application is showing on the home screen.

For iPhone/iPod touch and iPad devices, Bluetooth Audio will not work if the device is connected through the USB and Bluetooth at the same time.

### Navigation

#### Using the Navigation System

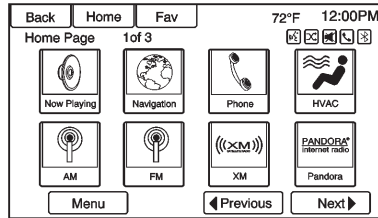

Use the NAV button on the faceplate or Navigation on the Home Page to access the navigation map.

Press the NAV button again to change between alternative views of the normal split and full map views.

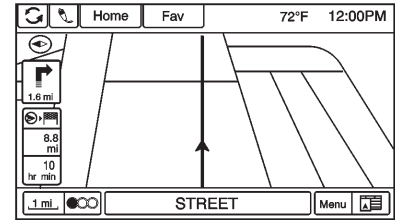

The Menu screen button at the bottom right side of the display accesses the Navigation Menu.

The touch-sensitive buttons available are:

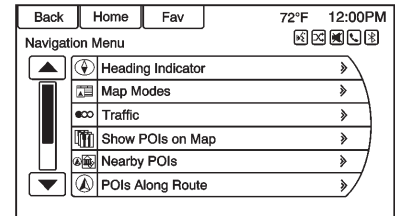

### Destination Entry

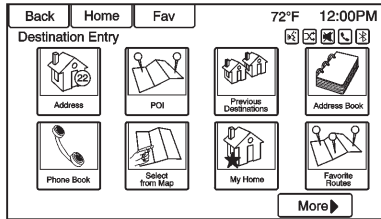

Press Destination Entry to display the Destination home page. Select a destination option. See *Destination* on page 7-48.

### Heading Indicator

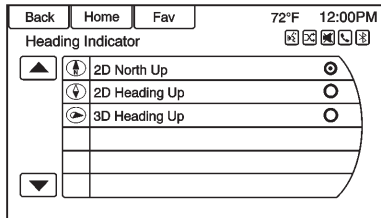

Press Heading Indicator to display the Map View. There are three indicator settings:

- 2D North Up: Displays North at the top of the map screen regardless of the direction the vehicle is traveling.
- 2D Heading Up: Displays the direction the vehicle is traveling. The shaded triangle icon points North.
- 3D Heading Up: Is the same as 2D Heading Up, but the map is in 3D.

### Map Modes

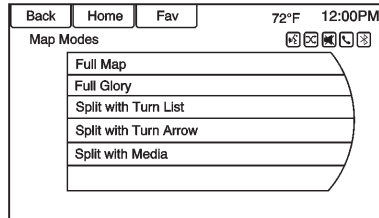

Press to change the view of the maps while using the navigation function. The system offers a variety of full and split views. Some views are only selectable when route guidance is active.



An alternative method to change the view of the maps would be to press the map mode icon.

### Map Settings

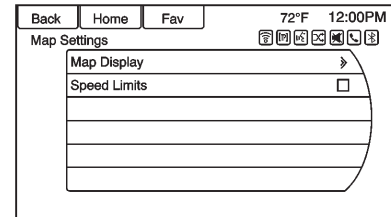

## 7-44 Infotainment System

Press Map Settings to display the Map Display line item. Press Map Display to select one of the available options:

- Automatic
- Day
- Night

See *Configure Menu on page 7-60*.

Select Speed Limits to toggle the speed limit display on or off.

### Traffic

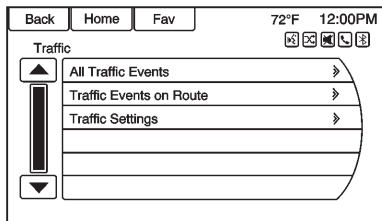

Press Traffic to display the Traffic Menu. Press the desired option.

Options available are:

- All Traffic Events: Press to view all reported traffic events while on or off a planned route.
- Traffic Events on Route: Press to view traffic events while on a planned route.
- Traffic Settings: Press to customize traffic options. This feature can also be accessed by pressing the traffic light screen button displayed at the left lower side of the map screen. See *Configure Menu on page 7-60* in this section.

### Nearby POIs

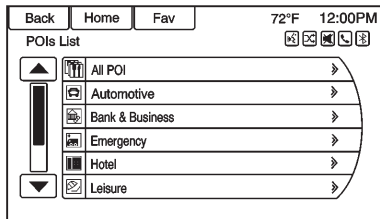

Press to display a search list of nearby POIs. Select the desired POI.

### POIs Along Route

Press to display a search list of POIs that lie along or near the route to the destination. Select the desired POI.

### Show POIs on Map

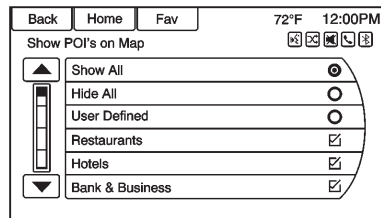

Press to customize which major POI categories are displayed on the map.

### Switch Route Time/Destination

Press to customize the arrival/travel time and waypoint/destination information displayed in the main map screen.

### Current Position Info

Press to display a split screen showing detailed information about the vehicle position. This feature can also be accessed by pressing the vehicle information tab on the lower center of the display. The location can be saved to the Address Book by pressing Save in the split screen.

### Destination Position Info

Press to display a split map screen showing the next waypoint/destination. The location can be saved to the Address Book by pressing Save in the split screen.

### Map Adjustments

The system lets you adjust the scale of view on the map. Also, as you drive, the map scrolls automatically based on the direction of travel.

### Map Scales

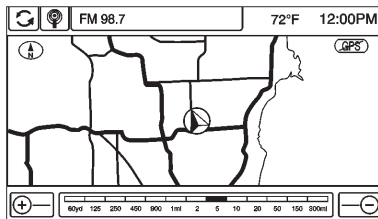

There are two methods to change the map scale:

- Turn the TUNE/MENU knob clockwise or counterclockwise to zoom out or in.
- Press the Map Scale + or - button on the bottom corners of the map screen to change the zoom level.

The map scale bar times out if the zoom level is not changed within a few seconds.

The scale can be configured for English or metric units. To change from English to metric, see *Driver Information Center (DIC)* on page 5-21.

### Scroll Features



- To scroll within the map, touch anywhere on the map screen and the scroll symbol displays.
- Tap the map to center at that location on the screen.
- Press and hold the screen in any direction outside the scroll symbol to scroll the map in that direction.

## 7-46 Infotainment System

- Scroll speed increases when touching closer to the edge of the screen.
- Press NAV on the faceplate to exit map scrolling and return to the current vehicle location on the map.



Press the cycling arrows at the top of the map screen to toggle from the normal top bar (Home and Fav) to the audio information bar.

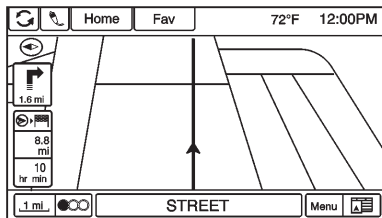

### Maps

This section includes basic information about the map database.

The data is stored in internal flash memory that is used in the navigation system.

### Detailed Areas

Road network attributes are contained in the map database for detailed areas. Attributes include information such as street names, street addresses, and turn restrictions. A detailed area includes all major highways, service roads, and residential roads. The detailed areas include points of interest (POIs) such as restaurants, airports, banks, hospitals, police stations, gas stations, tourist attractions, and historical monuments. The map database may not include data for newly constructed areas or map database corrections. The

navigation system provides full route guidance in the detailed map areas.

### Navigation Symbols

Following are the most common symbols that appear on a map screen.



The vehicle symbol indicates the current position and heading direction of the vehicle on the map.

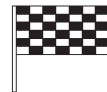

The destination symbol marks the final destination after a route has been planned.

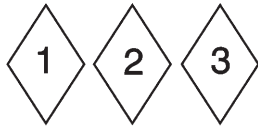

The waypoint symbol marks one or more set waypoints.

A waypoint is a stopover destination point added to the planned route.

The estimated time and distance to the destination are displayed.

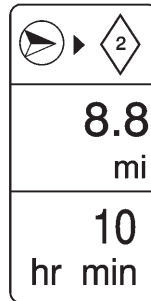

If waypoints have been added to the current route, each waypoint destination displays estimated time and distance.



This symbol indicates that the map view is North up: North up displays North at the top of the map screen regardless of the direction the vehicle is traveling.

Select this screen symbol to change the view to Heading up or 3D.



This symbol indicates that the map view is Heading up.

Heading up view displays the direction the vehicle is traveling at the top of the map screen. The shaded triangle indicates North.

Press this screen symbol to change to 3D mode.

The 3D symbol is the same as the Heading up symbol, but the map is in 3D.



## 7-48 Infotainment System

The No GPS symbol appears when there is no Global Positioning System (GPS) satellite signal.

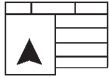

This symbol at the bottom of a map screen changes the current map mode screen.



This symbol on the right of the map screen displays the speed limit while on a route. The speed limit may not be accurate due to changes from the Department of Transportation, the local

municipalities or older map data. Always follow the posted speed limit on the road.

### Driving on a Route

#### Urgent Maneuver Alert

The system will give an indication that the next maneuver is close.

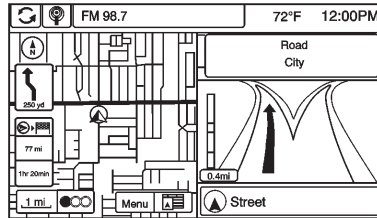

#### Driving on a Highway

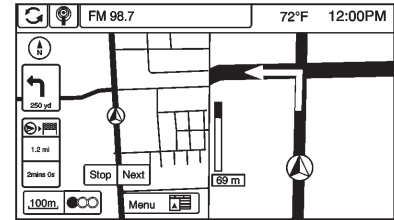

#### Driving on a Residential Road

### Destination

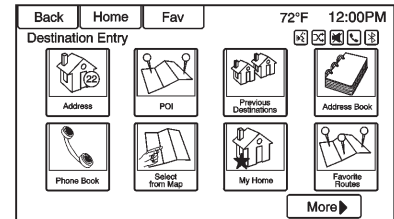

If route guidance is not active, press the Destination screen button on the Home Page to access the Destination Entry screen. Several options can be selected to plan a route by entering destinations.



Some destination entry items such as Previous Destinations, Address Book, and My Home may be grayed out if no destination was previously entered or saved.

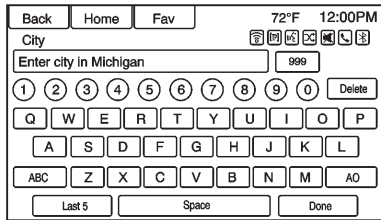

Letters of the alphabet, symbols, punctuation, and numbers, when available, display on the navigation screen as alpha/numeric keyboards. The alpha keyboard displays when data needs to be entered.

**ABC or QUERTY:** Press to toggle between ABC or QUERTY keyboard character layouts.

**ÄÖ:** Press to access an alternate language keyboard.

**Sym:** Use to select symbols.

**Space:** Use to enter a space between characters or the words of a name.

**Delete:** Press to delete an incorrect character that has been selected.

### Address Entry



Press the Address screen button to display the Address Entry screen. Set a route by entering the state name, city name, street name, house number, and intersection.

If no state or province has been entered previously, the city and state fields are not available. Press the screen button at the right of the city name to select a state or province.

If the state or province was previously set and is displayed, press the screen button at the right of the city name to change the selected state or province.

To make name selection easier, the system highlights only characters that are available after the previously entered one.

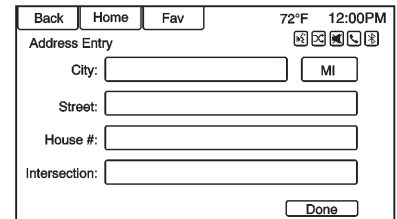

**State:** Enter a state name.

**City:** Enter a city name.

**Street:** Enter a street name.

**House #:** Enter a valid address number.

## 7-50 Infotainment System

**Intersection:** Enter a street name that intersects with the selected street.

Entering the city name first:

1. Enter the city name.
2. Enter the street name. Use the Delete screen button to delete an incorrectly entered character.

A list displays if six or fewer names are available. If there are more than six, there is a match counter with a number of available streets. Press the List screen button to view the list and select the street.

3. Enter the house number.
4. Press the Done screen button at any time and the system tries to resolve a destination based on the entered information, then displays it on the screen.

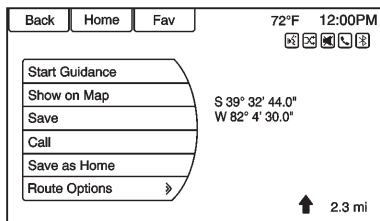

5. Press the Start Guidance screen button and the route calculates.

### To Enter a Destination in Canada

To change the destination address from the United States to Canada, the country will need to change in the navigation system. To change the country address:

1. Press the Destination screen button on the Home Page.
2. Press the address screen button to display the Enter Address screen.

3. Go to the State/Province line option and select. The Province entry screen displays. Select the Country line option. The Country List displays.
4. Select Canada.
5. Enter Province and confirm the selection.

### Entering a Destination in Other Countries

To change the destination address from the United States to another country, the country will need to change in the navigation system.

To change the country address:

1. Press the Destination screen button on the Home Page.
2. Press the Address screen button to display the Address Entry screen.
3. Go to the State/Province line option and select. The State/Province entry screen displays.

Select the Country line option. The available Country List displays.

4. Select the desired country. For example, select Canada as a default country.
5. Enter State/Province. For example, enter Ontario and confirm the selection.

The destination in other countries can also be changed using voice recognition. See *Voice Recognition on page 7-68*.

### Points of Interest (POI)

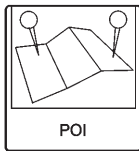

Press the Points of Interest screen button on the Destination Entry page. Several options can be selected to plan a route.

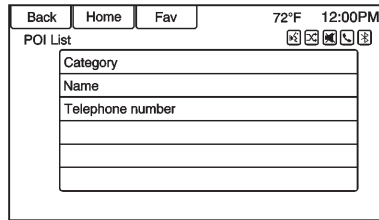

The POI List allows selection of a destination search by Category, Name, or Telephone Number.

Entering by POI name:

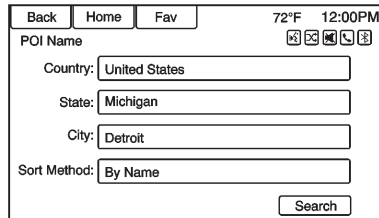

1. Select Search by Name.
2. Make sure the correct country, state/province, and city are present, then select Search.

3. Enter the POI name.
4. Select a few of the characters or spell the name in full, by using the alpha keyboard.
5. Select the Done screen button, or if the list has six or fewer items, a list of POIs will immediately display.
6. Press the desired POI.

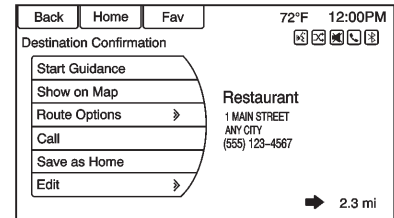

7. Press the Start Guidance screen button and the route calculates.

### Previous Destinations



Select a destination from the Previous Destination List. Up to 15 points that have been previously entered can be recalled. If the list is full, the oldest destinations are automatically deleted once the newest destinations are added.

### Address Book

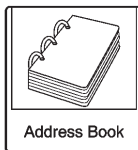

If no destination is saved to the address book, save a destination:

1. Press Destination on the Home Page.

2. Enter an address using any of the destination methods (Address Entry, POI Entry, etc.).
3. On the destination confirmation screen, select Save.
4. The system displays the options Name, Number, Icon, and Done. Press Done to save the destination.
5. To customize the address book entry, select Name, Number, or Icon.

If a destination is already saved to the address book, press Destination on the Home Page to display the Address Book screen button.

Choose a destination by selecting an address that has been stored in the address book.

1. Press the Address Book screen button. A list displays the address book entries.
2. Select the destination from the list.

3. Press the Start Guidance screen button and the route calculates.

To edit Address Book entries:

1. Select an item from the address book.
2. On the destination confirmation screen, select Edit.
3. The system displays the options Name, Number, Icon, and Delete. Press Delete to delete the destination from the address book.
4. To customize the address book entry, select Name, Number, or Icon.

### Latitude/Longitude Coordinates



Choose a destination based on latitudinal and longitudinal coordinates.

Back	Home	Fav	72°F	12:00PM
Enter Destination via Lat/Long				
Latitude:	<input type="text" value="N 42° 27' 36"/>			
Longitude:	<input type="text" value="W 82° 53' 40"/>			
<input type="button" value="Search"/>				

To enter the location as coordinates, latitude and longitude:

1. Press Destination on the Home Page. Press the Latitude and Longitude screen button to display the screen above.
2. Select Latitude or Longitude to change. Enter the coordinates in degrees, minutes, and seconds.
3. Press the Search screen button if the information is correct.
4. Press the Start Guidance screen button. The route calculates.

## Favorite Routes

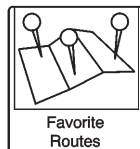

Adding a Favorite Route:

1. Press the Home Page Destination button to display the Favorite Routes screen button.
2. Press the Favorite Routes screen button to display New Favorite Route.
3. Select New Favorite Route and enter a favorite route name.
4. Press OK and the display returns to the favorite routes list.
5. Select the favorite route and add a waypoint using any of the destination methods, such as address entry, POI entry, etc.

Selecting a Favorite Route:

1. Press the Home Page Destination button to display the Favorite Routes screen button.
2. Press the Favorite Routes screen button to display a list of available favorite routes.
3. Scroll and select a favorite route.
4. Press the Start Guidance screen button. The route calculates.

Deleting a favorite route:

1. Press the Home Page Destination button to display the Favorite Routes screen button. Press this button to display the list of available favorite routes.
2. Scroll and select the route to be deleted.
3. Press Edit.
4. Press Delete Favorite Route.

## 7-54 Infotainment System

Changing the route name:

1. Press the Home Page Destination button to display the Favorite Routes screen button. Press this button to display the list of available favorite routes.
2. Press the Edit screen button.
3. Select Edit Name.
4. Using the keypad, enter the name.
5. Press the Done screen button. The new name will be in the Favorite Routes Menu.

### My Home



If no home destination is entered, save a destination by pressing the Home Page Destination button. Enter a destination using any of the destination entry methods (Address

Entry, POI Entry, etc.). Select Save as Home from the destination confirmation screen.

If a destination is already saved as home, press the Home Page Destination button to display the My Home screen button. Press this button to start route guidance.

### Select from Map

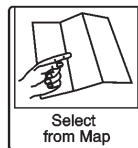

- Press the Home Page Destination button to display the Select from Map screen button. Press this button to display the map screen with a scroll symbol centered on the map.
- Press the Zoom in/out button on the screen and press the map to locate the destination to select. Press and hold a finger on the map to activate fast scrolling.

- Press the Go button on the bottom of the screen to display the destination confirmation screen.
- Press the Start Guidance screen button. The route calculates.

### Travel Guide



Press the Travel Guide screen button on the Destination Entry page. Several options can be selected to plan a route.

Back	Home	Fav	75°F	12:00PM
POI Selection				⊞ ⊞ ⊞ ⊞ ⊞
Category				⌋
Name				

The Travel Guide POI entry list allows selection of a destination search by category or name.

### Entering by POI Category

A screenshot of the 'POI List' menu. At the top, there are buttons for 'Back', 'Home', and 'Fav', and the weather '75°F' and time '12:00PM'. Below this, there are three input fields: 'Location:' with 'Nearby' entered, 'Category:' with 'All POIs' selected, and 'Sort Method:' with 'By Distance' selected. A 'Search' button is at the bottom right.

1. Select Category from the POI List menu to access the POI Selection screen display.
2. Enter the necessary information by first selecting the location line item to access the Location menu.

A screenshot of the 'Location' menu. It has the same top navigation and weather/time display. The menu lists four options: 'Nearby', 'Around Location:', 'Near Destination', and 'Along Route'. The 'Nearby' option is highlighted.

3. Select any of the line options such as Nearby.
4. Select Category from the POI Selection menu to access the POI List.

A screenshot of the 'POI List' menu. It has the same top navigation and weather/time display. A scrollable list of categories is shown: 'All POIs', 'Accommodations', 'Eat and Drink', 'Going Out', 'Place of interest', and 'Shopping'. The 'All POIs' option is selected.

5. Select any of the line options such as All POIs.

6. Select Sort Method from the POI Selection menu to access the Search Order menu. Select one of the two options available. These options are By Distance or By Name.
  7. Select Search.
  8. Select the desired POI.
- Entering by POI name:

A screenshot of the 'POI Name' search screen. It has the same top navigation and weather/time display. There are three input fields: 'Country:' with 'United States' entered, 'State:' with 'Michigan' entered, and 'City:' with 'Detroit' entered. The 'Sort Method:' is set to 'By Name'. A 'Search' button is at the bottom right.

1. Select Search by Name.
2. Make sure the correct country, state/province, and city are present, then select Search.
3. Enter the POI name.

## 7-56 Infotainment System

4. Select a few of the characters or spell the name in full, by using the alpha keyboard.
5. Select the Done screen button, or if the list has six or fewer items, a list of POIs will immediately display.
6. Press the desired POI.

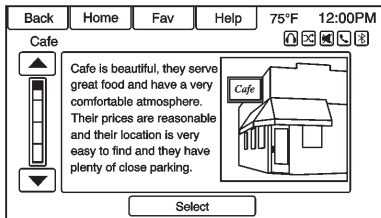

The Travel Guide POI will have some detailed information about the selection made. This information may include:

- Brief Description
- Address
- Number
- Hours of Operation

- Price
- Website

Photos may not be available for certain locations or countries.

### Destination Confirmation

Multiple options are available on the destination confirmation screen:

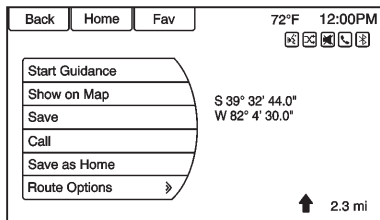

**Start Guidance:** Press to start a route calculation to the displayed destination.

**Show on Map:** Press to switch to the map view with the displayed destination centered on the map.

**Route Options:** Press to change route options. See “Route Options” following.

**Call:** Press to initiate a phone call to the displayed phone number, if phone capability is available.

**Save as Home:** Press to save the displayed destination as your home destination. The home destination will be stored at the top of the list of destinations in the address book.

**Save/Edit:** Press to save the displayed destination into the address book. If the displayed destination is already stored in the address book, Edit will show as the menu item.



## Route Options

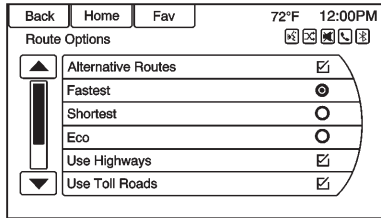

Press to display various route options.

**Alternative Routes:** If enabled, the system will provide an additional screen after Start Guidance has been selected. Select Fastest, Shortest, or Eco calculated routes before selecting GO.

**Fastest:** This calculates for the quickest route.

**Shortest:** This calculates for the shortest route.

**Eco:** This calculates for the most fuel efficient route based on speed and distance.

Under the Route Options menu, there are route preferences that by default are all enabled.

A checkmark placed next to each preference indicates this. All of these preferences are used when calculating the route. If any of these preferences are unselected, the route will be calculated without including these preferences.

**Use Highways:** Deselect to avoid major roads.

**Use Toll Road:** Deselect to avoid toll roads.

**Use Ferries:** Deselect to avoid ferries.

**Use Tunnels:** Deselect to avoid tunnels.

**Use Time Restricted:** Deselect to avoid time restricted roads.

**Use Car Train:** Deselect to avoid car trains.

## Menu with Route Guidance Active

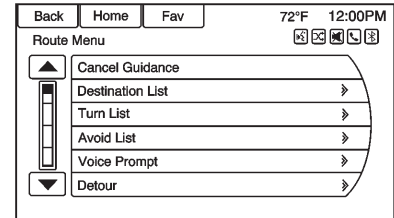

Several functions can be performed after a destination has been entered. Press the Home Page Destination screen button to access the Route Menu screen.

### Cancel Guidance

Press Cancel Guidance to cancel the current route.

## Destination List

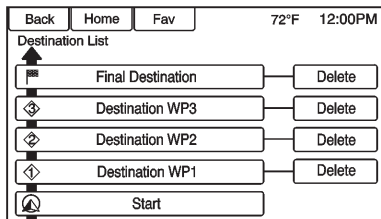

Select Destination List to view options for organizing waypoints.

## Turn List

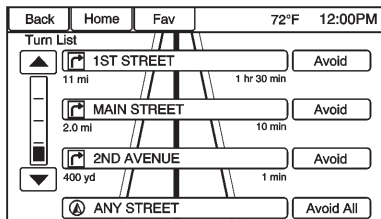

Select Turn List to view a list of maneuvers for the entire route. Press the Avoid screen button next to one of the turn maneuvers to

avoid a segment of roads. A maximum of eight avoided segments are allowed.

## Avoid List

Select Avoid List to display a list of avoided road segments with the option to remove the avoided items from the list.

## Voice Prompt

Select Voice Prompt to view options to disable or manage navigation voice prompts and traffic alert prompts.

## Detour

Press Detour to display the route detour options. Select to detour the whole route or by a specific distance.

## Route Options

This feature can be accessed from the destination confirmation menu and Destination Menu with Route Guidance Active. See "Destination Confirmation" previously in this section.

## Waypoints

Up to three waypoints can be added to the current route. The waypoints can be sorted (moved) or deleted.

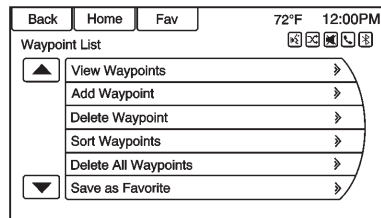

To add a waypoint:

1. From the Destination List menu, press Add Waypoint.
2. Enter the waypoint by any of the add destination methods. The system calculates and highlights the route and the route can be started.
3. To add more waypoints, press Add Waypoint to add the waypoint in the order desired on the route.

To delete a waypoint:

1. From the Route menu, press Waypoint List.
2. Press Delete Waypoints.

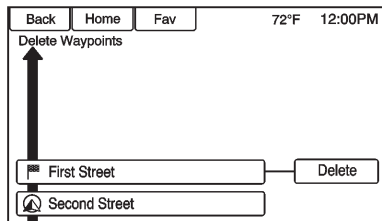

3. Select the waypoints to be deleted. Press the Delete screen button.

The Sort Waypoint feature allows reorganization of the destination list.

To sort a waypoint:

1. From the Route menu, press Waypoint List.
2. Press Sort Waypoints.
3. Select the waypoint to move.

4. Select the location to move the waypoint to.

Instead of deleting individual waypoints, select Delete All Waypoints to delete all waypoints at the same time.

To save a destination list as a favorite route, select Save as Favorite.

## OnStar® Destination Download

The destination download lets an OnStar® subscriber ask an OnStar Advisor to download a destination to the navigation system. OnStar will send address information and location coordinates of the destination into the navigation system.

## Using Destination Download

The navigation radio screen must be turned on before a download.

The navigation system displays "Please wait" as the address is searched within the map database.

If the address is not found within the map database, the system may use latitude and longitude coordinates to locate the destination.

If the system is unable to locate the address, a screen message, Sorry. There is no valid address for the given destination. Please try another one displays.

### Route Guidance Not Active

If an OnStar destination is downloaded while route guidance is not active, the navigation system displays a pop-up screen with the following screen functions:

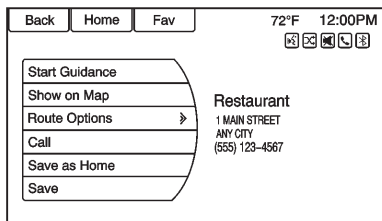

**Start Guidance:** Press to start route calculation to the destination(s) received.

**Show on Map:** Press to display the Map Screen.

**Call:** Press to initiate a call with a Bluetooth Phone or OnStar Hands-Free Calling (if available).

**Save as Home:** Press to set an address as a home destination.

**Save:** Press to save the downloaded destination to the address book.

### Route Guidance Active

If an OnStar destination is downloaded while route guidance is already active, the system displays a pop-up screen with the following screen function:

- Press Start Guidance; the navigation system adds the downloaded destination before the next waypoint of the existing route (closest to the current vehicle position).
- All other buttons on the pop-up screen operate as described under "Route Guidance Not Active."

### Previous Destinations

Previously downloaded OnStar destinations are saved under Previous Destinations in the navigation system, where they can be accessed or saved to the Address Book.

### Configure Menu

The Configuration Menu is used to adjust features and preferences, such as Sound, Radio, Nav (Navigation), Display, or Time Settings.

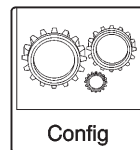

1. Press the Config screen button on the Home Page.

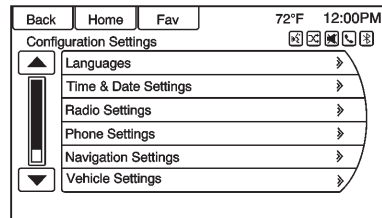

2. Touch-tap the scroll bar until the desired option displays. Select the desired settings to change. See the owner manual for information on adjusting most vehicle settings. See “Navigation Settings” and “Navigation Settings Button” in this section.

### Languages

Press the Config button on the Home Page or the CONFIG button on the faceplate to enter the menu options. Turn the TUNE/MENU knob or touch-tap the scroll bar to scroll through the available options. Press the TUNE/MENU knob or press Languages to display the languages. Select the desired language.

### Time and Date Settings

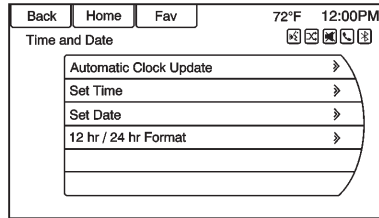

From the Time and Date screen button, press to display the Time and Date menu.

**Automatic Clock Update:** When enabled, this feature will set the clock automatically.

**Set Time:** Press the + or – to increase or decrease the Hours and Minutes displayed on the clock.

**Set Date:** Press the + and – to increase or decrease the day.

**12 hr/24 hr Format:** Press the 12 Hour screen button for standard time; press the 24 Hour screen button for military time.

Press the Back screen button to save the adjustments.

### Radio Settings

Press the Config button on the Home Page or the CONFIG button on the faceplate to enter the menu options. Turn the TUNE/MENU knob or touch-tap the scroll bar to scroll through the available options. Press the TUNE/MENU knob or press Radio Settings to display the radio settings menu. Press this feature to make changes for radio information displayed, preset pages, Auto Volume, and XM Categories Restore. See *Satellite Radio on page 7-15*, for more information about XM Categories.

The Radio Settings are:

**Auto Volume:** Select OFF, Low, Medium, or High sensitivity to automatically adjust the volume to minimize the effects of unwanted background noise that can result from changing road surfaces, driving speeds, or open windows. This feature works best at lower volume

## 7-62 Infotainment System

settings where background noise is typically louder than the sound system volume.

**Gracenote Options:** Press to enable/disable Normalization used to improve voice recognition and media groupings. See *USB on page 7-34*, *Auxiliary Devices on page 7-40*, and *Bluetooth Audio on page 7-41*.

**XM Channel Graphics:** Press to enable/disable the XM Audio page background on the XM Channel display.

**Max Startup Volume:** Press to set the maximum volume level for startup that will be used even if a higher volume had been set when the radio was turned off.

**Number of Favorite Pages:** Press to select the number of FAV pages to be displayed.

**XM Categories:** Press to customize which available XM Categories are used and displayed.

### Software Version Information:

Press to display information about the system and update software if available.

### Phone Settings

See *Bluetooth on page 7-75* in the "Phone" section for more information on phone settings.

### Navigation Settings

Press the Config button on the Home Page to enter the setup menu. Turn the TUNE/MENU knob or touch-tap the scroll bar until the Navigation Settings option displays. Select this feature to make changes to Voice Prompt, Traffic Settings, Route Options, and Home Address.

### Navigation Settings Button

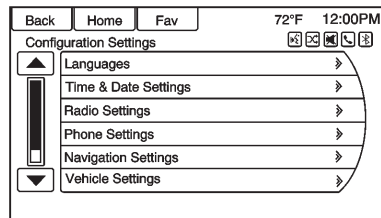

Various navigation system settings are available through the Configuration Menu. Some options are only available after a route is planned.

Press Navigation Settings to access the navigation system settings.

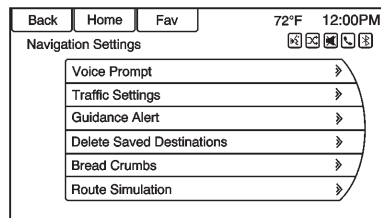

### Voice Prompt

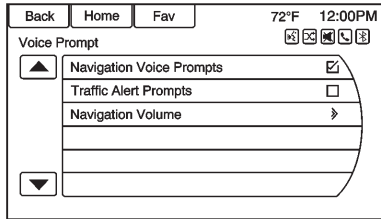

The Voice Prompt menu allows changes to the voice prompt features.

**Navigation Voice Prompts:** Select the On or Off button to turn the voice instructions on or off while traveling on a planned route.

**Traffic Alert Prompts:** Select the On or Off button to turn the traffic voice prompt on or off while traveling on a planned route.

**Navigation Volume:** Select Navigation Volume to change the volume of the navigation prompts.

### Traffic Settings

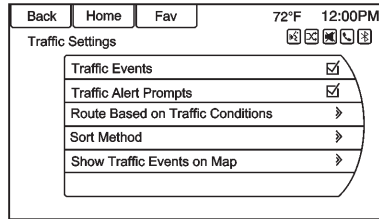

Press to display the Traffic Settings menu.

**Traffic Events (On/Off):** Press to enable or disable the traffic feature.

**Traffic Alert Prompts (On/Off):** Press to enable or disable the traffic voice prompts.

#### Route Based on Traffic

**Conditions:** Press to display a submenu of options.

- Route Based on Traffic Conditions: Press to enable or disable the route feature.
- Automatic Recalculation: Press to enable automatic route recalculation.

- Recalculation after Confirmation: Press to enable route recalculation after confirmation.

**Sort Method:** Press to display a submenu of sort options.

- Sort By Distance: Press to display traffic events in order of distance with the closest event shown first.
- Sort By Name: Press to display traffic events in alphabetical order.

**Show Traffic Events on Map:** Press to display traffic icons on the map.

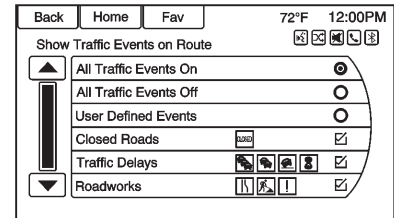

## 7-64 Infotainment System

- All Traffic Events On: Press to enable display of all traffic icons on the map.
- All Traffic Events Off: Press to disable display of all traffic icons on the map.
- User Defined: Press to define the individual types of icons that are displayed for traffic flow and traffic conditions.

### Traffic Flow Status

The traffic flow status will display in green, yellow, or red lines beside the road.

- Red indicates significantly impaired traffic flow with average speed less than 40 km/h (25 mph).
- Yellow indicates slightly impaired traffic flow with average speed between 40 and 73 km/h (25 and 45 mph).
- Green indicates normal traffic flow with average speed above 73 km/h (45 mph).

### Closed Roads, Traffic Delays, Roadworks, Incidents, and Advisories

Select the traffic event group for display on the map screen. Some events may cover more than one traffic condition. See the following traffic conditions.

### Traffic Conditions

The following traffic condition icons may display:



**Stopped Traffic**



**Traffic Jam**



**Accident**



**Road Closed**



**Lane Narrows**



**Road Work,  
Construction**



**Alert**



**Road Condition**



**Road Visibility**



**Other**



## Delete Saved Destinations

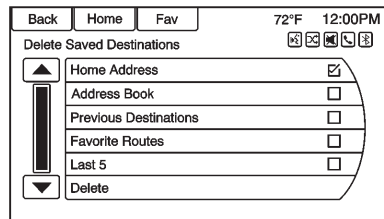

Press to delete all saved destinations. A Delete Saved Destinations submenu displays. Select the desired options for deletion and press delete at the bottom to continue. A confirmation screen displays requesting to delete or cancel.

## Guidance Alerts

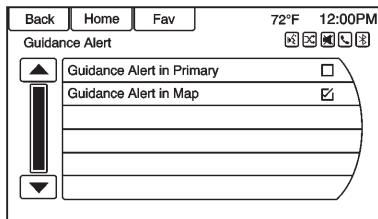

Press to enable the guidance alert pop-up to be viewed on the map or on the main screens such as audio, weather, phone, etc. A checkmark appears to indicate the guidance alert mode is on.

## Vehicle Settings

See *Vehicle Personalization on page 5-33*.

## Display Settings

Press the Config button on the Home Page or the CONFIG button on the faceplate, then select Display Settings from the list.

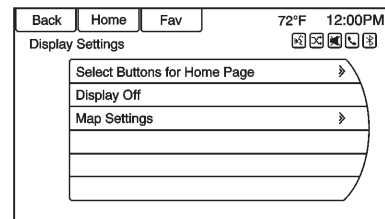

The following options may display:

### Select Buttons for Home Page:

Press to customize the first page of the Home Page.

**Display Off:** Press to turn off the display. The display will return when any radio buttons are pressed or the screen is touched (if equipped).

**Map Settings:** Press to enter the submenu to change Automatic Zoom, enable Speed Limit display on map, and change Map Display settings.

- **Map Display:** Press to change the screen background.
  - The Automatic setting adjusts the screen background automatically depending on the exterior lighting conditions.
  - The Day setting brightens the map background.
  - The Night setting darkens the map background.

To change the overall brightness setting for the display, use the vehicle interior lighting instrument panel illumination control.

### Global Positioning System (GPS)

The position of the vehicle is determined by using satellite signals, various vehicle signals, and map data.

At times, other interference such as the satellite condition, road configuration, condition of the vehicle, and/or other circumstances can affect the navigation system's ability to determine the accurate position of the vehicle.

The GPS shows the current position of the vehicle using signals sent by the GPS Satellites. When the vehicle is not receiving signals from the satellites, a symbol appears on the map screen. See *Navigation Symbols on page 7-46*.

This system might not be available or interference can occur if any of the following are true:

- Signals are obstructed by tall buildings, trees, large trucks, or a tunnel.

- Satellites are being repaired or improved.

For more information if the GPS is not functioning properly, see *Problems with Route Guidance on page 7-67* and *If the System Needs Service on page 7-68*.

### Vehicle Positioning

At times, the position of the vehicle on the map could be inaccurate due to one or more of the following reasons:

- The road system has changed.
- The vehicle is driving on slippery road surfaces such as sand, gravel, or snow.
- The vehicle is traveling on winding roads or long straight roads.
- The vehicle is approaching a tall building or a large vehicle.
- The surface streets run parallel to a freeway.

- The vehicle has been transferred by a vehicle carrier or a ferry.
- The current position calibration is set incorrectly.
- The vehicle is traveling at high speed.
- The vehicle changes directions more than once, or the vehicle is turning on a turn table in a parking lot.
- The vehicle is entering and/or exiting a parking lot, garage, or a lot with a roof.
- The GPS signal is not received.
- A roof carrier is installed on the vehicle.
- Tire chains have been installed.
- The tires are replaced or worn.
- The tire pressure for the tires is incorrect.
- This is the first navigation use after the map data is updated.
- The 12-volt battery is disconnected for several days.

- The vehicle is driving in heavy traffic where driving is at low speeds, and the vehicle is stopped and started repeatedly.

### Problems with Route Guidance

Inappropriate route guidance can occur under one or more of the following conditions:

- The turn was not made on the road indicated.
- Route guidance might not be available when using automatic rerouting for the next right or left turn.
- The route might not be changed when using automatic rerouting.
- There is no route guidance when turning at an intersection.
- Plural names of places might be announced occasionally.
- It could take a long time to operate automatic rerouting during high-speed driving.

- Automatic rerouting might display a route returning to the set waypoint if heading for a destination without passing through a set waypoint.
- The route prohibits the entry of a vehicle due to a regulation by time or season or any other regulation which may be given.
- Some routes might not be searched.
- The route to the destination might not be shown if there are new roads, if roads have recently changed, or if certain roads are not listed in the map data. See *Maps on page 7-46*.

To recalibrate the vehicle's position on the map, park with the vehicle running for two to five minutes, until the vehicle position updates. Make sure the vehicle is parked in a location that is safe and has a clear view of the sky and away from large obstruction.

### If the System Needs Service

If the navigation system needs service and the steps listed here have been followed but there are still problems, see your dealer for assistance.

### Map Data Updates

The map data provided in the vehicle is the most up-to-date information available when the vehicle was produced. The map data is updated periodically, provided that the map information has changed.

For questions about the operation of the navigation system or the update process, contact the GM Nav Disc Center toll-free phone number, 1-877-NAV-DISC (1-877-628-3472) or go to the center's website, [www.gmnavdisc.com](http://www.gmnavdisc.com). If updates are needed, call the GM Nav Disc Center or order a new Map Update online. To order map data, have the

vehicle's Vehicle Identification Number (VIN) available. See *Vehicle Identification Number (VIN) on page 12-1*.

After receiving the updated map data, see *Maps on page 7-46*.

### Database Coverage Explanations



Coverage areas vary with respect to the level of map detail available for any given area. Some areas feature greater levels of detail than others. If this happens, it does not mean there is a problem with the system. As the map data is updated, more detail can become available for areas which previously had limited detail. See *Map Data Updates on page 7-68* for more information.

### Voice Recognition

Voice recognition allows for hands-free operation of the infotainment system features.

Voice recognition can be used when the radio is on or when Retained Accessory Power (RAP) is active. See *Retained Accessory Power (RAP) on page 9-18*. The system maintains a minimum volume level.



### Using Voice Recognition

1. Press  /  on the steering wheel. The audio system mutes. A voice prompt states, "Please say a command." Wait until the tone is heard before speaking.



If there is no tone, make sure that the volume is turned up.

While voice recognition is active, the system displays a  symbol in the top right of the screen.

2. Clearly speak one of the commands listed later in this section.

Press  /  twice on the steering wheel to skip the voice prompt messages.

### Canceling Voice Recognition

1. Press and release  /  on the steering wheel control to cancel a command, if the system response does not match the voice command, or say “Goodbye” or “Cancel.”
2. The system replies, “Goodbye.”

### Helpful Hints for Speaking Commands

- When multiple commands are available, choose the command that works best for you.
- Words in parentheses are optional. For example, for the command “Tune FM (frequency),” saying “Tune FM 87.7” or “Tune FM” are both valid commands.

- When the command is recognized, the system will either perform the function or ask to confirm the choice.
- When the system does not recognize the command, the system says “pardon.”
- If experiencing difficulty with the system recognizing a command, confirm that the command is correct. Try saying the command clearly or wait for a brief moment after the tone.
- Background noise such as a climate control fan positioned on high, open windows, and very loud outside noises, even if the windows are closed, can cause voice commands to be misunderstood.
- The system is able to recognize commands in different languages, such as English, Canadian French, and Spanish. The system only recognizes commands based on the language selected.
- To increase or decrease the voice volume during a voice recognition session, turn the volume knob of the radio, or press the volume steering wheel control. If the volume is adjusted during a voice recognition session, a Volume bar appears on the screen showing the voice volume level as it is being adjusted. This also changes the volume of the guidance prompts.
- When using navigation commands, take the time to become familiar with the address. Long delays when giving the address can result in the system not recognizing the address or routing to different location than intended.
- When providing the house number portion of the address, the system recognizes both digit format and numerical text. An example would be to say, “3-0-0-0-1” or “Thirty Thousand One.”

## 7-70 Infotainment System

---

- If the system provides destination in another country on several attempts, say the “Change Country” command and say the country of interest. The country default is the United States. To enter a destination in Canada or Mexico, the country will first have to be changed in the system.

### Voice Recognition Help

To enter the help playback session, clearly speak one of the help commands.

**Help:** The system plays back more specific help commands such as Radio Settings for the user to choose from.

**Radio:** Use this command to learn about how to select a band (AM, FM, or XM), and how to change radio stations by speaking frequency numbers.

**Phone:** Use this command to learn about how to dial, pair a device, or delete a device.

**My Media:** Use this command to learn how to play specific tracks, artists, albums, devices connected to the USB port, or to change sources.

**Settings:** Use this command to learn about how to turn Verbose on or off, or set the language.

### Voice Recognition Commands

The following list shows the voice commands available for the infotainment system with a brief description of each. The commands are listed with the optional words in parentheses. To use the voice commands, see the previous instructions.

### Radio Commands

**Tune AM, Tune FM, Tune XM, Tune Pandora, Tune Stitcher:** Instructs the system to go to the specific band and the last channel.

**Tune AM (frequency), Tune FM (frequency), Tune XM (channel number), or Tune XM (channel name):** Instructs the system to go to the specific station.

**Thumbs Up:** Instructs the system to give the current song or station a thumbs up in Pandora or Stitcher.

**Thumbs Down:** Instructs the system to give the current song or station a thumbs down in Pandora or Stitcher.

### Phone Commands

**Dial or Call (phone number or contact):** Instructs the system to start a phone call. For example, say “Dial 1 248 123 4567.” To call a phone book contact, say “Dial” or “Call,” say the name and location, and then say “Dial.” For example, say “Call John at Home” or “Call John at Work.” If a number is not recognized, the first number in the list will be called.

**Pair or Connect:** Instructs the system to begin pairing a device.

**Digit Dial:** Instructs the system to dial a phone number one digit at a time. After saying the digits, say "Dial."

**Redial or Redial Last Number:** Instructs the system to dial the last phone number called.

**Select Device or Change Phone:** Instructs the system to switch to a different paired device. The device must be selected from the screen or using the TUNE/MENU knob.

**Delete Device:** Instructs the system to delete a paired device.

**Read Text Messages or Read SMS Messages:** Instructs the system to begin reading text messages from paired device.

Not all devices support text messages. Applicable where equipped.

## My Media Commands

**AUX, USB, or Bluetooth Audio:** Instructs the system to change the source.

The following commands only apply to USB, iPod, and iPhone sources. They are supported after the device has been indexed.

**Play Artist (artist name):** Instructs the system to play songs by a specific artist. For example, say "Play Artist <artist name>."

**Play Album (album title):** Instructs the system to play a specific album.

**Play Song (song title):** Instructs the system to play a specific song.

**Play Genre (genre name):** Instructs the system to play songs of a particular genre.

**Search Artist (artist name):** Instructs the system to show a list of all songs by a specific artist. For example, say "Search Artist <artist name>."

**Search Composer (composer name):** Instructs the system to show a list of all songs by a specific composer. For example, say "Search Composer <composer name>."

**Search Album (album name):** Instructs the system to show a list of all songs by a specific album. For example, say "Search Album <album name>."

**Search Genre (genre name):** Instructs the system to show a list of all songs for a specific genre. For example, say "Search Genre <genre name>."

**Search Folder (folder name):** Instructs the system to show a list of all songs in a specific folder. For example, say "Search folder <folder name>."

**Search Playlist (playlist name):** Instructs the system to show a list of all songs in a specific playlist. For example, say "Search playlist <playlist name>."

**Search Audio Book (audio book name):** Instructs the system to show a list of all tracks in a specific audio book. For example, say "Search audio book <audio book name>."

**Search Podcast (podcast name):**

Instructs the system to show a list of all tracks in a specific podcast. For example, say "Search podcast <podcast name>."

**More Like This:** Instructs the system to create a playlist of tracks similar to the current track playing.

**Settings Commands****Verbose (set) on (mode), Verbose (set) off (mode):**

Instructs the system to turn voice prompts on or off. When off, this feature turns off voice prompts.

**Language (language):** Instructs the system to set the language.

**List Devices:** Instructs the system to give a list of devices to use.

**Other Commands**

**Goodbye:** Instructs the system to end a phone call or voice recognition.

**Cancel:** Instructs the system to cancel an action.

**Go Back, Back, Previous:**

Instructs the system to go back to a prior menu.

**Main Menu:** Instructs the system to go to the main menu.

**Yes, Yep, Yup, Ya, Sure, Right, Correct, OK, Positive, You Got it, Probably, You Bet:** These can be used to say "Yes."



**No, Nope, Na, No way, Wrong, Incorrect, Negative, Not really, No I said, No I Did Not, No I Do Not:** These can be used to say "No."

**Next Page, Page Down:** Instructs the system to scroll forward one page in a list.

**Previous Page, Page Up:** Instructs the system to scroll back one page in a list.

**Navigation Commands (If Equipped)**

To activate the navigation voice recognition:

1. Press  /  on the steering wheel. The audio system mutes. A voice prompt says, "Please say a command." Wait until the tone is heard before speaking.

If there is no tone, make sure the volume is turned up.

While voice recognition is active, the system displays a symbol in the top right of the screen.

2. Clearly speak the command "Navigation."
3. Clearly speak one of the commands in this section.

The following commands only apply once the Navigation command is given.



**Change Country:** Changes the country origin to input a destination from that region. The system will accept United States, Canada, or Mexico.

**Address or Destination:** Allows an address to be stated as a one-shot method. The system will recognize the address if stated all at once or say a city center. An example is to say, “200 Renaissance Street, Detroit, Michigan” or “Detroit, Michigan.”

**Directed Address:** Allows an address to be stated one step at a time. The format will be State, City, Street, then House Number.

**Intersection:** Allows an Intersection to be stated as the destination. The format will be State, City, Street, then Intersection.

**Home:** Instructs the system to start guidance to address saved as My Home.

**Contact:** When a phone is paired to the system, which contains Address Information stored for contacts, the address associated with that contact can become a route. If the system cannot resolve the address, an error displays.

**Points of Interest or POI:** Allows a Point of Interest to be stated as a destination. Become familiar with the POI categories and sub-categories in the system by pressing Destination from the Home Page or DEST on the faceplate, then selecting Point of Interest. POI commands for Along Route and Around Destination will be available if route guidance is active.

**Add Waypoint:** Allows addition of individual waypoints or the destination. The system will ask for the choice of entry method to continue. An example is to say, “POI Along Route” or “Intersection.”

**Delete Waypoint:** When guidance is active, this command allows the deletion of individual waypoints or

the destination. If guidance is not active, the system will indicate the destination list is empty.

**Where Am I?, My Location, or Current Position:** Instructs the system to give the current position of the vehicle.

**Help:** The system plays back more specific help commands associated with Navigation or a Navigation sub-feature.

**Cancel Guidance or Cancel Route:** Instructs the system to cancel guidance.



### Entering a Destination in Other Countries

For the voice recognition to respond to a local address, the corresponding country needs to be set in the navigation system.



The country can also be set using voice commands. However, the country will change back to the default country when the vehicle is keyed off.

## 7-74 Infotainment System

---

1. Press  /  on the steering wheel.
2. Say "Navigation."
3. Say "Change Country."
4. Say the country name. For example, say "Canada."

### OnStar Command (If Equipped)

To activate OnStar voice recognition, press  on the mirror or press  /  on the steering wheel and say "OnStar" after the beep. This will activate the OnStar voice control. See *OnStar Overview on page 14-1*.

### Help Commands

- Help
- Hands-Free Calling (If Equipped)
- Turn-by-Turn Directions
- OnStar Info

After each list of help commands, the following are available:

- Go Back

- Repeat
- Cancel
- Help
- Goodbye

### Hands-Free Calling

- Call
- Store
- Commands
  - Call
  - Store
  - My Number
  - Minutes
  - Store Last Number
  - Digit Dial
  - Redial
  - Dial
  - Number Recall
  - Directory
  - Digit Store

### Turn-by-Turn Directions

- Directory
- Plan Route
- Commands
  - Directory
  - Store Destination
  - Plan Route
  - Delete Destination
  - Mute Directions

### OnStar Info

- Messages
- Minutes
- My Number
- Commands
  - Messages
  - Virtual Advisor
  - My Number
  - Minutes
  - Number Recall
  - Advisor Playback



- Virtual Advisor

**Virtual Advisor**

Choose this option to connect to a live Advisor.

**Voice Pass-Thru**

Voice pass-thru allows access to the voice recognition commands on the cell phone, i.e. Siri or Voice Command. See the cell phone manufacturer's user guide to see if the cell phone supports this feature.

To activate phone voice recognition system, press and hold  /  on the steering wheel for approximately two seconds.

**Bluetooth Phone/ Devices**

**Bluetooth**

**Overview**

For vehicles equipped with Bluetooth capability, the system can interact with many cell phones and devices, allowing:

- Placing and receiving hands-free calls.
- Sharing of the cell phone's address book or contact list with the vehicle. The phone book will only display when that phone is connected.
- Placing outgoing calls by voice recognition.

The system can be used while in ON/RUN, ACC/ACCESSORY, or Retained Accessory Power (RAP). The range of the Bluetooth system can be up to 9.1 m (30 ft). The radio can connect to most

Bluetooth-enabled phones. Available features and functions may be dependent on the device.



On a current phone call screen, an image of the contact from your phone's contact list can be displayed. Not all phones are compatible with this feature.

**Bluetooth Controls**

Use the buttons on the infotainment system and the steering wheel to operate the Bluetooth system.

**Steering Wheel Controls**



 /  (**Push to Talk**): Press to answer incoming calls and start voice recognition.

 /  (**Mute/End Call**): Press to end a call, decline an incoming call, or cancel voice recognition.

+  - (**Volume**): Press + or - to increase or decrease the volume.

### Infotainment System Controls

For information about how to navigate the menu system using the infotainment controls, see *Overview on page 7-2*.

  **(Phone/Mute):** Press to enter the Phone main menu. Press and hold to mute or unmute.

### Voice Recognition

The voice recognition system uses commands to control the system and dial phone numbers.

When using voice recognition:

- The system may not recognize voice commands if there is too much background noise.
- A tone sounds to indicate that the system is ready for a voice command. Wait for the tone and then speak.
- Speak clearly in a calm and natural voice.

See *Voice Recognition on page 7-68*.

### Audio System

Sound comes through the vehicle's front audio system speakers and overrides the audio system. Use the VOL/🔊 knob during a call to change the volume level. The adjusted volume level remains in memory for later calls. The system maintains a minimum volume level.

See *Voice Recognition on page 7-68*.

### Bluetooth Audio

See *Bluetooth Audio on page 7-41*.



### Pairing with Infotainment Controls

A Bluetooth-enabled cell phone must be paired and then connected to the vehicle before it can be used. See your cell phone manufacturer's user guide for Bluetooth functions before pairing the cell phone. If a Bluetooth phone is not connected, calls will be made using OnStar Hands-Free Calling, if available. See *OnStar Overview on page 14-1*.

### Pairing Information

- A Bluetooth-enabled phone and an audio playback device can be paired to the system at the same time.
- Up to five devices can be paired to the Bluetooth system.
- The pairing process is disabled when the vehicle is moving.
- Pairing only needs to be completed once, unless the pairing information on the cell phone changes or the cell phone is deleted from the system.
- Only one paired cell phone can be connected to the Bluetooth system at a time.
- If multiple paired cell phones are within range of the system, the radio will connect to the first phone in the list or to the phone that was previously connected.

### Pairing a Phone/Device

1. Press the CONFIG button or  / .
2. Select Phone Settings.
3. Select Pair Device (Phone). The radio displays "Please start Bluetooth search on your phone. Confirm or enter number:." If the device supports a four-digit Personal Identification Number (PIN), it will display. The PIN is used in Step 5.
4. Start the pairing process on the cell phone to be paired to the vehicle. See the cell phone manufacturer's user guide.
5. Locate and select the device named after the vehicle make and model in the list on the cell phone. Follow the instructions on the cell phone to enter the PIN provided in Step 3, or to confirm the six-digit code matches. The system recognizes the new connected phone after the pairing process is complete.

6. If the phone prompts to accept connection or allow phone book download, select always accept and allow. The phone book may not be available if not accepted. Some phones will put connection request or phonebook request in a pull down task bar at the top of the screen. Drag down the task bar and look for connection/phonebook request and accept.
7. Repeat to pair additional phones.

### Listing All Paired and Connected Phones/Devices

1. Press the CONFIG button.
2. Select Phone Settings.
3. Select Device List.

### Deleting a Paired Phone/Device

1. Press the CONFIG button.
2. Select Phone Settings.
3. Select Device List.

4. Select the phone to delete and follow the screen prompts.

### Connecting to a Different Phone



To connect to a different phone, the new phone must be in the vehicle and available to be connected to the Bluetooth system before the process is started.

1. Press the CONFIG button.
2. Select Phone Settings.
3. Select Device List.
4. Select the new phone to connect to and follow the screen prompts.

### Pairing with Voice Recognition

A Bluetooth-enabled cell phone must be paired and then connected to the vehicle before it can be used. See the cell phone manufacturer's user guide for Bluetooth functions before pairing the cell phone. If a Bluetooth phone is not connected, calls will be made using OnStar Hands-Free Calling, if available. See *OnStar Overview on page 14-1*.



### Pairing a Phone

1. Press  / . The system responds "Please say a command," followed by a tone.
2. Say "Pair." The system responds with "Please search for Bluetooth devices on your phone, select your vehicle, confirm and enter the PIN provided on the screen."
3. Start the search for Bluetooth devices on the phone. Then select the device and follow the instructions on the phone by either entering the four-digit PIN or confirming the six-digit passcode. The PIN is used in Step 4.
4. Locate and select the device named after the vehicle make and model in the list on the cell phone. Follow the instructions on the cell phone to enter the PIN provided in Step 3 or to confirm the six-digit code matches. The system responds "successfully paired."

5. Repeat Steps 1–4 to pair additional phones.



### Listing All Paired and Connected Phones

The system can list all cell phones paired to it. If a paired cell phone is also connected to the vehicle, the system responds with "is connected" after that phone name.



1. Press  / . The system responds "Please say a command," followed by a tone.
2. Say "Device List."

### Deleting a Paired Phone

If the phone name to delete is unknown, see "Listing All Paired and Connected Phones."



1. Press  / . The system responds "Please say a command," followed by a tone.
2. Say "Delete Device."

3. The system responds with: "To delete a device, please touch its name on the screen." Select the device to delete on the display and it will be removed.

To cancel this command, press  /  on the steering wheel control or press the  BACK button on the radio faceplate.

### Connecting to a Different Phone or Device

To connect to a different cell phone, the system looks for the next available cell phone. Depending on the cell phone to be connected, this command may need to be repeated.

1. Press  / . The system responds "Please say a command," followed by a tone.
2. Say "Change Phone."
  - To select a device, press the name on the display.
  - If another cell phone is not found, the original phone remains connected.

## Making a Call Using Phone Book and Infotainment Controls

For cell phones that support the phone book feature, the Bluetooth system can use the contacts stored on the cell phone to make calls. See the cell phone manufacturer's user guide or contact the wireless provider to find out if this feature is supported.



When a cell phone supports the phone book feature, the Phone Book and Call Lists menus are automatically available.

The Phone Book menu allows access to the phone book stored in the cell phone to make a call.



The Call Lists menu allows access to the phone numbers from the Incoming Calls, Outgoing Calls, and Missed Calls menus on the cell phone to make a call.

The radio will display the first 1,000 contacts and the phone numbers for each contact including Home, Work, Mobile, and Other.

To make a call using the Phone Book menu:

1. Press  /  once on the radio or the Phone screen button.
2. Select Phone Book.
3. Select the letter group of the phone book entry to scroll through the list of names/numbers.
4. Select the name.
5. Select the number to call.



To make a call using the Call Lists menu:

1. Press  /  once on the radio or the Phone screen button.
2. Select Call Lists.
3. Select the Incoming Calls, Outgoing Calls, or Missed Calls list.

4. Select the name or number to call.

## Making a Call Using the Infotainment Controls

To make a call:

1. Press  /  once on the radio or the Phone screen button.
2. Press Enter Number.
3. Enter the phone number.
4. Select OK to start dialing the number.
5. Select Call to place the call.

To make a call using voice recognition, see "Making a Call" under *Bluetooth on page 7-75*.





## Accepting or Declining a Call

When an incoming call is received, the infotainment system mutes and a ring tone is heard in the vehicle.

### Using the Infotainment Controls

Turn the TUNE/MENU knob to “Answer” or “Decline” and press the TUNE/MENU knob or press Accept or Decline on the screen.

### Using Steering Wheel Controls

Press  /  to answer or  /  to decline the call.

### Call Waiting Using the Infotainment Controls







Call waiting must be supported on the Bluetooth phone and enabled by the wireless service carrier to work.

### Switching Between Calls (Call Waiting Calls Only)

To switch between calls turn and press the TUNE/MENU knob and select Switch Call or select Switch Call on the screen.

### Call Waiting Using Steering Wheel Controls

Call waiting must be supported on the cell phone and enabled by the wireless service carrier.

- Press  /  to answer an incoming call when another call is active. The original call is placed on hold.
- Press  /  again to return to the original call.
- To decline answering the incoming call, press Decline on the screen or take no action.
- Press  /  to disconnect the current call and switch to the call on hold.

### Conference Calling Using the Infotainment Controls

Conference calling and three-way calling must be supported on the Bluetooth phone and enabled by the

wireless service carrier to work. This feature is only supported when the vehicle is not moving.

To start a conference while in a current call:

1. Turn and press the TUNE/MENU knob and select Enter Number.
2. Enter the phone number and select OK.
3. After the call has been placed, turn the TUNE/MENU knob and choose Merge Calls.
4. To add more callers to the conference call, repeat Steps 1–3. The number of callers that can be added is limited by your wireless service carrier.

### Ending a Call

#### Using the Infotainment Controls

Turn and press the TUNE/MENU knob and select Hang Up or press Hang Up on the screen.

#### Using Steering Wheel Controls

Press  / .



## Muting a Call

During a call, all sounds from inside the vehicle can be muted so that the person on the other end of the call cannot hear them.

## Using the Infotainment Controls



Turn and press the TUNE/MENU knob and select Mute Call. Press again to cancel mute.

## Transferring a Call



Audio can be transferred between the Bluetooth system and the cell phone.

The cell phone must be paired and connected with the Bluetooth system before a call can be transferred.

## To Transfer Audio from the Bluetooth System to a Cell Phone

During a call with the audio in the vehicle, press the Transfer Call button on the screen or press and hold the  /  button on the steering wheel.

## To Transfer Audio to the Bluetooth System from a Cell Phone

Use the audio transfer feature on the cell phone. See your cell phone manufacturer's user guide for more information. Press the Transfer call button on the screen or press and hold the  /  button on the steering wheel.

## Dual Tone Multi-Frequency (DTMF) Tones



The in-vehicle Bluetooth system can send numbers during a call. This is used when calling a menu-driven phone system.

## Using the Infotainment Controls

1. Turn and press the TUNE/MENU knob and select Enter Number.
2. Enter the phone number, or select Enter Number on the screen and select digits, then press OK.

## Hands-Free Phone

### Using Bluetooth Voice Recognition

To use voice recognition, press the  /  button on the steering wheel. Use the commands below for the various voice features. For additional information, say "Help" while in a voice recognition menu.

### Making a Call

Calls can be made using the following commands.

**Dial or Call:** These commands can be used interchangeably to dial a phone number.

**Digit Dial:** This command allows a phone number to be dialed by entering the digits one at a time.

**Re-dial:** This command dials the last number used on the cell phone.

### Using the “Dial” or “Call” Command

To call a number:

1. Press  $\mathcal{C}$  /  $\mathbb{L}$ . The system responds “Please say a command,” followed by a tone.
2. Say “Dial” or “Call.”
3. Say the entire number without pausing, followed by “Dial.”

Once connected, the person called will be heard through the audio speakers.

To call using a name tag:

1. Press  $\mathcal{C}$  /  $\mathbb{L}$ . The system responds “Please say a command,” followed by a tone.
2. Say “Dial” or “Call” and then say the name tag. For example “Call John at Work.”

Once connected, the person called will be heard through the audio speakers.

### Using the “Digit Dial” Command

This allows a phone number to be dialed by entering the digits one at a time.

1. Press  $\mathcal{C}$  /  $\mathbb{L}$ . The system responds “Please say a command,” followed by a tone.
2. Say “Digit Dial.”
3. Say each digit, one at a time, to dial. After each digit is entered, the system repeats back the digit it heard followed by a tone. After the last digit has been entered, say “Dial.”

If an unwanted number is repeated back, say “Clear” to clear the last number.

Once connected, the person called will be heard through the audio speakers.

### Using the “Redial” Command

1. Press  $\mathcal{C}$  /  $\mathbb{L}$ . The system responds “Please say a command,” followed by a tone.

2. After the tone, say “Redial.” The system dials the last number called from the connected cell phone.

Once connected, the person called will be heard through the audio speakers.

### Clearing the System

Unless information is deleted out of the vehicle Bluetooth system, it will be retained. This includes phone pairing information. For directions on how to delete this information, see “Deleting a Paired Phone/ Device.”

### Text Messaging

For vehicles equipped with Bluetooth capability, the system, if equipped with text messaging, can display text messages, play back a message over the audio system, and send a predefined message. Not all phones support all functions and work with Bluetooth. The radio only supports the receipt of SMS

text messages. A request may need to be accepted on the phone or some phone settings may need to be changed to allow text messaging to function. See the cell phone manufacturer's user guide.

### Using Text Messaging

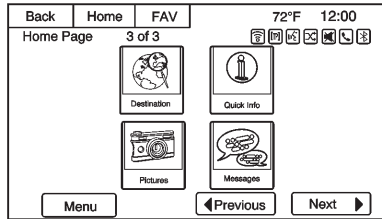

1. Press the Messages button on the Home Page or select Text Messages from the Phone main screen. Until all text messages are retrieved, the Home Page icon will remain gray and the Phone main screen option will be removed.

This feature will be disabled if the paired Bluetooth device does not support SMS Text Messaging.

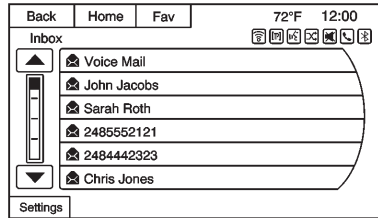

2. Once all messages are retrieved, the Text Message Inbox displays. Select a message for viewing. Viewing messages is only available while the vehicle is not in motion.

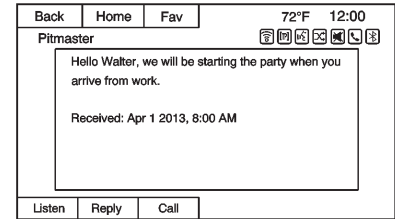

3. View the message or select Listen to hear the message through voice recognition. The message view screen is locked out while the vehicle is in motion.
  - Select Call to dial the contact or number associated with the text. Not all phones allow calling the sender of the message and will result in not being able to select Call.
  - Select Reply to reply to a text message that was received as an incoming message. Not all phones allow message sending.

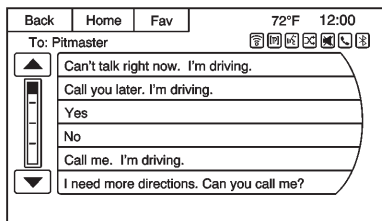

- Select the desired message from the display of predefined messages to send as the reply message.

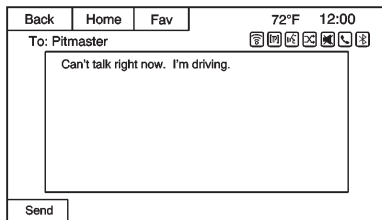

- Select Send to send that message.
- Select Back to cancel and return to the previous screen.

## Incoming Text Messages

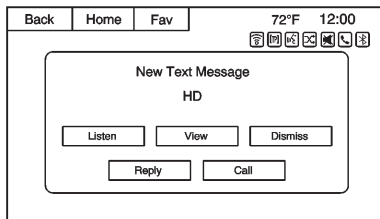

A pop-up screen is displayed when there is an incoming text. The pop-up will remain on the screen until Dismiss is selected.

- Select Listen to hear the message through voice recognition.
- Select View to view the message. Viewing is not available while the vehicle is in motion.

- Select Reply to reply to the message using a predefined message.
- Select Call to dial the contact or number associated with the text.
- Select Dismiss to close out the incoming pop-up message screen.

## Text Messaging Settings

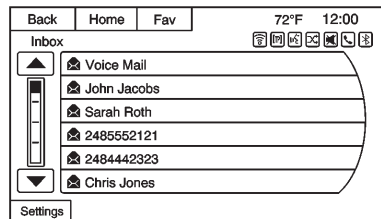

Text Message Settings are available from the Text Message Inbox.

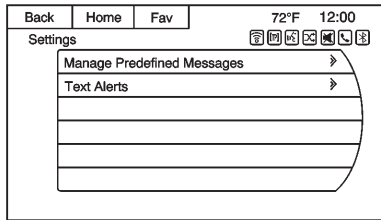

- Select Manage Predefined Messages to create a user defined message that can be used later to reply to a text message.
- Select Text Alerts to choose the alert behavior for incoming text messages:
  - Text alert with tone
  - Tone only
  - Off

## Trademarks and License Agreements

### FCC Information

See *Radio Frequency Statement* on page 13-15.



“Made for iPod” and “Made for iPhone” mean that an electronic accessory has been designed to connect specifically to iPod or iPhone and has been certified by the developer to meet Apple performance standards.

iPod and iPhone are trademarks of Apple Computer, Inc., registered in the U.S. and other countries.



Fees and Taxes: Subscription fee, taxes, one time activation fee, and other fees may apply. Subscription fee is consumer only. All fees and programming subject to change. Subscriptions subject to Customer Agreement available at [www.siriusxm.com](http://www.siriusxm.com). SiriusXM® service only available in the 48 contiguous United States and Canada.

Explicit Language Notice: Channels with frequent explicit language are indicated with an “XL” preceding the channel name. Channel blocking is available for SiriusXM Satellite Radio receivers by notifying SiriusXM:

- USA Customers — See [www.siriusxm.com](http://www.siriusxm.com) or call 1-866-635-2349.

It is prohibited to copy, decompile, disassemble, reverse engineer, hack, manipulate, or otherwise make available any technology or software incorporated in receivers compatible with the SiriusXM® Satellite Radio System or that support the SiriusXM website, the Online Service or any of its content. Furthermore, the AMBER voice compression software included in this product is protected by intellectual property rights including patent rights, copyrights, and trade secrets of Digital Voice Systems, Inc.

### General Requirements:

- A License Agreement from SiriusXM® is required for any product that incorporates SiriusXM Technology and/or for use of any of the SiriusXM marks to be manufactured, distributed, or marketed in the SiriusXM Service Area.

### Gracenote

Gracenote®, Gracenote logo and logotype, and the "Powered by Gracenote" logo are either a registered trademark or a trademark of Gracenote, Inc. in the United States and/or other countries.

### Bluetooth

The Bluetooth® word mark and logos are owned by the Bluetooth® SIG, Inc. and any use of such marks by General Motors is under license. Other trademarks and trade names are those of their respective owners.

### Pandora (If Equipped)

Pandora is a registered trademark of Pandora Media, Inc., used under license.



Manufactured under license from Dolby Laboratories. Dolby and the double-D symbol are trademarks of Dolby Laboratories.

### Map End User License Agreement (Optional Equipment Applies Where Equipped)

#### END USER TERMS

The data ("Data") is provided for your personal, internal use only and not for resale. It is protected by copyright, and is subject to the following terms and conditions which are agreed to by you, on the one hand, and Panasonic Automotive Systems Company of America ("PANASONIC") and its licensors (including their licensors and suppliers) on the other hand.

© 2013 NAVTEQ. All rights reserved.

The Data includes certain information and related content provided under license to NT from third parties and is subject to the

applicable supplier terms and copyright notices set forth at the following URL:  
[http://corporate.navteq.com/supplier\\_terms.html](http://corporate.navteq.com/supplier_terms.html).

In addition, the Lonely Planet Travel Guide content is subject to the following supplier notices (if equipped):

© 2013 Lonely Planet Publications Pty Ltd. All rights reserved.

PANASONIC and its content providers have tried to make this information as accurate as possible, but it is provided “as is” and PANASONIC and its content providers accept no responsibility for any loss, injury or inconvenience resulting from this information. You should verify critical information (like visas, health and safety) before you travel.

## **TERMS AND CONDITIONS**

**Personal Use Only.** You agree to use this Data together with the General Motors MyLink or IntelliLink

Connected Navigation Radio Platform for the solely personal, non-commercial purposes for which you were licensed, and not for service bureau, time-sharing or other similar purposes. Accordingly, but subject to the restrictions set forth in the following paragraphs, you agree not to otherwise reproduce, copy, modify, decompile, disassemble, create any derivative works of, or reverse engineer any portion of this Data, and may not transfer or distribute it in any form, for any purpose, except to the extent permitted by mandatory laws.

### **Restrictions**

Except where you have been specifically licensed to do so by PANASONIC, and without limiting the preceding paragraph, you may not (a) use this Data with any products, systems, or applications installed or otherwise connected to or in communication with vehicles, capable of vehicle navigation, positioning, dispatch, real time route guidance, fleet management or

similar applications; or (b) with or in communication with any positioning devices or any mobile or wireless-connected electronic or computer devices, including without limitation cellular phones, palmtop and handheld computers, pagers, and personal digital assistants or PDAs

### **Warning**

The Data may contain inaccurate or incomplete information due to the passage of time, changing circumstances, sources used and the nature of collecting comprehensive geographic data, any of which may lead to incorrect results.

### **No Warranty**

This Data is provided to you “as is,” and you agree to use it at your own risk. PANASONIC and its licensors (and their licensors and suppliers) make no guarantees, representations or warranties of any kind, express or implied, arising by law or otherwise, including but not

limited to, content, quality, accuracy, completeness, effectiveness, reliability, fitness for a particular purpose, usefulness, use or results to be obtained from this Data, or that the Data or server will be uninterrupted or error-free.

### **Disclaimer of Warranty**

PANASONIC AND ITS LICENSORS (INCLUDING THEIR LICENSORS AND SUPPLIERS) DISCLAIM ANY WARRANTIES, EXPRESS OR IMPLIED, OF QUALITY, PERFORMANCE, MERCHANTABILITY, FITNESS FOR A PARTICULAR PURPOSE OR NON-INFRINGEMENT. Some States, Territories and Countries do not allow certain warranty exclusions, so to that extent the above exclusion may not apply to you.

### **Disclaimer of Liability**

PANASONIC AND ITS LICENSORS (INCLUDING THEIR LICENSORS AND SUPPLIERS) SHALL NOT BE LIABLE TO YOU: IN RESPECT OF

ANY CLAIM, DEMAND OR ACTION, IRRESPECTIVE OF THE NATURE OF THE CAUSE OF THE CLAIM, DEMAND OR ACTION ALLEGING ANY LOSS, INJURY OR DAMAGES, DIRECT OR INDIRECT, WHICH MAY RESULT FROM THE USE OR POSSESSION OF THE INFORMATION; OR FOR ANY LOSS OF PROFIT, REVENUE, CONTRACTS OR SAVINGS, OR ANY OTHER DIRECT, INDIRECT, INCIDENTAL, SPECIAL OR CONSEQUENTIAL DAMAGES ARISING OUT OF YOUR USE OF OR INABILITY TO USE THIS INFORMATION, ANY DEFECT IN THE INFORMATION, OR THE BREACH OF THESE TERMS OR CONDITIONS, WHETHER IN AN ACTION IN CONTRACT OR TORT OR BASED ON A WARRANTY, EVEN IF PANASONIC OR ITS LICENSORS HAVE BEEN ADVISED OF THE POSSIBILITY OF SUCH DAMAGES. Some States, Territories and Countries do not allow certain liability exclusions

or damages limitations, so to that extent the above may not apply to you.

### **Export Control**

PANASONIC shall not export from anywhere any part of the Data or any direct product thereof except in compliance with, and with all licenses and approvals required under, applicable export laws, rules and regulations, including but not limited to the laws, rules and regulations administered by the Office of Foreign Assets Control of the U.S. Department of Commerce and the Bureau of Industry and Security of the U.S. Department of Commerce. To the extent that any such export laws, rules or regulations prohibit NT from complying with any of its obligations hereunder to deliver or distribute Data, such failure shall be excused and shall not constitute a breach of this Agreement.



**Entire Agreement**

These terms and conditions constitute the entire agreement between PANASONIC (and its licensors, including their licensors and suppliers) and you pertaining to the subject matter hereof, and supersedes in their entirety any and all written or oral agreements previously existing between us with respect to such subject matter.

**Governing Law**

The above terms and conditions shall be governed by the laws of the State of Illinois (with respect to use of Data for the Americas and/or the Asia Pacific territories), and the laws of The Netherlands (with respect to Data for the Middle East, Africa, Russia and Europe territories), without giving effect to (i) its conflict of laws provisions, or (ii) the United Nations Convention for Contracts for the International Sale of Goods, which is explicitly excluded. You agree to submit to the jurisdiction of the State of Illinois for any and all

disputes, claims and actions arising from or in connection with the Data provided to you hereunder.

**Government End Users**

If the Data is being acquired by or on behalf of the United States government or any other entity seeking or applying rights similar to those customarily claimed by the United States government, this Data is a "commercial item" as that term is defined at 48 C.F.R. ("FAR") 2.101, is licensed in accordance with these End-User Terms, and each copy of Data delivered or otherwise furnished shall be marked and embedded as appropriate with the following "Notice of Use," and shall be treated in accordance with such Notice:



**NOTICE OF USE**

CONTRACTOR (MANUFACTURER/SUPPLIER)

NAME:

**NAVTEQ North America, LLC, c/o Nokia**

CONTRACTOR (MANUFACTURER/SUPPLIER)

ADDRESS:

**425 West Randolph Street,  
Chicago, IL 60606.**

This Data is a commercial item as defined in FAR 2.101 and is subject to these End-User Terms under which this Data was provided.

© 2013 NAVTEQ. All rights reserved.

If the Contracting Officer, federal government agency, or any federal official refuses to use the legend provided herein, the Contracting Officer, federal government agency, or any federal official must notify NAVTEQ prior to seeking additional or alternative rights in the Data.



# Climate Controls

## Climate Control Systems

Dual Automatic Climate Control System ..... 8-1

## Air Vents

Air Vents ..... 8-6

## Maintenance

Passenger Compartment Air Filter ..... 8-6

# Climate Control Systems

## Dual Automatic Climate Control System

The heating, cooling, and ventilation for the vehicle can be controlled with this system.

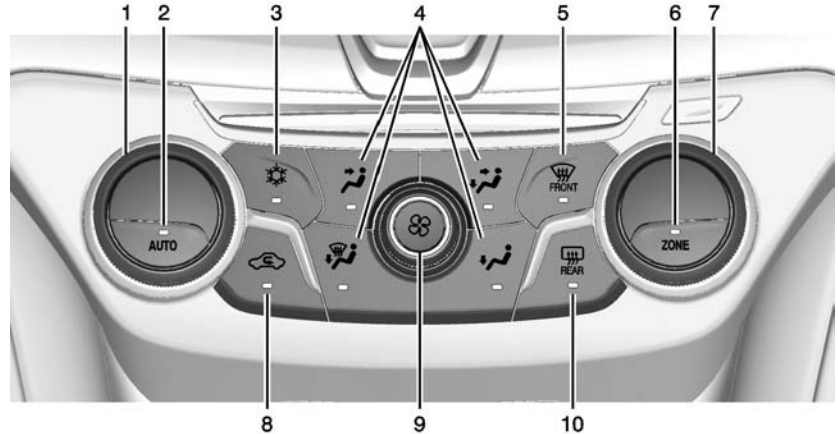

- 1. Driver Temperature Control
- 2. AUTO (Automatic Operation)

- 3. Air Conditioning
- 4. Air Delivery Mode Controls

## 8-2 Climate Controls

---

5. Front Defrost
6. ZONE
7. Passenger Temperature Control
8. Recirculation
9. Fan Control
10. Rear Window Defogger

### Automatic Operation

**AUTO (Automatic):** When this button is pressed, the system automatically controls the inside temperature, the air delivery mode, the air conditioning compressor, and the fan speed. When AUTO appears in the display, the system is in full automatic operation. If any of the controls are manually adjusted, the AUTO indicator turns off in the display.

1. Press the AUTO button, if the AUTO indicator does not appear on the display.
2. Adjust the temperature to a comfortable setting.
3. Adjust the air outlets as desired.

4. Let the system stabilize for a few minutes.

In cold weather, the system starts in the recirculation mode with the fan off. As the engine warms up, warm air is directed to the floor outlets, before automatically changing to bi-level mode with a reduced fan speed.

Do not cover the solar sensor in the center of the instrument panel, near the windshield. See “Sensors” later in this section.

The automatic climate control system may not work as desired if one or more of the instrument panel outlets are closed.

### Manual Operation

**On/Off:** Press  to turn the system on or off.

 **(Fan Control):** Turn clockwise or counterclockwise to increase or decrease the fan speed. The fan speed appears on the infotainment display.

Press the AUTO button to return to automatic operation.

### Driver and Passenger

**Temperature Controls:** The temperature can be adjusted separately for the driver and the passenger. Turn the temperature controls clockwise or counterclockwise to increase or decrease the temperature.

The temperature setting between 21°C (70°F) and 23°C (74°F) is recommended.

The temperature settings for each side are shown in the temperature control knob displays and the infotainment display. If the temperature control is past 30°C (86°F), the display shows HI (hottest). Turning it past 16°C (61°F), shows LO (coolest).

**ZONE:** Press to synchronize the driver and passenger temperatures.





**Single-Zone Mode:** All zones are set to the same temperature. “Driver has control” will be displayed on the

infotainment display. Turn the driver temperature control to adjust the system temperature.

**Dual-Zone Mode:** Allows different temperatures to be set for the driver and passenger sides.

Enter Dual-Zone mode by adjusting the passenger side temperature when in Single-Zone mode.

#### Air Delivery Mode Controls:

Press , , , or  to change the current airflow mode. The current mode selection appears in the display screen. Changing the mode cancels the automatic operation and the system goes into semi-automatic operation. Press AUTO to return to automatic operation.

Select from the following:



 **(Vent):** Air is directed to the instrument panel outlets and console outlet.

 **(Bi-Level):** Air is divided between the instrument panel outlets, console outlet and the floor

outlets. Cooler air is directed to the upper outlets and warmer air to the floor outlets.



 **(Floor):** Air is directed to the floor outlets with some air directed to the outer instrument panel, windshield, and side window outlets.

 **(Defog):** Air is directed to the windshield, floor and side window outlets. Use this mode to clear the windows of fog or moisture and warm the passengers.

 **FRONT (Defrost):** Press to turn the defrost on or off. The  FRONT indicator appears in the display. A portion of the air is directed to the windshield and side window outlets, with some air directed to the outer instrument panel outlets.

For best results, clear all snow and ice from the windshield before defrosting.



## Air Conditioning

 **(Air Conditioning):** Press to turn the air conditioning system on or off. The  appears on the infotainment display when the air conditioning is on. When the air conditioning is turned off,  OFF appears on the infotainment display.

The air conditioning system removes moisture and heat from the air.

The air conditioning might automatically turn off during heavy acceleration, abnormal system pressure or very cold outside temperatures.

## Recirculation

 **(Recirculation):** Press to change the air intake between recirculated air and outside air.  appears on the infotainment display when recirculation is activated.

The recirculation mode recycles interior air and is not recommended for extended use. If it is used for a

## 8-4 Climate Controls

long period of time, the system automatically lets some outside air into the vehicle for ventilation.

Do not use the recirculation mode if occupants are smoking.

The recirculation mode cannot be turned on in defrost mode.

AUTO  is displayed when the system is automatically controlling the combination of outside and recirculated air for best performance.

**Pollution Mode:** This mode selects recirculation when the vehicle speed is less than 15 km/h (9 mph) to prevent exhaust fumes from entering the vehicle in slow moving traffic.

To select, see “Pollution Mode” in the Climate and Air Quality menu under *Vehicle Personalization* on page 5-33.

### Rear Window Defogger

The rear window defogger uses a warming grid to remove fog or frost from the rear window. It only works when the ignition is in ON/RUN.

 **REAR (Rear Window Defogger):** Press to turn the rear window defogger on or off. The indicator on the button turns on. The rear window defogger turns off automatically if it is left on.

#### Caution

Using a razor blade or sharp object on the inside rear window can damage the antenna or defogger. Repairs would not be covered by the vehicle warranty. Do not stick anything to the rear window.

**Heated Mirrors:** If equipped with heated outside rearview mirrors, the mirrors heat to help clear fog or frost from the surface of the mirror when

the rear window defog button is pressed. See *Heated Mirrors* on page 2-17.

### Sensors

The automatic climate control system uses sensors to maintain temperatures. The solar sensor is on the instrument panel near the windshield, and the outside temperature sensor is in front of the radiator.

The solar sensor monitors the solar radiation when operating in AUTO mode, adjusting the temperature, fan speed and air delivery.

The system may also supply cooler air to the side of the vehicle facing the sun. The recirculation mode will also be activated, as necessary.

The outside temperature sensor can be affected by radiant heat when the vehicle is not moving.

To prevent false temperature readings, the displayed temperature will not update at low vehicle speeds.

If the vehicle has been turned off for less than four hours, the temperature at start up will be recalled from previous operation.

Do not cover the sensors; otherwise the automatic climate control system will not work properly.

### **Remote Start Climate Control Operation**

If equipped with the remote start feature, when it is activated, the climate control system will use the previous settings. See *Remote Vehicle Start* on page 2-8.

### **Regular Operation**

#### **Adjusting the Temperature**

When the climate control system has stabilized, adjust the temperature to a comfortable setting.

#### **Quick Cool Down**

When entering the vehicle on a hot day, open the windows for a short time to allow the hot air to escape.

### **Automatic Transmission**

If the vehicle is stopped for a long time in hot weather and the engine is running and the air conditioning is operating, move the shift lever to N (Neutral) or P (Park).

### **Hissing Sound**

A slight hissing sound when the air conditioning is turned off is normal.

### **Water**

Water may drip from underneath the vehicle, this is normal.

### **Unsealed Dusty Roads**

To help prevent dust from entering your vehicle:

- When following other vehicles on dusty roads and the dust is airborne, select .
- If the dust is not airborne, select outside air and set the fan control to high speed.
- Close all windows.

- Do not use recirculation for long periods of time.

### Air Vents

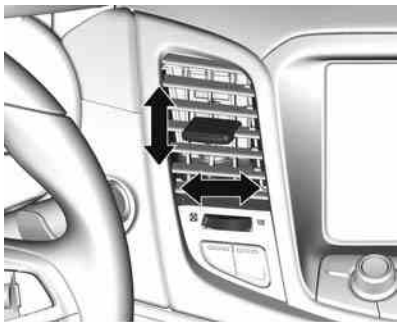

The air outlets have adjustable vanes that move up or down and left or right to change the direction of the airflow. Use the thumbwheels located near the air outlets on the instrument panel to shut off the airflow.

### Operation Tips

- Clear away any ice, snow, or leaves from the air inlets at the base of the windshield that may block the flow of air into the vehicle.
- Use of non-GM approved hood deflectors may adversely affect performance of the system.
- Keep the path under the front seats clear of objects to help circulate the air inside the vehicle more effectively.

### Maintenance

#### Passenger Compartment Air Filter

The vehicle has a passenger compartment air filter that filters the outside air entering the vehicle. The filter removes contaminants, such as pollen and dust. See your dealer for more information about filter replacement.



# Driving and Operating

## Driving Information

Distracted Driving .....	9-2
Defensive Driving .....	9-3
Drunk Driving .....	9-3
Control of a Vehicle .....	9-3
Braking .....	9-3
Steering .....	9-4
Off-Road Recovery .....	9-4
Loss of Control .....	9-5
Track Events and Competitive Driving .....	9-5
Driving on Wet Roads .....	9-6
Highway Hypnosis .....	9-7
Hill and Mountain Roads .....	9-7
Winter Driving .....	9-8
If the Vehicle Is Stuck .....	9-10
Vehicle Load Limits .....	9-10

## Starting and Operating

New Vehicle Break-In .....	9-15
Ignition Positions .....	9-15
Starting the Engine .....	9-17
Retained Accessory Power (RAP) .....	9-18

Shifting Into Park .....	9-18
Shifting out of Park .....	9-19
Parking over Things That Burn .....	9-21

## Engine Exhaust

Engine Exhaust .....	9-21
Running the Vehicle While Parked .....	9-22

## Automatic Transmission

Automatic Transmission .....	9-22
Manual Mode .....	9-24

## Brakes

Antilock Brake System (ABS) .....	9-26
Electric Parking Brake .....	9-27
Brake Assist .....	9-29
Hill Start Assist (HSA) .....	9-29

## Ride Control Systems

Traction Control/Electronic Stability Control .....	9-30
Competitive Driving Mode .....	9-31
Limited-Slip Rear Axle .....	9-32

## Cruise Control

Cruise Control .....	9-32
----------------------	------

## Driver Assistance Systems

Driver Assistance Systems .....	9-35
Assistance Systems for Parking or Backing .....	9-36
Assistance Systems for Driving .....	9-40
Forward Collision Alert (FCA) System .....	9-40
Side Blind Zone Alert (SBZA) .....	9-42
Lane Departure Warning (LDW) .....	9-44

## Fuel

Fuel .....	9-46
Recommended Fuel .....	9-46
Gasoline Specifications .....	9-47
California Fuel Requirements .....	9-47
Fuels in Foreign Countries .....	9-47
Fuel Additives .....	9-48
Filling the Tank .....	9-48
Filling a Portable Fuel Container .....	9-49

## 9-2 Driving and Operating

---

### Trailer Towing

Trailer Towing ..... 9-50

### Conversions and Add-Ons

Add-On Electrical  
Equipment ..... 9-50

## Driving Information

### Distracted Driving

Distraction comes in many forms and can take your focus from the task of driving. Exercise good judgment and do not let other activities divert your attention away from the road. Many local governments have enacted laws regarding driver distraction. Become familiar with the local laws in your area.

To avoid distracted driving, always keep your eyes on the road, hands on the wheel, and mind on the drive.

- Do not use a phone in demanding driving situations. Use a hands-free method to place or receive necessary phone calls.
- Watch the road. Do not read, take notes, or look up information on phones or other electronic devices.

- Designate a front seat passenger to handle potential distractions.
- Become familiar with vehicle features before driving, such as programming favorite radio stations and adjusting climate control and seat settings. Program all trip information into any navigation device prior to driving.
- Wait until the vehicle is parked to retrieve items that have fallen to the floor.
- Stop or park the vehicle to tend to children.
- Keep pets in an appropriate carrier or restraint.
- Avoid stressful conversations while driving, whether with a passenger or on a cell phone.

 **Warning**

Taking your eyes off the road too long or too often could cause a crash resulting in injury or death. Focus your attention on driving.

Refer to the Infotainment section for more information on using that system, including pairing and using a cell phone.

## Defensive Driving

Defensive driving means “always expect the unexpected.” The first step in driving defensively is to wear the safety belt. See *Safety Belts on page 3-8*.

- Assume that other road users (pedestrians, bicyclists, and other drivers) are going to be careless and make mistakes. Anticipate what they might do and be ready.

- Allow enough following distance between you and the driver in front of you.
- Focus on the task of driving.

## Drunk Driving

Death and injury associated with drinking and driving is a global tragedy.

 **Warning**

Drinking and then driving is very dangerous. Your reflexes, perceptions, attentiveness, and judgment can be affected by even a small amount of alcohol. You can have a serious — or even fatal — collision if you drive after drinking.

Do not drink and drive or ride with a driver who has been drinking. Ride home in a cab; or if you are with a group, designate a driver who will not drink.

## Control of a Vehicle

Braking, steering, and accelerating are important factors in helping to control a vehicle while driving.

## Braking

Braking action involves perception time and reaction time. Deciding to push the brake pedal is perception time. Actually doing it is reaction time.

Average driver reaction time is about three-quarters of a second. In that time, a vehicle moving at 100 km/h (60 mph) travels 20 m (66 ft), which could be a lot of distance in an emergency.

Helpful braking tips to keep in mind include:

- Keep enough distance between you and the vehicle in front of you.
- Avoid needless heavy braking.
- Keep pace with traffic.

## 9-4 Driving and Operating

---

If the engine ever stops while the vehicle is being driven, brake normally but do not pump the brakes. Doing so could make the pedal harder to push down. If the engine stops, there will be some power brake assist but it will be used when the brake is applied. Once the power assist is used up, it can take longer to stop and the brake pedal will be harder to push.

### Steering

#### Electric Power Steering

The vehicle has electric power steering. It does not have power steering fluid. Regular maintenance is not required.

If power steering assist is lost due to a system malfunction, the vehicle can be steered, but may require increased effort.

See your dealer if there is a problem.

If the steering wheel is turned until it reaches the end of its travel and is held against that position for an extended period of time, power steering assist may be reduced.

If the steering assist is used for an extended period of time, power assist may be reduced.

Normal use of the power steering assist should return when the system cools down.

See specific vehicle steering messages under *Service Vehicle Messages on page 5-31*. See your dealer if there is a problem.

#### Curve Tips

- Take curves at a reasonable speed.
- Reduce speed before entering a curve.
- Maintain a reasonable steady speed through the curve.
- Wait until the vehicle is out of the curve before accelerating gently into the straightaway.

#### Steering in Emergencies

- There are some situations when steering around a problem may be more effective than braking.
- Holding both sides of the steering wheel allows you to turn 180 degrees without removing a hand.
- The Antilock Brake System (ABS) allows steering while braking.

#### Off-Road Recovery

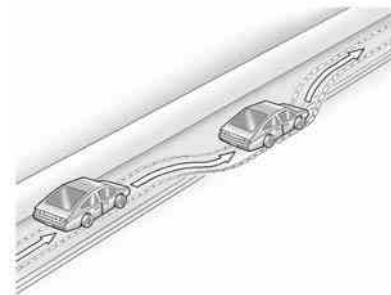

The vehicle's right wheels can drop off the edge of a road onto the shoulder while driving. Follow these tips:

1. Ease off the accelerator and then, if there is nothing in the way, steer the vehicle so that it straddles the edge of the pavement.
2. Turn the steering wheel about one-eighth of a turn, until the right front tire contacts the pavement edge.
3. Turn the steering wheel to go straight down the roadway.

## Loss of Control

### Skidding

There are three types of skids that correspond to the vehicle's three control systems:

- Braking Skid — wheels are not rolling.

- Steering or Cornering Skid — too much speed or steering in a curve causes tires to slip and lose cornering force.
- Acceleration Skid — too much throttle causes the driving wheels to spin.

Defensive drivers avoid most skids by taking reasonable care suited to existing conditions, and by not overdriving those conditions. But skids are always possible.

If the vehicle starts to slide, follow these suggestions:

- Ease your foot off the accelerator pedal and steer the way you want the vehicle to go. The vehicle may straighten out. Be ready for a second skid if it occurs.
- Slow down and adjust your driving according to weather conditions. Stopping distance can be longer and vehicle control can be affected when traction is reduced by water, snow, ice, gravel, or other

material on the road. Learn to recognize warning clues — such as enough water, ice, or packed snow on the road to make a mirrored surface — and slow down when you have any doubt.

- Try to avoid sudden steering, acceleration, or braking, including reducing vehicle speed by shifting to a lower gear. Any sudden changes could cause the tires to slide.

Remember: Antilock brakes help avoid only the braking skid.

## Track Events and Competitive Driving

Track events or competitive driving may affect the vehicle warranty. See the warranty manual before using the vehicle for track testing or other competitive driving.

### Caution

If the vehicle is used for track events and competitive driving, the engine may use more oil than it would with normal use. Low oil levels can damage the engine. Check the oil level often and at the proper level. See *Engine Oil* on page 10-6.

Be sure to check the oil level often during racing or other competitive driving and keep the level at or near the upper mark that shows the proper operating range on the engine oil dipstick.

For track events or competitive driving, it is recommended that the brake fluid be replaced with a high performance brake fluid that has a dry boiling point greater than 279°C (534°F). After conversion to the high performance brake fluid, follow the brake fluid service

recommendations outlined by the fluid manufacturer. Do not use silicone or DOT-5 brake fluids.

Because the fluid temperatures may be higher, it is necessary to change the rear axle fluid every 24 hours of racing or competitive driving. See *Recommended Fluids and Lubricants* on page 11-12.

### Caution

During a first time track or racing event, high rear axle temperatures can occur. Damage could be caused to the rear axle and would not be covered by the vehicle warranty.

Do not drive as long or as fast the first time the vehicle is driven on the track or raced.

For extended track use, GM recommends installing a rear differential cooler to protect the rear axle.

## Driving on Wet Roads

Rain and wet roads can reduce vehicle traction and affect your ability to stop and accelerate. Always drive slower in these types of driving conditions and avoid driving through large puddles and deep-standing or flowing water.

### Warning

Wet brakes can cause crashes. They might not work as well in a quick stop and could cause pulling to one side. You could lose control of the vehicle.

After driving through a large puddle of water or a car/vehicle wash, lightly apply the brake pedal until the brakes work normally.

Flowing or rushing water creates strong forces. Driving through flowing water could cause the vehicle to be carried away. If this

(Continued)

**Warning (Continued)**

happens, you and other vehicle occupants could drown. Do not ignore police warnings and be very cautious about trying to drive through flowing water.

**Hydroplaning**

Hydroplaning is dangerous. Water can build up under the vehicle's tires so they actually ride on the water. This can happen if the road is wet enough and you are going fast enough. When the vehicle is hydroplaning, it has little or no contact with the road.

There is no hard and fast rule about hydroplaning. The best advice is to slow down when the road is wet.

**Other Rainy Weather Tips**

Besides slowing down, other wet weather driving tips include:

- Allow extra following distance.

- Pass with caution.
- Keep windshield wiping equipment in good shape.
- Keep the windshield washer fluid reservoir filled.
- Have good tires with proper tread depth. See *Tires on page 10-34*.
- Turn off cruise control.

**Highway Hypnosis**

Always be alert and pay attention to your surroundings while driving. If you become tired or sleepy, find a safe place to park the vehicle and rest.

Other driving tips include:

- Keep the vehicle well ventilated.
- Keep the interior temperature cool.
- Keep your eyes moving — scan the road ahead and to the sides.
- Check the rearview mirror and vehicle instruments often.

**Hill and Mountain Roads**

Driving on steep hills or through mountains is different than driving on flat or rolling terrain. Tips for driving in these conditions include:

- Keep the vehicle serviced and in good shape.
- Check all fluid levels and brakes, tires, cooling system, and transmission.
- Shift to a lower gear when going down steep or long hills.

** Warning**

Using the brakes to slow the vehicle on a long downhill slope can cause brake overheating, can reduce brake performance, and could result in a loss of braking. Shift the transmission to a lower gear to let the engine assist the brakes on a steep downhill slope.

### Warning

Coasting downhill in N (Neutral) or with the ignition off is dangerous. This can cause overheating of the brakes and loss of steering. Always have the engine running and the vehicle in gear.

- Stay in your own lane. Do not swing wide or cut across the center of the road. Drive at speeds that let you stay in your own lane.
- Be alert on top of hills; something could be in your lane (stalled car, accident).
- Pay attention to special road signs (falling rocks area, winding roads, long grades, passing or no-passing zones) and take appropriate action.

## Winter Driving

### Driving on Snow or Ice

Drive carefully when there is snow or ice between the tires and the road, creating less traction or grip. Wet ice can occur at about 0°C (32°F) when freezing rain begins to fall, resulting in even less traction. Avoid driving on wet ice or in freezing rain until roads can be treated with salt or sand.

Drive with caution, whatever the condition. Accelerate gently so traction is not lost. Accelerating too quickly causes the wheels to spin and makes the surface under the tires slick, so there is even less traction.

Try not to break the fragile traction. If you accelerate too fast, the drive wheels will spin and polish the surface under the tires even more.

Traction Control should be turned on. See *Traction Control/Electronic Stability Control* on page 9-30.

The Antilock Brake System (ABS) improves vehicle stability during hard stops on slippery roads, but apply the brakes sooner than when on dry pavement. See *Antilock Brake System (ABS)* on page 9-26.

Allow greater following distance on any slippery road and watch for slippery spots. Icy patches can occur on otherwise clear roads in shaded areas. The surface of a curve or an overpass can remain icy when the surrounding roads are clear. Avoid sudden steering maneuvers and braking while on ice.

Turn off cruise control on slippery surfaces.



### Blizzard Conditions

Being stuck in snow can be a serious situation. Stay with the vehicle unless there is help nearby. If possible, use Roadside Assistance. See *Roadside Assistance Program on page 13-5*. To get help and keep everyone in the vehicle safe:

- Turn on the hazard warning flashers.
- Tie a red cloth to an outside mirror.

 **Warning**

Snow can trap engine exhaust under the vehicle. This may cause exhaust gases to get inside. Engine exhaust contains carbon monoxide (CO) which cannot be seen or smelled. It can cause unconsciousness and even death.

(Continued)

**Warning (Continued)**

If the vehicle is stuck in the snow:

- Clear away snow from around the base of your vehicle, especially any that is blocking the exhaust pipe.
- Check again from time to time to be sure snow does not collect there.
- Open a window about 5 cm (2 in) on the side of the vehicle that is away from the wind to bring in fresh air.
- Fully open the air outlets on or under the instrument panel.
- Adjust the climate control system to a setting that circulates the air inside the

(Continued)

**Warning (Continued)**

vehicle and set the fan speed to the highest setting. See “Climate Control Systems”.

For more information about carbon monoxide, see *Engine Exhaust on page 9-21*.

To save fuel, run the engine for only short periods as needed to warm the vehicle and then shut the engine off and close the window most of the way to save heat. Repeat this until help arrives but only when you feel really uncomfortable from the cold. Moving about to keep warm also helps.

If it takes some time for help to arrive, now and then when you run the engine, push the accelerator pedal slightly so the engine runs faster than the idle speed. This keeps the battery charged to restart

## 9-10 Driving and Operating

the vehicle and to signal for help with the headlamps. Do this as little as possible to save fuel.

### If the Vehicle Is Stuck

Slowly and cautiously spin the wheels to free the vehicle when stuck in sand, mud, ice, or snow.

If stuck too severely for the traction system to free the vehicle, turn the traction system off and use the rocking method. See *Traction Control/Electronic Stability Control* on page 9-30.

#### Warning

If the vehicle's tires spin at high speed, they can explode, and you or others could be injured. The vehicle can overheat, causing an engine compartment fire or other damage. Spin the wheels as little as possible and avoid going above 56 km/h (35 mph).

### Rocking the Vehicle to Get it Out

Turn the steering wheel left and right to clear the area around the front wheels. Turn off any traction system. Shift back and forth between R (Reverse) and a low forward gear, spinning the wheels as little as possible. To prevent transmission wear, wait until the wheels stop spinning before shifting gears. Release the accelerator pedal while shifting, and press lightly on the accelerator pedal when the transmission is in gear. Slowly spinning the wheels in the forward and reverse directions causes a rocking motion that could free the vehicle. If that does not get the vehicle out after a few tries, it might need to be towed out. If the vehicle does need to be towed out, see *Towing the Vehicle* on page 10-71.

### Vehicle Load Limits

It is very important to know how much weight the vehicle can carry. This weight is called the vehicle capacity weight and includes the weight of all occupants, cargo, and all nonfactory-installed options. Two labels on the vehicle show how much weight it may properly carry, the Tire and Loading Information label and the Certification label.

#### Warning

Do not load the vehicle any heavier than the Gross Vehicle Weight Rating (GVWR), or either the maximum front or rear Gross Axle Weight Rating (GAWR). This can cause systems to break and change the way the

(Continued)

**Warning (Continued)**

vehicle handles. This could cause loss of control and a crash. Overloading can also shorten the life of the vehicle.

**Tire and Loading Information Label**

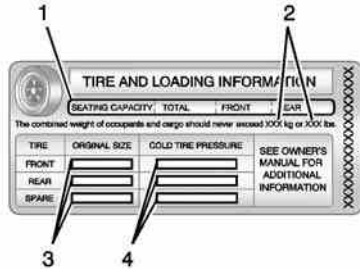

**Label Example**

1. Number of Occupant Seating Positions

2. Maximum Vehicle Capacity Weight
3. Size of the Original Equipment Tires
4. Recommended Cold Tire Inflation Pressure

A vehicle-specific Tire and Loading Information label is attached to the vehicle's center pillar (B-pillar). The Tire and Loading Information label shows the number of occupant seating positions (1), and the maximum vehicle capacity weight (2) in kilograms and pounds.

The Tire and Loading Information label also shows the tire size of the original equipment tires (3) and the recommended cold tire inflation pressures (4). For more information on tires and inflation see *Tires on page 10-34* and *Tire Pressure on page 10-41*.

There is also important loading information on the Certification label. It tells you the Gross Vehicle Weight Rating (GVWR) and the Gross Axle Weight Rating (GAWR) for the front and rear axle. See "Certification Label" later in this section.

**"Steps for Determining Correct Load Limit–**

1. Locate the statement "The combined weight of occupants and cargo should never exceed XXX kg or XXX lbs." on your vehicle's placard.
2. Determine the combined weight of the driver and passengers that will be riding in your vehicle.
3. Subtract the combined weight of the driver and passengers from XXX kg or XXX lbs.

## 9-12 Driving and Operating

- The resulting figure equals the available amount of cargo and luggage load capacity. For example, if the "XXX" amount equals 1400 lbs. and there will be five 150 lb passengers in your vehicle, the amount of available cargo and luggage load capacity is 650 lbs. (1400-750 (5 x 150) = 650 lbs.)
- Determine the combined weight of luggage and cargo being loaded on the vehicle. That weight may not safely exceed the available cargo and luggage load capacity calculated in Step 4.
- If your vehicle will be towing a trailer, load from your trailer will be transferred to your vehicle. Consult this manual to determine how this

reduces the available cargo and luggage load capacity of your vehicle."

See *Trailer Towing on page 9-50* for important information on towing a trailer, towing safety rules, and trailering tips.

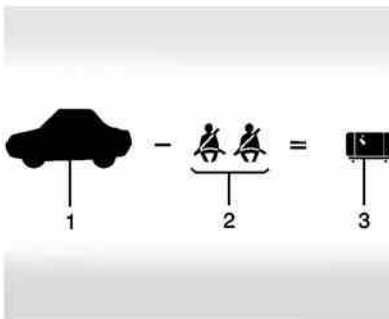

**Example 1**

- Vehicle Capacity Weight for Example 1 = 453 kg (1,000 lbs).

- Subtract Occupant Weight @ 68 kg (150 lbs) × 2 = 136 kg (300 lbs).
- Available Occupant and Cargo Weight = 317 kg (700 lbs).

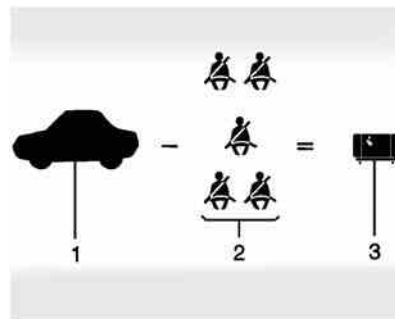

**Example 2**

- Vehicle Capacity Weight for Example 2 = 453 kg (1,000 lbs).
- Subtract Occupant Weight @ 68 kg (150 lbs) × 5 = 340 kg (750 lbs).

3. Available Cargo Weight = 113 kg (250 lbs).

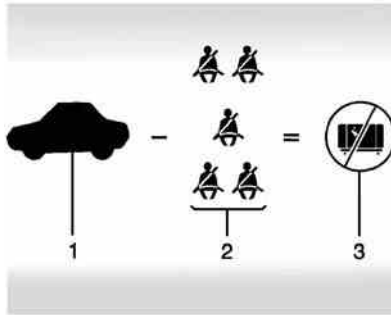

**Example 3**

1. Vehicle Capacity Weight for Example 3 = 453 kg (1,000 lbs).
2. Subtract Occupant Weight @ 91 kg (200 lbs) × 5 = 453 kg (1,000 lbs).
3. Available Cargo Weight = 0 kg (0 lbs).

Refer to the vehicle's Tire and Loading Information label for specific information about the vehicle's capacity weight and seating positions. The combined weight of the driver, passengers, and cargo should never exceed the vehicle's capacity weight.

**Certification Label**



**Label Example**

A vehicle-specific Certification label is attached to the vehicle's center pillar (B-pillar). The label tells the gross weight capacity of

the vehicle, called the Gross Vehicle Weight Rating (GVWR). The GVWR includes the weight of the vehicle, all occupants, fuel, and cargo. Never exceed the GVWR for the vehicle, or the Gross Axle Weight Rating (GAWR) for either the front or rear axle.

And, if there is a heavy load, it should be spread out. See "Steps for Determining Correct Load Limit" earlier in this section.

**Warning**

Do not load the vehicle any heavier than the Gross Vehicle Weight Rating (GVWR), or either the maximum front or rear Gross Axle Weight Rating (GAWR).

(Continued)

## 9-14 Driving and Operating

---

### Warning (Continued)

This can cause systems to break and change the way the vehicle handles. This could cause loss of control and a crash. Overloading can also shorten the life of the vehicle.

If you put things inside the vehicle — like suitcases, tools, packages, or anything else — they will go as fast as the vehicle goes. If you have to stop or turn quickly, or if there is a crash, they will keep going.

### Warning

Things inside the vehicle can strike and injure people in a sudden stop or turn, or in a crash.

- Put things in the cargo area of the vehicle. In the cargo area, put them as far forward as possible. Try to spread the weight evenly.
- Never stack heavier things, like suitcases, inside the vehicle so that some of them are above the tops of the seats.

(Continued)

### Warning (Continued)

- Do not leave an unsecured child restraint in the vehicle.
- Secure loose items in the vehicle.
- Do not leave a seat folded down unless needed.

## Starting and Operating

### New Vehicle Break-In

Use the following precautions to improve performance:

- For the first 1000 km (621 mi):  
Do not make full throttle starts.  
Avoid downshifting to brake or slow the vehicle.  
Do not drive at any one constant speed.  
Use moderate acceleration in lower gears.  
Avoid vehicle speeds above 110 km/h (68 mph).
- Between the first 1000 km (621 mi) and 5000 km (3,107 mi), heavy acceleration in lower gears may be used.  
Vehicle speeds above 110 km/h (68 mph) should be limited to five minutes per use.

- Avoid making hard stops for the first 350 km (217 mi) to avoid premature wear and early replacement of brakes.

### Ignition Positions



The vehicle has an electronic keyless ignition with pushbutton start.

Pressing the button cycles it through three modes: ACC/ACCESSORY, ON/RUN/START, and Stopping the Engine/OFF.

The transmitter must be in the vehicle for the system to operate. If the pushbutton start is not working, the vehicle may be near a strong radio antenna signal causing interference to the Keyless Access system. See *Remote Keyless Entry (RKE) System Operation on page 2-3*.

To shift out of P (Park), the vehicle must be in ACC/ACCESSORY or ON/RUN and the brake pedal must be applied.

**Stopping the Engine/OFF (No Indicator Lights):** When the vehicle is stopped, press the ENGINE START/STOP button once to turn the engine off.

If the vehicle is in P (Park), the ignition will turn off, and Retained Accessory Power (RAP) will remain active. See *Retained Accessory Power (RAP) on page 9-18*.

If the vehicle is not in P (Park), the ignition will return to ACC/ACCESSORY and display a message in the Driver Information

## 9-16 Driving and Operating

Center (DIC). See *Transmission Messages on page 5-32*. When the vehicle is shifted into P (Park), the ignition system will switch to OFF.

Do not turn the engine off when the vehicle is moving. This will cause a loss of power assist in the brake and steering systems and disable the airbags.

If the vehicle must be shut off in an emergency:

1. Brake using a firm and steady pressure. Do not pump the brakes repeatedly. This may deplete power assist, requiring increased brake pedal force.
2. Shift the vehicle to N (Neutral). This can be done while the vehicle is moving. After shifting to N (Neutral), firmly apply the brakes and steer the vehicle to a safe location.
3. Come to a complete stop, shift to P (Park), and turn the ignition to OFF. On vehicles with an automatic transmission, the shift

lever must be in P (Park) to turn the ignition switch to the OFF position.

4. Set the parking brake. See *Electric Parking Brake on page 9-27*.

### Warning

Turning off the vehicle while moving may cause loss of power assist in the brake and steering systems and disable the airbags. While driving, only shut the vehicle off in an emergency.

If the vehicle cannot be pulled over, and must be shut off while driving, press and hold the ENGINE START/STOP button for longer than two seconds, or press twice in five seconds.

**ACC/ACCESSORY (Amber Indicator Light):** This mode allows you to use some electrical accessories when the engine is off.

With the ignition off, pressing the button one time without the brake pedal applied will place the ignition system in ACC/ACCESSORY.

The ignition will switch from ACC/ACCESSORY to OFF after five minutes to prevent battery rundown.

**ON/RUN/START (Green Indicator Light):** This mode is for driving and starting. With the ignition off, and the brake pedal applied, pressing the button once will place the ignition system in ON/RUN/START. Once engine cranking begins, release the button. Engine cranking will continue until the engine starts. See *Starting the Engine on page 9-17*. The ignition will then remain in ON/RUN.

### Service Only Mode

This power mode is available for service and diagnostics, and to verify the proper operation of the malfunction indicator lamp as may be required for emission inspection purposes. With the vehicle off, and



the brake pedal not applied, pressing and holding the button for more than five seconds will place the vehicle in Service Only Mode. The instruments and audio systems will operate as they do in ON/RUN, but the vehicle will not be able to be driven. The engine will not start in Service Only Mode. Press the button again to turn the vehicle off.

## Starting the Engine

Move the shift lever to P (Park) or N (Neutral). The engine will not start in any other position. To restart the engine when the vehicle is already moving, use N (Neutral) only.

### Caution

Do not try to shift to P (Park) if the vehicle is moving. If you do, you could damage the transmission. Shift to P (Park) only when the vehicle is stopped.

### Caution

If you add electrical parts or accessories, you could change the way the engine operates. Any resulting damage would not be covered by the vehicle warranty. See *Add-On Electrical Equipment on page 9-50*.

## Starting Procedure

1. With the Keyless Access system, the transmitter must be in the vehicle. Put your foot on the brake pedal and push the START button. When the engine begins cranking, let go of the button.

The idle speed will go down as the engine gets warm. Do not race the engine immediately after starting it. Operate the engine and transmission gently to allow the oil to warm up and lubricate all moving parts.

If the transmitter is not in the vehicle or something is interfering with the transmitter, the Driver Information Center (DIC) will display a message. See *Key and Lock Messages on page 5-29*.

If the battery in the Remote Keyless Entry (RKE) transmitter needs replacing, the DIC will display a message. The vehicle can still be driven. See "Starting the Vehicle with a Low Transmitter Battery" in *Remote Keyless Entry (RKE) System Operation on page 2-3*.

The vehicle has a Computer-Controlled Cranking System. This feature assists in starting the engine and protects components. If the ENGINE START/STOP button is pressed, and then released when the engine begins cranking, the engine will continue cranking for a few seconds or until the vehicle starts. If the engine does not start and the button is

pressed for many seconds, cranking will be stopped after 15 seconds to prevent cranking motor damage. To prevent gear damage, this system also prevents cranking if the engine is already running. Engine cranking can be stopped by pressing the ENGINE START/STOP button a second time.

### **Caution**

Cranking the engine for long periods of time, by pressing the ENGINE START/STOP button immediately after cranking has ended, can overheat and damage the cranking motor, and drain the battery. Wait at least 15 seconds between each try, to let the cranking motor cool down.

2. If the engine does not start after five to 10 seconds, especially in very cold weather (below  $-18^{\circ}\text{C}$  or  $0^{\circ}\text{F}$ ), it could be flooded with too much gasoline. Try pushing

the accelerator pedal all the way to the floor and holding it there as you press the ENGINE START/STOP button, for up to a maximum of 15 seconds. Wait at least 15 seconds between each try, to allow the cranking motor to cool down. When the engine starts, let go of the button and the accelerator. If the vehicle starts briefly but then stops again, do the same thing. This clears the extra gasoline from the engine. Do not race the engine immediately after starting it. Operate the engine and transmission gently until the oil warms up and lubricates all moving parts.

### **Retained Accessory Power (RAP)**

The power windows will operate when the ignition is in the ON/RUN or ACC/ACCESSORY positions.

Once the ignition is turned off, RAP allows the power windows to continue to operate for up to 10 minutes. If a door is opened during this time, they will be deactivated.

The audio system will be deactivated only if the driver door is opened.

### **Shifting Into Park**

1. Hold the brake pedal down and set the parking brake.  
*See [Electric Parking Brake on page 9-27](#).*
2. Hold the button on the shift lever and push the lever toward the front of the vehicle into P (Park).
3. Turn the ignition off.

## Leaving the Vehicle With the Engine Running

### Warning

It can be dangerous to leave the vehicle with the engine running. It could overheat and catch fire.

It is dangerous to get out of the vehicle if the shift lever is not fully in P (Park) with the parking brake firmly set. The vehicle can roll.

Do not leave the vehicle when the engine is running. If you have left the engine running, the vehicle can move suddenly. You or others could be injured. To be sure the vehicle will not move, even when you are on fairly level ground, always set the parking brake and move the shift lever to P (Park). See *Shifting Into Park* on page 9-18.

If you have to leave the vehicle with the engine running, the vehicle must be in P (Park) and the parking brake set.

Release the button and check that the shift lever cannot be moved out of P (Park).

### Torque Lock

Torque lock is when the weight of the vehicle puts too much force on the parking pawl in the transmission. This happens when parking on a hill and shifting the transmission into P (Park) is not done properly and then it is difficult to shift out of P (Park). To prevent torque lock, set the parking brake and then shift into P (Park). To find out how, see “Shifting Into Park” listed previously.

If torque lock does occur, the vehicle may need to be pushed uphill by another vehicle to relieve the parking pawl pressure, so you can shift out of P (Park).

## Shifting out of Park

This vehicle is equipped with an electronic shift lock release system. The shift lock release is designed to prevent movement of the shift lever out of P (Park), unless the ignition is in ON/RUN and the brake pedal is applied.

The shift lock release is always functional except in the case of an uncharged or low voltage (less than 9-volt) battery.

If the vehicle has an uncharged battery or a battery with low voltage, try charging or jump starting the battery. See *Jump Starting* on page 10-69.

To shift out of P (Park):

1. Apply the brake pedal.
2. Place the ignition in ON/RUN.
3. Press the shift lever button.
4. Move the shift lever to the desired position.

## 9-20 Driving and Operating

---

If still unable to shift out of P (Park):

1. Fully release the shift lever button.
2. Hold the brake pedal down and press the shift lever button again.
3. Move the shift lever to the desired position.

If you are still having a problem shifting, see your dealer.

### Shift Lock Manual Release

If jump starting the vehicle did not work, the shift lock manual release must be used.

To access the shift lock manual release:

1. Apply the parking brake.



2. Remove the trim from the center console, in front of the shift lever.



3. Insert a tool into the opening as far as it will go and move the shift lever out of P (Park). If P (Park) is selected again, the shift lever will be locked again. Have the cause of the problem fixed by your dealer.
4. Refit the trim to the center console.

## Parking over Things That Burn

 **Warning**

Things that can burn could touch hot exhaust parts under the vehicle and ignite. Do not park over papers, leaves, dry grass, or other things that can burn.

## Engine Exhaust

 **Warning**

Engine exhaust contains carbon monoxide (CO) which cannot be seen or smelled. Exposure to CO can cause unconsciousness and even death.

Exhaust may enter the vehicle if:

- The vehicle idles in areas with poor ventilation (parking garages, tunnels, deep snow that may block underbody airflow or tail pipes).
- The exhaust smells or sounds strange or different.
- The exhaust system leaks due to corrosion or damage.
- The vehicle exhaust system has been modified, damaged, or improperly repaired.

(Continued)

**Warning (Continued)**

- There are holes or openings in the vehicle body from damage or aftermarket modifications that are not completely sealed.

If unusual fumes are detected or if it is suspected that exhaust is coming into the vehicle:

- Drive it only with the windows completely down.
- Have the vehicle repaired immediately.

Never park the vehicle with the engine running in an enclosed area such as a garage or a building that has no fresh air ventilation.

### Running the Vehicle While Parked

It is better not to park with the engine running.

If the vehicle is left with the engine running, follow the proper steps to be sure the vehicle will not move. See *Shifting Into Park* on page 9-18 and *Engine Exhaust* on page 9-21.

### Automatic Transmission



Press the select button on the front of the shift lever to move into any position.

When the shift lever position is changed, the lever position is indicated on the bottom of the Driver Information Center (DIC).

The engine will not start unless the shift lever is in P (Park) or N (Neutral).

**P (Park):** This position locks the rear wheels. It is the best position to use when the engine is started because the vehicle cannot move easily.

#### **Warning**

It is dangerous to get out of the vehicle if the shift lever is not fully in P (Park) with the parking brake firmly set. The vehicle can roll.

Do not leave the vehicle when the engine is running. If you have left the engine running, the vehicle can move suddenly. You or others could be injured. To be sure the vehicle will not move, even when you are on fairly level ground, always set the parking brake and move the shift lever to P (Park). See *Shifting Into Park* on page 9-18.

Make sure the shift lever is fully in P (Park) before starting the engine. The vehicle has an automatic

transmission shift lock control system. Fully apply the brake pedal first and then press the shift lever button before shifting from P (Park) when the ignition is in ON/RUN or ACC/ACCESSORY. If the vehicle will not shift out of P (Park), ease pressure on the shift lever and push the shift lever all the way into P (Park) while maintaining brake application. Then press the shift lever button and move the shift lever into another gear. See *Shifting out of Park on page 9-19*.

**R (Reverse):** Use this gear to back up.

At low vehicle speeds, R (Reverse) can also be used to rock the vehicle back and forth to get out of snow, ice, or sand without damaging the transmission. See *If the Vehicle Is Stuck on page 9-10* for additional information.

 **Caution**

Shifting to R (Reverse) while the vehicle is moving forward could damage the transmission. The repairs would not be covered by the vehicle warranty. Shift to R (Reverse) only after the vehicle is stopped.

**N (Neutral):** In this position, the engine does not connect with the wheels. To restart the engine when the vehicle is already moving, use N (Neutral) only.

 **Warning**

Shifting into a drive gear while the engine is running at high speed is dangerous. Unless your foot is firmly on the brake pedal, the vehicle could move very rapidly.

(Continued)

**Warning (Continued)**

You could lose control and hit people or objects. Do not shift into a drive gear while the engine is running at high speed.

 **Caution**

Shifting out of P (Park) or N (Neutral) with the engine running at high speed may damage the transmission. The repairs would not be covered by the vehicle warranty. Be sure the engine is not running at high speed when shifting the vehicle.

**D (Drive):** Use this position for general driving. The transmission automatically selects the appropriate gear according to the current load and driving conditions.

### Caution

If the vehicle accelerates slowly, or does not shift gears, the transmission could be damaged. Have the vehicle serviced right away.

### Sport Shift Mode



Sport Shift mode can be selected where maximum responsiveness is required.

When operated in Sport Shift mode, the transmission will delay upshifts and allow earlier downshifts.

In addition, the transmission can sense enthusiastic driving, at which point it may delay upshifting and downshift earlier when braking. This is designed to maximize vehicle performance.

To activate sport shift mode:

1. Move the shift lever to D (Drive).
2. Push the shift lever to the right.

Sport Mode On is displayed on the DIC.

Do not move the shift lever to + (Plus) or - (Minus), otherwise Active Select mode will be enabled.

3. To return to Normal Shift mode, move the shift lever left, to D (Drive). Sport Mode Off is displayed on the DIC.

On the bottom of the display, S appears as long as Sport Shift mode is selected.

### Normal Shift Mode

Normal shift mode is recommended for normal or freeway driving, as it provides optimum fuel economy.

When the shift lever is moved to D (Drive), normal shift mode is selected.

### Manual Mode

#### Active Select (A/S) Mode

A/S mode allows gears to be selected manually.

It can also provide engine braking by selecting the appropriate lower gear on a steep downhill grade.





To enable A/S mode:

1. Move the shift lever to D (Drive).
2. Push the lever to the right.
3. Shift to the required gear:

To shift up a gear, briefly push the lever forward toward the + (Plus) and release it.

To shift down a gear, briefly pull the lever rearward toward the - (Minus) and release it.

After changing the gear and releasing the shift lever, it returns to the center position on the right side of the selector.

On the bottom of the display, M and the currently selected gear appear as long as A/S mode is selected.

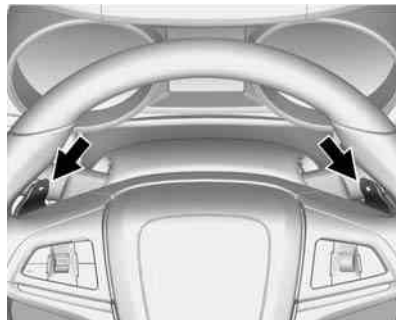

Alternatively, the paddles can be used to shift to the required gear:

To shift up a gear, briefly pull the + (Plus) paddle toward the steering wheel and release it.

To shift down a gear, briefly pull the - (Minus) paddle toward the steering wheel and release it.

- The transmission will shift to a selected gear only if the engine speed is within a suitable range. If not suitable, SHIFT DENIED will be displayed in the DIC, and the transmission will not shift gears. Continuing to hold the lever in the - (Minus) position will select the requested gear as soon as the vehicle speed decreases to the allowed speed for that gear.
- If the engine speed becomes too low for the currently selected gear, the transmission will automatically shift down, even though A/S mode is still selected.
- While in A/S mode, 2 (Second) or 3 (Third) gear starts can be selected from a standing start. This is useful for gentle acceleration on slippery surfaces.

To disable A/S mode and return to Normal Shift mode, push the shift lever to the left, to position D (Drive). On the bottom of the display, D is displayed.

To disable A/S mode and return to Sport Shift mode, hold the shift lever in the + (Plus) position for more than one second. On the bottom of the display, S is displayed.

### Temporary Active Select (A/S) Mode

A/S can also be operated from D (Drive) using the steering wheel paddles only. With the vehicle in motion, briefly pulling the + (Plus) or - (Minus) steering wheel paddles at any time will engage Temporary A/S mode.

In this mode A/S functions as if activated from Sport mode, except that the transmission will automatically exit Temporary A/S mode to Normal Shift mode if any of the following conditions are met:

- The vehicle speed drops below approximately 10 km/h (6 mph).
- No shift paddle is pressed, and steady driving without accelerating, decelerating, or cornering is detected for approximately seven seconds.
- The + (Plus) steering wheel paddle is pulled and held for more than one second.
- The shift lever is moved out of D (Drive) to Sport Shift mode.

## Brakes

### Antilock Brake System (ABS)

This vehicle has ABS, an advanced electronic braking system that helps prevent a braking skid.

When the vehicle begins to drive away, ABS checks itself. A momentary motor or clicking noise might be heard while this test is going on, and it might even be noticed that the brake pedal moves a little. This is normal.



If there is a problem with ABS, this warning light stays on. See *Antilock Brake System (ABS) Warning Light on page 5-16*.

If driving safely on a wet road and it becomes necessary to slam on the brakes and continue braking to avoid a sudden obstacle, a computer senses that the wheels are slowing down. If one of the wheels is about to stop rolling, the computer will separately work the brakes at each wheel.

ABS can change the brake pressure to each wheel, as required, faster than any driver could. This can help you steer around the obstacle while braking hard.

As the brakes are applied, the computer keeps receiving updates on wheel speed and controls braking pressure accordingly.

Remember: ABS does not change the time needed to get a foot up to the brake pedal or always decrease stopping distance. If you get too close to the vehicle in front of you, there will not be enough time to apply the brakes if that vehicle

suddenly slows or stops. Always leave enough room up ahead to stop, even with ABS.

### Using ABS

Do not pump the brakes. Just hold the brake pedal down firmly and let ABS work. You might hear the ABS pump or motor operating and feel the brake pedal pulsate, but this is normal.

### Braking in Emergencies

ABS allows you to steer and brake at the same time. In many emergencies, steering can help more than even the very best braking.

## Electric Parking Brake



The vehicle has an Electric Parking Brake (EPB). The switch is on the center console. The EPB can always be activated, even if the ignition is off. To prevent draining the battery, avoid repeated cycles of the EPB when the engine is not running.

The system has a red parking brake status light and an amber parking brake warning light. See *Electric Parking Brake Light* on page 5-15 and *Service Electric Parking Brake*

*Light on page 5-15.* There are also parking brake-related Driver Information Center (DIC) messages. See *Brake System Messages on page 5-26.* In case of insufficient electrical power, the EPB cannot be applied or released.

Before leaving the vehicle, check the red parking brake status light to ensure that the parking brake is applied.

### EPB Apply

To apply the EPB:

1. Be sure the vehicle is at a complete stop.
2. Lift up the EPB switch momentarily.

The red parking brake status light will flash and then stay on once the EPB is fully applied. If the red parking brake status light flashes continuously, then the EPB is only partially applied or there is a problem with the EPB. A DIC message will display. Release the EPB and try to apply it again. If the

light does not come on, or keeps flashing, have the vehicle serviced. Do not drive the vehicle if the red parking brake status light is flashing. See your dealer. See *Electric Parking Brake Light on page 5-15.*

If the amber parking brake warning light is on, lift up on the EPB switch and hold it up. Continue to hold the switch until the red parking brake status light remains on. If the amber parking brake warning light remains on, see your dealer.

If the EPB is applied while the vehicle is moving, the vehicle will decelerate as long as the switch is held up. If the switch is held up until the vehicle comes to a stop, the EPB will remain applied.

If the EPB fails to apply, the rear wheels should be blocked to prevent vehicle movement.

### EPB Release

To release the EPB:

1. Place the ignition in the ACC/ACCESSORY or ON/RUN position.
2. Apply and hold the brake pedal.
3. Push down momentarily on the EPB switch.

The EPB is released when the red parking brake status light is off.

If the amber parking brake warning light is on, release the EPB by pushing down on the EPB switch and holding it down. Continue to hold the switch until the red parking brake status light is off. If either light stays on after release is attempted, see your dealer.



Driving with the parking brake on can overheat the brake system and cause premature wear or

(Continued)

**Caution (Continued)**

damage to brake system parts. Make sure that the parking brake is fully released and the brake warning light is off before driving.

**Automatic EPB Release**

The EPB will automatically release if the vehicle is running, placed into gear, and an attempt is made to drive away. Avoid rapid acceleration when the EPB is applied, to preserve parking brake lining life.

**Brake Assist**

This vehicle has a brake assist feature designed to assist the driver in stopping or decreasing vehicle speed in emergency driving conditions. This feature automatically uses the stability system hydraulic brake control module to supplement the power brake system under conditions where the driver has quickly and

forcefully applied the brake pedal in an attempt to quickly stop or slow down the vehicle. The stability system hydraulic brake control module increases brake pressure at each corner of the vehicle until the ABS activates. Minor brake pedal pulsation or pedal movement during this time is normal and the driver should continue to apply the brake pedal as the driving situation dictates. The brake assist feature will automatically disengage when the brake pedal is released or brake pedal pressure is quickly decreased.

**Hill Start Assist (HSA)**

This vehicle has an HSA feature, which may be useful when the vehicle is stopped on a grade. This feature is designed to prevent the vehicle from rolling, either forward or rearward, during vehicle drive off. After the driver completely stops and holds the vehicle in a complete standstill on a grade, HSA will be automatically activated. During the

transition period between when the driver releases the brake pedal and starts to accelerate to drive off on a grade, HSA holds the braking pressure for a maximum of two seconds to ensure that there is no rolling. The brakes will automatically release when the accelerator pedal is applied within the two-second window. It will not activate if the vehicle is in a drive gear and facing downhill, or if the vehicle is facing uphill and in R (Reverse).

## Ride Control Systems

### Traction Control/ Electronic Stability Control

#### System Operation

The vehicle has a Traction Control System (TCS) and StabiliTrak<sup>®</sup>, an electronic stability control system. These systems help limit wheel slip and assist the driver in maintaining control, especially on slippery road conditions.

TCS activates if it senses that any of the drive wheels are spinning or beginning to lose traction. When this happens, TCS applies the brakes to the spinning wheels and reduces engine power to limit wheel spin.

StabiliTrak activates when the vehicle senses a difference between the intended path and the direction the vehicle is actually traveling. StabiliTrak selectively applies braking pressure to any one of the

vehicle wheel brakes to assist the driver in keeping the vehicle on the intended path.

If cruise control is being used and traction control or StabiliTrak begins to limit wheel spin, cruise control will disengage. Cruise control may be turned back on when road conditions allow.

Both systems come on automatically when the vehicle is started and begins to move. The systems may be heard or felt while they are operating or while performing diagnostic checks. This is normal and does not mean there is a problem with the vehicle.

It is recommended to leave both systems on for normal driving conditions, but it may be necessary to turn TCS off if the vehicle gets stuck in sand, mud, ice, or snow. See *If the Vehicle Is Stuck on page 9-10* and “Turning the Systems Off and On” later in this section.



The indicator light for both systems is in the instrument cluster. This light will:

- Flash when TCS is limiting wheel spin.
- Flash when StabiliTrak is activated.
- Turn on and stay on when either system is not working.

If either system fails to turn on or to activate, a message displays in the Driver Information Center (DIC), and  comes on and stays on to indicate that the system is inactive and is not assisting the driver in maintaining control. The vehicle is safe to drive, but driving should be adjusted accordingly.

If  comes on and stays on:

1. Stop the vehicle.
2. Turn the engine off and wait 15 seconds.
3. Start the engine.

Drive the vehicle. If  comes on and stays on, the vehicle may need more time to diagnose the problem. If the condition persists, see your dealer.

### Turning the Systems Off and On







To turn the system off, press the TCS/StabiliTrak button on the center console.

To turn off only TCS, press and release the TCS/StabiliTrak button. The traction off light  displays in the instrument cluster.

To turn TCS on again, press and release the TCS/StabiliTrak button. The traction off light  displayed in the instrument cluster will turn off.

If TCS is limiting wheel spin when the TCS/StabiliTrak button is pressed, the system will not turn off until the wheels stop spinning.

To turn off both TCS and StabiliTrak, press and hold the TCS/StabiliTrak button until the traction off light  and StabiliTrak OFF light  come on and stay on in the instrument cluster.

To turn TCS and StabiliTrak on again, press and release the TCS/StabiliTrak button. The traction off light  and StabiliTrak OFF light  in the instrument cluster turn off.

Adding accessories can affect the vehicle performance. See *Accessories and Modifications on page 10-2*.

### Competitive Driving Mode

The Competitive Driving Mode system is designed to allow increased performance while accelerating and/or cornering. This is accomplished by regulating and optimizing engine, steering, and brake performance. This mode is for use at a closed course race track and is not intended for use on public roads. It will not compensate for driver inexperience or lack of familiarity with the race track. Drivers who prefer to allow the system to have more control of the

engine and brake systems are advised to turn the normal TCS and StabiliTrak systems on.

### Competitive Driving Mode

Competitive Driving Mode controls engine power while the StabiliTrak system helps maintain directional control of the vehicle by selective brake application. In this mode, TCS is optimized. Adjust your driving style to account for the available engine power.

The  light is on when the vehicle is in the Competitive Driving Mode.

This optional handling mode can be selected by pressing the  button quickly two times. The appropriate message displays in the DIC. See *Ride Control System Messages on page 5-31* for more information.

When the  button is pressed again, the TCS and StabiliTrak systems are on. The appropriate message displays briefly in the DIC.

### Warning

The Competitive Driving Mode system is designed for a closed course race track and not intended for use on public roads. The system is not intended to compensate for lack of driver experience or familiarity with the race track.

### Limited-Slip Rear Axle

Vehicles with a limited-slip rear axle can give more traction on snow, mud, ice, sand, or gravel. When traction is low, this feature allows the drive wheel with the most traction to move the vehicle. The limited-slip rear axle also gives the driver enhanced control when cornering hard or completing a maneuver, such as a lane change.

## Cruise Control

With cruise control, the vehicle can maintain a speed of about 40 km/h (25 mph) or more without keeping your foot on the accelerator. Cruise control does not work at speeds below 40 km/h (25 mph).

If the brakes are applied, the cruise control is disengaged.

If the vehicle has the StabiliTrak<sup>®</sup> system and begins to limit wheel spin while using cruise control, the cruise control automatically disengages. See *Traction Control/Electronic Stability Control on page 9-30*. If a collision alert occurs when cruise control is activated, cruise control is disengaged. See *Forward Collision Alert (FCA) System on page 9-40*. When road conditions allow you to safely use it again, the cruise control can be turned back on.





### Warning

Cruise control can be dangerous where you cannot drive safely at a steady speed. Do not use the cruise control on winding roads or in heavy traffic.

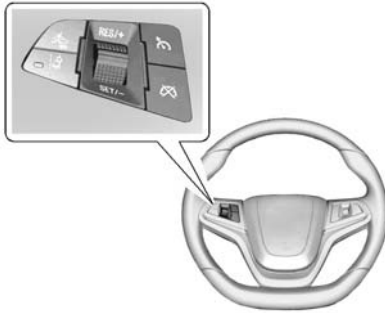
Cruise control can be dangerous on slippery roads. On such roads, fast changes in tire traction can cause excessive wheel slip, and you could lose control. Do not use cruise control on slippery roads.



 **(On/Off):** Press to turn the cruise control system on and off. A white cruise control indicator appears in the instrument cluster.

 **(Cancel):** Press to disengage cruise control without erasing the set speed from memory.

**RES/+ (Resume/Accel):** Move the thumbwheel up briefly to make the vehicle resume to a previously set speed or hold upwards to accelerate. If cruise control is already active, use to increase vehicle speed.

**SET/- (Set/Coast):** Move the thumbwheel down briefly to set the speed and activate cruise control. If cruise control is already active, use to decrease speed.

### Setting Cruise Control

If the cruise button is on when not in use, it could get bumped and go into cruise when not desired. Keep the cruise button turned off when cruise control is not being used.

To set a speed:

1. Press .
2. Get to the speed desired.
3. Move the thumbwheel down toward SET/- and release it. The cruise control indicator turns green.
4. Remove foot from the accelerator.

## 9-34 Driving and Operating

---

### Resuming a Set Speed

If the cruise control is set at a desired speed and then the brakes are applied, the cruise control is disengaged without erasing the set speed from memory.

Once the vehicle reaches about 40 km/h (25 mph) or more, move the thumbwheel up toward RES/+ briefly. The vehicle returns to the previous set speed.

### Increasing Speed While Using Cruise Control

If the cruise control system is already activated:

- Move the thumbwheel up toward RES/+ and hold it until the vehicle accelerates to the desired speed, and then release it.
- To increase the speed in small increments, move the thumbwheel up toward RES/+ briefly and then release it. Each

time this is done, the vehicle goes about 1.6 km/h (1 mph) faster.

### Reducing Speed While Using Cruise Control

If the cruise control system is already activated:

- Move the thumbwheel toward SET/- and hold until the desired lower speed is reached, then release it.
- To slow down in small increments, move the thumbwheel toward SET/- briefly. Each time this is done, the vehicle goes about 1.6 km/h (1 mph) slower.

### Passing Another Vehicle While Using Cruise Control



Use the accelerator pedal to increase the vehicle speed. When you take your foot off the pedal, the vehicle slows down to the previously set cruise control speed. While pressing the accelerator pedal or shortly following the release to override cruise control, briefly moving the thumbwheel toward SET/- will result in cruise control set to the current vehicle speed.

### Using Cruise Control on Hills

How well the cruise control works on hills depends upon the vehicle speed, load, and the steepness of the hills. When going up steep hills, you might have to step on the accelerator pedal to maintain the vehicle speed. When going downhill, you might have to brake or shift to a lower gear to maintain the vehicle speed. When the brakes are applied, the cruise control is disengaged.

### Ending Cruise Control

There are three ways to end cruise control:

- To disengage cruise control, step lightly on the brake pedal.
- Press .
- To turn off the cruise control, press .

### Erasing Speed Memory

The cruise control set speed is erased from memory if  is pressed or if the vehicle is turned off.

## Driver Assistance Systems

This vehicle may have features that work together to help avoid crashes or reduce crash damage while driving, backing, and parking. Read this entire section before using these systems.

### Warning

Do not rely on the Driver Assistance Systems. These systems do not replace the need for paying attention and driving safely. You may not hear or see alerts or warnings provided by these systems. Failure to use proper care when driving may result in injury, death, or vehicle damage. See *Defensive Driving* on page 9-3.

(Continued)

### Warning (Continued)

Under many conditions, these systems will not:

- Detect children, pedestrians, bicyclists, or animals.
- Detect vehicles or objects outside the area monitored by the system.
- Work at all driving speeds.
- Warn you or provide you with enough time to avoid a crash.
- Work under poor visibility or bad weather conditions.
- Work if the detection sensor is not cleaned or is covered by ice, snow, mud, or dirt.

Complete attention is always required while driving, and you should be ready to take action and apply the brakes and/or steer the vehicle to avoid crashes.

### Assistance Systems for Parking or Backing

When the vehicle is in R (Reverse), the Rear Vision Camera (RVC) and Rear Parking Assist may help the driver to avoid a crash or to reduce crash damage while backing and parking. Some models may also have Rear Cross Traffic Alert (RCTA), Automatic Parking Assist (APA), and/or Front Parking Assist.

When the vehicle is shifted into R (Reverse), the RVC displays an image of the area behind the vehicle in the center stack display. When the vehicle is shifted out of R (Reverse), the screen returns to the previous content, after a short delay. To see the previous content sooner, press one of the radio buttons. If the message Service Rear Camera System is displayed, the vehicle may need service.

#### Warning

The RVC system does not display children, pedestrians, bicyclists, animals, or any other object located outside the camera's field of view, below the bumper, or under the vehicle. Perceived distances may be different from actual distances. Do not back the vehicle using only the RVC screen, during longer, higher speed backing maneuvers, or where there could be cross traffic. Failure to use proper care before backing may result in injury, death, or vehicle damage. Always check behind and around the vehicle before backing.

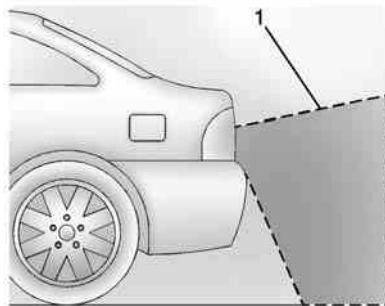

1. View Displayed by the Camera

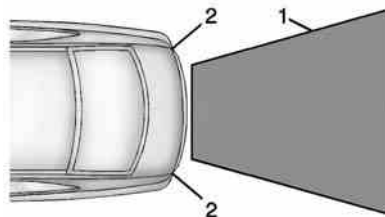

1. View Displayed by the Camera  
2. Corners of the Rear Bumper

Displayed images may be farther or closer than they appear. The area displayed is limited and objects that are close to either corner of the bumper or under the bumper do not display.

On vehicles with the Rear Cross Traffic Alert (RCTA), a triangle with an arrow may also display on the RVC screen to warn of traffic coming from either direction. This system detects objects coming from up to 20 m (65 ft) from the left or right side behind the vehicle. When an object is detected beeps sound from the left or right side, depending on the direction of the detected vehicle.

With Rear Park Assist, and if equipped with Front Park Assist, as the vehicle moves at speeds of less than 8 km/h (5 mph) the sensors on the bumpers detect objects up to 2.5 m (8 ft) behind and 1.2 m (4 ft) in front of the vehicle within a zone 25 cm (10 in) high off the ground

and below bumper level. These detection distances may be less during warmer or humid weather.

### Warning

The parking assist system does not detect children, pedestrians, bicyclists, animals, or objects located below the bumper or that are too close or too far from the vehicle. It is not available at speeds greater than 8 km/h (5 mph). To prevent injury, death, or vehicle damage, even with parking assist, always check the area around the vehicle and check all mirrors before moving forward or backing.

An obstacle is indicated by audible beeps. The interval between the beeps becomes shorter as the vehicle gets closer to the obstacle. When the distance is less than 30 cm (12 in) the beeping is a continuous tone for five seconds.

Beeps for Front Parking Assist are higher pitched than for Rear Parking Assist.

### Turning the Features On or Off



The  button near the shift lever is used to turn on or off the Front and Rear Parking Assist. The indicator light next to the button comes on when the features are on and turns off when the features have been disabled.

The Rear Vision Camera (RVC) parking assist symbols, guidance lines, and Rear Cross Traffic Alert

## 9-38 Driving and Operating

(RCTA) can be turned on or off through Vehicle Personalization. See *Vehicle Personalization* on page 5-33.

### Automatic Parking Assist (APA)

If equipped, the APA system searches for and steers the vehicle into parallel or perpendicular parking spots. When using APA, you must still shift gears, and control the brakes and accelerator. The Driver Information Center (DIC) and audible beeps help to guide parking maneuvers.

#### Warning

APA does not apply the brakes. APA may not detect objects in the parking space, objects that are soft or narrow, objects high off the ground such as flatbed trucks, or objects below ground level such as large potholes. Always

(Continued)

#### Warning (Continued)

verify that the parking space is appropriate for parking a vehicle. APA does not respond to changes in the parking space, such as movement of an adjacent vehicle, or a person or object entering the parking space. APA does not detect or avoid traffic that is behind or alongside of the vehicle. Always be prepared to stop the vehicle during the parking maneuver.



The system is available when the vehicle speed is below 30 km/h (18 mph). Press  to enable the system to begin searching for a space that is large enough to park. The system cannot detect whether it is a legal parking space.

If equipped with perpendicular parking mode, press and hold the APA button during the search process to switch the APA parking mode between perpendicular and parallel parking. APA searches for parking spaces to the right of the

vehicle. To search for a parking space to the left, turn on the left turn signal.

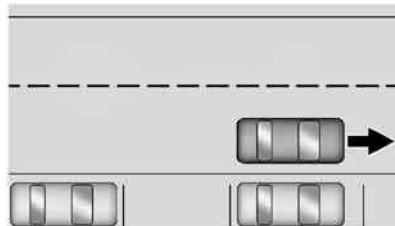

After completely passing a large enough space bordered by two vehicles or other objects, an audible beep occurs and a red symbol displays in the DIC.

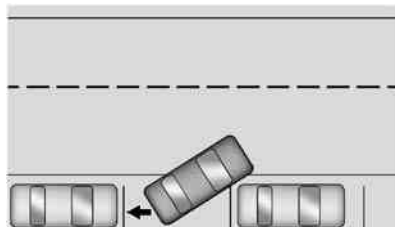

APA will instruct the vehicle to stop once a large enough space is found. Follow the instructions in the DIC. When instructed to drive in reverse, shift to R (Reverse) to engage automatic steering. The steering wheel will vibrate briefly as a reminder to remove hands from the steering wheel. Check surroundings and continue braking or accelerating as needed, and be prepared to stop to avoid vehicles, pedestrians, or objects. If the vehicle is in R (Reverse), but does not steer into the expected space, this may be because the system is maneuvering the vehicle into a previously detected space. The APA system does not need service.

If the vehicle exceeds 10 km/h (6 mph), APA is automatically disengaged and Automatic Steering will turn off. A DIC progress arrow displays the status of the parking maneuver. Depending on the space size, additional maneuvers may be required, and there will be additional instructions. When changing gears,

allow the automatic steering to complete before continuing the parking maneuver. Upon completion of a successful maneuver, APA will beep and display a PARKING COMPLETE message. Place the vehicle in P (Park).

APA may automatically disengage if:

- The steering wheel is used by the driver.
- The maximum allowed speed is exceeded.
- There is a failure with the APA system.
- Electronic stability control or antilock brakes are activated.
- An important vehicle message is displayed in the DIC.

To cancel APA, press the APA button again.

**When the System Does Not Seem to Work Properly**

The APA system may require a short period of driving along curves to calibrate.

### Assistance Systems for Driving

If equipped, when driving the vehicle, Forward Collision Alert (FCA), Lane Departure Warning (LDW), and Side Blind Zone Alert (SBZA) can help to avoid a crash or reduce crash damage.

### Forward Collision Alert (FCA) System

If equipped, the FCA system may help to avoid or reduce the harm caused by front-end crashes. When approaching a vehicle ahead too quickly, FCA provides a red flashing alert on the windshield and rapidly beeps. FCA also lights an amber visual alert if following another vehicle much too closely.

FCA detects vehicles within a distance of approximately 60 m (197 ft) and operates at speeds above 40 km/h (25 mph).

#### Warning

FCA is a warning system and does not apply the brakes. When approaching a slower-moving or stopped vehicle ahead too rapidly, or when following a vehicle too closely, FCA may not provide a warning with enough time to help avoid a crash. FCA does not warn of pedestrians, animals, signs, guardrails, bridges, construction barrels, or other objects. Be ready to take action and apply the brakes. For more information, see *Defensive Driving on page 9-3*.

FCA can be disabled with the FCA steering wheel control.

### Detecting the Vehicle Ahead



FCA warnings will not occur unless the FCA system detects a vehicle ahead. When a vehicle is detected, the vehicle ahead indicator will display green. Vehicles may not be detected on curves, highway exit ramps, or hills; or due to poor visibility. FCA will not detect another vehicle ahead until it is completely in the driving lane.

#### Warning

FCA does not provide a warning to help avoid a crash, unless it detects a vehicle. FCA may not detect a vehicle ahead if the FCA sensor is blocked by dirt, snow,

(Continued)



**Warning (Continued)**

or ice, or if the windshield is damaged. It may also not detect a vehicle on winding or hilly roads, or in conditions that can limit visibility such as fog, rain, or snow, or if the headlamps or windshield are not cleaned or in proper condition. Keep the windshield, headlamps, and FCA sensors clean and in good repair.

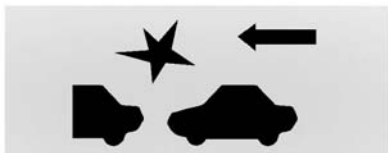
**Collision Alert**

When your vehicle approaches another detected vehicle too rapidly, the red FCA display will flash on the windshield. Also, eight rapid high-pitched beeps will sound from the front. When this Collision Alert

occurs, the brake system may prepare for driver braking to occur more rapidly which can cause a brief, mild deceleration. Continue to apply the brake pedal as needed. Cruise control may be disengaged when the Collision Alert occurs.

**Tailgating Alert**

The vehicle ahead indicator will display amber when you are following a detected vehicle ahead much too closely.

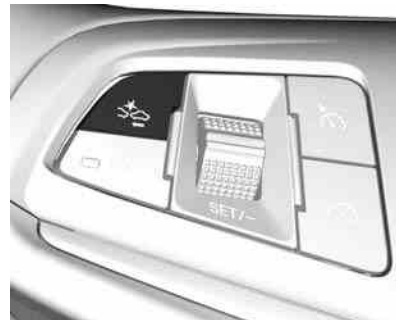
**Selecting the Alert Timing**

The Collision Alert control is on the steering wheel. Press  to set the FCA timing to Far, Medium, Near, or Off. The first button press shows the current setting on the Head-Up Display (HUD). Additional button presses will change this setting. The chosen setting will remain until it is changed and will affect the timing of both the Collision Alert and the Tailgating Alert features. The timing of both alerts will vary based on vehicle speed. The faster the vehicle speed, the farther away the

## 9-42 Driving and Operating

alert will occur. Consider traffic and weather conditions when selecting the alert timing. The range of selectable alert timing may not be appropriate for all drivers and driving conditions.

### Unnecessary Alerts

FCA may provide unnecessary alerts for turning vehicles, vehicles in other lanes, objects that are not vehicles, or shadows. These alerts are normal operation and the vehicle does not need service.

### Cleaning the System

If the FCA system does not seem to operate properly, cleaning the outside of the windshield in front of the camera sensor and the front of the vehicle may correct the issue.

### Side Blind Zone Alert (SBZA)

If equipped, the SBZA system is a lane-changing aid that assists drivers with avoiding crashes that

occur with vehicles in the side blind zone (or spot) areas. The SBZA warning display will light up in the corresponding outside side mirror and will flash if the turn signal is on.

#### Warning

SBZA does not alert the driver to vehicles rapidly approaching outside of the side blind zones, pedestrians, bicyclists, or animals. It may not provide alerts when changing lanes under all driving conditions. Failure to use proper care when changing lanes may result in injury, death, or vehicle damage. Before making a lane change, always check mirrors, glance over your shoulder, and use the turn signals.

### SBZA Detection Zones

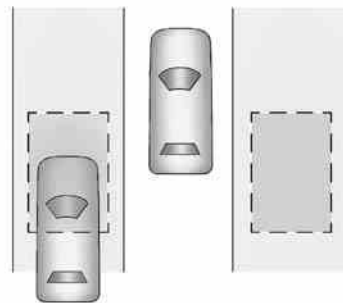

The SBZA sensor covers a zone of approximately one lane over from both sides of the vehicle, or 3.5 m (11 ft). The height of the zone is approximately between 0.5 m (1.5 ft) and 2 m (6 ft) off the ground. This zone starts at approximately the middle of the vehicle and goes back 5 m (16 ft).

### How the System Works

The SBZA symbol lights up in the side mirrors when the system detects a vehicle in the next lane

over that is in the side blind zone. This indicates it may be unsafe to change lanes. Before making a lane change, check the SBZA display, check mirrors, glance over your shoulder, and use the turn signals.

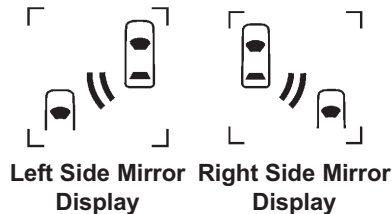

When the vehicle is started, both outside mirror SBZA displays will briefly come on to indicate the system is operating. When the vehicle is moving forward, the left- or right-side mirror display will light up if a vehicle is detected in that blind zone. If the turn signal is activated in the same direction of a detected vehicle, this display will flash as an extra warning not to change lanes.

SBZA can be disabled through vehicle personalization. See "Collision/Detection Systems" under *Vehicle Personalization on page 5-33*. If SBZA is disabled by the driver, the SBZA mirror displays will not light up.

### When the System Does Not Seem to Work Properly

SBZA displays may not come on when passing a vehicle quickly or when towing a trailer. The SBZA detection zones that extend back from the side of the vehicle do not move further back when a trailer is towed. Use caution while changing lanes when towing a trailer. SBZA may alert to objects attached to the vehicle, such as a trailer, bicycle, or object extending out to either side of the vehicle. This is normal system operation; the vehicle does not need service.

SBZA may not always alert the driver to vehicles in the side blind zone, especially in wet conditions. The system does not need to be

serviced. The system may light up due to guardrails, signs, trees, shrubs, and other non-moving objects. This is normal system operation; the vehicle does not need service.

SBZA may not operate when the SBZA sensors in the left or right corners of the rear bumper are covered with mud, dirt, snow, ice, or slush, or in heavy rainstorms. For cleaning instructions, see "Washing the Vehicle" under *Exterior Care on page 10-72*. If the DIC still displays the system unavailable message after cleaning both sides of the vehicle toward the rear corners of the vehicle, see your dealer.

If the SBZA displays do not light up when vehicles are in the blind zone and the system is clean, the system may need service. Take the vehicle to your dealer.

## 9-44 Driving and Operating

When SBZA is disabled for any reason other than the driver turning it off, the Side Blind Zone Alert On option will not be available on the personalization menu.

### FCC Information

See *Radio Frequency Statement on page 13-15*.

### Lane Departure Warning (LDW)

If equipped, LDW may help avoid crashes due to unintentional lane departures. It may provide a warning if the vehicle is crossing a detected lane without using a turn signal in the lane departure direction. LDW uses a camera sensor to detect the lane markings. It only operates at speeds of 56 km/h (35 mph) or greater.

When the vehicle crosses a detected lane marking and is traveling greater than 56 km/h (35 mph), the LDW indicator will flash and three beeps will be

sounded from the left or right side, depending on the lane departure direction. LDW will not warn if the turn signal is on or if a sharp maneuver is made.

#### Warning

The LDW system is an aid to help the vehicle stay in the driving lane. It does not steer the vehicle. The LDW system may not:

- Provide enough time to avoid a crash.
- Detect lane markings under bad weather conditions or if the windshield is dirty.
- Detect lane markings and will not detect road edges.
- Warn that the vehicle is crossing a lane marking if the system does not detect the lane marking.

(Continued)

#### Warning (Continued)

If LDW only detects lane markings on one side of the road, it will only warn you when departing the lane on the side where it has detected a lane marker. Even with LDW, always keep your attention on the road and maintain proper vehicle position within the lane, or vehicle damage, injury, or death could occur. Always keep the windshield clean and do not use LDW in bad weather conditions.

#### How the System Works

The LDW camera sensor is on the windshield ahead of the rearview mirror.

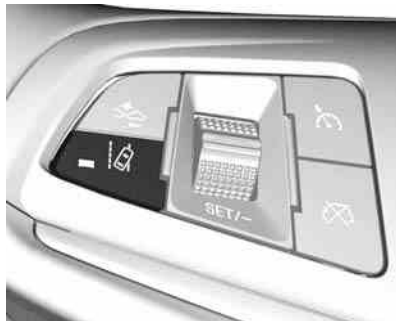

To turn LDW on and off, press  on the steering wheel. The control indicator will light when LDW is on.



When the vehicle is started, the LDW indicator on the instrument cluster will come on briefly.

If LDW is on, the LDW indicator will appear green if the system detects a left or right lane marking while the vehicle is traveling at 56 km/h (35 mph) or greater. If the vehicle crosses a detected lane marking without using the turn signal in the lane departure direction, this indicator will change to amber and flash. In addition, three beeps will be sounded from the left or right side, depending on the lane departure direction.

### When the System Does Not Seem to Work Properly

If the LDW symbol does not appear when the system is on and the vehicle is traveling at least 56 km/h (35 mph):

- The lane markings on the road may not be seen.
- The camera sensor may be blocked by dirt, snow, or ice.
- The windshield may be damaged.

- The weather may be limiting visibility.

This is normal operation; the vehicle does not need service. Clean the windshield.

Lane markings may not be detected on curves, highway exit ramps, or hills; or due to poor visibility.

If the LDW camera system does not seem to operate properly, cleaning the outside of the windshield in front of the camera sensor may correct the issue.

### Warning

LDW does not provide a warning to help avoid a crash, unless it detects the lane markings. LDW may not detect the lane markings if the camera sensor is blocked by dirt, snow, or ice, or if the windshield is damaged. It may also not detect a lane on winding or hilly roads, or in conditions that

(Continued)

**Warning (Continued)**

can limit visibility such as fog, rain, or snow, or if the headlamps or windshield are not cleaned or in proper condition. Keep the windshield, headlamps, and camera sensors clean and in good repair.

LDW warnings may occur due to tar marks, shadows, cracks in the road, or other road imperfections. This is normal system operation; the vehicle does not need service.

**Fuel**

Use of the recommended fuel is an important part of the proper maintenance of this vehicle. When driving in the U.S., to help keep the engine clean and maintain optimum vehicle performance, we recommend using TOP TIER Detergent Gasolines. See [www.toptiergas.com](http://www.toptiergas.com) for a list of TOP TIER Detergent Gasolines.



**Recommended Fuel**

Use premium unleaded gasoline with a posted octane rating of 91 or higher. Regular unleaded gasoline rated at 87 octane or higher can be used, but acceleration could be reduced, and an audible knocking noise may be heard. If the octane is less than 87, a heavy knocking noise may be heard. If this occurs, use a gasoline rated at 87 octane or higher as soon as possible. Otherwise, the engine could be damaged. If heavy knocking is heard when using gasoline with a higher octane rating, the engine needs service.

**Use of Seasonal Fuels**

Use summer and winter fuels in the appropriate season. Driving or starting could be affected if the incorrect fuel is used. Drive the vehicle with the engine running until the fuel is a half tank or less, then refuel with the current seasonal fuel.

## Prohibited Fuels

Gasolines containing oxygenates, such as ethers and ethanol, as well as reformulated gasolines are available in some cities. If these gasolines comply with the previously described specification, then they are acceptable to use. However, E85 and other fuels containing more than 15% ethanol must be used only in FlexFuel vehicles.

### Caution

Do not use fuel containing methanol. It can corrode metal parts in the fuel system and also damage plastic and rubber parts. That damage would not be covered under the vehicle warranty.

Some gasolines that are not reformulated for low emissions can contain an octane-enhancing additive called

methylcyclopentadienyl manganese tricarbonyl (MMT). Do not use gasolines with MMT as they can reduce spark plug life and affect emission control system performance. The malfunction indicator lamp may turn on. If this occurs, see your dealer for service.

## Gasoline Specifications

At a minimum, gasoline should meet ASTM specification D 4814. Some gasolines contain an octane-enhancing additive called methylcyclopentadienyl manganese tricarbonyl (MMT). We recommend against the use of gasolines containing MMT. See "Prohibited Fuels" in *Recommended Fuel* on page 9-46.

## California Fuel Requirements

If the vehicle is certified to meet California Emissions Standards, it is designed to operate on fuels that meet California specifications. See

the underhood emission control label. If this fuel is not available in states adopting California Emissions Standards, the vehicle will operate satisfactorily on fuels meeting federal specifications, but emission control system performance might be affected. The malfunction indicator lamp could turn on and the vehicle may not pass a smog-check test. See *Malfunction Indicator Lamp* on page 5-12. If this occurs, return to your authorized dealer for diagnosis. If it is determined that the condition is caused by the type of fuel used, repairs may not be covered by the vehicle warranty.

## Fuels in Foreign Countries

If planning to drive in countries outside the U.S., the proper fuel might be hard to find. Check regional auto club or fuel retail brand websites for availability in the country where driving. Never use leaded gasoline, fuel containing methanol, or any other fuel not

## 9-48 Driving and Operating

recommended. Costly repairs caused by use of improper fuel would not be covered by the vehicle warranty.

### Fuel Additives

To keep fuel systems clean, TOP TIER Detergent Gasoline is recommended. See *Fuel* on page 9-46.

If TOP TIER Detergent Gasoline is not available, one bottle of Fuel System Treatment PLUS, part number 88861013, added to the fuel tank at every engine oil change, can help. Fuel System Treatment PLUS is the only gasoline additive recommended by General Motors. It is available at your dealer.

### Filling the Tank

#### Warning

Fuel vapors and fuel fires burn violently and can cause injury or death.

- To help avoid injuries to you and others, read and follow all the instructions on the fuel pump island.
- Turn off the engine when refueling.
- Keep sparks, flames, and smoking materials away from fuel.
- Do not leave the fuel pump unattended.
- Do not reenter the vehicle while pumping fuel.
- Keep children away from the fuel pump and never let children pump fuel.

(Continued)

#### Warning (Continued)

- Fuel can spray out if the fuel cap is opened too quickly. This spray can happen if the tank is nearly full, and is more likely in hot weather. Open the fuel cap slowly and wait for any hiss noise to stop then unscrew the cap all the way

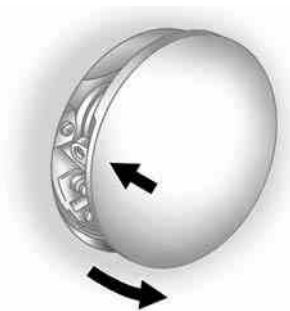



The fuel cap is behind a hinged fuel door on the passenger side of the vehicle. To open the fuel door, push and release the rearward center edge of the door.

When reinstalling the cap, turn it clockwise until it clicks, otherwise the malfunction indicator lamp may turn on. See *Malfunction Indicator Lamp on page 5-12*.

Be careful not to spill fuel. Do not top off or overfill the tank and wait a few seconds after you have finished pumping before removing the nozzle. Clean fuel from painted surfaces as soon as possible. See *Exterior Care on page 10-72*.

When replacing the fuel cap, turn it clockwise until it clicks. Make sure the cap is fully installed. The diagnostic system can determine if the fuel cap has been left off or improperly installed. This would allow fuel to evaporate into the atmosphere. See *Malfunction Indicator Lamp on page 5-12*.

### Warning

If a fire starts while you are refueling, do not remove the nozzle. Shut off the flow of fuel by shutting off the pump or by notifying the station attendant. Leave the area immediately.

### Caution

If a new fuel cap is needed, be sure to get the right type of cap from your dealer. The wrong type of fuel cap might not fit properly, might cause the malfunction indicator lamp to light, and could damage the fuel tank and emissions system. See *Malfunction Indicator Lamp on page 5-12*.

## Filling a Portable Fuel Container

### Warning

Filling a portable fuel container while it is in the vehicle can cause fuel vapors that can ignite either by static electricity or other means. You or others could be badly burned and the vehicle could be damaged. Always:

- Use approved fuel containers.
- Remove the container from the vehicle, trunk, or pickup bed before filling.
- Place the container on the ground.
- Place the nozzle inside the fill opening of the container before dispensing fuel, and

(Continued)

**Warning (Continued)**

keep it in contact with the fill opening until filling is complete.

- Fill the container no more than 95% full to allow for expansion.
- Do not smoke, light matches, or use lighters while pumping fuel.
- Avoid using cell phones or other electronic devices.

## Trailer Towing

The vehicle is neither designed nor intended to tow a trailer.

## Conversions and Add-Ons

### Add-On Electrical Equipment



Some electrical equipment can damage the vehicle or cause components to not work and would not be covered by the warranty. Always check with your dealer before adding electrical equipment.

Add-on equipment can drain the vehicle's 12-volt battery, even if the vehicle is not operating.

The vehicle has an airbag system. Before attempting to add anything electrical to the vehicle, see *Servicing the Airbag-Equipped Vehicle on page 3-24* and *Adding Equipment to the Airbag-Equipped Vehicle on page 3-25*.

## Vehicle Care

### General Information

General Information .....	10-2
California Proposition 65 Warning .....	10-2
California Perchlorate Materials Requirements ....	10-2
Accessories and Modifications .....	10-2

### Vehicle Checks

Doing Your Own Service Work .....	10-3
Hood .....	10-4
Engine Compartment Overview .....	10-5
Engine Oil .....	10-6
Engine Oil Life System .....	10-8
Automatic Transmission Fluid .....	10-9
Engine Air Cleaner/Filter ....	10-10
Cooling System .....	10-11
Engine Coolant .....	10-12
Engine Overheating .....	10-16
Washer Fluid .....	10-17
Brakes .....	10-18
Brake Fluid .....	10-19

Battery .....	10-20
Rear Axle .....	10-21
Starter Switch Check .....	10-21
Automatic Transmission Shift Lock Control Function Check .....	10-22
Ignition Transmission Lock Check .....	10-22
Park Brake and P (Park) Mechanism Check .....	10-23
Wiper Blade Replacement .....	10-23
Windshield Replacement ...	10-24

### Headlamp Aiming

Headlamp Aiming .....	10-24
-----------------------	-------

### Bulb Replacement

Bulb Replacement .....	10-24
High Intensity Discharge (HID) Lighting .....	10-24
License Plate Lamp .....	10-25
Replacement Bulbs .....	10-25

### Electrical System

Electrical System Overload .....	10-26
Fuses .....	10-26

Engine Compartment Fuse Block .....	10-27
Instrument Panel Fuse Block .....	10-29
Rear Compartment Fuse Block .....	10-32

### Wheels and Tires

Tires .....	10-34
Winter Tires .....	10-35
Low-Profile Tires .....	10-35
Summer Tires .....	10-36
Tire Sidewall Labeling .....	10-36
Tire Designations .....	10-37
Tire Terminology and Definitions .....	10-38
Tire Pressure .....	10-41
Tire Pressure Monitor System .....	10-42
Tire Pressure Monitor Operation .....	10-43
Tire Inspection .....	10-46
Tire Rotation .....	10-47
When It Is Time for New Tires .....	10-48
Buying New Tires .....	10-49
Different Size Tires and Wheels .....	10-50

## 10-2 Vehicle Care

---

Uniform Tire Quality Grading .....	10-51
Wheel Alignment and Tire Balance .....	10-52
Wheel Replacement .....	10-52
Tire Chains .....	10-53
If a Tire Goes Flat .....	10-54
Tire Sealant and Compressor Kit .....	10-56
Storing the Tire Sealant and Compressor Kit .....	10-62
Tire Changing .....	10-63
Full-Size Spare Tire .....	10-68
<b>Jump Starting</b>	
Jump Starting .....	10-69
<b>Towing the Vehicle</b>	
Towing the Vehicle .....	10-71
Recreational Vehicle Towing .....	10-72
<b>Appearance Care</b>	
Exterior Care .....	10-72
Interior Care .....	10-77
Floor Mats .....	10-81

### General Information

For service and parts needs, visit your dealer. You will receive genuine GM parts and GM-trained and supported service people.

Genuine GM parts have one of these marks:

---



**ACDelco**<sup>®</sup>

---



Genuine  Parts

---



 **Accessories**

### California Proposition 65 Warning

Most motor vehicles, including this one, contain and/or emit chemicals known to the State of California to

cause cancer and birth defects or other reproductive harm. Engine exhaust, many parts and systems, many fluids, and some component wear by-products contain and/or emit these chemicals.

### California Perchlorate Materials Requirements

Certain types of automotive applications, such as airbag initiators, safety belt pretensioners, and lithium batteries contained in Remote Keyless Entry transmitters, may contain perchlorate materials. Special handling may be necessary. For additional information, see [www.dtsc.ca.gov/hazardouswaste/perchlorate](http://www.dtsc.ca.gov/hazardouswaste/perchlorate).

### Accessories and Modifications

Adding non-dealer accessories or making modifications to the vehicle can affect vehicle performance and safety, including such things as airbags, braking, stability, ride and

handling, emissions systems, aerodynamics, durability, and electronic systems like antilock brakes, traction control, and stability control. These accessories or modifications could even cause malfunction or damage not covered by the vehicle warranty.

Damage to vehicle components resulting from modifications or the installation or use of non-GM certified parts, including control module or software modifications, is not covered under the terms of the vehicle warranty and may affect remaining warranty coverage for affected parts.

GM Accessories are designed to complement and function with other systems on the vehicle. See your dealer to accessorize the vehicle using genuine GM Accessories installed by a dealer technician.

Also, see *Adding Equipment to the Airbag-Equipped Vehicle* on page 3-25.

## Vehicle Checks

### Doing Your Own Service Work

#### Warning

It can be dangerous to work on your vehicle if you do not have the proper knowledge, service manual, tools, or parts. Always follow owner manual procedures and consult the service manual for your vehicle before doing any service work.

If doing some of your own service work, use the proper service manual. It tells you much more about how to service the vehicle than this manual can. To order the proper service manual, see *Service Publications Ordering Information* on page 13-11.

This vehicle has an airbag system. Before attempting to do your own service work, see *Servicing the Airbag-Equipped Vehicle* on page 3-24.

Keep a record with all parts receipts and list the mileage and the date of any service work performed. See *Maintenance Records* on page 11-14.

#### Caution

Even small amounts of contamination can cause damage to vehicle systems. Do not allow contaminants to contact the fluids, reservoir caps, or dipsticks.

## 10-4 Vehicle Care

---

### Hood

To open the hood:



1. Pull up on the hood release handle with this symbol on it. It is located below the instrument panel to the left of the steering column.



2. Push up on the secondary hood release and lift the hood.

To close the hood:

1. Before closing the hood, be sure all the filler caps are on properly.
2. Lower the hood 30 cm (12 in) above the vehicle and release it so it fully latches. Check to make sure the hood is closed and repeat the process if necessary.

## Engine Compartment Overview

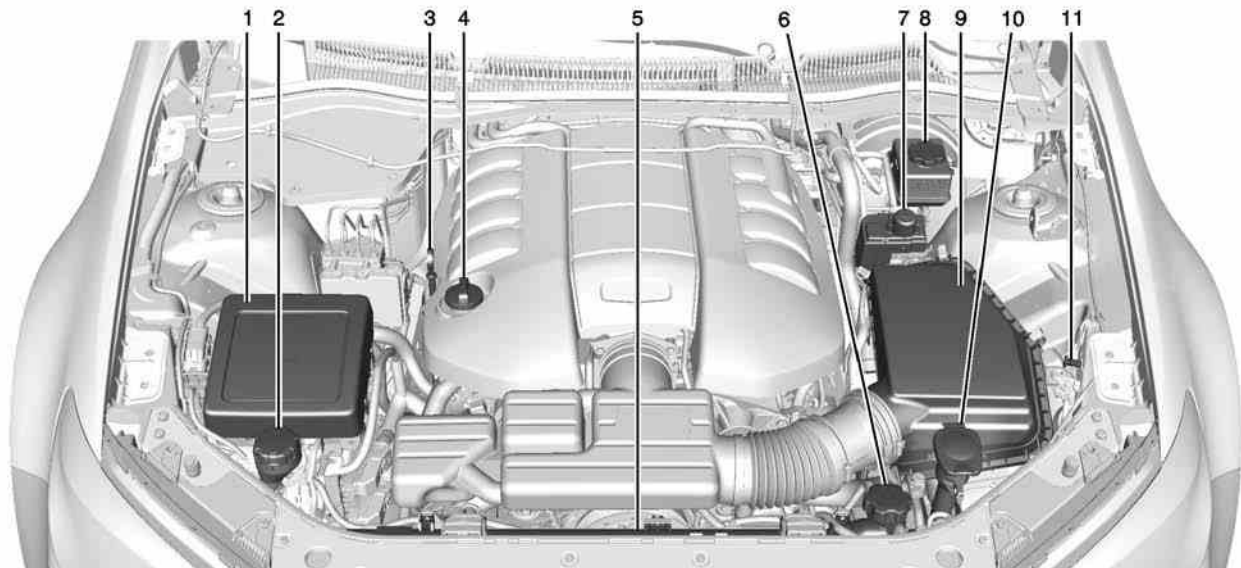

## 10-6 Vehicle Care

---

1. *Engine Compartment Fuse Block on page 10-27.*
2. *Coolant Recovery Reservoir and Dipstick Cap. See Cooling System on page 10-11.*
3. *Engine Oil Dipstick. See Engine Oil on page 10-6.*
4. *Engine Oil Fill Cap. See Engine Oil on page 10-6.*
5. *Engine Cooling Fans (Out of View). See Cooling System on page 10-11.*
6. *Radiator Pressure Cap. See Cooling System on page 10-11.*
7. *Remote Positive (+) Terminal. See Jump Starting on page 10-69.*
8. *Brake Master Cylinder Reservoir. See Brakes on page 10-18.*
9. *Engine Air Cleaner/Filter on page 10-10.*
10. *Windshield Washer Fluid Reservoir. See Washer Fluid on page 10-17.*

11. *Remote Negative (-) Terminal. See Jump Starting on page 10-69.*

### Engine Oil

To ensure proper engine performance and long life, careful attention must be paid to engine oil. Following these simple, but important steps will help protect your investment:

- Always use engine oil approved to the proper specification and of the proper viscosity grade. See “Selecting the Right Engine Oil” in this section.
- Check the engine oil level regularly and maintain the proper oil level. See “Checking Engine Oil” and “When to Add Engine Oil” in this section.
- Change the engine oil at the appropriate time. See *Engine Oil Life System on page 10-8.*

- Always dispose of engine oil properly. See “What to Do with Used Oil” in this section.

### Checking Engine Oil

It is a good idea to check the engine oil level at each fuel fill. In order to get an accurate reading, the vehicle must be on level ground. The engine oil dipstick handle is a loop. See *Engine Compartment Overview on page 10-5* for the location of the engine oil dipstick.

Obtaining an accurate oil level reading is essential:

1. If the engine has been running recently, turn off the engine and allow several minutes for the oil to drain back into the oil pan. Checking the oil level too soon after engine shutoff will not provide an accurate oil level reading.



### Warning

The engine oil dipstick handle may be hot; it could burn you. Use a towel or glove to touch the dipstick handle.

2. Pull out the dipstick and clean it with a paper towel or cloth, then push it back in all the way. Remove it again, keeping the tip down, and check the level.

### When to Add Engine Oil



If the oil is at the lower mark at the tip of the dipstick, add 1 L (1 qt) of the recommended oil and then recheck the level. See “Selecting the Right Engine Oil” in this section for an explanation of what kind of oil

to use. For engine oil crankcase capacity, see *Capacities and Specifications on page 12-2*

### Caution

Do not add too much oil. Oil levels above or below the acceptable operating range shown on the dipstick are harmful to the engine. If you find that you have an oil level above the operating range, the engine could be damaged. You should drain out the excess oil or limit driving of the vehicle and seek a service professional to remove the excess amount of oil.

See *Engine Compartment Overview on page 10-5*

Add enough oil to reach the upper mark on the dipstick. Push the dipstick all the way back in when through.

### Selecting the Right Engine Oil

Selecting the right engine oil depends on both the proper oil specification and viscosity grade. See *Recommended Fluids and Lubricants on page 11-12*.

#### Specification

Use and ask for licensed engine oils with the dexos1<sup>®</sup> approved certification mark. Engine oils meeting the requirements for the vehicle should have the dexos1 approved certification mark. This certification mark indicates that the oil has been approved to the dexos1 specification.



### **Caution**

Failure to use the recommended engine oil can result in engine damage not covered by the vehicle warranty. Check with your dealer or service provider on whether the oil is approved to the dexos1 specification.

### **Viscosity Grade**

SAE 5W-30 is the best viscosity grade for the vehicle. Do not use other viscosity grade oils such as SAE 10W-30, 10W-40, or 20W-50.

**Cold Temperature Operation:** In an area of extreme cold, where the temperature falls below  $-29^{\circ}\text{C}$  ( $-20^{\circ}\text{F}$ ), an SAE 0W-30 oil may be used. An oil of this viscosity grade will provide easier cold starting for the engine at extremely low temperatures. When selecting an oil of the appropriate viscosity grade, always select an oil of the correct

specification. See “Specification” earlier in this section for more information.

### **Engine Oil Additives/Engine Oil Flushes**

Do not add anything to the oil. The recommended oils with the dexos specification and displaying the dexos certification mark are all that is needed for good performance and engine protection.

Engine oil system flushes are not recommended and could cause engine damage not covered by the vehicle warranty.

### **What to Do with Used Oil**

Used engine oil contains certain elements that can be unhealthy for your skin and could even cause cancer. Do not let used oil stay on your skin for very long. Clean your skin and nails with soap and water, or a good hand cleaner. Wash or properly dispose of clothing or rags

containing used engine oil. See the manufacturer’s warnings about the use and disposal of oil products.

Used oil can be a threat to the environment. If you change your own oil, be sure to drain all the oil from the filter before disposal. Never dispose of oil by putting it in the trash or pouring it on the ground, into sewers, or into streams or bodies of water. Recycle it by taking it to a place that collects used oil.

## **Engine Oil Life System**

### **When to Change Engine Oil**

This vehicle has a computer system that indicates when to change the engine oil and filter. This is based on a combination of factors which include engine revolutions, engine temperature, and miles driven. Based on driving conditions, the mileage at which an oil change is indicated can vary considerably. For the oil life system to work properly, the system must be reset every time the oil is changed.

When the system has calculated that oil life has been diminished, it indicates that an oil change is necessary. A CHANGE ENGINE OIL SOON message comes on. See *Engine Oil Messages on page 5-28*. Change the oil as soon as possible within the next 1 000 km (600 mi). It is possible that, if driving under the best conditions, the oil life system might indicate that an oil change is not necessary for up to a year. The engine oil and filter must be changed at least once a year and, at this time, the system must be reset. Your dealer has trained service people who will perform this work and reset the system. It is also important to check the oil regularly over the course of an oil drain interval and keep it at the proper level.

If the system is ever reset accidentally, the oil must be changed at 5 000 km (3,000 mi) since the last oil change. Remember to reset the oil life system whenever the oil is changed.

### How to Reset the Engine Oil Life System

Reset the system whenever the engine oil is changed so that the system can calculate the next engine oil change. To reset the system:

1. Display the REMAINING OIL LIFE on the DIC. See *Driver Information Center (DIC) on page 5-21*.
2. Press and hold the SET/CLR button on the DIC while the Oil Life display is active. The oil life will change to 100%.

The oil life system can also be reset as follows:

1. Turn the ignition to ON/RUN with the engine off.
2. Fully press and release the accelerator pedal three times within five seconds.

The system is reset when the CHANGE ENGINE OIL SOON message goes off.

If the CHANGE ENGINE OIL SOON message comes back on when the vehicle is started, the engine oil life system has not been reset. Repeat the procedure.

### Automatic Transmission Fluid

#### How to Check Automatic Transmission Fluid

It is not necessary to check the transmission fluid level. A transmission fluid leak is the only reason for fluid loss. If a leak occurs, take the vehicle to your dealer service department and have it repaired as soon as possible.

There is a special procedure for checking and changing the transmission fluid. Because this procedure is difficult, you should have this done at your dealer service department. Contact your dealer for additional information or the procedure can be found in the service manual. To purchase a

## 10-10 Vehicle Care

service manual, see *Service Publications Ordering Information* on page 13-11.

Change the fluid and filter at the intervals listed in *Maintenance Schedule* on page 11-2, and be sure to use the fluid listed in *Recommended Fluids and Lubricants* on page 11-12.

### Engine Air Cleaner/Filter

See *Engine Compartment Overview* on page 10-5 for the location of the engine air cleaner/filter.

#### When to Inspect the Engine Air Cleaner/Filter

Inspect the air cleaner/filter at the scheduled maintenance intervals and replace it when required. See *Maintenance Schedule* on page 11-2 for more information. If driving in dusty/dirty conditions, inspect the filter at each engine oil change.

#### How to Inspect the Engine Air Cleaner/Filter

To inspect the air cleaner/filter, remove the filter from the vehicle and lightly shake the filter to release loose dust and dirt. If the filter remains covered with dirt, a new filter is required. Never use compressed air to clean the filter.

To inspect or replace the engine air cleaner/filter:

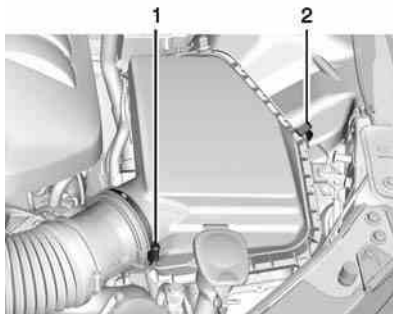

1. Air Duct Clamp Screw
2. Retaining Clips

1. Open the hood. See *Hood* on page 10-4.
2. Disconnect the outlet duct by loosening the screw (1) on the air duct clamp.
3. Remove the retaining clips (2) securing the cover on the air cleaner/filter housing.
4. Pull straight up on the cover; while holding the cover, remove the air filter.
5. Inspect or replace the air filter. See *Maintenance Replacement Parts* on page 11-13.
6. Reverse Steps 2–5 to reinstall the cover.

#### **Warning**

Operating the engine with the air cleaner/filter off can cause you or others to be burned. The air cleaner not only cleans the air; it helps to stop flames if the engine

(Continued)

**Warning (Continued)**

backfires. Use caution when working on the engine and do not drive with the air cleaner/filter off.

**⚠ Caution**

If the air cleaner/filter is off, dirt can easily get into the engine, which could damage it. Always have the air cleaner/filter in place when you are driving.

**Cooling System**

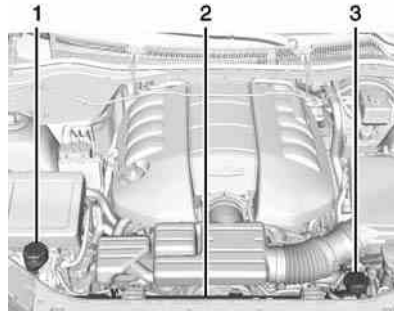

1. Coolant Recovery Reservoir
2. Engine Cooling Fans (Out of View)
3. Radiator Cap

**⚠ Warning**

An electric engine cooling fan under the hood can start up even when the engine is not running  
(Continued)

**Warning (Continued)**

and can cause injury. Keep hands, clothing, and tools away from any underhood electric fan.

**⚠ Warning**

Heater and radiator hoses, and other engine parts, can be very hot. Do not touch them. If you do, you can be burned.

Do not run the engine if there is a leak. If you run the engine, it could lose all coolant. That could cause an engine fire, and you could be burned. Get any leak fixed before you drive the vehicle.

### Caution

Using coolant other than DEX-COOL<sup>®</sup> can cause premature engine, heater core, or radiator corrosion. In addition, the engine coolant could require changing sooner. Any repairs would not be covered by the vehicle warranty. Always use DEX-COOL (silicate-free) coolant in the vehicle.

## Engine Coolant

The cooling system in the vehicle is filled with DEX-COOL<sup>®</sup> engine coolant. This coolant is designed to remain in the vehicle for 5 years or 240 000 km (150,000 mi), whichever occurs first.

The following explains the cooling system and how to check and add coolant when it is low. If there is a problem with engine overheating, see *Engine Overheating on page 10-16*.

## What to Use

### Warning

Adding only plain water or some other liquid to the cooling system can be dangerous. Plain water and other liquids, can boil before the proper coolant mixture will. The coolant warning system is set for the proper coolant mixture. With plain water or the wrong mixture, the engine could get too hot but you would not get the overheat warning. The engine could catch fire and you or others could be burned. Use a 50/50 mixture of clean, drinkable water and DEX-COOL coolant.

Use a 50/50 mixture of clean, drinkable water and DEX-COOL coolant. If using this mixture, nothing else needs to be added. This mixture:

- Gives freezing protection down to  $-37^{\circ}\text{C}$  ( $-34^{\circ}\text{F}$ ), outside temperature.
- Gives boiling protection up to  $129^{\circ}\text{C}$  ( $265^{\circ}\text{F}$ ), engine temperature.
- Protects against rust and corrosion.
- Will not damage aluminum parts.
- Helps keep the proper engine temperature.

### Caution

If improper coolant mixture, inhibitors, or additives are used in the vehicle cooling system, the engine could overheat and be damaged. Too much water in the

(Continued)

**Caution (Continued)**

mixture can freeze and crack engine cooling parts. The repairs would not be covered by the vehicle warranty. Use only the proper mixture of engine coolant for the cooling system. See *Recommended Fluids and Lubricants* on page 11-12.

Never dispose of engine coolant by putting it in the trash, pouring it on the ground, or pouring it into sewers, streams or bodies of water. Have the coolant changed by an authorized service center, familiar with legal requirements regarding used coolant disposal. This will help protect the environment and your health.

**Checking Coolant**

The vehicle must be on a level surface when checking the coolant level.

To check coolant:

1. Turn the ignition off.
2. Locate the coolant recovery reservoir. See *Engine Compartment Overview* on page 10-5.

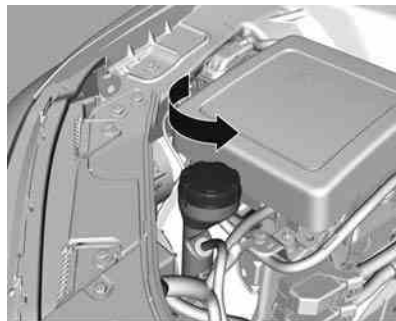

3. Turn the coolant recovery reservoir dipstick cap counterclockwise and slowly pull out the dipstick. There are maximum and minimum markings on the dipstick.

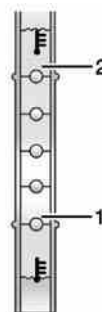

4. When the engine is cold, the coolant level should be at or above the minimum mark (1). After the vehicle has been driven and the engine is at normal operating temperature, the level should be somewhere between half full and the maximum mark (2).
5. If the coolant level is correct, replace the coolant recovery reservoir dipstick cap and turn clockwise to secure.

### How to Add Coolant to the Coolant Recovery Bottle

#### Warning

You can be burned if you spill coolant on hot engine parts. Coolant contains ethylene glycol and it will burn if the engine parts are hot enough. Do not spill coolant on a hot engine.

#### Caution

This vehicle has a specific coolant fill procedure. Failure to follow this procedure could cause the engine to overheat and be severely damaged.

To add coolant:

1. Turn the engine coolant recovery reservoir dipstick cap counterclockwise 1/8 of a turn and slowly pull out the dipstick.

2. Pour the coolant into the engine coolant recovery reservoir.
3. When the level is correct, as per the markings on the dipstick, replace the coolant recovery reservoir dipstick cap and turn clockwise to secure.

### How to Add Coolant to the Radiator

#### Warning

You can be burned if you spill coolant on hot engine parts. Coolant contains ethylene glycol and it will burn if the engine parts are hot enough. Do not spill coolant on a hot engine.

#### Caution

This vehicle has a specific coolant fill procedure. Failure to follow this procedure could cause the engine to overheat and be severely damaged.

#### Warning

An electric engine cooling fan under the hood can start up even when the engine is not running and can cause injury. Keep hands, clothing, and tools away from any underhood electric fan.

#### Warning

Steam and scalding liquids from a hot cooling system can blow out and burn you badly. They are

(Continued)



**Warning (Continued)**

under pressure, and if you turn the radiator cap — even a little — they can come out at high speed. Never turn the cap when the cooling system, including the radiator cap, is hot. Wait for the cooling system and radiator cap to cool if you ever have to turn the pressure cap.

If no coolant is visible in the engine coolant recovery reservoir, add coolant as follows:

1. Locate the radiator cap. See *Engine Compartment Overview* on page 10-5.



2. Cover the radiator cap with a thick cloth and turn it slowly counterclockwise and remove.
3. If there is no coolant visible or the level is low, slowly fill the system through the radiator cap opening with a 50/50 mixture of clean, drinkable water and DEX-COOL coolant until full.

Wait 30 seconds for the coolant to settle and top off if the level drops.

Do not spill coolant on the accessory drive belts.

If a spill occurs, rinse the belt with fresh water.

4. Start the engine.
5. With the engine idling, top off the coolant through the radiator cap opening until full.

Wait 30 seconds for the coolant to settle and top off if the level drops.

6. Once the system is full, put the radiator cap back on by turning clockwise.
7. Turn the engine off.

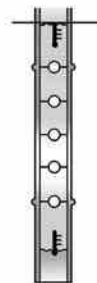

8. Check the coolant level in the engine coolant recovery reservoir and fill it until the level is at the top mark on the dipstick cap. Filling to this level provides additional coolant to allow for any air that may be left in the cooling system.

### Caution

If the pressure cap is not tightly installed, coolant loss and possible engine damage may occur. Be sure the cap is properly and tightly secured.

## Engine Overheating

The vehicle has an indicator to warn of engine overheating.

There is an engine coolant temperature gauge on your vehicle's instrument panel. See *Engine Coolant Temperature Gauge* on page 5-9.

You may decide not to lift the hood when this warning appears, but instead get service help right away. See *Roadside Assistance Program* on page 13-5.

If you do decide to lift the hood, make sure the vehicle is parked on a level surface.

Then check to see if the engine cooling fans are running. If the engine is overheating, both fans should be running. If they are not, do not continue to run the engine and have the vehicle serviced.

### Caution

Running the engine without coolant may cause damage or a fire. Vehicle damage would not be covered by the vehicle warranty.

## If Steam is Coming from the Engine Compartment

### Warning

Steam from an overheated engine can burn you badly, even if you just open the hood. Stay away from the engine if you see or hear steam coming from it. Just turn it off and get everyone away from the vehicle until it cools down.

(Continued)

### Warning (Continued)

Wait until there is no sign of steam or coolant before you open the hood.

If you keep driving when the engine is overheated, the liquids in it can catch fire. You or others could be badly burned. Stop the engine if it overheats, and get out of the vehicle until the engine is cool.

## If No Steam is Coming from the Engine Compartment

If an engine overheat warning is displayed but no steam can be seen or heard, the problem may not be too serious. Sometimes the engine can get a little too hot when the vehicle:

- Climbs a long hill on a hot day.
- Stops after high-speed driving.
- Idles for long periods in traffic.

If the overheat warning is displayed with no sign of steam:

1. Turn the air conditioning off.
2. Turn the heater on to the highest temperature and to the highest fan speed. Open the windows as necessary.
3. When it is safe to do so, pull off the road, shift to P (Park) or N (Neutral), and let the engine idle.

If the temperature overheat gauge is no longer in the overheat zone or an overheat warning no longer displays, the vehicle can be driven. Continue to drive the vehicle slowly for about 10 minutes. Keep a safe vehicle distance from the vehicle in front. If the warning does not come back on, continue to drive normally and have the cooling system checked for proper fill and function.

If the warning continues, pull over, stop, and park the vehicle right away.

If there is no sign of steam, idle the engine for three minutes while parked. If the warning is still displayed, turn off the engine until it cools down.

## Washer Fluid

### What to Use

When windshield washer fluid is needed, be sure to read the manufacturer's instructions before use. If operating the vehicle in an area where the temperature may fall below freezing, use a fluid that has sufficient protection against freezing.

### Adding Washer Fluid



Open the cap with the washer symbol on it. Add washer fluid until the windshield washer fluid reservoir is full. See *Engine Compartment Overview on page 10-5* for reservoir location.

### Caution

- Do not use engine coolant (antifreeze) in the windshield washer. It can damage the windshield washer system and paint.
- Do not mix water with ready-to-use washer fluid. Water can cause the solution to freeze and damage the washer fluid tank and other parts of the washer system.
- When using concentrated washer fluid, follow the manufacturer instructions for adding water.

(Continued)

### Caution (Continued)

- Fill the washer fluid tank only three-quarters full when it is very cold. This allows for fluid expansion if freezing occurs, which could damage the tank if it is completely full.

## Brakes

This vehicle has disc brakes. Disc brake pads have built-in wear indicators that make a high-pitched warning sound when the brake pads are worn and new pads are needed. The sound can come and go or be heard all the time when the vehicle is moving, except when applying the brake pedal firmly.

### Warning

The brake wear warning sound means that soon the brakes will not work well. That could lead to  
(Continued)

### Warning (Continued)

a crash. When the brake wear warning sound is heard, have the vehicle serviced.

### Caution

Continuing to drive with worn-out brake pads could result in costly brake repair.

Some driving conditions or climates can cause a brake squeal when the brakes are first applied or lightly applied. This does not mean something is wrong with the brakes.

Properly torqued wheel nuts are necessary to help prevent brake pulsation. When tires are rotated, inspect brake pads for wear and evenly tighten wheel nuts in the proper sequence to torque specifications. See *Capacities and Specifications on page 12-2*.

Brake pads should be replaced as complete sets.

### Brake Pedal Travel

See your dealer if the brake pedal does not return to normal height, or if there is a rapid increase in pedal travel. This could be a sign that brake service might be required.

### Brake Adjustment

Every time the brakes are applied, with or without the vehicle moving, the brakes adjust for wear.

### Replacing Brake System Parts

The braking system on a vehicle is complex. Its many parts have to be of top quality and work well together if the vehicle is to have really good braking. The vehicle was designed and tested with top-quality brake parts. When parts of the braking system are replaced, be sure to get new, approved replacement parts. If this is not done, the brakes might not work properly. For example,

installing disc brake pads that are wrong for the vehicle, can change the balance between the front and rear brakes — for the worse. The braking performance expected can change in many other ways if the wrong replacement brake parts are installed.

## Brake Fluid



The brake master cylinder reservoir is filled with DOT 4 brake fluid.

There are only two reasons why the brake fluid level in the reservoir might go down:

- The brake fluid level goes down because of normal brake lining wear. When new linings are installed, the fluid level goes back up.

- A fluid leak in the brake hydraulic system can also cause a low fluid level. Have the brake hydraulic system fixed, since a leak means that sooner or later the brakes will not work well.

Do not top off the brake fluid. Adding fluid does not correct a leak. If fluid is added when the linings are worn, there will be too much fluid when new brake linings are installed. Add or remove brake fluid, as necessary, only when work is done on the brake hydraulic system.

### Warning

If too much brake fluid is added, it can spill on the engine and burn, if the engine is hot enough. You or others could be burned, and the vehicle could be damaged. Add brake fluid only when work is done on the brake hydraulic system.

When the brake fluid falls to a low level, the brake warning light comes on. See *Brake System Warning Light* on page 5-14.

### What to Add

Use only new DOT 4 brake fluid from a sealed container. It is recommended that the brake hydraulic system be flushed and refilled with new DOT 4 fluid at a regular maintenance service every two years. See *Maintenance Schedule* on page 11-2 and *Recommended Fluids and Lubricants* on page 11-12.

Always clean the brake fluid reservoir cap and the area around the cap before removing it. This helps keep dirt from entering the reservoir.

 **Warning**

With the wrong kind of fluid in the brake hydraulic system, the brakes might not work well. This could cause a crash. Always use the proper brake fluid.

 **Caution**

- Using the wrong fluid can badly damage brake hydraulic system parts. For example, just a few drops of mineral-based oil, such as engine oil, in the brake hydraulic system can damage brake hydraulic system parts so badly that they will have to be replaced. Do not let someone put in the wrong kind of fluid.

(Continued)

**Caution (Continued)**

- If brake fluid is spilled on the vehicle's painted surfaces, the paint finish can be damaged. Be careful not to spill brake fluid on the vehicle. If you do, wash it off immediately.

**Battery**

The battery is in the trunk, behind a trim panel, on the driver side of the vehicle. Refer to the replacement number shown on the original battery label when a new battery is needed.

 **Warning**

A specifically developed battery with a ventilation system is required for this vehicle. Any

(Continued)

**Warning (Continued)**

other standard battery may cause explosive gases to enter the trunk or passenger compartment.

Do not remove the caps on the top of the battery. The battery supplied in the vehicle is maintenance free and does not require checking or filling.

The battery vent tube must be installed correctly to ensure the explosive gases are vented outside the vehicle.

Only use a manufacturer recommended battery as a replacement.

 **Warning**

Battery posts, terminals, and related accessories contain lead and lead compounds, chemicals

(Continued)

**Warning (Continued)**

known to the State of California to cause cancer and reproductive harm. Wash hands after handling.

**Vehicle Storage****Warning**

Batteries have acid that can burn you and gas that can explode. You can be badly hurt if you are not careful. See *Jump Starting* on page 10-69 for tips on working around a battery without getting hurt.

**Infrequent Usage:** Remove the black, negative (-) cable from the battery to keep the battery from running down.

**Extended Storage:** Remove the black, negative (-) cable from the battery or use a battery trickle charger.

**Rear Axle****When to Check Lubricant**

It is not necessary to regularly check rear axle fluid unless you suspect there is a leak or you hear an unusual noise. A fluid loss could indicate a problem. Have it inspected and repaired.

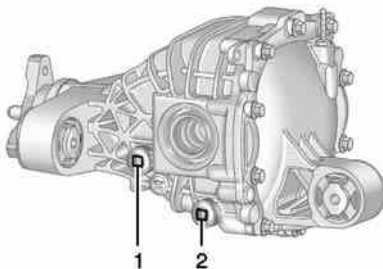
**How to Check Lubricant**

1. Fill Plug Hole
2. Drain Plug Hole

To get an accurate reading, the vehicle should be on a level surface.

If the level is below the bottom of the filler plug hole, add some lubricant. Add enough lubricant to raise the level to the bottom of the filler plug hole.

**What to Use**

To add lubricant when the level is low or to completely refill after draining, see *Recommended Fluids and Lubricants* on page 11-12. Then fill to the bottom of the fill plug hole with the required lubricant.

**Starter Switch Check****Warning**

When you are doing this inspection, the vehicle could move suddenly. If the vehicle moves, you or others could be injured.

1. Before starting this check, be sure there is enough room around the vehicle.
2. Apply both the parking brake and the regular brake.  
Do not use the accelerator pedal, and be ready to turn off the engine immediately if it starts.
3. Try to start the engine in each gear. The vehicle should start only in P (Park) or N (Neutral). If the vehicle starts in any other position, contact your dealer for service.

### Automatic Transmission Shift Lock Control Function Check

 **Warning**

When you are doing this inspection, the vehicle could move suddenly. If the vehicle moves, you or others could be injured.

1. Before starting this check, be sure there is enough room around the vehicle. It should be parked on a level surface.
2. Apply the parking brake. Be ready to apply the regular brake immediately if the vehicle begins to move.
3. With the engine off, turn the ignition on, but do not start the engine. Without applying the regular brake, try to move the shift lever out of P (Park) with

normal effort. If the shift lever moves out of P (Park), contact your dealer for service.

### Ignition Transmission Lock Check

If equipped with a key type ignition, while parked and with the parking brake set, try to turn the ignition to LOCK/OFF in each shift lever position.

- The ignition should turn to LOCK/OFF only when the shift lever is in P (Park).
- The ignition key should come out only in LOCK/OFF.

Contact your dealer if service is required.



## Park Brake and P (Park) Mechanism Check

### Warning

When you are doing this check, the vehicle could begin to move. You or others could be injured and property could be damaged. Make sure there is room in front of the vehicle in case it begins to roll. Be ready to apply the regular brake at once should the vehicle begin to move.

Park on a fairly steep hill, with the vehicle facing downhill. Keeping your foot on the regular brake, set the parking brake.

- To check the parking brake's holding ability: With the engine running and the transmission in N (Neutral), slowly remove foot pressure from the regular brake pedal. Do this until the vehicle is held by the parking brake only.

- To check the P (Park) mechanism's holding ability: With the engine running, shift to P (Park). Then release the parking brake followed by the regular brake.

Contact your dealer if service is required.

## Wiper Blade Replacement

### Front Wiper Blade

Windshield wiper blades should be inspected for wear or cracking. See *Maintenance Schedule on page 11-2*.

Replacement blades come in different types and are removed in different ways. For the proper type and size, see *Maintenance Replacement Parts on page 11-13*.

To replace the wiper blade assembly:

- Pull the windshield wiper assembly away from the windshield.

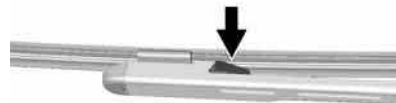

- Squeeze the tabs on each side of the wiper blade assembly and slide the assembly off the end of the wiper arm.



- Install the new blade onto the arm connector and make sure the tabs are fully set in the locked position.

Allowing the wiper blade arm to touch the windshield when no wiper blade is installed could damage the windshield. Any damage that occurs would not

be covered by your warranty. Do not allow the wiper blade arm to touch the windshield.

4. Repeat the steps for the other blade.

### Windshield Replacement

The windshield is part of the HUD system. If the vehicle has to have the windshield replaced, get one that is designed for HUD or the HUD image may look out of focus.

### Headlamp Aiming

Headlamp aim has been preset and should need no further adjustment.

If the vehicle is damaged in a crash, the headlamp aim may be affected. If adjustment to the headlamps is necessary, see your dealer.

### Bulb Replacement

For the proper type of replacement bulbs, see *Replacement Bulbs on page 10-25*.

For any bulb changing procedure not listed in this section, contact your dealer.

### High Intensity Discharge (HID) Lighting

 **Warning**

The high intensity discharge lighting system operates at a very high voltage. If you try to service any of the system components, you could be seriously injured. Have your dealer or a qualified technician service them.

After an HID headlamp bulb has been replaced, the beam might be a slightly different shade than it was originally. This is normal.

## License Plate Lamp

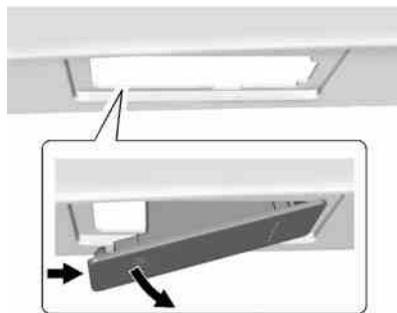

Lamp Assembly

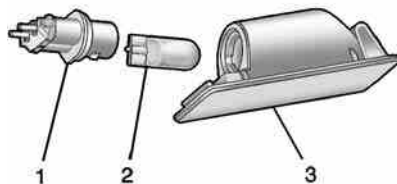

Bulb Assembly

1. Bulb Socket
2. Bulb
3. Lamp Assembly

To replace one of these bulbs:

1. Push the left end of the lamp assembly toward the right.
2. Turn the lamp assembly down to remove it.
3. Turn the bulb socket (1) counterclockwise to remove it from the lamp assembly (3).
4. Pull the bulb (2) straight out of the bulb socket (1).
5. Push the replacement bulb straight into the bulb socket and turn the bulb socket clockwise to install it into the lamp assembly.
6. Turn the lamp assembly into the lamp assembly opening engaging the clip side first.
7. Push on the lamp side opposite the clip until the lamp assembly snaps into place.

## Replacement Bulbs

Exterior Lamp	Bulb Number
License Plate Lamp	W5W

For replacement bulbs not listed here, contact your dealer.

## Electrical System

### Electrical System Overload

The vehicle has fuses and circuit breakers to protect against an electrical system overload.

When the current electrical load is too heavy, the circuit breaker opens and closes, protecting the circuit until the current load returns to normal or the problem is fixed. This greatly reduces the chance of circuit overload and fire caused by electrical problems.

Fuses and circuit breakers protect power devices in the vehicle.

Replace a bad fuse with a new one of the identical size and rating.

If there is a problem on the road and a fuse needs to be replaced, the same amperage fuse can be borrowed. Choose some feature of the vehicle that is not needed to use and replace it as soon as possible.

### Headlamp Wiring

An electrical overload may cause the lamps to go on and off, or in some cases to remain off. Have the headlamp wiring checked right away if the lamps go on and off or remain off.

### Windshield Wipers

If the wiper motor overheats due to heavy snow or ice, the windshield wipers will stop until the motor cools and will then restart.

Although the circuit is protected from electrical overload, overload due to heavy snow or ice may cause wiper linkage damage. Always clear ice and heavy snow from the windshield before using the windshield wipers.

If the overload is caused by an electrical problem and not snow or ice, be sure to get it fixed.

### Fuses

The wiring circuits in the vehicle are protected from short circuits by fuses. This greatly reduces the chance of fires caused by electrical problems.

Look at the silver-colored band inside the fuse. If the band is broken or melted, replace the fuse. Be sure you replace a bad fuse with a new one of the identical size and rating.

Fuses of the same amperage can be temporarily borrowed from another fuse location, if a fuse goes out. Replace the fuse as soon as you can.

Spare fuses of various ratings are provided in the Engine Compartment Fuse Block and Rear Compartment Fuse Block.

# Engine Compartment Fuse Block



To access the fuse block, remove the clip-on cover.  
Ensure the cover is replaced securely.

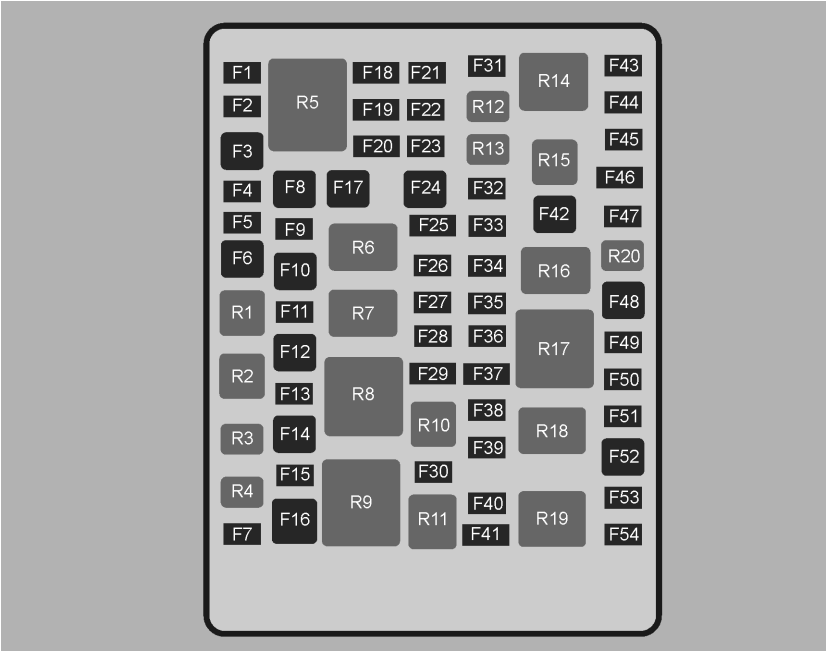

## 10-28 Vehicle Care

The vehicle may not be equipped with all of the fuses, relays and features shown.

Fuses	Usage
F1	Heated Mirrors
F2	Not Used
F3	Rear Defogger
F4	Not Used
F5	Spot Lamp Right
F6	Driver Power Seat
F7	Washer Pump
F8	Passenger Power Seat
F9	EMER/ VEH/FT/LP
F10	Not Used
F11	Driving Lamps
F12	Headlamp Washer
F13	Spot Lamp Left
F14	ABS Pump
F15	ABS Valves

Fuses	Usage
F16	Not Used
F17	Not Used
F18	Heated Front Seats
F19	Not Used
F20	Not Used
F21	Front Passenger Window Switch
F22	Rear Wiper
F23	Sunroof
F24	Front Wipers
F25	Automatic Occupant Sensing/Instrument Cluster Ignition
F26	LRBEC Ignition
F27	Not Used
F28	Ignition/Injectors Even-V8
F29	Engine Control Module-V8, Ignition Odd-V6/EMIS

Fuses	Usage
F30	Not Used
F31	Not Used
F32	Fog Lamps
F33	Ignition-IP/BODY
F34	Fuel System Control Module
F35	Not Used
F36	ESCL
F37	EMIS 2/Ignition Even-V6
F38	Engine Control Module-V6, Injectors/ Ignition Odd-V8
F39	INCLR Pump
F40	Not Used
F41	Transmission Control Module/Electric Power Steering
F42	Starter Motor
F43	Not Used

Fuses	Usage
F44	Left HID Headlamp
F45	Right HID Headlamp
F46	Left & Right High-Beam Headlamp
F47	Horn
F48	Engine Cooling Fan
F49	Automatic Headlamp Leveling
F50	Transmission Control Module Ignition
F51	Engine Control Module Ignition
F52	Brake Vacuum Pump
F53	Air Conditioning Compressor Clutch
F54	Vaporizer Control Module

**Relays**

Relays	Usage
R1	Driving Lamps

Relays	Usage
R2	Headlamp Washer
R3	Rear Washer Pump
R4	Front Washer Pump
R5	Rear Defogger
R6	Front Wiper Control
R7	Wiper Speed
R8	Engine Control Module
R9	Not Used
R10	INCLR Pump
R11	Not Used
R12	Rear Wiper Control
R13	Fog Lamps
R14	Low-Beam Headlamps
R15	High-Beam Headlamps
R16	Starter
R17	Run/Crank

Relays	Usage
R18	Brake Vacuum Pump
R19	Air Conditioning Control
R20	Horn

Relays R3, R4, R12, R13, and R20 are PCB mounted relays.

**Instrument Panel Fuse Block**

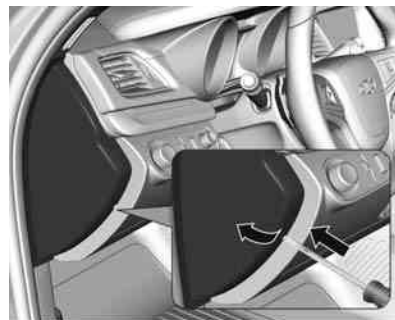

## 10-30 Vehicle Care

### Removing the Fuse Panel Cover

Insert a screwdriver in the slot indicated and remove the fuse panel cover.

### Refitting the Fuse Panel Cover

1. Insert the rear edge of the fuse panel cover under the door seal.
2. Locate the hooks on the cover into the end of the instrument panel.
3. Rotate and push the cover back into position.

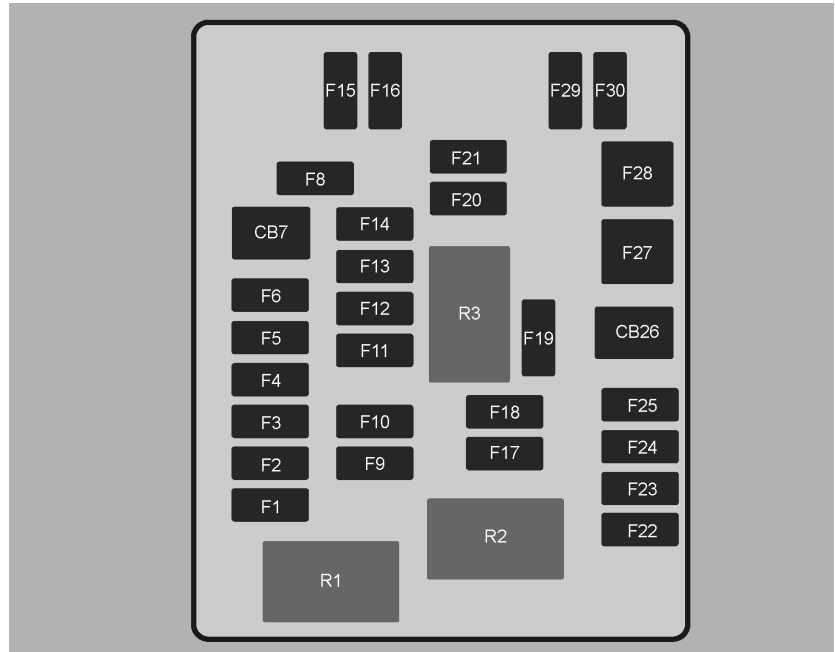



The vehicle may not be equipped with all of the fuses, relays and features shown.

**Fuses**

Fuses	Usage
F1	Body Control Module 1
F2	Diagnostic Link Connector
F3	LPG Shut-Off Solenoid
F4	Body Control Module 2
F5	Ignition Switch
F6	Electric Steering Control Lock
CB7	Not Used
F8	Not Used
F9	Not Used
F10	Not Used
F11	Shunt 1

Fuses	Usage
F12	Airbag/Automatic Occupant Sensing
F13	Instrument Cluster
F14	HVAC Control Module
F15	Rain Sensor
F16	Body Control Module 3
F17	LPG Shut-Off Solenoid
F18	Not Used
F19	SWC Backlight
F20	Not Used
F21	Not Used
F22	Shunt 2
F23	Body Control Module 4
F24	Body Control Module 5
F25	Body Control Module 6

Fuses	Usage
CB26	Not Used
F27	Body Control Module 8
F28	Blower Fan
F29	Accessories
F30	Body Control Module 7

**Relays**

Relays	Usage
R1	Logistics
R2	LPG Shut-Off Solenoid
R3	LPG Shut-Off Solenoid

### Rear Compartment Fuse Block

The fuse panel is on the left side of the trunk, above the battery.

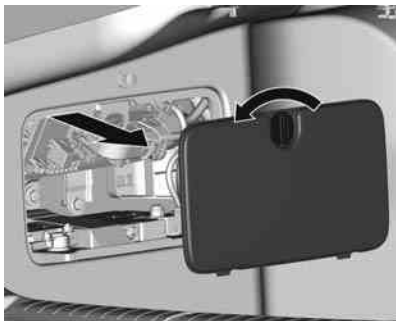

- Turn the catch counterclockwise to unlatch the cover.
- To refit, replace the cover and turn the catch clockwise to secure.

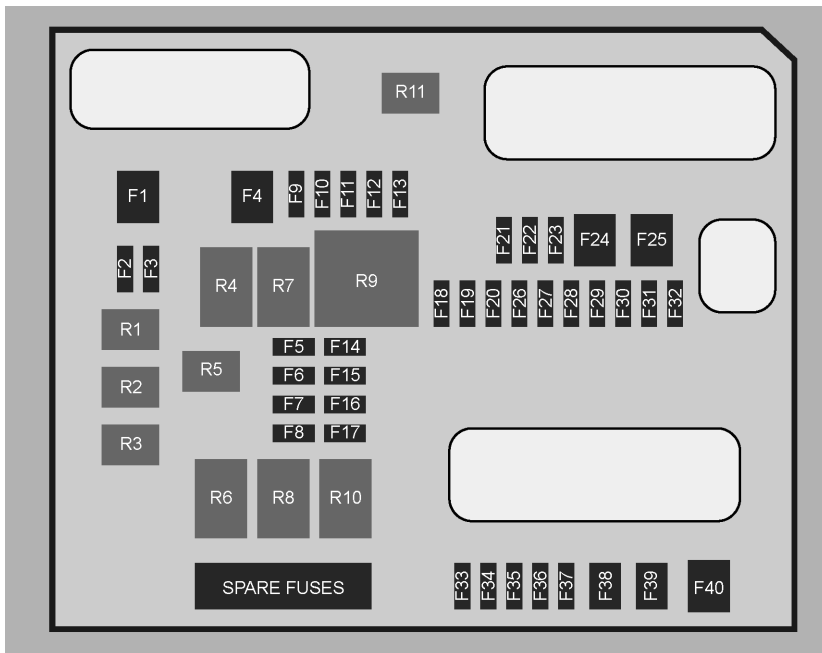

The vehicle may not be equipped with all of the fuses, relays and features shown.

**Fuses**

Fuses	Usage
F1	Driver Front/Left Rear Window
F2	EMER/VEH/ACCY
F3	Trunk Release
F4	Passive Entry Passive Start-BATT 2
F5	Radio
F6	Not Used
F7	Not Used
F8	Fuel System Control Module
F9	MRTD
F10	Decklid Flashing Lamps/EDI Module
F11	Auxiliary Battery
F12	Not Used

Fuses	Usage
F13	Not Used
F14	Rear Seat Entertainment
F15	Automatic Headlamp Leveling
F16	Not Used
F17	Not Used
F18	OnStar
F19	Mirror/Window Module
F20	Canister Vent Solenoid
F21	Passive Entry Passive Start-BATT 1
F22	Memory Seat Module
F23	Amplifier
F24	Passenger Front/ Right Rear Window
F25	Electric Parking Brake
F26	Tailgate Module

Fuses	Usage
F27	Camera Ignition
F28	Front Vent Seat Ignition
F29	Trailer Module Ignition
F30	Advanced Park Assist/Side Blind Zone Alert
F31	Engine Control Module
F32	Auxiliary Gauges
F33	Retained Accessory Power
F34	Battery Voltage Sensing
F35	Tailgate Motor
F36	Rear Accessory Power Outlet
F37	Interior Accessory Power Outlet
F38	Cigar Lighter
F39	Not Used

Fuses	Usage
F40	Trailer Module

### Relays

Relays	Usage
R1	Trunk Release
R2	Accessory
R3	Not Used
R4	Run
R5	Not Used
R6	Retained Accessory Power
R7	Logistics Mode
R8	Not Used
R9	Not Used
R10	Not Used
R11	Child Locks

Relays R1, R2, R3, and R5 are PCB mounted relays.

## Wheels and Tires

### Tires

Every new GM vehicle has high-quality tires made by a leading tire manufacturer. See the warranty manual for information regarding the tire warranty and where to get service. For additional information refer to the tire manufacturer.

#### Warning

- Poorly maintained and improperly used tires are dangerous.
- Overloading the tires can cause overheating as a result of too much flexing. There could be a blowout

(Continued)

#### Warning (Continued)

and a serious crash. See *Vehicle Load Limits on page 9-10*.

- Underinflated tires pose the same danger as overloaded tires. The resulting crash could cause serious injury. Check all tires frequently to maintain the recommended pressure. Tire pressure should be checked when the tires are cold.
- Overinflated tires are more likely to be cut, punctured, or broken by a sudden impact — such as when hitting a pothole. Keep tires at the recommended pressure.

(Continued)

**Warning (Continued)**

- Worn or old tires can cause a crash. If the tread is badly worn, replace them.
- Replace any tires that have been damaged by impacts with potholes, curbs, etc.
- Improperly repaired tires can cause a crash. Only the dealer or an authorized tire service center should repair, replace, dismount, and mount the tires.
- Do not spin the tires in excess of 56 km/h (35 mph) on slippery surfaces such as snow, mud, ice, etc. Excessive spinning may cause the tires to explode.

**Winter Tires**

This vehicle was not originally equipped with winter tires. Winter tires are designed for increased traction on snow and ice-covered roads. Consider installing winter tires on the vehicle if frequent driving on ice or snow covered roads is expected. See your dealer for details regarding winter tire availability and proper tire selection. Also, see *Buying New Tires on page 10-49*.

With winter tires, there may be decreased dry road traction, increased road noise, and shorter tread life. After changing to winter tires, be alert for changes in vehicle handling and braking.

If using winter tires:

- Use tires of the same brand and tread type on all four wheel positions.

- Use only radial ply tires of the same size, load range, and speed rating as the original equipment tires.

Winter tires with the same speed rating as the original equipment tires may not be available for H, V, W, Y, and ZR speed rated tires. If winter tires with a lower speed rating are chosen, never exceed the tire's maximum speed capability.

**Low-Profile Tires****Caution**

Low-profile tires are more susceptible to damage from road hazards or curb impact than standard profile tires. Tire and/or wheel assembly damage can occur when coming into contact with road hazards like potholes, or sharp edged objects, or when sliding into a curb. The warranty does not cover this type of

(Continued)

### Caution (Continued)

damage. Keep tires set to the correct inflation pressure and when possible, avoid contact with curbs, potholes, and other road hazards.

## Summer Tires

### Ultra High Performance Summer Tires

This vehicle may come with 245/40R19 and 275/35R19 ultra high performance summer tires. These tires have a special tread and compound that are optimized for maximum dry and wet road performance. This special tread and compound will have decreased performance in cold climates, and on ice and snow. Driving a vehicle with ultra high performance summer tires when temperatures are below approximately 5°C (40°F) is not recommended. If driving in these

conditions, winter tires should be installed. See *Winter Tires* on page 10-35.

### ⚠ Caution

Ultra high performance summer tires have rubber compounds that lose flexibility and may develop surface cracks in the tread area at temperatures below -7°C (20°F). Always store ultra high performance summer tires indoors and at temperatures above -7°C (20°F) when not in use. If the tires have been subjected to -7°C (20°F) or less, let them warm up in a heated space to at least 5°C (40°F) for 24 hours or more before being installed or driving a vehicle on which they are installed. Do not apply heat or blow heated air directly on the tires. Always inspect tires before use. See *Tire Inspection* on page 10-46.

## Tire Sidewall Labeling

Useful information about a tire is molded into its sidewall. The examples show a typical passenger tire sidewall.

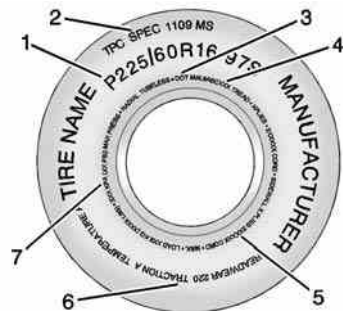

### Passenger (P-Metric) Tire Example

**(1) Tire Size:** The tire size is a combination of letters and numbers used to define a particular tire's width, height, aspect ratio, construction type, and service description. See the "Tire Size" illustration later in this section for more detail.

## (2) TPC Spec (Tire Performance Criteria Specification):

Original equipment tires designed to GM's specific tire performance criteria have a TPC specification code molded onto the sidewall. GM's TPC specifications meet or exceed all federal safety guidelines.

## (3) DOT (Department of Transportation):

The Department of Transportation (DOT) code indicates that the tire is in compliance with the U.S. Department of Transportation Motor Vehicle Safety Standards.

## DOT Tire Date of

**Manufacture:** The last four digits of the TIN indicate the tire manufactured date. The first two digits represent the week (01-52) and the last two digits, the year. For example, the third

week of the year 2010 would have a four-digit DOT date of 0310.

## (4) Tire Identification Number (TIN):

The letters and numbers following the DOT code are the Tire Identification Number (TIN). The TIN shows the manufacturer and plant code, tire size, and date the tire was manufactured. The TIN is molded onto both sides of the tire, although only one side may have the date of manufacture.

**(5) Tire Ply Material:** The type of cord and number of plies in the sidewall and under the tread.

## (6) Uniform Tire Quality Grading (UTQG):

Tire manufacturers are required to grade tires based on three performance factors: treadwear, traction, and temperature

resistance. For more information see *Uniform Tire Quality Grading on page 10-51*.

**(7) Maximum Cold Inflation Load Limit:** Maximum load that can be carried and the maximum pressure needed to support that load.

## Tire Designations

### Tire Size

The following is an example of a typical passenger vehicle tire size.

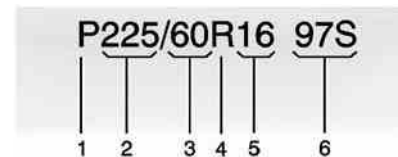

### (1) Passenger (P-Metric) Tire:

The United States version of a metric tire sizing system. The letter P as the first character in

the tire size means a passenger vehicle tire engineered to standards set by the U.S. Tire and Rim Association.

**(2) Tire Width:** The three-digit number indicates the tire section width in millimeters from sidewall to sidewall.

**(3) Aspect Ratio:** A two-digit number that indicates the tire height-to-width measurements. For example, if the tire size aspect ratio is 60, as shown in item 3 of the illustration, it would mean that the tire's sidewall is 60 percent as high as it is wide.

**(4) Construction Code:** A letter code is used to indicate the type of ply construction in the tire. The letter R means radial ply construction; the letter D means diagonal or bias ply construction; and the letter B means belted-bias ply construction.

**(5) Rim Diameter:** Diameter of the wheel in inches.

**(6) Service Description:** These characters represent the load index and speed rating of the tire. The load index represents the load carrying capacity a tire is certified to carry. The speed rating is the maximum speed a tire is certified to carry a load.

### Tire Terminology and Definitions

**Air Pressure:** The amount of air inside the tire pressing outward on each square inch of the tire. Air pressure is expressed in kPa (kilopascal) or psi (pounds per square inch).

**Accessory Weight:** The combined weight of optional accessories. Some examples of optional accessories are

automatic transmission, power windows, power seats, and air conditioning.

**Aspect Ratio:** The relationship of a tire's height to its width.

**Belt:** A rubber coated layer of cords between the plies and the tread. Cords may be made from steel or other reinforcing materials.

**Bead:** The tire bead contains steel wires wrapped by steel cords that hold the tire onto the rim.

**Bias Ply Tire:** A pneumatic tire in which the plies are laid at alternate angles less than 90 degrees to the centerline of the tread.

**Cold Tire Pressure:** The amount of air pressure in a tire, measured in kPa (kilopascal) or psi (pounds per square inch)



before a tire has built up heat from driving. See *Tire Pressure on page 10-41*.

**Curb Weight:** The weight of a motor vehicle with standard and optional equipment including the maximum capacity of fuel, oil, and coolant, but without passengers and cargo.

**DOT Markings:** A code molded into the sidewall of a tire signifying that the tire is in compliance with the U.S. Department of Transportation (DOT) Motor Vehicle Safety Standards. The DOT code includes the Tire Identification Number (TIN), an alphanumeric designator which can also identify the tire manufacturer, production plant, brand, and date of production.

**GVWR:** Gross Vehicle Weight Rating. See *Vehicle Load Limits on page 9-10*.

**GAWR FRT:** Gross Axle Weight Rating for the front axle. See *Vehicle Load Limits on page 9-10*.

**GAWR RR:** Gross Axle Weight Rating for the rear axle. See *Vehicle Load Limits on page 9-10*.

**Intended Outboard Sidewall:** The side of an asymmetrical tire that must always face outward when mounted on a vehicle.

**Kilopascal (kPa):** The metric unit for air pressure.

**Light Truck (LT-Metric) Tire:** A tire used on light duty trucks and some multipurpose passenger vehicles.

**Load Index:** An assigned number ranging from 1 to 279 that corresponds to the load carrying capacity of a tire.

**Maximum Inflation Pressure:** The maximum air pressure to which a cold tire can be inflated. The maximum air pressure is molded onto the sidewall.

**Maximum Load Rating:** The load rating for a tire at the maximum permissible inflation pressure for that tire.

**Maximum Loaded Vehicle Weight:** The sum of curb weight, accessory weight, vehicle capacity weight, and production options weight.

**Normal Occupant Weight:** The number of occupants a vehicle is designed to seat multiplied by 68 kg (150 lb). See *Vehicle Load Limits on page 9-10*.

**Occupant Distribution:** Designated seating positions.

**Outward Facing Sidewall:** The side of an asymmetrical tire that has a particular side that faces

outward when mounted on a vehicle. The side of the tire that contains a whitewall, bears white lettering, or bears manufacturer, brand, and/or model name molding that is higher or deeper than the same moldings on the other sidewall of the tire.

**Passenger (P-Metric) Tire:** A tire used on passenger cars and some light duty trucks and multipurpose vehicles.

**Recommended Inflation Pressure:** Vehicle manufacturer's recommended tire inflation pressure as shown on the tire placard. See *Tire Pressure on page 10-41* and *Vehicle Load Limits on page 9-10*.

**Radial Ply Tire:** A pneumatic tire in which the ply cords that extend to the beads are laid at 90 degrees to the centerline of the tread.

**Rim:** A metal support for a tire and upon which the tire beads are seated.

**Sidewall:** The portion of a tire between the tread and the bead.

**Speed Rating:** An alphanumeric code assigned to a tire indicating the maximum speed at which a tire can operate.

**Traction:** The friction between the tire and the road surface. The amount of grip provided.

**Tread:** The portion of a tire that comes into contact with the road.

**Treadwear Indicators:** Narrow bands, sometimes called wear bars, that show across the tread

of a tire when only 1.6 mm (1/16 in) of tread remains. See *When It Is Time for New Tires on page 10-48*.

**UTQGS (Uniform Tire Quality Grading Standards):** A tire information system that provides consumers with ratings for a tire's traction, temperature, and treadwear. Ratings are determined by tire manufacturers using government testing procedures. The ratings are molded into the sidewall of the tire. See *Uniform Tire Quality Grading on page 10-51*.

**Vehicle Capacity Weight:** The number of designated seating positions multiplied by 68 kg (150 lb) plus the rated cargo load. See *Vehicle Load Limits on page 9-10*.

**Vehicle Maximum Load on the**

**Tire:** Load on an individual tire due to curb weight, accessory weight, occupant weight, and cargo weight.

**Vehicle Placard:** A label permanently attached to a vehicle showing the vehicle capacity weight and the original equipment tire size and recommended inflation pressure. See “Tire and Loading Information Label” under *Vehicle Load Limits on page 9-10*.

**Tire Pressure**

Tires need the correct amount of air pressure to operate effectively.

 **Caution**

Neither tire underinflation nor overinflation is good. Underinflated tires, or tires that do not have enough air, can result in:

- Tire overloading and overheating which could lead to a blowout.
- Premature or irregular wear.
- Poor handling.
- Reduced fuel economy.

Overinflated tires, or tires that have too much air, can result in:

- Unusual wear.
- Poor handling.
- Rough ride.
- Needless damage from road hazards.

The Tire and Loading Information label on the vehicle indicates the original equipment tires and the correct cold tire inflation pressures. The recommended pressure is the minimum air pressure needed to support the vehicle's maximum load carrying capacity.

For additional information regarding how much weight the vehicle can carry, and an example of the Tire and Loading Information label, see *Vehicle Load Limits on page 9-10*. How the vehicle is loaded affects vehicle handling and ride comfort. Never load the vehicle with more weight than it was designed to carry.

**When to Check**

Check the tires once a month or more.

### How to Check

Use a good quality pocket-type gauge to check the tire pressure. Proper tire inflation cannot be determined by looking at the tire. Check the tire inflation pressure when the tires are cold, meaning the vehicle has not been driven for at least three hours or no more than 1.6 km (1 mi).

Remove the valve cap from the tire valve stem. Press the tire gauge firmly onto the valve to get the pressure measurement. If the cold tire inflation pressure matches the recommended pressure on the Tire and Loading Information label, no further adjustment is necessary.

If the inflation pressure is low, add air until the recommended pressure is reached. If the inflation pressure is high, press on the metal stem in the center

of the tire valve to release air. Re-check the tire pressure with the tire gauge.

Return the valve caps on the valve stems to keep out dirt and moisture and prevent leaks.

### Tire Pressure Monitor System

The Tire Pressure Monitor System (TPMS) uses radio and sensor technology to check tire pressure levels. The TPMS sensors monitor the air pressure in your tires and transmit tire pressure readings to a receiver located in the vehicle.

Each tire, including the spare (if provided), should be checked monthly when cold and inflated to the inflation pressure recommended by the vehicle manufacturer on the vehicle placard or tire inflation pressure label. (If your vehicle has tires of a different size than the size indicated on the vehicle placard or

tire inflation pressure label, you should determine the proper tire inflation pressure for those tires.)

As an added safety feature, your vehicle has been equipped with a tire pressure monitoring system (TPMS) that illuminates a low tire pressure telltale when one or more of your tires is significantly under-inflated.

Accordingly, when the low tire pressure telltale illuminates, you should stop and check your tires as soon as possible, and inflate them to the proper pressure. Driving on a significantly under-inflated tire causes the tire to overheat and can lead to tire failure. Under-inflation also reduces fuel efficiency and tire tread life, and may affect the vehicle's handling and stopping ability.

Please note that the TPMS is not a substitute for proper tire maintenance, and it is the driver's responsibility to maintain correct tire pressure, even if under-inflation has

not reached the level to trigger illumination of the TPMS low tire pressure telltale.

Your vehicle has also been equipped with a TPMS malfunction indicator to indicate when the system is not operating properly. The TPMS malfunction indicator is combined with the low tire pressure telltale. When the system detects a malfunction, the telltale will flash for approximately one minute and then remain continuously illuminated. This sequence will continue upon subsequent vehicle start-ups as long as the malfunction exists.

When the malfunction indicator is illuminated, the system may not be able to detect or signal low tire pressure as intended. TPMS malfunctions may occur for a variety of reasons, including the installation of replacement or alternate tires or wheels on the vehicle that prevent the TPMS from functioning properly. Always check the TPMS malfunction telltale after replacing one or more tires or wheels on your vehicle to

ensure that the replacement or alternate tires and wheels allow the TPMS to continue to function properly.

See *Tire Pressure Monitor Operation* on page 10-43.

See *Radio Frequency Statement* on page 13-15.

## Tire Pressure Monitor Operation

This vehicle may have a Tire Pressure Monitor System (TPMS). The TPMS is designed to warn the driver when a low tire pressure condition exists. TPMS sensors are mounted onto each tire and wheel assembly, including the spare tire and wheel assembly. The TPMS sensors monitor the air pressure in the tires and transmit the tire pressure readings to a receiver located in the vehicle.

The full-size spare includes a sensor for the Tire Pressure Monitor System (TPMS). The TPMS will not

monitor or display the spare tire air pressure until the tire/wheel is installed at one of the four tire/wheel positions on the vehicle and matched to the new position.



When a low tire pressure condition is detected, the TPMS illuminates the low tire pressure warning light located on the instrument cluster. If the warning light comes on, stop as soon as possible and inflate the tires to the recommended pressure shown on the Tire and Loading Information label. See *Vehicle Load Limits* on page 9-10.

A message to check the pressure in a specific tire may display in the Driver Information Center (DIC). The low tire pressure warning light and the DIC warning message, if equipped, come on at each

ignition cycle until the tires are inflated to the correct inflation pressure. Using the DIC, it may be possible to view the tire pressure levels. For additional information and details about the DIC operation and displays, see *Driver Information Center (DIC) on page 5-21*.

The low tire pressure warning light may come on in cool weather when the vehicle is first started, and then turn off as the vehicle is driven. This could be an early indicator that the air pressure is getting low and needs to be inflated to the proper pressure.

A Tire and Loading Information label shows the size of the original equipment tires and the correct inflation pressure for the tires when they are cold. See *Vehicle Load Limits on page 9-10*, for an example of the Tire and Loading Information label and its location. Also see *Tire Pressure on page 10-41*.

The TPMS can warn about a low tire pressure condition, but it does not replace normal tire maintenance. See *Tire Inspection on page 10-46*, *Tire Rotation on page 10-47*, and *Tires on page 10-34*.

### **Caution**

Tire sealant materials are not all the same. A non-approved tire sealant could damage the TPMS sensors. TPMS sensor damage caused by using an incorrect tire sealant is not covered by the vehicle warranty. Always use only the GM approved tire sealant available through your dealer or included in the vehicle.

Factory-installed Tire Inflator Kits use a GM approved liquid tire sealant. Using non-approved tire sealants could damage the TPMS sensors. See *Tire Sealant and*

*Compressor Kit on page 10-56* for information regarding the inflator kit materials and instructions.

### **TPMS Malfunction Light and Message**

The TPMS will not function properly if one or more of the TPMS sensors are missing or inoperable. When the system detects a malfunction, the low tire pressure warning light, defined above, flashes for about one minute and then stays on for the remainder of the ignition cycle. A DIC warning message may also display. The malfunction light and DIC warning message, if equipped, come on at each ignition cycle until the problem is corrected. Some of the conditions that can cause these to come on are:

- The TPMS sensor matching process was not done or not completed successfully after rotating the tires or exchanging a road tire with the spare tire. The malfunction light and the DIC message, if equipped, should go

off after successfully completing the sensor matching process. See "TPMS Sensor Matching Process" later in this section.

- One or more TPMS sensors are missing or damaged. The malfunction light and the DIC message, if equipped, should go off when the TPMS sensors are installed and the sensor matching process is performed successfully. See your dealer for service.
- Replacement tires or wheels do not match the original equipment tires or wheels. Tires and wheels other than those recommended could prevent the TPMS from functioning properly. See *Buying New Tires on page 10-49*.
- Operating electronic devices or being near facilities using radio wave frequencies similar to the TPMS could cause the TPMS sensors to malfunction.

If the TPMS is not functioning properly, it cannot detect or signal a low tire condition. See your dealer for service if the TPMS malfunction light and DIC message, if equipped, come on and stay on.

### **TPMS Sensor Matching Process**

Each TPMS sensor has a unique identification code. The identification code needs to be matched to a new tire/wheel position after rotating the vehicle's tires or replacing one or more of the TPMS sensors. Also, the TPMS sensor matching process should be performed after replacing a spare tire with a road tire containing the TPMS sensor. The malfunction light and the DIC message, if equipped, should go off at the next ignition cycle. The sensors are matched to the tire/wheel positions, using a TPMS relearn tool, in the following order: left front tire, right front tire, right

rear tire, and left rear tire. See your dealer for service or to purchase a relearn tool.

There are two minutes to match the first tire/wheel position, and five minutes overall to match all four tire/wheel positions. If it takes longer, the matching process stops and must be restarted.

The TPMS sensor matching process is:

1. Set the parking brake.
2. Turn the ignition to ON/RUN with the engine off.
3. Use the MENU button to select the Vehicle Information Menu in the Driver Information Center (DIC).
4. Use the thumbwheel to scroll to the Tire Pressure Menu Item screen.

5. Press and hold the SET/CLR button to begin the sensor matching process.  
A message requesting acceptance of the process may display.
6. If requested, press the SET/CLR button again to confirm the selection.  
The horn sounds twice to signal the receiver is in relearn mode and the TIRE LEARN or TIRE LEARNING ACTIVE message displays on the DIC screen.
7. Start with the left front tire.
8. Place the relearn tool against the tire sidewall, near the valve stem. Then press the button to activate the TPMS sensor. A horn chirp confirms that the sensor identification code has been matched to this tire and wheel position.
9. Proceed to the right front tire, and repeat the procedure in Step 8.

10. Proceed to the right rear tire, and repeat the procedure in Step 8.
11. Proceed to the left rear tire, and repeat the procedure in Step 8. The horn sounds two times to indicate the sensor identification code has been matched to the left rear tire, and the TPMS sensor matching process is no longer active. The TIRE LEARN or TIRE LEARNING ACTIVE message on the DIC display screen goes off.
12. Turn the ignition to LOCK/OFF.
13. Set all four tires to the recommended air pressure level as indicated on the Tire and Loading Information label.

### Tire Inspection

We recommend that the tires, including the spare tire, if the vehicle has one, be inspected for signs of wear or damage at least once a month.

Replace the tire if:

- The indicators at three or more places around the tire can be seen.
- There is cord or fabric showing through the tire's rubber.
- The tread or sidewall is cracked, cut, or snagged deep enough to show cord or fabric.
- The tire has a bump, bulge, or split.



- The tire has a puncture, cut, or other damage that cannot be repaired well because of the size or location of the damage.

### Tire Rotation

The tires should be rotated every 12 000 km/7,500 mi. See *Maintenance Schedule on page 11-2*.

Tires are rotated to achieve uniform wear for all tires. The first rotation is the most important.

Anytime unusual wear is noticed, rotate the tires as soon as possible, check for proper tire inflation pressure, and check for damaged tires or wheels. If the unusual wear continues after the rotation, check the wheel

alignment. See *When It Is Time for New Tires on page 10-48* and *Wheel Replacement on page 10-52*.

Different tire sizes should not be rotated front to rear.

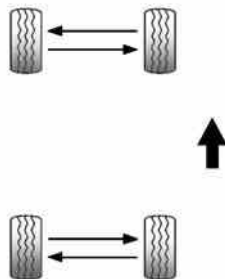

Use this rotation pattern if the vehicle has different size tires on the front and rear.

Adjust the front and rear tires to the recommended inflation pressure on the Tire and

Loading Information label after the tires have been rotated. See *Tire Pressure on page 10-41* and *Vehicle Load Limits on page 9-10*.

Reset the Tire Pressure Monitor System. See *Tire Pressure Monitor Operation on page 10-43*.

Check that all wheel nuts are properly tightened. See “Wheel Nut Torque” under *Capacities and Specifications on page 12-2*.

#### **Warning**

Rust or dirt on a wheel, or on the parts to which it is fastened, can make wheel nuts become loose after time. The wheel could come off and cause an accident. When changing a wheel, remove any rust or dirt from places where the

(Continued)

**Warning (Continued)**

wheel attaches to the vehicle. In an emergency, a cloth or a paper towel can be used; however, use a scraper or wire brush later to remove all rust or dirt.

Lightly coat the center of the wheel hub with wheel bearing grease after a wheel change or tire rotation to prevent corrosion or rust build-up. Do not get grease on the flat wheel mounting surface or on the wheel nuts or bolts.

**When It Is Time for New Tires**

Factors such as maintenance, temperatures, driving speeds, vehicle loading, and road conditions affect the wear rate of the tires.

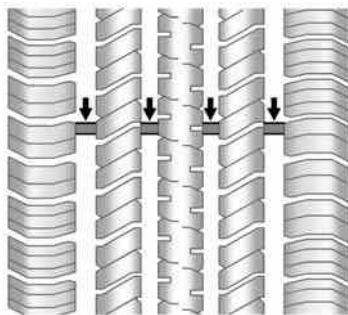

Treadwear indicators are one way to tell when it is time for new tires. Treadwear indicators appear when the tires have only 1.6 mm (1/16 in) or less of tread remaining. See *Tire Inspection* on page 10-46 and *Tire Rotation* on page 10-47.

The rubber in tires ages over time. This also applies to the spare tire, if the vehicle has one, even if it is never used. Multiple factors including temperatures, loading conditions, and inflation pressure maintenance affect how fast aging takes place. GM recommends that tires, including the spare if

equipped, be replaced after six years, regardless of tread wear. The tire manufacturer date is the last four digits of the DOT Tire Identification Number (TIN) which is molded into one side of the tire sidewall. The first two digits represent the week (01–52) and the last two digits, the year. For example, the third week of the year 2010 would have a four-digit DOT date of 0310.

**Vehicle Storage**

Tires age when stored normally mounted on a parked vehicle. Park a vehicle that will be stored for at least a month in a cool, dry, clean area away from direct sunlight to slow aging. This area should be free of grease, gasoline, or other substances that can deteriorate rubber.

Parking for an extended period can cause flat spots on the tires that may result in vibrations while driving. When storing a vehicle for

at least a month, remove the tires or raise the vehicle to reduce the weight from the tires.

## Buying New Tires

GM has developed and matched specific tires for the vehicle. The original equipment tires installed were designed to meet General Motors Tire Performance Criteria Specification (TPC Spec) system rating. When replacement tires are needed, GM strongly recommends buying tires with the same TPC Spec rating.

GM's exclusive TPC Spec system considers over a dozen critical specifications that impact the overall performance of the vehicle, including brake system performance, ride and handling, traction control, and tire pressure monitoring performance. GM's TPC Spec

number is molded onto the tire's sidewall near the tire size. If the tires have an all-season tread design, the TPC Spec number will be followed by MS for mud and snow. See *Tire Sidewall Labeling on page 10-36*, for additional information.

GM recommends replacing worn tires in complete sets of four. Uniform tread depth on all tires will help to maintain the performance of the vehicle. Braking and handling performance may be adversely affected if all the tires are not replaced at the same time. If proper rotation and maintenance have been done, all four tires should wear out at about the same time. See *Tire Rotation on page 10-47* for information on proper tire rotation. However, if it is

necessary to replace only one axle set of worn tires, place the new tires on the rear axle.

Winter tires with the same speed rating as the original equipment tires may not be available for H, V, W, and ZR speed rated tires. Never exceed the winter tire's maximum speed capability when using winter tires with a lower speed rating.

### Warning

Tires could explode during improper service. Attempting to mount or dismount a tire could cause injury or death. Only your dealer or authorized tire service center should mount or dismount the tires.

 **Warning**

Mixing tires of different sizes (other than those originally installed on the vehicle), brands, or types may cause loss of control of the vehicle, resulting in a crash or other vehicle damage. Use the correct size, brand, and type of tire on all four wheels.

 **Warning**

Using bias-ply tires on the vehicle may cause the wheel rim flanges to develop cracks after many miles of driving. A tire and/or wheel could fail suddenly and cause a crash. Use only radial-ply tires with the wheels on the vehicle.

If the vehicle tires must be replaced with a tire that does not have a TPC Spec number, make sure they are the same size, load range, speed rating, and construction (radial) as the original tires.

Vehicles that have a tire pressure monitoring system could give an inaccurate low-pressure warning if non-TPC Spec rated tires are installed. See *Tire Pressure Monitor Operation on page 10-43*.

The Tire and Loading Information label indicates the original equipment tires on the vehicle. See *Vehicle Load Limits on page 9-10*, for the label location and more information about the Tire and Loading Information label.

## Different Size Tires and Wheels

If wheels or tires are installed that are a different size than the original equipment wheels and tires, vehicle performance, including its braking, ride and handling characteristics, stability, and resistance to rollover may be affected. If the vehicle has electronic systems such as antilock brakes, rollover airbags, traction control, electronic stability control, or All-Wheel Drive, the performance of these systems can also be affected.

 **Warning**

If different sized wheels are used, there may not be an acceptable level of performance and safety if tires not recommended for those wheels are selected. This increases the chance of a crash and serious injury. Only use GM

(Continued)

**Warning (Continued)**

specific wheel and tire systems developed for the vehicle, and have them properly installed by a GM certified technician.

See *Buying New Tires on page 10-49* and *Accessories and Modifications on page 10-2*.

## Uniform Tire Quality Grading

Quality grades can be found where applicable on the tire sidewall between tread shoulder and maximum section width. For example:

### **Treadwear 200 Traction AA Temperature A**

The following information relates to the system developed by the United States National Highway Traffic Safety Administration

(NHTSA), which grades tires by treadwear, traction, and temperature performance. This applies only to vehicles sold in the United States. The grades are molded on the sidewalls of most passenger car tires. The Uniform Tire Quality Grading (UTQG) system does not apply to deep tread, winter tires, compact spare tires, tires with nominal rim diameters of 10 to 12 inches (25 to 30 cm), or to some limited-production tires.

While the tires available on General Motors passenger cars and light trucks may vary with respect to these grades, they must also conform to federal safety requirements and additional General Motors Tire Performance Criteria (TPC) standards.

All Passenger Car Tires Must Conform to Federal Safety Requirements In Addition To These Grades.

### **Treadwear**

The treadwear grade is a comparative rating based on the wear rate of the tire when tested under controlled conditions on a specified government test course. For example, a tire graded 150 would wear one and one-half (1½) times as well on the government course as a tire graded 100. The relative performance of tires depends upon the actual conditions of their use, however, and may depart significantly from the norm due to variations in driving habits, service practices and differences in road characteristics and climate.

### **Traction**

The traction grades, from highest to lowest, are AA, A, B, and C. Those grades represent the tire's ability to stop on wet pavement as measured under controlled conditions on specified government test surfaces of asphalt and concrete. A tire marked C may have poor traction performance. Warning: The traction grade assigned to this tire is based on straight-ahead braking traction tests, and does not include acceleration, cornering, hydroplaning, or peak traction characteristics.

### **Temperature**

The temperature grades are A (the highest), B, and C, representing the tire's resistance to the generation of heat and its ability to dissipate heat when tested under controlled

conditions on a specified indoor laboratory test wheel. Sustained high temperature can cause the material of the tire to degenerate and reduce tire life, and excessive temperature can lead to sudden tire failure. The grade C corresponds to a level of performance which all passenger car tires must meet under the Federal Motor Safety Standard No. 109. Grades B and A represent higher levels of performance on the laboratory test wheel than the minimum required by law. Warning: The temperature grade for this tire is established for a tire that is properly inflated and not overloaded. Excessive speed, underinflation, or excessive loading, either separately or in combination, can cause heat buildup and possible tire failure.

### **Wheel Alignment and Tire Balance**

The tires and wheels were aligned and balanced at the factory to provide the longest tire life and best overall performance. Adjustments to wheel alignment and tire balancing are not necessary on a regular basis. Consider an alignment check if there is unusual tire wear or the vehicle is significantly pulling to one side or the other. Some slight pull to the left or right, depending on the crown of the road and/or other road surface variations such as troughs or ruts, is normal. If the vehicle is vibrating when driving on a smooth road, the tires and wheels may need to be rebalanced. See your dealer for proper diagnosis.

### **Wheel Replacement**

Replace any wheel that is bent, cracked, or badly rusted or corroded. If wheel nuts keep coming loose, the wheel, wheel bolts, and wheel nuts should be replaced.

If the wheel leaks air, replace it. Some aluminum wheels can be repaired. See your dealer if any of these conditions exist.

Your dealer will know the kind of wheel that is needed.

Each new wheel should have the same load-carrying capacity, diameter, width, offset, and be mounted the same way as the one it replaces.

Replace wheels, wheel bolts, wheel nuts, or Tire Pressure Monitor System (TPMS) sensors with new GM original equipment parts.

 **Warning**

Using the wrong replacement wheels, wheel bolts, or wheel nuts can be dangerous. It could affect the braking and handling of the vehicle. Tires can lose air, and cause loss of control, causing  
(Continued)

**Warning (Continued)**

a crash. Always use the correct wheel, wheel bolts, and wheel nuts for replacement.

 **Caution**

The wrong wheel can also cause problems with bearing life, brake cooling, speedometer or odometer calibration, headlamp aim, bumper height, vehicle ground clearance, and tire or tire chain clearance to the body and chassis.

**Used Replacement Wheels**

 **Warning**

Replacing a wheel with a used one is dangerous. How it has been used or how far it has been driven may be unknown. It could fail suddenly and cause a crash. When replacing wheels, use a new GM original equipment wheel.

**Tire Chains**

 **Warning**

Do not use tire chains. There is not enough clearance. Tire chains used on a vehicle without the proper amount of clearance can cause damage to the brakes, suspension, or other vehicle parts. The area damaged by the tire chains could cause loss of  
(Continued)

**Warning (Continued)**

control and a crash. Use another type of traction device only if its manufacturer recommends it for the vehicle's tire size combination and road conditions. Follow that manufacturer's instructions. To avoid vehicle damage, drive slowly and readjust or remove the traction device if it contacts the vehicle. Do not spin the wheels. If traction devices are used, install them on the rear tires.

**If a Tire Goes Flat**

It is unusual for a tire to blow out while driving, especially if the tires are maintained properly. See *Tires on page 10-34*. If air goes out of a tire, it is much more likely to leak out slowly. But if there is ever a blowout, here are a few tips about what to expect and what to do:

If a front tire fails, the flat tire creates a drag that pulls the vehicle toward that side. Take your foot off the accelerator pedal and grip the steering wheel firmly. Steer to maintain lane position, and then gently brake to a stop, well off the road, if possible.

A rear blowout, particularly on a curve, acts much like a skid and may require the same correction as used in a skid. Stop pressing the accelerator pedal and steer to straighten the vehicle. It may be very bumpy and noisy. Gently brake to a stop, well off the road, if possible.

 **Warning**

Driving on a flat tire will cause permanent damage to the tire. Re-inflating a tire after it has been driven on while severely underinflated or flat may cause a blowout and a serious crash. Never attempt to re-inflate a tire that has been driven on while severely underinflated or flat. Have your dealer or an authorized tire service center repair or replace the flat tire as soon as possible.

 **Warning**

Lifting a vehicle and getting under it to do maintenance or repairs is dangerous without the appropriate safety equipment and training. If a jack is provided with the vehicle, it is designed only for

(Continued)



**Warning (Continued)**

changing a flat tire. If it is used for anything else, you or others could be badly injured or killed if the vehicle slips off the jack. If a jack is provided with the vehicle, only use it for changing a flat tire.

If a tire goes flat, avoid further tire and wheel damage by driving slowly to a level place, well off the road, if possible. Turn on the hazard warning flashers. See *Hazard Warning Flashers* on page 6-3.

**Warning**

Changing a tire can be dangerous. The vehicle can slip off the jack and roll over or fall causing injury or death. Find a level place to change the tire. To help prevent the vehicle from moving:

(Continued)

**Warning (Continued)**

1. Set the parking brake firmly.
2. Put an automatic transmission in P (Park) or a manual transmission in 1 (First) or R (Reverse).
3. Turn off the engine and do not restart while the vehicle is raised.
4. Do not allow passengers to remain in the vehicle.
5. Place wheel blocks on both sides of the tire at the opposite corner of the tire being changed.

This vehicle may come with a jack and spare tire or a tire sealant and compressor kit. To use the jacking equipment to change a spare tire safely, follow the instructions below.

Then see *Tire Changing* on page 10-63. To use the tire sealant and compressor kit, see *Tire Sealant and Compressor Kit* on page 10-56.

When the vehicle has a flat tire (2), use the following example as a guide to assist you in the placement of wheel blocks (1).

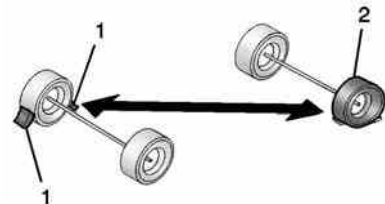

1. Wheel Block
2. Flat Tire

The following information explains how to repair or change a tire.

## Tire Sealant and Compressor Kit

 **Warning**

Idling a vehicle in an enclosed area with poor ventilation is dangerous. Engine exhaust may enter the vehicle. Engine exhaust contains carbon monoxide (CO) which cannot be seen or smelled. It can cause unconsciousness and even death. Never run the engine in an enclosed area that has no fresh air ventilation. For more information, see *Engine Exhaust* on page 9-21.

 **Warning**

Overinflating a tire could cause the tire to rupture and you or others could be injured. Be sure to read and follow the tire sealant  
(Continued)

**Warning (Continued)**

and compressor kit instructions and inflate the tire to its recommended pressure. Do not exceed the recommended pressure.

 **Warning**

Storing the tire sealant and compressor kit or other equipment in the passenger compartment of the vehicle could cause injury. In a sudden stop or collision, loose equipment could strike someone. Store the tire sealant and compressor kit in its original location.

If this vehicle has a tire sealant and compressor kit, there may not be a spare tire, tire changing equipment, and on some vehicles there may not be a place to store a tire.

The tire sealant and compressor can be used to temporarily seal punctures up to 6 mm (0.25 inch) in the tread area of the tire. It can also be used to inflate an under inflated tire.

If the tire has been separated from the wheel, has damaged sidewalls, or has a large puncture, the tire is too severely damaged for the tire sealant and compressor kit to be effective. See *Roadside Assistance Program* on page 13-5.

Read and follow all of the tire sealant and compressor kit instructions.

The kit includes:

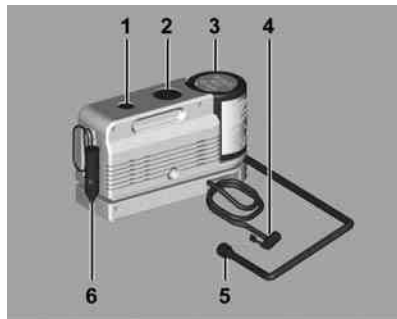

1. On/Off Switch
2. Pressure Gauge
3. Tire Sealant Canister
4. Air Only Hose
5. Sealant/Air Hose
6. Power Plug

### Tire Sealant

Read and follow the safe handling instructions on the label adhered to the sealant canister.

Check the tire sealant expiration date on the sealant canister. The sealant canister should be replaced before its expiration date. Replacement sealant canisters are available at your local dealer. See "Removal and Installation of the Sealant Canister" following.

There is only enough sealant to seal one tire. After usage, the sealant canister and sealant/air hose assembly must be replaced. See "Removal and Installation of the Sealant Canister" following.

### Using the Tire Sealant and Compressor Kit to Temporarily Seal and Inflate a Punctured Tire

When using the tire sealant and compressor kit during cold temperatures, warm the kit in a heated environment for five minutes. This will help to inflate the tire faster.

If a tire goes flat, avoid further tire and wheel damage by driving slowly to a level place. Turn on the hazard warning flashers. See *Hazard Warning Flashers* on page 6-3.

See *If a Tire Goes Flat* on page 10-54 for other important safety warnings.

Do not remove any objects that have penetrated the tire.

1. Remove the tire sealant and compressor kit from its storage location. See *Storing the Tire Sealant and Compressor Kit* on page 10-62.
2. Remove the sealant/air hose (5) from the side of the compressor.
3. Remove the power plug (6).
4. Place the kit on the ground.  
Make sure the tire valve stem is positioned close to the ground so the hose will reach it.
5. Remove the valve stem cap from the flat tire by turning it counterclockwise.

6. Attach the sealant/air hose (5) onto the tire valve. Turn it clockwise until it is tight.
7. Switch the on/off switch (1) to the O position.
8. Plug the power plug (6) into the power outlet in the vehicle. Unplug all items from other accessory power outlets. See *Power Outlets on page 5-4*.

If the vehicle has an accessory power outlet, do not use the cigarette lighter.

If the vehicle only has a cigarette lighter, use the cigarette lighter.

Do not pinch the power plug cord in the door or window.

9. Start the vehicle. The vehicle must be running while using the air compressor.
10. Switch the on/off switch (1) to the I position.  
The compressor will inject sealant and air into the tire.

Sealant may leak from the puncture hole until the vehicle is driven and the hole has sealed.

The pressure gauge (2) will initially show a high pressure while the compressor pushes the sealant into the tire. Once the sealant is completely dispersed into the tire, the pressure will quickly drop and start to rise again as the tire inflates with air only.

11. Inflate the tire to the recommended inflation pressure using the pressure gauge (2). The recommended inflation pressure can be found on the Tire and Loading Information label. See *Tire Pressure on page 10-41*.

The pressure gauge (2) may read higher than the actual tire pressure while the compressor is on. Turn the compressor off to get an accurate pressure

reading. The compressor may be turned on/off until the correct pressure is reached.

### **Caution**

If the recommended pressure cannot be reached after approximately 25 minutes, the vehicle should not be driven farther. The tire is too severely damaged and the tire sealant and compressor kit cannot inflate the tire. Remove the power plug from the accessory power outlet and unscrew the inflating hose from the tire valve. See *Roadside Assistance Program on page 13-5*.

12. Switch the on/off switch (1) to the O position.  
The tire is not sealed and will continue to leak air until the vehicle is driven and the sealant is distributed in the tire. Therefore, Steps 13–19 must be done immediately after Step 12.  
Be careful while handling the tire sealant and compressor kit as it could be warm after usage.
13. Unplug the power plug (6) from the accessory power outlet in the vehicle.
14. Turn the sealant/air hose (5) counterclockwise to remove it from the tire valve stem.
15. Replace the tire valve stem cap.
16. Replace the sealant/air hose (5), and the power plug (6) back in their original location.



17. If the flat tire was able to inflate to the recommended inflation pressure, remove the maximum speed label from the tire sealant canister (3) and place it in a highly visible location.  
Do not exceed the speed on this label until the damaged tire is repaired or replaced.
18. Return the equipment to its original storage location in the vehicle.
19. Immediately drive the vehicle 8 km (5 mi) to distribute the sealant in the tire.

20. Stop at a safe location and check the tire pressure. Refer to Steps 1–10 under “Using the Tire Sealant and Compressor Kit without Sealant to Inflate a Tire (Not Punctured).”  
If the tire pressure has fallen more than 68 kPa (10 psi) below the recommended inflation pressure, stop driving the vehicle. The tire is too severely damaged and the tire sealant cannot seal the tire. See *Roadside Assistance Program* on page 13-5.  
If the tire pressure has not dropped more than 68 kPa (10 psi) from the recommended inflation pressure, inflate the tire to the recommended inflation pressure.
21. Wipe off any sealant from the wheel, tire or vehicle.
22. Dispose of the used tire sealant canister (3) and sealant/air hose (5) assembly

at a local dealer or in accordance with local state codes and practices.

23. Replace it with a new canister available from your dealer.
24. After temporarily sealing a tire using the tire sealant and compressor kit, take the vehicle to an authorized dealer within 161 km (100 mi) of driving to have the tire repaired or replaced.

### Using the Tire Sealant and Compressor Kit without Sealant to Inflate a Tire (Not Punctured)

To use the air compressor to inflate a tire with air only and not sealant:

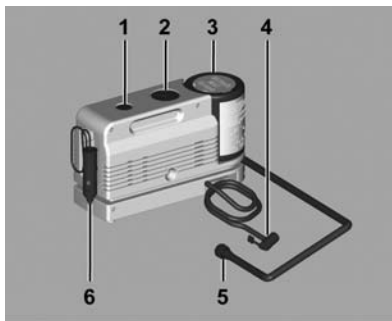

1. On/Off Switch
2. Pressure Gauge
3. Tire Sealant Canister
4. Air Only Hose
5. Sealant/Air Hose
6. Power Plug

If a tire goes flat, avoid further tire and wheel damage by driving slowly to a level place. Turn on the hazard warning flashers. See *Hazard Warning Flashers* on page 6-3.

See *If a Tire Goes Flat* on page 10-54 for other important safety warnings.

1. Remove the tire sealant and compressor kit from its storage location. See *Storing the Tire Sealant and Compressor Kit* on page 10-62.
2. Lift the lever and pull the air only hose (4) from the bottom of the tire sealant and compressor kit.
3. Remove the power plug (6) from the air compressor.
4. Place the kit on the ground.  
Make sure the tire valve stem is positioned close to the ground so the hose will reach it.
5. Remove the tire valve stem cap by turning it counterclockwise.

6. Attach the air only hose (4) onto the tire valve stem and press the lever down to secure it.
7. Plug the power plug (6) into the accessory power outlet in the vehicle. Unplug all items from other accessory power outlets. See *Power Outlets on page 5-4*.

If the vehicle has an accessory power outlet, do not use the cigarette lighter.

If the vehicle only has a cigarette lighter, use the cigarette lighter.

Do not pinch the power plug cord in the door or window.

8. Start the vehicle. The vehicle must be running while using the air compressor.
9. Switch the on/off switch (1) to the I position.  
The compressor will inflate the tire with air only.

10. Inflate the tire to the recommended inflation pressure using the pressure gauge (2). The recommended inflation pressure can be found on the Tire and Loading Information label. See *Tire Pressure on page 10-41*.

The pressure gauge (2) may read higher than the actual tire pressure while the compressor is on. Turn the compressor off to get an accurate reading. The compressor may be turned on/off until the correct pressure is reached.

11. Switch the on/off switch (1) to the O position.  
Be careful while handling the tire sealant and compressor kit as it could be warm after usage.
12. Unplug the power plug (6) and the air only hose (4).
13. Replace the tire valve stem cap.

14. Place the equipment in the original storage location in the vehicle.

### **Removal and Installation of the Sealant Canister**

After repairing a tire, replace the tire sealant canister.

To remove the sealant canister:

1. Unlock the air only hose (4) from the tire sealant canister (3) by pulling up on the lever.
2. Pull the air only hose (4) from the tire sealant canister (3).
3. Unwrap the sealant/air hose (5) from the air compressor.

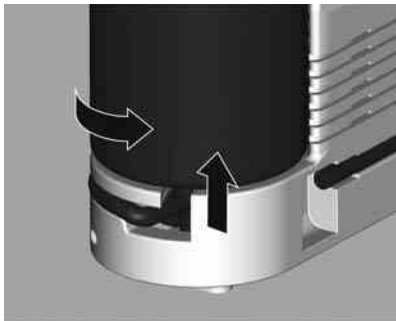

4. Turn the sealant canister (3) counterclockwise so the sealant/air hose (5) is aligned with the slot in the compressor.
5. Lift the tire sealant canister (3) from the compressor and replace with a new tire sealant canister. See your dealer for more information.
6. Dispose of the tire sealant canister at your dealer or in accordance with local or State codes and practices.

To install a new sealant canister:

1. Align the sealant/air hose (5) with the slot in the compressor.
2. Push the tire sealant canister (3) down and turn it clockwise.
3. Wrap the sealant/air hose (5) around the air compressor channel to stow it in its original location.
4. Push the air only hose (4) onto the tire sealant canister (3) inlet and push the lever down.

## Storing the Tire Sealant and Compressor Kit

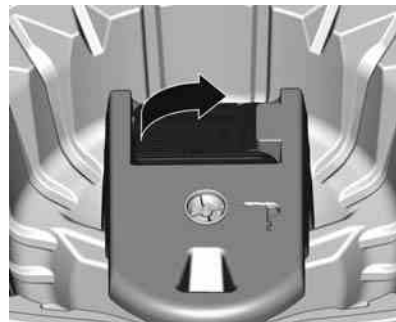

The tire sealant and air compressor kit is located in a foam container in the trunk, under the floor carpet.



## Tire Changing

### Removing the Spare Tire and Tools

To access the spare tire and tools:

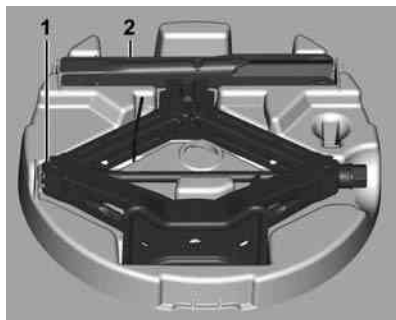

1. Jack
2. Wheel Wrench
1. Open the trunk.

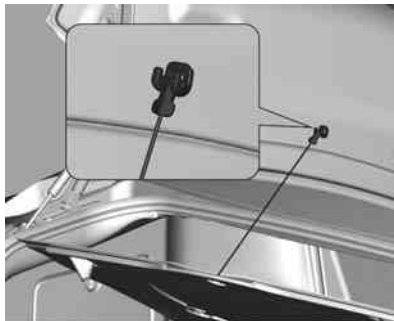

2. Lift the cover with the handle/strap and attach the hook to the trunk lid.

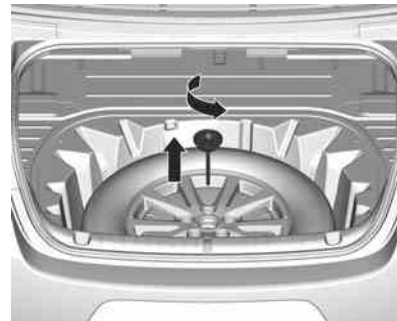

3. Turn the retainer nut counterclockwise to remove it.
4. Place the spare tire next to the tire being changed.

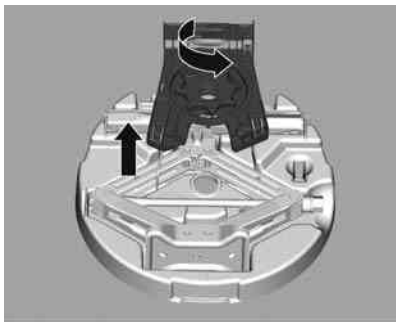

5. The vehicle may have a second retainer nut and panel.

To access the tools, remove the second retainer nut and panel.

6. Remove the tools and place them near the tire being changed.

Remove the tool container from the vehicle, if necessary.

### Removing the Flat Tire and Installing the Spare Tire

1. Do a safety check before proceeding. See *If a Tire Goes Flat* on page 10-54.



2. Turn the wheel wrench counterclockwise to loosen all the wheel nuts.  
Do not remove the wheel nuts.
3. Place the jack near the flat tire.
4. Place the spare tire near you.

#### Warning

Getting under a vehicle when it is lifted on a jack is dangerous. If the vehicle slips off the jack, you could be badly injured or killed. Never get under a vehicle when it is supported only by a jack.

#### Warning

Raising the vehicle with the jack improperly positioned can damage the vehicle and even make the vehicle fall. To help avoid personal injury and vehicle damage, be sure to fit the jack lift head into the proper location before raising the vehicle.

**⚠ Warning**

Lifting a vehicle and getting under it to do maintenance or repairs is dangerous without the appropriate safety equipment and training. If a jack is provided with the vehicle, it is designed only for changing a flat tire. If it is used for anything else, you or others could be badly injured or killed if the vehicle slips off the jack. If a jack is provided with the vehicle, only use it for changing a flat tire.

5. Unfold the wheel wrench so it forms a right angle.



6. Slide the wheel wrench onto the drive nut of the jack.

**⚠ Caution**

Make sure that the jack lift head is in the correct position or you may damage your vehicle. The repairs would not be covered by your warranty.

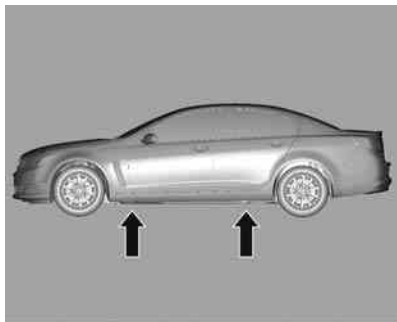

7. Position the jack lift head at the jack location nearest the flat tire. The locations are identified by cutouts in the underside of the door sill. The jack must not be used in any other position.

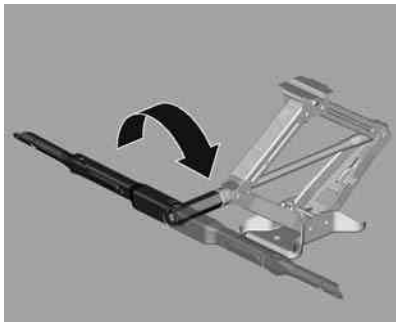

8. Raise the vehicle by turning the jack handle clockwise. Raise the vehicle far enough off the ground so there is enough room for the road tire to clear the ground.

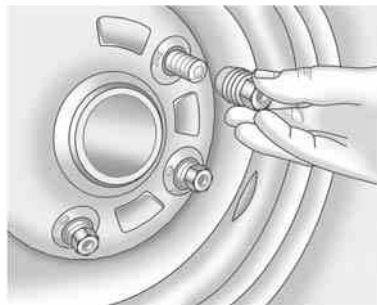

9. Remove all of the wheel nuts.
10. Remove the flat tire.

**Warning**

Rust or dirt on a wheel, or on the parts to which it is fastened, can make wheel nuts become loose after time. The wheel could come off and cause an accident. When changing a wheel, remove any rust or dirt from places where the wheel attaches to the vehicle. In

(Continued)

**Warning (Continued)**

an emergency, a cloth or a paper towel can be used; however, use a scraper or wire brush later to remove all rust or dirt.

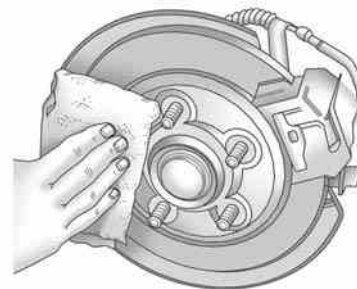

11. Remove any rust or dirt from the wheel bolts, mounting surfaces, and spare wheel.
12. Place the spare tire on the wheel-mounting surface.

**Warning**

Never use oil or grease on bolts or nuts because the nuts might come loose. The vehicle's wheel could fall off, causing a crash.

- 13. Reinstall the wheel nuts. Tighten each nut by hand until the wheel is held against the hub.
- 14. Lower the vehicle by turning the jack handle counterclockwise.

**Warning**

Wheel nuts that are improperly or incorrectly tightened can cause the wheels to become loose or come off. The wheel nuts should be tightened with a torque wrench to the proper torque specification after replacing. Follow the torque specification supplied by the

(Continued)

**Warning (Continued)**

aftermarket manufacturer when using accessory locking wheel nuts. See *Capacities and Specifications* on page 12-2 for original equipment wheel nut torque specifications.

**Caution**

Improperly tightened wheel nuts can lead to brake pulsation and rotor damage. To avoid expensive brake repairs, evenly tighten the wheel nuts in the proper sequence and to the proper torque specification. See *Capacities and Specifications* for the wheel nut torque specification.

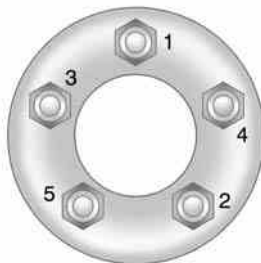

- 15. Tighten the wheel nuts firmly in a crisscross sequence, as shown.
- 16. Lower the jack all the way and remove the jack from under the vehicle.
- 17. Tighten the wheel nuts firmly with the wheel wrench.

### Storing a Flat or Spare Tire and Tools

#### Warning

Storing a jack, a tire, or other equipment in the passenger compartment of the vehicle could cause injury. In a sudden stop or collision, loose equipment could strike someone. Store all these in the proper place.

Replace the jack, tools, container and flat tire in the trunk by reversing the steps used to remove them.

### Full-Size Spare Tire

If this vehicle came with a full-size spare tire, it was fully inflated when new, however, it can lose air over time. Check the inflation pressure regularly. See *Tire Pressure* on page 10-41 and *Vehicle Load Limits* on page 9-10 for information regarding proper tire inflation and loading the vehicle. For instructions

on how to remove, install, or store a spare tire, see *Tire Changing* on page 10-63.

After installing the spare tire on the vehicle, stop as soon as possible and check that the spare is correctly inflated. The spare tire is made to perform well at speeds up to 112 km/h (70 mph) at the recommended inflation pressure, so you can finish your trip.

The full-size spare includes a TPMS sensor. The TPMS will not monitor or display the spare tire air pressure until the tire/wheel is installed at one of the four tire/wheel positions on the vehicle and matched to the new position. See *Tire Pressure Monitor Operation* on page 10-43 for information about matching the spare tire to the TPMS.

Have the damaged or flat road tire repaired or replaced and installed back onto the vehicle as soon as possible so the spare tire will be available in case it is needed again.

Do not mix tires and wheels of different sizes, because they will not fit. Keep the spare tire and its wheel together.

## Jump Starting

For more information about the vehicle battery, see *Battery* on page 10-20.

If the battery has run down, try to use another vehicle and some jumper cables to start your vehicle. Be sure to use the following steps to do it safely.

### Warning

Batteries can hurt you. They can be dangerous because:

- They contain acid that can burn you.
- They contain gas that can explode or ignite.
- They contain enough electricity to burn you.

If you do not follow these steps exactly, some or all of these things can hurt you.

### Caution

Ignoring these steps could result in costly damage to the vehicle that would not be covered by the vehicle warranty. Trying to start the vehicle by pushing or pulling it will not work, and it could damage the vehicle.

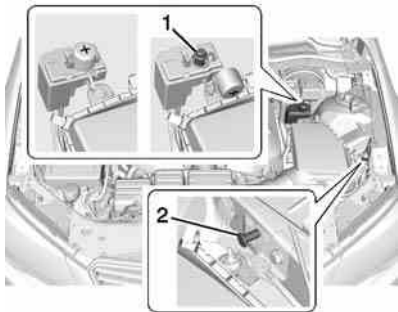

1. Jump Start Positive Post
2. Jump Start Negative Post

The jump start positive (1) and negative (2) posts are in the engine compartment on the driver side of the vehicle.

These posts are used instead of a direct connection to the battery.

The positive jump start connection is covered by a red cap. Remove to expose the terminal.

1. Check the other vehicle. It must have a 12-volt battery with a negative ground system.

### Caution

If the other vehicle does not have a 12-volt system with a negative ground, both vehicles can be damaged. Only use a vehicle that has a 12-volt system with a negative ground for jump starting.

2. Position the two vehicles so that they are not touching.

## 10-70 Vehicle Care

3. Set the parking brake firmly and put the shift lever in P (Park). See *Shifting Into Park* on page 9-18.

### Caution

If any accessories are left on or plugged in during the jump starting procedure, they could be damaged. The repairs would not be covered by the vehicle warranty. Whenever possible, turn off or unplug all accessories on either vehicle when jump starting.

4. Turn the ignition to LOCK/OFF and switch off all lights and accessories in both vehicles, except the hazard warning flashers if needed.

### Warning

An electric fan can start up even when the engine is not running and can injure you. Keep hands, clothing and tools away from any underhood electric fan.

### Warning

Using a match near a battery can cause battery gas to explode. People have been hurt doing this, and some have been blinded. Use a flashlight if you need more light.

Be sure the battery has enough water. You do not need to add water to the battery installed in your new vehicle. But if a battery has filler caps, be sure the right amount of fluid is there. If it is low,  
(Continued)

### Warning (Continued)

add water to take care of that first. If you do not, explosive gas could be present.

Battery fluid contains acid that can burn you. Do not get it on you. If you accidentally get it in your eyes or on your skin, flush the place with water and get medical help immediately.

### Warning

Fans or other moving engine parts can injure you badly. Keep your hands away from moving parts once the engine is running.

5. Connect one end of the red positive (+) cable to the jump start remote positive (+) post (1) of the discharged battery.



6. Connect the other end of the red positive (+) cable to the positive (+) terminal of the good battery.
7. Connect one end of the black negative (-) cable to the negative (-) terminal of the good battery.
8. Connect the other end of the black negative (-) cable to the remote negative (-) post (2).
9. Start the engine in the vehicle with the good battery and run the engine at idle speed for at least four minutes.
10. Try to start the vehicle that had the dead battery. If it will not start after a few tries, it probably needs service.

 **Caution**

If the jumper cables are connected or removed in the wrong order, electrical shorting may occur and damage the vehicle. The repairs would not be covered by the vehicle warranty. Always connect and remove the jumper cables in the correct order, making sure that the cables do not touch each other or other metal.

**Jumper Cable Removal**

Reverse the sequence exactly when removing the jumper cables

## Towing the Vehicle

 **Caution**

Incorrectly towing a disabled vehicle may cause damage. The damage would not be covered by the vehicle warranty. Do not lash or hook to the chassis components — including the front and rear subframes, suspension control arms, and links — during towing and recovery of a disabled vehicle, or when securing the vehicle. Use the proper nylon strap harnesses around the tires to secure the vehicle.

Have the vehicle towed on a flatbed car carrier. A wheel lift tow truck could damage the vehicle.

Consult your dealer or a professional towing service if the disabled vehicle must be towed.

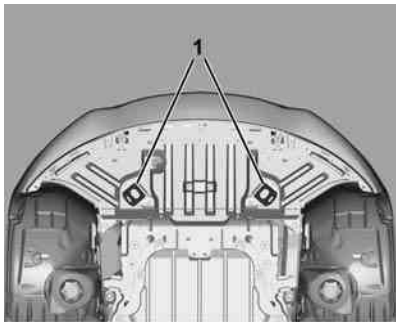

There are 2 oval-shaped slots (1) under the front of the vehicle that should be used to move a disabled vehicle. Use only these slots to hook to the vehicle. The slots can be accessed through the splash shield. Use an appropriate size T hook for the slot.

To tow the vehicle behind another vehicle for recreational purposes, such as behind a motor home, see "Recreational Vehicle Towing" following.

## Recreational Vehicle Towing



**Caution**

Dolly towing or dinghy towing the vehicle may cause damage because of reduced ground clearance. Always put the vehicle on a flatbed truck or trailer.

The vehicle was neither designed nor intended to be towed with any of its wheels on the ground. If the vehicle must be towed, see *Towing the Vehicle* on page 10-71.

## Appearance Care

### Exterior Care

#### Locks

Locks are lubricated at the factory. Use a de-icing agent only when absolutely necessary, and have the locks greased after using. See *Recommended Fluids and Lubricants* on page 11-12.

#### Washing the Vehicle

To preserve the vehicle's finish, wash it often and out of direct sunlight.



**Caution**

Do not use petroleum-based, acidic, or abrasive cleaning agents as they can damage the vehicle's paint, metal, or plastic parts. If damage occurs, it would not be covered by the vehicle warranty. Approved cleaning

(Continued)

**Caution (Continued)**

products can be obtained from your dealer. Follow all manufacturer directions regarding correct product usage, necessary safety precautions, and appropriate disposal of any vehicle care product.

 **Caution**

Avoid using high-pressure washes closer than 30 cm (12 in) to the surface of the vehicle. Use of power washers exceeding 8,274 kPa (1,200 psi) can result in damage or removal of paint and decals.

This symbol  is on any underhood compartment electrical center that should not be power

washed. This could cause damage that would not be covered by the vehicle warranty.

If using an automatic car wash, follow the car wash instructions. The windshield wiper and rear window wiper, if equipped, must be off. Remove any accessories that may be damaged or interfere with the car wash equipment.

Rinse the vehicle well, before washing and after, to remove all cleaning agents completely. If they are allowed to dry on the surface, they could stain.

Dry the finish with a soft, clean chamois or an all-cotton towel to avoid surface scratches and water spotting.

**Finish Care**

Application of aftermarket clearcoat sealant/wax materials is not recommended. If painted surfaces are damaged, see your dealer to have the damage assessed and repaired. Foreign materials such as

calcium chloride and other salts, ice melting agents, road oil and tar, tree sap, bird droppings, chemicals from industrial chimneys, etc., can damage the vehicle's finish if they remain on painted surfaces. Wash the vehicle as soon as possible. If necessary, use non-abrasive cleaners that are marked safe for painted surfaces to remove foreign matter.

Occasional hand waxing or mild polishing should be done to remove residue from the paint finish. See your dealer for approved cleaning products.

Do not apply waxes or polishes to uncoated plastic, vinyl, rubber, decals, simulated wood, or flat paint as damage can occur.

 **Caution**

Machine compounding or aggressive polishing on a basecoat/clearcoat paint finish

(Continued)

### Caution (Continued)

may damage it. Use only non-abrasive waxes and polishes that are made for a basecoat/clearcoat paint finish on the vehicle.

To keep the paint finish looking new, keep the vehicle garaged or covered whenever possible.

### Protecting Exterior Bright Metal Moldings

#### Caution

Failure to clean and protect the bright metal moldings can result in a hazy white finish or pitting. This damage would not be covered by the vehicle warranty.

The bright metal moldings on the vehicle are aluminum. To prevent damage always follow these cleaning instructions:

- Be sure the molding is cool to the touch before applying any cleaning solution.
- Use a cleaning solution approved for aluminum. Some cleaners are highly acidic or contain alkaline substances and can damage the moldings.
- Always dilute a concentrated cleaner according to the manufacturer's instructions.
- Do not use chrome cleaners.
- Do not use cleaners that are not intended for automotive use.
- Use a nonabrasive wax on the vehicle after washing to protect and extend the molding finish.

### Cleaning Exterior Lamps/Lenses, Emblems, Decals and Stripes

Use only lukewarm or cold water, a soft cloth, and a car washing soap to clean exterior lamps, lenses and emblems, decals and stripes. Follow instructions under "Washing the Vehicle" previously in this section.

Lamp covers are made of plastic, and some have a UV protective coating.

Use only lukewarm water, a soft cloth, and mild car washing soap to clean exterior lamps and lenses. Do not clean or wipe them while they are dry.

Do not use any of the following on lamp covers:

- Abrasive or caustic agents.
- Washer fluids and other cleaning agents in higher concentrations than suggested by the manufacturer.

- Solvents, alcohols, fuels, or other harsh cleaners.
- Ice scrapers or other hard items.
- Aftermarket appearance caps or covers while the lamps are illuminated, due to excessive heat generated.

 **Caution**

Failure to clean lamps properly can cause damage to the lamp cover that would not be covered by the vehicle warranty.

 **Caution**

Using wax on low gloss black finish stripes can increase the gloss level and create a non-uniform finish. Clean low gloss stripes with soap and water only.

**Air Intakes**

Clear debris from the air intakes, between the hood and windshield, when washing the vehicle.

**Windshield and Wiper Blades**

Clean the outside of the windshield with glass cleaner.

Clean rubber blades using a lint-free cloth or paper towel soaked with windshield washer fluid or a mild detergent. Wash the windshield thoroughly when cleaning the blades. Bugs, road grime, sap, and a buildup of vehicle wash/wax treatments may cause wiper streaking.

Replace the wiper blades if they are worn or damaged. Damage can be caused by extreme dusty conditions, sand, salt, heat, sun, snow, and ice.

**Weatherstrips**

Apply Dielectric silicone grease on weatherstrips to make them last longer, seal better, and not stick or

squeak. Lubricate weatherstrips at least once a year. Hot, dry climates may require more frequent application. Black marks from rubber material on painted surfaces can be removed by rubbing with a clean cloth. See *Recommended Fluids and Lubricants on page 11-12*.

**Tires**

Use a stiff brush with tire cleaner to clean the tires.

 **Caution**

Using petroleum-based tire dressing products on the vehicle may damage the paint finish and/or tires. When applying a tire dressing, always wipe off any overspray from all painted surfaces on the vehicle.

### Wheels and Trim — Aluminum or Chrome

Use a soft, clean cloth with mild soap and water to clean the wheels. After rinsing thoroughly with clean water, dry with a soft, clean towel. A wax may then be applied.

#### Caution

Chrome wheels and other chrome trim may be damaged if the vehicle is not washed after driving on roads that have been sprayed with magnesium, calcium, or sodium chloride. These chlorides are used on roads for conditions such as ice and dust. Always wash the chrome with soap and water after exposure.

#### Caution

To avoid surface damage, do not use strong soaps, chemicals, abrasive polishes, cleaners, brushes, or cleaners that contain acid on aluminum or chrome-plated wheels. Use only approved cleaners. Also, never drive a vehicle with aluminum or chrome-plated wheels through an automatic car wash that uses silicone carbide tire cleaning brushes. Damage could occur and the repairs would not be covered by the vehicle warranty.

### Door Drain Holes

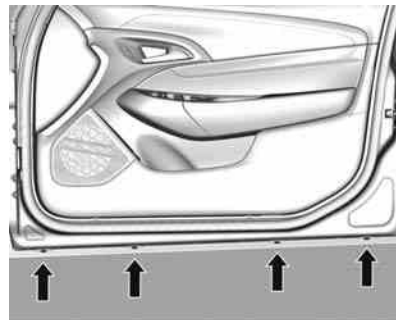

- Clear dirt and other foreign materials from the drain holes at the bottom of the door panels which could trap water inside the panels.
- Clean clogged drain holes.
- Avoid scratching the finish.

### Steering, Suspension, and Chassis Components

Visually inspect steering, suspension, and chassis components for damaged, loose or

missing parts or signs of wear at least once a year. Inspect the power steering for proper hook-up, binding, leaks, cracks, chafing, etc. Visually check constant velocity joint, boots and axle seals for leaks.

### Body Component Lubrication

Lubricate all key lock cylinders, hood hinges, liftgate hinges, and the steel fuel door hinge unless the components are plastic. Applying silicone grease on weatherstrips with a clean cloth will make them last longer, seal better, and not stick or squeak.

### Underbody Maintenance

At least twice a year, Spring and Fall, use plain water to flush dirt and debris from the vehicle's underbody. Your dealer or an underbody car washing system can do this. If not removed, rust and corrosion can develop.

### Sheet Metal Damage

If the vehicle is damaged and requires sheet metal repair or replacement, make sure the body repair shop applies anti-corrosion material to parts repaired or replaced to restore corrosion protection.

Original manufacturer replacement parts will provide the corrosion protection while maintaining the vehicle warranty.

### Finish Damage

Quickly repair minor chips and scratches with touch-up materials available from your dealer to avoid corrosion. Larger areas of finish damage can be corrected in your dealer's body and paint shop.

### Chemical Paint Spotting

Airborne pollutants can fall upon and attack painted vehicle surfaces causing blotchy, ring-shaped discolorations, and small, irregular

dark spots etched into the paint surface. Refer to "Finish Care" previously in this section.

### Interior Care

To prevent dirt particle abrasions, regularly clean the vehicle's interior. Immediately remove any soils. Note that newspapers or dark garments that can transfer color to home furnishings can also permanently transfer color to the vehicle's interior.

Use a soft bristle brush to remove dust from knobs and crevices on the instrument cluster. Using a mild soap solution, immediately remove hand lotions, sunscreen, and insect repellent from all interior surfaces or permanent damage may result.

Your dealer may have products for cleaning the interior. Use cleaners specifically designed for the surfaces being cleaned to prevent permanent damage. Apply all cleaners directly to the cleaning cloth. Do not spray cleaners directly

on any switches or controls. Cleaners should be removed quickly. Never allow cleaners to remain on the surface being cleaned for extended periods of time.

Cleaners may contain solvents that can become concentrated in the interior. Before using cleaners, read and adhere to all safety instructions on the label. While cleaning the interior, maintain adequate ventilation by opening the doors and windows.

To prevent damage, do not clean the interior using the following cleaners or techniques:

- Never use a razor or any other sharp object to remove a soil from any interior surface.
- Never use a brush with stiff bristles.
- Never rub any surface aggressively or with excessive pressure.

- Do not use laundry detergents or dishwashing soaps with degreasers. For liquid cleaners, use approximately 20 drops per 3.8 L (1 gal) of water. A concentrated soap solution will leave a residue that creates streaks and attracts dirt. Do not use solutions that contain strong or caustic soap.
- Do not heavily saturate the upholstery when cleaning.
- Do not use solvents or cleaners containing solvents.

### Interior Glass

To clean, use a terry cloth fabric dampened with water. Wipe droplets left behind with a clean dry cloth. Commercial glass cleaners may be used, if necessary, after cleaning the interior glass with plain water.

### Caution

To prevent scratching, never use abrasive cleaners on automotive glass. Abrasive cleaners or aggressive cleaning may damage the rear window defogger.

Cleaning the windshield with water during the first three to six months of ownership will reduce tendency to fog.

### Speaker Covers

Vacuum around a speaker cover gently, so that the speaker will not be damaged. Clean spots with just water and mild soap.

### Coated Moldings

Coated moldings should be cleaned.

- When lightly soiled, wipe with a sponge or soft lint-free cloth dampened with water.
- When heavily soiled, use warm soapy water.



## Fabric/Carpet/Suede

Start by vacuuming the surface using a soft brush attachment. If a rotating brush attachment is being used during vacuuming, only use it on the floor carpet. Before cleaning, gently remove as much of the soil as possible using one of the following techniques:

- Gently blot liquids with a paper towel. Continue blotting until no more soil can be removed.
- For solid soils, remove as much as possible prior to vacuuming.

To clean:

1. Saturate a clean lint-free colorfast cloth with water. Microfiber cloth is recommended to prevent lint transfer to the fabric or carpet.
2. Remove excess moisture by gently wringing until water does not drip from the cleaning cloth.

3. Start on the outside edge of the soil and gently rub toward the center. Fold the cleaning cloth to a clean area frequently to prevent forcing the soil in to the fabric.
4. Continue gently rubbing the soiled area until there is no longer any color transfer from the soil to the cleaning cloth.
5. If the soil is not completely removed, use a mild soap solution followed only by plain water.

If the soil is not completely removed, it may be necessary to use a commercial upholstery cleaner or spot lifter. Test a small hidden area for colorfastness before using a commercial upholstery cleaner or spot lifter. If ring formation occurs, clean the entire fabric or carpet.

Following the cleaning process, a paper towel can be used to blot excess moisture.

## Cleaning High Gloss Surfaces and Vehicle Information and Radio Displays

For vehicles with high gloss surfaces or vehicle displays, use a microfiber cloth to wipe surfaces. Before wiping the surface with the microfiber cloth, use a soft bristle brush to remove dirt that could scratch the surface. Then use the microfiber cloth by gently rubbing to clean. Never use window cleaners or solvents. Periodically hand wash the microfiber cloth separately, using mild soap. Do not use bleach or fabric softener. Rinse thoroughly and air dry before next use.

### Caution

Do not attach a device with a suction cup to the display. This may cause damage and would not be covered by the warranty.

**Instrument Panel, Leather, Vinyl, Other Plastic Surfaces, Low Gloss Paint Surfaces and Natural Open Pore Wood Surfaces**

Use a soft microfiber cloth dampened with water to remove dust and loose dirt. For a more thorough cleaning, use a soft microfiber cloth dampened with a mild soap solution.

 **Caution**

Soaking or saturating leather, especially perforated leather, as well as other interior surfaces, may cause permanent damage. Wipe excess moisture from these surfaces after cleaning and allow them to dry naturally. Never use heat, steam, spot lifters, or spot removers. Do not use cleaners that contain silicone or wax-based products. Cleaners containing  
(Continued)

**Caution (Continued)**

these solvents can permanently change the appearance and feel of leather or soft trim and are not recommended.

Do not use cleaners that increase gloss, especially on the instrument panel. Reflected glare can decrease visibility through the windshield under certain conditions.

 **Caution**

Use of air fresheners may cause permanent damage to plastics and painted surfaces. If an air freshener comes in contact with any plastic or painted surface in the vehicle, blot immediately and clean with a soft cloth dampened with a mild soap solution. Damage caused by air fresheners would not be covered by the vehicle warranty.

**Cargo Cover and Convenience Net**

Wash with warm water and mild detergent. Do not use chlorine bleach. Rinse with cold water, and then dry completely.

**Care of Safety Belts**

Keep belts clean and dry.

 **Warning**

Do not bleach or dye safety belts. It may severely weaken them. In a crash, they might not be able to provide adequate protection. Clean safety belts only with mild soap and lukewarm water.

## Floor Mats

### Warning

If a floor mat is the wrong size or is not properly installed, it can interfere with the pedals. Interference with the pedals can cause unintended acceleration and/or increased stopping distance which can cause a crash and injury. Make sure the floor mat does not interfere with the pedals.

Use the following guidelines for proper floor mat usage (if equipped):

- The original equipment floor mats were designed for your vehicle. If the floor mats need replacing, it is recommended that GM certified floor mats be purchased. Non-GM floor mats may not fit properly and may interfere with the pedals. Always check that the floor mats do not interfere with the pedals.

- Use the floor mat with the correct side up. Do not turn it over.
- Do not place anything on top of the driver side floor mat.
- Use only a single floor mat on the driver side.
- Do not place one floor mat on top of another.

### Removing and Replacing the Floor Mats

Pull up on the rear of the floor mat to unlock each retainer and remove.

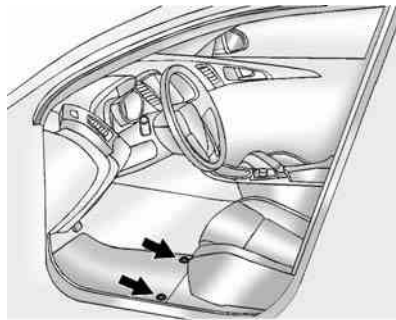

Reinstall by lining up the floor mat retainer openings over the carpet retainers and snap into position.

Make sure the floor mat is properly secured in place.

Verify the floor mat does not interfere with the pedals.



# Service and Maintenance

## General Information

General Information ..... 11-1

## Maintenance Schedule

Maintenance Schedule ..... 11-2

## Special Application Services

Special Application  
Services ..... 11-8

## Additional Maintenance and Care

Additional Maintenance  
and Care ..... 11-8

## Recommended Fluids

Recommended Fluids and  
Lubricants ..... 11-12  
Maintenance Replacement  
Parts ..... 11-13

## Maintenance Records

Maintenance Records ..... 11-14

## General Information

Your vehicle is an important investment. This section describes the required maintenance for the vehicle. Follow this schedule to help protect against major repair expenses resulting from neglect or inadequate maintenance. It may also help to maintain the value of the vehicle if it is sold. It is the responsibility of the owner to have all required maintenance performed.

Your dealer has trained technicians who can perform required maintenance using genuine replacement parts. They have up-to-date tools and equipment for fast and accurate diagnostics. Many dealers have extended evening and Saturday hours, courtesy transportation, and online scheduling to assist with service needs.

Your dealer recognizes the importance of providing competitively priced maintenance and repair services. With trained

technicians, the dealer is the place for routine maintenance such as oil changes and tire rotations and additional maintenance items like tires, brakes, batteries, and wiper blades.

### Caution

Damage caused by improper maintenance can lead to costly repairs and may not be covered by the vehicle warranty.

Maintenance intervals, checks, inspections, recommended fluids, and lubricants are important to keep the vehicle in good working condition.

The Tire Rotation and Required Services are the responsibility of the vehicle owner. It is recommended to have your dealer perform these services every 12 000 km/7,500 mi. Proper vehicle maintenance helps to keep the vehicle in good working condition, improves fuel economy, and reduces vehicle emissions.

## 11-2 Service and Maintenance

Because of the way people use vehicles, maintenance needs vary. There may need to be more frequent checks and services. Normal vehicle maintenance is for vehicles that:

- Carry passengers and cargo within recommended limits on the Tire and Loading Information label. See *Vehicle Load Limits on page 9-10*.
- Are driven on reasonable road surfaces within legal driving limits.
- Use the recommended fuel. See *Recommended Fuel on page 9-46*.

The Additional Required Services - Severe are for vehicles that are:

- Mainly driven in heavy city traffic in hot weather.
- Mainly driven in hilly or mountainous terrain.
- Frequently towing a trailer.

- Used for high speed or competitive driving.
- Used for taxi, police, or delivery service.

Refer to the information in the Maintenance Schedule Additional Required Services - Severe chart.

### **Warning**

Performing maintenance work can be dangerous and can cause serious injury. Perform maintenance work only if the required information, proper tools, and equipment are available. If they are not, see your dealer to have a trained technician do the work. See *Doing Your Own Service Work on page 10-3*.

## Maintenance Schedule

### Owner Checks and Services

#### At Each Fuel Stop

- Check the engine oil level. See *Engine Oil on page 10-6*.

#### Once a Month

- Check the tire inflation pressures. See *Tire Pressure on page 10-41*.
- Inspect the tires for wear. See *Tire Inspection on page 10-46*.
- Check the windshield washer fluid level. See *Washer Fluid on page 10-17*.

### Engine Oil Change

When the CHANGE ENGINE OIL SOON message displays, have the engine oil and filter changed within the next 1 000 km/600 mi. If driven under the best conditions, the engine oil life system might not indicate the need for vehicle service

for more than a year. The engine oil and filter must be changed at least once a year and the oil life system must be reset. Your trained dealer technician can perform this work. If the engine oil life system is reset accidentally, service the vehicle within 5 000 km/3,000 mi since the last service. Reset the oil life system when the oil is changed. See *Engine Oil Life System* on page 10-8.

### **Tire Rotation and Required Services Every 12 000 km/ 7,500 mi**

Rotate the tires, if recommended for the vehicle, and perform the following services. See *Tire Rotation* on page 10-47.

- Check engine oil level and oil life percentage. If needed, change engine oil and filter, and reset oil life system. See *Engine Oil* on page 10-6 and *Engine Oil Life System* on page 10-8.
- Check engine coolant level. See *Engine Coolant* on page 10-12.
- Check windshield washer fluid level. See *Washer Fluid* on page 10-17.
- Visually inspect windshield wiper blades for wear, cracking, or contamination. See *Exterior Care* on page 10-72. Replace worn or damaged wiper blades. See *Wiper Blade Replacement* on page 10-23.
- Check tire inflation pressures. See *Tire Pressure* on page 10-41.
- Check spare wheel retainer. If loose, tighten with a torque wrench to 4.5 +/- 0.5 N•m
- Inspect tire wear. See *Tire Inspection* on page 10-46.
- Visually check for fluid leaks.
- Inspect engine air cleaner filter. See *Engine Air Cleaner/Filter* on page 10-10.
- Inspect brake system.
- Visually inspect steering, suspension, and chassis components for damaged, loose, or missing parts or signs of wear. See *Exterior Care* on page 10-72.
- Check restraint system components. See *Safety System Check* on page 3-12.
- Visually inspect fuel system for damage or leaks.
- Visually inspect exhaust system and nearby heat shields for loose or damaged parts.
- Lubricate body components. See *Exterior Care* on page 10-72.
- Check starter switch. See *Starter Switch Check* on page 10-21.
- Check automatic transmission shift lock control function. See *Automatic Transmission Shift Lock Control Function Check* on page 10-22.
- Check ignition transmission lock. See *Ignition Transmission Lock Check* on page 10-22.

## 11-4 Service and Maintenance

---

- Check parking brake and automatic transmission park mechanism. See *Park Brake and P (Park) Mechanism Check on page 10-23*.
- Check accelerator pedal for damage, high effort, or binding. Replace if needed.
- Visually inspect gas strut for signs of wear, cracks, or other damage. Check the hold open ability of the strut. See your dealer if service is required.



<b>Maintenance Schedule Additional Required Services - Normal</b>	12 000 km/7,500 mi	24 000 km/15,000 mi	36 000 km/22,500 mi	48 000 km/30,000 mi	60 000 km/37,500 mi	72 000 km/45,000 mi	84 000 km/52,500 mi	96 000 km/60,000 mi	108 000 km/67,500 mi	120 000 km/75,000 mi	132 000 km/82,500 mi	144 000 km/90,000 mi	156 000 km/97,500 mi	168 000 km/105,000 mi	180 000 km/112,500 mi	192 000 km/120,000 mi	204 000 km/127,500 mi	216 000 km/135,000 mi	228 000 km/142,500 mi	240 000 km/150,000 mi
Rotate tires and perform Required Services. Check engine oil level and oil life percentage. Change engine oil and filter, if needed.	✓	✓	✓	✓	✓	✓	✓	✓	✓	✓	✓	✓	✓	✓	✓	✓	✓	✓	✓	✓
Replace passenger compartment air filter. (1)			✓			✓			✓			✓			✓			✓		
Inspect evaporative control system. (2)						✓						✓						✓		
Replace engine air cleaner filter. (3)						✓						✓						✓		
Change automatic transmission fluid. Change filter if serviceable.													✓							
Replace spark plugs. Inspect spark plug wires.													✓							
Drain and fill engine cooling system. (4)																				✓
Visually inspect accessory drive belts. (5)																				✓
Replace rear axle fluid.						✓						✓						✓		
Replace brake fluid. (6)				✓				✓				✓			✓					✓

## 11-6 Service and Maintenance

---

### Footnotes — Maintenance Schedule Additional Required Services - Normal

(1) Or every two years, whichever comes first. More frequent replacement may be needed if the vehicle is driven in areas with heavy traffic, areas with poor air quality, or areas with high dust levels.

Replacement may also be needed if there is a reduction in air flow, excessive window fogging, or odors.

(2) Check all fuel and vapor lines and hoses for proper hook-up, routing, and condition.

(3) Or every four years, whichever comes first.

(4) Or every five years, whichever comes first. See *Cooling System on page 10-11*.

(5) Or every 10 years, whichever comes first. Inspect for fraying, excessive cracking, or damage; replace, if needed.

(6) Or every two years, whichever comes first.

Maintenance Schedule Additional Required Services - Severe	12 000 km/7,500 mi	24 000 km/15,000 mi	36 000 km/22,500 mi	48 000 km/30,000 mi	60 000 km/37,500 mi	72 000 km/45,000 mi	84 000 km/52,500 mi	96 000 km/60,000 mi	108 000 km/67,500 mi	120 000 km/75,000 mi	132 000 km/82,500 mi	144 000 km/90,000 mi	156 000 km/97,500 mi	168 000 km/105,000 mi	180 000 km/112,500 mi	192 000 km/120,000 mi	204 000 km/127,500 mi	216 000 km/135,000 mi	228 000 km/142,500 mi	240 000 km/150,000 mi
	Rotate tires and perform Required Services. Check engine oil level and oil life percentage. Change engine oil and filter, if needed.	✓	✓	✓	✓	✓	✓	✓	✓	✓	✓	✓	✓	✓	✓	✓	✓	✓	✓	✓
Replace passenger compartment air filter. (1)			✓			✓			✓			✓			✓			✓		
Inspect evaporative control system. (2)						✓						✓						✓		
Replace engine air cleaner filter. (3)						✓						✓						✓		
Change automatic transmission fluid. Change filter if serviceable.						✓						✓						✓		
Replace spark plugs. Inspect spark plug wires.													✓							
Drain and fill engine cooling system. (4)																				✓
Visually inspect accessory drive belts. (5)																				✓
Replace rear axle fluid.						✓						✓						✓		
Replace brake fluid. (6)				✓				✓				✓			✓					✓

## 11-8 Service and Maintenance

---

### Footnotes — Maintenance Schedule Additional Required Services - Severe

**(1)** Or every two years, whichever comes first. More frequent replacement may be needed if the vehicle is driven in areas with heavy traffic, areas with poor air quality, or areas with high dust levels. Replacement may also be needed if there is a reduction in air flow, excessive window fogging, or odors.

**(2)** Check all fuel and vapor lines and hoses for proper hook-up, routing, and condition.

**(3)** Or every four years, whichever comes first.

**(4)** Or every five years, whichever comes first. See *Cooling System* on page 10-11.

**(5)** Or every 10 years, whichever comes first. Inspect for fraying, excessive cracking, or damage; replace, if needed.

**(6)** Or every two years, whichever comes first.

### Special Application Services

- Severe Commercial Use Vehicles Only: Lubricate chassis components every 5 000 km/ 3,000 mi.
- Have underbody flushing service performed. See "Underbody Maintenance" in *Exterior Care* on page 10-72.

### Additional Maintenance and Care

Your vehicle is an important investment and caring for it properly may help to avoid future costly repairs. To maintain vehicle performance, additional maintenance services may be required.

It is recommended that your dealer perform these services — their trained dealer technicians know your vehicle best. Your dealer can also perform a thorough assessment with a multi-point inspection to recommend when your vehicle may need attention.

The following list is intended to explain the services and conditions to look for that may indicate services are required.

### Battery

The battery supplies power to start the engine and operate any additional electrical accessories.

- To avoid break-down or failure to start the vehicle, maintain a battery with full cranking power.
- Trained dealer technicians have the diagnostic equipment to test the battery and ensure that the connections and cables are corrosion-free.

### Belts

- Belts may need replacing if they squeak or show signs of cracking or splitting.
- Trained dealer technicians have access to tools and equipment to inspect the belts and recommend adjustment or replacement when necessary.

### Brakes

Brakes stop the vehicle and are crucial to safe driving.

- Signs of brake wear may include chirping, grinding, or squealing noises, or difficulty stopping.
- Trained dealer technicians have access to tools and equipment to inspect the brakes and recommend quality parts engineered for the vehicle.

### Fluids

Proper fluid levels and approved fluids protect the vehicle's systems and components. See *Recommended Fluids and Lubricants on page 11-12* for GM approved fluids.

- Engine oil and windshield washer fluid levels should be checked at every fuel fill.
- Instrument cluster lights may come on to indicate that fluids may be low and need to be filled.

### Hoses

Hoses transport fluids and should be regularly inspected to ensure that there are no cracks or leaks. With a multi-point inspection, your dealer can inspect the hoses and advise if replacement is needed.

### Lamps

Properly working headlamps, taillamps, and brake lamps are important to see and be seen on the road.

- Signs that the headlamps need attention include dimming, failure to light, cracking, or damage. The brake lamps need to be checked periodically to ensure that they light when braking.
- With a multi-point inspection, your dealer can check the lamps and note any concerns.

## 11-10 Service and Maintenance

---

### Shocks and Struts

Shocks and struts help aid in control for a smoother ride.

- Signs of wear may include steering wheel vibration, bounce/sway while braking, longer stopping distance, or uneven tire wear.
- As part of the multi-point inspection, trained dealer technicians can visually inspect the shocks and struts for signs of leaking, blown seals, or damage, and can advise when service is needed.

### Tires

Tires need to be properly inflated, rotated, and balanced. Maintaining the tires can save money and fuel, and can reduce the risk of tire failure.

- Signs that the tires need to be replaced include three or more visible treadwear indicators; cord or fabric showing through the

rubber; cracks or cuts in the tread or sidewall; or a bulge or split in the tire.

- Trained dealer technicians can inspect and recommend the right tires. Your dealer can also provide tire/wheel balancing services to ensure smooth vehicle operation at all speeds. Your dealer sells and services name brand tires.

### Vehicle Care

To help keep the vehicle looking like new, vehicle care products are available from your dealer. For information on how to clean and protect the vehicle's interior and exterior, see *Interior Care on page 10-77* and *Exterior Care on page 10-72*.

### Wheel Alignment

Wheel alignment is critical for ensuring that the tires deliver optimal wear and performance.

- Signs that the alignment may need to be adjusted include pulling, improper vehicle handling, or unusual tire wear.
- Your dealer has the required equipment to ensure proper wheel alignment.

### Windshield

For safety, appearance, and the best viewing, keep the windshield clean and clear.

- Signs of damage include scratches, cracks, and chips.
- Trained dealer technicians can inspect the windshield and recommend proper replacement if needed.

### **Wiper Blades**

Wiper blades need to be cleaned and kept in good condition to provide a clear view.

- Signs of wear include streaking, skipping across the windshield, and worn or split rubber.
- Trained dealer technicians can check the wiper blades and replace them when needed.

## Recommended Fluids

### Recommended Fluids and Lubricants

Usage	Fluid/Lubricant
Engine Oil	Use only engine oil licensed to the dexos1 <sup>®</sup> specification of the proper SAE viscosity grade. ACDelco dexos1 Synthetic Blend is recommended. See <i>Engine Oil on page 10-6</i> .
Engine Coolant	50/50 mixture of clean, drinkable water and use only DEX-COOL Coolant. See <i>Engine Coolant on page 10-12</i> .
Hydraulic Brake System	DOT 4 Hydraulic Brake Fluid (GM Part No. 19299570).
Windshield Washer	Automotive windshield washer fluid that meets regional freeze protection requirements.
Automatic Transmission	DEXRON <sup>®</sup> -VI Automatic Transmission Fluid.
Rear Axle	Castrol SAF Carbon Modified SAE 75W/85 API GL5 Differential Oil (GM Part No. 92184900).
Key Lock Cylinders	Multi-Purpose Lubricant, Superlube (GM Part No. 12346241).
Hood Latch Assembly, Secondary Latch, Pivots, Spring Anchor, and Release Pawl	Lubriplate Lubricant Aerosol (GM Part No. 89021668) or lubricant meeting requirements of NLGI #2, Category LB or GC-LB.
Hood and Door Hinges	Multi-Purpose Lubricant, Superlube (GM Part No. 12346241).
Weatherstrip Conditioning	Weatherstrip Lubricant (GM Part No. 3634770) or Dielectric Silicone Grease (GM Part No. 12345579).



## Maintenance Replacement Parts

Replacement parts identified below by name, part number, or specification can be obtained from your dealer.

Part	GM Part Numbers	ACDelco Part Numbers
Engine Air Cleaner/Filter	92066873	A3149C
Engine Oil Filter	89017524	PF48
Passenger Compartment Air Filter	92184248	CF182
Spark Plugs	12621258	41-110
Wiper Blades		
Driver Side	92219233	—
Passenger Side	92219234	—







## Technical Data

### Vehicle Identification

Vehicle Identification	
Number (VIN) .....	12-1
Service Parts Identification	
Label .....	12-1

### Vehicle Data

Capacities and	
Specifications .....	12-2
Engine Drive Belt Routing ...	12-3

## Vehicle Identification

### Vehicle Identification Number (VIN)



This legal identifier is in the front corner of the instrument panel, on the left side of the vehicle. It can be seen through the windshield from outside. The VIN also appears on the Vehicle Certification and Service Parts labels and certificates of title and registration.

### Engine Identification

The eighth character in the VIN is the engine code. This code identifies the vehicle's engine, specifications, and replacement parts. See "Engine Specifications" under *Capacities and Specifications* on page 12-2 for the vehicle's engine code.

### Service Parts Identification Label

This label, on the rear load floor, behind the spare tire tub, has the following information:

- Vehicle Identification Number (VIN).
- Model designation.
- Paint information.
- Production options and special equipment.

Do not remove this label from the vehicle.

### Vehicle Data

#### Capacities and Specifications

The following approximate capacities are given in English and metric conversions. See *Recommended Fluids and Lubricants* on page 11-12.

Application	Capacities	
	Metric	English
Air Conditioning Refrigerant	For the air conditioning system refrigerant charge type and amount, see the refrigerant label under the hood. See your dealer for more information.	
Engine Cooling System	10.5 L	11.0 qt
Engine Oil with Filter	7.6 L	8.0 qt
Fuel Tank	71 L	19 gal
Rear Axle Fluid	1.25 L	1.3 qt
Wheel Nut Torque	190 N•m	140 lb ft

All capacities are approximate. When adding, be sure to fill to the approximate level, as recommended in this manual. Recheck fluid level after filling.

**Engine Specifications**

Engine	VIN Code	Transmission	Spark Plug Gap
6.2L V8 (LS3)	W	Automatic	0.95–1.10 mm (0.037–0.043 in)

**Engine Drive Belt Routing**

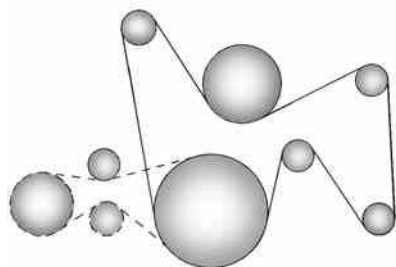





## Customer Information

### Customer Information

Customer Satisfaction Procedure .....	13-1
Customer Assistance Offices .....	13-3
Customer Assistance for Text Telephone (TTY) Users .....	13-4
Online Owner Center .....	13-4
GM Mobility Reimbursement Program .....	13-5
Roadside Assistance Program .....	13-5
Scheduling Service Appointments .....	13-7
Courtesy Transportation Program .....	13-7
Collision Damage Repair .....	13-9
Service Publications Ordering Information .....	13-11

### Reporting Safety Defects

Reporting Safety Defects to the United States Government .....	13-12
Reporting Safety Defects to the Canadian Government .....	13-13
Reporting Safety Defects to General Motors .....	13-13

### Vehicle Data Recording and Privacy

Vehicle Data Recording and Privacy .....	13-13
Event Data Recorders .....	13-14
OnStar® .....	13-14
Infotainment System .....	13-15
Radio Frequency Identification (RFID) .....	13-15
Radio Frequency Statement .....	13-15

## Customer Information

### Customer Satisfaction Procedure

Your satisfaction and goodwill are important to your dealer and to Chevrolet. Normally, any concerns with the sales transaction or the operation of the vehicle will be resolved by your dealer's sales or service departments. Sometimes, however, despite the best intentions of all concerned, misunderstandings can occur. If your concern has not been resolved to your satisfaction, the following steps should be taken:

**STEP ONE:** Discuss your concern with a member of dealership management. Normally, concerns can be quickly resolved at that level. If the matter has already been reviewed with the sales, service, or parts manager, contact the owner of your dealership or the general manager.

## 13-2 Customer Information

---

**STEP TWO:** If after contacting a member of dealership management, it appears your concern cannot be resolved by your dealership without further help, in the U.S., call the Chevrolet Customer Assistance Center at 1-800-222-1020. In Canada, call General Motors of Canada Customer Care Centre at 1-800-263-3777 (English), or 1-800-263-7854 (French).

We encourage you to call the toll-free number in order to give your inquiry prompt attention. Have the following information available to give the Customer Assistance representative:

- Vehicle Identification Number (VIN). This is available from the vehicle registration or title, or the plate at the top left of the instrument panel and visible through the windshield.
- Dealership name and location.
- Vehicle delivery date and present mileage.

When contacting Chevrolet, remember that your concern will likely be resolved at a dealer's facility. That is why we suggest following Step One first.

**STEP THREE — U.S. Owners:** Both General Motors and your dealer are committed to making sure you are completely satisfied with your new vehicle. However, if you continue to remain unsatisfied after following the procedure outlined in Steps One and Two, you can file with the Better Business Bureau (BBB) Auto Line® Program to enforce your rights.

The BBB Auto Line Program is an out-of-court program administered by the Council of Better Business Bureaus to settle automotive disputes regarding vehicle repairs or the interpretation of the New Vehicle Limited Warranty. Although you may be required to resort to this informal dispute resolution program prior to filing a court action, use of the program is free of charge and your case will generally be heard within

40 days. If you do not agree with the decision given in your case, you may reject it and proceed with any other venue for relief available to you.

You may contact the BBB Auto Line Program using the toll-free telephone number or write them at the following address:

BBB Auto Line Program  
Council of Better Business  
Bureaus, Inc.  
4200 Wilson Boulevard  
Suite 800  
Arlington, VA 22203-1838

Telephone: 1-800-955-5100  
[www.dr.bbb.org/goauto](http://www.dr.bbb.org/goauto)

This program is available in all 50 states and the District of Columbia. Eligibility is limited by vehicle age, mileage, and other factors. General Motors reserves the right to change eligibility limitations and/or discontinue its participation in this program.

**STEP THREE — Canadian**

**Owners:** In the event that you do not feel your concerns have been addressed after following the procedure outlined in Steps One and Two, General Motors of Canada Limited wants you to be aware of its participation in a no-charge Mediation/Arbitration Program. General Motors of Canada Limited has committed to binding arbitration of owner disputes involving factory-related vehicle service claims. The program provides for the review of the facts involved by an impartial third party arbiter, and may include an informal hearing before the arbiter. The program is designed so that the entire dispute settlement process, from the time you file your complaint to the final decision, should be completed in about 70 days. We believe our impartial program offers advantages over courts in most jurisdictions because it is informal, quick, and free of charge.

For further information concerning eligibility in the Canadian Motor Vehicle Arbitration Plan (CAMVAP), call toll-free 1-800-207-0685, or call the General Motors Customer Care Centre, 1-800-263-3777 (English), 1-800-263-7854 (French), or write to:

The Mediation/Arbitration Program  
c/o Customer Care Centre  
General Motors of Canada Limited  
Mail Code: CA1-163-005  
1908 Colonel Sam Drive  
Oshawa, Ontario L1H 8P7

Your inquiry should be accompanied by the Vehicle Identification Number (VIN).

**Customer Assistance Offices**

Chevrolet encourages customers to call the toll-free number for assistance. However, if a customer wishes to write or e-mail Chevrolet, the letter should be addressed to:

**United States and Puerto Rico**

Chevrolet Motor Division  
Chevrolet Customer Assistance  
Center  
P.O. Box 33170  
Detroit, MI 48232-5170  
[www.Chevrolet.com](http://www.Chevrolet.com)

1-800-222-1020  
1-800-833-2438 (For Text  
Telephone Devices (TTYs))  
Roadside Assistance:  
1-800-243-8872

From U.S. Virgin Islands:  
1-800-496-9994

## 13-4 Customer Information

---

### Canada

General Motors of Canada Limited  
Customer Care Centre, Mail  
Code: CA1-163-005  
1908 Colonel Sam Drive  
Oshawa, Ontario L1H 8P7  
www.gm.ca

1-800-263-3777 (English)  
1-800-263-7854 (French)  
1-800-263-3830 (For Text  
Telephone devices (TTYs))  
Roadside Assistance:  
1-800-268-6800

### Overseas

Please contact the local General  
Motors Business Unit.

### Customer Assistance for Text Telephone (TTY) Users

To assist customers who are deaf,  
hard of hearing, or speech-impaired  
and who use Text Telephones  
(TTYs), Chevrolet has TTY  
equipment available at its Customer

Assistance Center. Any TTY user in  
the U.S. can communicate with  
Chevrolet by dialing:  
1-800-833-2438. TTY users in  
Canada can dial 1-800-263-3830.

### Online Owner Center

#### Online Owner Experience (U.S.) [my.chevrolet.com](http://my.chevrolet.com)

The Chevrolet online owner  
experience is a one-stop resource  
that allows interaction with  
Chevrolet and keeps important  
vehicle-specific information in one  
place.

#### Membership Benefits

 **(Vehicle Information):**  
Download owner manuals and view  
vehicle-specific how-to videos.

 **(Maintenance Information):**  
View maintenance schedules,  
required alerts, OnStar onboard  
vehicle diagnostic information, and  
schedule service appointments.

 **(Service History):** View  
printable dealer-recorded service  
records and self-recorded service  
records.

 **(Preferred Dealer  
Information):** Select a preferred  
dealer and view dealer location,  
maps, phone numbers, and hours.

 **(Warranty Tracking  
Information):** Track the vehicle's  
warranty information.

 **(Recall Information):** View  
active recalls or search by Vehicle  
Identification Number (VIN). See  
*Vehicle Identification Number (VIN)*  
on page 12-1.

 **(Other Account Information):**  
View GM Card, SiriusXM Satellite  
radio, and OnStar account  
information.

 **(Live Chat Support):** Chat live  
with online help representatives.

Visit [my.chevrolet.com](http://my.chevrolet.com) to register  
your vehicle.

## Chevrolet Owner Centre (Canada) [chevroletowner.ca](http://chevroletowner.ca)

Take a trip to the Chevrolet Owner Centre:

- Chat live with online help representatives.
- Use the Vehicle Tools section.
- Access third party enthusiast sites and social media networks.
- Locate owner resources such as lease-end, financing, and warranty information.
- Retrieve your favorite articles, quizzes, tips, and multimedia galleries organized into the Features and Auto Care Sections.
- Download the owner manual for your vehicle, quickly and easily.
- Find the Chevrolet-recommended maintenance services for your vehicle.

## GM Mobility Reimbursement Program



This program is available to qualified applicants for cost reimbursement of eligible aftermarket adaptive equipment required for the vehicle, such as hand controls or a wheelchair/scooter lift for the vehicle.

For more information on the limited offer, visit [www.gmmobility.com](http://www.gmmobility.com) or call the GM Mobility Assistance Center at 1-800-323-9935. Text Telephone (TTY) users, call 1-800-833-9935.

General Motors of Canada also has a Mobility Program. Visit [www.gm.ca](http://www.gm.ca) or call 1-800-GM-DRIVE (463-7483) for details. TTY users call 1-800-263-3830.

## Roadside Assistance Program

For U.S.-purchased vehicles, call 1-800-243-8872; (Text Telephone (TTY): 1-888-889-2438).

For Canadian-purchased vehicles, call 1-800-268-6800.

Service is available 24 hours a day, 365 days a year.

### Calling for Assistance

When calling Roadside Assistance, have the following information ready:

- Your name, home address, and home telephone number.
- Telephone number of your location.
- Location of the vehicle.

## 13-6 Customer Information

---

- Model, year, color, and license plate number of the vehicle.
- Odometer reading, Vehicle Identification Number (VIN), and delivery date of the vehicle.
- Description of the problem.

### Coverage

Services are provided up to 5 years/160 000 km (100,000 mi), whichever comes first.

In the U.S., anyone driving the vehicle is covered. In Canada, a person driving the vehicle without permission from the owner is not covered.

Roadside Assistance is not a part of the New Vehicle Limited Warranty. Chevrolet and General Motors of Canada Limited reserve the right to make any changes or discontinue the Roadside Assistance program at any time without notification.

Chevrolet and General Motors of Canada Limited reserve the right to limit services or payment to an owner or driver if they decide the

claims are made too often, or the same type of claim is made many times.

### Services Provided

- **Emergency Fuel Delivery:** Delivery of enough fuel for the vehicle to get to the nearest service station.
- **Lock-Out Service:** Service to unlock the vehicle if you are locked out. A remote unlock may be available if you have OnStar. For security reasons, the driver must present identification before this service is given.
- **Emergency Tow from a Public Road or Highway:** Tow to the nearest Chevrolet dealer for warranty service, or if the vehicle was in a crash and cannot be driven. Assistance is also given when the vehicle is stuck in the sand, mud, or snow.
- **Flat Tire Change:** Service to change a flat tire with the spare tire. The spare tire, if equipped,

must be in good condition and properly inflated. It is the owner's responsibility for the repair or replacement of the tire if it is not covered by the warranty.

- **Battery Jump Start:** Service to jump start a dead battery.

### Services Not Included in Roadside Assistance

- Impound towing caused by violation of any laws.
- Legal fines.
- Mounting, dismounting, or changing of snow tires, chains, or other traction devices.
- Towing or services for vehicles driven on a non-public road or highway.

### Services Specific to Canadian-Purchased Vehicles

- **Fuel Delivery:** Reimbursement is approximately \$5 Canadian. Diesel fuel delivery may be

restricted. Propane and other fuels are not provided through this service.

- **Lock-Out Service:** Vehicle registration is required.
- **Trip Interruption Benefits and Assistance:** Must be over 250 kilometers from where your trip was started to qualify. General Motors of Canada Limited requires pre-authorization, original detailed receipts, and a copy of the repair orders. Once authorization has been received, the Roadside Assistance advisor will help to make arrangements and explain how to receive payment.
- **Alternative Service:** If assistance cannot be provided right away, the Roadside Assistance advisor may give permission to get local emergency road service. You will receive payment, up to \$100, after sending the original receipt

to Roadside Assistance. Mechanical failures may be covered, however any cost for parts and labor for repairs not covered by the warranty are the owner responsibility.

## Scheduling Service Appointments

When the vehicle requires warranty service, contact your dealer and request an appointment. By scheduling a service appointment and advising the service consultant of your transportation needs, your dealer can help minimize your inconvenience.

If the vehicle cannot be scheduled into the service department immediately, keep driving it until it can be scheduled for service, unless, of course, the problem is safety related. If it is, please call your dealership, let them know this, and ask for instructions.

If your dealer requests you to bring the vehicle for service, you are urged to do so as early in the work day as possible to allow for same-day repair.

## Courtesy Transportation Program

To enhance your ownership experience, we and our participating dealers are proud to offer Courtesy Transportation, a customer support program for vehicles with the Bumper-to-Bumper (Base Warranty Coverage period in Canada), extended powertrain, and/or hybrid-specific warranties in both the U.S. and Canada.

Several Courtesy Transportation options are available to assist in reducing inconvenience when warranty repairs are required.

Courtesy Transportation is not a part of the New Vehicle Limited Warranty. A separate booklet entitled "Limited Warranty and Owner Assistance Information"

## 13-8 Customer Information

---

furnished with each new vehicle provides detailed warranty coverage information.

### Transportation Options

Warranty service can generally be completed while you wait. However, if you are unable to wait, GM helps to minimize inconvenience by providing several transportation options. Depending on the circumstances, your dealer can offer one of the following:

#### Shuttle Service

Shuttle service is the preferred means of offering Courtesy Transportation. Dealers may provide shuttle service to get you to your destination with minimal interruption of your daily schedule. This includes one-way or round-trip shuttle service within reasonable time and distance parameters of your dealer's area.

#### Public Transportation or Fuel Reimbursement

If the vehicle requires overnight warranty repairs, and public transportation is used instead of your dealer's shuttle service, the expense must be supported by original receipts and can only be up to the maximum amount allowed by GM for shuttle service. In addition, for U.S. customers, should you arrange transportation through a friend or relative, limited reimbursement for reasonable fuel expenses may be available. Claim amounts should reflect actual costs and be supported by original receipts. See your dealer for information regarding the allowance amounts for reimbursement of fuel or other transportation costs.

#### Courtesy Rental Vehicle

Your dealer may arrange to provide you with a courtesy rental vehicle or reimburse you for a rental vehicle that you obtain if the vehicle is kept for an overnight warranty repair.

Rental reimbursement will be limited and must be supported by original receipts. This requires that you sign and complete a rental agreement and meet state/provincial, local, and rental vehicle provider requirements. Requirements vary and may include minimum age requirements, insurance coverage, credit card, etc. You are responsible for fuel usage charges and may also be responsible for taxes, levies, usage fees, excessive mileage, or rental usage beyond the completion of the repair.

It may not be possible to provide a like vehicle as a courtesy rental.

#### Additional Program Information

All program options, such as shuttle service, may not be available at every dealer. Please contact your dealer for specific information about availability. All Courtesy Transportation arrangements will be administered by appropriate dealer personnel.



*General Motors reserves the right to unilaterally modify, change, or discontinue Courtesy Transportation at any time and to resolve all questions of claim eligibility pursuant to the terms and conditions described herein at its sole discretion.*

## **Collision Damage Repair**

If the vehicle is involved in a collision and it is damaged, have the damage repaired by a qualified technician using the proper equipment and quality replacement parts. Poorly performed collision repairs diminish the vehicle resale value, and safety performance can be compromised in subsequent collisions.

### **Collision Parts**

Genuine GM Collision parts are new parts made with the same materials and construction methods as the parts with which the vehicle was originally built. Genuine GM Collision parts are the best choice to

ensure that the vehicle's designed appearance, durability, and safety are preserved. The use of Genuine GM parts can help maintain the GM New Vehicle Limited Warranty.

Recycled original equipment parts may also be used for repair. These parts are typically removed from vehicles that were total losses in prior crashes. In most cases, the parts being recycled are from undamaged sections of the vehicle. A recycled original equipment GM part may be an acceptable choice to maintain the vehicle's originally designed appearance and safety performance; however, the history of these parts is not known. Such parts are not covered by the GM New Vehicle Limited Warranty, and any related failures are not covered by that warranty.

Aftermarket collision parts are also available. These are made by companies other than GM and may not have been tested for the vehicle. As a result, these parts may fit poorly, exhibit premature durability/

corrosion problems, and may not perform properly in subsequent collisions. Aftermarket parts are not covered by the GM New Vehicle Limited Warranty, and any vehicle failure related to such parts is not covered by that warranty.

### **Repair Facility**

GM also recommends that you choose a collision repair facility that meets your needs before you ever need collision repairs. Your dealer may have a collision repair center with GM-trained technicians and state-of-the-art equipment, or be able to recommend a collision repair center that has GM-trained technicians and comparable equipment.

### **Insuring the Vehicle**

Protect your investment in the GM vehicle with comprehensive and collision insurance coverage. There are significant differences in the quality of coverage afforded by various insurance policy terms.

## 13-10 Customer Information

---

Many insurance policies provide reduced protection to the GM vehicle by limiting compensation for damage repairs through the use of aftermarket collision parts. Some insurance companies will not specify aftermarket collision parts. When purchasing insurance, we recommend that you ensure that the vehicle will be repaired with GM original equipment collision parts. If such insurance coverage is not available from your current insurance carrier, consider switching to another insurance carrier.

If the vehicle is leased, the leasing company may require you to have insurance that ensures repairs with Genuine GM Original Equipment Manufacturer (OEM) parts or Genuine Manufacturer replacement parts. Read the lease carefully, as you may be charged at the end of the lease for poor quality repairs.

### If a Crash Occurs

If there has been an injury, call emergency services for help. Do not leave the scene of a crash until all matters have been taken care of. Move the vehicle only if its position puts you in danger, or you are instructed to move it by a police officer.

Give only the necessary information to police and other parties involved in the crash.

For emergency towing see *Roadside Assistance Program on page 13-5*.

Gather the following information:

- Driver name, address, and telephone number.
- Driver license number.
- Owner name, address, and telephone number.
- Vehicle license plate number.
- Vehicle make, model, and model year.

- Vehicle Identification Number (VIN).
- Insurance company and policy number.
- General description of the damage to the other vehicle.

Choose a reputable repair facility that uses quality replacement parts. See “Collision Parts” earlier in this section.

If the airbag has inflated, see *What Will You See after an Airbag Inflates?* on page 3-19.

### Managing the Vehicle Damage Repair Process

In the event that the vehicle requires damage repairs, GM recommends that you take an active role in its repair. If you have a pre-determined repair facility of choice, take the vehicle there, or have it towed there. Specify to the facility that any required replacement collision parts be original equipment parts, either new Genuine GM parts or recycled

original GM parts. Remember, recycled parts will not be covered by the GM vehicle warranty.

Insurance pays the bill for the repair, but you must live with the repair. Depending on your policy limits, your insurance company may initially value the repair using aftermarket parts. Discuss this with the repair professional, and insist on Genuine GM parts. Remember, if the vehicle is leased, you may be obligated to have the vehicle repaired with Genuine GM parts, even if your insurance coverage does not pay the full cost.

If another party's insurance company is paying for the repairs, you are not obligated to accept a repair valuation based on that insurance company's collision policy repair limits, as you have no contractual limits with that company. In such cases, you can have control of the repair and parts choices as long as the cost stays within reasonable limits.

## Service Publications Ordering Information

### Service Manuals

Service Manuals have the diagnosis and repair information on the engines, transmission, axle, suspension, brakes, electrical, steering, body, etc.

### Service Bulletins

Service Bulletins give additional technical service information needed to knowledgeable service General Motors cars and trucks. Each bulletin contains instructions to assist in the diagnosis and service of the vehicle.

### Owner Information

Owner publications are written specifically for owners and intended to provide basic operational information about the vehicle. The Owner Manual includes the Maintenance Schedule for all models.

In-Portfolio: Includes a Portfolio, Owner Manual, and Warranty Manual.

RETAIL SELL PRICE:  
\$35.00 (U.S.) plus handling and shipping fees.

Without Portfolio: Owner Manual only.

RETAIL SELL PRICE:  
\$25.00 (U.S.) plus handling and shipping fees.

### Current and Past Models

Technical Service Bulletins and Manuals are available for current and past model GM vehicles.

ORDER TOLL FREE:  
1-800-551-4123 Monday – Friday  
8:00 AM – 6:00 PM Eastern Time

For Credit Card Orders Only  
(VISA-MasterCard-Discover), see  
Helm, Inc. at: [www.helminc.com](http://www.helminc.com).

Or write to:

Helm, Incorporated  
Attention: Customer Service  
47911 Halyard Drive  
Plymouth, MI 48170

Prices are subject to change without notice and without incurring obligation. Allow ample time for delivery.

All listed prices are quoted in U.S. funds. Make checks payable in U.S. funds.

### **Reporting Safety Defects**

#### **Reporting Safety Defects to the United States Government**

If you believe that your vehicle has a defect which could cause a crash or could cause injury or death, you should immediately inform the National Highway Traffic Safety Administration (NHTSA) in addition to notifying General Motors.

If NHTSA receives similar complaints, it may open an investigation, and if it finds that a safety defect exists in a group of vehicles, it may order a recall and remedy campaign.

However, NHTSA cannot become involved in individual problems between you, your dealer, or General Motors.

To contact NHTSA, you may call the Vehicle Safety Hotline toll-free at 1-888-327-4236 (TTY: 1-800-424-9153); go to <http://www.safercar.gov>; or write to:

Administrator, NHTSA  
1200 New Jersey Avenue, S.E.  
Washington, D.C. 20590

You can also obtain other information about motor vehicle safety from <http://www.safercar.gov>.

## Reporting Safety Defects to the Canadian Government

If you live in Canada, and you believe that the vehicle has a safety defect, notify Transport Canada immediately, and notify General Motors of Canada Limited. Call Transport Canada at 1-800-333-0510 or write to:

Transport Canada  
Road Safety Branch  
80 rue Noel  
Gatineau, QC J8Z 0A1

## Reporting Safety Defects to General Motors

In addition to notifying NHTSA (or Transport Canada) in a situation like this, notify General Motors.

Call 1-800-222-1020, or write:

Chevrolet Motor Division  
Chevrolet Customer Assistance  
Center  
P.O. Box 33170  
Detroit, MI 48232-5170

In Canada, call 1-800-263-3777  
(English) or 1-800-263-7854  
(French), or write:

General Motors of Canada Limited  
Customer Care Centre, Mail  
Code: CA1-163-005  
1908 Colonel Sam Drive  
Oshawa, Ontario L1H 8P7

## Vehicle Data Recording and Privacy

The vehicle has a number of computers that record information about the vehicle's performance and how it is driven. For example, the vehicle uses computer modules to monitor and control engine and transmission performance, to monitor the conditions for airbag deployment and deploy them in a crash, and, if equipped, to provide antilock braking to help the driver control the vehicle. These modules may store data to help the dealer technician service the vehicle. Some modules may also store data about how the vehicle is operated, such as rate of fuel consumption or average speed. These modules may retain personal preferences, such as radio presets, seat positions, and temperature settings.

### Event Data Recorders

This vehicle is equipped with an event data recorder (EDR). The main purpose of an EDR is to record, in certain crash or near crash-like situations, such as an air bag deployment or hitting a road obstacle, data that will assist in understanding how a vehicle's systems performed. The EDR is designed to record data related to vehicle dynamics and safety systems for a short period of time, typically 30 seconds or less. The EDR in this vehicle is designed to record such data as:

- How various systems in your vehicle were operating;
- Whether or not the driver and passenger safety belts were buckled/fastened;
- How far (if at all) the driver was depressing the accelerator and/or brake pedal; and,
- How fast the vehicle was traveling.

These data can help provide a better understanding of the circumstances in which crashes and injuries occur. NOTE: EDR data are recorded by your vehicle only if a non-trivial crash situation occurs; no data are recorded by the EDR under normal driving conditions and no personal data (e.g., name, gender, age, and crash location) are recorded. However, other parties, such as law enforcement, could combine the EDR data with the type of personally identifying data routinely acquired during a crash investigation.

To read data recorded by an EDR, special equipment is required, and access to the vehicle or the EDR is needed. In addition to the vehicle manufacturer, other parties, such as law enforcement, that have the special equipment, can read the information if they have access to the vehicle or the EDR.

GM will not access this data or share it with others except: with the consent of the vehicle owner or,

if the vehicle is leased, with the consent of the lessee; in response to an official request by police or similar government office; as part of GM's defense of litigation through the discovery process; or, as required by law. Data that GM collects or receives may also be used for GM research needs or may be made available to others for research purposes, where a need is shown and the data is not tied to a specific vehicle or vehicle owner.

### OnStar®

If the vehicle is equipped with OnStar® and has an active subscription, additional data may be collected through the OnStar system. This includes information about the vehicle's operation; collisions involving the vehicle; the use of the vehicle and its features; and, in certain situations, the location and approximate GPS speed of the vehicle. Refer to the

OnStar Terms and Conditions and Privacy Statement on the OnStar website.

## Infotainment System

Using the navigation system may result in the storage of destinations, addresses, telephone numbers, and other trip information. See the infotainment manual for information on stored data and for deletion instructions.

## Radio Frequency Identification (RFID)

RFID technology is used in some vehicles for functions such as tire pressure monitoring and ignition system security, as well as in connection with conveniences such as Remote Keyless Entry (RKE) transmitters for remote door locking/unlocking and starting, and in-vehicle transmitters for garage door openers. RFID technology in GM vehicles does not use or record

personal information or link with any other GM system containing personal information.

## Radio Frequency Statement

This vehicle has systems that operate on a radio frequency that comply with Part 15 of the Federal Communications Commission (FCC) rules and with Industry Canada Standards RSS-GEN/210/220/310.

Operation is subject to the following two conditions:

1. The device may not cause harmful interference.
2. The device must accept any interference received, including interference that may cause undesired operation of the device.

Changes or modifications to any of these systems by other than an authorized service facility could void authorization to use this equipment.





# OnStar

## OnStar Overview

OnStar Overview ..... 14-1

## OnStar Services

Emergency ..... 14-2  
 Security ..... 14-2  
 Navigation ..... 14-2  
 Connections ..... 14-3  
 Diagnostics ..... 14-5

## OnStar Additional Information

OnStar Additional Information ..... 14-5

## OnStar Overview



If equipped, this vehicle has a comprehensive, in-vehicle system that can connect to a live Advisor for Emergency, Security, Navigation, Connection, and Diagnostic Services.

The OnStar system status light is next to the OnStar buttons. If the status light is:

- Solid Green: System is ready.
- Flashing Green: On a call.
- Red: Indicates a problem.

Press or call 1-888-4-ONSTAR (1-888-466-7827) to speak to an Advisor.

Press to:

- Make a call, end a call, or answer an incoming call.
- Give OnStar Hands-Free Calling voice commands.
- Give OnStar Turn-by-Turn Navigation voice commands. Requires the available Directions and Connections service plan.

Press to connect to a live Advisor to:

- Verify account information or update contact information.
- Get driving directions. Requires the available Directions and Connections service plan.
- Receive On-Demand Diagnostics for a check of the vehicle's key operating systems.
- Receive Roadside Assistance.

Press the OnStar Emergency button  to get a priority connection to an Emergency Advisor available 24/7 to:

- Get help for an emergency.
- Be a Good Samaritan or respond to an AMBER Alert.
- Get assistance in severe weather or other crisis and evacuation routes.

## OnStar Services

### Emergency

With Automatic Crash Response, the built-in system can automatically connect to help in most crashes, even if help cannot be requested.

Press  to connect to an Emergency Advisor. GPS technology is used to identify the vehicle location and can provide critical information to emergency personnel. The Advisor is also trained to offer critical assistance in emergency situations.

### Security

OnStar provides services like Stolen Vehicle Assistance, Remote Ignition Block, and Roadside Assistance, if equipped. OnStar can unlock the vehicle doors remotely, if equipped with automatic door locks, and can help police locate the vehicle if it is stolen.

## Navigation

OnStar navigation requires the Directions and Connections service plan.

Press  to receive directions or have them sent to the vehicle navigation screen, if equipped. Destinations can also be forwarded to the vehicle from MapQuest.com. The OnStar mapping database is continuously updated. For coverage maps, see [www.onstar.com](http://www.onstar.com) (U.S.) or [www.onstar.ca](http://www.onstar.ca) (Canada).

### Turn-by-Turn Navigation

1. Press  to connect to a live Advisor.
2. Request directions.
3. Directions are downloaded to the vehicle.
4. Follow the voice-guided commands.

## Using Voice Commands During a Planned Route

### Cancel Route

1. Press . System responds: "OnStar ready," then a tone. Say "Cancel route." System responds: "Do you want to cancel directions?"
2. Say "Yes." System responds: "OK, request completed, thank you, goodbye."

### Route Preview

1. Press . System responds: "OnStar ready," then a tone.
2. Say "Route preview." System responds with the next three maneuvers.

### Repeat

1. Press . System responds: "OnStar ready," then a tone.

2. Say "Repeat." System responds with the last direction given, then responds with "OnStar ready," then a tone.

### Get My Destination

1. Press . System responds: "OnStar ready," then a tone.
2. Say "Get my destination." System responds with the address and the distance to the destination, then responds with "OnStar ready," then a tone.

### Other Navigation Services Available from OnStar

**OnStar eNav:** Allows subscribers to send destinations from MapQuest.com to their Turn-by-Turn Navigation or screen-based navigation system. When ready, the directions will be downloaded to the vehicle.

**Destination Download:** Press , then request the Advisor to download directions to the navigation system in the vehicle.

After the call ends, press the "Go" button on the navigation screen to begin driving directions.

If directions are downloaded to the navigation system, the route can only be canceled through the navigation system.

Destinations can also be downloaded on the go. For information about eNav, Destination Download, and coverage maps see [www.onstar.com](http://www.onstar.com) (U.S.) or [www.onstar.ca](http://www.onstar.ca) (Canada).

### Connections

OnStar Hands-Free Calling allows calls to be made and received from the vehicle. The vehicle can also be controlled through the OnStar RemoteLink<sup>®</sup> mobile app. For coverage maps, see [www.onstar.com](http://www.onstar.com) (U.S.) or [www.onstar.ca](http://www.onstar.ca) (Canada).

### OnStar Mobile App

Download the OnStar RemoteLink mobile app to select Apple<sup>®</sup>, Android<sup>™</sup>, and BlackBerry<sup>®</sup> devices to check vehicle fuel level, oil life, or tire pressure; to start the vehicle (if equipped) or unlock it; or to connect to an OnStar Advisor. For OnStar RemoteLink information and compatibility, see [www.onstar.com](http://www.onstar.com) (U.S.) or [www.onstar.ca](http://www.onstar.ca) (Canada).

### Hands-Free Calling

1. Press . System responds: "OnStar ready."
2. Say "Call." System responds: "Please say the name or number to call."
3. Say the entire number without pausing, including a "1" and the area code. System responds: "OK calling."

### Calling 911 Emergency

1. Press . System responds: "OnStar ready," followed by a tone.
2. Say "Call." System responds: "Please say the name or number to call."
3. Say "911" without pausing. System responds: "911."
4. Say "Call." System responds: "OK, dialing 911."

### Retrieve My Number

1. Press . System responds: "OnStar ready."
2. Say "My number." System responds: "Your OnStar Hands-Free Calling number is," then says the number.

### End a Call

Press . System responds: "Call ended."

### Store a Name Tag for Speed Dialing

1. Press . System responds: "OnStar ready."
2. Say "Store." System responds: "Please say the number you would like to store."
3. Say the entire number without pausing. System responds: "Please say the name tag."
4. Pick a name tag. System responds: "About to store <name tag>. Does that sound OK?"
5. Say "Yes" or say "No" to try again. System responds: "OK, storing <name tag>."

### Place a Call Using a Stored Number

1. Press . System responds: "OnStar ready."
2. Say "Call <name tag>." System responds: "OK, calling <name tag>."

## Verify Minutes and Expiration

Press  and say “Minutes” then “Verify” to check how many minutes remain and their expiration date.

## Diagnostics

OnStar Vehicle Diagnostics will perform a vehicle check every month. It will check the engine, transmission, antilock brakes, and major vehicle systems. It also checks the tire pressures, if the vehicle is equipped with the Tire Pressure Monitoring System. If an On-Demand Diagnostics check is needed between e-mails, press , and an Advisor can run a check.

## OnStar Additional Information

### Transferring Service

Press  to request account transfer eligibility information. The Advisor can assist in canceling or removing account information. If OnStar receives information that vehicle ownership has changed, OnStar may send a voice message to the vehicle, requesting updated account information.

### Reactivation for Subsequent Owners

Press  and follow the prompts to speak to an Advisor as soon as possible after acquiring the vehicle. The Advisor will update vehicle records and will explain the OnStar service offers and options available.

## How OnStar Service Works

Automatic Crash Response, Emergency Services, Crisis Assist, Stolen Vehicle Assistance, Vehicle Diagnostics, Remote Door Unlock, Roadside Assistance, Turn-by-Turn Navigation, and Hands-Free Calling are available on most vehicles. Not all OnStar services are available everywhere or on all vehicles. For more information, a full description of OnStar services, system limitations, and OnStar terms and conditions:

- Call 888-4-ONSTAR (888-466-7827).
- See [www.onstar.com](http://www.onstar.com) (U.S.).
- See [www.onstar.ca](http://www.onstar.ca) (Canada).
- Call TTY 1-877-248-2080.
- Press  to speak with an Advisor.

OnStar services require a vehicle electrical system, wireless service, and GPS satellite technologies to be available and operating for features

to function properly. These systems may not operate if the battery is discharged or disconnected.

OnStar service cannot work unless your vehicle is in a place where OnStar has an agreement with a wireless service provider for service in that area, and the wireless service provider has coverage, network capacity, reception, and technology compatible with OnStar service. Service involving location information about the vehicle cannot work unless GPS signals are available, unobstructed, and compatible with the OnStar hardware. OnStar service may not work if the OnStar equipment is not properly installed or it has not been properly maintained. If equipment or software is added, connected, or modified, OnStar service may not work. Other problems beyond the control of OnStar may prevent service such as hills, tall buildings, tunnels, weather, electrical system design and architecture of the

vehicle, damage to the vehicle in a crash, or wireless phone network congestion or jamming.

See *Radio Frequency Statement on page 13-15*.

### Services for People with Disabilities

Advisors provide services to help subscribers with physical disabilities and medical conditions.

Press  for help with:

- Locating a gas station with an attendant to pump gas.
- Finding a hotel, restaurant, etc., that meets accessibility needs.
- Providing directions to the closest hospital or pharmacy in urgent situations.

### TTY Users

OnStar has the ability to communicate to the deaf, hard-of-hearing, or speech-impaired customers while in the vehicle. The available dealer-installed TTY

system can provide in-vehicle access to all of the OnStar services, except Virtual Advisor and OnStar Turn-by-Turn Navigation.

### OnStar.com (U.S.) or OnStar.ca (Canada)

The website provides access to account information, allows management of the OnStar subscription, and viewing of videos of each service. Get subscription plan pricing and sign up for OnStar Vehicle Diagnostics. Click on the “My Account” tab on the home page. The website navigation and services provided may vary by country.

### OnStar Personal Identification Number (PIN)

A PIN is needed to access some of the OnStar services, like Remote Door Unlock and Stolen Vehicle Assistance. You will be prompted to change the PIN the first time when speaking with an Advisor. To

change the OnStar PIN, call OnStar and provide the Advisor with the current number.

### **Warranty**

OnStar equipment may be warranted as part of the New Vehicle Limited Warranty. The manufacturer of the vehicle furnishes detailed warranty information.

### **Languages**

The vehicle can be programmed to respond in multiple languages. Press  and ask an Advisor. Advisors are available in English, Spanish and French. Available languages may vary by country.

### **Potential Issues**

OnStar cannot perform Remote Door Unlock or Stolen Vehicle Assistance after the vehicle has been off continuously for five days. After five days, OnStar can contact

Roadside Assistance and a locksmith to help gain access to the vehicle.

### **Global Positioning System (GPS)**

- Obstruction of the GPS can occur in a large city with tall buildings; in parking garages; around airports; in tunnels, underpasses, or parking garages; or in an area with very dense trees. If GPS signals are not available, the OnStar system should still operate to call OnStar. However, OnStar could have difficulty identifying the exact location.
- In emergency situations, OnStar can use the last stored GPS location to send to emergency responders.
- A temporary loss of GPS can cause loss of the ability to send a Turn-by-Turn Navigation route. The Advisor may give a verbal

route or may ask for a call back after the vehicle is driven into an open area.

### **Cellular and GPS Antennas**

Avoid placing items over or near the antenna to prevent blocking cellular and GPS signal reception. Cellular reception is required for OnStar to send remote signals to the vehicle.

### **Unable to Connect to OnStar Message**

If there is limited cellular coverage or the cellular network has reached maximum capacity, this message may come on. Press  to try the call again or try again after driving a few miles into another cellular area.

### **Vehicle and Power Issues**

OnStar services require a vehicle electrical system, wireless service, and GPS satellite technologies to be available and operating for features to function properly. These systems may not operate if the battery is discharged or disconnected.

### Add-on Electrical Equipment

The OnStar system is integrated into the electrical architecture of the vehicle. Do not add any electrical equipment. See *Add-On Electrical Equipment on page 9-50*. Added electrical equipment may interfere with the operation of the OnStar system and cause it to not operate.

### Privacy

The complete OnStar Privacy Statement may be found at [www.onstar.com](http://www.onstar.com) (U.S.), or [www.onstar.ca](http://www.onstar.ca) (Canada). Privacy-sensitive users of wireless communications are cautioned that the privacy of any information sent via wireless cellular communications cannot be assured. Third parties may unlawfully intercept or access transmissions and private communications without consent.

### OnStar - libcurl and unzip acknowledgments

Certain OnStar components include libcurl and unzip software. Below are the notices and licenses associated with this software:

#### libcurl:

#### COPYRIGHT AND PERMISSION NOTICE

Copyright (c) 1996 - 2010, Daniel Stenberg, <daniel@haxx.se>.

All rights reserved.

Permission to use, copy, modify, and distribute this software for any purpose with or without fee is hereby granted, provided that the above copyright notice and this permission notice appear in all copies.

THE SOFTWARE IS PROVIDED "AS IS," WITHOUT WARRANTY OF ANY KIND, EXPRESS OR IMPLIED, INCLUDING BUT NOT LIMITED TO THE WARRANTIES OF MERCHANTABILITY, FITNESS

FOR A PARTICULAR PURPOSE AND NONINFRINGEMENT OF THIRD PARTY RIGHTS. IN NO EVENT SHALL THE AUTHORS OR COPYRIGHT HOLDERS BE LIABLE FOR ANY CLAIM, DAMAGES OR OTHER LIABILITY, WHETHER IN AN ACTION OF CONTRACT, TORT OR OTHERWISE, ARISING FROM, OUT OF OR IN CONNECTION WITH THE SOFTWARE OR THE USE OR OTHER DEALINGS IN THE SOFTWARE.

Except as contained in this notice, the name of a copyright holder shall not be used in advertising or otherwise to promote the sale, use or other dealings in this Software without prior written authorization of the copyright holder.

#### unzip:

This is version 2005-Feb-10 of the Info-ZIP copyright and license. The definitive version of this document



should be available at <ftp://ftp.info-zip.org/pub/infozip/license.html> indefinitely.

Copyright (c) 1990-2005 Info-ZIP. All rights reserved.

For the purposes of this copyright and license, "Info-ZIP" is defined as the following set of individuals:

Mark Adler, John Bush, Karl Davis, Harald Denker, Jean-Michel Dubois, Jean-loup Gailly, Hunter Goatley, Ed Gordon, Ian Gorman, Chris Herborth, Dirk Haase, Greg Hartwig, Robert Heath, Jonathan Hudson, Paul Kienitz, David Kirschbaum, Johnny Lee, Onno van der Linden, Igor Mandrichenko, Steve P. Miller, Sergio Monesi, Keith Owens, George Petrov, Greg Roelofs, Kai Uwe Rommel, Steve Salisbury, Dave Smith, Steven M. Schweda, Christian Spieler, Cosmin Truta, Antoine Verheijen, Paul von Behren, Rich Wales, Mike White

This software is provided "as is," without warranty of any kind, express or implied. In no event shall

Info-ZIP or its contributors be held liable for any direct, indirect, incidental, special or consequential damages arising out of the use of or inability to use this software.

Permission is granted to anyone to use this software for any purpose, including commercial applications, and to alter it and redistribute it freely, subject to the following restrictions:

1. Redistributions of source code must retain the above copyright notice, definition, disclaimer, and this list of conditions.
2. Redistributions in binary form (compiled executables) must reproduce the above copyright notice, definition, disclaimer, and this list of conditions in documentation and/or other materials provided with the distribution. The sole exception to this condition is redistribution of a standard UnZipSFX binary (including SFXWiz) as part of a self-extracting archive; that is

permitted without inclusion of this license, as long as the normal SFX banner has not been removed from the binary or disabled.

3. Altered versions—including, but not limited to, ports to new operating systems, existing ports with new graphical interfaces, and dynamic, shared, or static library versions—must be plainly marked as such and must not be misrepresented as being the original source. Such altered versions also must not be misrepresented as being Info-ZIP releases—including, but not limited to, labeling of the altered versions with the names "Info-ZIP" (or any variation thereof, including, but not limited to, different capitalizations), "Pocket UnZip," "WiZ" or "MacZip" without the explicit permission of Info-ZIP. Such altered versions are further prohibited from misrepresentative use of the

Zip-Bugs or Info-ZIP e-mail addresses or of the Info-ZIP URL(s).

4. Info-ZIP retains the right to use the names "Info-ZIP," "Zip," "UnZip," "UnZipSFX," "WiZ," "Pocket UnZip," "Pocket Zip," and "MacZip" for its own source and binary releases.

**A**

Accessories and  
Modifications ..... 10-2

Accessory Power ..... 9-18

Add-On Electrical  
Equipment ..... 9-50

Additional Information  
OnStar® ..... 14-5

Adjustments  
Lumbar, Front Seats ..... 3-4

Air Cleaner/Filter, Engine ..... 10-10

Air Filter, Passenger  
Compartment ..... 8-6

Air Vents ..... 8-6

Airbag System  
Check ..... 3-25

How Does an Airbag  
Restrain? ..... 3-18

Passenger Sensing  
System ..... 3-20

What Makes an Airbag  
Inflate? ..... 3-18

Airbag System (cont'd)  
What Will You See after an  
Airbag Inflates? ..... 3-19

When Should an Airbag  
Inflate? ..... 3-17

Where Are the Airbags? ..... 3-15

Airbags  
Adding Equipment to the  
Vehicle ..... 3-25

Passenger Status Indicator ..... 5-11

Readiness Light ..... 5-10

Servicing Airbag-Equipped  
Vehicles ..... 3-24

System Check ..... 3-14

Alarm  
Vehicle Security ..... 2-14

Alert  
Side Blind Zone (SBZA) ..... 9-42

AM-FM Radio ..... 7-11

Antenna  
Multi-band ..... 7-21

Antilock Brake  
System (ABS) ..... 9-26

Warning Light ..... 5-16

Appearance Care  
Exterior ..... 10-72

Interior ..... 10-77

Assistance Program,  
Roadside ..... 13-5

Assistance Systems for  
Driving ..... 9-40

Assistance Systems for  
Parking and Backing ..... 9-36

Audio  
Bluetooth ..... 7-41

Audio Players ..... 7-32

CD ..... 7-32

Audio System  
Backglass Antenna ..... 7-21

Radio Reception ..... 7-20

Automatic  
Dimming Mirrors ..... 2-17

Door Locks ..... 2-11

Headlamp System ..... 6-2

Transmission ..... 9-22

Transmission Fluid ..... 10-9

Automatic Transmission  
Manual Mode ..... 9-24

Shift Lock Control  
Function Check ..... 10-22

Auxiliary  
Devices ..... 7-40

Axle, Rear ..... 10-21

**B**

Battery .....	10-20
Jump Starting .....	10-69
Power Protection .....	6-5
Voltage and Charging Messages .....	5-26
Blade Replacement, Wiper ...	10-23
Bluetooth .....	7-75
Bluetooth Audio .....	7-41
Brake	
Parking, Electric .....	9-27
System Warning Light .....	5-14
Brakes .....	10-18
Antilock .....	9-26
Assist .....	9-29
Fluid .....	10-19
System Messages .....	5-26
Braking .....	9-3
Break-In, New Vehicle .....	9-15
Bulb Replacement .....	10-25
Fog Lamps .....	6-3
Headlamp Aiming .....	10-24
Headlamps .....	10-24
High Intensity Discharge (HID) Lighting .....	10-24
License Plate Lamps .....	10-25

Buying New Tires .....	10-49
------------------------	-------

**C**

California	
Fuel Requirements .....	9-47
Perchlorate Materials Requirements .....	10-2
Warning .....	10-2
Capacities and Specifications .....	12-2
Carbon Monoxide	
Engine Exhaust .....	9-21
Trunk .....	2-12
Winter Driving .....	9-8
Cautions, Danger, and Warnings .....	iii
CD Player .....	7-32
Center Console Storage .....	4-2
Chains, Tire .....	10-53
Charging System Light .....	5-11
Check	
Engine Light .....	5-12
Ignition Transmission Lock .....	10-22

Child Restraints	
Infants and Young Children .....	3-28
Lower Anchors and Tethers for Children .....	3-34
Older Children .....	3-26
Securing .....	3-39, 3-41
Systems .....	3-31
Cleaning	
Exterior Care .....	10-72
Interior Care .....	10-77
Climate Control Systems	
Dual Automatic .....	8-1
Clock .....	5-4
Cluster, Instrument .....	5-7
Collision Damage Repair .....	13-9
Compartments	
Storage .....	4-1
Competitive Driving Mode .....	9-31
Compressor Kit, Tire	
Sealant .....	10-56
Configure Menu .....	7-60
Connections	
OnStar® .....	14-3

Control	
Traction and Electronic	
Stability	9-30
Control of a Vehicle	9-3
Convenience Net	4-3
Convex Mirrors	2-16
Coolant	
Engine	10-12
Engine Temperature Gauge	5-9
Cooling System	10-11
Engine Messages	5-27
Courtesy Transportation	
Program	13-7
Cruise Control	9-32
Light	5-20
Messages	5-27
Cupholders	4-1
Customer Assistance	13-4
Offices	13-3
Text Telephone (TTY)	
Users	13-4
Customer Information	
Service Publications	
Ordering Information	13-11
Customer Satisfaction	
Procedure	13-1

## D

Damage Repair, Collision	13-9
Danger, Warnings, and	
Cautions	iii
Data Recorders, Event	13-14
Database Coverage	
Explanations	7-68
Daytime Running	
Lamps (DRL)	6-2
Defensive Driving	9-3
Delayed Locking	2-11
Destination Download,	
OnStar®	7-59
Destination, Navigation	7-48
Devices	
Auxiliary	7-40
USB	7-34
Diagnostics	
OnStar®	14-5
Distracted Driving	9-2
Dome Lamps	6-4
Door	
Ajjar Light	5-20
Ajjar Messages	5-27
Delayed Locking	2-11

Door (cont'd)	
Locks	2-10
Power Locks	2-11
Rear Seat Pass-Through	3-7
Drive Belt Routing, Engine	12-3
Driver Assistance Systems	9-35
Driver Information	
Center (DIC)	5-21
Driving	
Assistance Systems	9-40
Competitive	9-31
Defensive	9-3
Drunk	9-3
For Better Fuel Economy	1-18
Highway Hypnosis	9-7
Hill and Mountain Roads	9-7
If the Vehicle is Stuck	9-10
Loss of Control	9-5
Off-Road Recovery	9-4
Vehicle Load Limits	9-10
Wet Roads	9-6
Winter	9-8
Dual Automatic Climate	
Control System	8-1

**E**

Electric Parking Brake .....	9-27
Electric Parking Brake Light ...	5-15
Electrical Equipment, Add-On .....	9-50
Electrical System	
Engine Compartment	
Fuse Block .....	10-27
Fuses .....	10-26
Instrument Panel Fuse	
Block .....	10-29
Overload .....	10-26
Rear Compartment Fuse	
Block .....	10-32
Emergency	
OnStar® .....	14-2
Engine	
Air Cleaner/Filter .....	10-10
Check and Service Engine	
Soon Light .....	5-12
Compartment Overview .....	10-5
Coolant .....	10-12
Coolant Temperature Gauge ...	5-9
Cooling System .....	10-11
Cooling System Messages ...	5-27
Drive Belt Routing .....	12-3

**Engine (cont'd)**

Exhaust .....	9-21
Oil Life System .....	10-8
Oil Messages .....	5-28
Overheating .....	10-16
Power Messages .....	5-28
Pressure Light .....	5-18
Running While Parked .....	9-22
Starting .....	9-17
Entry Lighting .....	6-5
Event Data Recorders .....	13-14
Exit Lighting .....	6-5
Extender, Safety Belt .....	3-12
Exterior Lamp Controls .....	6-1

**F****Features**

Memory .....	1-7
Filter,	
Engine Air Cleaner .....	10-10
Flash-to-Pass .....	6-1
Flashers, Hazard Warning .....	6-3
Flat Tire .....	10-54
Changing .....	10-63
Floor Mats .....	10-81

**Fluid**

Automatic Transmission .....	10-9
Brakes .....	10-19
Washer .....	10-17
Fog Lamps	
Bulb Replacement .....	6-3
Folding Mirrors .....	2-17
Forward Collision Alert	
(FCA) System .....	9-40
Forward Collision Alert	
(FCA) Warning Light .....	5-16
Front Fog Lamp	
Light .....	5-20
Front Seats	
Heated and Ventilated .....	3-6
Fuel .....	9-46
Additives .....	9-48
Economy Driving .....	1-18
Filling a Portable Fuel	
Container .....	9-49
Filling the Tank .....	9-48
Foreign Countries .....	9-47
Gasoline Specifications .....	9-47
Gauge .....	5-8
Low Fuel Warning Light .....	5-19

Fuel (cont'd)  
 Recommended ..... 9-46  
 Requirements, California ..... 9-47  
 System Messages ..... 5-28  
 Full-Size Spare Tire ..... 10-68  
 Fuses ..... 10-26  
 Engine Compartment  
 Fuse Block ..... 10-27  
 Instrument Panel Fuse  
 Block ..... 10-29  
 Rear Compartment Fuse  
 Block ..... 10-32

**G**

Gasoline  
 Specifications ..... 9-47  
 Gauges  
 Engine Coolant  
 Temperature ..... 5-9  
 Fuel ..... 5-8  
 Odometer ..... 5-8  
 Speedometer ..... 5-8  
 Tachometer ..... 5-8  
 Trip Odometer ..... 5-8  
 Warning Lights and  
 Indicators ..... 5-6

General Information  
 Service and Maintenance ..... 11-1  
 Vehicle Care ..... 10-2  
 Global Positioning  
 System (GPS) ..... 7-66  
 Glove Box ..... 4-1  
 GM Mobility Reimbursement  
 Program ..... 13-5

**H**

Hazard Warning Flashers ..... 6-3  
 Head Restraints ..... 3-2  
 Head-up Display ..... 5-23  
 Headlamps  
 Aiming ..... 10-24  
 Automatic ..... 6-2  
 Bulb Replacement ..... 10-24  
 Daytime Running  
 Lamps (DRL) ..... 6-2  
 Flash-to-Pass ..... 6-1  
 High Intensity Discharge  
 (HID) Lighting ..... 10-24  
 High-Beam On Light ..... 5-20  
 High/Low Beam Changer ..... 6-1  
 Lamps On Reminder ..... 5-20

Heated and Ventilated Front  
 Seats ..... 3-6  
 Heated Mirrors ..... 2-17  
 High-Beam On Light ..... 5-20  
 Highway Hypnosis ..... 9-7  
 Hill and Mountain Roads ..... 9-7  
 Hill Start Assist (HSA) ..... 9-29  
 Hood ..... 10-4  
 Horn ..... 5-3  
 How to Wear Safety Belts  
 Properly ..... 3-9

**I**

If the System Needs Service ... 7-68  
 Ignition Positions ..... 9-15  
 Ignition Transmission Lock  
 Check ..... 10-22  
 Immobilizer ..... 2-15  
 Indicator  
 Vehicle Ahead ..... 5-17  
 Infants and Young Children,  
 Restraints ..... 3-28  
 Info  
 Quick ..... 7-22  
 Infotainment ..... 7-2  
 Infotainment System ..... 13-15

Instrument Cluster .....	5-7
Instrument Panel Overview .....	1-2
Interior Rearview Mirrors .....	2-17
Internet Radio	
Pandora .....	7-22
Introduction .....	iii

**J**

Jump Starting .....	10-69
---------------------	-------

**K**

Key and Lock Messages .....	5-29
Keyless Entry	
Remote (RKE) System .....	2-3
Keys .....	2-1

**L**

Labeling, Tire Sidewall .....	10-36
Lamps	
Daytime Running (DRL) .....	6-2
Dome .....	6-4
Exterior Controls .....	6-1
License Plate .....	10-25
Malfunction Indicator .....	5-12

Lamps (cont'd)	
Messages .....	5-29
On Reminder .....	5-20
Reading .....	6-4
Lane Departure	
Warning (LDW) .....	9-44
Lane Departure Warning	
Light .....	5-16
Lap-Shoulder Belt .....	3-10
LATCH System	
Replacing Parts after a	
Crash .....	3-39
LATCH, Lower Anchors and	
Tethers for Children .....	3-34
Lighting	
Entry .....	6-5
Exit .....	6-5
Illumination Control .....	6-4
Lights	
Airbag Readiness .....	5-10
Antilock Brake System	
(ABS) Warning .....	5-16
Brake System Warning .....	5-14
Charging System .....	5-11
Cruise Control .....	5-20
Door Ajar .....	5-20
Electric Parking Brake .....	5-15

Lights (cont'd)	
Engine Oil Pressure .....	5-18
Flash-to-Pass .....	6-1
Front Fog Lamp .....	5-20
High-Beam On .....	5-20
High/Low Beam Changer .....	6-1
Lane Departure Warning .....	5-16
Low Fuel Warning .....	5-19
Safety Belt Reminders .....	5-9
Security .....	5-19
Service Electric Parking	
Brake .....	5-15
Service Vehicle Soon .....	5-14
StabiliTrak® OFF .....	5-17
Tire Pressure .....	5-18
Traction Control System	
(TCS)/StabiliTrak® .....	5-18
Traction Off .....	5-17
Limited-Slip Rear Axle .....	9-32
Locks	
Automatic Door .....	2-11
Delayed Locking .....	2-11
Door .....	2-10
Lockout Protection .....	2-11
Power Door .....	2-11
Safety .....	2-12
Loss of Control .....	9-5



Low Fuel Warning Light ..... 5-19  
 Low-Profile Tires ..... 10-35  
 Lower Anchors and Tethers  
 for Children (LATCH  
 System) ..... 3-34  
 Lumbar Adjustment ..... 3-4  
 Front Seats ..... 3-4

**M**

Maintenance  
 Records ..... 11-14  
 Maintenance Schedule  
 Recommended Fluids  
 and Lubricants ..... 11-12  
 Malfunction Indicator Lamp .... 5-12  
 Manual Mode ..... 9-24  
 Map Data Updates ..... 7-68  
 Maps ..... 7-46  
 Memory Features ..... 1-7  
 Memory Seats ..... 3-5  
 Menu  
 Configure ..... 7-60

Messages  
 Battery Voltage and  
 Charging ..... 5-26  
 Brake System ..... 5-26  
 Door Ajar ..... 5-27  
 Engine Cooling System ..... 5-27  
 Engine Oil ..... 5-28  
 Engine Power ..... 5-28  
 Fuel System ..... 5-28  
 Key and Lock ..... 5-29  
 Lamp ..... 5-29  
 Object Detection System ..... 5-29  
 Ride Control System ..... 5-31  
 Security ..... 5-31  
 Service Vehicle ..... 5-31  
 Tire ..... 5-31  
 Transmission ..... 5-32  
 Vehicle ..... 5-26  
 Vehicle Reminder ..... 5-32  
 Washer Fluid ..... 5-32  
 Window ..... 5-32  
 Messaging  
 Text ..... 7-82

Mirrors  
 Automatic Dimming ..... 2-17  
 Automatic Dimming  
 Rearview ..... 2-17  
 Convex ..... 2-16  
 Folding ..... 2-17  
 Heated ..... 2-17  
 Power ..... 2-16  
 Tilt in Reverse ..... 2-17  
 Mirrors, Interior Rearview ..... 2-17  
 Monitor System, Tire  
 Pressure ..... 10-42  
 Multi-band Antenna ..... 7-21

**N**

Navigation  
 Destination ..... 7-48  
 OnStar® ..... 14-2  
 Symbols ..... 7-46  
 Using the System ..... 7-42  
 Net, Convenience ..... 4-3  
 New Vehicle Break-In ..... 9-15

**O**

Object Detection System	
Messages .....	5-29
Odometer .....	5-8
Trip .....	5-8
Off-Road	
Recovery .....	9-4
Oil	
Engine .....	10-6
Engine Oil Life System .....	10-8
Messages .....	5-28
Pressure Light .....	5-18
Older Children, Restraints .....	3-26
Online Owner Center .....	13-4
OnStar <sup>®</sup>	
System, In Brief .....	1-19
OnStar <sup>®</sup> Additional	
Information .....	14-5
OnStar <sup>®</sup> Connections .....	14-3
OnStar <sup>®</sup> Destination	
Download .....	7-59
OnStar <sup>®</sup> Diagnostics .....	14-5
OnStar <sup>®</sup> Emergency .....	14-2
OnStar <sup>®</sup> Navigation .....	14-2
OnStar <sup>®</sup> Overview .....	14-1
OnStar <sup>®</sup> Security .....	14-2

Ordering	
Service Publications .....	13-11
Outlets	
Power .....	5-4
Overheating, Engine .....	10-16
Overview, Infotainment	
System .....	7-2

**P**

Pandora Internet Radio .....	7-22
Park	
Shifting Into .....	9-18
Shifting Out of .....	9-19
Parking	
Brake and P (Park)	
Mechanism Check .....	10-23
Over Things That Burn .....	9-21
Parking or Backing	
Assistance Systems .....	9-36
Passenger Airbag Status	
Indicator .....	5-11
Passenger Compartment Air	
Filter .....	8-6
Passenger Sensing System .....	3-20
Perchlorate Materials	
Requirements, California .....	10-2

Personalization	
Vehicle .....	5-33
Phone	
Bluetooth .....	7-75
Pictures .....	7-31
Power	
Door Locks .....	2-11
Mirrors .....	2-16
Outlets .....	5-4
Protection, Battery .....	6-5
Retained Accessory (RAP) .....	9-18
Seat Adjustment .....	3-3
Windows .....	2-18
Pregnancy, Using Safety	
Belts .....	3-12
Privacy	
Radio Frequency	
Identification (RFID) .....	13-15
Problems with Route	
Guidance .....	7-67
Program	
Courtesy Transportation .....	13-7
Proposition 65 Warning,	
California .....	10-2

**Q**

Quick Info ..... 7-22

**R**

Radio Frequency  
 Identification (RFID) ..... 13-15  
 Statement ..... 13-15  
 Radios  
 AM-FM Radio ..... 7-11  
 Reception ..... 7-20  
 Satellite ..... 7-15  
 Reading Lamps ..... 6-4  
 Rear Axle ..... 10-21  
 Limited-Slip ..... 9-32  
 Rear Seat  
 Pass-Through Door ..... 3-7  
 Rearview Mirrors  
 Automatic Dimming ..... 2-17  
 Reclining Seatbacks ..... 3-4  
 Recommended  
 Fuel ..... 9-46  
 Recommended Fluids and  
 Lubricants ..... 11-12  
 Records  
 Maintenance ..... 11-14

Recreational Vehicle  
 Towing ..... 10-72  
 Reimbursement Program,  
 GM Mobility ..... 13-5  
 Remote Keyless Entry  
 (RKE) System ..... 2-2, 2-3  
 Remote Vehicle Start ..... 2-8  
 Replacement Bulbs ..... 10-25  
 Replacement Parts  
 Airbags ..... 3-26  
 Maintenance ..... 11-13  
 Replacing Airbag System ..... 3-26  
 Replacing LATCH System  
 Parts after a Crash ..... 3-39  
 Replacing Safety Belt  
 System Parts after a Crash... 3-13  
 Reporting Safety Defects  
 Canadian Government ..... 13-13  
 General Motors ..... 13-13  
 U.S. Government ..... 13-12  
 Restraints  
 Where to Put ..... 3-32  
 Retained Accessory  
 Power (RAP) ..... 9-18  
 Reverse Tilt Mirrors ..... 2-17

Ride Control Systems  
 Limited Slip Rear Axle ..... 9-32  
 Messages ..... 5-31  
 Roads  
 Driving, Wet ..... 9-6  
 Roadside Assistance  
 Program ..... 13-5  
 Roof  
 Sunroof ..... 2-20  
 Rotation, Tires ..... 10-47  
 Routing, Engine Drive Belt ..... 12-3  
 Running the Vehicle While  
 Parked ..... 9-22

**S**

Safety Belts ..... 3-8  
 Care ..... 3-13  
 Extender ..... 3-12  
 How to Wear Safety Belts  
 Properly ..... 3-9  
 Lap-Shoulder Belt ..... 3-10  
 Reminders ..... 5-9  
 Replacing after a Crash ..... 3-13  
 Use During Pregnancy ..... 3-12

Safety Defects Reporting		Signals, Turn and	
Canadian Government . . . . .	13-13	Lane-Change . . . . .	6-3
General Motors . . . . .	13-13	Software Updates . . . . .	7-11
U.S. Government . . . . .	13-12	Specifications and	
Safety Locks . . . . .	2-12	Capacities . . . . .	12-2
Safety System Check . . . . .	3-12	Speedometer . . . . .	5-8
Satellite Radio . . . . .	7-15	StabiliTrak	
Scheduling Appointments . . . . .	13-7	OFF Light . . . . .	5-17
Sealant Kit, Tire . . . . .	10-56	Start Assist, Hills . . . . .	9-29
Seats		Start Vehicle, Remote . . . . .	2-8
Head Restraints . . . . .	3-2	Starter Switch Check . . . . .	10-21
Heated and Ventilated Front . . . . .	3-6	Starting the Engine . . . . .	9-17
Lumbar Adjustment, Front . . . . .	3-4	Steering . . . . .	9-4
Memory . . . . .	3-5	Wheel Adjustment . . . . .	5-2
Power Adjustment, Front . . . . .	3-3	Wheel Controls . . . . .	5-2
Reclining Seatbacks . . . . .	3-4	Storage Areas	
Securing Child		Center Console . . . . .	4-2
Restraints . . . . .	3-39, 3-41	Convenience Net . . . . .	4-3
Security		Glove Box . . . . .	4-1
Light . . . . .	5-19	Storage Compartments . . . . .	4-1
Messages . . . . .	5-31	Storing the Tire Sealant	
OnStar <sup>®</sup> . . . . .	14-2	and Compressor Kit . . . . .	10-62
Vehicle . . . . .	2-14	Stuck Vehicle . . . . .	9-10
Vehicle Alarm . . . . .	2-14	Sun Visors . . . . .	2-19
Service		Sunroof . . . . .	2-20
Accessories and		Symbols . . . . .	iv
Modifications . . . . .	10-2		
Doing Your Own Work . . . . .	10-3		
Engine Soon Light . . . . .	5-12		
Maintenance Records . . . . .	11-14		
Maintenance, General			
Information . . . . .	11-1		
Parts Identification Label . . . . .	12-1		
Publications Ordering			
Information . . . . .	13-11		
Scheduling Appointments . . . . .	13-7		
Vehicle Messages . . . . .	5-31		
Vehicle Soon Light . . . . .	5-14		
Service Electric Parking			
Brake Light . . . . .	5-15		
Servicing the Airbag . . . . .	3-24		
Shift Lock Control Function			
Check, Automatic			
Transmission . . . . .	10-22		
Shifting			
Into Park . . . . .	9-18		
Out of Park . . . . .	9-19		
Side Blind Zone			
Alert (SBZA) . . . . .	9-42		

Symbols, Navigation ..... 7-46  
 System  
     Forward Collision  
         Alert (FCA) ..... 9-40  
         Infotainment ..... 7-2, 13-15  
 System Needs Service ..... 7-68  
 Systems  
     Driver Assistance ..... 9-35

**T**

Tachometer ..... 5-8  
 Text ..... 7-82  
 Text Telephone (TTY) Users ... 13-4  
 Theft-Deterrent Systems ..... 2-15  
     Immobilizer ..... 2-15  
 Time ..... 5-4  
 Tires  
     Buying New Tires ..... 10-49  
     Chains ..... 10-53  
     Changing ..... 10-63  
     Designations ..... 10-37  
     Different Size ..... 10-50  
     Full-Size Spare ..... 10-68  
     If a Tire Goes Flat ..... 10-54  
     Inflation Monitor System ... 10-43  
     Inspection ..... 10-46

Tires (cont'd)  
     Low Profile ..... 10-35  
     Messages ..... 5-31  
     Pressure Light ..... 5-18  
     Pressure Monitor System ... 10-42  
     Rotation ..... 10-47  
     Sealant and  
         Compressor Kit ..... 10-56  
     Sealant and Compressor  
         Kit, Storing ..... 10-62  
     Sidewall Labeling ..... 10-36  
 Terminology and  
     Definitions ..... 10-38  
 Uniform Tire Quality  
     Grading ..... 10-51  
 Wheel Alignment and Tire  
     Balance ..... 10-52  
     Wheel Replacement ..... 10-52  
     When It Is Time for New  
         Tires ..... 10-48  
         Winter ..... 10-35  
 Towing  
     Recreational Vehicle ..... 10-72  
     Trailer ..... 9-50  
     Vehicle ..... 10-71

Track Events and  
     Competitive Driving ..... 9-5  
 Traction  
     Control System (TCS)/  
         StabiliTrak® Light ..... 5-18  
     Limited-Slip Rear Axle ..... 9-32  
     Off Light ..... 5-17  
 Traction Control/Electronic  
     Stability Control ..... 9-30  
 Trailer  
     Towing ..... 9-50  
 Transmission  
     Automatic ..... 9-22  
     Fluid, Automatic ..... 10-9  
     Messages ..... 5-32  
 Transportation Program,  
     Courtesy ..... 13-7  
 Trip Odometer ..... 5-8  
 Trunk ..... 2-12  
 Turn and Lane-Change  
     Signals ..... 6-3

**U**

Uniform Tire Quality Grading .....	10-51
Updates	
Map Data .....	7-68
Software .....	7-11
USB .....	7-34
Using the System .....	7-6
Using This Manual .....	iii

**V**

Vehicle	
Alarm System .....	2-14
Control .....	9-3
Identification	
Number (VIN) .....	12-1
Load Limits .....	9-10
Messages .....	5-26
Personalization .....	5-33
Positioning .....	7-66
Reminder Messages .....	5-32
Remote Start .....	2-8
Security .....	2-14
Service Soon Light .....	5-14
Towing .....	10-71
Vehicle Ahead Indicator .....	5-17

## Vehicle Care

Storing the Tire Sealant and Compressor Kit .....	10-62
Tire Pressure .....	10-41
Ventilation, Air .....	8-6
Viewing	
Pictures .....	7-31
Visors .....	2-19
Voice Recognition .....	7-68

**W**

Warning	
Brake System Light .....	5-14
Lane Departure (LDW) .....	9-44
Warning Light	
Forward Collision Alert (FCA) .....	5-16
Warning Lights, Gauges, and Indicators .....	5-6
Warnings .....	iii
Cautions and Danger .....	iii
Hazard Flashers .....	6-3
Washer Fluid .....	10-17
Messages .....	5-32

## Wheels

Alignment and Tire	
Balance .....	10-52
Different Size .....	10-50
Replacement .....	10-52
When It Is Time for New Tires .....	10-48
Where to Put the Restraint ....	3-32
Windows .....	2-18
Messages .....	5-32
Power .....	2-18
Windshield	
Replacement .....	10-24
Wiper/Washer .....	5-3
Winter	
Driving .....	9-8
Winter Tires .....	10-35
Wiper Blade Replacement ....	10-23