

2012 Chevrolet Malibu Owner Manual

In Brief	1-1	Storage	4-1	Climate Controls	8-1
Instrument Panel	1-2	Storage Compartments	4-1	Climate Control Systems	8-1
Initial Drive Information	1-3	Additional Storage Features	4-4	Air Vents	8-9
Vehicle Features	1-16	Instruments and Controls	5-1	Driving and Operating	9-1
Performance and		Controls	5-2	Driving Information	9-2
Maintenance	1-20	Warning Lights, Gauges, and		Starting and Operating	9-14
		Indicators	5-8	Engine Exhaust	9-21
Keys, Doors, and		Information Displays	5-22	Automatic Transmission	9-22
Windows	2-1	Vehicle Messages	5-25	Brakes	9-25
Keys and Locks	2-2	Vehicle Personalization	5-29	Ride Control Systems	9-27
Doors	2-9	Lighting	6-1	Cruise Control	9-31
Vehicle Security	2-11	Exterior Lighting	6-1	Fuel	9-33
Exterior Mirrors	2-13	Interior Lighting	6-5	Towing	9-39
Interior Mirrors	2-14	Lighting Features	6-6	Conversions and Add-Ons	9-45
Windows	2-15	Infotainment System	7-1	Vehicle Care	10-1
Roof	2-18	Introduction	7-1	General Information	10-2
Seats and Restraints	3-1	Radio	7-6	Vehicle Checks	10-4
Head Restraints	3-2	Audio Players	7-13	Headlamp Aiming	10-25
Front Seats	3-3	Phone	7-23	Bulb Replacement	10-25
Rear Seats	3-7			Electrical System	10-30
Safety Belts	3-8			Wheels and Tires	10-38
Airbag System	3-17			Jump Starting	10-76
Child Restraints	3-30			Towing	10-79
				Appearance Care	10-82

2012 Chevrolet Malibu Owner Manual

Service and Maintenance ... 11-1	Technical Data 12-1	OnStar 14-1
General Information 11-1	Vehicle Identification 12-1	OnStar Overview 14-1
Maintenance Schedule 11-3	Vehicle Data 12-2	OnStar Services 14-2
Special Application Services 11-8	Customer Information 13-1	OnStar Additional Information 14-5
Additional Maintenance and Care 11-8	Customer Information 13-1	Index i-1
Recommended Fluids, Lubricants, and Parts 11-11	Reporting Safety Defects 13-17	
Maintenance Records 11-13	Vehicle Data Recording and Privacy 13-19	



The names, logos, emblems, slogans, vehicle model names, and vehicle body designs appearing in this manual including, but not limited to, GM, the GM logo, CHEVROLET, the CHEVROLET Emblem, MALIBU, and the MALIBU Emblem are trademarks and/or service marks of General Motors LLC, its subsidiaries, affiliates, or licensors.

This manual describes features that may or may not be on your specific vehicle either because they are options that you did not purchase or due to changes subsequent to the printing of this owner manual. Please refer to the purchase documentation relating to your specific vehicle to confirm each of the features found on your vehicle. For vehicles first sold in Canada, substitute the name "General Motors of Canada Limited" for Chevrolet Motor Division wherever it appears in this manual.

Keep this manual in the vehicle for quick reference.

Canadian Vehicle Owners

Propriétaires Canadiens

A French language copy of this manual can be obtained from your dealer or from:

On peut obtenir un exemplaire de ce guide en français auprès du concessionnaire ou à l'adresse suivante:

Helm, Incorporated
P.O. Box 07130
Detroit, MI 48207

1-800-551-4123
Numéro de poste 6438
de langue française
www.helminc.com

Using this Manual

To quickly locate information about the vehicle, use the Index in the back of the manual. It is an alphabetical list of what is in the manual and the page number where it can be found.

Danger, Warnings, and Cautions

Warning messages found on vehicle labels and in this manual describe hazards and what to do to avoid or reduce them.

Danger indicates a hazard with a high level of risk which will result in serious injury or death.

Warning or **Caution** indicates a hazard that could result in injury or death.

WARNING

These mean there is something that could hurt you or other people.

Notice: This means there is something that could result in property or vehicle damage. This would not be covered by the vehicle's warranty.



A circle with a slash through it is a safety symbol which means “Do Not,” “Do not do this,” or “Do not let this happen.”

Symbols

The vehicle has components and labels that use symbols instead of text. Symbols are shown along with the text describing the operation or information relating to a specific component, control, message, gauge, or indicator.

 : This symbol is shown when you need to see your owner manual for additional instructions or information.

 : This symbol is shown when you need to see a service manual for additional instructions or information.

Vehicle Symbol Chart

Here are some additional symbols that may be found on the vehicle and what they mean. For more information on the symbol, refer to the Index.

 : Airbag Readiness Light

 : Air Conditioning

 : Antilock Brake System (ABS)

 : Audio Steering Wheel Controls or OnStar®

 : Brake System Warning Light

 : Charging System

 : Cruise Control

 : Engine Coolant Temperature

 : Exterior Lamps

 : Fog Lamps

 : Fuel Gauge

 : Fuses

 : Headlamp High/Low-Beam Changer

 : LATCH System Child Restraints

 : Malfunction Indicator Lamp

 : Oil Pressure

 : Power

 : Remote Vehicle Start

 : Safety Belt Reminders

 : Tire Pressure Monitor

 : Traction Control/Electronic Stability Control (ESC)

 : Windshield Washer Fluid

In Brief

Instrument Panel

Instrument Panel 1-2

Initial Drive Information

Initial Drive Information 1-3

Remote Keyless Entry (RKE)

System 1-3

Remote Vehicle Start 1-4

Door Locks 1-5

Trunk Release 1-5

Windows 1-6

Seat Adjustment 1-6

Second Row Seats 1-9

Heated Seats 1-9

Head Restraint Adjustment 1-9

Safety Belts 1-10

Passenger Sensing

System 1-10

Mirror Adjustment 1-11

Steering Wheel

Adjustment 1-11

Interior Lighting 1-12

Exterior Lighting 1-12

Windshield Wiper/Washer 1-13

Climate Controls 1-14

Transmission 1-15

Vehicle Features

Radio(s) 1-16

Satellite Radio 1-17

Portable Audio Devices

(Auxiliary Input or

USB Port) 1-17

Bluetooth® 1-17

Steering Wheel Controls 1-18

Cruise Control 1-18

Driver Information

Center (DIC) 1-19

Power Outlets 1-19

Performance and Maintenance

Traction Control

System (TCS) 1-20

Electronic Stability

Control (ESC) 1-20

Tire Pressure Monitor 1-20

Tire Sealant and

Compressor Kit 1-21

Engine Oil Life System 1-21

Fuel E85 (85% Ethanol) 1-21

Driving for Better Fuel

Economy 1-21

Roadside Assistance

Program 1-22

OnStar® 1-22

Instrument Panel

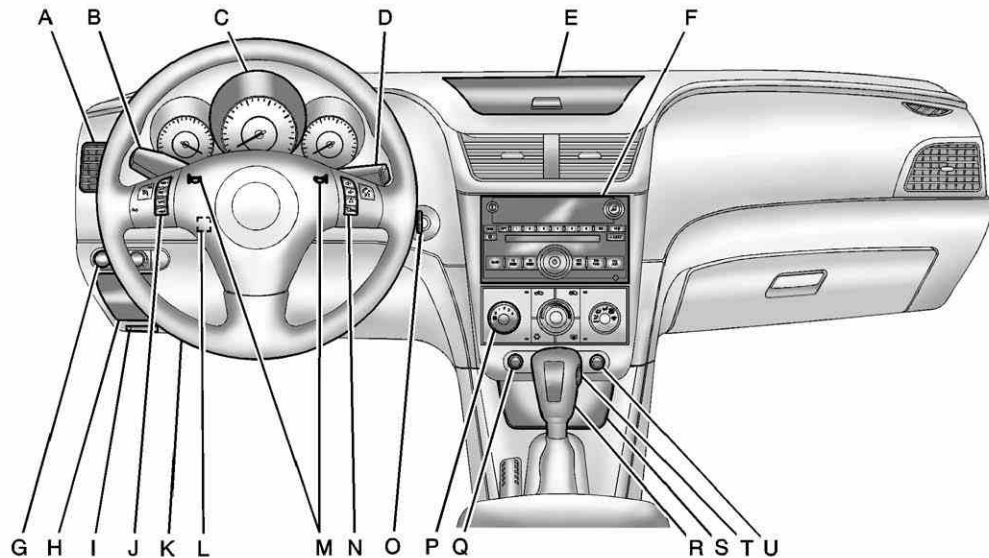

- A. *Air Vents on page 8-9.*
- B. *Turn and Lane-Change Lever. See Turn and Lane-Change Signals on page 6-4.*
- C. *Instrument Cluster on page 5-9.*
- D. *Windshield Wiper/Washer on page 5-3.*
- E. *Instrument Panel Storage on page 4-1.*
- F. *Infotainment on page 7-1.*
- G. *Instrument Panel Illumination Control on page 6-5.*
- H. *Driver Compartment Storage. See Front Storage on page 4-2.*
- I. *Hood Release. See Hood on page 10-4.*
- J. *Cruise Control on page 9-31.*
Driver Information Center (DIC) Buttons. See Driver Information Center (DIC) on page 5-22.
- K. *Data Link Connector (DLC) (Out of View). See Malfunction Indicator Lamp on page 5-14.*
- L. *Steering Wheel Adjustment on page 5-2 (Out of View).*
- M. *Horn on page 5-3.*
- N. *Steering Wheel Controls on page 5-2 (If Equipped).*
- O. *Ignition Positions on page 9-15.*
- P. *Climate Control Systems on page 8-1 (If Equipped).*
Automatic Climate Control System on page 8-5 (If Equipped) .
- Q. *Hazard Warning Flashers on page 6-4.*
- R. *Shift Lever. See Automatic Transmission on page 9-22.*
- S. *Front Storage on page 4-2.*
Power Outlets on page 5-7.
- T. *Passenger Sensing System on page 3-24.*
- U. *Traction Control System (TCS) on page 9-27.*

Initial Drive Information

This section provides a brief overview about some of the important features that may or may not be on your specific vehicle.

For more detailed information, refer to each of the features which can be found later in this owner manual.

Remote Keyless Entry (RKE) System

The RKE transmitter is used to remotely lock and unlock the doors from up to 60 m (195 ft) away from the vehicle.

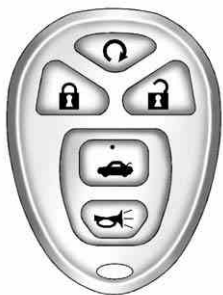

Press  to unlock the driver door. Press again within five seconds to unlock all remaining doors.

Press  to lock all doors.

Lock and unlock feedback can be personalized. See *Vehicle Personalization* on page 5-29 for additional information.

Press and hold  for approximately one second to open the trunk.

Press  and release to locate the vehicle.

Press  and hold for more than two seconds to sound the panic alarm.

Press  again to cancel the panic alarm.

See *Keys* on page 2-2 and *Remote Keyless Entry (RKE) System Operation* on page 2-3.

Remote Vehicle Start

With this feature the engine can be started from outside of the vehicle.

Starting the Vehicle

1. Aim the RKE transmitter at the vehicle.
2. Press and release .
3. Immediately after completing Step 2, press and hold  until the turn signal lamps flash.

When the vehicle starts, the parking lamps will turn on and remain on as long as the engine is running. The doors will be locked and the climate control system may come on.

The engine will continue to run for 10 minutes. Repeat the steps for a 10-minute time extension. Remote start can be extended only once.

Canceling a Remote Start

To cancel a remote start:

- Aim the RKE transmitter at the vehicle and press and hold  until the parking lamps turn off.
- Turn on the hazard warning flashers.
- Turn the ignition on and then back off.

See *Remote Vehicle Start* on page 2-5.

Door Locks

Manual Locks

From inside the vehicle move the manual lock control to unlock or lock a door.

Power Door Locks

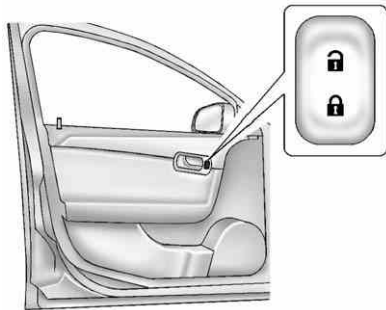

On vehicles with power door locks.

 : Press to unlock the doors.

 : Press to lock the doors.

For more information, see:

- *Door Locks on page 2-7.*
- *Power Door Locks on page 2-7.*

Trunk Release

To open the trunk from the outside, press the trunk release button on the RKE transmitter.

Remote Trunk Release

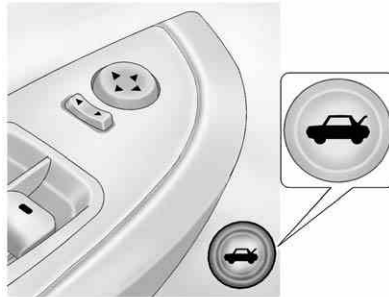

Press the button located on the driver door near the map pocket to open the trunk.

Close the trunk by pulling on the handle.

Emergency Trunk Release Handle

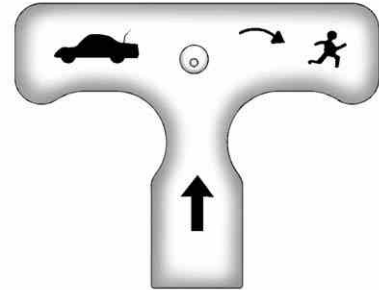

There is a glow-in-the-dark emergency trunk release handle located inside the trunk on the trunk latch. This handle glows following exposure to light. Pull the release handle up to open the trunk from the inside.

See *Trunk on page 2-9* for more information.

Windows



The power window switches are located on the armrest on the driver's door. In addition, there is a switch on each passenger door.

Press the front of the switch to open the window. Pull the switch up to close it.

Express-Down Window

The driver window has an express-down feature. This switch is labeled AUTO. Press the front all the way down and release, to automatically lower.

To stop the window while it is lowering, pull the front of the switch momentarily. To raise the window, pull and hold the front of the switch.

Express-Up Window

On windows with this feature, pull the switch up to the second position and release the switch to activate the express-up feature. To stop the window as it is going up, pull up or press down briefly on the switch again.

See *Power Windows* on page 2-16.

Seat Adjustment

Manual Seats

Seat Position

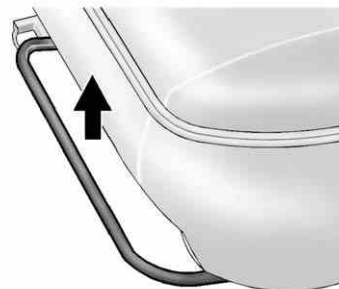

To adjust the seat position:

1. Lift the bar under the front of the seat cushion to unlock the seat.
2. Slide the seat to the desired position and release the bar.
3. Try to move the seat back and forth to make sure it is locked in place.

Height Adjustment

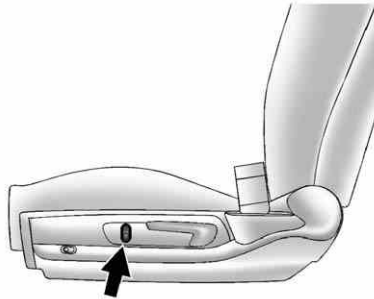

If available, press and hold the top or bottom of the switch to raise or lower the seat. Release the switch when the desired height is reached. See *Seat Adjustment on page 3-3*.

Seatback Adjustment

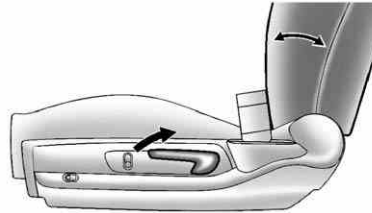

To recline the seatback:

1. Lift the lever.
2. Move the seatback to the desired position, and then release the lever to lock the seatback in place.
3. Push and pull on the seatback to make sure it is locked.

To return the seatback to the upright position:

1. Lift the lever fully without applying pressure to the seatback, and the seatback will return to the upright position.
2. Push and pull on the seatback to make sure it is locked.

See “Manual Reclining Seatbacks” under *Reclining Seatbacks on page 3-4*.

Power Seats

Seat Position

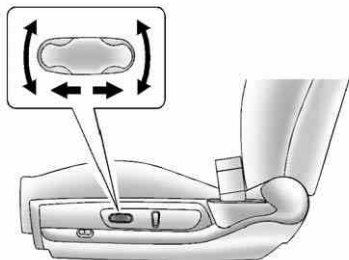

To adjust a power seat, if available:

- Move the seat forward or rearward by sliding the control forward or rearward.
- Raise or lower the front or rear part of the seat cushion by moving the front or rear of the horizontal control up or down.
- Raise or lower the entire seat by moving the entire control up or down.

See *Power Seat Adjustment* on page 3-4.

Seatback Adjustment

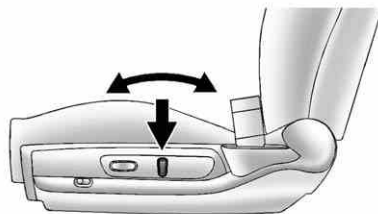

To adjust a power seatback, if equipped:

- Tilt the top of the control rearward to recline.
- Tilt the top of the control forward to raise.

See “Power Reclining Seatbacks” under *Reclining Seatbacks* on page 3-4.

Lumbar Adjustment

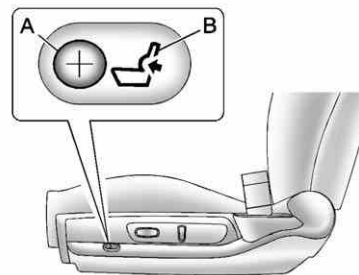

- A. Increase Lumbar Support Control
- B. Decrease Lumbar Support Control

If available, press the front (A) or rear (B) of the control to increase or decrease lumbar support. Release the control when the desired level of support is reached.

See *Lumbar Adjustment* on page 3-4.

Second Row Seats

With this feature, either side of the seatback can be folded down for more cargo space. Before folding a seatback, make sure the front seat is not reclined. If it is, the rear seatback will not fold down all the way.

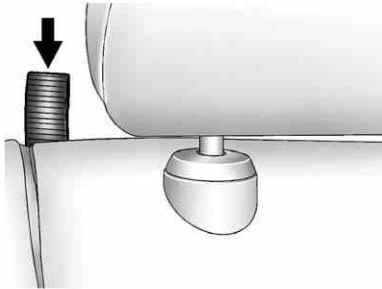

To lower the rear seatback, pull up on the seatback strap while folding the seatback down. This allows access to the trunk. To raise the rear seatback pull the seatback up and make sure it latches.

Push and pull on the seatback to be sure it is locked in position. Make sure that the safety belts are properly stowed over the seatback in all three positions.

See *Rear Seats* on page 3-7 for more information.

Heated Seats

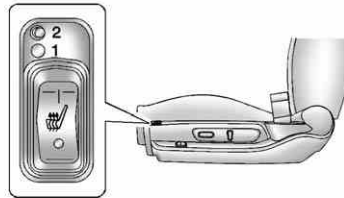

If available, press the top of the switch to turn the heat feature on to the high heat setting. The indicator light "2" will be lit.

Press the top of the switch again to go to the low heat setting. The indicator light "1" will be lit.

Press the bottom of the switch to turn the feature off.

The heated seats are canceled when the ignition is turned off.

For more information, see *Heated Front Seats* on page 3-6.

Head Restraint Adjustment

Do not drive until the head restraints for all occupants are installed and adjusted properly.

To achieve a comfortable seating position, change the seatback recline angle as little as necessary while keeping the seat and the head restraint height in the proper position.

See *Head Restraints* on page 3-2 and *Seat Adjustment* on page 3-3.

Safety Belts



Refer to the following sections for important information on how to use safety belts properly:

- *Safety Belts on page 3-8.*
- *How to Wear Safety Belts Properly on page 3-10.*
- *Lap-Shoulder Belt on page 3-11.*
- *Lower Anchors and Tethers for Children (LATCH System) on page 3-38.*

Passenger Sensing System

The passenger sensing system turns off the front outboard passenger frontal airbag and seat-mounted side impact airbag under certain conditions. No other airbag is affected by this.

The passenger airbag status indicator will be visible on the instrument panel when the vehicle is started.



United States



Canada and Mexico

See *Passenger Sensing System* on page 3-24 for important information.

Mirror Adjustment

Exterior Mirrors

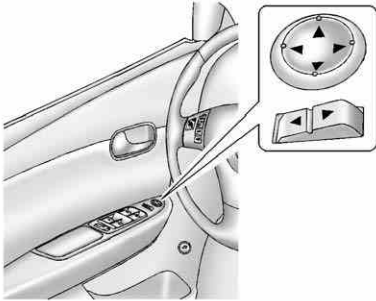

Controls for the outside power mirrors are located on the driver door.

1. Move the selector switch located below the four-way control pad to the left or right to choose either the driver side or passenger side mirror.

2. Press one of the four arrows located on the control pad to move the mirror to the desired direction.

Keep the selector switch in the center position when not adjusting either outside mirror.

See *Power Mirrors* on page 2-14.

Interior Mirror

Hold the inside rearview mirror in the center to move it for a clearer view of behind your vehicle. Adjust the mirror to avoid glare from the headlamps behind. Push the tab forward for daytime use and pull it for nighttime use.

See *Manual Rearview Mirror* on page 2-14.

Vehicles with an automatic dimming rearview mirror will automatically reduce the glare from the headlamps of the vehicle behind. This feature comes on each time the vehicle is started.

To turn the automatic dimming feature off or on, press and hold  for approximately six seconds or until the indicator light turns off or on.

Steering Wheel Adjustment

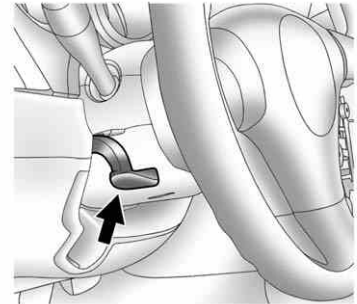

The lever is located on the left side of the steering wheel column.

1-12 In Brief

To adjust the steering wheel:

1. Pull the lever down.
2. Move the steering wheel up or down.
3. Pull or push the steering wheel closer or away from you.
4. Pull the lever up to lock the steering wheel in place.

Do not adjust the steering wheel while driving.

Interior Lighting

Dome Lamps

The dome lamps come on when any door is opened. They turn off after all the doors are closed.

To turn the dome lamps on manually, turn the instrument panel brightness knob, located on the instrument panel to the left of the steering column, clockwise to the farthest position. The dome lamps will remain on whether a door is opened or closed.

Reading Lamps

The front reading lamps are located in the front overhead console. The rear reading lamps are near the dome lamp overhead near the rear passenger seats.

For vehicles with front and/or rear reading lamps, press the lens to turn the lamp on and off, while the doors are closed. These lamps come on automatically when any door is opened.

For more information on interior lighting, see:

- *Instrument Panel Illumination Control on page 6-5.*
- *Entry/Exit Lighting on page 6-6.*
- *Parade Dimming on page 6-6.*

Exterior Lighting



 : Briefly turn to this position to manually turn the automatic lamp control off or on.

In Canada, this position only works when a vehicle is in the P (Park) position. When the vehicle is put into D (Drive) the lights come on.

AUTO: Automatically turns on the Daytime Running Lamps during daytime, and the headlamps, parking lamps, and taillamps at night.

 : Manual operation of the parking lamps and taillamps.

 : Manual operation of the headlamps, parking lamps, and taillamps.

For more information, see:

- *Exterior Lamp Controls on page 6-1.*
- *Delayed Headlamps on page 6-4.*
- *Daytime Running Lamps (DRL) on page 6-2.*
- *Automatic Headlamp System on page 6-3.*
- *Fog Lamps on page 6-5.*

Windshield Wiper/Washer

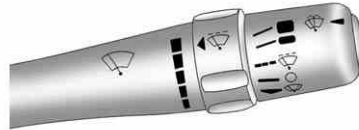

The windshield wiper lever is located on the right side of the steering column.

○ : Turns the wipers off.

☒ : For intermittent or speed sensitive operation. While in this position, turn the ☒ band up or down to vary frequency.

The amount of delay time varies between wiping cycles due to the delay setting selected or the speed of the vehicle. As vehicle speed is increased or decreased, the wiper interval also increases or decreases.

▬ : Slow wipes.

▬ : Fast wipes.

☒ : Use for a single wiping cycle.

Windshield Washer: Press the button at the end of the lever until the washers begin.

See *Windshield Wiper/Washer on page 5-3.*

Climate Controls

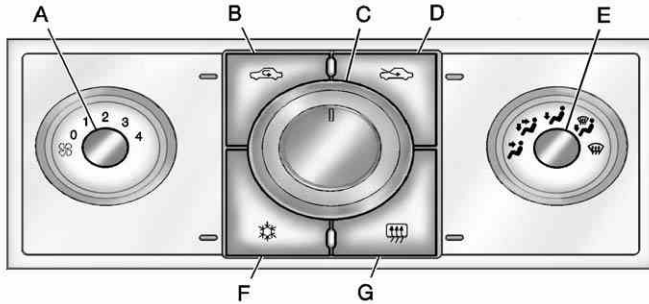

- A. Fan Control
- B. Air Recirculation
- C. Temperature Control
- D. Outside Air

- E. Air Delivery Mode Control
- F. Air Conditioning
- G. Rear Window Defogger

See *Climate Control Systems* on page 8-1 (If Equipped).

Automatic Climate Control System (If Equipped)

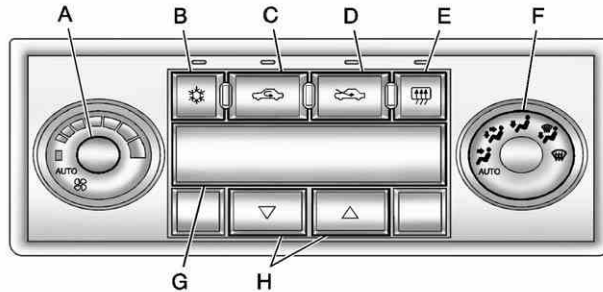

- A. Fan Control
- B. Air Conditioning
- C. Air Recirculation
- D. Outside Air

- E. Rear Window Defogger
- F. Air Delivery Mode Control
- G. Display
- H. Temperature Control

See *Automatic Climate Control System* on page 8-5 (If Equipped).

Transmission

Driver Shift Control (DSC)

This position allows you to change gears similar to a manual transmission. To use this feature:

1. Move the shift lever from D (Drive) rearward to M (Manual).

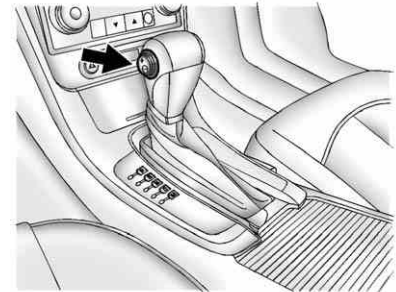

2. Press the + (plus) end of the button on the side of the shifter to upshift, or push the - (minus) end of the button to downshift.

See *Manual Mode* on page 9-23.

Vehicle Features

Radio(s)





Radio with CD (MP3) and USB Port shown

: Press to turn the system on and off. Turn to increase or decrease the volume.

BAND: Press to choose between FM, AM, or XM™, if equipped.

: Select radio stations.

: Seek or scan stations.

: For vehicles with XM, MP3, WMA, or RDS features, press to display additional text information related to the current FM-RDS or XM station; or CD, MP3, WMA song. Song title information will be displayed on the top line of the display while the artist information will be displayed on the bottom line, if the information is available during XM, CD, MP3, or WMA playback. When information is not available, "No Info" displays.

For more information about these and other radio features, see *Infotainment on page 7-1* and *Operation on page 7-2*.

Storing a Favorite Station

Depending on which radio the vehicle has, radio stations are stored as either favorites or presets.

For radios with a FAV button, a maximum of 36 stations can be stored as favorites using the six softkeys located below the radio



station frequency tabs and by using the radio FAV button. Press FAV to go through up to six pages of favorites, each having six favorite stations available per page. Each page of favorites can contain any combination of AM, FM, or XM™ stations.

For radios without a FAV button, up to 18 stations (six FM1, six FM2, and six AM), can be programmed on the six numbered buttons.

See *Operation on page 7-2*.

Setting the Clock

To set the time and date for the Radio with CD (MP3) and USB port or Radio with a Single CD (MP3) player:

1. Turn the ignition key to ACC/ACCESSORY or ON/RUN.
2. Press  to turn the radio on.
3. Press  and the HR, MIN, MM, DD, YYYY (hour, minute, month, day, and year) displays.

4. Press the softkey located below any one of the tabs that you want to change.
5. Increase or decrease the time or date by turning  clockwise or counterclockwise.

For detailed instructions on setting the clock for your specific audio system, see *Clock on page 5-5*.

Satellite Radio

XM is a satellite radio service based in the 48 contiguous United States and 10 Canadian provinces. XM satellite radio has a wide variety of programming and commercial-free music, coast to coast, and in digital-quality sound.

A fee is required to receive the XM service.

For more information, refer to:

- www.xmradio.com or call 1-800-929-2100 (U.S.)
- www.xmradio.ca or call 1-877-438-9677 (Canada)

See *Satellite Radio on page 7-8*.

Portable Audio Devices (Auxiliary Input or USB Port)

This vehicle may have a 3.5 mm (1/8 in) auxiliary input jack and a USB port, located on the audio faceplate. Some portable audio devices such as iPods®, MP3 players, and USB storage devices can be connected to the vehicle using a 3.5 mm (1/8 in) cable or a USB cable.

For more information, see *Auxiliary Devices on page 7-18*.

Bluetooth®

For vehicles with a Bluetooth system, it allows users with a Bluetooth-enabled cell phone to make and receive hands-free calls using the vehicle's audio system and controls.

1-18 In Brief

The Bluetooth-enabled cell phone must be paired with the Bluetooth system before it can be used in the vehicle. Not all phones will support all functions. For more information, visit www.gm.com/bluetooth.

For more information, see *Bluetooth* on page 7-23.

Steering Wheel Controls

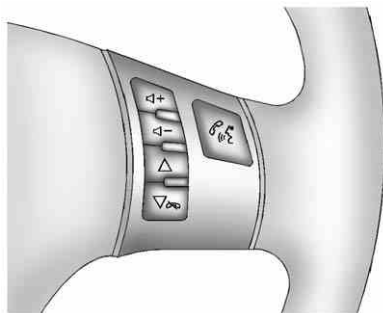

If equipped, some audio controls can be adjusted using the controls on the right side of the steering wheel.

◀ + / ▶ -: Increases or decreases volume.

△ or ▽ / 🎧 : Press to change radio stations, select tracks on a CD, or to select tracks and navigate folders on an iPod® or USB device.

🔇 / 🗣️ : Press to silence the vehicle speakers only. Press again to turn the sound on. Press and hold longer than two seconds to interact with the OnStar® or Bluetooth systems.

▽ / 🎧 : Press to reject an incoming call, or to end a call.

For more information, see *Steering Wheel Controls* on page 5-2.

Cruise Control

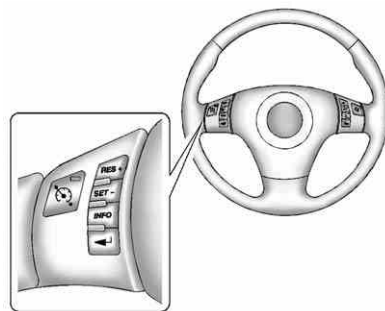

The cruise control buttons are located on the left side of the steering wheel.

🚗 : Press to turn the cruise control system on and off.

RES+: Press briefly to make the vehicle resume a previously set speed or press and hold to accelerate.

SET-: Press to set the speed and activate cruise control or make the vehicle decelerate.

For more information, see *Cruise Control* on page 9-31.

Driver Information Center (DIC)

The DIC display is located at the bottom of the instrument panel cluster. It shows the status of many vehicle systems and enables access to the personalization menu.

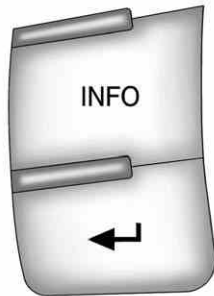

The DIC buttons are located on the left side of the steering wheel.

INFO: Press to scroll through the vehicle information displays.

: Press to reset some vehicle information displays, select a personalization setting, or acknowledge a warning message.

For more information, see *Driver Information Center (DIC)* on page 5-22.

Vehicle Personalization

Some vehicle features can be programmed by using the DIC buttons on the left side of the steering wheel. These features include:

- Oil Life Reset
- Units
- RKE Lock and Unlock Feedback
- Door Lock and Unlock Settings
- Language

See *Vehicle Personalization* on page 5-29.

Power Outlets

Accessory power outlets can be used to plug in electrical equipment, such as a cell phone or MP3 player.

There are two accessory power outlets. One accessory power outlet is located inside the storage bin below the climate controls and the other outlet is on the rear of the center storage console.



Remove the cover to access and replace when not in use.

See *Power Outlets* on page 5-7.

Performance and Maintenance

Traction Control System (TCS)



The traction control system limits wheel spin. The system turns on automatically every time the vehicle is started.

- To turn off traction control, press and release  on the center console.  illuminates and the appropriate DIC message is displayed. See *Ride Control System Messages on page 5-26*.
- Press and release the button again to turn on traction control.

For more information, see *Traction Control System (TCS) on page 9-27*.

Electronic Stability Control (ESC)

The Electronic Stability Control system assists with directional control of the vehicle in difficult driving conditions. The system turns on automatically every time the vehicle is started.

- To turn off both traction control and Electronic Stability Control, press and hold  until  and  illuminate and the appropriate DIC messages are displayed. See *Ride Control System Messages on page 5-26*.
- Press and release the button again to turn on both systems.

For more information, see *Electronic Stability Control (ESC) on page 9-29*.

Tire Pressure Monitor

This vehicle may have a Tire Pressure Monitor System (TPMS).



The TPMS warning light alerts you to a significant loss in pressure of one of the vehicle's tires. If the warning light comes on, stop as soon as possible and inflate the tires to the recommended pressure shown on the Tire and Loading Information label. See *Vehicle Load Limits on page 9-10*. The warning light will remain on until the tire pressure is corrected.

During cooler conditions, the low tire pressure warning light may appear when the vehicle is first started and then turn off. This may be an early indicator that the tire pressures are getting low and the tires need to be inflated to the proper pressure.

The TPMS does not replace normal monthly tire maintenance. It is the driver's responsibility to maintain correct tire pressures.

See *Tire Pressure Monitor System* on page 10-47.

Tire Sealant and Compressor Kit

This vehicle may come with a spare tire and tire changing equipment or a tire sealant and compressor kit. The kit can be used to temporarily seal small punctures in the tread area of the tire.

See *Tire Sealant and Compressor Kit* on page 10-60 for complete operating information.

If the vehicle came with a spare tire and tire changing equipment, see *If a Tire Goes Flat* on page 10-58.

Engine Oil Life System

The engine oil life system calculates engine oil life based on vehicle use and displays the CHANGE OIL SOON DIC message when it is necessary to change the engine oil and filter. The oil life system should be reset to 100% only following an oil change.

Resetting the Oil Life System

1. Turn the ignition to ON/RUN, with the engine off.
2. Press and hold the DIC INFO and reset buttons, on the left side of the steering wheel, at the same time to enter the personalization menu. The OIL LIFE RESET message displays.
3. Press and hold the reset button until the DIC display shows ACKNOWLEDGED.
4. Turn the key to LOCK/OFF.

See *Engine Oil Life System* on page 10-11.

Fuel E85 (85% Ethanol)

Vehicles that have a FlexFuel badge and a yellow fuel cap can use either unleaded gasoline or ethanol fuel containing up to 85% ethanol (E85). See *Fuel E85 (85% Ethanol)* on page 9-36. For all other vehicles, use only the unleaded gasoline described under *Recommended Fuel* on page 9-34.

Driving for Better Fuel Economy

Driving habits can affect fuel mileage. Here are some driving tips to get the best fuel economy possible.

- Avoid fast starts and accelerate smoothly.
- Brake gradually and avoid abrupt stops.
- Avoid idling the engine for long periods of time.

- When road and weather conditions are appropriate, use cruise control.
- Always follow posted speed limits or drive more slowly when conditions require.
- Keep vehicle tires properly inflated.
- Combine several trips into a single trip.
- Replace the vehicle's tires with the same TPC Spec number molded into the tire's sidewall near the size.
- Follow recommended scheduled maintenance.

Roadside Assistance Program

U.S.: **1-800-243-8872**

TTY Users (U.S.): **1-888-889-2438**

Canada: **1-800-268-6800**

Mexico: **01-800-466-0800**

As the owner of a new Chevrolet, you are automatically enrolled in the Roadside Assistance program.

See *Roadside Assistance Program (U.S. and Canada)* on page 13-7 or *Roadside Assistance Program (Mexico)* on page 13-9.

Roadside Assistance and OnStar (U.S. and Canada)

If you have an active OnStar subscription, press the  button and the current GPS location will be sent to an OnStar advisor who will assess your problem, contact Roadside Assistance, and relay your exact location to get the help you need.

Online Owner Center (U.S. and Canada)

The Online Owner Center is a complimentary service that includes online service reminders, vehicle maintenance tips, online owner manual, special privileges, and more.

Sign up today at:

U.S.: chevrolet.com (click on “Owners,” then “Manage My Chevrolet/Owners Login”)

Canada: chevroletowner.ca

OnStar[®]

If equipped, this vehicle has a comprehensive, in-vehicle system that can connect to a live Advisor for Emergency, Security, Navigation, Connection, and Diagnostic Services. See *OnStar Overview* on page 14-1 for more information.

Keys, Doors, and Windows

Keys and Locks

Keys	2-2
Remote Keyless Entry (RKE)	
System	2-2
Remote Keyless Entry (RKE)	
System Operation	2-3
Remote Vehicle Start	2-5
Door Locks	2-7
Power Door Locks	2-7
Door Ajar Reminder	2-8
Delayed Locking	2-8
Automatic Door Locks	2-8
Lockout Protection	2-8
Safety Locks	2-8

Doors

Trunk	2-9
-------------	-----

Vehicle Security

Vehicle Security	2-11
Anti-theft Alarm System	2-11
Immobilizer	2-12
Immobilizer Operation	2-12

Exterior Mirrors

Convex Mirrors	2-13
Power Mirrors	2-14
Heated Mirrors	2-14

Interior Mirrors

Manual Rearview Mirror	2-14
Automatic Dimming Rearview	
Mirror	2-14

Windows

Windows	2-15
Power Windows	2-16
Sun Visors	2-17

Roof

Sunroof	2-18
---------------	------

Keys and Locks

Keys

WARNING

Leaving children in a vehicle with the ignition key is dangerous for many reasons. Children or others could be badly injured or even killed. They could operate the power windows or other controls or even make the vehicle move. The windows will function with the keys in the ignition and children could be seriously injured or killed if caught in the path of a closing window. Do not leave the keys in a vehicle with children.



The key can be used for the ignition and all locks.

The key has a bar-coded key tag that the dealer or qualified locksmith can use to make new keys. Store this information in a safe place, not in your vehicle.

Notice: If the keys get locked in the vehicle, it may have to be damaged to get them out. Always carry a spare key.

If locked out of your vehicle, contact Roadside Assistance. See *Roadside Assistance Program (U.S. and Canada)* on page 13-7 or *Roadside Assistance Program (Mexico)* on page 13-9.

With an active OnStar subscription, an OnStar Advisor may remotely unlock the vehicle. See *OnStar Overview* on page 14-1.

Remote Keyless Entry (RKE) System

See *Radio Frequency Statement* on page 13-20 for information regarding Part 15 of the Federal Communications Commission (FCC) rules and Industry Canada Standards RSS-GEN/210/220/310.

If there is a decrease in the RKE operating range:

- Check the distance. The transmitter may be too far from the vehicle.
- Check the location. Other vehicles or objects may be blocking the signal.
- Check the transmitter's battery. See "Battery Replacement" later in this section.
- If the transmitter is still not working correctly, see your dealer or a qualified technician for service.

Remote Keyless Entry (RKE) System Operation

The Remote Keyless Entry (RKE) transmitter functions work up to 60 m (195 feet) away from the vehicle.

Keep in mind that other conditions, such as those previously stated, can impact the performance of the transmitter.

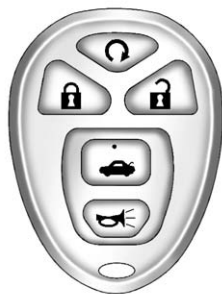

With Remote Start Shown, Without Remote Start Similar

⤵ (Remote Vehicle Start): For vehicles with this feature, press to operate the remote start feature. See *Remote Vehicle Start* on page 2-5 for additional information.

🔒 (Lock): Press to lock all the doors. The interior lamps turn off after all of the doors are closed.

If enabled through the Driver Information Center (DIC), the remote lock feedback can be programmed to have the horn chirp and/or the turn signals flash to confirm locking. See "LOCK HORN" and "LIGHT FLASH" under *Vehicle Personalization* on page 5-29 for more information.

Pressing **🔒** may also arm the anti-theft alarm system. See *Anti-theft Alarm System* on page 2-11.

🔓 (Unlock): Press once to unlock the driver door. Press **🔓** again within five seconds to unlock all remaining doors. The interior lamps turn on and stay on for 20 seconds or until the ignition is turned on. If enabled through the DIC, the remote unlock feedback can be programmed to have the horn chirp and/or the turn signals flash to confirm unlocking. See "UNLOCK HORN" and "LIGHT FLASH" under *Vehicle Personalization* on page 5-29 for more information.

2-4 Keys, Doors, and Windows

The high-beam headlamps, parking lamps, and back-up lamps may come on each time  is pressed. See “EXT (Exterior) LIGHTS” under *Vehicle Personalization on page 5-29* for additional information.

Pressing  on the RKE transmitter disarms the anti-theft alarm system. See *Anti-theft Alarm System on page 2-11*.

(Remote Trunk Release):

Press and hold for about one second to unlock the trunk. The trunk can be opened with the transmitter when the vehicle speed is less than 3 km/h (2 mph) or when the ignition is off.

(Vehicle Locator/Panic

Alarm): Press and release to locate the vehicle. The horn sounds three times and the headlamps and turn signals flash three times.

Press and hold  for more than two seconds to initiate the panic alarm. The horn sounds and the

headlamps and turn signals flash for 30 seconds. Press  again to cancel the panic alarm.

Programming Transmitters to the Vehicle

Only RKE transmitters programmed to the vehicle will work. If a transmitter is lost or stolen, a replacement can be purchased and programmed through your dealer. When the replacement transmitter is programmed to the vehicle, all remaining transmitters must also be programmed. Any lost or stolen transmitters no longer work once the new transmitter is programmed. Each vehicle can have up to four transmitters programmed to it.

Battery Replacement

Replace the battery if the KEY FOB BATT (Battery) LOW message displays in the DIC. See “KEY FOB BATT (Battery) LOW” under *Key and Lock Messages on page 5-26* for additional information.

Notice: When replacing the battery, do not touch any of the circuitry on the transmitter. Static from your body could damage the transmitter.

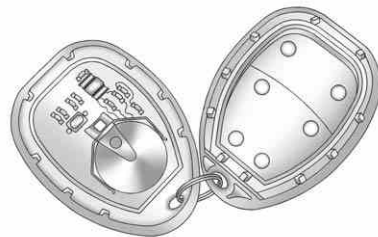

To replace the battery:

1. Separate the transmitter with a flat, thin object inserted into the notch on the side.
2. Remove the old battery. Do not use a metal object.

3. Insert the new battery, positive side facing up. Replace with a CR2032 or equivalent battery.
4. Snap the transmitter back together.

Remote Vehicle Start

Your vehicle may have a remote starting feature that allows you to start the engine from outside the vehicle. It may also start the vehicle's heating or air conditioning systems and rear window defogger. When the remote start system is active and the vehicle has an automatic climate control system, it will automatically regulate the inside temperature. Normal operation of these systems will return after the ignition key is turned to ON/RUN.

Laws in some communities may restrict the use of remote starters. For example, some laws may require a person using remote start to have the vehicle in view when

doing so. Check local regulations for any requirements on remote starting of vehicles.

Do not use the remote start feature if your vehicle is low on fuel. Your vehicle may run out of fuel.

If your vehicle has the remote start feature, the RKE transmitter functions will have an increased range of operation. However, the range may be less while the vehicle is running.

There are other conditions which can affect the performance of the transmitter, see *Remote Keyless Entry (RKE) System on page 2-2* for additional information.

 **(Remote Start):** This button will be on the RKE transmitter if the vehicle has remote start.

To start the vehicle using the remote start feature:

1. Aim the transmitter at the vehicle.
2. Press and release the transmitter's lock button, then immediately press and hold the transmitter's remote start button for about four seconds or until the vehicle's turn signal lamps flash. The doors will lock.

When the vehicle starts, the parking lamps turn on and remain on while the engine is running.

The remote start feature provides two separate starts per ignition cycle, each with 10 minutes of engine running time, or one start with a time extension. The first start must expire or be canceled to get two separate 10 minute starts.

2-6 Keys, Doors, and Windows

If it is the first remote start since the vehicle has been driven, repeat the previous steps, while the engine is still running, to extend the engine running time by 10 minutes from the time you repeat the steps for remote starting. The remote start running time can be extended one time and only after the first remote start.

After entering the vehicle during a remote start, insert and turn the key to ON/RUN to drive the vehicle.

The engine will shut off automatically after 10 minutes, unless a time extension has been done or the vehicle's key is inserted into the ignition switch and turned to ON/RUN.

To manually shut off a remote start, do any of the following.

- Aim the RKE transmitter at the vehicle and press and release the remote start button.

- Turn on the hazard warning flashers.
- Turn the ignition switch out of LOCK/OFF position and then back to LOCK/OFF.

The parking lamps turn off to indicate the engine is off.

After the engine has been started two times, or one time with a time extension, the vehicle's ignition must be turned to ON/RUN using the key before the remote start procedure can be used again. See *Ignition Positions on page 9-15* for information regarding the ignition positions on your vehicle.

The remote vehicle start feature will not operate if any of the follow occur:

- The vehicle's key is in the ignition.
- The vehicle's hood is open.

- The hazard warning flashers are on.
- The check engine light is on. See *Malfunction Indicator Lamp on page 5-14*.
- The engine coolant temperature is too high.
- The oil pressure is low.
- Two remote vehicle starts, or one start with a time extension, have already been provided for that ignition cycle.

Remote Start Ready

If your vehicle does not have the remote vehicle start feature, it may have the remote start ready feature. This feature allows your dealer to add the manufacturer's remote vehicle start feature.

See your dealer if you would like to add the manufacturer's remote vehicle start feature to your vehicle.

Door Locks

WARNING

Unlocked doors can be dangerous.

- Passengers, especially children, can easily open the doors and fall out of a moving vehicle. When a door is locked, the handle will not open it. The chance of being thrown out of the vehicle in a crash is increased if the doors are not locked. So, all passengers should wear safety belts properly and the doors should be locked whenever the vehicle is driven.
- Young children who get into unlocked vehicles may be unable to get out. A child can be overcome by extreme heat and can suffer permanent

(Continued)

WARNING (Continued)

injuries or even death from heat stroke. Always lock the vehicle whenever leaving it.

- Outsiders can easily enter through an unlocked door when you slow down or stop the vehicle. Locking the doors can help prevent this from happening.

There are several ways to lock and unlock your vehicle.

From the outside, turn the key in the driver door lock counterclockwise to lock the door and clockwise to unlock it, or use the Remote Keyless Entry (RKE) transmitter.

From the inside, move the manual lock control on the door or use the power door lock switch.

Power Door Locks

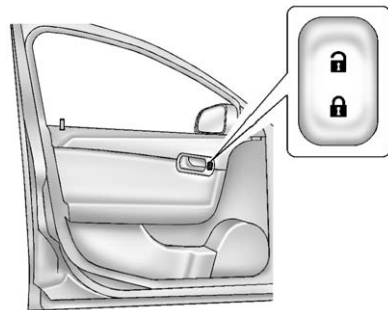

 **(Unlock):** Press to unlock the doors.

 **(Lock):** Remove the key from the ignition and press to lock the doors.

2-8 Keys, Doors, and Windows

Door Ajar Reminder

A chime will sound and the appropriate door message will display if one of the doors is not fully closed. This happens when the ignition is on and the shift lever is moved out of P (Park) or N (Neutral). See *Door Ajar Messages* on page 5-25.

Delayed Locking

This feature will delay the actual locking of the doors and arming of the theft-deterrent system for five seconds when the power door lock switch or remote keyless entry transmitter is used to lock the vehicle.

If any door is open when locking the vehicle, three chimes will sound signaling that the delayed locking feature is active. Five seconds after the last door is closed, all of the doors will lock. To cancel the delay and lock the doors immediately,

press the lock button on the remote keyless entry transmitter or the power door lock switch a second time. The theft deterrent system will arm after 30 seconds.

Automatic Door Locks

The vehicle is programmed to lock all doors automatically when the following are met:

- All doors are closed.
- The ignition is on.
- The vehicle is shifted out of P (Park).

This feature cannot be disabled.

All doors will unlock when the vehicle is shifted into P (Park).

The power door unlock function can be programmed through prompts displayed on the Driver Information Center (DIC). See *Vehicle Personalization* on page 5-29.

Lockout Protection

If you press the power door lock switch when the key is in the ignition and any door is open, all the doors will lock and then the driver's door will unlock. Be sure to remove the key from the ignition when locking your vehicle.

If the remote keyless entry transmitter is used to lock the doors while the key is in the ignition, a chime will sound three times. All doors will then lock.

Safety Locks

The vehicle has rear door security locks to prevent passengers from opening the rear doors from the inside.

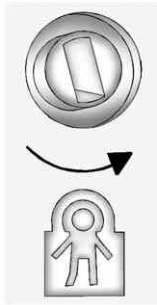

Open the rear doors to access the security locks on the inside edge of each door.

To set the locks, insert a key into the slot and turn it to the horizontal position. The door can only be opened from the outside with the door unlocked. To return the door to normal operation, turn the slot to the vertical position.

Doors

Trunk

WARNING

Exhaust gases can enter the vehicle if it is driven with the liftgate, trunk/hatch open, or with any objects that pass through the seal between the body and the trunk/hatch or liftgate. Engine exhaust contains carbon monoxide (CO) which cannot be seen or smelled. It can cause unconsciousness and even death.

If the vehicle must be driven with the liftgate, or trunk/hatch open:

- Close all of the windows.
- Fully open the air outlets on or under the instrument panel.

(Continued)

WARNING (Continued)

- Adjust the Climate Control System to a setting that brings in only outside air and set the fan speed to the highest setting. See “Climate Control Systems” in the Index.
- If the vehicle is equipped with a power liftgate, disable the power liftgate function.

For more information about carbon monoxide, see *Engine Exhaust* on page 9-21.

Trunk Release

To open the trunk from the outside, press the trunk release button on the RKE transmitter.

2-10 Keys, Doors, and Windows

Remote Trunk Release

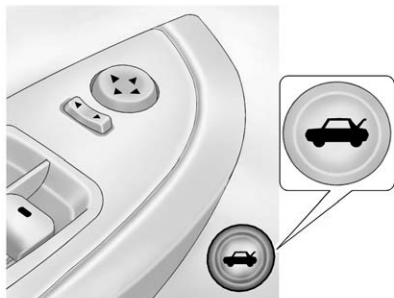

Press the button located on the driver door near the map pocket to open the trunk.

The trunk can only be opened while the vehicle is in P (Park) or when the ignition is off.

Close the trunk by pulling on the handle.

Emergency Trunk Release Handle

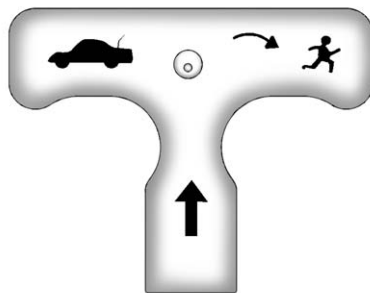

Notice: Do not use the emergency trunk release handle as a tie-down or anchor point when securing items in the trunk as it could damage the handle.

The emergency trunk release handle is only intended to aid a person trapped in a latched trunk, enabling them to open the trunk from the inside.

There is a glow-in-the-dark emergency trunk release handle located inside the trunk on the trunk latch. This handle glows following exposure to light. Pull the release handle up to open the trunk from the inside.

Vehicle Security

This vehicle has theft-deterrent features; however, they do not make it impossible to steal.

Anti-theft Alarm System

Your vehicle may have an anti-theft alarm system.

Arming the System

With the ignition off, press the Remote Keyless Entry (RKE) transmitter lock button to arm the system.

The system will arm 30 seconds after all the doors are closed, or 60 seconds with any door open.

If you press the lock button on the transmitter a second time while all the doors are closed, the system will arm immediately. The system will still arm in 60 seconds if a door is open. When the open door is closed, the system will arm.



The security light, located on the instrument panel cluster, comes on to indicate that arming has been initiated. Once the system is armed, the security light flashes once every three seconds.

If the security light is flashing twice per second, this means that a door is open.

If the system is armed and the key is used to unlock the vehicle, the alarm will be activated.

If you do not want to arm the system, lock the vehicle with the manual lock knob on the doors or with the inside power door lock switches.

The alarm will sound and the exterior lights will flash if any door is opened while armed.

Disarming the System

To disarm the system:

- Press the RKE transmitter unlock button.
- Turn the ignition to ON/RUN.

Once the system is disarmed, the security light will stop flashing.

How the System Alarm is Activated

To activate the system if it is armed:

- Open the driver's door or trunk. A ten second pre-alarm chirp will sound followed by a thirty second full alarm of horn and lights.
- Open any other door. A full alarm of horn and lights will immediately sound for thirty seconds.
- Open the hood. If the vehicle has the remote start feature, it will activate the full alarm.

2-12 Keys, Doors, and Windows

When an alarm event has finished, the system will re-arm itself automatically.

How to Turn Off the System Alarm

To turn off the system alarm:

- Press the lock button on the RKE transmitter. The system will then re-arm itself.
- Press the unlock button on the RKE transmitter. This will also disarm the system.
- Insert the key in the ignition and turn it on. This will also disarm the system.

How to Detect a Tamper Condition

If three chirps are heard when the unlock or lock button is pressed on the RKE transmitter, it means that the system alarm was previously triggered.

Immobilizer

See *Radio Frequency Statement on page 13-20* for information regarding Part 15 of the Federal Communications Commission (FCC) rules and Industry Canada Standards RSS-GEN/210/220/310.

Immobilizer Operation

This vehicle has a passive theft-deterrent system.

The system does not have to be manually armed or disarmed.

The vehicle is automatically immobilized when the key is removed from the ignition.

The system is automatically disarmed when the vehicle is started with the correct key. The key uses a transponder that matches an immobilizer control unit in the vehicle and automatically disarms

the system. Only the correct key starts the vehicle. The vehicle may not start if the key is damaged.



The security light, located in the instrument panel cluster, comes on if there is a problem with arming or disarming the theft-deterrent system.

When trying to start the vehicle, the security light comes on briefly when the ignition is turned on.

If the engine does not start and the security light stays on there is a problem with the system. Turn the ignition off and try again.

If the engine still does not start, and the key appears to be undamaged or the light continues to stay on, try another ignition key. If the engine does not start with the other key, the vehicle needs service. If the vehicle does start, the first key may be damaged. See your dealer who can service the theft-deterrent system and have a new key made.

It is possible for the theft-deterrent system decoder to learn the transponder value of a new or replacement key. Up to 10 keys can be programmed for the vehicle. The following procedure is for programming additional keys only.

To program the new key:

1. Verify that the new key has a ⊕ stamped on it.
2. Insert the already programmed key in the ignition and start the engine. If the engine will not start, see your dealer for service.

3. After the engine has started, turn the key to LOCK/OFF, and remove the key.
4. Insert the key to be programmed and turn it to ON/RUN within five seconds of the original key being turned to LOCK/OFF in Step 3.

The security light will turn off once the key has been programmed. It may not be apparent that the security light went on due to how quickly the key is programmed.

5. Repeat Steps 1 through 4 if additional keys are to be programmed.

Do not leave the key or device that disarms or deactivates the theft deterrent system in the vehicle.

Exterior Mirrors

Convex Mirrors



WARNING

A convex mirror can make things, like other vehicles, look farther away than they really are. If you cut too sharply into the right lane, you could hit a vehicle on the right. Check the inside mirror or glance over your shoulder before changing lanes.

The passenger side mirror is convex shaped. A convex mirror's surface is curved so more can be seen from the driver seat.

Power Mirrors

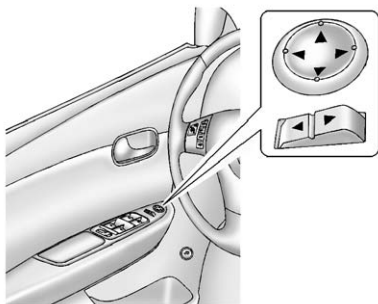

Controls for the outside power mirrors are located on the driver door.

To adjust the mirrors:

1. Move the selector switch located below the four-way control pad to the left or right to choose either the driver side or passenger side mirror.

2. Press one of the four arrows located on the control pad to move the mirror in the desired direction.
3. Adjust each outside mirror so that a little of the vehicle and the area behind it can be seen.

Keep the selector switch in the center position when not adjusting either outside mirror.

Manually fold the mirrors inward to prevent damage when going through an automatic car wash. To fold, push the mirror toward the vehicle. Push the mirror outward to return it to its original position.

Heated Mirrors

For vehicles with heated mirrors:

 (**Rear Defogger**): Press to heat the mirrors.

See “Rear Window Defogger” under *Automatic Climate Control System* on page 8-5 for more information.

Interior Mirrors

Manual Rearview Mirror

Hold the inside rearview mirror in the center to move it for a clearer view of behind your vehicle. Adjust the mirror to avoid glare from the headlamps behind. Push the tab forward for daytime use and pull it for nighttime use.

Vehicles with OnStar[®] have three control buttons located at the bottom of the mirror. See your dealer for more information on the system and how to subscribe to OnStar. See *OnStar Overview* on page 14-1.

Automatic Dimming Rearview Mirror

The vehicle may have an automatic dimming inside rearview mirror with a compass display and OnStar[®] controls. See your dealer for more

information on the system and how to subscribe to OnStar®. See *OnStar Overview on page 14-1*.

Press  to turn the compass display on or off.

See *Compass on page 5-4* for more information.

Automatic Dimming Mirror Operation

Vehicles with an automatic dimming rearview mirror will automatically reduce the glare from the headlamps of the vehicle behind. This feature comes on each time the vehicle is started.

To turn the automatic dimming feature off or on, press and hold  for approximately six seconds or until the indicator light turns off or on.

Cleaning the Mirror

Do not spray glass cleaner directly on the mirror. Use a soft towel dampened with water.

Windows

WARNING

Leaving children, helpless adults, or pets in a vehicle with the windows closed is dangerous. They can be overcome by the extreme heat and suffer permanent injuries or even death from heat stroke. Never leave a child, a helpless adult, or a pet alone in a vehicle, especially with the windows closed in warm or hot weather.



The vehicle aerodynamics are designed to improve fuel economy performance. This may result in a pulsing sound when a window is partially open. To reduce the sound, open another window or the sunroof (if equipped).

Power Windows



Press the front of the switch to open the window. Pull the switch up to close it.

Express-Down Window

The driver window has an express-down feature. This switch is labeled AUTO. Press the front all the way down and release, to automatically lower.

To stop the window while it is lowering, pull the front of the switch momentarily. To raise the window, pull and hold the front of the switch.

Express-Up Window

On windows with this feature, pull the switch up to the second position and release the switch to activate the express-up feature. To stop the window as it is going up, pull up or press down briefly on the switch again.

Programming the Power Windows

If the battery on the vehicle has been recharged or disconnected, or is not working, the driver power window will need to be re-programmed for the express-up feature to work. Replace or recharge the vehicle battery before reprogramming.

To program the driver window:

1. With the ignition in ACC/ ACCESSORY or ON/RUN, or when Retained Accessory Power (RAP) is active, close all doors.
2. Press and hold the power window switch until the window is fully open.
3. Pull the power window switch up until the window is fully closed.
4. Continue holding the switch up for approximately two seconds after the window is completely closed.

The window is now reprogrammed.

Express Window Anti-Pinch Feature

If any object is in the path of the window when the express-up is active, the window stops at the obstruction and auto-reverses to a preset factory position. Weather

conditions such as severe icing may also cause the window to auto-reverse. The window returns to normal operation once the obstruction or condition is removed.

Express Window Anti-Pinch Override

⚠ WARNING

If express override is activated, the window will not reverse automatically. You or others could be injured and the window could be damaged. Before you use express override, make sure that all people and obstructions are clear of the window path.

In an emergency, the anti-pinch feature can be overridden in a supervised mode. Hold the window switch all the way up to the second position. The window rises for as long as the switch is held. Once the switch is released, the express mode is re-activated.

In this mode, the window can still close on an object in its path. Use care when using the override mode.

Window Lockout

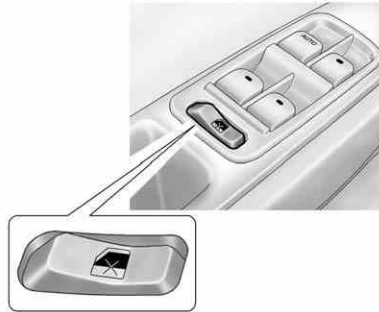

The rear window lockout switch is on the driver door. This feature prevents the rear passenger windows from operating, except from the driver position.

Press  on the right side to activate the lockout switch. The red line on the switch is not visible when activated.

Press  on the left side to deactivate the lockout switch. The red line on the switch is visible when deactivated.

Sun Visors

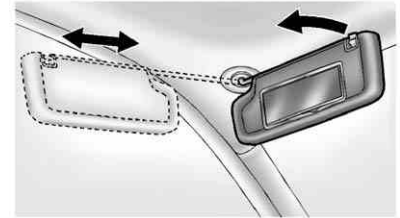

Pull the sun visor down to block glare. Detach the sun visor from the center mount to pivot to the side window, or to extend along the rod, if available.

Roof

Sunroof



The sunroof only operates when the ignition is in ON/RUN or ACC/ACCESSORY, or if Retained Accessory Power (RAP) is active. See *Retained Accessory Power (RAP)* on page 9-18.

Press and release the back of the switch to open the sunroof to the vent position. From the vent position, press and release the back

of the switch to express-open the sunroof. To stop the sunroof from express-opening, press the switch again. If the sunshade is closed, it will open automatically when the sunroof opens past the vented position.

A deflector will automatically raise when the sunroof is opened. The deflector will retract when the sunroof is closed.

To close the sunroof, press the front of the switch and hold it until the sunroof is closed. The sunroof will stop if the switch is released. Close the sunshade by hand.

The sunroof glass panel cannot be opened or closed if the vehicle has an electrical failure.

Notice: Forcing the sunshade forward of the sliding glass panel may cause damage and the sunroof may not operate properly. Always close the glass panel before closing the sunshade.

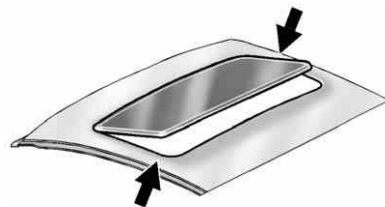

Dirt and debris may collect on the sunroof seal or in the track. This could cause an issue with sunroof operation or noise. It could also plug the water drainage system. Periodically open the sunroof and remove any obstacles or loose debris. Wipe the sunroof seal and roof sealing area using a clean cloth, mild soap, and water. Do not remove grease from the sunroof.

Seats and Restraints

Head Restraints

Head Restraints 3-2

Front Seats

Seat Adjustment 3-3

Power Seat Adjustment 3-4

Lumbar Adjustment 3-4

Reclining Seatbacks 3-4

Heated Front Seats 3-6

Rear Seats

Rear Seats 3-7

Safety Belts

Safety Belts 3-8

How to Wear Safety Belts

Properly 3-10

Lap-Shoulder Belt 3-11

Safety Belt Use During

Pregnancy 3-15

Safety Belt Extender 3-16

Safety System Check 3-16

Safety Belt Care 3-16

Replacing Safety Belt System

Parts after a Crash 3-16

Airbag System

Airbag System 3-17

Where Are the Airbags? 3-19

When Should an Airbag

Inflate? 3-21

What Makes an Airbag

Inflate? 3-22

How Does an Airbag

Restrain? 3-22

What Will You See after an

Airbag Inflates? 3-22

Passenger Sensing

System 3-24

Servicing the Airbag-Equipped

Vehicle 3-28

Adding Equipment to the

Airbag-Equipped Vehicle ... 3-28

Airbag System Check 3-29

Replacing Airbag System

Parts after a Crash 3-29

Child Restraints

Older Children 3-30

Infants and Young

Children 3-32

Child Restraint Systems 3-34

Where to Put the Restraint ... 3-36

Lower Anchors and Tethers

for Children (LATCH

System) 3-38

Replacing LATCH System

Parts After a Crash 3-45

Securing Child Restraints

(Rear Seat) 3-45

Securing Child Restraints

(Front Passenger Seat) 3-47

3-2 Seats and Restraints

Head Restraints

The vehicle's front and rear seats have adjustable head restraints in the outboard seating positions.

WARNING

With head restraints that are not installed and adjusted properly, there is a greater chance that occupants will suffer a neck/spinal injury in a crash. Do not drive until the head restraints for all occupants are installed and adjusted properly.



Adjust the head restraint so that the top of the restraint is at the same height as the top of the occupant's head. This position reduces the chance of a neck injury in a crash.

The height of the head restraint can be adjusted. Pull the head restraint up to raise it. Try to move the head restraint to make sure that it is locked in place.

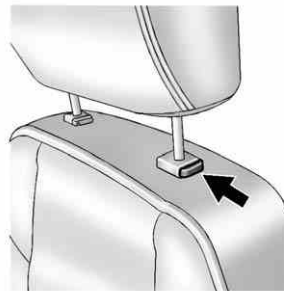

To lower the head restraint, press the button located on top of the seatback, and push the head restraint down. Try to move the head restraint after the button is released to make sure that it is locked in place.

The vehicle's front and rear seat outboard head restraints are not designed to be removed.

Front Seats

Seat Adjustment

Seat Position

⚠ WARNING

You can lose control of the vehicle if you try to adjust a manual driver seat while the vehicle is moving. The sudden movement could startle and confuse you, or make you push a pedal when you do not want to. Adjust the driver seat only when the vehicle is not moving.

To adjust the seat position:

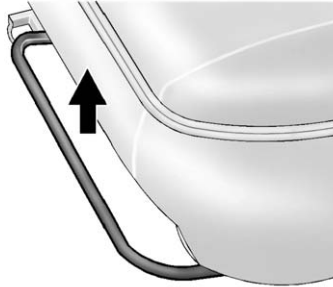

1. Lift the bar under the front of the seat cushion to unlock the seat.
2. Slide the seat to the desired position and release the bar.
3. Try to move the seat back and forth to make sure it is locked in place.

Height Adjustment

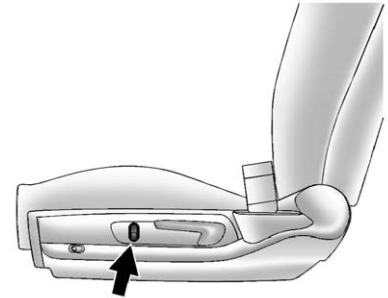

If available, press and hold the top or bottom of the switch to raise or lower the seat. Release the switch when the desired height is reached.

3-4 Seats and Restraints

Power Seat Adjustment

WARNING

You can lose control of the vehicle if you try to adjust the seat while the vehicle is moving. Adjust the driver seat only when the vehicle is not moving.

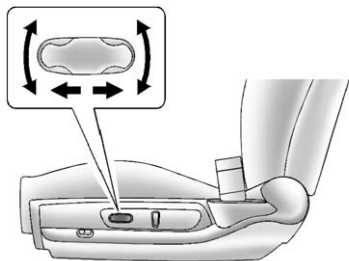

To adjust a power seat, if available:

- Move the seat forward or rearward by sliding the control forward or rearward.

- Raise or lower the front or rear part of the seat cushion by moving the front or rear of the control up or down.
- Raise or lower the entire seat by moving the entire control up or down.

Lumbar Adjustment

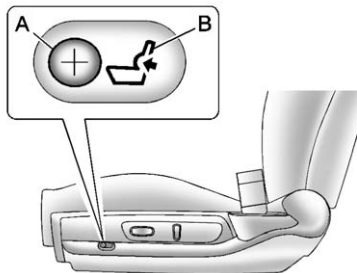

- A. Increase Lumbar Support Control
- B. Decrease Lumbar Support Control

If available, press the front (A) or rear (B) of the control to increase or decrease lumbar support. Release the control when the desired level of support is reached.

Reclining Seatbacks

WARNING

Sitting in a reclined position when the vehicle is in motion can be dangerous. Even when buckled up, the safety belts cannot do their job when reclined like this.

The safety belt cannot properly restrain you, and you could be injured or killed.

For proper protection when the vehicle is in motion, have the seatback upright. Then sit well back in the seat and wear the safety belt properly.



Do not have a seatback reclined if the vehicle is moving.

Manual Reclining Seatbacks

WARNING

You can lose control of the vehicle if you try to adjust a manual driver seat while the vehicle is moving. The sudden movement could startle and confuse you, or make you push a pedal when you do not want to. Adjust the driver seat only when the vehicle is not moving.

WARNING

If either seatback is not locked, it could move forward in a sudden stop or crash. That could cause injury to the person sitting there. Always push and pull on the seatbacks to be sure they are locked.

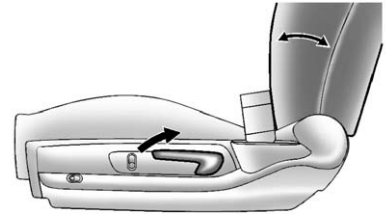

To recline the seatback:

1. Lift the lever.
2. Move the seatback to the desired position, and then release the lever to lock the seatback in place.
3. Push and pull on the seatback to make sure it is locked.

3-6 Seats and Restraints

To return the seatback to the upright position:

1. Lift the lever fully without applying pressure to the seatback, and the seatback will return to the upright position.
2. Push and pull on the seatback to make sure it is locked.

Power Reclining Seatbacks

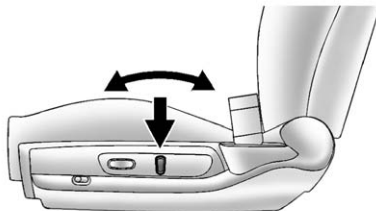

To adjust a power seatback, if equipped:

- Tilt the top of the control rearward to recline.
- Tilt the top of the control forward to raise.

Heated Front Seats

WARNING

If you cannot feel temperature change or pain to the skin, the seat heater may cause burns even at low temperatures. To reduce the risk of burns, people with such a condition should use care when using the seat heater, especially for long periods of time. Do not place anything on the seat that insulates against heat, such as a blanket, cushion, cover, or similar item. This may cause the seat heater to overheat. An overheated seat heater may cause a burn or may damage the seat.

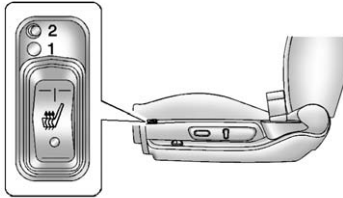

If available, press the top of the switch to turn the heat feature on to the high heat setting. The indicator light “2” will be lit.

Press the top of the switch again to go to the low heat setting. The indicator light “1” will be lit.

Press the bottom of the switch to turn the feature off.

The heated seats are canceled when the ignition is turned off.

Rear Seats

Folding the Seatback

Either side of the seatback can be folded down for more cargo space. Adjust the seatback only when the vehicle is not moving.

Notice: Folding a rear seat with the safety belts still fastened may cause damage to the seat or the safety belts. Always unbuckle the safety belts and return them to their normal stowed position before folding a rear seat.

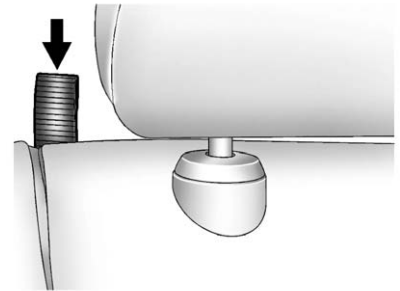

To fold the seatback down:

1. Make sure the front seatback is not reclined. If it is, the rear seatback will not fold down all the way. If necessary, return the front seatback to the upright position. See *Reclining Seatbacks* on page 3-4.
2. Pull up on the seatback strap while folding the seatback down.

Raising the Seatback

WARNING

A safety belt that is improperly routed, not properly attached, or twisted will not provide the protection needed in a crash. The person wearing the belt could be seriously injured. After raising the rear seatback, always check to be sure that the safety belts are properly routed and attached, and are not twisted.

WARNING

If either seatback is not locked, it could move forward in a sudden stop or crash. That could cause injury to the person sitting there. Always push and pull on the seatbacks to be sure they are locked.

To raise the seatback:

1. Push the seatback up and back to lock it into place.
2. Push and pull the top of the seatback to be sure it is locked into position.
3. Make sure that the safety belts are properly stowed over the seatback in all three seating positions.

When the seat is not in use, it should be kept in the upright, locked position.

Safety Belts

This section of the manual describes how to use safety belts properly. It also describes some things not to do with safety belts.

WARNING

Do not let anyone ride where a safety belt cannot be worn properly. In a crash, if you or your passenger(s) are not wearing safety belts, injuries can be much worse than if you are wearing safety belts. You can be seriously injured or killed by hitting things inside the vehicle harder or by being ejected from the vehicle. In addition, anyone who is not buckled up can strike other passengers in the vehicle.

(Continued)

WARNING (Continued)

It is extremely dangerous to ride in a cargo area, inside or outside of a vehicle. In a collision, passengers riding in these areas are more likely to be seriously injured or killed. Do not allow passengers to ride in any area of the vehicle that is not equipped with seats and safety belts.

Always wear a safety belt, and check that all passenger(s) are restrained properly too.

This vehicle has indicators as a reminder to buckle the safety belts. See *Safety Belt Reminders* on page 5-12 for additional information.

Why Safety Belts Work

When riding in a vehicle, you travel as fast as the vehicle does. If the vehicle stops suddenly, you keep going until something stops you. It could be the windshield, the instrument panel, or the safety belts!

When you wear a safety belt, you and the vehicle slow down together. There is more time to stop because you stop over a longer distance and, when worn properly, your strongest bones take the forces from the

safety belts. That is why wearing safety belts makes such good sense.

Questions and Answers About Safety Belts

- Q: Will I be trapped in the vehicle after a crash if I am wearing a safety belt?**
- A:** You *could* be— whether you are wearing a safety belt or not. Your chance of being conscious during and after a crash, so you *can* unbuckle and get out, is *much* greater if you are belted.
- Q: If my vehicle has airbags, why should I have to wear safety belts?**
- A:** Airbags are supplemental systems only; so they work *with* safety belts— not instead of them. Whether or not an airbag is provided, all occupants still have to buckle up to get the most protection.

3-10 Seats and Restraints

Also, in nearly all states and in all Canadian provinces, the law requires wearing safety belts.

How to Wear Safety Belts Properly

This section is only for people of adult size.

There are special things to know about safety belts and children. And there are different rules for smaller children and infants. If a child will be riding in the vehicle, see *Older Children on page 3-30* or *Infants and Young Children on page 3-32*. Follow those rules for everyone's protection.

It is very important for all occupants to buckle up. Statistics show that unbelted people are hurt more often in crashes than those who are wearing safety belts.

There are important things to know about wearing a safety belt properly.

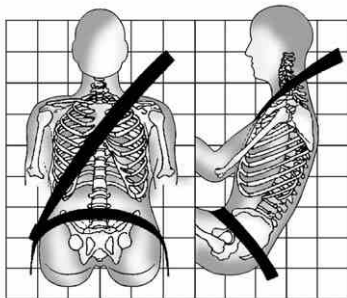

- Sit up straight and always keep your feet on the floor in front of you.
- Always use the correct buckle for your seating position.
- Wear the lap part of the belt low and snug on the hips, just touching the thighs. In a crash, this applies force to the strong pelvic bones and you would be less likely to slide under the lap belt. If you slid under it, the belt would apply force on your abdomen. This could cause serious or even fatal injuries.

- Wear the shoulder belt over the shoulder and across the chest. These parts of the body are best able to take belt restraining forces. The shoulder belt locks if there is a sudden stop or crash.

WARNING

You can be seriously injured, or even killed, by not wearing your safety belt properly.

- Never allow the lap or shoulder belt to become loose or twisted.
- Never wear the shoulder belt under both arms or behind your back.
- Never route the lap or shoulder belt over an armrest.

Lap-Shoulder Belt

All seating positions in the vehicle have a lap-shoulder belt.

The following instructions explain how to wear a lap-shoulder belt properly.

1. Adjust the seat, if the seat is adjustable, so you can sit up straight. To see how, see “Seats” in the Index.
2. Pick up the latch plate and pull the belt across you. Do not let it get twisted.

The lap-shoulder belt may lock if you pull the belt across you very quickly. If this happens, let the belt go back slightly to unlock it. Then pull the belt across you more slowly.

If the shoulder portion of a passenger belt is pulled out all the way, the child restraint locking feature may be engaged. If this happens, just let the belt go back all the way and start again.

Engaging the child restraint locking feature in the right front seating position may affect the passenger sensing system. See *Passenger Sensing System on page 3-24* for more information.

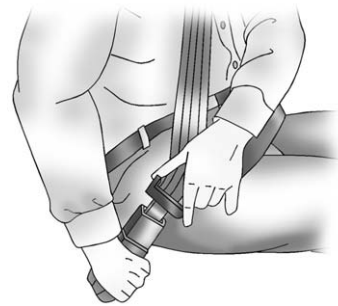

3. Push the latch plate into the buckle until it clicks.
Pull up on the latch plate to make sure it is secure. If the belt is not long enough, see *Safety Belt Extender on page 3-16*.
Position the release button on the buckle so that the safety belt could be quickly unbuckled if necessary.

3-12 Seats and Restraints

4. If equipped with a shoulder belt height adjuster, move it to the height that is right for you. Improper shoulder belt height adjustment could reduce the effectiveness of the safety belt in a crash. See “Shoulder Belt Height Adjuster” later in this section for instruction on use and important safety information.

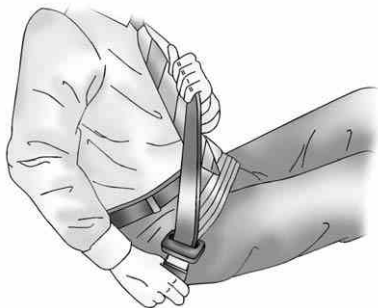

5. To make the lap part tight, pull up on the shoulder belt.

It may be necessary to pull stitching on the safety belt through the latch plate to fully tighten the lap belt on smaller occupants.



To unlatch the belt, push the button on the buckle. The belt should return to its stowed position. Slide the latch plate up the safety belt webbing when the safety belt is not in use. The latch plate should rest on the stitching on the safety belt, near the guide loop on the side wall.

Before a door is closed, be sure the safety belt is out of the way. If a door is slammed against a safety belt, damage can occur to both the safety belt and the vehicle.

Shoulder Belt Height Adjuster

Your vehicle has a shoulder belt height adjuster for the driver and right front passenger position.

Adjust the height so the shoulder portion of the belt is on the shoulder and not falling off of it. The belt should be close to, but not contacting, the neck. Improper shoulder belt height adjustment could reduce the effectiveness of the safety belt in a crash. See *How to Wear Safety Belts Properly* on page 3-10.

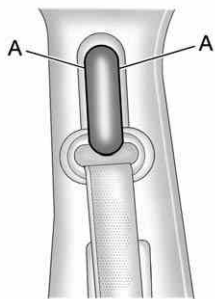

Squeeze the buttons (A) on the sides of the height adjuster and move the height adjuster to the desired position.

After the adjuster is set to the desired position, try to move it down without squeezing the buttons to make sure it has locked into position.

Safety Belt Pretensioners

This vehicle has safety belt pretensioners for the front outboard occupants. Although the safety belt pretensioners cannot be seen, they are part of the safety belt assembly. They can help tighten the safety belts during the early stages of a moderate to severe frontal and near frontal crash if the threshold conditions for pretensioner activation are met. And, if the vehicle has side impact airbags, safety belt pretensioners can help tighten the safety belts in a side crash.

Pretensioners work only once. If they activate in a crash, they will need to be replaced, and probably other new parts for the vehicle's safety belt system. See *Replacing Safety Belt System Parts after a Crash* on page 3-16.

Rear Safety Belt Comfort Guides

This vehicle may have rear shoulder belt comfort guides. If not, they are available through your dealer. The guides may provide added safety belt comfort for older children who have outgrown booster seats and for some adults. When installed and properly adjusted, the comfort guide positions the belt away from the neck and head.

3-14 Seats and Restraints

Here is how to install a comfort guide to the safety belt:

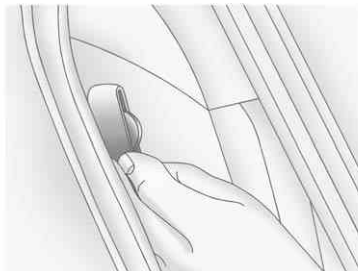

1. Pull the elastic cord out from between the edge of the seatback and the interior body to remove the guide from its storage clip.

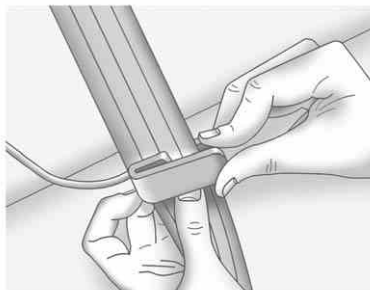

2. Place the guide over the belt and insert the two edges of the belt into the slots of the guide.

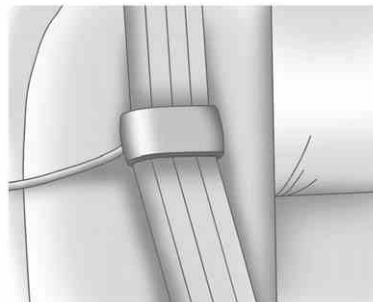

3. Be sure that the belt is not twisted and it lies flat. The elastic cord must be under the belt and the guide on top.

⚠ WARNING

A safety belt that is not properly worn may not provide the protection needed in a crash. The person wearing the belt could be seriously injured. The shoulder belt should go over the shoulder and across the chest. These parts of the body are best able to take belt restraining forces.

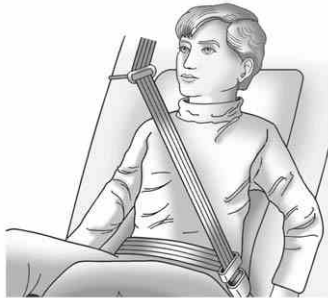

4. Buckle, position, and release the safety belt as described previously in this section. Make sure the shoulder portion of the belt is on the shoulder and not falling off of it. The belt should be close to, but not contacting, the neck.

To remove and store the comfort guide, squeeze the belt edges together so that the safety belt can be removed from the guide. Pull the guide upward to expose its storage clip, and then slide the guide onto the clip. Turn the guide and clip inward and slide them in between the seatback and the interior body, leaving only the loop of the elastic cord exposed.

Safety Belt Use During Pregnancy

Safety belts work for everyone, including pregnant women. Like all occupants, they are more likely to be seriously injured if they do not wear safety belts.



A pregnant woman should wear a lap-shoulder belt, and the lap portion should be worn as low as possible, below the rounding, throughout the pregnancy.

The best way to protect the fetus is to protect the mother. When a safety belt is worn properly, it is more likely that the fetus will not be hurt in a crash. For pregnant women, as for anyone, the key to making safety belts effective is wearing them properly.

Safety Belt Extender

If the vehicle's safety belt will fasten around you, you should use it.

But if a safety belt is not long enough, your dealer will order you an extender. When you go in to order it, take the heaviest coat you will wear, so the extender will be long enough for you. To help avoid personal injury, do not let someone else use it, and use it only for the seat it is made to fit. The extender has been designed for adults. Never use it for securing child seats. To wear it, attach it to the regular safety belt. For more information, see the instruction sheet that comes with the extender.

Safety System Check

Now and then, check that the safety belt reminder light, safety belts, buckles, latch plates, retractors, and anchorages are all working properly. Look for any other loose or damaged safety belt system parts that might keep a safety belt system

from doing its job. See your dealer to have it repaired. Torn or frayed safety belts may not protect you in a crash. They can rip apart under impact forces. If a belt is torn or frayed, get a new one right away.

Make sure the safety belt reminder light is working. See *Safety Belt Reminders on page 5-12* for more information.

Keep safety belts clean and dry. See *Safety Belt Care on page 3-16*.

Safety Belt Care

Keep belts clean and dry.

WARNING

Do not bleach or dye safety belts. It may severely weaken them. In a crash, they might not be able to provide adequate protection. Clean safety belts only with mild soap and lukewarm water.

Replacing Safety Belt System Parts after a Crash

WARNING

A crash can damage the safety belt system in the vehicle. A damaged safety belt system may not properly protect the person using it, resulting in serious injury or even death in a crash. To help make sure the safety belt systems are working properly after a crash, have them inspected and any necessary replacements made as soon as possible.

After a minor crash, replacement of safety belts may not be necessary. But the safety belt assemblies that were used during any crash may have been stressed or damaged.

See your dealer to have the safety belt assemblies inspected or replaced.

New parts and repairs may be necessary even if the safety belt system was not being used at the time of the crash.

Have the safety belt pretensioners checked if the vehicle has been in a crash, or if the airbag readiness light stays on after you start the vehicle or while you are driving. See *Airbag Readiness Light* on page 5-12.

Airbag System

The vehicle has the following airbags:

- A frontal airbag for the driver.
- A frontal airbag for the front outboard passenger.
- A seat-mounted side impact airbag for the driver.
- A seat-mounted side impact airbag for the front outboard passenger.
- A roof-rail airbag for the driver and the passenger seated directly behind the driver.
- A roof-rail airbag for the front outboard passenger and the passenger seated directly behind the front outboard passenger.

All vehicle airbags have the word AIRBAG in the trim or on a label near the deployment opening.

For frontal airbags, the word AIRBAG is on the center of the steering wheel for the driver and on the instrument panel for the front outboard passenger.

For seat-mounted side impact airbags, the word AIRBAG is on the side of the seatback closest to the door.

For roof-rail airbags, the word AIRBAG is on the ceiling or trim.

Airbags are designed to supplement the protection provided by safety belts. Even though today's airbags are also designed to help reduce the risk of injury from the force of an inflating bag, all airbags must inflate very quickly to do their job.

3-18 Seats and Restraints

Here are the most important things to know about the airbag system:

WARNING

You can be severely injured or killed in a crash if you are not wearing your safety belt, even with airbags. Airbags are designed to work with safety belts, not replace them. Also, airbags are not designed to inflate in every crash. In some crashes safety belts are the only restraint. See *When Should an Airbag Inflate?* on page 3-21.

Wearing your safety belt during a crash helps reduce the chance of hitting things inside the vehicle or being ejected from it. Airbags are “supplemental restraints” to the safety belts. Everyone in the vehicle should wear a safety belt properly, whether or not there is an airbag for that person.

WARNING

Because airbags inflate with great force and faster than the blink of an eye, anyone who is up against, or very close to any airbag when it inflates can be seriously injured or killed. Do not sit unnecessarily close to any airbag, as you would be if sitting on the edge of the seat or leaning forward. Safety belts help keep you in position before and during a crash. Always wear a safety belt, even with airbags. The driver should sit as far back as possible while still maintaining control of the vehicle.

Occupants should not lean on or sleep against the door or side windows in seating positions with seat-mounted side impact airbags and/or roof-rail airbags.

WARNING

Children who are up against, or very close to, any airbag when it inflates can be seriously injured or killed. Airbags plus lap-shoulder belts offer protection for adults and older children, but not for young children and infants. Neither the vehicle's safety belt system nor its airbag system is designed for them. Young children and infants need the protection that a child restraint system can provide. Always secure children properly in the vehicle. To read how, see *Older Children* on page 3-30 or *Infants and Young Children* on page 3-32.



There is an airbag readiness light on the instrument panel cluster, which shows the airbag symbol.

The system checks the airbag electrical system for malfunctions. The light tells you if there is an electrical problem. See *Airbag Readiness Light* on page 5-12 for more information.

Where Are the Airbags?



The driver frontal airbag is in the center of the steering wheel.



The front outboard passenger frontal airbag is in the passenger side instrument panel.

3-20 Seats and Restraints



Driver Side shown, Passenger Side similar

The driver and front outboard passenger seat-mounted side impact airbags are in the side of the seatbacks closest to the door.



Driver Side shown, Passenger Side similar

The roof-rail airbags for the driver, front outboard passenger, and second row outboard passengers are in the ceiling above the side windows.

WARNING

If something is between an occupant and an airbag, the airbag might not inflate properly or it might force the object into that person causing severe injury or even death. The path of an inflating airbag must be kept clear. Do not put anything between an occupant and an airbag, and do not attach or put anything on the steering wheel hub or on or near any other airbag covering.

Do not use seat accessories that block the inflation path of a seat-mounted side impact airbag.

Never secure anything to the roof of a vehicle with roof-rail airbags by routing a rope or tie-down through any door or window opening. If you do, the path of an inflating roof-rail airbag will be blocked.

When Should an Airbag Inflate?

Frontal airbags are designed to inflate in moderate to severe frontal or near frontal crashes to help reduce the potential for severe injuries, mainly to the driver's or right front passenger's head and chest. However, they are only designed to inflate if the impact exceeds a predetermined deployment threshold. Deployment thresholds are used to predict how severe a crash is likely to be in time for the airbags to inflate and help restrain the occupants.

Whether the frontal airbags will or should inflate is not based primarily on how fast the vehicle is traveling. It depends on what is hit, the direction of the impact, and how quickly the vehicle slows down.

Frontal airbags may inflate at different crash speeds depending on whether the vehicle hits an object straight on or at an angle, and

whether the object is fixed or moving, rigid or deformable, narrow or wide.

Thresholds can also vary with specific vehicle design.

Frontal airbags are not intended to inflate during vehicle rollovers, rear impacts, or in many side impacts.

In addition, the vehicle has dual-stage frontal airbags. Dual-stage airbags adjust the restraint according to crash severity. The vehicle has electronic frontal sensors, which help the sensing system distinguish between a moderate frontal impact and a more severe frontal impact. For moderate frontal impacts, dual-stage airbags inflate at a level less than full deployment. For more severe frontal impacts, full deployment occurs.

The vehicle has seat-mounted side impact and roof-rail airbags. See *Airbag System on page 3-17*. Seat-mounted side impact and roof-rail airbags are intended to inflate in moderate to severe side

crashes depending on the location of the impact. Seat-mounted side impact and roof-rail airbags will inflate if the crash severity is above the system's designed threshold level. The threshold level can vary with specific vehicle design.

Seat-mounted side impact and roof-rail airbags are not intended to inflate in frontal impacts, near-frontal impacts, rollovers, or rear impacts. A seat-mounted side impact airbag is intended to inflate on the side of the vehicle that is struck. A roof-rail airbag is intended to inflate on the side of the vehicle that is struck.

In any particular crash, no one can say whether an airbag should have inflated simply because of the vehicle or repair costs. For frontal airbags, inflation is determined by what the vehicle hits, the angle of the impact, and how quickly the vehicle slows down. For seat-mounted side impact and roof-rail airbags, deployment is determined by the location and severity of the side impact.

What Makes an Airbag Inflate?

In a deployment event, the sensing system sends an electrical signal triggering a release of gas from the inflator. Gas from the inflator fills the airbag causing the bag to break out of the cover. The inflator, the airbag, and related hardware are all part of the airbag module.

For airbag location, see *Where Are the Airbags?* on page 3-19.

How Does an Airbag Restrain?

In moderate to severe frontal or near frontal collisions, even belted occupants can contact the steering wheel or the instrument panel. In moderate to severe side collisions, even belted occupants can contact the inside of the vehicle.

Airbags supplement the protection provided by safety belts by distributing the force of the impact more evenly over the occupant's body.

But airbags would not help in many types of collisions, primarily because the occupant's motion is not toward those airbags. See *When Should an Airbag Inflate?* on page 3-21 for more information.

Airbags should never be regarded as anything more than a supplement to safety belts.

What Will You See after an Airbag Inflates?

After the frontal airbags and seat-mounted side impact airbags inflate, they quickly deflate, so quickly that some people may not even realize an airbag inflated.

Roof-rail airbags may still be at least partially inflated for some time after they inflate. Some components of the airbag module may be hot for several minutes. For location of the airbags, see *Where Are the Airbags?* on page 3-19.

The parts of the airbag that come into contact with you may be warm, but not too hot to touch. There may be some smoke and dust coming from the vents in the deflated airbags. Airbag inflation does not prevent the driver from seeing out of the windshield or being able to steer the vehicle, nor does it prevent people from leaving the vehicle.

 **WARNING**

When an airbag inflates, there may be dust in the air. This dust could cause breathing problems for people with a history of asthma or other breathing trouble. To avoid this, everyone in the vehicle should get out as soon as it is safe to do so. If you have breathing problems but cannot get out of the vehicle after an airbag inflates, then get fresh air by opening a window or a door. If you experience breathing problems following an airbag deployment, you should seek medical attention.

The vehicle has a feature that may automatically unlock the doors, turn on the interior lamps and hazard warning flashers, and shut off the fuel system after the airbags inflate.

You can lock the doors, and turn off the interior lamps and hazard warning flashers by using the controls for those features.

 **WARNING**

A crash severe enough to inflate the airbags may have also damaged important functions in the vehicle, such as the fuel system, brake and steering systems, etc. Even if the vehicle appears to be drivable after a moderate crash, there may be concealed damage that could make it difficult to safely operate the vehicle.

Use caution if you should attempt to restart the engine after a crash has occurred.

In many crashes severe enough to inflate the airbag, windshields are broken by vehicle deformation.

Additional windshield breakage may also occur from the front outboard passenger airbag.

- Airbags are designed to inflate only once. After an airbag inflates, you will need some new parts for the airbag system. If you do not get them, the airbag system will not be there to help protect you in another crash. A new system will include airbag modules and possibly other parts. The service manual for the vehicle covers the need to replace other parts.
- The vehicle has a crash sensing and diagnostic module which records information after a crash. See *Vehicle Data Recording and Privacy* on page 13-19 and *Vehicle Data Recording* on page 13-19.

3-24 Seats and Restraints

- Let only qualified technicians work on the airbag systems. Improper service can mean that an airbag system will not work properly. See your dealer for service.

Passenger Sensing System

The vehicle has a passenger sensing system for the front outboard passenger position. The passenger airbag status indicator will light on the instrument panel when the vehicle is started.



United States



Canada and Mexico

The words ON and OFF, or the symbol for on and off, are visible during the system check. If you use remote start, if equipped, to start the vehicle, you may not see the system check. When the system check is complete, either the word ON or OFF, or the symbol for on or off, will be visible. See *Passenger Airbag Status Indicator* on page 5-13.

The passenger sensing system turns off the front outboard passenger frontal airbag and seat-mounted side impact airbag under certain conditions. No other airbag is affected by the passenger sensing system.

The passenger sensing system works with sensors that are part of the front outboard passenger seat. The sensors are designed to detect the presence of a properly-seated occupant and determine if the front outboard passenger frontal airbag and seat-mounted side impact airbag should be allowed to inflate or not.

According to accident statistics, children are safer when properly secured in a rear seat in the correct child restraint for their weight and size.

We recommend that children be secured in a rear seat, including: an infant or a child riding in a rear-facing child restraint; a child riding in a forward-facing child seat; an older child riding in a booster seat; and children, who are large enough, using safety belts.

Never put a rear-facing child seat in the front. This is because the risk to the rear-facing child is so great, if the airbag inflates.

 **WARNING**

A child in a rear-facing child restraint can be seriously injured or killed if the passenger frontal airbag inflates. This is because the back of the rear-facing child restraint would be very close to the inflating airbag. A child in a forward-facing child restraint can be seriously injured or killed if the passenger frontal airbag inflates and the passenger seat is in a forward position.

Even if the passenger sensing system has turned off the front outboard passenger airbag(s), no system is fail-safe. No one can guarantee that an airbag will not inflate under some unusual circumstance, even though the airbag(s) are off.

(Continued)

WARNING (Continued)

Secure rear-facing child restraints in a rear seat, even if the airbag(s) are off. If you secure a forward-facing child restraint in the front outboard passenger seat, always move the seat as far back as it will go. It is better to secure the child restraint in a rear seat.

The passenger sensing system is designed to turn off the front outboard passenger airbag and seat-mounted side impact airbag if:

- The front outboard passenger seat is unoccupied.
- The system determines that an infant is present in a rear-facing infant seat.
- The system determines that a small child is present in a child restraint.

- The system determines that a small child is present in a booster seat.
- A front outboard passenger takes his/her weight off of the seat for a period of time.
- The front outboard passenger seat is occupied by a smaller person, such as a child who has outgrown child restraints.
- There is a critical problem with the airbag system or the passenger sensing system.

When the passenger sensing system has turned off the front outboard passenger frontal airbag and seat-mounted side impact airbag, the off indicator will light and stay lit as a reminder that the airbags are off. See *Passenger Airbag Status Indicator* on page 5-13.

3-26 Seats and Restraints

The passenger sensing system is designed to turn on the front outboard passenger frontal airbag and seat-mounted side impact airbag anytime the system senses that a person of adult size is sitting properly in the front outboard passenger seat.

When the passenger sensing system has allowed the airbags to be enabled, the on indicator will light and stay lit as a reminder that the airbags are active.

For some children who have outgrown child restraints and for very small adults, the passenger sensing system may or may not turn off the front outboard passenger frontal airbag and seat-mounted side impact airbag, depending upon the person's seating posture and body build. Everyone in the vehicle who has outgrown child restraints should wear a safety belt properly — whether or not there is an airbag for that person.

WARNING

If the airbag readiness light ever comes on and stays on, it means that something may be wrong with the airbag system. To help avoid injury to yourself or others, have the vehicle serviced right away. See *Airbag Readiness Light* on page 5-12 for more information, including important safety information.

If the On Indicator Is Lit for a Child Restraint

If a child restraint has been installed and the on indicator is lit:

1. Turn the vehicle off.
2. Remove the child restraint from the vehicle.
3. Remove any additional items from the seat such as blankets, cushions, seat covers, seat heaters, or seat massagers.
4. Reinstall the child restraint following the directions provided by the child restraint manufacturer and refer to *Securing Child Restraints (Front Passenger Seat)* on page 3-47 or *Securing Child Restraints (Rear Seat)* on page 3-45.
5. If, after reinstalling the child restraint and restarting the vehicle, the on indicator is still lit, turn the vehicle off. Then slightly recline the vehicle seatback and adjust the seat cushion, if adjustable, to make sure that the vehicle seatback is not pushing the child restraint into the seat cushion.

Also make sure the child restraint is not trapped under the vehicle head restraint. If this happens, adjust the head restraint. See *Head Restraints* on page 3-2.
6. Restart the vehicle.

If the on indicator is still lit, secure the child restraint in a rear seat position in the vehicle and see your dealer.

If the Off Indicator Is Lit for an Adult-Size Occupant



If a person of adult-size is sitting in the front outboard passenger seat, but the off indicator is lit, it could be because that person is not sitting

properly in the seat. Use the following steps to allow the system to detect that person and enable the front outboard passenger frontal airbag and seat-mounted side impact airbag:

1. Turn the vehicle off.
2. Remove any additional material from the seat, such as blankets, cushions, seat covers, seat heaters, or seat massagers.
3. Place the seatback in the fully upright position.
4. Have the person sit upright in the seat, centered on the seat cushion, with legs comfortably extended.
5. Restart the vehicle and have the person remain in this position for two to three minutes after the on indicator is lit.

Additional Factors Affecting System Operation

Safety belts help keep the passenger in position on the seat during vehicle maneuvers and braking, which helps the passenger sensing system maintain the passenger airbag status. See “Safety Belts” and “Child Restraints” in the Index for additional information about the importance of proper restraint use.

A thick layer of additional material, such as a blanket or cushion, or aftermarket equipment such as seat covers, seat heaters, and seat massagers can affect how well the passenger sensing system operates. We recommend that you not use seat covers or other aftermarket equipment except when approved by GM for your specific vehicle. See *Adding Equipment to the Airbag-Equipped Vehicle* on page 3-28 for more information about modifications that can affect how the system operates.

WARNING

Stowing of articles under the passenger seat or between the passenger seat cushion and seatback may interfere with the proper operation of the passenger sensing system.

Servicing the Airbag-Equipped Vehicle

Airbags affect how the vehicle should be serviced. There are parts of the airbag system in several places around the vehicle. Your dealer and the service manual have information about servicing the vehicle and the airbag system. To purchase a service manual, see *Service Publications Ordering Information on page 13-16*.

WARNING

For up to 10 seconds after the vehicle is turned off and the battery is disconnected, an airbag can still inflate during improper service. You can be injured if you are close to an airbag when it inflates. Avoid yellow connectors. They are probably part of the airbag system. Be sure to follow proper service procedures, and make sure the person performing work for you is qualified to do so.

Adding Equipment to the Airbag-Equipped Vehicle

Adding accessories that change the vehicle's frame, bumper system, height, front end, or side sheet metal may keep the airbag system from working properly.

The operation of the airbag system can also be affected by changing or moving any parts of the front seats, safety belts, airbag sensing and diagnostic module, steering wheel, instrument panel, roof-rail airbag modules, ceiling or pillar garnish trim, front sensors, side impact sensors, or airbag wiring.

Your dealer and the service manual have information about the location of the airbag sensors, sensing and diagnostic module, and airbag wiring.

In addition, the vehicle has a passenger sensing system that includes sensors as part of the front outboard passenger seat. The passenger sensing system may not operate properly if the original seat trim is replaced with non-GM covers, upholstery, or trim; or with GM covers, upholstery, or trim designed for a different vehicle. Any object, such as an aftermarket seat

heater or a comfort-enhancing pad or device, installed under or on top of the seat fabric, could also interfere with the operation of the passenger sensing system. This could either prevent proper deployment of the passenger airbag(s) or prevent the passenger sensing system from properly turning off the passenger airbag(s). See *Passenger Sensing System* on page 3-24.

If your vehicle needs to be modified because you have a disability and you have questions about whether the modifications will affect the vehicle's airbag system, or if you have questions about whether the airbag system will be affected if the vehicle is modified for any other reason, call Customer Assistance. See *Customer Assistance Offices (U.S. and Canada)* on page 13-4 or *Customer Assistance Offices (Mexico)* on page 13-5.

Airbag System Check

The airbag system does not need regularly scheduled maintenance or replacement. Make sure the airbag readiness light is working. See *Airbag Readiness Light* on page 5-12 for more information.

Notice: If an airbag covering is damaged, opened, or broken, the airbag may not work properly. Do not open or break the airbag coverings. If there are any opened or broken airbag covers, have the airbag covering and/or airbag module replaced. For the location of the airbags, see *Where Are the Airbags?* on page 3-19. See your dealer for service.

Replacing Airbag System Parts after a Crash

WARNING

A crash can damage the airbag systems in the vehicle. A damaged airbag system may not work properly and may not protect you and your passenger(s) in a crash, resulting in serious injury or even death. To help make sure the airbag systems are working properly after a crash, have them inspected and any necessary replacements made as soon as possible.

If an airbag inflates, you will need to replace airbag system parts. See your dealer for service.

If the airbag readiness light stays on after the vehicle is started or comes on when you are driving, the airbag system may not work properly. Have the vehicle serviced right away. See *Airbag Readiness Light on page 5-12* for more information.

Child Restraints

Older Children

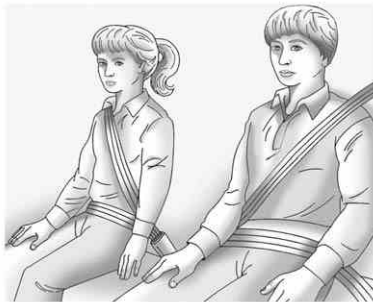

Older children who have outgrown booster seats should wear the vehicle safety belts.

The manufacturer's instructions that come with the booster seat state the weight and height limitations for that booster. Use a booster seat with a lap-shoulder belt until the child passes the fit test below:

- Sit all the way back on the seat. Do the knees bend at the seat edge? If yes, continue. If no, return to the booster seat.
- Buckle the lap-shoulder belt. Does the shoulder belt rest on the shoulder? If yes, continue. If no, try using the rear safety belt comfort guide. See "Rear Safety Belt Comfort Guides" under *Lap-Shoulder Belt on page 3-11* for more information. If the shoulder belt still does not rest on the shoulder, then return to the booster seat.

- Does the lap belt fit low and snug on the hips, touching the thighs? If yes, continue. If no, return to the booster seat.
- Can proper safety belt fit be maintained for the length of the trip? If yes, continue. If no, return to the booster seat.

Q: What is the proper way to wear safety belts?

A: An older child should wear a lap-shoulder belt and get the additional restraint a shoulder belt can provide. The shoulder belt should not cross the face or neck. The lap belt should fit snugly below the hips, just touching the top of the thighs. This applies belt force to the child's pelvic bones in a crash. It should never be worn over the abdomen, which could cause severe or even fatal internal injuries in a crash.

Also see "Rear Safety Belt Comfort Guides" under *Lap-Shoulder Belt on page 3-11*.

According to accident statistics, children and infants are safer when properly restrained in a child restraint system or infant restraint system secured in a rear seating position.

In a crash, children who are not buckled up can strike other people who are buckled up, or can be thrown out of the vehicle. Older children need to use safety belts properly.



⚠ WARNING

Never do this.

Never allow two children to wear the same safety belt. The safety belt cannot properly spread the impact forces. In a crash, the two children can be crushed together and seriously injured. A safety belt must be used by only one person at a time.

⚠ WARNING

Never do this.

Never allow a child to wear the safety belt with the shoulder belt behind their back. A child can be seriously injured by not wearing the lap-shoulder belt properly. In a crash, the child would not be restrained by the shoulder belt.

(Continued)

WARNING (Continued)

The child could move too far forward increasing the chance of head and neck injury. The child might also slide under the lap belt. The belt force would then be applied right on the abdomen. That could cause serious or fatal injuries. The shoulder belt should go over the shoulder and across the chest.



Infants and Young Children

Everyone in a vehicle needs protection! This includes infants and all other children. Neither the distance traveled nor the age and size of the traveler changes the need, for everyone, to use safety restraints. In fact, the law in every state in the United States and in every Canadian province says children up to some age must be restrained while in a vehicle.

⚠ WARNING

Children can be seriously injured or strangled if a shoulder belt is wrapped around their neck and the safety belt continues to tighten. Never leave children unattended in a vehicle and never allow children to play with the safety belts.

Airbags plus lap-shoulder belts offer protection for adults and older children, but not for young children and infants. Neither the vehicle's safety belt system nor its airbag system is designed for them. Every time infants and young children ride in vehicles, they should have the protection provided by appropriate child restraints.

Children who are not restrained properly can strike other people, or can be thrown out of the vehicle.

⚠ WARNING

Never do this.

Never hold an infant or a child while riding in a vehicle. Due to crash forces, an infant or a child will become so heavy it is not possible to hold it during a crash.

(Continued)

WARNING (Continued)

For example, in a crash at only 40 km/h (25 mph), a 5.5 kg (12 lb) infant will suddenly become a 110 kg (240 lb) force on a person's arms. An infant should be secured in an appropriate restraint.

**⚠ WARNING**

Never do this.

Children who are up against, or very close to, any airbag when it inflates can be seriously injured or killed. Never put a rear-facing child restraint in the right front seat. Secure a rear-facing child restraint in a rear seat. It is also better to secure a forward-facing child restraint in a rear seat. If you must secure a forward-facing child restraint in the right front seat, always move the front passenger seat as far back as it will go.

**Q: What are the different types of add-on child restraints?**

A: Add-on child restraints, which are purchased by the vehicle owner, are available in four basic types. Selection of a particular restraint should take into consideration not only the child's weight, height, and age but also whether or not the restraint will be compatible with the motor vehicle in which it will be used.

For most basic types of child restraints, there are many different models available. When purchasing a child restraint, be

3-34 Seats and Restraints

sure it is designed to be used in a motor vehicle. If it is, the restraint will have a label saying that it meets federal motor vehicle safety standards.

The restraint manufacturer's instructions that come with the restraint state the weight and height limitations for a particular child restraint. In addition, there are many kinds of restraints available for children with special needs.

WARNING

To reduce the risk of neck and head injury during a crash, infants need complete support. This is because an infant's neck is not fully developed and its head weighs so much compared with the rest of its body. In a crash, an infant in a rear-facing child restraint settles into the restraint, so the crash forces can be

(Continued)

WARNING (Continued)

distributed across the strongest part of an infant's body, the back and shoulders. Infants should always be secured in rear-facing child restraints.

WARNING

A young child's hip bones are still so small that the vehicle's regular safety belt may not remain low on the hip bones, as it should. Instead, it may settle up around the child's abdomen. In a crash, the belt would apply force on a body area that is unprotected by any bony structure. This alone could cause serious or fatal injuries. To reduce the risk of serious or fatal injuries during a crash, young children should always be secured in appropriate child restraints.

Child Restraint Systems

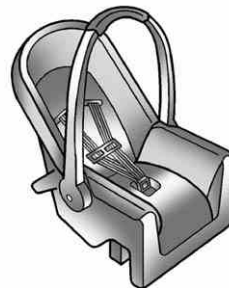

(A) Rear-Facing Infant Seat

A rear-facing infant seat (A) provides restraint with the seating surface against the back of the infant.

The harness system holds the infant in place and, in a crash, acts to keep the infant positioned in the restraint.



(B) Forward-Facing Child Seat

A forward-facing child seat (B) provides restraint for the child's body with the harness.



(C) Booster Seats

A booster seat (C) is a child restraint designed to improve the fit of the vehicle's safety belt system. A booster seat can also help a child to see out the window.

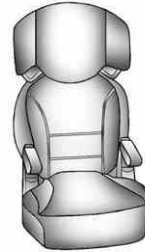

Securing an Add-On Child Restraint in the Vehicle

⚠ WARNING

A child can be seriously injured or killed in a crash if the child restraint is not properly secured in the vehicle. Secure the child restraint properly in the vehicle using the vehicle safety belt or LATCH system, following the instructions that came with that child restraint and the instructions in this manual.

To help reduce the chance of injury, the child restraint must be secured in the vehicle. Child restraint systems must be secured in vehicle seats by lap belts or the lap belt portion of a lap-shoulder belt, or by the LATCH system. See *Lower Anchors and Tethers for Children (LATCH System)* on page 3-38 for more information. Children can be

3-36 Seats and Restraints

endangered in a crash if the child restraint is not properly secured in the vehicle.

When securing an add-on child restraint, refer to the instructions that come with the restraint which may be on the restraint itself or in a booklet, or both, and to this manual. The child restraint instructions are important, so if they are not available, obtain a replacement copy from the manufacturer.

Keep in mind that an unsecured child restraint can move around in a collision or sudden stop and injure people in the vehicle. Be sure to properly secure any child restraint in the vehicle— even when no child is in it.

In some areas of the United States and Canada, Certified Child Passenger Safety Technicians (CPSTs) are available to inspect and demonstrate how to correctly use and install child restraints. In the U.S., refer to the National Highway Traffic Safety

Administration (NHTSA) website to locate the nearest child safety seat inspection station. For CPST availability in Canada, check with Transport Canada or the Provincial Ministry of Transportation office.

Securing the Child Within the Child Restraint

WARNING

A child can be seriously injured or killed in a crash if the child is not properly secured in the child restraint. Secure the child properly following the instructions that came with that child restraint.

Where to Put the Restraint

According to accident statistics, children and infants are safer when properly restrained in a child restraint system or infant restraint system secured in a rear seating position.

We recommend that children and child restraints be secured in a rear seat, including: an infant or a child riding in a rear-facing child restraint; a child riding in a forward-facing child seat; an older child riding in a booster seat; and children, who are large enough, using safety belts.

A label on your sun visor says, “Never put a rear-facing child seat in the front.” This is because the risk to the rear-facing child is so great, if the airbag deploys.

WARNING

A child in a rear-facing child restraint can be seriously injured or killed if the right front passenger airbag inflates. This is because the back of the rear-facing child restraint would be very close to the inflating airbag. A child in a forward-facing child restraint can be seriously injured or killed if the right front

(Continued)

WARNING (Continued)

passenger airbag inflates and the passenger seat is in a forward position.

Even if the passenger sensing system has turned off the right front passenger frontal airbag, no system is fail-safe. No one can guarantee that an airbag will not deploy under some unusual circumstance, even though it is turned off.

Secure rear-facing child restraints in a rear seat, even if the airbag is off. If you secure a forward-facing child restraint in the right front seat, always move the front passenger seat as far back as it will go. It is better to secure the child restraint in a rear seat.

See *Passenger Sensing System* on page 3-24 for additional information.

When securing a child restraint in a rear seating position, study the instructions that came with your child restraint to make sure it is compatible with this vehicle.

Child restraints and booster seats vary considerably in size, and some may fit in certain seating positions better than others. Always make sure the child restraint is properly secured.

Depending on where you place the child restraint and the size of the child restraint, you may not be able to access adjacent safety belt assemblies or LATCH anchors for additional passengers or child restraints. Adjacent seating positions should not be used if the child restraint prevents access to or interferes with the routing of the safety belt.

Wherever you install a child restraint, be sure to secure the child restraint properly.

Keep in mind that an unsecured child restraint can move around in a collision or sudden stop and injure people in the vehicle. Be sure to properly secure any child restraint in your vehicle — even when no child is in it.

If you secure a child restraint in the left or center rear seat using LATCH, review the following illustrations. Depending on where you place the child restraint, you may not be able to access certain safety belt assemblies or LATCH anchors for additional passengers or child restraints.

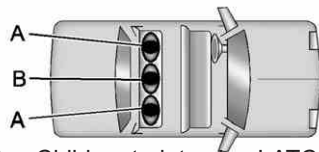
Configurations for Use of Child Restraints

- A. Child restraint using LATCH
- B. Child restraint or occupant using safety belt

3-38 Seats and Restraints

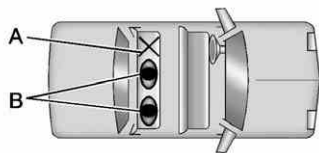

- A. Occupant prohibited
- B. Child restraint using LATCH

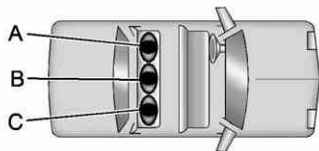

- A. Child restraint using LATCH
- B. Child restraint or occupant using safety belt
- C. Child restraint using safety belt or LATCH or occupant using safety belt

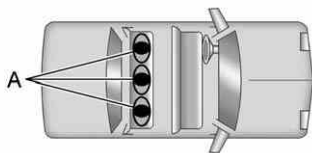

- A. Child restraint or occupant using safety belt

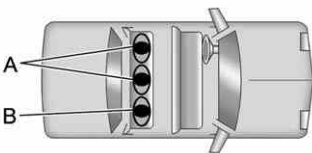

- A. Child restraint or occupant using safety belt
- B. Child restraint using LATCH

Lower Anchors and Tethers for Children (LATCH System)

The LATCH system holds a child restraint during driving or in a crash. This system is designed to make installation of a child restraint easier.

The LATCH system uses anchors in the vehicle and attachments on the child restraint that are made for use with the LATCH system.

Make sure that a LATCH-compatible child restraint is properly installed using the anchors, or use the vehicle's safety belts to secure the restraint, following the instructions that came with that restraint, and also the instructions in this manual. When installing a child restraint with a top tether, you must also use either the lower anchors or the safety belts to properly secure the child restraint. A child restraint must never be installed using only the top tether and anchor.

In order to use the LATCH system in your vehicle, you need a child restraint that has LATCH attachments. The child restraint manufacturer will provide you with instructions on how to use the child restraint and its attachments. The following explains how to attach a child restraint with these attachments in your vehicle.

Not all vehicle seating positions or child restraints have lower anchors and attachments or top tether anchors and attachments.

Lower Anchors

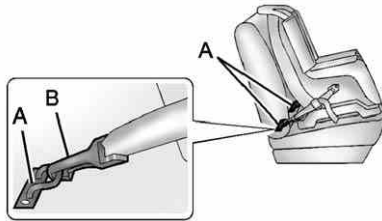

Lower anchors (A) are metal bars built into the vehicle. There are two lower anchors for each LATCH seating position that will accommodate a child restraint with lower attachments (B).

Top Tether Anchor

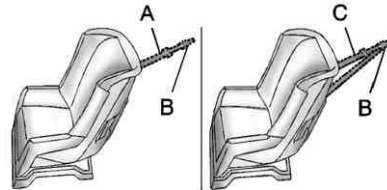

A top tether (A, C) anchors the top of the child restraint to the vehicle. A top tether anchor is built into the vehicle. The top tether attachment (B) on the child restraint connects to the top tether anchor in the vehicle in order to reduce the forward movement and rotation of the child restraint during driving or in a crash.

Your child restraint may have a single tether (A) or a dual tether (C). Either will have a single attachment (B) to secure the top tether to the anchor.

Some child restraints with top tethers are designed for use with or without the top tether being attached. Others require the top tether always to be attached. In Canada, the law requires that forward-facing child restraints have a top tether, and that the tether be attached. Be sure to read and follow the instructions for your child restraint.

3-40 Seats and Restraints

Lower Anchor and Top Tether Anchor Locations



Rear Seat

 (Top Tether Anchor): Seating positions with top tether anchors.

 (Lower Anchor): Seating positions with two lower anchors.



To assist in locating the lower anchors, each rear anchor position has a label, near the crease between the seatback and the seat cushion.



To assist in locating the top tether anchor positions, the top tether anchor symbol is on the cover.

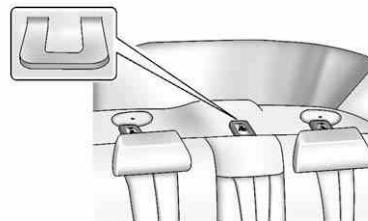

The top tether anchors are under the covers, behind the rear seat, on the filler panel. Be sure to use an anchor on the same side of the vehicle as the seating position where the child restraint will be placed.

Do not secure a child restraint in a position without a top tether anchor if a national or local law requires that the top tether be attached, or if the instructions that come with the child restraint say that the top tether must be attached.

According to accident statistics, children and infants are safer when properly restrained in a child restraint system or infant restraint system secured in a rear seating position. See *Where to Put the Restraint* on page 3-36 for additional information.

Securing a Child Restraint Designed for the LATCH System

 **WARNING**

If a LATCH-type child restraint is not attached to anchors, the child restraint will not be able to protect the child correctly. In a crash, the child could be seriously injured or killed. Install a LATCH-type child restraint properly using the anchors, or use the vehicle safety belts to secure the restraint, following the instructions that came with the child restraint and the instructions in this manual.

 **WARNING**

Do not attach more than one child restraint to a single anchor. Attaching more than one child restraint to a single anchor could cause the anchor or attachment to come loose or even break during a crash. A child or others could be injured. To reduce the risk of serious or fatal injuries during a crash, attach only one child restraint per anchor.

 **WARNING**

Children can be seriously injured or strangled if a shoulder belt is wrapped around their neck and the safety belt continues to tighten. Buckle any unused safety belts behind the child restraint so
(Continued)

WARNING (Continued)

children cannot reach them. Pull the shoulder belt all the way out of the retractor to set the lock, if the vehicle has one, after the child restraint has been installed.

Notice: Do not let the LATCH attachments rub against the vehicle's safety belts. This may damage these parts. If necessary, move buckled safety belts to avoid rubbing the LATCH attachments.

Do not fold the empty rear seat with a safety belt buckled. This could damage the safety belt or the seat. Unbuckle and return the safety belt to its stowed position, before folding the seat.

3-42 Seats and Restraints

If you need to secure more than one child restraint in the rear seat, see *Where to Put the Restraint on page 3-36*. Depending on where you place the child restraint, you may not be able to access certain safety belt assemblies or LATCH anchors for additional passengers or child restraints.

You cannot secure three child restraints using the LATCH anchors in the rear seat at the same time, but you can install two of them. If you want to do this, install one LATCH child restraint in the passenger-side position, and install the other one either in the driver-side position or in the center position. Refer to the following illustration to learn which anchors to use.

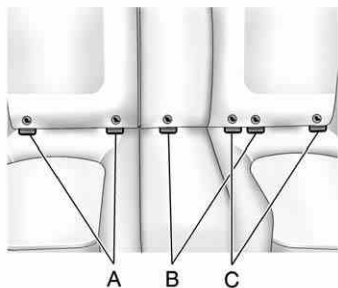

- A. Passenger Side Rear Seat Lower Anchors
- B. Center Rear Seat Lower Anchors
- C. Driver Side Rear Seat Lower Anchors

Make sure to attach the child restraint at the proper anchor location.

This system is designed to make installation of child restraints easier. When using lower anchors, do not use the vehicle's safety belts.

Instead use the vehicle's anchors and child restraint attachments to secure the restraints. Some restraints also use another vehicle anchor to secure a top tether.

1. Attach and tighten the lower attachments to the lower anchors. If the child restraint does not have lower attachments or the desired seating position does not have lower anchors, secure the child restraint with the top tether and the safety belts. Refer to your child restraint manufacturer instructions and the instructions in this manual.
 - 1.1. Find the lower anchors for the desired seating position.
 - 1.2. Put the child restraint on the seat.
 - 1.3. Attach and tighten the lower attachments on the child restraint to the lower anchors.

2. If the child restraint manufacturer recommends that the top tether be attached, attach and tighten the top tether to the top tether anchor, if equipped. Refer to the child restraint instructions and the following steps:

2.1. Find the top tether anchor.

Open the cover to expose the anchor.

2.2. If the position you are using has an adjustable headrest or head restraint, raise it. See *Head Restraints* on page 3-2.

2.3. Route, attach, and tighten the top tether according to the child restraint instructions and the following instructions:

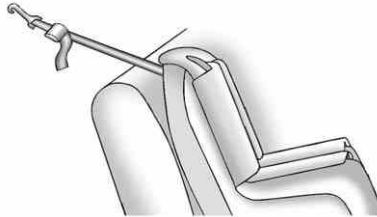

If the position you are using does not have a headrest or head restraint and you are using a single tether, route the tether over the seatback.

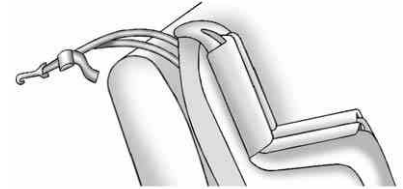

If the position you are using does not have a headrest or head restraint and you are using a dual tether, route the tether over the seatback.

3-44 Seats and Restraints

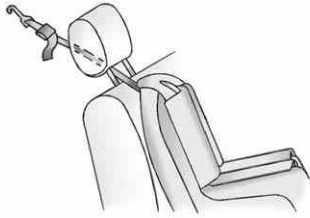

If the position you are using has an adjustable headrest or head restraint and you are using a single tether, route the tether under the headrest or head restraint and in between the headrest or head restraint posts. See *Head Restraints* on page 3-2.

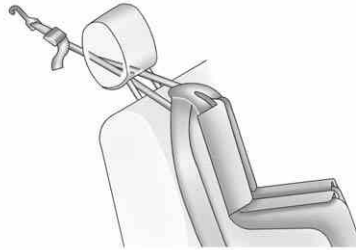

If the position you are using has an adjustable headrest or head restraint and you are using a dual tether route the tether under the headrest or head restraint and in between the headrest or head restraint posts. See *Head Restraints* on page 3-2.

3. Before placing a child in the child restraint, make sure it is securely held in place. To check, grasp the child restraint at the LATCH path and attempt to move it side-to-side and back-and-forth. There should be no more than 2.5 cm (1 in) of movement for proper installation.

Replacing LATCH System Parts After a Crash

WARNING

A crash can damage the LATCH system in the vehicle. A damaged LATCH system may not properly secure the child restraint, resulting in serious injury or even death in a crash. To help make sure the LATCH system is working properly after a crash, see your dealer to have the system inspected and any necessary replacements made as soon as possible.

If the vehicle has the LATCH system and it was being used during a crash, new LATCH system parts may be needed.

New parts and repairs may be necessary even if the LATCH system was not being used at the time of the crash.

Securing Child Restraints (Rear Seat)

When securing a child restraint in a rear seating position, study the instructions that came with the child restraint to make sure it is compatible with this vehicle.

If the child restraint has the LATCH system, see *Lower Anchors and Tethers for Children (LATCH System)* on page 3-38 for how and where to install the child restraint using LATCH. If a child restraint is secured in the vehicle using a safety belt and it uses a top tether, see *Lower Anchors and Tethers for Children (LATCH System)* on page 3-38 for top tether anchor locations.

Do not secure a child seat in a position without a top tether anchor if a national or local law requires that the top tether be anchored, or if the instructions that come with the child restraint say that the top strap must be anchored.

In Canada, the law requires that forward-facing child restraints have a top tether, and that the tether be attached.

If the child restraint does not have the LATCH system, you will be using the safety belt to secure the child restraint in this position. Be sure to follow the instructions that came with the child restraint. Secure the child in the child restraint when and as the instructions say.

3-46 Seats and Restraints

If more than one child restraint needs to be installed in the rear seat, be sure to read *Where to Put the Restraint* on page 3-36.

1. Put the child restraint on the seat.
2. Pick up the latch plate, and run the lap and shoulder portions of the vehicle's safety belt through or around the restraint. The child restraint instructions will show you how.

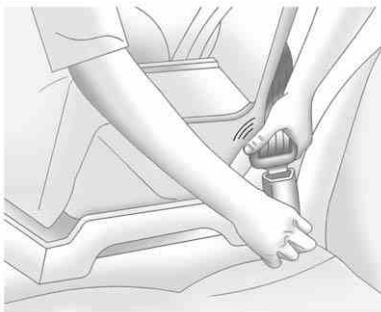

3. Push the latch plate into the buckle until it clicks.
Position the release button on the buckle so that the safety belt could be quickly unbuckled if necessary.



4. Pull the shoulder belt all the way out of the retractor to set the lock. When the retractor lock is set, the belt can be tightened but not pulled out of the retractor.

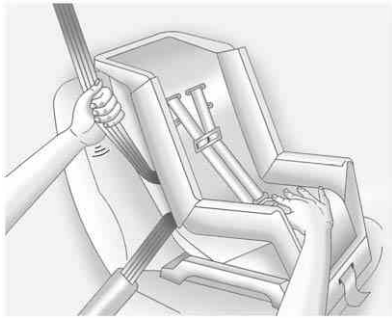

5. To tighten the belt, push down on the child restraint, pull the shoulder portion of the belt to tighten the lap portion of the belt, and feed the shoulder belt back into the retractor. When installing a forward-facing child restraint, it may be helpful to use your knee to push down on the child restraint as you tighten the belt. Try to pull the belt out of the retractor to make sure the retractor is locked. If the retractor is not locked, repeat Steps 4 and 5.
 6. If the child restraint has a top tether, follow the child restraint manufacturer's instructions regarding the use of the top tether. See *Lower Anchors and Tethers for Children (LATCH System)* on page 3-38 for more information.
 7. Before placing a child in the child restraint, make sure it is securely held in place. To check, grasp the child restraint at the safety belt path and attempt to move it side-to-side and back-and-forth. When the child restraint is properly installed, there should be no more than 2.5 cm (1 in) of movement.
- To remove the child restraint, unbuckle the vehicle safety belt and let it return to the stowed position. If the top tether is attached to a top tether anchor, disconnect it.

Securing Child Restraints (Front Passenger Seat)

This vehicle has airbags. A rear seat is a safer place to secure a forward-facing child restraint. See *Where to Put the Restraint* on page 3-36.

In addition, the vehicle has a passenger sensing system which is designed to turn off the right front passenger frontal airbag and seat-mounted side impact airbag under certain conditions. See *Passenger Sensing System* on page 3-24 and *Passenger Airbag Status Indicator* on page 5-13 for more information, including important safety information.

A label on the sun visor says, "Never put a rear-facing child seat in the front." This is because the risk to the rear-facing child is so great, if the airbag deploys.

WARNING

A child in a rear-facing child restraint can be seriously injured or killed if the right front passenger airbag inflates. This is because the back of the rear-facing child restraint would be very close to the inflating airbag. A child in a forward-facing child restraint can be seriously injured or killed if the right front passenger airbag inflates and the passenger seat is in a forward position.

(Continued)

WARNING (Continued)

Even if the passenger sensing system has turned off the right front passenger frontal airbag, no system is fail-safe. No one can guarantee that an airbag will not deploy under some unusual circumstance, even though it is turned off.

Secure rear-facing child restraints in a rear seat, even if the airbag is off. If you secure a forward-facing child restraint in the right front seat, always move the front passenger seat as far back as it will go. It is better to secure the child restraint in a rear seat.

See *Passenger Sensing System* on page 3-24 for additional information.

If the child restraint has the LATCH system, see *Lower Anchors and Tethers for Children (LATCH System)* on page 3-38 for how and where to install the child restraint using LATCH. If a child restraint is secured using a safety belt and it uses a top tether, see *Lower Anchors and Tethers for Children (LATCH System)* on page 3-38 for top tether anchor locations.

Do not secure a child seat in a position without a top tether anchor if a national or local law requires that the top tether be anchored, or if the instructions that come with the child restraint say that the top strap must be anchored.

In Canada, the law requires that forward-facing child restraints have a top tether, and that the tether be attached.

You will be using the lap-shoulder belt to secure the child restraint in this position. Follow the instructions that came with the child restraint.

1. Move the seat as far back as it will go before securing the forward-facing child restraint.

When the passenger sensing system has turned off the right front passenger frontal airbag and seat-mounted side impact airbag, the off indicator on the passenger airbag status indicator should light and stay lit when you start the vehicle. See *Passenger Airbag Status Indicator on page 5-13*.

2. Put the child restraint on the seat.

3. Pick up the latch plate, and run the lap and shoulder portions of the vehicle's safety belt through or around the restraint. The child restraint instructions will show you how.

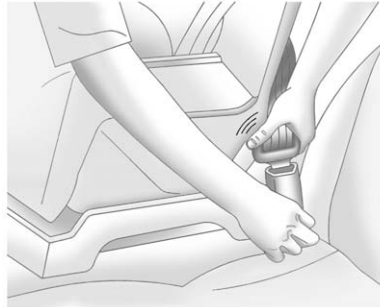

4. Push the latch plate into the buckle until it clicks. Position the release button on the buckle so that the safety belt could be quickly unbuckled if necessary.



5. Pull the shoulder belt all the way out of the retractor to set the lock. When the retractor lock is set, the belt can be tightened but not pulled out of the retractor.

3-50 Seats and Restraints

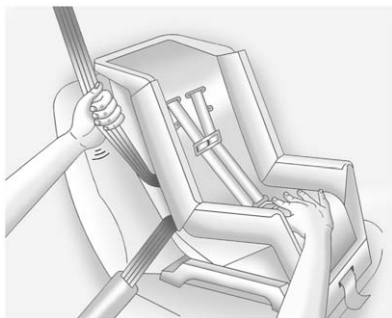

6. To tighten the belt, push down on the child restraint, pull the shoulder portion of the belt to tighten the lap portion of the belt, and feed the shoulder belt back into the retractor. When installing a forward-facing child restraint, it may be helpful to use your knee to push down on the child restraint as you tighten the belt.

Try to pull the belt out of the retractor to make sure the retractor is locked. If the retractor is not locked, repeat Steps 5 and 6.

7. Before placing a child in the child restraint, make sure it is securely held in place. To check, grasp the child restraint at the safety belt path and attempt to move it side-to-side and back-and-forth. When the child restraint is properly installed, there should be no more than 2.5 cm (1 in) of movement.

If the airbags are off, the off indicator in the passenger airbag status indicator will come on and stay on when the vehicle is started.

If a child restraint has been installed and the on indicator is lit, see "If the On Indicator is Lit for a Child Restraint" under *Passenger Sensing System on page 3-24* for more information.

To remove the child restraint, unbuckle the vehicle safety belt and let it return to the stowed position.

Storage

Storage Compartments

- Instrument Panel Storage 4-1
- Glove Box 4-1
- Cupholders 4-1
- Front Storage 4-2
- Center Console Storage 4-3

Additional Storage Features

- Convenience Net 4-4

Storage Compartments

Instrument Panel Storage

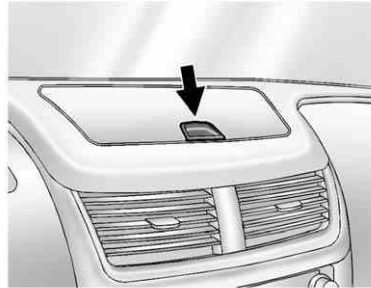

An instrument panel storage area, with a removable liner, is located above the radio. Slide the latch toward the rear of the vehicle to open the storage area.

Glove Box

Pull the handle up to open.

Cupholders

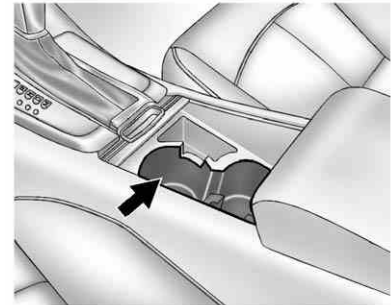

Removable cupholders are located in front of the center console.

4-2 Storage

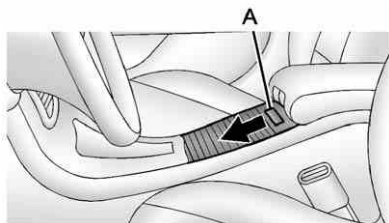

Push down on the cover handle (A) and then forward to access the cupholders.

To remove the cupholders:

1. Press and hold the tab at the rear of the cupholders.
2. Lift up and rearward.

To reinstall, place the two forward tabs into the slots and push down on the rear of the cupholder.

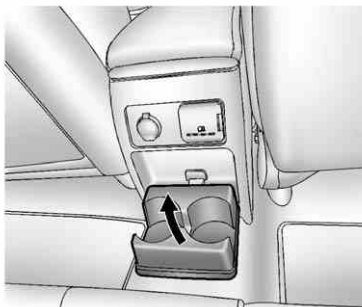

For vehicles with rear seat cupholders, access them by pulling down on the door at the back of the center console.

It has a storage tray and removable cupholders.

Front Storage



Storage is available in front of the shift lever. Open it by pushing on the bottom of the door.

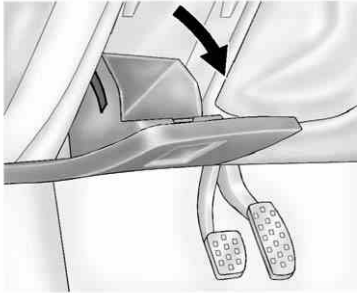

A driver side storage compartment is located near the steering column on the bottom of the instrument panel. Pull the cover down to open. Pull out to remove for cleaning.

Center Console Storage

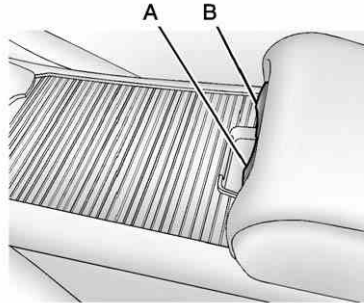

The center console storage has a tray and a main storage area. Pull up on the latch (A) to access the tray. Pull up on the latch (B) to access the main storage. It is equipped with a removable divider. There may be a storage pocket at the rear of the center console.

The armrest on top of the center console can be adjusted to a rearward, middle, and forward position. Pull or push the front of the armrest to adjust to the desired position.

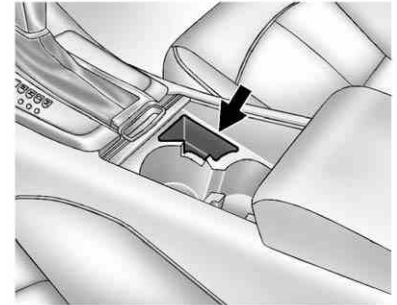

An additional storage area is in front of the main storage.

4-4 Storage

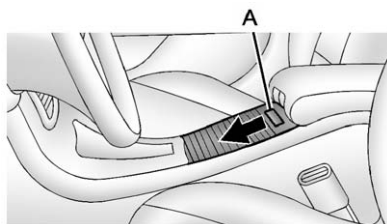

Push down on the cover handle (A) and then forward to access the storage area.

Additional Storage Features

Convenience Net

Use the rear convenience net to store small items. The net should not be used to store heavy loads.

Instruments and Controls

Controls

Steering Wheel Adjustment . . .	5-2
Steering Wheel Controls	5-2
Horn	5-3
Windshield Wiper/Washer	5-3
Compass	5-4
Clock	5-5
Power Outlets	5-7

Warning Lights, Gauges, and Indicators

Warning Lights, Gauges, and Indicators	5-8
Instrument Cluster	5-9
Speedometer	5-10
Odometer	5-10
Trip Odometer	5-10
Tachometer	5-10
Fuel Gauge	5-10
Engine Coolant Temperature Gauge	5-11
Safety Belt Reminders	5-12
Airbag Readiness Light	5-12

Passenger Airbag Status Indicator	5-13
Charging System Light	5-14
Malfunction Indicator Lamp	5-14
Brake System Warning Light	5-17
Antilock Brake System (ABS) Warning Light	5-17
Traction Off Light	5-18
Electronic Stability Control (ESC) Off Light	5-18
Electronic Stability Control (ESC)/Traction Control System (TCS) Indicator/Warning Light	5-19
Engine Coolant Temperature Warning Light	5-19
Tire Pressure Light	5-20
Engine Oil Pressure Light	5-20
Security Light	5-21
High-Beam On Light	5-21
Cruise Control Light	5-21

Information Displays

Driver Information Center (DIC)	5-22
---	------

Vehicle Messages

Vehicle Messages	5-25
Brake System Messages	5-25
Cruise Control Messages	5-25
Door Ajar Messages	5-25
Engine Oil Messages	5-25
Engine Power Messages	5-26
Fuel System Messages	5-26
Key and Lock Messages	5-26
Lamp Messages	5-26
Ride Control System Messages	5-26
Airbag System Messages	5-28
Service Vehicle Messages	5-28
Tire Messages	5-28
Vehicle Reminder Messages	5-29
Washer Fluid Messages	5-29

Vehicle Personalization

Vehicle Personalization	5-29
-----------------------------------	------

Controls

Steering Wheel Adjustment

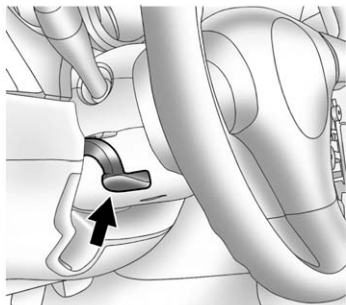

The lever is located on the left side of the steering wheel column.

To adjust the steering wheel:

1. Pull the lever down.
2. Move the steering wheel up or down.
3. Pull or push the steering wheel closer or away from you.

4. Pull the lever up to lock the steering wheel in place.

Do not adjust the steering wheel while driving.

Steering Wheel Controls

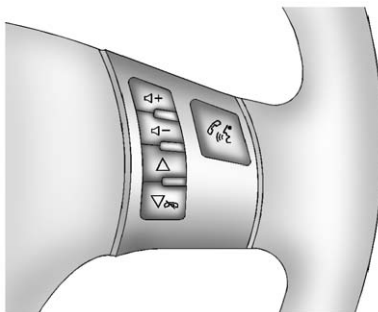



Vehicles with audio steering wheel controls could differ depending on the vehicle's options. Some audio controls can be adjusted at the steering wheel.

◀ + / ▶ - (Volume): Press to increase or to decrease the radio volume.

△ or ▽ /  (Next/Previous): Press to change radio stations, select tracks on a CD, or to select tracks and navigate folders on an iPod® or USB device.

To change radio stations:

- Press and release △ or ▽ /  to go to the next or previous radio station stored as a preset.
- Press and hold △ or ▽ /  to go to the next or previous radio station in the selected band with a strong signal.

To select tracks on a CD:





Press and release △ or ▽ /  to go to the next or previous track.

To select tracks on an iPod or USB device:





1. Press and hold △ or ▽ /  while listening to a song until the contents of the current folder display on the radio display.

- Press and release \triangle or ∇ /  to scroll up or down the list, then press and hold \triangle to play the highlighted track.

To navigate folders on an iPod or USB device:

- Press and hold \triangle or ∇ /  while listening to a song until the contents of the current folder display on the radio display.
- Press and hold ∇ /  to go back to the previous folder list.
- Press and release \triangle or ∇ /  to scroll up or down the list.
 - To select a folder, press and hold \triangle when the folder is highlighted.
 - To go back further in the folder list, press and hold ∇ / .

∇ /  (**End/Mute**): Press to reject an incoming call, or end a current call. Press to silence the vehicle speakers only. Press again to turn the sound on.

 /  (**Voice Recognition**): For vehicles with Bluetooth[®] or OnStar[®] systems press and hold  /  for longer than two seconds to interact with those systems. See *Bluetooth on page 7-23* and *OnStar Overview on page 14-1* for more information.

Horn

Press  on the steering wheel pad to sound the horn.

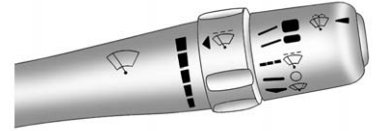

Windshield Wiper/Washer



The windshield wiper lever is on the right side of the steering wheel.

Move the lever to control the windshield wipers.

 (**Off**): Turns the windshield wipers off.

 (**Intermittent; Speed Sensitive Wipers**): For intermittent or speed sensitive operation. While in this position, turn the  band up or down to vary frequency.

The amount of delay time varies between wiping cycles due to the delay setting selected or the speed of the vehicle. As vehicle speed is increased or decreased, the wiper interval also increases or decreases.

5-4 Instruments and Controls

 (Low Speed): Slow wipes.

 (High Speed): Fast wipes.

 (Mist): Single wipe, move the lever down, then release it. Several wipes, hold the lever down.

Clear ice and snow from the wiper blades before using them.

If frozen to the windshield, carefully loosen or thaw them. Damaged wiper blades should be replaced.

Heavy snow or ice can overload the wiper motor. A circuit breaker stops the motor until it cools. If the motor gets stuck, turn the wipers off, clear away the snow or ice, and then turn the wipers back on.

As an added safety feature, if the wipers are on for more than 15 seconds, the vehicle's headlamps turn on automatically. They turn off 15 seconds after the wipers are turned off.

Windshield Washer

Press the button at the end of the windshield wiper lever until the washers begin.

WARNING

In freezing weather, do not use the washer until the windshield is warmed. Otherwise the washer fluid can form ice on the windshield, blocking your vision.

When the button is released, the washers stop, but the wipers continue to wipe about three times or resume the previous speed.

Compass

Compass Operation

Press  on the rearview mirror to turn the compass display on or off.

When the ignition and the compass feature are on, the compass displays the current compass direction after a few seconds.

Compass Calibration

If after a few seconds the display does not show a compass direction, (N for North for example), there may be a strong magnetic field interfering with the compass. Interference can be caused by a magnetic antenna mount, note pad holder, or similar object. If the letter C appears in the compass window, the compass may need to be reset or calibrated.

The mirror can be calibrated by driving the vehicle very slowly, in circles, until the display reads a direction.



Compass Variance

The mirror is set in zone eight. It is necessary to adjust the compass to compensate for compass variance if the vehicle is driven outside zone eight. Under certain circumstances, such as a long distance, cross-country trip, it is necessary to adjust the compass variance.

To adjust for compass variance:

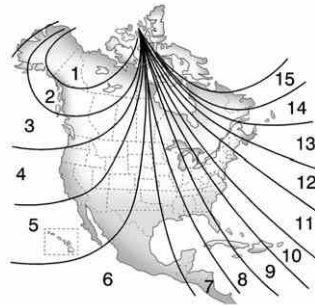
1. Find your current location and variance zone number on the zone map that follows.







2. Press and hold  until a zone number displays.
3. Once the zone number displays, press  repeatedly until the correct zone number is reached. If C appears in the compass window, the compass may need calibration. See "Compass Calibration" listed previously.

Clock

Without Date Display



AM/FM Base Radio with a Single CD Player

To set the time:

1. Turn the ignition key to ACC/ACCESSORY or ON/RUN. Press the  knob to turn the radio on.
2. Press the  button until the hour begins flashing on the display. Press the  button a second time and the minute begins flashing on the display.
3. While either the hour or the minute numbers are flashing, turn the  knob to increase or decrease the time.

5-6 Instruments and Controls

4. Press the  button again until the clock display stops flashing to set the currently displayed time; otherwise, the flashing stops after five seconds and the current time displayed is automatically set.







To change the time default setting from 12 hour to 24 hour, press the  button until 12H or 24H is displayed. Once 12H or 24H is displayed, turn the  knob to the desired option to select the setting. Press the  button again to apply the setting, or let the screen time out.

With Date Display

Radio with CD (MP3) and USB Port, and Radio with Single CD (MP3) Player



To set the time and date:

1. Turn the ignition key to ACC/ACCESSORY or ON/RUN.
Press the  knob to turn the radio on.

2. Press the  button and the HR, MIN, MM, DD, YYYY (hour, minute, month, day, and year) displays.
3. Press the softkey located below any one of the tabs that you want to change.
4. To increase the time or date do one of the following:
 - Press the softkey located below the selected tab.
 - Press the  SEEK, or  FWD button.
 - Turn the  knob clockwise.
5. To decrease the time or date do one of the following:
 - Press the  SEEK or  REV button.
 - Turn the  knob counterclockwise.

The date does not automatically display. To see the date press  while the radio is on. The date with display times out after a few seconds and goes back to the normal radio and time display.

To change the time default setting from 12 hour to 24 hour or to change the date default setting from month/day/year to day/month/year:

1. Press the  button and then the softkey located below the forward arrow label. Once the time 12H and 24H, and the date MM/DD/YYYY (month, day, and year) and DD/MM/YYYY (day, month, and year) displays.
2. Press the softkey located below the desired option.
3. Press the  button again to apply the selected default, or let the screen time out.

Power Outlets

Accessory power outlets can be used to plug in electrical equipment, such as a cell phone or MP3 player.

There are two accessory power outlets. One accessory power outlet is located inside the storage bin below the climate controls and the other outlet is on the rear of the center storage console.

Remove the cover to access and replace when not in use. The accessory power outlet is operational at all times.

WARNING

Power is always supplied to the outlets. Do not leave electrical equipment plugged in when the vehicle is not in use because the vehicle could catch fire and cause injury or death.

Notice: Leaving electrical equipment plugged in for an extended period of time while the vehicle is off will drain the battery. Always unplug electrical equipment when not in use and do not plug in equipment that exceeds the maximum 20 ampere rating.

Certain electrical accessories may not be compatible with the accessory power outlet and could overload vehicle or adapter fuses. If a problem is experienced, see your dealer.

When adding electrical equipment, be sure to follow the proper installation instructions included with the equipment. See *Add-On Electrical Equipment* on page 9-45.

Notice: Hanging heavy equipment from the power outlet can cause damage not covered by the vehicle warranty. The power outlets are designed for accessory power plugs only, such as cell phone charge cords.

Power Outlet 110 Volt Alternating Current

The vehicle may have a power outlet that can be used to plug in electrical equipment that uses a maximum limit of 150 watts.

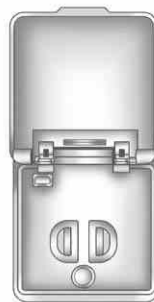

The power outlet is located on the rear of the center console.

An indicator light on the outlet comes on when in use. The ignition must be in ON/RUN and equipment requiring less than 150 watts is plugged into the outlet, and no system fault is detected.

If you try to connect equipment using more than 150 watts or a system fault is detected, a protection circuit shuts off the power supply and the indicator light turns off. To reset the circuit, unplug the item and plug it back in or turn the Remote Accessory Power (RAP) off and then back on. See *Retained Accessory Power (RAP) on page 9-18*. The power restarts when equipment that operates within the limit is plugged into the outlet and a system fault is not detected.

The power outlet is not designed for and may not work properly if the following are plugged in:

- Equipment with high initial peak wattage such as:
compressor-driven refrigerators and electric power tools.
- Other equipment requiring an extremely stable power supply such as:
microcomputer-controlled electric blankets, touch sensor lamps, etc.

Warning Lights, Gauges, and Indicators

Warning lights and gauges can signal that something is wrong before it becomes serious enough to cause an expensive repair or replacement. Paying attention to the warning lights and gauges could prevent injury.

Warning lights come on when there could be a problem with a vehicle function. Some warning lights come on briefly when the engine is started to indicate they are working.

Gauges can indicate when there could be a problem with a vehicle function. Often gauges and warning lights work together to indicate a problem with the vehicle.

When one of the warning lights comes on and stays on while driving, or when one of the gauges shows there may be a problem, check the section that explains what to do. Follow this manual's advice. Waiting to do repairs can be costly and even dangerous.

Instrument Cluster

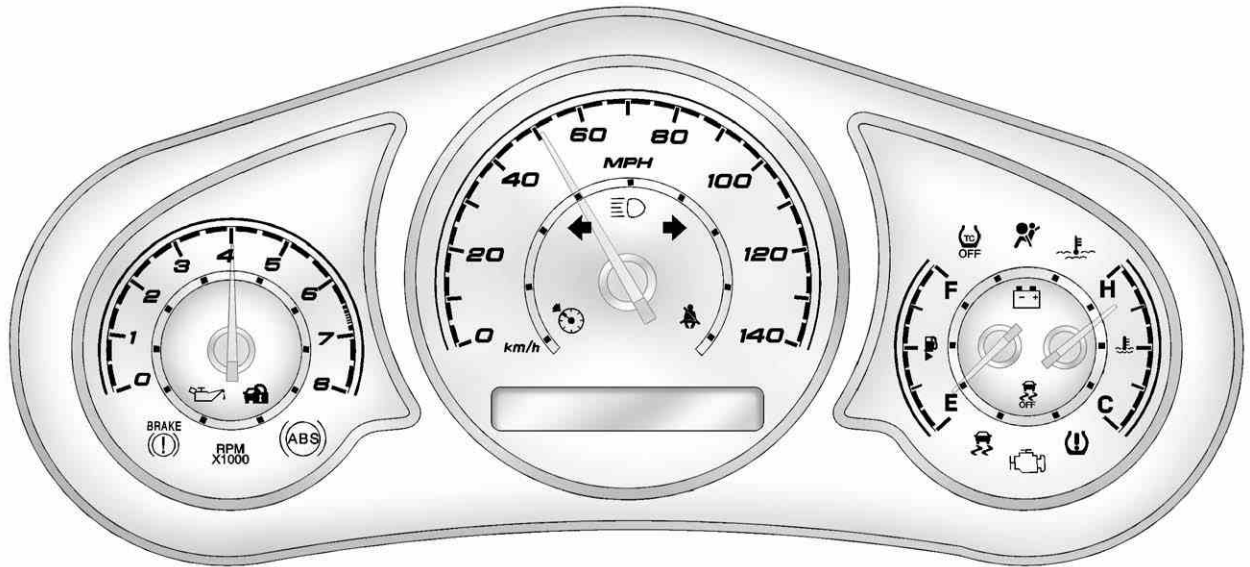

English shown, Metric similar

Speedometer

The speedometer shows the vehicle's speed in either kilometers per hour (km/h) or miles per hour (mph).

Odometer

The odometer shows how far the vehicle has been driven, in either kilometers or miles.

This vehicle has a tamper-resistant odometer. The digital odometer will read 999,999 if it is turned back.

If the vehicle needs a new odometer installed, it must be set to the mileage total of the old odometer. If that is not possible, then it must be set at zero and a label must be put on the driver door to show the old mileage reading when the new odometer was installed.

Trip Odometer

The trip odometer can show how far the vehicle has been driven since the trip odometer was last reset.

The trip odometer is accessed and reset through the Driver Information Center (DIC). See *Driver Information Center (DIC)* on page 5-22 for more information.

Tachometer

The tachometer displays the engine speed in revolutions per minute (rpm).

Notice: If the engine is operated with the tachometer in the shaded warning area, the vehicle could be damaged, and the damages would not be covered by the vehicle warranty. Do not operate the engine with the tachometer in the shaded warning area.

Fuel Gauge

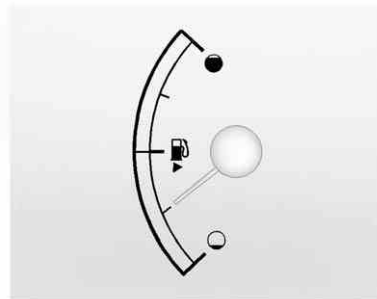

Metric

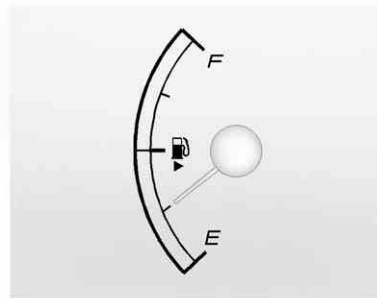

English

When the ignition is on, the fuel gauge shows how much fuel is left in the fuel tank. When the indicator nears empty, a message in the Driver Information Center (DIC) displays. See *Fuel System Messages on page 5-26* for more information. The vehicle still has a little fuel left, but the vehicle should be fueled soon. An arrow on the fuel gauge indicates the side of the vehicle the fuel door is on.

Here are four things that some owners ask about. These are normal and do not indicate a problem with the fuel gauge:

- At the service station, the gas pump shuts off before the gauge reads full.
- It takes a little more or less fuel to fill up than the gauge indicated. For example, the gauge may have indicated the fuel tank was half full, but it actually took a little more or less than half the fuel tank's capacity to fill it.

- The indicator moves a little while turning a corner or speeding up.
- The gauge goes back to empty when the ignition is turned off.

Engine Coolant Temperature Gauge

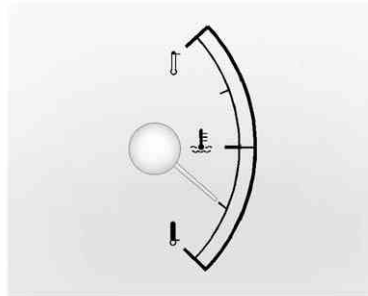

Metric

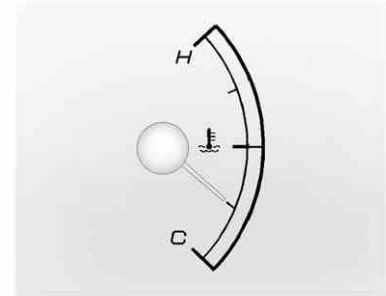

English

This gauge shows the engine coolant temperature. If the pointer moves towards the H (United States) or to the shaded thermostat symbol area (Canada), the engine is too hot.

A temperature indicator light turns on and a chime sounds.

The vehicle is operated under normal driving conditions and the temperature indicator light comes on, pull off the road, stop the vehicle, and turn off the engine as soon as possible.

Safety Belt Reminders

Driver Safety Belt Reminder Light



When the engine is started, a chime sounds for several seconds to remind a driver to fasten the safety belt. Unless the driver safety belt is already buckled.

The safety belt light comes on and stays on for several seconds, then flashes for several more.

This chime and light are repeated if the driver remains unbuckled and the vehicle is in motion.

If the driver safety belt is buckled, neither the light nor the chime comes on.

Passenger Safety Belt Reminder Light



For vehicles equipped with the passenger safety belt reminder light, several seconds after the engine is started, a chime sounds for several seconds to remind the front passenger to buckle their safety belt. The passenger safety belt light flashes and then stays on solid until the belt is buckled. This cycle continues several times if the passenger remains or becomes unbuckled while the vehicle is moving.

If the passenger safety belt is buckled, neither the chime nor the light comes on.

The passenger safety belt reminder light and chime may turn on if an object is put on the seat such as a briefcase, handbag, grocery bag, laptop, or other electronic device. To turn off the reminder light and/or chime, remove the object from the seat or buckle the safety belt.

Airbag Readiness Light

The system checks the airbag's electrical system for possible malfunctions. If the light stays on it indicates there is an electrical problem. The system check includes the airbag sensor(s), passenger sensing system, the pretensioners, the airbag modules, the wiring, and the crash sensing and diagnostic module. For more information on the airbag system, see *Airbag System* on page 3-17.



The airbag readiness light comes on solid for a few seconds when the engine is started. If the light does not come on then, have it fixed immediately.

WARNING

If the airbag readiness light stays on after the vehicle is started or comes on while driving, it means the airbag system might not be working properly. The airbags in the vehicle might not inflate in a crash, or they could even inflate without a crash. To help avoid injury, have the vehicle serviced right away.

If there is a problem with the airbag system, a Driver Information Center (DIC) message can also come on. See *Airbag System Messages on page 5-28* for more information.

Passenger Airbag Status Indicator

The vehicle has a passenger sensing system. See *Passenger Sensing System on page 3-24* for important safety information. The instrument panel has a passenger airbag status indicator.



United States



Canada and Mexico

When the vehicle is started, the passenger airbag status indicator will light ON and OFF, or the symbol for on and off, for several seconds as a system check. If you are using remote start to start the vehicle from a distance, if equipped, you may not see the system check. Then, after several more seconds, the status indicator will light either ON or OFF, or either the on or off symbol to let you know the status of the right front passenger frontal and seat-mounted side impact airbags.

If the word ON or the on symbol is lit on the passenger airbag status indicator, it means that the right front passenger frontal airbag and seat-mounted side impact airbag are enabled (may inflate).

5-14 Instruments and Controls

If the word OFF or the off symbol is lit on the passenger airbag status indicator, it means that the passenger sensing system has turned off the right front passenger frontal and seat-mounted side impact airbag.

If, after several seconds, both status indicator lights remain on, or if there are no lights at all, there may be a problem with the lights or the passenger sensing system. See your dealer for service.

WARNING

If the airbag readiness light ever comes on and stays on, it means that something may be wrong with the airbag system. To help avoid injury to yourself or others, have the vehicle serviced right away. See *Airbag Readiness Light on page 5-12* for more information, including important safety information.

Charging System Light

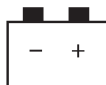

This light comes on briefly when the ignition key is turned to START, but the engine is not running, as a check to show it is working.

If it does not, have the vehicle serviced by your dealer.

The light should go out once the engine starts. If it stays on, or comes on while driving, there could be a problem with the charging system. This light could indicate that there are problems with a generator drive belt, or that there is an electrical problem. Have it checked right away. If the vehicle must be driven a short distance with the light on, turn off accessories, such as the radio and air conditioner.

Malfunction Indicator Lamp

A computer system called OBD II (On-Board Diagnostics-Second Generation) monitors the operation of the vehicle to ensure emissions are at acceptable levels, to produce a cleaner environment. This light comes on when the vehicle is placed in ON/RUN, as a check to show it is working. If it does not, have the vehicle serviced by your dealer. See *Ignition Positions on page 9-15* for more information.



If the malfunction indicator lamp comes on and stays on while the engine is running, this indicates that there is an OBD II problem and service is required.

Malfunctions often are indicated by the system before any problem is apparent. Being aware of the light can prevent more serious damage to the vehicle. This system assists the service technician in correctly diagnosing any malfunction.

Notice: If the vehicle is continually driven with this light on, the emission controls might not work as well, the vehicle fuel economy might not be as good, and the engine might not run as smoothly. This could lead to costly repairs that might not be covered by the vehicle warranty.

Notice: Modifications made to the engine, transmission, exhaust, intake, or fuel system of the vehicle or the replacement of the original tires with other than those of the same Tire Performance Criteria (TPC) can affect the vehicle's emission controls and can cause this light to come on. Modifications to

these systems could lead to costly repairs not covered by the vehicle warranty. This could also result in a failure to pass a required Emission Inspection/Maintenance test. See *Accessories and Modifications on page 10-3*.

This light comes on during a malfunction in one of two ways:

Light Flashing: A misfire condition has been detected. A misfire increases vehicle emissions and could damage the emission control system on the vehicle. Diagnosis and service might be required.

To prevent more serious damage to the vehicle:

- Reduce vehicle speed.
- Avoid hard accelerations.
- Avoid steep uphill grades.
- If towing a trailer, reduce the amount of cargo being hauled as soon as it is possible.

If the light continues to flash, stop and park the vehicle. Turn the vehicle off, wait at least 10 seconds, and restart the engine. If the light is still flashing, follow the previous steps and see your dealer for service as soon as possible.

Light On Steady: An emission control system malfunction has been detected on the vehicle. Diagnosis and service might be required.

The following may correct an emission system malfunction:

- Check that the fuel cap is fully installed. See *Filling the Tank on page 9-37*. The diagnostic system can determine if the fuel cap has been left off or improperly installed. A loose or missing fuel cap allows fuel to evaporate into the atmosphere. A few driving trips with the cap properly installed should turn the light off.

5-16 Instruments and Controls

- Check that good quality fuel is used. Poor fuel quality causes the engine not to run as efficiently as designed and may cause stalling after start-up, stalling when the vehicle is changed into gear, misfiring, hesitation on acceleration, or stumbling on acceleration. These conditions might go away once the engine is warmed up.

If one or more of these conditions occurs, change the fuel brand used. It will require at least one full tank of the proper fuel to turn the light off.

See *Recommended Fuel* on page 9-34.

If none of the above have made the light turn off, your dealer can check the vehicle. The dealer has the proper test equipment and diagnostic tools to fix any mechanical or electrical problems that might have developed.

Emissions Inspection and Maintenance Programs

Some local governments may have programs to inspect the on-vehicle emission control equipment. For the inspection, the emission system test equipment is connected to the vehicle's Data Link Connector (DLC).

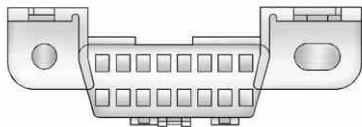

The DLC is under the instrument panel to the left of the steering wheel. See your dealer if assistance is needed.

The vehicle may not pass inspection if:

- The malfunction indicator lamp is on with the engine running, or if the light does not come on when the ignition is turned to ON/RUN

while the engine is off. See your dealer for assistance in verifying proper operation of the malfunction indicator lamp.

- The OBD II (On-Board Diagnostics) system determines that critical emission control systems have not been completely diagnosed. The vehicle would be considered not ready for inspection. This can happen if the 12-volt battery has recently been replaced or run down. The diagnostic system is designed to evaluate critical emission control systems during normal driving. This can take several days of routine driving. If this has been done and the vehicle still does not pass the inspection for lack of OBD II system readiness, your dealer can prepare the vehicle for inspection.

Brake System Warning Light

The vehicle brake system consists of two hydraulic circuits. If one circuit is not working, the remaining circuit can still work to stop the vehicle. For normal braking performance, both circuits need to be working.

If the warning light comes on, there is a brake problem. Have the brake system inspected right away.



Metric

BRAKE



English

This light comes on briefly when the ignition key is turned to ON/RUN. If it does not come on then, have it fixed so it will be ready to warn if there is a problem.

When the ignition is on, the brake system warning light also comes on when the parking brake is set. The light stays on if the parking brake does not fully release. If it stays on after the parking brake is fully released, it means there is a brake problem.

The Driver Information Center (DIC) may display a BRAKE FLUID message. See *Brake System Messages on page 5-25* for more information.

If the light comes on while driving, pull off the road and carefully stop. The brake pedal may be harder to push or the pedal may go closer to the floor. It may take longer to stop. Try turning off and restarting the vehicle one or two times, if the light is still on, have the vehicle towed for service. See *Towing the Vehicle on page 10-79*

WARNING

The brake system might not be working properly if the brake system warning light is on. Driving with the brake system warning light on can lead to a crash. If the light is still on after the vehicle has been pulled off the road and carefully stopped, have the vehicle towed for service.

Antilock Brake System (ABS) Warning Light



For vehicles with the Antilock Brake System (ABS), this light comes on briefly when the engine is started.

5-18 Instruments and Controls

If it does not, have the vehicle serviced by your dealer. If the system is working normally, the indicator light then goes off.

If the ABS light stays on, turn the ignition off. If the light comes on while driving, stop as soon as it is safely possible and turn the ignition off. Then start the engine again to reset the system. If the ABS light stays on, or comes on again while driving, the vehicle needs service. If the regular brake system warning light is not on, the vehicle still has brakes, but not antilock brakes. If the regular brake system warning light is also on, the vehicle does not have antilock brakes and there is a problem with the regular brakes. See *Brake System Warning Light* on page 5-17.

For vehicles with a Driver Information Center (DIC), see *Brake System Messages* on page 5-25 for all brake-related DIC messages.

Traction Off Light



This light comes on briefly while starting the engine. If it does not, have the vehicle serviced by your dealer. If the system is working normally, the indicator light then turns off.

The traction off light comes on when the Traction Control System (TCS) has been turned off by pressing and releasing the traction control button.

This light and the Electronic Stability Control (ESC) Off light come on when ESC is turned off.

If the TCS is off, wheelspin is not limited. Adjust driving accordingly.

See *Traction Control System (TCS)* on page 9-27 and *Electronic Stability Control (ESC)* on page 9-29 for more information.

Electronic Stability Control (ESC) Off Light



This light comes on briefly while starting the engine. If it does not, have the vehicle serviced by your dealer.

This light comes on when the Electronic Stability Control (ESC) system is turned off. If ESC is off, the Traction Control System (TCS) is also off.

If the TCS is off, the system does not assist in controlling the vehicle. Turn on the TCS and the ESC systems and the warning light turns off.

See *Traction Control System (TCS)* on page 9-27 and *Electronic Stability Control (ESC)* on page 9-29 for more information

Electronic Stability Control (ESC)/Traction Control System (TCS) Indicator/Warning Light



The Electronic Stability Control (ESC) or the Traction Control System (TCS) indicator/warning light comes on briefly when the engine is started.

If the light does not come on, have the vehicle serviced by the dealer. If the system is working normally, the indicator light turns off.

If the light is on and not flashing, the TCS, and potentially the ESC system have been disabled. A DIC message may display. Check the DIC messages to determine which feature(s) is no longer functioning and whether the vehicle requires service.

If the indicator/warning light is on and flashing, the TCS and/or the StabiliTrak system is actively working.

See *Traction Control System (TCS)* on page 9-27 and *Electronic Stability Control (ESC)* on page 9-29 for more information.

Engine Coolant Temperature Warning Light



This light comes on briefly while starting the vehicle.

If it does not, have the vehicle serviced by the dealer. If the system is working normally the indicator light goes off.

Notice: Driving with the engine coolant temperature warning light on could cause the vehicle to overheat. See *Engine Overheating* on page 10-17. The vehicle's engine could be damaged, and it might not be covered by the vehicle warranty. Never drive with the engine coolant temperature warning light on.

The engine coolant temperature warning light comes on when the engine has overheated.

If this happens pull over and turn off the engine as soon as possible. See *Engine Overheating* on page 10-17 for more information.

Tire Pressure Light



For vehicles with the Tire Pressure Monitor System (TPMS), this light comes on briefly when the engine is started. It provides information about tire pressures and the TPMS.

When the Light Is On Steady

This indicates that one or more of the tires are significantly underinflated.

A Driver Information Center (DIC) tire pressure message may also display. See *Vehicle Messages* on page 5-25 for more information. Stop as soon as possible, and inflate the tires to the pressure value shown on the Tire and Loading Information label. See *Tire Pressure* on page 10-45 for more information.

When the Light Flashes First and Then Is On Steady

If the light flashes for about a minute and then stays on, there may be a problem with the TPMS. If the problem is not corrected, the light will come on at every ignition cycle. See *Tire Pressure Monitor Operation* on page 10-48 for more information.

Engine Oil Pressure Light

Notice: Lack of proper engine oil maintenance can damage the engine. Driving with the engine oil low can also damage the engine. The repairs would not be covered by the vehicle warranty.

Check the oil level as soon as possible. Add oil if required, but if the oil level is within the operating range and the oil pressure is still low, have the vehicle serviced. Always follow the maintenance schedule for changing engine oil.



The oil pressure light should come on briefly as the engine is started. If it does not come on, have the vehicle serviced by your dealer.

If the light comes on and stays on, it means that oil is not flowing through the engine properly. The vehicle could be low on oil and might have some other system problem. See your dealer.

Security Light



The security light should come on briefly as the engine is started. If the system is working normally, the indicator light turns off. If it does not come on, have the vehicle serviced by your dealer.

If the light stays on and the engine does not start, there could be a problem with the theft-deterrent system.

This light is also used to indicate the status of the anti-theft alarm system when the ignition is turned off. The light will flash rapidly if the alarm system is arming and one or more

of the monitored entry points is not closed. The light will stay on if the alarm is arming and all entry points are closed.

For information regarding this light and the vehicle's security system, see *Anti-theft Alarm System* on page 2-11.

High-Beam On Light



The high-beam on light comes on when the high-beam headlamps are in use.

See *Headlamp High/Low-Beam Changer* on page 6-2 for more information.

Cruise Control Light



The cruise control light comes on whenever the cruise control is set.

The light goes out when the cruise control is turned off. See *Cruise Control* on page 9-31 for more information.

Information Displays

Driver Information Center (DIC)

Your vehicle has a Driver Information Center (DIC). The DIC display gives you the status of many of your vehicle's systems. The DIC is also used to display driver personalization menu modes and warning/status messages. All messages will appear in the DIC display, located at the bottom of the instrument panel cluster.

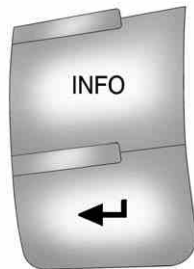

The DIC buttons are located on the left side of the steering wheel.

INFO (Information): Press this button to scroll through the vehicle information mode displays.

← (Reset): Press this button to reset some vehicle information mode displays, select a personalization menu mode setting, or acknowledge a warning message.

Press and hold the information and reset buttons at the same time for one second, then release the buttons to enter the personalization menu. See *Vehicle Personalization on page 5-29* for more information.

The DIC comes on when the ignition is on. The DIC has different modes which can be accessed by pressing the DIC buttons. The button functions are detailed in the following.

Information Modes

INFO (Information): Press this button to scroll through the following vehicle information modes:

Outside Air Temperature

The outside air temperature will be displayed at the same time as the Odometer and the Trip Odometer.

The temperature outside of the vehicle will be displayed in either degrees Celsius (°C) or degrees Fahrenheit (°F). The outside air temperature appears on the left side of the DIC display and the odometer, or trip odometer, appears on the right side of the display.

Odometer

Press the information button until the outside air temperature and the odometer displays. This mode shows the total distance the vehicle has been driven in either kilometers (km) or miles (mi).

To change the DIC display to English or metric units, see “UNITS” under *Vehicle Personalization on page 5-29*.

Trip Odometer

Press the information button until the outside air temperature along with A or B displays. These modes show the current distance traveled since the last reset for each trip odometer in either kilometers (km) or miles (mi). Both odometers can be used at the same time.

To reset the trip odometer to zero, press and hold the reset button for a few seconds while the desired trip odometer is displayed.

FUEL RANGE

Press the information button until FUEL RANGE displays. This mode shows the remaining distance you can drive without refueling in either kilometers (km) or miles (mi). It is based on fuel economy and the fuel remaining in the tank.

When the fuel level is low, FUEL RANGE LOW displays.

The fuel economy data used to determine fuel range is an average of recent driving conditions. As your driving conditions change, this data is gradually updated. The FUEL RANGE mode cannot be reset.

MPG (L/100 KM) AVG (Average)

Press the information button until MPG (L/100 KM) AVG displays. This mode shows how many liters per 100 kilometers (L/100 km) or miles per gallon (mpg) your vehicle is getting based on current and past driving conditions.

To reset the average fuel economy, press and hold the reset button while MPG (L/100 KM) AVG is displayed. Average fuel economy is then calculated starting from that point. If the average fuel economy is not reset, it is continually updated each time you drive.

MPG (L/100 KM) INST (Instantaneous)

Press the information button until MPG (L/100 KM) INST displays. This mode shows the current fuel economy at a particular moment and changes frequently as driving conditions change. This mode shows the instantaneous fuel economy in liters per 100 kilometers (L/100 km) or miles per gallon (mpg). Unlike average fuel economy, this screen cannot be reset.

AV (Average) SPEED

Press the information button until AV SPEED displays. This mode shows the vehicle's average speed in kilometers per hour (km/h) or miles per hour (mph).

To reset the average vehicle speed, press and hold the reset button while AV SPEED is displayed.

OIL LIFE

Press the information button until OIL LIFE displays. The engine oil life system shows an estimate of the oil's remaining useful life. It shows 100% when the system is reset after an oil change. It alerts you to change the oil on a schedule consistent with your driving conditions.

In addition to the engine oil life system monitoring the oil life, additional maintenance is recommended in the Maintenance Schedule in this manual. See *Engine Oil on page 10-8* and *Maintenance Schedule on page 11-3*.

Always reset the engine oil life system after an oil change. See "How to Reset the Engine Oil Life System" under *Engine Oil Life System on page 10-11*.

Tire Pressure

On vehicles with the Tire Pressure Monitor System (TPMS), the pressure for each tire can be viewed in the DIC. The tire pressure is shown in either kilopascals (kPa) or pounds per square inch (psi). Press the information button until LF ## PSI (kPa) ## RF displays for the front tires. Press the information button again until LR ## PSI (kPa) ## RR displays for the rear tires.

If a low tire pressure condition is detected by the system while driving, a message advising you to add air will appear in the display. See *Tire Pressure on page 10-45* and *Tire Messages on page 5-28* for more information.

Vehicle Messages

The following messages appear if there is a problem detected in one of your vehicle's systems.

A message clears when the vehicle's condition is no longer present. To acknowledge a message and clear it from the display, press and hold any of the DIC buttons. If the condition is still present, the warning message comes back on the next time the vehicle is turned off and back on. With most messages, a warning chime sounds when the message displays. Your vehicle may have other warning messages.

Brake System Messages

BRAKE FLUID

This message displays, while the ignition is on, when the brake fluid level is low. The brake system warning light on the instrument panel cluster also comes on. See *Brake System Warning Light on*

page 5-17 for more information. Have the brake system serviced by your dealer as soon as possible.

PUSH PARK PEDAL

This message displays if the parking brake is left engaged. See *Parking Brake on page 9-26* for more information.

Cruise Control Messages

CRUISE ENGAGED

This message displays when the cruise control system is active. See *Cruise Control on page 9-31* for more information.

Door Ajar Messages

DOOR AJAR

This message displays if one or more of the vehicle's doors are not closed properly. Make sure that the door(s) are closed completely.

TRUNK AJAR

This message displays when the trunk is not closed completely. Make sure that the trunk is closed completely. See *Trunk on page 2-9* for more information.

Engine Oil Messages

CHANGE OIL SOON

This message displays when the life of the engine oil has expired and it should be changed.

When this message is acknowledged and cleared from the display, the engine oil life system must still be reset separately. See *Engine Oil Life System on page 10-11*, *Engine Oil on page 10-8*, and *Maintenance Schedule on page 11-3* for more information.

Engine Power Messages

ENG (Engine) PWR (Power) REDUCED

This message displays when the vehicle's engine power is reduced. Reduced engine power can affect the vehicle's ability to accelerate. If this message is on, but there is no reduction in performance, proceed to your destination. The performance may be reduced the next time the vehicle is driven. The vehicle may be driven at a reduced speed while this message is on, but acceleration and speed may be reduced. Anytime this message stays on, the vehicle should be taken to your dealer for service as soon as possible.

Fuel System Messages

CHECK GAS CAP

This message displays if the fuel cap has not been fully tightened. Recheck the fuel cap to make sure that it is on properly. A few driving trips with the cap properly installed should turn the message off.

LOW FUEL

This message displays when your vehicle is low on fuel. Refill the fuel tank as soon as possible. See *Fuel Gauge on page 5-10*, *Fuel on page 9-33*, and *Filling the Tank on page 9-37* for more information.

Key and Lock Messages

KEY FOB BATT (Battery) LOW

This message displays if the Remote Keyless Entry (RKE) transmitter battery is low. Replace the battery in the transmitter. See "Battery Replacement" under *Remote Keyless Entry (RKE) System Operation on page 2-3*.

Lamp Messages

AUTO (Automatic) LIGHTS OFF

This message displays if the automatic headlamp system is disabled with the headlamp switch. See *Automatic Headlamp System on page 6-3* for more information.

AUTO (Automatic) LIGHTS ON

This message displays if the automatic headlamp system is enabled with the headlamp switch. See *Automatic Headlamp System on page 6-3* for more information.

Ride Control System Messages

ESC (Electronic Stability Control) ACTIVE

If your vehicle has Electronic Stability Control (ESC), this message displays and the ESC/TCS light on the instrument panel cluster flashes when ESC is assisting you

with directional control of the vehicle. You may feel or hear the system working and see this message displayed in the DIC. Slippery road conditions may exist when this message is displayed, so adjust your driving accordingly. This message may stay on for a few seconds after ESC stops assisting you with directional control of the vehicle. This is normal when the system is operating. See *Electronic Stability Control (ESC) on page 9-29 and Electronic Stability Control (ESC)/Traction Control System (TCS) Indicator/Warning Light on page 5-19* for more information.

ESC (Electronic Stability Control) OFF

If your vehicle has Electronic Stability Control (ESC), this message displays and the ESC/TCS light on the instrument panel cluster comes on solid when ESC is turned off. Adjust your driving accordingly.

See *Electronic Stability Control (ESC) on page 9-29 and Electronic Stability Control (ESC)/Traction Control System (TCS) Indicator/Warning Light on page 5-19* for more information.

LOW TRACTION

If your vehicle has the Traction Control System (TCS), this message displays and the ESC/TCS light on the instrument panel cluster flashes when the system is actively limiting wheel spin. Slippery road conditions may exist if this message is displayed, so adjust your driving accordingly. This message stays on for a few seconds after the system stops limiting wheel spin. See *Traction Control System (TCS) on page 9-27 and Electronic Stability Control (ESC)/Traction Control System (TCS) Indicator/Warning Light on page 5-19* for more information.

SERVICE ESC (ELECTRONIC STABILITY CONTROL)

If your vehicle has Electronic Stability Control (ESC), this message displays and a chime sounds if there has been a problem detected with ESC. The ESC/TCS light also appears on the instrument panel cluster. This light stays on solid as long as the detected problem remains present. When this message displays, the system is not working. Adjust your driving accordingly. See *Electronic Stability Control (ESC) on page 9-29 and Electronic Stability Control (ESC)/Traction Control System (TCS) Indicator/Warning Light on page 5-19* for more information.

If this message turns on while you are driving, pull off the road as soon as possible and stop carefully. Try resetting the system by turning the ignition off and then back on.

If this message still stays on or turns back on again while you are driving, your vehicle needs service. Have the ESC inspected by your dealer as soon as possible.

SERVICE TRACTION

If your vehicle has the Traction Control System (TCS), this message displays and a chime sounds when the system is not functioning properly. The ESC/TCS light also appears on the instrument panel cluster. This light stays on solid as long as the detected problem remains present. When this message displays, the system is not working. Adjust your driving accordingly. See *Traction Control System (TCS)* on page 9-27 and *Electronic Stability Control (ESC)/Traction Control System (TCS) Indicator/Warning Light* on page 5-19 for more information. Have the system serviced by your dealer as soon as possible.

TRACTION OFF

If your vehicle has the Traction Control System (TCS), this message displays and the ESC/TCS light on the instrument panel cluster comes on solid when the system is turned off. Adjust your driving accordingly. See *Traction Control System (TCS)* on page 9-27 and *Electronic Stability Control (ESC)/Traction Control System (TCS) Indicator/Warning Light* on page 5-19 for more information.

Airbag System Messages

SERVICE AIR BAG

This message displays when there is a problem with the airbag system. Have your vehicle serviced by your dealer immediately.

Service Vehicle Messages

ENGINE DISABLED

This message displays if the starting of the engine is disabled. Have your vehicle serviced by your dealer immediately.

POWER STEERING

On some vehicles, this message displays if a problem has been detected with the electric power steering. Have your vehicle serviced by your dealer immediately.

Tire Messages

SVC (Service) TIRE MONITOR

On vehicles with the Tire Pressure Monitor System (TPMS), this message displays if a part on the TPMS is not working properly. The tire pressure light also flashes and then remains on during the same ignition cycle. See *Tire Pressure Light* on page 5-20.

Several conditions may cause this message to appear. See *Tire Pressure Monitor Operation on page 10-48* for more information. If the warning comes on and stays on, there may be a problem with the TPMS. See your dealer.

TIRE LOW ADD AIR

On vehicles with the Tire Pressure Monitor System (TPMS), this message displays when the pressure in one or more of the vehicle's tires is low on air. The low tire pressure warning light also comes on. See *Tire Pressure Light on page 5-20*. If this message appears on the DIC, stop as soon as you can. Have the tire pressures checked and set to those shown on the Tire Loading Information label. See *Tires on page 10-38*, *Vehicle Load Limits on page 9-10*, and *Tire Pressure on page 10-45*. The DIC also shows the tire pressure values. See *Driver Information Center (DIC) on page 5-22*.

Vehicle Reminder Messages

ICE POSSIBLE

This message displays when the outside air temperature is cold enough to create icy road conditions. Adjust your driving accordingly.

Washer Fluid Messages

LOW WASHER FLUID

This message displays when the vehicle's windshield washer fluid is low. Fill the windshield washer fluid reservoir to the proper level as soon as possible. See *Washer Fluid on page 10-19*.

Vehicle Personalization

Your vehicle has personalization capabilities that allow you to program certain features to a preferred setting. All of the features listed may not be available on your vehicle. Only the features available will be displayed on the DIC.

The default settings for the features were set when your vehicle left the factory, but may have been changed from their default state since that time.

To change feature settings, use the following procedure:

Entering Personalization Menu

1. Turn the ignition on while the vehicle is stopped.

To avoid excessive drain on the battery, it is recommended that the headlamps are turned off.

5-30 Instruments and Controls

2. Press and hold the information and reset buttons at the same time for one second, then release to enter the personalization menu.

If the vehicle speed is greater than 3 km/h (2 mph), only the UNITS menu will be accessible.

3. Press the information button to scroll through the available personalization menu modes.

Press the reset button to scroll through the available settings for each mode.

If you do not make a selection within ten seconds, the display will go back to the previous information displayed.

Personalization Menu Modes

OIL LIFE RESET

When this feature is displayed, you can reset the engine oil life system. To reset the system, see *Engine Oil Life System* on page 10-11. See

“OIL LIFE” under *Driver Information Center (DIC)* on page 5-22 for more information.

UNITS

This feature allows you to select the units of measurement in which the DIC will display the vehicle information. When UNITS appears on the display, press and hold the reset button for at least one second to scroll through the available settings:

ENGLISH (default in United States): All information will be displayed in English units.

METRIC (default in Canada): All information will be displayed in metric units.

To select a setting and move on to the next feature, press the information button while the desired setting is displayed on the DIC.

REMOTE START

If your vehicle has remote start, this feature allows remote start to be turned off or on. Remote start allows you to start the engine from outside of the vehicle using your Remote Keyless Entry (RKE) transmitter. When REMOTE START appears on the display, press and hold the reset button for at least one second to scroll through the available settings:

OFF: The remote start feature will be disabled.

ON (default): The remote start feature will be enabled.

See *Remote Vehicle Start* on page 2-5 for more information.

To select a setting and move on to the next feature, press the information button while the desired setting is displayed on the DIC.

LOCK HORN

This feature, which allows the vehicle's horn to chirp every time the lock button on the Remote Keyless Entry (RKE) transmitter is pressed, can be enabled or disabled. When LOCK HORN appears on the display, press and hold the reset button for at least one second to scroll through the available settings:

OFF (default): The horn will not chirp on the first press of the lock button on the RKE transmitter. The horn will still chirp on the second press.

ON: The horn will chirp on the first press of the lock button on the RKE transmitter.

See *Remote Keyless Entry (RKE) System Operation on page 2-3* for more information.

To select a setting and move on to the next feature, press the information button while the desired setting is displayed on the DIC.

UNLOCK HORN

This feature, which allows the vehicle's horn to chirp on the first press of the unlock button on the Remote Keyless Entry (RKE) transmitter, can be enabled or disabled. When UNLOCK HORN appears on the display, press and hold the reset button for at least one second to scroll through the available settings:

OFF (default): The horn will not chirp when the unlock button on the RKE transmitter is pressed.

ON: The horn will chirp on the first press of the unlock button on the RKE transmitter.

See *Remote Keyless Entry (RKE) System Operation on page 2-3* for more information.

To select a setting and move on to the next feature, press the information button while the desired setting is displayed on the DIC.

LIGHT FLASH

This feature, which allows the vehicle's exterior hazard/turn signal lighting to flash every time the lock, unlock, or trunk release buttons on the Remote Keyless Entry (RKE) transmitter are pressed, can be enabled or disabled. When LIGHT FLASH appears on the display, press and hold the reset button for at least one second to scroll through the available settings:

OFF: The exterior hazard/turn signal lighting will not flash when the lock, unlock, or trunk release buttons on the RKE transmitter are pressed.

ON (default): The exterior hazard/turn signal lighting will flash when the lock, unlock, or trunk release buttons on the RKE transmitter are pressed.

See *Remote Keyless Entry (RKE) System Operation on page 2-3* for more information.

5-32 Instruments and Controls

To select a setting and move on to the next feature, press the information button while the desired setting is displayed on the DIC.

DELAY LOCK

This feature, which delays the actual locking of the vehicle, can be enabled or disabled. When DELAY LOCK appears on the display, press and hold the reset button for at least one second to scroll through the available settings:

ON (default): The doors will not lock until five seconds after the last door is closed. You can temporarily override delayed locking by pressing the power lock switch or the lock button on the Remote Keyless Entry (RKE) transmitter a second time.

OFF: The doors will lock immediately when pressing the power lock switch or the lock button on the RKE transmitter.

See *Power Door Locks on page 2-7*, *Delayed Locking on page 2-8*, and *Remote Keyless Entry (RKE) System Operation on page 2-3* for more information.

To select a setting and move on to the next feature, press the information button while the desired setting is displayed on the DIC.

AUTO UNLK (Unlock)

This feature, which allows the vehicle to automatically unlock certain doors, can be enabled or disabled. When AUTO UNLK appears on the display, press and hold the reset button for at least one second to scroll through the available settings:

ALL (default): All of the doors will automatically unlock.

DRIVER: The driver's door will automatically unlock.

NONE: None of the doors will automatically unlock. You will need to manually unlock the doors.

See *Automatic Door Locks on page 2-8* for more information.

To select a setting and move on to the next feature, press the information button while the desired setting is displayed on the DIC.

UNLK (Unlock)

This screen displays only if DRIVER or ALL is selected for the AUTO UNLK feature. This feature determines when the automatic door unlocking will occur. When UNLK appears on the display, press and hold the reset button for at least one second to scroll through the available settings:

KEY OFF: The door(s) will unlock when the key is turned off.

SHIFT TO P (Park) (default): The door(s) will unlock when the vehicle is shifted into P (Park).

See *Automatic Door Locks on page 2-8* for more information.

To select a setting and move on to the next feature, press the information button while the desired setting is displayed on the DIC.

EXT (Exterior) LIGHTS

This feature, which allows the vehicle's exterior perimeter lighting to turn on each time the unlock button on the Remote Keyless Entry (RKE) transmitter is pressed, can be enabled or disabled. When EXT LIGHTS appears on the display, press and hold the reset button for at least one second to scroll through the available settings:

OFF: The exterior perimeter lighting will not turn on when the unlock button on the RKE transmitter is pressed.

ON (default): The exterior perimeter lighting will turn on when the unlock button on the RKE transmitter is pressed.

See *Remote Keyless Entry (RKE) System Operation on page 2-3* for more information.

To select a setting and move on to the next feature, press the information button while the desired setting is displayed on the DIC.

LANGUAGE

This feature allows you to select the language in which the DIC will display. When LANGUAGE appears on the display, press and hold the reset button for at least one second to scroll through the available settings:

ENGLISH (default): All messages will appear in English.

FRENCH: All messages will appear in French.

SPANISH: All messages will appear in Spanish.

GERMAN: All messages will appear in German.

To select a setting and exit out of the personalization menu mode, press the information button while the desired setting is displayed on the DIC.

Exiting Personalization Menu

The personalization menu will be exited when any of the following conditions occur:

- A ten second time period has elapsed.
- The ignition is turned off.
- The end of the personalization menu list is reached.

Lighting

Exterior Lighting

Exterior Lamp Controls	6-1
Exterior Lamps Off	
Reminder	6-2
Headlamp High/Low-Beam	
Changer	6-2
Flash-to-Pass	6-2
Daytime Running	
Lamps (DRL)	6-2
Automatic Headlamp	
System	6-3
Delayed Headlamps	6-4
Hazard Warning Flashers	6-4
Turn and Lane-Change	
Signals	6-4
Fog Lamps	6-5

Interior Lighting

Instrument Panel Illumination	
Control	6-5
Dome Lamps	6-6
Reading Lamps	6-6

Lighting Features

Entry/Exit Lighting	6-6
Parade Dimming	6-6
Battery Load Management	6-6
Battery Power Protection	6-7

Exterior Lighting

Exterior Lamp Controls



The band on the lever located on the left side of the steering column, operates the exterior lamps.

The exterior lamp control has the following four positions:

 **(Headlamps):** Turns on the headlamps, parking lamps, and taillamps.

 **(Parking Lamps):** Turns on the parking lamps and taillamps only.

6-2 Lighting

AUTO (Automatic Headlamp System): Automatically turns on the Daytime Running Lamps during daytime, and the headlamps, parking lamps, and taillamps at night.

 **(Off/On):** Turn the band to this position to turn on the Automatic Headlamp System. In Canada, this position only works when a vehicle is in the P (Park) position.

To turn on the Automatic Headlamp System, turn the switch to off/on. To turn them off, turn the switch to off/on again. This is a momentary control switch that springs back when released. The Automatic Headlamp System always turns on at the beginning of an ignition cycle.

Exterior Lamps Off Reminder

If the drivers door is opened and the ignition is turned off while leaving the lamps on, a warning chime will sound.

Headlamp High/Low-Beam Changer

To change the headlamps from low beam to high beam, push the turn signal/multifunction lever away from you.

This instrument panel cluster light  comes on if the high beam lamps are turned on while the ignition is in ON/RUN.

To change the headlamps from high beam to low beam, pull the turn signal lever toward you.

Flash-to-Pass

This feature lets the high-beam headlamps be used to signal a driver in front of you that you want to pass.

Pull the turn signal/multifunction lever toward you until the high-beam headlamps come on, then release the lever to turn them off.

Daytime Running Lamps (DRL)

Daytime Running Lamps (DRL) can make it easier for others to see the front of your vehicle during the day. Fully functional DRL are required on all vehicles first sold in Canada. The vehicle has a light sensor on top of the instrument panel that controls the DRL. Do not cover this sensor or the head lamps will be on when they are not needed.

The DRL system makes the low-beam headlamps come on at a reduced brightness when the following conditions are met:

- The ignition is on.
- The exterior lamps control is in AUTO.
- The exterior lamps control is in the parking lamps only position (This applies only to vehicles that are first sold in Canada).

- The light sensor detects daytime light.
- The parking brake is released or the vehicle is not in P (Park).

When the DRL system is on, the taillamps, sidemarker lamps, parking lamps, and instrument panel lights are not on unless you turn the exterior lamps control to the parking lamp position.

The regular headlamp system should be turned on when they are needed.

Automatic Headlamp System

When it is dark enough outside, the automatic headlamp system turns on the headlamps at the normal brightness along with other lamps such as the taillamps, sidemarker, parking lamps, and the instrument panel lights. The radio lights will also be dim.

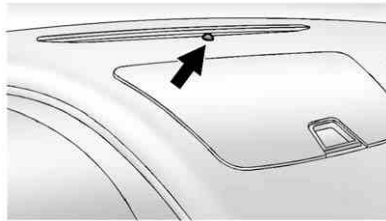

The vehicle has a light sensor on top of the instrument panel that controls the automatic headlamp system. Do not cover the sensor or the automatic headlamp system will turn on when it is not needed.

There is a delay in the transition between the daytime and nighttime operation of the DRL and the automatic headlamp systems so that driving under bridges or bright overhead street lights does not affect the system. The DRL and automatic headlamp systems will only be affected when the light sensor sees a change in lighting lasting longer than this delay.

If the vehicle is started in a dark garage, the automatic headlamp system comes on immediately. Once the vehicle leaves the garage, it takes about one minute for the automatic headlamp system to change to DRL if it is light outside. During that delay, the instrument panel cluster may not be as bright as usual. Make sure the instrument panel brightness control is in the full bright position. See *Instrument Panel Illumination Control on page 6-5*.

To idle the vehicle with the automatic headlamp system off, turn the ignition on and set the exterior light switch to the off/on position. For vehicles first sold in Canada, the transmission must stay in P (Park) for this function.

The regular headlamps should be used when needed.

6-4 Lighting

Delayed Headlamps

The delayed headlamps feature keeps the headlamps on for 20 seconds after the key is turned to LOCK/OFF, then the headlamps automatically turn off.

To override the 20 second delayed headlamp feature while it is active turn the turn signal/multifunction lever up one position and then back to AUTO.

Hazard Warning Flashers

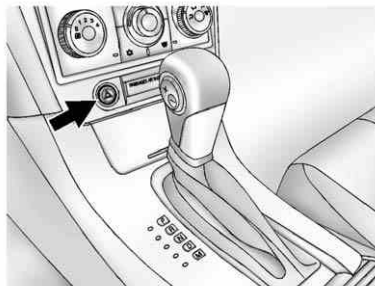

(Hazard Warning Flasher):

Press this button located on the instrument panel, to make the front and rear turn signal lamps flash on and off. This warns others that you are having trouble.

Press  again to turn the flashers off.

Turn and Lane-Change Signals



An arrow on the instrument panel cluster flashes in the direction of the turn or lane change.

Move the lever all the way up or down to signal a turn.

Raise or lower the lever until the arrow starts to flash to signal a lane change. Release the lever and the turn signal automatically flashes three times. If more flashes are desired, continue to hold the lever.

The lever returns to its starting position when it is released.

If a turn signal arrow flashes rapidly or does not come on, a signal bulb may need to be replaced. See *Fuses on page 10-31*.

Fog Lamps

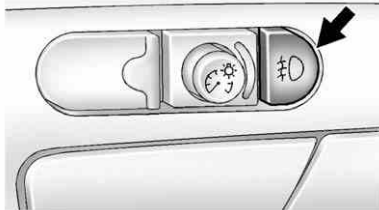

For vehicles with fog lamps, the button for this feature is located on the instrument panel, to the left of the steering wheel.

The ignition must be on for the fog lamps to work.

 : Press to turn the fog lamps on or off. An indicator light comes on when the fog lamps are on.

The parking lamps automatically turn on and off when the fog lamps are turned on and off.

The fog lamps turn off while the high-beam headlamps are turned on.

Some localities have laws that require the headlamps to be on along with the fog lamps.

Interior Lighting

Instrument Panel Illumination Control

The knob for this control is located on the instrument panel to the left of the steering column.

 (Instrument Panel

Brightness): Turn the knob clockwise or counterclockwise to brighten or dim the lights. Turn the knob completely clockwise to turn on the interior lamps.

Dome Lamps

The dome lamps come on when any door is opened. They turn off after all the doors are closed.

The dome lamps can also be turned on by turning the instrument panel brightness knob, located on the instrument panel to the left of the steering column, clockwise to the farthest position. In this position, the dome lamps remain on whether a door is opened or closed.

Reading Lamps

For vehicles with front and rear reading lamps, press the lens to turn the lamp on and off, while the doors are closed. These lamps come on automatically when any door is opened.

Lighting Features

Entry/Exit Lighting

The lamps inside the vehicle come on when any door is opened. These lamps fade out about 20 seconds after all of the doors have been closed or when the ignition is turned to ON/RUN. They also come on when the unlock symbol button or the horn symbol is pressed on the Remote Keyless Entry (RKE) system transmitter.

The lamps inside the vehicle stay on for about 20 seconds after the key is removed from the ignition to provide light as you exit.

Parade Dimming

Parade dimming is a separate lighting mode that comes on while the parking lamps are turned on during the day. It prevents the display lights and indicator lights from being dim, while the parking lamps are used during the day.

Battery Load Management

The vehicle has Electric Power Management (EPM) that estimates the battery's temperature and state of charge. It then adjusts the voltage for best performance and extended life of the battery.

When the battery's state of charge is low, the voltage is raised slightly to quickly bring the charge back up. When the state of charge is high, the voltage is lowered slightly to prevent overcharging. If the vehicle has a voltmeter gauge or a voltage display on the Driver Information Center (DIC), you may see the voltage move up or down. This is normal. If there is a problem, an alert will be displayed.

The battery can be discharged at idle if the electrical loads are very high. This is true for all vehicles. This is because the generator (alternator) may not be spinning fast enough at idle to produce all of the power needed for very high electrical loads.

A high electrical load occurs when several of the following are on, such as: headlamps, high beams, fog lamps, rear window defogger, climate control fan at high speed, heated seats, engine cooling fans, trailer loads, and loads plugged into accessory power outlets.

EPM works to prevent excessive discharge of the battery. It does this by balancing the generator's output and the vehicle's electrical needs. It can increase engine idle speed to generate more power whenever needed. It can temporarily reduce the power demands of some accessories.

Normally, these actions occur in steps or levels, without being noticeable. In rare cases at the highest levels of corrective action, this action may be noticeable to the driver. If so, a DIC message might be displayed, such as BATTERY SAVER ACTIVE, BATTERY VOLTAGE LOW, or LOW BATTERY. If one of these messages displays, it is recommended that the driver reduce the electrical loads as much as possible. See *Driver Information Center (DIC) on page 5-22*.

Battery Power Protection

The vehicle has a battery run-down protection feature designed to protect the vehicle's battery.

When any interior lamp (trunk, reading, or visor vanity) is left on while the ignition is turned off, the battery run-down protection system will automatically shut the lamp(s) off after 20 minutes. This will avoid draining the battery.

To reactivate the interior lamps, do one of the following:

- Turn on the ignition.
- Turn the exterior lamp control off and then on.
- Open a door.
- Press any Remote Keyless Entry (RKE) transmitter button (if equipped).
- Press the remote trunk release button.
- Press the power door lock switch.

The battery run-down feature will also be activated when any door on the vehicle is left open and the ignition is in LOCK/OFF.

Infotainment System

Introduction

Infotainment 7-1
 Theft-Deterrent Feature 7-2
 Operation 7-2

Radio

AM-FM Radio 7-6
 Satellite Radio 7-8
 Radio Reception 7-12
 Backglass Antenna 7-12
 Satellite Radio Antenna 7-13

Audio Players

CD Player 7-13
 Auxiliary Devices 7-18

Phone

Bluetooth 7-23

Introduction

Infotainment

Determine which radio the vehicle has and read the following pages to become familiar with its features.

 WARNING
<p>Taking your eyes off the road for extended periods could cause a crash resulting in injury or death to you or others. Do not give extended attention to infotainment tasks while driving.</p>

This system provides access to many audio and non-audio listings.

To minimize taking your eyes off the road while driving, do the following while the vehicle is parked:

- Become familiar with the operation and controls of the audio system.

- Set up the tone, speaker adjustments, and preset radio stations.

For more information, see *Defensive Driving* on page 9-2.

Notice: Contact your dealer before adding any equipment.

Adding audio or communication equipment could interfere with the operation of the engine, radio, or other systems, and could damage them. Follow federal rules covering mobile radio and telephone equipment.

Notice: The chime signals related to safety belts, parking brake, and other functions of your vehicle operate through the radio/entertainment system. If that equipment is replaced or additional equipment is added to your vehicle, the chimes may not work. Make sure that replacement

7-2 Infotainment System

or additional equipment is compatible with your vehicle before installing it. See *Accessories and Modifications on page 10-3*.

The vehicle has Retained Accessory Power (RAP). With RAP, the audio system can be played even after the ignition is turned off. See *Retained Accessory Power (RAP) on page 9-18* for more information.

Theft-Deterrent Feature

TheftLock® is designed to discourage theft of the vehicle's radio by learning a portion of the Vehicle Identification Number (VIN). The radio does not operate if it is stolen or moved to a different vehicle.

Operation



Radio with CD (Base)



Radio with CD (MP3) and USB Port shown, Radio with CD (MP3) similar

The vehicle has one of these radios as its infotainment system.

Softkeys

The Radio with CD (MP3) and USB Port, and the Radio with CD (MP3) have five softkeys located below the radio display. Softkeys are used to

control functions that appear on the radio display as tabs directly above the softkeys.

Using the Radio

⏻ (Power/Volume): Press to turn the system on and off. Turn to increase or decrease the volume.

i (Information): Press to switch the display between the radio station frequency and the time. While the ignition is off, press this button to display the time.

Speed Compensated Volume (SCV): Radios with the Speed Compensated Volume (SCV) feature automatically adjust the radio volume to compensate for road and wind noise as the vehicle speeds up or slows down, so that the volume level is consistent.

To activate SCV:







1. Set the radio volume to the desired level.
2. Press MENU to display the radio setup menu.
3. Press the softkey under the AUTO VOLUM tab on the radio display.
4. Press the softkey under the desired Speed Compensated Volume setting (OFF, Low, Med, or High) to select the level of radio volume compensation.

7-4 Infotainment System

The display times out after approximately 10 seconds. Each higher setting allows for more radio volume compensation at faster vehicle speeds.

Setting the Tone (Bass/Treble) Radio with CD

To adjust the bass, or treble:

1. Press the  knob until Bass or Treble displays.
2. To adjust the setting, do one of the following:
 - Turn the  knob.
 - Press either  SEEK, or  SEEK button.
 - Press either  FWD, or  REV button.



EQ (Equalization): Press this button to choose bass and treble equalization settings designed for different types of music.





Selecting MANUAL or changing bass or treble, returns the EQ to the manual bass and treble settings.

Unique EQ settings can be saved for each source.

Setting the Tone (Bass/Midrange/Treble) Radio with CD (MP3) and USB Port, Radio with CD (MP3)

BASS/MID/TREB (Bass, Midrange, or Treble): To adjust the bass, midrange, or treble:

1. Press the  knob until the tone control tabs display.
2. Highlight the desired tone control tab by doing one of the following:
 - Pressing the  knob.
 - Press the softkey under the desired tab.

3. Adjust the setting by doing one of the following:
 - Turn the  knob clockwise or counterclockwise.
 - Press the  SEEK, or  SEEK button.
 - Press the  FWD, or  REV button.

If a station's frequency is weak or if there is static, decrease the treble.

To quickly adjust bass, midrange, or treble to the middle position, press the softkey positioned under the BASS, MID, or TREB tab for more than two seconds. A beep sounds and the level adjusts to the middle position.

To quickly adjust all tone and speaker controls to the middle position, press the  knob for more than two seconds until a beep sounds.





EQ (Equalization): Press this button to choose bass and treble equalization settings designed for different types of music. Selecting MANUAL or changing bass or treble, returns the EQ to the manual bass and treble settings.



Unique EQ settings can be saved for each source.

If the radio has a Bose® audio system, the EQ settings are either MANUAL or TALK.

Adjusting the Speakers (Balance/Fade) Radio with CD





To adjust the balance or fade:



1. Press the  or press the  knob until the speaker control label displays.
2. To adjust the setting, do one of the following:
 - Turn the  knob.
 - Press either  SEEK, or  SEEK button.

- Press either  FWD, or  REV button.

Adjusting the Speakers (Balance/Fade) Radio with CD (MP3) and USB Port, Radio with CD (MP3)

BAL/FADE (Balance/Fade): To adjust the balance or fade:

1. Press the  knob until the speaker control tabs display.
2. Highlight the desired speaker control tab by doing one of the following:
 - Pressing the  knob.
 - Press the softkey under the desired tab.
3. Adjust the setting by doing one of the following:
 - Turn the  knob clockwise or counterclockwise.
 - Press the  SEEK, or  SEEK button.

- Press the  FWD, or  REV button.

To quickly adjust all speaker and tone controls to the middle position, press the  knob for more than two seconds.

If the Rear Seat Audio (RSA) is turned on, the radio disables FADE and mutes the rear speakers.

Radio Messages

Calibration Error: Displays if the radio is no longer calibrated properly for the vehicle. The vehicle must be returned to your dealer for service.

Loc or Locked: Displays when the TheftLock® system has activated. Take the vehicle to your dealer for service.

If any error occurs repeatedly or if an error cannot be corrected, contact your dealer.

Radio

AM-FM Radio

Radio Data System (RDS)

The radio may have RDS. The RDS feature is available for use only on FM stations that broadcast RDS information. This system relies upon receiving specific information from these stations and only works when the information is available. While the radio is tuned to an FM-RDS station, the station name or call letters display. In rare cases, a radio station could broadcast incorrect information that causes the radio features to work improperly. If this happens, contact the radio station.

i (Information) (RDS Features):

For vehicles with RDS features, press **i** to display additional text information related to the current FM-RDS station. If information is available, the song title information displays on the top line of the display and artist information

displays on the bottom line. When information is not available, "NO INFO" displays.

Auto Text (RDS Features): If additional information is available for the current song being played, Auto Text will automatically page/scroll the information every three seconds above the FAV presets on the radio display. By default, Auto Text is enabled.

To change the Auto Text setting:

1. Press MENU to display the radio setup menu.
2. Press the softkey under AUTO TXT tab on the radio display.
3. Press the softkey under the ON or OFF tab on the radio display.

If **i** is pressed and the song title or artist information is longer than what can be displayed, the extra information will page every three seconds when Auto Text is activated.

Finding a Station

BAND: Press to choose between FM1, FM2, AM, or XM™ (if equipped) on the Radio with CD (Base). Press to choose between FM, AM, XM (if equipped) on the Radio with CD (MP3) and USB Port, or the Radio with CD (MP3).

♪ (Tune): Turn to select radio stations.

⏪ SEEK: Press to seek or scan stations with a strong signal in the selected band.

- To seek stations, press and release **⏪ SEEK** to go to the previous station and stay there.
- To scan stations, press and hold **⏪ SEEK** for a few seconds until the radio beeps once. The radio goes to a station, plays for a few seconds, then goes to the next station. Press **⏪ SEEK** again to stop scanning.

- To scan preset stations in the selected band, press and hold **↵** SEEK for four seconds until a double beep sounds. The radio goes to a stored preset, plays for a few seconds, then goes to the next stored preset. Press **↵** SEEK again to stop scanning preset stations.

↵ **SEEK**: Press to seek or scan stations with a strong signal in the selected band.

- To seek stations, press and release **↵** SEEK to go to the next station and stay there.
- To scan stations, press and hold **↵** SEEK for a few seconds until the radio beeps once. The radio goes to a station, plays for a few seconds, then goes to the next station. Press **↵** SEEK again to stop scanning.
- To scan preset stations in the selected band, press and hold **↵** SEEK for four seconds

until a double beep sounds. The radio goes to a stored preset, plays for a few seconds, then goes to the next stored preset. Press **↵** SEEK again to stop scanning preset stations.

Storing Radio Stations

Drivers are encouraged to store radio station while the vehicle is parked, see *Defensive Driving on page 9-2*. Tune to stored radio stations using the presets, favorites button, and steering wheel controls, if the vehicle has this feature.

Radios that have a FAV button store radio stations as favorites, up to 36 stations can be programmed as favorites using the six softkeys below the radio station frequency tabs and by using the FAV button. Press the FAV button to go through up to six pages of favorites, each having six favorite stations available per page. Each page of favorites can contain any combination of AM, FM, or XM, if equipped, stations.

Radios that do not have a FAV button store radio stations as presets, up to 18 stations (six FM1, six FM2, and six AM), can be programmed on the six numbered pushbuttons.

Storing a Radio Station as a Preset

Radios that have numbered pushbuttons store radio stations as presets.

Up to 18 stations (six FM1, six FM2, and six AM), can be programmed on the six numbered buttons.

To store preset stations:

1. Tune to a radio station.
2. Press and hold one of the six numbered pushbuttons for three seconds until a beep sounds.
3. Repeat Steps 1 and 2 to store additional radio stations.

7-8 Infotainment System

Storing a Radio Station as a Favorite

Radio that have a FAV button store radio stations as favorites.

To store a station as a favorite:

1. Tune to a radio station.
2. Press the FAV button to display the page where the station will be stored.
3. Press and hold one of the six softkeys until a beep sounds.
4. Repeat Steps 1 through 3 to store additional radio stations.

The number of favorites pages can be setup using the MENU button. To setup the number of favorites pages:

1. Press the MENU button.
2. Press the softkey located below the FAV 1-6 tab.
3. Select the number of favorites pages by pressing the softkey located below the displayed page numbers.

4. Press the FAV button, or let the menu time out, to return to the original main radio screen showing the radio station frequency tabs and to begin the process of programming favorites.

Satellite Radio

XM™ Satellite Radio Service

XM is a satellite radio service that is based in the 48 contiguous United States and 10 Canadian provinces. XM Satellite Radio has a wide variety of programming and commercial-free music, coast-to-coast, and in digital-quality sound. A service fee is required to receive the XM service. If XM Service needs to be reactivated, the radio will display "No Subscription Please Renew" on channel XM1. For more information, contact XM at www.xmradio.com or call 1-800-929-2100 in the U.S. and www.xmradio.ca or call 1-877-438-9677 in Canada.

i (Information) (XM Satellite Radio Service): For vehicles with XM, press **i** to display additional text information related to the current XM channel. If information is available, the song title information displays on the top line of the display and artist information displays on the bottom line. When information is not available, "NO INFO" displays.

Auto Text (Satellite Radio

Service): If additional information is available for the current song being played, Auto Text will automatically page/scroll the information every three seconds above the FAV presets on the radio display. By default, Auto Text is enabled.

To change the Auto Text setting:

1. Press MENU to display the radio setup menu.
2. Press the softkey under AUTO TXT tab on the radio display.
3. Press the softkey under the ON or OFF tab on the radio display.

If **i** is pressed and the song title or artist information is longer than what can be displayed, the extra information will page every three seconds when Auto Text is activated.

Finding an XM Channel

BAND: Press to switch between AM, FM, or XM™, if equipped.

🎵 (Tune): Turn to manually select an XM channel.

⏪ SEEK: Press to go to the previous XM channel.

- To scan stations, press and hold **⏪ SEEK** for a few seconds until the radio beeps once. The radio goes to a channel, plays for a few seconds, then goes to the next station. Press **⏪ SEEK** again to stop scanning.

⏩ SEEK: Press to go to the next XM channel.

- To scan stations, press and hold **⏩ SEEK** for a few seconds until the radio beeps once. The radio

goes to a station, plays for a few seconds, then goes to the next station. Press **⏩ SEEK** again to stop scanning.

⏪ REV: Press to go to the previous XM category.

⏩ FWD: Press to go to the next XM category.

Finding a Category (CAT) Channel

To find XM channels in a category:

1. Press the CAT button to display the category tabs. Continue pressing the CAT button until the desired category name displays.
 - Radios with CD and DVD can also navigate the category list by pressing the **⏩ FWD** or the **⏪ REV** button.
2. Press either of the two softkeys below the desired category tab to immediately tune to the first XM station in that category.

To go to the previous or next XM station in the selected category, do one of the following:

- Turn the **🎵** knob.
 - Press the softkey below the right or left arrows in the category tab.
 - Press **⏪ SEEK** or **⏩ SEEK**.
3. To exit the category search mode, press the FAV button or BAND button to display the favorites again.

Adding and Removing Categories

Categories cannot be added or removed while the vehicle is moving faster than 8 km/h (5 mph).

To add or remove a category:

1. Press the MENU button.
2. Press the softkey located below the XM CAT tab.
3. Turn the **🎵** knob to display the category you want to add or remove.

7-10 Infotainment System

4. Press the softkey located under the Add or Remove tab.

To restore all removed categories, press the softkey under the Restore All tab.

5. Repeat the steps to remove more categories.

Storing XM Channels

Drivers are encouraged to store radio station while the vehicle is parked, see *Defensive Driving on page 9-2*. Tune to stored radio stations using the presets, favorites button, and steering wheel controls, if the vehicle has this feature.

Up to 36 stations can be programmed as favorites using the six softkeys below the radio station frequency tabs and by using the FAV button. Press the FAV button to go through up to six pages of favorites, each having six favorite stations available per page. Each page of favorites can contain any combination of AM, FM, or XM, if equipped, stations.

Storing an XM Channel as a Favorite

To store a station as a favorite:

1. Tune to an XM channel.
2. Press the FAV button to display the page where the station will be stored.
3. Press and hold one of the six softkeys until a beep sounds.
4. Repeat Steps 1 through 3 to store additional radio stations.

The number of favorites pages can be setup using the MENU button. To setup the number of favorites pages:

1. Press the MENU button.
2. Press the softkey located below the FAV 1-6 tab.
3. Select the number of favorites pages by pressing the softkey located below the displayed page numbers.

4. Press the FAV button, or let the menu time out, to return to the original main radio screen showing the radio station frequency tabs and to begin the process of programming favorites.

XM Radio Messages

XL (Explicit Language Channels):

These channels, or any others, can be blocked at a customer's request, by calling 1-800-929-2100 in the U.S. and 1-877-438-9677 in Canada.

XM Updating: The encryption code in the receiver is being updated, and no action is required. This process should take no longer than 30 seconds.

No XM Signal: The system is functioning correctly, but the vehicle is in a location that is blocking the XM™ signal. When the vehicle is moved into an open area, the signal should return.

Loading XM: The audio system is acquiring and processing audio and text data. No action is needed. This message should disappear shortly.

Channel Off Air: This channel is not currently in service. Tune in to another channel.

Channel Unauth: This channel is blocked or cannot be received with your XM Subscription package.

Channel Unavail: This previously assigned channel is no longer assigned. Tune to another station. If this station was one of the presets, choose another station for that preset button.

No Artist Info: No artist information is available at this time on this channel. The system is working properly.

No Title Info: No song title information is available at this time on this channel. The system is working properly.

No CAT Info: No category information is available at this time on this channel. The system is working properly.

No Information: No text or informational messages are available at this time on this channel. The system is working properly.

No Subscription Please Renew: XM subscription needs to be reactivated. Contact XM at www.xmradio.com or call 1-800-929-2100 in the U.S. and www.xmradio.ca or call 1-877-438-9677 in Canada.

CAT Not Found: There are no channels available for the selected category. The system is working properly.

XM Theftlocked: The XM receiver in the vehicle could have previously been in another vehicle. For security purposes, XM receivers cannot be swapped between vehicles. If this

message is received after having the vehicle serviced, check with your dealer.

XM Radio ID: If tuned to channel 0, this message alternates with the XM™ Radio 8 digit radio ID label. This label is needed to activate the service.

Unknown: If this message is received when tuned to channel 0, there could be a receiver fault. Consult with your dealer.

Check Antenna: If this message does not clear within a short period of time, the receiver or antenna could have a fault. Consult with your dealer.

Check XM Receiver: If this message does not clear within a short period of time, the receiver could have a fault. Consult with your dealer.

XM Not Available: If this message does not clear within a short period of time, the receiver could have a fault. Consult with your dealer.

Radio Reception

Frequency interference and static can occur during normal radio reception if items such as cell phone chargers, vehicle convenience accessories, and external electronic devices are plugged into the accessory power outlet. If there is interference or static, unplug the item from the accessory power outlet.

FM

FM signals only reach about 16 to 65 km (10 to 40 mi). Although the radio has a built-in electronic circuit that automatically works to reduce interference, some static can occur, especially around tall buildings or hills, causing the sound to fade in and out.

AM

The range for most AM stations is greater than for FM, especially at night. The longer range can cause station frequencies to interfere with each other. For better radio reception, most AM radio stations boost the power levels during the day, and then reduce these levels during the night. Static can also occur when things like storms and power lines interfere with radio reception. When this happens, try reducing the treble on the radio.

XM™ Satellite Radio Service

XM Satellite Radio Service gives digital radio reception from coast to coast in the 48 contiguous United States, and in Canada. Just as with FM, tall buildings or hills can interfere with satellite radio signals, causing the sound to fade in and out. In addition, traveling or standing under heavy foliage, bridges, garages, or tunnels may cause loss of the XM signal for a period of time.

Cellular Phone Usage

Cellular phone usage may cause interference with the vehicle's radio. This interference may occur when making or receiving phone calls, charging the phone's battery, or simply having the phone on. This interference can cause an increased level of static while listening to the radio. If static is received while listening to the radio, unplug the cellular phone and turn it off.

Backglass Antenna

The AM-FM antenna is integrated with the rear window defogger, located in the rear window. Make sure that the inside surface of the rear window is not scratched and that the lines on the glass are not damaged. If the inside surface is damaged, it could interfere with radio reception. For proper radio reception, the antenna connector needs to be properly attached to the post on the glass.

If a cellular telephone antenna needs to be attached to the glass, make sure that the grid lines for the AM-FM antenna are not damaged. There is enough space between the grid lines to attach a cellular telephone antenna without interfering with radio reception.

Notice: Using a razor blade or sharp object to clear the inside rear window can damage the rear window antenna and/or the rear window defogger. Repairs would not be covered by the vehicle warranty. Do not clear the inside rear window with sharp objects.

Notice: Do not apply aftermarket glass tinting with metallic film. The metallic film in some tinting materials will interfere with or distort the incoming radio reception. Any damage caused to your backglass antenna due to metallic tinting materials will not be covered by the vehicle warranty.

Satellite Radio Antenna

For vehicles with XM satellite radio service, the antenna is located on the roof of the vehicle. Keep the antenna clear of obstructions for clear radio reception.

Audio Players

CD Player

Some CD players can play MP3 CD-R or CD-RW discs, see “MP3” later in this section for more information.

The CD player can play the smaller 8 cm (3 in) single discs with an adapter ring.

Care of the CD Player

Do not add labels to a disc, it could get caught in the CD player. Use a marking pen to write on the top of the disc if a description is needed.

Do not use CD lens cleaners, they could damage the CD player.

Notice: If a label is added to a CD, more than one CD is inserted into the slot at a time, or an attempt is made to play scratched or damaged CDs, the CD player could be damaged. While using the CD player, use only CDs in good condition without any label,

load one CD at a time, and keep the CD player and the loading slot free of foreign materials, liquids, and debris.

If an error displays, see “CD Messages” later in this section.

Care of CDs

Store a disc in its original case or a protective case and away from direct sunlight and dust. If the bottom of a disc is damaged it may not play properly or at all. Do not touch the bottom of a disc while handling it, pick it up by grasping the outer edges or the edge of the hole and the outer edge.

If the surface of a disc is dirty, take a soft, lint free cloth or dampen a clean, soft cloth in a mild, neutral detergent solution mixed with water, and clean it. Make sure the wiping process starts from the center to the edge.

Inserting a Disc

Insert the disc partway into the slot, label side up. The player pulls it in and the disc begins playing.

Use an adapter ring when playing the smaller 8 cm (3 in) discs. Smaller discs with the adapter ring are loaded the same way as a full-size disc.

Ejecting a Disc

 **EJECT:** Press to eject the disc. If the disc is not removed after several seconds, the CD player automatically pulls the disc back in.

Playing a CD

When a CD is inserted into the player the CD symbol displays, and as each new track starts to play the track number displays.

If the ignition or radio is turned off when a CD is in the player, the CD stays in the player. If the ignition or radio is turned on when a CD is in

the player, the CD starts to play where it stopped, if it was the last selected audio source.

Buttons and Knobs

The buttons and knobs on the radio control the following features.

 **(Tune):** Turn to select tracks on the CD.

 **SEEK:** Press to go to the start of the current track, if more than ten seconds have played. Press and hold or press multiple times to continue moving backward through the tracks on the CD.

 **SEEK:** Press to go to the next track. Press and hold or press multiple times to continue moving forward through the tracks on the CD.

 **REV (Reverse):** Press and hold to reverse playback quickly within a track. Sound is heard at a reduced volume and the elapsed time of the track displays. Release to resume playing the track.

▷▷ **FWD (Fast Forward):** Press and hold to advance playback quickly within a track. Sound is heard at a reduced volume and the elapsed time of the track displays. Release to resume playing the track.

i (Information): Press to display available additional information about the current track.

BAND: Press to listen to the radio while a CD is playing. The CD remains inside the CD player.

CD/AUX (CD/Auxiliary): Press to play a CD while listening to the radio or a portable audio device. Press this button again and the system automatically searches for an auxiliary input device, such as a portable audio player. If a portable audio player is not connected, No Aux Input Device Found may display.

Softkeys

The five softkeys below the radio display are used to control functions that display as tabs.

The softkeys below the radio display control the following features.

RDM (Random): Tracks can be listened to in random, rather than sequential order.

To use random:

1. Press the softkey below RDM tab until Random Current Disc displays.
2. Press the softkey again to turn off random play.

MP3 Supported Files

The Radio with CD (MP3), Radio with USB and CD (MP3), have the capability of playing an MP3 CD-R or CD-RW disc.

The radio can also play discs that contain both uncompressed CD audio and MP3 files. When a disc

contains both types of audio, the CD player reads all MP3 files first, then the uncompressed CD audio files.

Supported File and Folder Structure

The radio supports:

- Up to 50 folders.
- Up to eight folders in depth.
- Up to 50 playlists.
- Up to 255 files.
- Playlists with an .m3u or .wpl extension.
- Files with an .mp3 or .cda file extension.

Root Directory

The root directory is treated as a folder. Files are stored in the root directory when the disc or storage device does not contain folders. Files accessed from the root directory of a disc display as F1 ROOT.

Empty Folder

Folders that do not contain files are skippedd, and the player advances to the next folder that contains files.

File Naming

The song name that displays is the song name that is contained in the ID3 tag. If the song name is not present in the ID3 tag, then the radio displays the file name without the file extension as the track name.

Track names longer than 32 characters or four pages are shortened. The display does not show parts of words on the last page of text and the extension of the filename is not displayed.

Playlists

Discs that have playlists that were created using WinAmp™, MusicMatch™, or Real Jukebox™ software can be accessed, however, there is no playlist editing capability using the radio. These playlists are treated as special folders containing compressed audio song files.

Playing an MP3

Order of Play

Tracks are played in the following order:

- Play begins from the first track in the first playlist and continues sequentially through all tracks in each playlist. When the last track of the last playlist has played, play continues from the first track of the first playlist.
- Play begins from the first track in the first folder and continues sequentially through all tracks in each folder. When the last track of the last folder has played, play continues from the first track of the first folder.

When playback starts from a new folder, the new track name displays unless folder mode has been chosen as the default display, then the new folder name displays.

Buttons and Knobs

The buttons and knobs on the radio control the following features.

🎵 (Tune): Turn to select MP3 files on the disc.

⏮ SEEK: Press to go to the start of the track, if more than ten seconds have played. Press and hold or press multiple times to continue moving backward through tracks.

⏭ SEEK: Press to go to the next track. Press and hold or press multiple times to continue moving forward through tracks.

⏪ REV (Reverse): Press and hold to reverse playback quickly. Sound is heard at a reduced volume and the elapsed time of the track displays. Release ⏪ REV to resume playing.

⏩ FWD (Fast Forward): Press and hold to advance playback quickly. Sound is heard at a reduced

volume and the elapsed time of the track displays. Release **▶▶ FWD** to resume playing.

i (Information): Press to display available additional information about the current track.

BAND: Press to listen to the radio while an MP3 disc is playing. The MP3 disc remains inside the CD player.

CD/AUX (CD/Auxiliary): Press to play an MP3 disc while listening to the radio or a portable audio device. Press this button again and the system automatically searches for an auxiliary input device, such as a portable audio player. If a portable audio player is not connected, No Aux Input Device Found may display.

Softkeys

The five softkeys below the radio display are used to control functions that display as tabs.

The softkeys below the radio display control the following features.

< [Folder] (Previous Folder): Press the softkey below **< [Folder]** to go to the first track in the previous folder.

[Folder] > (Next Folder): Press the softkey below **[Folder] >** to go to the first track in the next folder.

RDM (Random): MP3 files can be listened to on a CD in random, rather than sequential order. To use random:

1. Press the softkey under the RDM tab until Random Current Disc displays to play songs from the current CD in random order.
2. Press the same softkey again to turn off random play.

[Music Navigator] (Music Navigator): Press the softkey below **[Music Navigator]** to have the files played in order by artist or album. The player scans the disc to sort the files by artist and album ID3 tag information. It can take several minutes to scan the disc depending

on the number of files on the disc. The radio may begin playing while it is scanning in the background.

When the scan is finished, the disc begins playing files in order by artist. The current artist playing is shown on the second line of the display. Once all songs by that artist are played, the player moves to the next artist in alphabetical order and begins playing files by that artist.

To listen to files by another artist, press the softkey located below either arrow tab. The disc goes to the next or previous artist in alphabetical order. Continue pressing either softkey below the arrow tab until the desired artist displays.

To change from playback by artist to playback by album:

1. Press the softkey located below the Sort By tab.
2. Press one of the softkeys below the album tab from the sort screen.

7-18 Infotainment System

3. Press the softkey below the back tab to return to the main music navigator screen.

The album name displays on the second line between the arrows and songs from the current album begins to play. Once all songs from that album have played, the player moves to the next album in alphabetical order on the disc and begins playing MP3 files from that album.

To exit music navigator mode, press the softkey below the Back tab to return to normal MP3 playback.

CD Player Messages

CHECK DISC: If an error message displays and/or the disc comes out, it could be for one of the following reasons:

- The CD player is very hot. When the temperature returns to normal, the disc should play.
- The road is very rough. When the road becomes smoother, the disc should play.

- The disc is dirty, scratched, wet, or upside down.
- The air is very humid. If so, wait about an hour and try again.
- A problem may have occurred while burning the disc.
- The label could be caught in the CD player.

If the disc is not playing correctly for any other reason, try a known good disc.

If any error occurs repeatedly or if an error cannot be corrected, contact your dealer. If the radio displays an error message, write it down and provide it to your dealer when reporting the problem.

Auxiliary Devices

This vehicle may have a 3.5 mm (1/8 in) auxiliary input jack and a USB port, located on the audio faceplate. Some portable audio

devices such as iPods[®], MP3 players, and USB storage devices can be connected to the vehicle using a 3.5 mm (1/8 in) cable or a USB cable.

Drivers are encouraged to set up any auxiliary device while the vehicle is in P (Park). See *Defensive Driving on page 9-2* for more information on driver distraction.

Using the 3.5 mm (1/8 in) Auxiliary Input Jack

The radio system may have a 3.5 mm (1/8 in) auxiliary input jack located on the lower right or left side of the faceplate. This is not an audio output; do not plug the headphone set into the front auxiliary input jack. An external audio device such as an iPod[®], laptop computer, MP3 player, CD changer, etc. can be connected to the auxiliary input jack for use as another audio source.

To use a portable audio player, connect a 3.5 mm (1/8 in) cable to the auxiliary input jack. When a device is connected, press the CD/AUX button to begin playing audio from the device over the vehicle speakers.

⏮ (Power/Volume): Turn to adjust the volume. Additional volume adjustments may have to be made from the portable device if the volume is too quiet or not loud.

BAND: Press to listen to the radio while a portable audio device is connected to the auxiliary input. The portable audio device continues playing until it is stopped or turned off.

CD/AUX (CD/Auxiliary): Press to play a CD while a portable audio device is connected to the auxiliary input. Press again and the system begins playing audio from the connected portable audio player. If a portable audio player is not connected, No Aux Input Device may display.

Using the USB Port

The radio may have a USB port located on the lower right side of the faceplate. Radios that have a USB port can play .mp3 and .wma files that are stored on a USB storage device as well as tracks that are stored on an iPod®.

USB Supported File and Folder Structure

The radio supports:

- Up to 700 folders.
- Up to eight folders in depth.
- Up to 65,535 files.
- Folder and file names up to 64 bytes.
- Files with an .mp3 or .wma file extension.
- AAC files stored on an iPod.
- FAT16
- FAT32

Root Directory

The root directory is treated as a folder. Files are stored in the root directory when the disc or storage device does not contain folders. Files accessed from the root directory of a USB device display as F1 ROOT.

Empty Folder

Folders that do not contain files are skipped, and the player advances to the next folder that contains files.

File Naming

The song name that displays is the song name that is contained in the ID3 tag. If the song name is not present in the ID3 tag, then the radio displays the file name without the file extension as the track name.

Track names longer than 32 characters or four pages are shortened. The display does not show parts of words on the last page of text and the extension of the filename is not displayed.

7-20 Infotainment System

Preprogrammed Playlists

Playlists that have an .m3u or .pls file extension and are stored on a USB device may be supported by the radio with a USB port.

Order of Play

Tracks are played in the following order:

- Play begins from the first track in the first playlist and continues sequentially through all tracks in each playlist. When the last track of the last playlist has played, play continues from the first track of the first playlist.
- Play begins from the first track in the first folder and continues sequentially through all tracks in each folder. When the last track of the last folder has played, play continues from the first track of the first folder.

When play enters a new folder, the display does not automatically show the new folder name unless the

folder mode has been chosen as the default display. The new track name displays.

Connecting a USB Storage Device or iPod

The radio buttons, knobs and softkeys are used to control a USB storage device or an iPod when it is connected to the USB port.

To connect a USB storage device, connect the device to the USB port located on the front of the radio.

To connect an iPod, connect one end of the USB cable that came with the iPod to the iPod's dock connector and connect the other end to the USB port located on the front of the radio. If the vehicle is on and the USB connection works, "OK to disconnect" and a GM logo may appear on the iPod and iPod appears on the radio's display.

The iPod charges while it is connected to the USB port if the ignition is in the ACC/ACCESSORY or ON/RUN position. When the

ignition is turned OFF, the iPod automatically powers off and will not charge or draw power from the vehicle's battery.

Older iPod's that are not supported can still be used by connecting it to the 3.5 mm (1/8 in) auxiliary input jack using a 3.5 mm (1/8 in) cable.

Using a USB Storage Device or iPod

The buttons and knobs on the radio and the softkeys below the radio display are used to control a USB storage device or an iPod.

Buttons and Knobs

The buttons and knobs on the radio control the following features.

♪ (Tune): Turn to select files.

⏮ SEEK: Press to go to the start of the track, if more than ten seconds have played. Press and hold ⏮ SEEK or press it multiple times to continue moving backward through tracks.

⏮ SEEK: Press to go to the next track. Press and hold ⏮ SEEK or press it multiple times to continue moving forward through tracks.

⏪ REV (Reverse): Press and hold to reverse playback quickly. Sound is heard at a reduced volume.

Release ⏪ REV to resume playing.

⏩ FWD (Fast Forward): Press and hold to advance playback quickly. Sound is heard at a reduced volume. Release ⏩ FWD to resume playing.

i (Information): Press to display additional information about the selected track.

Softkeys

The five softkeys below the radio display are used to control functions that display as tabs.

To use the softkeys, press a softkey below any tab that is displayed, or if no tabs are displayed, press the first or last softkey below the radio display to display the tabs.

The softkeys below the radio display control the following features.

⏸ (Pause): Press the softkey below ⏸ to pause the track. The tab appears raised when pause is being used. Press the softkey below ⏸ again to resume playback.

⏪ Back: Press the softkey below the back tab to go back to the main display screen on an iPod, or the root directory on a USB storage device.

📁 (Folder View): Press the softkey below 📁 to view the contents of the current folder on the USB drive.

To browse and select files:

1. Press the softkey below 📁.
2. Turn 🎵 to scroll through the list of folders.
3. Press 🎵 to select the desired folder. If there is more than one folder, repeat Steps 1 and 2 until the desired folder is reached.

4. Turn 🎵 to scroll through the files in the selected folder.
5. Press 🎵 to select the desired file to be played.

To skip through large lists, the five softkeys can be used to navigate in the following order:

- First softkey, first item in the list.
- Second softkey, 1% through the list each time the softkey is pressed.
- Third softkey, 5% through the list each time the softkey is pressed.
- Fourth softkey, 10% through the list each time the softkey is pressed.
- Fifth softkey, end of the list.





🎵 (Music Navigator): Press the softkey below 🎵 to view and select a track on an iPod. Files are sorted by:

- Playlists
- Artists

7-22 Infotainment System

- Albums
- Genres
- Songs
- Composers



To select tracks:



1. Press the softkey below .
2. Turn  to scroll through the list of menus.
3. Press  to select the desired menu.
4. Turn  to scroll through the folders or files in the selected menu.
5. Press  to select the track.





To skip through large lists, the five softkeys can be used to navigate in the following order:



- First softkey, first item in the list.
- Second softkey, 1% through the list each time the softkey is pressed.



- Third softkey, 5% through the list each time the softkey is pressed.
- Fourth softkey, 10% through the list each time the softkey is pressed.
- Fifth softkey, end of the list.

 **(Repeat All):** Press the softkey below  to repeat all tracks. The tab appears lowered when Repeat All is being used. This is the default mode when a USB storage device or iPod is first connected.



 **(Repeat Track):** Press the softkey below  to repeat one track. The tab appears raised when Repeat Track is being used.

Press the softkey below , ,  or  to select between Shuffle Off, Shuffle All Songs/ Shuffle Album, or Shuffle Folder.

 **(Shuffle Off):** Press the softkey below  to turn shuffle off. This is the default mode when a USB storage device or iPod is first connected.

 **(Shuffle All Songs / Shuffle Songs):** Press the softkey below  or  to shuffle all songs on the USB storage device or iPod.

 **(Shuffle Album):** Press the softkey below  to shuffle all songs in the current album on an iPod.

 **(Shuffle Folder):** Press the softkey below  to shuffle all songs in the current folder on a USB storage device.

Phone

Bluetooth

For vehicles equipped with Bluetooth capability, the system can interact with many cell phones, allowing:

- Placement and receipt of calls in a hands-free mode.
- Sharing of the cell phone's address book or contact list with the vehicle.

To minimize driver distraction, before driving, and with the vehicle parked:

- Become familiar with the features of the cell phone. Organize the phone book and contact lists clearly and delete duplicate or rarely used entries. If possible, program speed dial or other shortcuts.
- Review the controls and operation of the infotainment system.

- Pair cell phone(s) to the vehicle. The system may not work with all cell phones. See "Pairing a Phone" in this section for more information.
- If the cell phone has voice dialing capability, learn to use that feature to access the address book or contact list. See "Voice Pass-Thru" in this section for more information.
- See "Storing and Deleting Phone Numbers" in this section for more information.

WARNING

When using a cell phone, it can be distracting to look too long or too often at the screen of the phone or the infotainment (navigation) system. Taking your eyes off the road too long or too often could cause a crash resulting in injury or death. Focus your attention on driving.

A Bluetooth system can use a Bluetooth-capable cell phone with a Hands Free Profile to make and receive phone calls. The system can be used while the key is in ON/RUN or ACC/ACCESSORY position. The range of the Bluetooth system can be up to 9.1 m (30 ft). Not all phones support all functions, and not all phones work with the in-vehicle Bluetooth system. See www.gm.com/bluetooth for more information on compatible phones.

Voice Recognition

The Bluetooth system uses voice recognition to interpret voice commands to dial phone numbers and name tags.

For additional information, say "Help" while you are in a voice recognition menu.

Noise: Keep interior noise levels to a minimum. The system may not recognize voice commands if there is too much background noise.

7-24 Infotainment System

When to Speak: A short tone sounds after the system responds indicating when it is waiting for a voice command. Wait until the tone and then speak.



How to Speak: Speak clearly in a calm and natural voice.



Audio System

When using the in-vehicle Bluetooth system, sound comes through the vehicle's front audio system speakers and overrides the audio system. Use the audio system volume knob, during a call, to change the volume level. The adjusted volume level remains in memory for later calls. To prevent missed calls, a minimum volume level is used if the volume is turned down too low.

Bluetooth Controls

Use the buttons located on the steering wheel to operate the in-vehicle Bluetooth system. See *Steering Wheel Controls on page 5-2* for more information.

 /  (**Push To Talk**): Press to answer incoming calls, to confirm system information, and to start speech recognition.

 /  (**Mute/End Call**): Press to end a call, reject a call, or to cancel an operation.

Pairing



A Bluetooth cell phone must be paired to the Bluetooth system and then connected to the vehicle before it can be used. See your cell phone manufacturers user guide for Bluetooth functions before pairing the cell phone. If a Bluetooth phone is not connected, calls will be made using OnStar® Hands-Free Calling, if available. See *OnStar Overview on page 14-1* for more information.

Pairing Information

- A Bluetooth phone with MP3 capability cannot be paired to the vehicle as a phone and an MP3 player at the same time.

- Up to five cell phones can be paired to the Bluetooth system.
- The pairing process is disabled when the vehicle is moving.
- Pairing only needs to be completed once, unless the pairing information on the cell phone changes or the cell phone is deleted from the system.
- Only one paired cell phone can be connected to the Bluetooth system at a time.
- If multiple paired cell phones are within range of the system, the system connects to the first available paired cell phone in the order that they were first paired to the system. To link to a different paired phone, see "Connecting to a Different Phone" later in this section.

Pairing a Phone



1. Press and hold  /  for two seconds.

2. Say "Bluetooth." This command can be skipped.
3. Say "Pair." The system responds with instructions and a four-digit PIN number. The PIN number is used in Step 5.
4. Start the pairing process on the cell phone that you want to pair. For help with this process, see your cell phone manufacturers user guide.
5. Locate the device named "Your Vehicle" in the list on the cell phone. Follow the instructions on the cell phone to enter the PIN that was provided in Step 3. After the PIN is successfully entered, the system prompts you to provide a name for the paired cell phone. This name will be used to indicate which phones are paired and connected to the vehicle. The system responds with "<phone name> has been successfully paired" after the pairing process is complete.

6. Repeat Steps 1 through 5 to pair additional phones.



Listing All Paired and Connected Phones

The system can list all cell phones paired to it. If a paired cell phone is also connected to the vehicle, the system responds with "is connected" after that phone name.

1. Press and hold  /  for two seconds.
2. Say "Bluetooth."
3. Say "List."

Deleting a Paired Phone



If the phone name you want to delete is unknown, see "Listing All Paired and Connected Phones."

1. Press and hold  /  for two seconds.
2. Say "Bluetooth."
3. Say "Delete." The system asks for which phone to delete.

4. Say the name of the phone you want to delete.

Connecting to a Different Phone

To connect to a different cell phone, the Bluetooth system looks for the next available cell phone in the order in which all the available cell phones were paired. Depending on which cell phone you want to connect to, you may have to use this command several times.

1. Press and hold  /  for two seconds.
2. Say "Bluetooth."
3. Say "Change phone."
 - If another cell phone is found, the response will be "<Phone name> is now connected."
 - If another cell phone is not found, the original phone remains connected.

Storing and Deleting Phone Numbers

The system can store up to 30 phone numbers as name tags in the Hands Free Directory that is shared between the Bluetooth and OnStar systems.

The following commands are used delete and store phone numbers.



Store: This command will store a phone number, or a group of numbers as a name tag.

Digit Store: This command allows a phone number to be stored as a name tag by entering the digits one at a time.

Delete: This command is used to delete individual name tags.

Delete All Name Tags: This command deletes all stored name tags in the Hands Free Calling Directory and the OnStar Turn-by-Turn Destinations Directory.



Using the “Store” Command

1. Press and hold  /  for two seconds.
2. Say “Store.”
3. Say the phone number or group of numbers you want to store all at once with no pauses, then follow the directions given by the system to save a name tag for this number.

Using the “Digit Store” Command



If an unwanted number is recognized by the system, say “Clear” at any time to clear the last number.

To hear all of the numbers recognized by the system, say “Verify” at any time.

1. Press and hold  /  for two seconds.
2. Say “Digit Store.”
3. Say each digit, one at a time, that you want to store. After each digit is entered, the system

repeats back the digit it heard followed by a tone. After the last digit has been entered, say “Store,” and then follow the directions given by the system to save a name tag for this number.



Using the “Delete” Command

1. Press and hold  /  for two seconds.
2. Say “Delete.”
3. Say the name tag you want to delete.

Using the “Delete All Name Tags” Command

This command deletes all stored name tags in the Hands-Free Calling Directory and the OnStar Turn-by-Turn Destinations Directory, if equipped.



To delete all name tags:

1. Press and hold  /  for two seconds.
2. Say “Delete all name tags.”

Listing Stored Numbers

The list command will list all the stored numbers and name tags.

Using the “List” Command

1. Press and hold  /  for two seconds.
2. Say “Directory.”
3. Say “Hands Free Calling.”
4. Say “List.”

Making a Call



Calls can be made using the following commands.

Dial or Call: The dial or call command can be used interchangeably to dial a phone number or a stored name tag.

Digit Dial: This command allows a phone number to be dialed by entering the digits one at a time.

Re-dial: This command is used to dial the last number used on the cell phone.

Using the “Dial” or “Call” Command

1. Press and hold  /  for two seconds.
2. Say “Dial” or “Call.”
3. Say the entire number without pausing or say the name tag.



Once connected, the person called will be heard through the audio speakers.

Using the “Digit Dial” Command

The digit dial command allows a phone number to be dialed by entering the digits one at a time. After each digit is entered, the system repeats back the digit it heard followed by a tone.



If an unwanted number is recognized by the system, say “Clear” at any time to clear the last number.

To hear all of the numbers recognized by the system, say “Verify” at any time.

1. Press and hold  /  for two seconds.
2. Say “Digit Dial.”
3. Say each digit, one at a time, that you want to dial. After each digit is entered, the system repeats back the digit it heard followed by a tone. After the last digit has been entered, say “Dial.”

Once connected, the person called will be heard through the audio speakers.





Using the “Re-dial” Command

1. Press and hold  /  for two seconds.
2. After the tone, say “Re-dial.”

Once connected, the person called will be heard through the audio speakers.







Receiving a Call

When an incoming call is received, the audio system mutes and a ring tone is heard in the vehicle.

- Press  /  to answer the call.
- Press  /  to ignore a call.





Call Waiting

Call waiting must be supported on the cell phone and enabled by the wireless service carrier.

- Press  /  to answer an incoming call when another call is active. The original call is placed on hold.
- Press  /  again to return to the original call.
- To ignore the incoming call, no action is required.
- Press  /  to disconnect the current call and switch to the call on hold.

Three-Way Calling

Three-way calling must be supported on the cell phone and enabled by the wireless service carrier.



1. While on a call, press  / .
2. Say “Three-way call.”
3. Use the dial or call command to dial the number of the third party to be called.
4. Once the call is connected, press  /  to link all the callers together.



Ending a Call

Press  /  to end a call.

Muting a Call

During a call, all sounds from inside the vehicle can be muted so that the person on the other end of the call cannot hear them.

To mute a call, press  / , and then say “Mute Call.”

To cancel mute, press  / , and then say “Un-mute Call.”



Transferring a Call

Audio can be transferred between the Bluetooth system and the cell phone.



The cell phone must be paired and connected with the Bluetooth system before a call can be transferred. The connection process can take up to two minutes after the ignition is turned to ON/RUN.

Transferring Audio from the Bluetooth System to a Cell Phone

To transfer a call with the audio in the vehicle:

1. Press  / .
2. Say “Transfer Call.”



Transferring Audio to the Bluetooth System from a Cell Phone

During a call with the audio on the cell phone, press  / . The audio transfers to the vehicle. If the audio does not transfer to the vehicle, use the audio transfer feature on the cell phone. See your cell phone manufacturers user guide for more information.

Voice Pass-Thru

Voice pass-thru allows access to the voice recognition commands on the cell phone. See your cell phone manufacturers user guide to see if the cell phone supports this feature.

To access contacts stored in the cell phone:

1. Press and hold  /  for two seconds.
2. Say "Bluetooth." This command can be skipped.



3. Say "Voice." The system responds "OK, accessing <phone name>."

The cell phone's normal prompt messages will go through its cycle according to the phone's operating instructions.

Dual Tone Multi-Frequency (DTMF) Tones

The Bluetooth system can send numbers and the numbers stored as name tags during a call. You can use this feature when calling a menu driven phone system. Account numbers can also be stored for use.

Sending a Number or Name Tag During a Call

1. Press  / . The system responds "Ready," followed by a tone.
2. Say "Dial."
3. Say the number or name tag to send.

Clearing the System

Unless information is deleted out of the in-vehicle Bluetooth system, it will be retained indefinitely. This includes all saved name tags in the phone book and phone pairing information. For information on how to delete this information, see the previous sections on Deleting a Paired Phone and Deleting Name Tags.

Other Information

The Bluetooth[®] word mark and logos are owned by the Bluetooth[®] SIG, Inc. and any use of such marks by General Motors is under license. Other trademarks and trade names are those of their respective owners.

See *Radio Frequency Statement on page 13-20* for information regarding Part 15 of the Federal Communications Commission (FCC) rules and Industry Canada Standards RSS-GEN/210/220/310.

Climate Controls

Climate Control Systems

Climate Control Systems	8-1
Automatic Climate Control System	8-5

Air Vents

Air Vents	8-9
-----------------	-----

Climate Control Systems

The heating, cooling and ventilation for the vehicle can be controlled with this system.

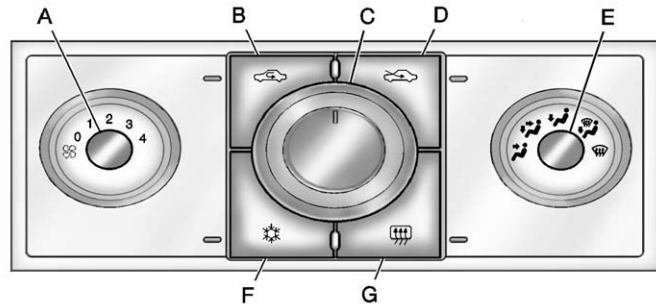

- A. Fan Control
- B. Recirculation
- C. Temperature Control
- D. Outside Air

- E. Air Delivery Mode Control
- F. Air Conditioning
- G. Rear Window Defogger

8-2 Climate Controls

Operation

Temperature Control: Turn clockwise or counterclockwise to increase or decrease the temperature inside the vehicle.

When it is cold outside -18°C (0°F) or lower, use the engine coolant heater, if vehicle has one, to provide warmer air faster to the vehicle. An engine coolant heater warms the coolant the engine uses that provides heat to warm the inside of the vehicle. For more information, see *Engine Heater on page 9-18*.

 **(Fan Control):** Turn clockwise or counterclockwise to increase or decrease the fan speed. The fan must be on to run the air-conditioning compressor.

Air Delivery Mode Control: Turn clockwise or counterclockwise to change the current airflow mode.

Select from the following:

 **(Vent):** Air is directed to the instrument panel outlets.

 **(Bi-Level):** Air is divided between the instrument panel and floor outlets. Some air will be directed toward the side windows.

 **(Floor):** Air is directed to the floor outlets with some air directed to the windshield and side window outlets.

 **(Defog):** This mode clears the windows of fog or moisture. Air is directed to the windshield and floor outlets, with some air directed to the side windows. When this mode is selected, the system automatically turns off recirculation and runs the air-conditioning compressor unless the outside temperature is at or below freezing. The air-conditioning compressor operates although the indicator light is not on. The air-conditioning indicator light turns off when defog is selected. If the

air-conditioning button is pressed while in defog mode, the indicator light will turn on. If the button is pressed again, the light will turn off. The recirculation mode cannot be selected while in the defog mode. Do not drive the vehicle until all the windows are clear.

 **(Defrost):** This mode quickly clears the windshield of fog or frost. Air is directed to the windshield with some air directed to the floor vents. In this mode, outside air is pulled into the vehicle. The air-conditioning compressor will not run unless the outside temperature is at or below freezing. The air-conditioning compressor operates although the indicator light is not on. The air-conditioning indicator light turns off when defrost is selected. If the air-conditioning button is pressed while in defrost mode, the indicator light turns on. If the button is pressed again, the light turns off. Recirculation cannot be selected while in the defrost mode.

To help clear the windshield quickly, do the following:

1. Select .
2. Select the highest temperature.
3. Select the highest fan speed.



 **(Air Conditioning):** Press to turn the air conditioning system on or off. An indicator light comes on to show it is on.

The air-conditioning system removes moisture from the air, so a small amount of water might drip under the vehicle while it is idling or after the engine is turned off is normal.

Maximum Air Conditioning

On hot days, open the windows to let hot inside air escape; then close them. This helps reduce the time it takes for the vehicle to cool down. It also helps the air conditioning system operate more efficiently.

For quick cool down on hot days, do the following:

1. Select the  vent mode.
2. Select the highest fan speed.
3. Select  air conditioning.
4. Select the  recirculation mode.
5. Select the coolest temperature.

Using these settings together for long periods of time can cause the air inside of the vehicle to become too dry. To prevent this from happening, after the air in the vehicle has cooled, turn the recirculation mode off.

 **(Outside Air):** Press to turn the outside air mode on. An indicator light comes on to show that it is on. Air from outside the vehicle will circulate throughout the vehicle. The outside air mode can be used with all modes, but it

cannot be used with the recirculation mode. Press  to cancel the recirculation mode.

 **(Recirculation):** Press to turn the recirculation mode on. An indicator light comes on to show that it is on. This mode recirculates and helps to quickly cool the air inside the vehicle. It can be used to prevent outside air and odors from entering the vehicle. The recirculation indicator light blinks three times if you try to use recirculation in a mode in which it cannot function.

Pressing this button cancels the outside air mode. When switching to the defog or defrost modes the system automatically moves from recirculation to outside air. When the vehicle or fan is turned off and back on, the system defaults to outside air automatically. Only use recirculation mode when it is needed for comfort, since window fogging can occur.

8-4 Climate Controls

To improve fuel efficiency and to cool the vehicle faster, recirculation may be automatically selected in warm weather. The recirculation light will not come on. To override this feature, select outside air.

Rear Window Defogger

The rear window defogger uses a warming grid to remove fog or frost from the rear window.

 **REAR:** Press to turn the rear window defogger on or off. An indicator light comes on to show that the rear window defogger is on. Be sure to clear as much snow from the rear window as possible.

If driving below 80 km/h (50 mph), the rear window defogger turns off about 15 minutes after the button is pressed. If turned on again, the defogger only runs for about seven minutes before turning off. The defogger can also be turned off by turning off the engine.

If the vehicle's speed is maintained above 80 km/h (50 mph), the rear window defogger remains on once the button is pressed.

If the vehicle has heated outside mirrors, the surface of the outside mirrors heat when the rear window defogger is activated. See *Heated Mirrors* on page 2-14.

Notice: Do not use anything sharp on the inside of the rear window. If you do, you could cut or damage the warming grid, and the repairs would not be covered by the vehicle warranty. Do not attach a temporary vehicle license, tape, a decal, or anything similar to the defogger grid.

Remote Start Climate Control Operation

For vehicles with the remote start feature, when it is activated the climate control system heats or cools the inside of the vehicle using the modes that were set before the vehicle was turned off. The climate control knobs will remain active during a remote start. However, the climate control buttons will be inactive until the ignition is turned on by the key. If the fan is off, the climate control system will not operate during remote start. See *Remote Keyless Entry (RKE) System Operation* on page 2-3.

Automatic Climate Control System

For vehicles with this system, the heating, cooling, and ventilation can be automatically controlled.

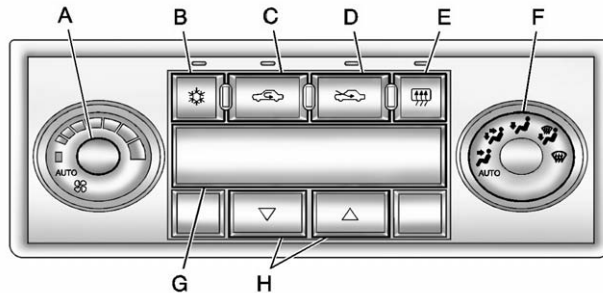

- A. Fan Control
- B. Air Conditioning
- C. Recirculation
- D. Outside Air

- E. Rear Window Defogger
- F. Air Delivery Mode Control
- G. Display
- H. Temperature Control

Automatic Operation

AUTO (Automatic): Select AUTO on both the fan speed control and the air delivery mode control knobs to activate the automatic system. When automatic operation is active the system controls the inside temperature and air delivery.



To place the system in automatic mode do the following:

1. Turn the fan knob and the mode knob to the AUTO position.

The current set temperature displays. When AUTO is selected, the air conditioning operation and air inlet is automatically controlled. The air conditioning compressor runs while the outside temperature is over about 40°F (4°C). The air inlet will normally be set to outside air. If it is hot outside, the air inlet may automatically switch to recirculate inside air to help quickly cool down the vehicle.

8-6 Climate Controls

2. Set the temperature.

An initial setting of 73°F (23°C) is recommended. Allow about 20 minutes for the system to regulate. Press  or  to adjust the temperature setting as necessary. If the temperature is set at 60°F (15°C) the system remains at the maximum cooling setting. If the temperature is set at 90°F (32°C) the system remains at the maximum heat setting. Choosing either maximum setting does not cause the vehicle to heat or cool any faster.

Do not to cover the sensor located on the top of the instrument panel near the windshield. This sensor regulates air temperature based on the intensity of the sun.



Also do not cover the sensor grille on the lower right side of the climate control faceplate, as this regulates the inside temperature.

To avoid blowing cold air at engine start-up in cold weather, the system delays turning on the fan until warm air is available.

The length of delay depends on the engine coolant temperature. Turning the fan knob overrides this delay and changes the fan to the selected speed.

Manual Operation

 **(Off):** Select this position on the fan knob to turn off the entire climate control system. Outside air still enters the vehicle. The airflow direction and temperature can be adjusted.

 /  **Temperature Control:** Press the arrows to increase or decrease the temperature inside the vehicle.

 **(Fan Control):** Turn clockwise or counterclockwise to increase or decrease the fan speed.

Air Delivery Mode Control: Turn clockwise or counterclockwise to change the direction of the airflow in the vehicle.

Select from the following:

 **(Vent):** Air is directed to the instrument panel outlets.

 **(Bi-Level):** Air is divided between the instrument panel outlets and the floor outlets.

 **(Floor):** Air is directed to the floor outlets with some air directed to the side window outlets.

 **(Defog):** This mode clears the windows of fog or moisture. Air is directed to the floor and windshield outlets.

 **(Defrost):** This mode clears the windows of fog or frost more quickly. The system automatically controls the fan speed if defrost is selected from the AUTO mode. If the outside temperature is 4°C (40°F) or warmer, the air conditioning compressor automatically runs to help dehumidify the air and dry the

windshield. The air conditioning indicator light blinks three times if the compressor is turned off while in this mode.

 **(Air Conditioning):** Press turn the air conditioning on and off. An indicator light turns on to show the air conditioning is on.

When air conditioning is selected or is in AUTO mode, the system runs the air conditioning automatically to cool and dehumidify the air entering the vehicle.

On hot days, open the windows long enough to let hot inside air escape. This reduces the time it takes for the vehicle to cool down. Then keep the windows closed for the air conditioner to work its best.

On cool, but sunny days while using manual operation of the automatic system, use bi-level to deliver warm air to the floor and cooler air to the instrument panel outlets. To warm or cool the air delivered, press the temperature buttons to the desired setting.

In AUTO mode the system cools and dehumidifies the air inside the vehicle. Also while in AUTO mode, the system maximizes its performance by using recirculation as necessary.

Heating: On cold days when using manual operation of the automatic system, use floor mode to deliver air to the floor outlets. To warm or cool the air delivered, press ∇ or \triangle to the desired temperature setting.

To use the automatic mode, turn the knob to AUTO and press ∇ or \triangle to adjust the temperature.

 **(Outside Air):** Press to turn the outside air mode on. An indicator light comes on to show it is on. Air from outside the vehicle will circulate throughout the vehicle. The outside air mode can be used with all modes, but it cannot be used with the recirculation mode. Pressing this button cancels the recirculation mode.

 **(Recirculation):** Press to turn the recirculation mode on. An indicator light above the button comes on to show it is on. This mode recirculates and helps to quickly cool the air inside the vehicle. It can be used to help prevent outside air and odors from entering the vehicle. The recirculation indicator light blinks three times if you try to use recirculation in a mode in which it cannot function.

Pressing this button cancels the auto recirculation feature. Each time the vehicle is started, the system reverts to the auto recirculation function.

The recirculation mode cannot be used with the floor, defrost, or defog modes. If recirculation is selected in these modes, the indicator flashes three times and turns off to indicate that this is not allowed. This is to prevent window fogging.

8-8 Climate Controls

When the weather is cool or damp, operating the system in recirculation for extended periods of time can cause fogging of the vehicle's windows. To clear the fog, select either defog or defrost. Make sure the air conditioning is on. Allow the air conditioning to run automatically to help dehumidify the air.

To improve fuel efficiency and to cool the vehicle faster, recirculation may be automatically selected in warm weather. The recirculation light will not come on. To override this feature, select outside air.

Rear Window Defogger

The rear window defogger uses a warming grid to remove fog from the rear window.

 **(Rear):** Press to turn the rear window defogger on or off. An indicator light comes on to show that the rear window defogger is on.

If driving below 80 km/h (50 mph), the rear window defogger turns off about 15 minutes after the button is pressed. If additional warming time is needed, press the button again.

If the vehicle's speed is maintained above 80 km/h (50 mph), the rear window defogger remains on once the button is pressed.

For vehicles with heated outside mirrors, the surface of the outside mirrors will also heat when the rear window defogger is activated. See *Heated Mirrors on page 2-14*.

Notice: Do not use a razor blade or sharp object to clear the inside rear window. Do not adhere anything to the defogger grid lines in the rear glass. These actions may damage the rear defogger. Repairs would not be covered by your warranty.

Remote Start Climate Control Operation

For vehicles with remote start, when it is activated the climate control system heats and cools the inside of the vehicle using the previous system settings before the vehicle was turned off. The climate control knobs will remain active during a remote start. However, the climate control buttons will be inactive until the ignition is turned on by the key. If the fan is off, the climate control system will not operate during remote start.

With the automatic climate control system, the climate control displays "RS" in place of the temperature to indicate that remote start is activated. For best performance, turn both the fan and mode knobs to AUTO. If the temperature is cold enough and the mode knob is set to AUTO, the system begins in defrost to clear the windows. See *Remote Keyless Entry (RKE) System Operation on page 2-3*.

Air Vents

Use the lever located in the center of each outlet by moving it either up and down or side-to-side, to change the direction and amount of airflow in the vehicle.

Operation Tips

- Clear away any ice, snow, or leaves from the air inlets at the base of the windshield that may block the flow of air into the vehicle.
 - Do not use non-GM approved hood deflectors as they could adversely affect the performance of the system.
- Keep the path under the front seats clear of objects to help circulate the air inside of the vehicle more effectively.
 - When an objectionable odor outside the vehicle is encountered, use the recirculation mode, with the temperature knob at a comfortable setting to prevent the odor from entering the vehicle through the ventilation system. This can be helpful when driving through a long tunnel with poor ventilation. However, extended usage of this mode in cold or cool weather can cause window fogging.

Driving and Operating

Driving Information

Distracted Driving	9-2
Defensive Driving	9-2
Drunk Driving	9-3
Control of a Vehicle	9-3
Braking	9-3
Steering	9-3
Off-Road Recovery	9-5
Loss of Control	9-5
Driving on Wet Roads	9-6
Highway Hypnosis	9-7
Hill and Mountain Roads	9-7
Winter Driving	9-8
If the Vehicle Is Stuck	9-9
Vehicle Load Limits	9-10

Starting and Operating

New Vehicle Break-In	9-14
Ignition Positions	9-15
Starting the Engine	9-17
Engine Heater	9-18
Retained Accessory Power (RAP)	9-18

Shifting Into Park	9-19
Shifting out of Park	9-20
Parking over Things That Burn	9-20

Engine Exhaust

Engine Exhaust	9-21
Running the Vehicle While Parked	9-21

Automatic Transmission

Automatic Transmission	9-22
Manual Mode	9-23

Brakes

Antilock Brake System (ABS)	9-25
Parking Brake	9-26
Brake Assist	9-26

Ride Control Systems

Traction Control System (TCS)	9-27
Electronic Stability Control (ESC)	9-29

Cruise Control

Cruise Control	9-31
----------------------	------

Fuel

Fuel	9-33
Recommended Fuel	9-34
Gasoline Specifications (U.S. and Canada Only)	9-34
California Fuel Requirements	9-34
Fuels in Foreign Countries ...	9-35
Fuel Additives	9-35
Fuel E85 (85% Ethanol)	9-36
Filling the Tank	9-37
Filling a Portable Fuel Container	9-38

Towing

General Towing Information	9-39
Driving Characteristics and Towing Tips	9-39
Trailer Towing	9-42
Towing Equipment	9-44

Conversions and Add-Ons

Add-On Electrical Equipment	9-45
--------------------------------------	------

Driving Information

Distracted Driving

Distraction comes in many forms and can take your focus from the task of driving. Exercise good judgment and do not let other activities divert your attention away from the road. Many local governments have enacted laws regarding driver distraction. Become familiar with the local laws in your area.

To avoid distracted driving, always keep your eyes on the road, hands on the wheel, and mind on the drive.

- Do not use a phone in demanding driving situations. Use a hands-free method to place or receive necessary phone calls.
- Watch the road. Do not read, take notes, or look up information on phones or other electronic devices.

- Designate a front seat passenger to handle potential distractions.
- Become familiar with vehicle features before driving, such as programming favorite radio stations and adjusting climate control and seat settings. Program all trip information into any navigation device prior to driving.
- Wait until the vehicle is parked to retrieve items that have fallen to the floor.
- Stop or park the vehicle to tend to children.
- Keep pets in an appropriate carrier or restraint.
- Avoid stressful conversations while driving, whether with a passenger or on a cell phone.

WARNING

Taking your eyes off the road too long or too often could cause a crash resulting in injury or death. Focus your attention on driving.

Refer to the Infotainment section for more information on using that system, including pairing and using a cell phone.

Defensive Driving

Defensive driving means “always expect the unexpected.” The first step in driving defensively is to wear the safety belt. See *Safety Belts on page 3-8*.

- Assume that other road users (pedestrians, bicyclists, and other drivers) are going to be careless and make mistakes. Anticipate what they might do and be ready.

- Allow enough following distance between you and the driver in front of you.
- Focus on the task of driving.

Drunk Driving

Death and injury associated with drinking and driving is a global tragedy.

 **WARNING**

Drinking and then driving is very dangerous. Your reflexes, perceptions, attentiveness, and judgment can be affected by even a small amount of alcohol. You can have a serious— or even fatal— collision if you drive after drinking.

Do not drink and drive or ride with a driver who has been drinking. Ride home in a cab; or if you are with a group, designate a driver who will not drink.

Control of a Vehicle

Braking, steering, and accelerating are important factors in helping to control a vehicle while driving.

Braking

Braking action involves perception time and reaction time. Deciding to push the brake pedal is perception time. Actually doing it is reaction time.

Average driver reaction time is about three-quarters of a second. In that time, a vehicle moving at 100 km/h (60 mph) travels 20 m (66 ft), which could be a lot of distance in an emergency.

Helpful braking tips to keep in mind include:

- Keep enough distance between you and the vehicle in front of you.
- Avoid needless heavy braking.
- Keep pace with traffic.

If the engine ever stops while the vehicle is being driven, brake normally but do not pump the brakes. Doing so could make the pedal harder to push down. If the engine stops, there will be some power brake assist but it will be used when the brake is applied. Once the power assist is used up, it can take longer to stop and the brake pedal will be harder to push.

Steering

Electric Power Steering

If your vehicle has electric power steering it does not have power steering fluid. Regular maintenance is not required.

If power steering assist is lost due to a system malfunction, the vehicle can be steered, but may require increased effort.

9-4 Driving and Operating

If the steering wheel is turned in either direction several times until it stops, or it is held until it is stopped for an extended time, power steering assist should return shortly after a few normal steering movements.

See specific vehicle steering messages under *Vehicle Messages* on page 5-25.

See your dealer if there is a problem.

Variable Effort Steering

Some vehicles have a steering system that varies the amount of effort required to steer the vehicle in relation to the speed of the vehicle.

The amount of steering effort required is less at slower speeds to make the vehicle more maneuverable and easier to park.

At faster speeds, the steering effort increases to provide a sport-like feel to the steering. This provides maximum control and stability.

If the vehicle seems harder to steer than normal when parking or driving slowly, there may be a problem with the system. You will still have power steering, but steering will be stiffer than normal at slow speeds. See your dealer for service.

Hydraulic Power Steering

If your vehicle has hydraulic power steering, it may require maintenance. See *Power Steering Fluid* on page 10-19.

If power steering assist is lost because the engine stops or the power steering system is not functioning, the vehicle can be steered but may require increased effort. See your dealer if there is a problem.

Curve Tips

- Take curves at a reasonable speed.
- Reduce speed before entering a curve.
- Maintain a reasonable steady speed through the curve
- Wait until the vehicle is out of the curve before accelerating gently into the straightaway.

Steering in Emergencies

- There are some situations when steering around a problem may be more effective than braking.
- Holding both sides of the steering wheel allows you to turn 180 degrees without removing a hand.
- Antilock Brake System (ABS) allows steering while braking.

Off-Road Recovery

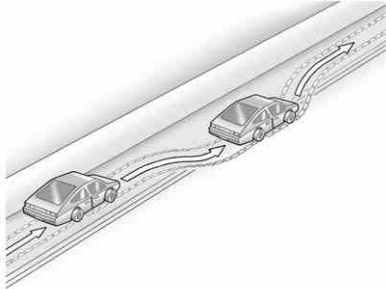

The vehicle's right wheels can drop off the edge of a road onto the shoulder while driving. Follow these tips:

1. Ease off the accelerator and then, if there is nothing in the way, steer the vehicle so that it straddles the edge of the pavement.

2. Turn the steering wheel about one-eighth of a turn, until the right front tire contacts the pavement edge.
3. Then turn the steering wheel to go straight down the roadway.

Loss of Control

Skidding

There are three types of skids that correspond to the vehicle's three control systems:

- Braking Skid — wheels are not rolling.
- Steering or Cornering Skid — too much speed or steering in a curve causes tires to slip and lose cornering force.
- Acceleration Skid — too much throttle causes the driving wheels to spin.

Defensive drivers avoid most skids by taking reasonable care suited to existing conditions, and by not overdriving those conditions. But skids are always possible.

If the vehicle starts to slide, follow these suggestions:

- Ease your foot off the accelerator pedal and quickly steer the way you want the vehicle to go. The vehicle may straighten out. Be ready for a second skid if it occurs.
- Slow down and adjust your driving according to weather conditions. Stopping distance can be longer and vehicle control can be affected when traction is reduced by water, snow, ice, gravel, or other material on the road. Learn to recognize warning clues — such as enough water, ice, or packed snow on the road to make a mirrored surface — and slow down when you have any doubt.

9-6 Driving and Operating

- Try to avoid sudden steering, acceleration, or braking, including reducing vehicle speed by shifting to a lower gear. Any sudden changes could cause the tires to slide.

Remember: Antilock brakes help avoid only the braking skid.

Driving on Wet Roads

Rain and wet roads can reduce vehicle traction and affect your ability to stop and accelerate. Always drive slower in these types of driving conditions and avoid driving through large puddles and deep-standing or flowing water.

WARNING

Wet brakes can cause crashes. They might not work as well in a quick stop and could cause pulling to one side. You could lose control of the vehicle.

After driving through a large puddle of water or a car/vehicle wash, lightly apply the brake pedal until the brakes work normally.

Flowing or rushing water creates strong forces. Driving through flowing water could cause the vehicle to be carried away. If this happens, you and other vehicle occupants could drown. Do not ignore police warnings and be very cautious about trying to drive through flowing water.

Hydroplaning

Hydroplaning is dangerous. Water can build up under the vehicle's tires so they actually ride on the water. This can happen if the road is wet enough and you are going fast enough. When the vehicle is hydroplaning, it has little or no contact with the road.

There is no hard and fast rule about hydroplaning. The best advice is to slow down when the road is wet.

Other Rainy Weather Tips

Besides slowing down, other wet weather driving tips include:

- Allow extra following distance.
- Pass with caution.
- Keep windshield wiping equipment in good shape.

- Keep the windshield washer fluid reservoir filled.
- Have good tires with proper tread depth. See *Tires on page 10-38*.
- Turn off cruise control.

Highway Hypnosis

Always be alert and pay attention to your surroundings while driving. If you become tired or sleepy, find a safe place to park the vehicle and rest.

Other driving tips include:

- Keep the vehicle well ventilated.
- Keep the interior temperature cool.
- Keep your eyes moving — scan the road ahead and to the sides.
- Check the rearview mirror and vehicle instruments often.

Hill and Mountain Roads

Driving on steep hills or through mountains is different than driving on flat or rolling terrain. Tips for driving in these conditions include:

- Keep the vehicle serviced and in good shape.
- Check all fluid levels and brakes, tires, cooling system, and transmission.
- Shift to a lower gear when going down steep or long hills.

WARNING

If you do not shift down, the brakes could get so hot that they would not work well. You would then have poor braking or even none going down a hill. You could crash. Shift down to let the engine assist the brakes on a steep downhill slope.

WARNING

Coasting downhill in N (Neutral) or with the ignition off is dangerous. The brakes will have to do all the work of slowing down and they could get so hot that they would not work well. You would then have poor braking or even none going down a hill. You could crash. Always have the engine running and the vehicle in gear when going downhill.

- Stay in your own lane. Do not swing wide or cut across the center of the road. Drive at speeds that let you stay in your own lane.
- Be alert on top of hills; something could be in your lane (stalled car, accident).

9-8 Driving and Operating

- Pay attention to special road signs (falling rocks area, winding roads, long grades, passing or no-passing zones) and take appropriate action.

Winter Driving

Driving on Snow or Ice

Drive carefully when there is snow or ice between the tires and the road, creating less traction or grip. Wet ice can occur at about 0°C (32°F) when freezing rain begins to fall, resulting in even less traction. Avoid driving on wet ice or in freezing rain until roads can be treated with salt or sand.

Drive with caution, whatever the condition. Accelerate gently so traction is not lost. Accelerating too quickly causes the wheels to spin and makes the surface under the tires slick, so there is even less traction.

Try not to break the fragile traction. If you accelerate too fast, the drive wheels will spin and polish the surface under the tires even more.

The *Antilock Brake System (ABS)* on page 9-25 improves vehicle stability during hard stops on slippery roads, but apply the brakes sooner than when on dry pavement.

Allow greater following distance on any slippery road and watch for slippery spots. Icy patches can occur on otherwise clear roads in shaded areas. The surface of a curve or an overpass can remain icy when the surrounding roads are clear. Avoid sudden steering maneuvers and braking while on ice.

Turn off cruise control on slippery surfaces.

Blizzard Conditions

Being stuck in snow can be a serious situation. Stay with the vehicle unless there is help nearby. If possible, use the *Roadside Assistance Program (U.S. and Canada)* on page 13-7 or *Roadside Assistance Program (Mexico)* on page 13-9. To get help and keep everyone in the vehicle safe:

- Turn on the hazard warning flashers.
- Tie a red cloth to an outside mirror.

⚠ WARNING

Snow can trap engine exhaust under the vehicle. This may cause exhaust gases to get inside. Engine exhaust contains carbon monoxide (CO) which cannot be seen or smelled. It can cause unconsciousness and even death.

If the vehicle is stuck in the snow:

- Clear away snow from around the base of your vehicle, especially any that is blocking the exhaust pipe.
- Check again from time to time to be sure snow does not collect there.
- Open a window about 5 cm (2 in) on the side of the vehicle that is away from the wind to bring in fresh air.

(Continued)

WARNING (Continued)

- Fully open the air outlets on or under the instrument panel.
- Adjust the climate control system to a setting that circulates the air inside the vehicle and set the fan speed to the highest setting. See “Climate Control Systems” in the Index.

For more information about carbon monoxide, see *Engine Exhaust* on page 9-21.

Run the engine for short periods only as needed to keep warm, but be careful.

To save fuel, run the engine for only short periods as needed to warm the vehicle and then shut the engine off and close the window most of the way to save heat. Repeat this until help arrives but only when you

feel really uncomfortable from the cold. Moving about to keep warm also helps.

If it takes some time for help to arrive, now and then when you run the engine, push the accelerator pedal slightly so the engine runs faster than the idle speed. This keeps the battery charged to restart the vehicle and to signal for help with the headlamps. Do this as little as possible to save fuel.

If the Vehicle Is Stuck

Slowly and cautiously spin the wheels to free the vehicle when stuck in sand, mud, ice, or snow.

If the vehicle has a traction system, it can often help to free a stuck vehicle. Refer to the vehicle's traction system in the Index. If stuck too severely for the traction system to free the vehicle, turn the traction system off and use the rocking method.

WARNING

If the vehicle's tires spin at high speed, they can explode, and you or others could be injured. The vehicle can overheat, causing an engine compartment fire or other damage. Spin the wheels as little as possible and avoid going above 55 km/h (35 mph).

For information about using tire chains on the vehicle, see *Tire Chains* on page 10-58.

Rocking the Vehicle to Get It Out

Turn the steering wheel left and right to clear the area around the front wheels. Turn off any traction or stability system. Shift back and forth between R (Reverse) and a forward gear, spinning the wheels as little as possible. To prevent transmission wear, wait until the wheels stop spinning before shifting gears.

Release the accelerator pedal while shifting, and press lightly on the accelerator pedal when the transmission is in gear. Slowly spinning the wheels in the forward and reverse directions causes a rocking motion that could free the vehicle. If that does not get the vehicle out after a few tries, it might need to be towed out. If the vehicle does need to be towed out, see *Towing the Vehicle* on page 10-79.

Vehicle Load Limits

It is very important to know how much weight the vehicle can carry. This weight is called the vehicle capacity weight and includes the weight of all occupants, cargo and all nonfactory-installed options. Two labels on the vehicle show how much weight it may properly carry, the Tire and Loading Information label and the Certification label.

WARNING

Do not load the vehicle any heavier than the Gross Vehicle Weight Rating (GVWR), or either the maximum front or rear Gross Axle Weight Rating (GAWR). This can cause systems to break and change the way the vehicle handles. This could cause loss of control and a crash. Overloading can also shorten the life of the vehicle.

Tire and Loading Information Label

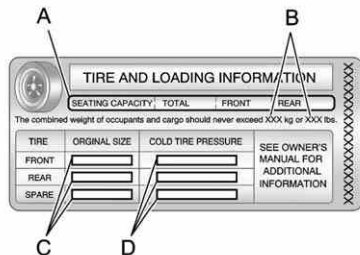

Label Example

A vehicle-specific Tire and Loading Information label is attached to the vehicle's center pillar (B-pillar). With the driver's door open, you will find the label attached below the door lock post. The Tire and Loading Information label shows the number of occupant seating

positions (A), and the maximum vehicle capacity weight (B) in kilograms and pounds.

The Tire and Loading Information label also shows the tire size of the original equipment tires (C) and the recommended cold tire inflation pressures (D). For more information on tires and inflation see *Tires* on page 10-38 and *Tire Pressure* on page 10-45.

There is also important loading information on the Certification label. It tells you the Gross Vehicle Weight Rating (GVWR) and the Gross Axle Weight Rating (GAWR) for the front and rear axle. See "Certification Label" later in this section.

Steps for Determining Correct Load Limit

1. Locate the statement "The combined weight of occupants and cargo should never exceed XXX kg or XXX lbs" on your vehicle's placard.
2. Determine the combined weight of the driver and passengers that will be riding in your vehicle.
3. Subtract the combined weight of the driver and passengers from XXX kg or XXX lbs.
4. The resulting figure equals the available amount of cargo and luggage load capacity. For example, if the "XXX" amount equals 1400 lbs and there will be five 150 lb passengers in your vehicle,

9-12 Driving and Operating

the amount of available cargo and luggage load capacity is 650 lbs (1400 – 750 (5 x 150) = 650 lbs).

- Determine the combined weight of luggage and cargo being loaded on the vehicle. That weight may not safely exceed the available cargo and luggage load capacity calculated in Step 4.
- If your vehicle will be towing a trailer, the load from your trailer will be transferred to your vehicle. Consult this manual to determine how this reduces the available cargo and luggage load capacity of your vehicle.

See *Trailer Towing on page 9-42* for important information on towing a trailer, towing safety rules, and trailering tips.

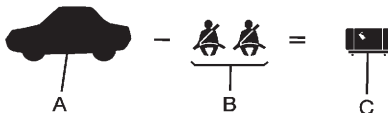

Example 1

- Vehicle Capacity Weight for Example 1 = 453 kg (1,000 lbs).
- Subtract Occupant Weight @ 68 kg (150 lbs) × 2 = 136 kg (300 lbs).
- Available Occupant and Cargo Weight = 317 kg (700 lbs).

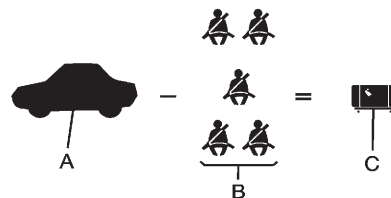

Example 2

- Vehicle Capacity Weight for Example 2 = 453 kg (1,000 lbs).
- Subtract Occupant Weight @ 68 kg (150 lbs) × 5 = 340 kg (750 lbs).
- Available Cargo Weight = 113 kg (250 lbs).

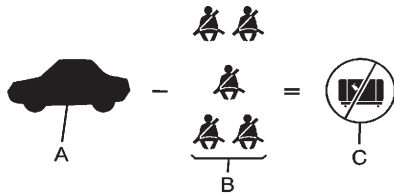

Example 3

- A. Vehicle Capacity Weight for Example 3 = 453 kg (1,000 lbs).
- B. Subtract Occupant Weight @ 91 kg (200 lbs) × 5 = 453 kg (1,000 lbs).
- C. Available Cargo Weight = 0 kg (0 lbs).

Refer to the vehicle's Tire and Loading Information label for specific information about the vehicle's capacity weight and

seating positions. The combined weight of the driver, passengers, and cargo should never exceed the vehicle's capacity weight.

Certification Label

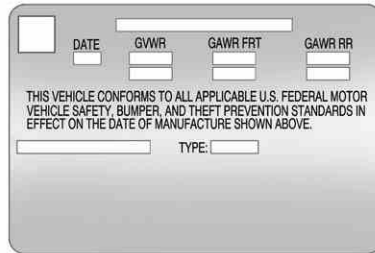

Label Example

A vehicle-specific Certification label is attached to the driver side center pillar (B-pillar). The label tells the gross weight capacity of the vehicle, called the Gross Vehicle Weight Rating (GVWR). The GVWR includes the weight of the vehicle, all

occupants, fuel, and cargo. Never exceed the GVWR for the vehicle, or the Gross Axle Weight Rating (GAWR) for either the front or rear axle.

And, if there is a heavy load, it should be spread out. See "Steps for Determining Correct Load Limit" earlier in this section.

WARNING

Do not load the vehicle any heavier than the Gross Vehicle Weight Rating (GVWR), or either the maximum front or rear Gross Axle Weight Rating (GAWR). This can cause systems to break and change the way the vehicle handles. This could cause loss of control and a crash. Overloading can also shorten the life of the vehicle.

If you put things inside the vehicle — like suitcases, tools, packages, or anything else — they will go as fast as the vehicle goes. If you have to stop or turn quickly, or if there is a crash, they will keep going.

 **WARNING**

Things inside the vehicle can strike and injure people in a sudden stop or turn, or in a crash.

- Put things in the cargo area of the vehicle. In the cargo area, put them as far forward as possible. Try to spread the weight evenly.

(Continued)

WARNING (Continued)

- Never stack heavier things, like suitcases, inside the vehicle so that some of them are above the tops of the seats.
- Do not leave an unsecured child restraint in the vehicle.
- Secure loose items in the vehicle.
- Do not leave a seat folded down unless needed.

Starting and Operating

New Vehicle Break-In

Notice: The vehicle does not need an elaborate break-in. But it will perform better in the long run if you follow these guidelines:

- Do not drive at any one constant speed, fast or slow, for the first 805 km (500 miles). Do not make full-throttle starts. Avoid downshifting to brake or slow the vehicle.

- Avoid making hard stops for the first 322 km (200 miles) or so. During this time the new brake linings are not yet broken in. Hard stops with new linings can mean premature wear and earlier replacement. Follow this breaking-in guideline every time you get new brake linings.
- Do not tow a trailer during break-in. See *Trailer Towing on page 9-42* for the trailer towing capabilities of the vehicle and more information.

Following break-in, engine speed and load can be gradually increased.

Ignition Positions



The ignition switch has four different positions.

To shift out of P (Park), the ignition must be in ON/RUN or ACC/ACCESSORY and the brake pedal must be applied.

Notice: Using a tool to force the key to turn in the ignition could cause damage to the switch or break the key. Use the correct key, make sure it is all the way in, and turn it only with your hand. If the key cannot be turned by hand, see your dealer.

○ (STOPPING THE ENGINE/ LOCK/OFF): When the vehicle is stopped, turn the ignition switch to LOCK/OFF to turn the engine off. Retained Accessory Power (RAP) will remain active. See *Retained Accessory Power (RAP) on page 9-18*.

This position locks the ignition. It also locks the transmission. The key can only be removed in LOCK/OFF.

Do not turn the engine off when the vehicle is moving. This will cause a loss of power assist in the brake and steering systems and disable the airbags.

9-16 Driving and Operating

If the vehicle must be shut off in an emergency:

1. Brake using a firm and steady pressure. Do not pump the brakes repeatedly. This may deplete power assist, requiring increased brake pedal force.
2. Shift the vehicle to N (Neutral). This can be done while the vehicle is moving. After shifting to N (Neutral), firmly apply the brakes and steer the vehicle to a safe location.
3. Come to a complete stop, shift to P (Park), and turn the ignition to LOCK/OFF. On vehicles with an automatic transmission, the shift lever must be in P (Park) to turn the ignition switch to the LOCK/OFF position.
4. Set the parking brake. See *Parking Brake on page 9-26*.

WARNING

Turning off the vehicle while moving may cause loss of power assist in the brake and steering systems and disable the airbags. While driving, only shut the vehicle off in an emergency.

If the vehicle cannot be pulled over, and must be shut off while driving, turn the ignition to ACC/ACCESSORY.

The steering can bind with the wheels turned off center. If this happens, move the steering wheel from right to left while turning the key to ACC/ACCESSORY. If this doesn't work, the vehicle needs service.

ACC (ACC/ACCESSORY): This position lets you use things like the radio and windshield wipers while the engine is not running.

(ON/RUN): This position can be used to operate the electrical accessories and to display some instrument panel warning lights. The switch will stay in this position while the engine is running. This position can also be used for service and diagnostics, and to verify the proper operation of the malfunction indicator lamp as may be required for emission inspection purposes.

If you leave the key in the ACC/ACCESSORY or ON/RUN position with the engine off, the battery could be drained. You may not be able to start the vehicle if the battery is allowed to drain for an extended period of time.

(START): This position starts the engine. When the engine starts, release the key. The ignition switch will return to the ON/RUN position for driving.

A warning tone will sound when the driver door is opened, the ignition is in ACC/ACCESSORY or LOCK/OFF and the key is in the ignition.

Starting the Engine

Move the shift lever to P (Park) or N (Neutral). The engine will not start in any other position. To restart the engine when the vehicle is already moving, use N (Neutral) only.

Notice: Do not try to shift to P (Park) if the vehicle is moving. If you do, you could damage the transmission. Shift to P (Park) only when the vehicle is stopped.

Starting Procedure

1. With your foot off the accelerator pedal, turn the ignition to START. When the engine starts, let go of the key. The idle speed will slow down as the engine warms. Do not race the engine immediately after starting it. Operate the engine and transmission gently to allow the oil to warm up and lubricate all moving parts.

The vehicle has a Computer-Controlled Cranking System. This feature assists in starting the engine and protects

components. If the ignition key is turned to the START position, and then released when the engine begins cranking, the engine will continue cranking for a few seconds or until the vehicle starts. If the engine does not start and the key is held in START, cranking will be stopped after 15 seconds to prevent cranking motor damage. To prevent gear damage, this system also prevents cranking if the engine is already running. Engine cranking can be stopped by turning the ignition switch to the ACC/ACCESSORY or LOCK/OFF position.

Notice: Cranking the engine for long periods of time, by returning the key to the START position immediately after cranking has ended, can overheat and damage the cranking motor, and drain the battery. Wait at least 15 seconds between each try, to let the cranking motor cool down.

2. If the engine does not start after 5 to 10 seconds, especially in very cold weather (below -18°C or 0°F), it could be flooded with too much gasoline. Try pushing the accelerator pedal all the way to the floor and holding it there as you hold the key in START for up to a maximum of 15 seconds. Wait at least 15 seconds between each try, to allow the cranking motor to cool down. When the engine starts, let go of the key and accelerator. If the vehicle starts briefly but then stops again, repeat these steps. This clears the extra gasoline from the engine. Do not race the engine immediately after starting it. Operate the engine and transmission gently until the oil warms up and lubricates all moving parts.

Notice: The engine is designed to work with the electronics in the vehicle. If you add electrical parts or accessories, you could change the way the engine operates.

Before adding electrical equipment, check with your dealer. If you do not, the engine might not perform properly. Any resulting damage would not be covered by the vehicle warranty.

Engine Heater

The engine coolant heater can provide easier starting and better fuel economy during engine warm-up in cold weather conditions at or below -18°C (0°F). Vehicles with an engine coolant heater should be plugged in at least four hours before starting the vehicle. An internal thermostat in the plug-end of the cord may exist which will prevent engine coolant heater operation at temperatures above -18°C (0°F).

To Use the Engine Coolant Heater

1. Turn off the engine.
2. Open the hood and unwrap the electrical cord. With a 4 cylinder engine, the engine coolant

heater cord is located near the air cleaner box on the passenger side of the engine compartment. With a V6 engine, the engine coolant heater cord is located on the driver side around the battery box. See *Engine Compartment Overview* on page 10-5 for more information on location.

WARNING

Plugging the cord into an ungrounded outlet could cause an electrical shock. Also, the wrong kind of extension cord could overheat and cause a fire. You could be seriously injured. Plug the cord into a properly grounded three-prong 110-volt AC outlet. If the cord will not reach, use a heavy-duty three-prong extension cord rated for at least 15 amps.

3. Plug the cord into a normal, grounded 110-volt AC outlet.

4. Before starting the engine, be sure to unplug and store the cord as it was before to keep it away from moving engine parts and prevent damage.

The length of time the heater should remain plugged in depends on several factors. Ask a dealer in the area where you will be parking the vehicle for the best advice on this.

Retained Accessory Power (RAP)

These vehicle accessories can be used for up to 10 minutes after the engine is turned off:

- Audio System
- Power Windows
- Heated Seats (if equipped)
- Sunroof (if equipped)

These features continue to work up to 10 minutes after the ignition is turned to LOCK/OFF.

The power windows, heated seats, and sunroof will work until any door is opened.

The radio continues to work until the driver door is opened.

All these features operate when the key is in the ON/RUN or ACC/ACCESSORY.

Shifting Into Park

WARNING

It can be dangerous to get out of the vehicle if the shift lever is not fully in P (Park) with the parking brake firmly set. The vehicle can roll. If you have left the engine running, the vehicle can move suddenly. You or others could be injured. To be sure the vehicle will not move, even when you are on fairly level ground, use the steps that follow. If you are pulling a trailer, see *Driving Characteristics and Towing Tips on page 9-39*.

1. Hold the brake pedal down and set the parking brake. See *Parking Brake on page 9-26* for more information.
2. Move the shift lever into P (Park) by holding in the button on the shift lever and pushing the shift lever all the way toward the front of the vehicle.
3. Turn the ignition key to LOCK/OFF.
4. Remove the key and take it with you. If you can leave the vehicle with the ignition key in your hand, the vehicle is in P (Park).

Leaving the Vehicle with the Engine Running

WARNING

It can be dangerous to leave the vehicle with the engine running. The vehicle could move suddenly if the shift lever is not fully in P (Park) with the parking brake

(Continued)

WARNING (Continued)

firmly set. And, if you leave the vehicle with the engine running, it could overheat and even catch fire. You or others could be injured. Do not leave the vehicle with the engine running.

If you have to leave the vehicle with the engine running, be sure the vehicle is in P (Park) and the parking brake is firmly set before you leave it. After you have moved the shift lever into P (Park), hold the regular brake pedal down. Then, see if you can move the shift lever away from P (Park) without first pushing the button.

If you can, it means that the shift lever was not fully locked in P (Park).

Torque Lock

Torque lock is when the weight of the vehicle puts too much force on the parking pawl in the transmission. This happens when parking on a hill and shifting the transmission into P (Park) is not done properly and then it is difficult to shift out of P (Park). To prevent torque lock, set the parking brake and then shift into P (Park). To find out how, see “Shifting Into Park” listed previously.

If torque lock does occur, your vehicle may need to be pushed uphill by another vehicle to relieve the parking pawl pressure, so you can shift out of P (Park).

Shifting out of Park

This vehicle is equipped with an electronic shift lock release system. The shift lock release is designed to:

- Prevent ignition key removal unless the shift lever is in P (Park) with the shift lever button fully released.
- Prevent movement of the shift lever out of P (Park), unless the ignition is in ON/RUN or ACC/ACCESSORY and the brake pedal is applied.

The shift lock release is always functional except in the case of an uncharged or low voltage (less than 9 volt) battery.

If the vehicle has an uncharged battery or a battery with low voltage, try charging or jump starting the battery. See *Jump Starting on page 10-76*

To shift out of P (Park):

1. Apply the brake pedal.

2. Press the shift lever button.
3. Move the shift lever to the desired position.

If still unable to shift out of P (Park):

1. Fully release the shift lever button.
2. Hold the brake pedal down and press the shift lever button again.
3. Move the shift lever to the desired position.

If you are still having a problem shifting, see your dealer.

Parking over Things That Burn



Things that can burn could touch hot exhaust parts under the vehicle and ignite. Do not park over papers, leaves, dry grass, or other things that can burn.

Engine Exhaust

WARNING

Engine exhaust contains carbon monoxide (CO) which cannot be seen or smelled. Exposure to CO can cause unconsciousness and even death.

Exhaust may enter the vehicle if:

- The vehicle idles in areas with poor ventilation (parking garages, tunnels, deep snow that may block underbody airflow or tail pipes).
- The exhaust smells or sounds strange or different.
- The exhaust system leaks due to corrosion or damage.
- The vehicle exhaust system has been modified, damaged or improperly repaired.

(Continued)

WARNING (Continued)

- There are holes or openings in the vehicle body from damage or aftermarket modifications that are not completely sealed.

If unusual fumes are detected or if it is suspected that exhaust is coming into the vehicle:

- Drive it only with the windows completely down.
- Have the vehicle repaired immediately.

Never park the vehicle with the engine running in an enclosed area such as a garage or a building that has no fresh air ventilation.

Running the Vehicle While Parked

It is better not to park with the engine running. But if you ever have to, here are some things to know.

WARNING

Idling a vehicle in an enclosed area with poor ventilation is dangerous. Engine exhaust may enter the vehicle. Engine exhaust contains Carbon Monoxide (CO) which cannot be seen or smelled. It can cause unconsciousness and even death. Never run the engine in an enclosed area that has no fresh air ventilation. For more information, see *Engine Exhaust* on page 9-21.

WARNING

It can be dangerous to get out of the vehicle if the automatic transmission shift lever is not fully in P (Park) with the parking brake firmly set. The vehicle can roll. Do not leave the vehicle when the engine is running unless you have to. If you have left the engine running, the vehicle can move suddenly. You or others could be injured. To be sure the vehicle will not move, even when you are on fairly level ground, always set the parking brake and move the shift lever to P (Park).

Follow the proper steps to be sure the vehicle will not move. See *Shifting Into Park* on page 9-19.

If parking on a hill and pulling a trailer, see *Driving Characteristics and Towing Tips* on page 9-39.

Automatic Transmission

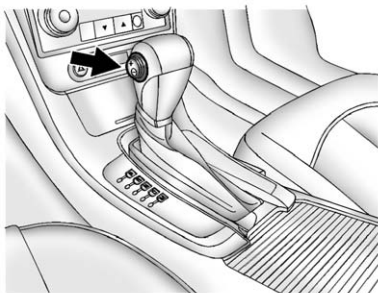

The automatic transmission has a shift lever located on the console between the seats.

P (Park): This position locks the front wheels. It is the best position to use when you start the engine because the vehicle cannot move easily.

WARNING

It is dangerous to get out of the vehicle if the shift lever is not fully in P (Park) with the parking brake firmly set. The vehicle can roll.

Do not leave the vehicle when the engine is running unless you have to. If you have left the engine running, the vehicle can move suddenly. You or others could be injured. To be sure the vehicle will not move, even when you are on fairly level ground, always set the parking brake and move the shift lever to P (Park). See *Shifting Into Park* on page 9-19. If you are pulling a trailer, see *Trailer Towing* on page 9-42.

Make sure the shift lever is fully in P (Park) before starting the engine. The vehicle has an automatic transmission shift lock control

system. You must fully apply the brake pedal then press the shift lever button before you can shift from P (Park) while the ignition key is in ON/RUN. If you cannot shift out of P (Park), ease pressure on the shift lever and push the shift lever all the way into P (Park) as you maintain brake application. Then move the shift lever into another gear. See *Shifting out of Park on page 9-20*.

R (Reverse): Use this gear to back up.

Notice: Shifting to R (Reverse) while the vehicle is moving forward could damage the transmission. The repairs would not be covered by the vehicle warranty. Shift to R (Reverse) only after the vehicle is stopped.

To rock the vehicle back and forth to get out of snow, ice, or sand without damaging the transmission, see *If the Vehicle Is Stuck on page 9-9*.

N (Neutral): In this position, the engine does not connect with the wheels. To restart the engine when the vehicle is already moving, use N (Neutral) only. Also, use N (Neutral) when the vehicle is being towed.

WARNING

Shifting into a drive gear while the engine is running at high speed is dangerous. Unless your foot is firmly on the brake pedal, the vehicle could move very rapidly. You could lose control and hit people or objects. Do not shift into a drive gear while the engine is running at high speed.

Notice: Shifting out of P (Park) or N (Neutral) with the engine running at high speed may damage the transmission. The repairs would not be covered by the vehicle warranty. Be sure the engine is not running at high speed when shifting the vehicle.

D (Drive): This position is for normal driving. It provides the best fuel economy. If you need more power for passing, and you are:

- Going less than 56 km/h (35 mph), push the accelerator pedal about halfway down.
- Going about 56 km/h (35 mph) or more, push the accelerator all the way down.

M (Manual Mode): This position, allows you to change gears similar to a manual transmission. If the vehicle has this feature, see Driver Shift Control (DSC).

Manual Mode

Driver Shift Control (DSC)

To use this feature, do the following:

1. Move the shift lever from D (Drive) rearward to M (Manual).

9-24 Driving and Operating

While driving in manual mode, the transmission will remain in the driver selected gear. When coming to a stop in the manual position, the vehicle will automatically shift into 2 (Second) gear.

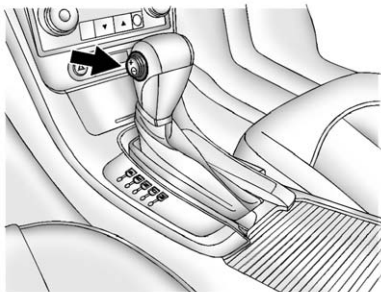

2. Press the + (plus) end of the button on the side of the shifter to upshift, or push the - (minus) end of the button to downshift.

The Driver Information Center (DIC) in the instrument cluster will change from the currently displayed message to the letter “M,” for Manual position, and a number indicating the requested gear.

While using the DSC feature the transmission will have firmer shifting and sportier performance. You can use this for sport driving or when climbing hills to stay in gear longer or to downshift for more power or engine braking.

The transmission will only allow you to shift into gears appropriate for the vehicle speed and engine revolutions per minute (rpm):

- The transmission will not automatically shift to the next higher gear if the vehicle speed or engine rpm is too low.
- The transmission will not allow shifting to the next lower gear if the vehicle speed or engine rpm is too high.

Second or Third Gear Start Feature

When accelerating the vehicle from a stop in snowy and icy conditions, you may want to shift into 2 (Second) or 3 (Third) gear. A higher gear allows you to gain more traction on slippery surfaces.

With the DSC feature, the vehicle can be set to pull away in Second or Third gear.

1. Move the shift lever from D (Drive) into the M (Manual Mode).
2. With the vehicle stopped, press (+) end of the button to select 2 (Second) or 3 (Third) gear. The vehicle will start from a stop position in 2 (Second) or 3 (Third) gear.
3. Once moving select the desired drive gear.

Brakes

Antilock Brake System (ABS)

This vehicle has the Antilock Brake System (ABS), an advanced electronic braking system that helps prevent a braking skid.

When the engine is started and the vehicle begins to drive away, ABS checks itself. A momentary motor or clicking noise might be heard while this test is going on, and it might even be noticed that the brake pedal moves a little. This is normal.



If there is a problem with ABS, this warning light stays on. See *Antilock Brake System (ABS) Warning Light* on page 5-17.

If driving safely on a wet road and it becomes necessary to slam on the brakes and continue braking to avoid a sudden obstacle, a computer senses that the wheels are slowing down. If one of the wheels is about to stop rolling, the computer will separately work the brakes at each wheel.

ABS can change the brake pressure to each wheel, as required, faster than any driver could. This can help the driver steer around the obstacle while braking hard.

As the brakes are applied, the computer keeps receiving updates on wheel speed and controls braking pressure accordingly.

Remember: ABS does not change the time needed to get a foot up to the brake pedal or always decrease stopping distance. If you get too close to the vehicle in front of you,

there will not be enough time to apply the brakes if that vehicle suddenly slows or stops. Always leave enough room up ahead to stop, even with ABS.

Using ABS

Do not pump the brakes. Just hold the brake pedal down firmly and let ABS work. You might hear the ABS pump or motor operating and feel the brake pedal pulsate, but this is normal.

Braking in Emergencies

ABS allows the driver to steer and brake at the same time. In many emergencies, steering can help more than even the very best braking.

Parking Brake

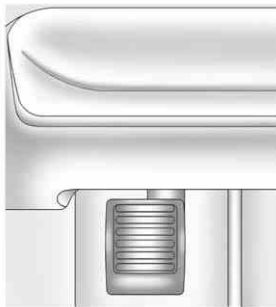

To set the parking brake, push down the parking brake pedal with your left foot. If the ignition is on, the brake system warning light will come on. See *Brake System Warning Light* on page 5-17.

To release the parking brake, hold the regular brake pedal down with your right foot. Push down momentarily on the parking brake pedal with your left foot until you

feel the pedal release. If the parking brake is not released when you begin to drive, the brake system warning light comes on and a chime sounds as a warning that the parking brake is still on.

The PUSH PARK PEDAL message will also display in the Driver Information Center (DIC) as a reminder to release the parking brake. See *Brake System Messages* on page 5-25.

Notice: Driving with the parking brake on can overheat the brake system and cause premature wear or damage to brake system parts. Make sure that the parking brake is fully released and the brake warning light is off before driving.

If you are towing a trailer and are parking on a hill, see *Driving Characteristics and Towing Tips* on page 9-39.

Brake Assist

This vehicle has a brake assist feature designed to assist the driver in stopping or decreasing vehicle speed in emergency driving conditions. This feature uses the stability system hydraulic brake control module to supplement the power brake system under conditions where the driver has quickly and forcefully applied the brake pedal in an attempt to quickly stop or slow down the vehicle. The stability system hydraulic brake control module increases brake pressure at each corner of the vehicle until the ABS activates. Minor brake pedal pulsation or pedal movement during this time is normal and the driver should continue to apply the brake pedal as the driving situation dictates. The brake assist feature will automatically disengage when the brake pedal is released or brake pedal pressure is quickly decreased.

Ride Control Systems

Traction Control System (TCS)

The vehicle may have a Traction Control System (TCS) that limits wheel spin. This is especially useful in slippery road conditions. The system operates only if it senses that the front wheels are spinning too much or are beginning to lose traction. When this happens, the system works the front brakes and reduces engine power by closing the throttle and managing engine spark to limit wheel spin.



This light will flash when the traction control system is limiting wheel spin.

The system may be heard or felt while it is working, but this is normal.

If the vehicle is in cruise control when TCS begins to limit wheel spin, the cruise control will automatically disengage. The cruise control may be re-engaged when road conditions allow. See *Cruise Control* on page 9-31.



When this light is on solid and either the SERVICE TRACTION or TRACTION OFF message is displayed, the system will not limit wheel spin.

Adjust your driving accordingly. See *Ride Control System Messages* on page 5-26 for more information.

The Traction Control System is automatically enabled whenever the vehicle is started. To limit wheel spin, especially in slippery road conditions, always leave the system enabled. TCS can be turned off if needed.

It is recommended to leave the system on for normal driving conditions, but it may be necessary to turn the system off if the vehicle is stuck in sand, mud, ice or snow, and you want to “rock” the vehicle to attempt to free it. It may also be necessary to turn off the system when driving in extreme off-road conditions where high wheel spin is required. See *If the Vehicle Is Stuck* on page 9-9.



To turn the system off or on, press and release this button located on the center console.



The traction off light comes on and the DIC will display the appropriate message as described previously when the button is pressed.

Traction Control Operation

Traction control limits wheel spin by reducing engine power to the wheels (engine speed management) and by applying brakes to each individual wheel (brake-traction control) as necessary.

The traction control system is enabled automatically when the vehicle is started, and it will activate and flash the ESC/TCS light and display the LOW TRACTION message if it senses either of the front wheels are spinning or beginning to lose traction while driving. For more information on the LOW TRACTION message, see *Ride Control System Messages on page 5-26*.

Notice: If the wheel(s) of one axle are allowed to spin excessively while the ESC/TCS, ABS and Brake warning lights and the SERVICE ESC and/or SERVICE TRACTION messages are displayed, the differential could be damaged. The repairs would not be covered by the vehicle warranty. Reduce engine power and do not spin the wheel(s) excessively while these lights and this message are displayed.

Notice: When traction control is turned off, it is possible to lose traction. If you attempt to shift

with the front wheels spinning with a loss of traction, it is possible to cause damage to the transmission. Do not attempt to shift when the front wheels do not have traction. Damage caused by misuse of the vehicle is not covered. See your warranty book for additional information.

The traction control system may activate on dry or rough roads or under conditions such as heavy acceleration while turning or abrupt upshifts/downshifts of the transmission. When this happens, a reduction in acceleration may be noticed, or a noise or vibration may be heard. This is normal.

If the vehicle is in cruise control when the system activates, the ESC/TCS light will flash and the cruise control will automatically disengage. The cruise control may be re-engaged when road conditions allow. See *Cruise Control on page 9-31*.

Adding non-dealer accessories can affect the vehicle's performance. See *Accessories and Modifications on page 10-3* for more information.

Electronic Stability Control (ESC)

The vehicle has an Electronic Stability Control (ESC) system which combines antilock brake, traction and stability control systems and helps the driver maintain directional control of the vehicle in most driving conditions.

When you first start the vehicle and begin to drive away, the system performs several diagnostic checks to ensure there are no problems. The system may be heard or felt while it is working. This is normal and does not mean there is a problem with the vehicle. The system should initialize before the vehicle reaches 32 km/h (20 mph).

If the system fails to turn on or activate, the ESC/TCS light will be on solid, and the ESC OFF or SERVICE ESC message will be displayed.

For more information, see *Ride Control System Messages on page 5-26*.



This light will flash on the instrument panel cluster when the ESC system is both on and activated.

The system may be heard or felt while it is working; this is normal.

When the light is on solid and either the SERVICE ESC or ESC OFF message is displayed, the system will not assist the driver in maintaining directional control of the vehicle. Adjust your driving accordingly. See *Ride Control System Messages on page 5-26*.

The Electronic Stability Control (ESC) system is automatically enabled whenever the vehicle is started. To assist the driver with vehicle directional control, especially in slippery road conditions, the system should always be left on. But, ESC can be turned off if needed.

9-30 Driving and Operating

If the vehicle is in cruise control when the system begins to assist the driver maintain directional control of the vehicle, the ESC/TCS light will flash and the cruise control will automatically disengage. The cruise control system may be re-engaged when road conditions allow. See *Cruise Control* on page 9-31.



The ESC/TCS button is located on the instrument panel.

The traction control system can be turned off or back on by pressing the ESC/TCS button. To disable both traction control and ESC, press and hold the button briefly.



When the ESC system is turned off, the traction off light and the ESC off light will be on to warn the driver that both traction control and ESC are disabled. The TRACTION OFF and ESC OFF messages will appear on the DIC,

It is recommended to leave the system on for normal driving conditions, but it may be necessary to turn the system off if the vehicle is stuck in sand, mud, ice or snow, and you want to “rock” the vehicle to attempt to free it. It may also be necessary to turn off the system when driving in extreme off-road conditions where high wheel spin is required. See *If the Vehicle Is Stuck* on page 9-9.

ESC may also turn off automatically if it determines that a problem exists with the system. The ESC OFF and SERVICE ESC messages and the ESC/TCS light will be on solid to warn the driver that ESC is disabled and requires service. If the problem does not clear after restarting the vehicle, see your dealer for service. See *Ride Control System Messages* on page 5-26 for more information.

Adding non-dealer accessories can affect the vehicle's performance. See *Accessories and Modifications* on page 10-3 for more information.

Cruise Control

Cruise control lets a speed of about 40 km/h (25 mph) or more be maintained without keeping your foot on the accelerator. This can really help on long trips. Cruise control does not work at speeds below 40 km/h (25 mph).

When the brakes are applied, the cruise control shuts off.

If the vehicle is in cruise control and the Traction Control System (TCS) or Enhanced Traction System (ETS) begins to limit wheel spin, the cruise control automatically disengages. See *Traction Control System (TCS)* on page 9-27 and *Electronic Stability Control (ESC)* on page 9-29. When road conditions allow, the cruise control can be used again.

⚠ WARNING

Cruise control can be dangerous where you cannot drive safely at a steady speed. So, do not use the cruise control on winding roads or in heavy traffic.

Cruise control can be dangerous on slippery roads. On such roads, fast changes in tire traction can cause excessive wheel slip, and you could lose control. Do not use cruise control on slippery roads.

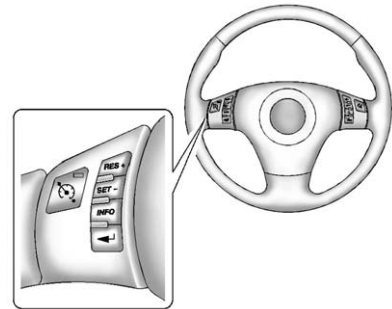

The cruise control buttons are located on the steering wheel.

(On/Off): Press to turn the cruise control system on and off.

RES+ (Resume): Press briefly to make the vehicle resume a previously set speed or press and hold to accelerate.

SET- (Set): Press to set the speed and activate cruise control or make the vehicle decelerate.

9-32 Driving and Operating

Setting Cruise Control

If the cruise button is on when not in use, it could get bumped and go into cruise when not desired. Keep the cruise control switch off when cruise is not being used.

1. Press  to turn cruise control on. The indicator light on the button comes on.
2. Get up to the desired speed.
3. Press the SET- and release it. The cruise symbol displays in the instrument panel cluster to show the system is engaged.
4. Take your foot off the accelerator pedal.

Resuming a Set Speed

If the cruise control is set at a desired speed and then the brakes are applied, the cruise control is disengaged without erasing the set speed from memory. The cruise symbol in the instrument panel cluster also goes out indicating cruise is no longer engaged. Once the vehicle speed is 40 km/h (25 mph) or greater, press the RES+ button on the steering wheel. The vehicle returns to the previously set speed and stays there.

Increasing Speed While Using Cruise Control

If the cruise control system is already activated,

- Press and hold the RES+ button on the steering wheel until the desired speed is reached, then release it.

- To increase the vehicle speed in small amounts, press the RES+ button briefly. Each time this is done, the vehicle goes about 1.6 km/h (1 mph) faster.

Reducing Speed While Using Cruise Control

If the cruise control system is already activated,

- Press and hold the SET- on the steering wheel until the lower speed desired is reached, then release it.
- To slow down in small amounts, press the SET- button briefly. Each time this is done, the vehicle goes about 1.6 km/h (1 mph) slower.

Passing Another Vehicle While Using Cruise Control

Use the accelerator pedal to increase the vehicle speed. When you take your foot off the pedal, the vehicle will slow down to the previously set cruise control speed.

Using Cruise Control on Hills

How well the cruise control works on hills depends upon the vehicle speed, load, and the steepness of the hills. When going up steep hills, you might have to step on the accelerator pedal to maintain the vehicle speed. When going downhill, you might have to brake or shift to a lower gear to keep the vehicle at a lower speed. When the brakes are applied this ends the cruise control.

Ending Cruise Control

There are two ways to end cruise control:

- To disengage the cruise control, step lightly on the brake pedal.
- To turn off cruise control, press the  button.

Erasing Speed Memory

The cruise control set speed is erased from memory, by pressing the  button or if the ignition is turned off.

Fuel

Use of the recommended fuel is an important part of the proper maintenance of this vehicle. To help keep the engine clean and maintain optimum vehicle performance, we recommend the use of gasoline advertised as TOP TIER Detergent Gasoline.

Look for the TOP TIER label on the fuel pump to ensure gasoline meets enhanced detergency standards developed by auto companies. A list of marketers providing TOP TIER Detergent Gasoline can be found at www.toptiergas.com.



The eighth digit of the Vehicle Identification Number (VIN) shows the code letter or number that identifies the vehicle's engine. The VIN is at the top left of the instrument panel. See *Vehicle Identification Number (VIN) on page 12-1*.

Vehicles that have a FlexFuel badge and a yellow fuel cap can use either unleaded gasoline or ethanol fuel containing up to 85% ethanol (E85).

9-34 Driving and Operating

See *Fuel E85 (85% Ethanol)* on page 9-36. For all other vehicles, use only the unleaded gasoline described under *Recommended Fuel* on page 9-34.

Recommended Fuel

If the vehicle has the 2.4L L4 engine (VIN Code 1) or the 2.4L L4 engine (VIN Code U), use regular unleaded gasoline with a posted octane rating of 87 or higher. If the octane rating is less than 87, an audible knocking noise, commonly referred to as spark knock, might be heard when driving. If this occurs, use a gasoline rated at 87 octane or higher as soon as possible. If heavy knocking is heard when using gasoline rated at 87 octane or higher, the engine needs service.

If the vehicle has the 3.6L V6 engine (VIN Code 7), use regular unleaded gasoline with a posted octane rating of 87 or higher. For best performance or trailer towing, you

could choose to use middle grade 89 octane unleaded gasoline. If the octane rating is less than 87, an audible knocking noise, commonly referred to as spark knock, might be heard when driving. If this occurs, use a gasoline rated at 87 octane or higher as soon as possible. If heavy knocking is heard when using gasoline rated at 87 octane or higher, the engine needs service.

Gasoline Specifications (U.S. and Canada Only)

At a minimum, gasoline should meet ASTM specification D 4814 in the United States or CAN/CGSB-3.5 or 3.511 in Canada. Some gasolines contain an octane-enhancing additive called methylcyclopentadienyl manganese tricarbonyl (MMT). We recommend against the use of gasolines containing MMT. See *Fuel Additives* on page 9-35 for additional information.

California Fuel Requirements

If the vehicle is certified to meet California Emissions Standards, it is designed to operate on fuels that meet California specifications. See the underhood emission control label. If this fuel is not available in states adopting California Emissions Standards, the vehicle will operate satisfactorily on fuels meeting federal specifications, but emission control system performance might be affected. The malfunction indicator lamp could turn on and the vehicle might fail a smog-check test. See *Malfunction Indicator Lamp* on page 5-14. If this occurs, return to your authorized dealer for diagnosis. If it is determined that the condition is caused by the type of fuel used, repairs might not be covered by the vehicle warranty.

Fuels in Foreign Countries

Never use leaded gasoline or any other fuel not recommended in the previous text on fuel. Costly repairs caused by use of improper fuel would not be covered by the vehicle warranty.

To check the fuel availability, ask an auto club, or contact a major oil company that does business in the country where you will be driving.

Fuel Additives

To provide cleaner air, all gasolines in the United States are now required to contain additives that help prevent engine and fuel system deposits from forming, allowing the emission control system to work properly. In most cases, nothing should have to be added to the fuel. However, some gasolines contain only the minimum amount of additive required to meet U.S. Environmental Protection Agency

regulations. To help keep fuel injectors and intake valves clean and avoid problems due to dirty injectors or valves, look for gasoline that is advertised as TOP TIER Detergent Gasoline. Look for the TOP TIER label on the fuel pump to ensure gasoline meets enhanced detergency standards developed by the auto companies. A list of marketers providing TOP TIER Detergent Gasoline can be found at www.toptiergas.com.

For customers who do not use TOP TIER Detergent Gasoline regularly, one bottle of GM Fuel System Treatment PLUS, added to the fuel tank at every engine oil change, can help clean deposits from fuel injectors and intake valves. GM Fuel System Treatment PLUS is the only gasoline additive recommended by General Motors. It is available at your dealer.

Gasolines containing oxygenates, such as ethers and ethanol, and reformulated gasolines might be available in your area.

We recommend that you use these gasolines, if they comply with the specifications described earlier. However, E85 (85% ethanol) and other fuels containing more than 15% ethanol must not be used in vehicles that were not designed for those fuels.

Notice: This vehicle was not designed for fuel that contains methanol. Do not use fuel containing methanol. It can corrode metal parts in the fuel system and also damage plastic and rubber parts. That damage would not be covered under the vehicle warranty.

Some gasolines that are not reformulated for low emissions can contain an octane-enhancing additive called methylcyclopentadienyl manganese tricarbonyl (MMT); ask the attendant where you buy gasoline whether the fuel contains MMT. We recommend against the use of such gasolines.

Fuels containing MMT can reduce spark plug life and affect emission control system performance. The malfunction indicator lamp might turn on. If this occurs, return to your dealer for service.

Fuel E85 (85% Ethanol)

Vehicles that have a FlexFuel badge and a yellow fuel cap can use either unleaded gasoline or ethanol fuel containing up to 85% ethanol (E85). For all other vehicles, use only the unleaded gasoline described under *Recommended Fuel on page 9-34*.

We encourage the use of E85 in vehicles that are designed to use it. The ethanol in E85 is a “renewable” fuel, meaning it is made from renewable sources such as corn and other crops.

Many service stations will not have an 85% ethanol fuel (E85) pump available. The U.S. Department of Energy has an alternative fuels

website (www.afdc.energy.gov/afdc/locator/stations/) that can help you find E85 fuel. Those stations that do have E85 should have a label indicating ethanol content. Do not use the fuel if the ethanol content is greater than 85%.

At a minimum, E85 should meet ASTM Specification D 5798 or CGSB Specification 3.512. Filling the tank with fuel mixtures that do not meet ASTM or CGSB specifications can affect driveability and could cause the malfunction indicator lamp to come on. As the outside temperature approaches freezing, ethanol fuel distributors should supply winter grade ethanol, the same as with unleaded gasoline.

It is best not to alternate repeatedly between gasoline and E85. If you do switch fuels, it is recommended that you add as much fuel as possible — do not add less than 11 L (3 gal) when refueling. You should drive the vehicle immediately

after refueling for at least 11 km (7 mi) to allow the vehicle to adapt to the change in ethanol concentration.

E85 has less energy per liter (gallon) than gasoline, so you will need to refill the fuel tank more often when using E85 than when you are using gasoline. See *Filling the Tank on page 9-37*.

Notice: Some additives are not compatible with E85 fuel and can harm the vehicle's fuel system. Do not add anything to E85. Damage caused by additives would not be covered by the vehicle warranty.

Notice: This vehicle was not designed for fuel that contains methanol. Do not use fuel containing methanol. It can corrode metal parts in the fuel system and also damage plastic and rubber parts. That damage would not be covered under the vehicle warranty.

Filling the Tank

WARNING

Fuel vapor burns violently and a fuel fire can cause bad injuries. To help avoid injuries to you and others, read and follow all the instructions on the fuel pump island. Turn off the engine when refueling. Do not smoke near fuel or when refueling the vehicle. Do not use cellular phones. Keep sparks, flames, and smoking materials away from fuel. Do not leave the fuel pump unattended when refueling the vehicle. This is against the law in some places. Do not re-enter the vehicle while pumping fuel. Keep children away from the fuel pump; never let children pump fuel.

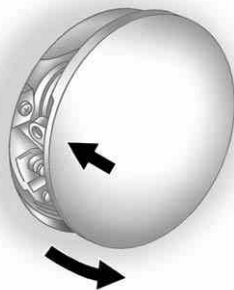

The fuel cap is behind the fuel door on the vehicle's passenger side. To open the fuel door, push the rearward center edge in and release and it will open.

Turn the tethered fuel cap counterclockwise to remove. If the vehicle has E85 fuel capability, the fuel cap will be yellow and state that E85 or gasoline can be used. See *Fuel E85 (85% Ethanol)* on page 9-36. While refueling, hang the tethered fuel cap from the hook on the fuel door. Reinstall the cap by turning it clockwise until it clicks.

If the cap is not properly installed, the Malfunction Indicator Lamp come on. See *Malfunction Indicator Lamp* on page 5-14 for more information.

WARNING

Fuel can spray out on you if you open the fuel cap too quickly. If you spill fuel and then something ignites it, you could be badly burned. This spray can happen if the tank is nearly full, and is more likely in hot weather. Open the fuel cap slowly and wait for any hiss noise to stop. Then unscrew the cap all the way.

Do not top off or overfill the tank and wait a few seconds before removing the nozzle. Clean fuel from painted surfaces as soon as possible. See *Exterior Care* on page 10-82.

 **WARNING**

If a fire starts while you are refueling, do not remove the nozzle. Shut off the flow of fuel by shutting off the pump or by notifying the station attendant. Leave the area immediately.

Notice: If a new fuel cap is needed, be sure to get the right type of cap from your dealer. The wrong type of fuel cap might not fit properly, might cause the malfunction indicator lamp to light, and could damage the fuel tank and emissions system. See *Malfunction Indicator Lamp on page 5-14*.

Filling a Portable Fuel Container

 **WARNING**

Never fill a portable fuel container while it is in the vehicle. Static electricity discharge from the container can ignite the fuel vapor. You can be badly burned and the vehicle damaged if this occurs. To help avoid injury to you and others:

- Dispense fuel only into approved containers.

(Continued)

WARNING (Continued)

- Do not fill a container while it is inside a vehicle, in a vehicle's trunk, pickup bed, or on any surface other than the ground.
- Bring the fill nozzle in contact with the inside of the fill opening before operating the nozzle. Contact should be maintained until the filling is complete.
- Do not smoke while pumping fuel.
- Do not use a cellular phone while pumping fuel.

Towing

General Towing Information

Only use towing equipment that has been designed for the vehicle. Contact your dealer or trailering dealer for assistance with preparing the vehicle for towing a trailer.

See the following trailer towing information in this section:

- For information on driving while towing a trailer, see “Driving Characteristics and Towing Tips.”
- For maximum vehicle and trailer weights, see “Trailer Towing.”
- For information on equipment to tow a trailer, see “Towing Equipment.”

For information on towing a disabled vehicle, see *Towing the Vehicle on page 10-79*. For information on towing the vehicle behind another

vehicle such as a motor home, see *Recreational Vehicle Towing on page 10-80*.

Driving Characteristics and Towing Tips

WARNING

The driver can lose control when pulling a trailer if the correct equipment is not used or the vehicle is not driven properly. For example, if the trailer is too heavy, the brakes may not work well — or even at all. The driver and passengers could be seriously injured. The vehicle may also be damaged; the resulting repairs would not be covered by the vehicle warranty. Pull a trailer only if all the steps in this section have been followed. Ask your dealer for advice and information about towing a trailer with the vehicle.

The vehicle can tow a trailer when equipped with the proper trailer towing equipment. For trailering capacity, see *Trailer Towing on page 9-42*. Trailering changes handling, acceleration, braking, durability and fuel economy. With the added weight, the engine, transmission, wheel assemblies and tires are forced to work harder and under greater loads. The trailer also adds wind resistance, increasing the pulling requirements. For safe trailering, correctly use the proper trailering equipment.

The following information has important trailering tips and rules for your safety and that of your passengers. Read this section carefully before pulling a trailer.

Pulling a Trailer

Here are some important points:

- There are many laws, including speed limit restrictions that apply to trailering. Check for legal requirements with state or provincial police.
- Do not tow a trailer at all during the first 1 600 km (1,000 miles) the new vehicle is driven. The engine, axle or other parts could be damaged.
- During the first 800 km (500 miles) that a trailer is towed, do not drive over 80 km/h (50 mph) and do not make starts at full throttle. This reduces wear on the vehicle.
- The vehicle can tow in D (Drive). Use a lower gear if the transmission shifts too often.

- Obey speed limit restrictions. Do not drive faster than the maximum posted speed for trailers, or no more than 90 km/h (55 mph), to reduce wear on the vehicle.

Driving with a Trailer

Towing a trailer requires experience. Get familiar with handling and braking with the added trailer weight. The vehicle is now longer and not as responsive as the vehicle is by itself.

Check all trailer hitch parts and attachments, safety chains, electrical connectors, lamps, tires and mirror adjustments. If the trailer has electric brakes, start the vehicle and trailer moving and then apply the trailer brake controller by hand to be sure the brakes are working.

During the trip, check regularly to be sure that the load is secure, and the lamps and trailer brakes are working properly.

Towing with a Stability Control System

When towing, the sound of the stability control system might be heard. The system is reacting to the vehicle movement caused by the trailer, which mainly occurs during cornering. This is normal when towing heavier trailers.

Following Distance

Stay at least twice as far behind the vehicle ahead as you would when driving the vehicle without a trailer. This can help to avoid situations that require heavy braking and sudden turns.

Passing

More passing distance is needed when towing a trailer. Because the rig is longer, it is necessary to go farther beyond the passed vehicle before returning to the lane.

Backing Up

Hold the bottom of the steering wheel with one hand. To move the trailer to the left, move that hand to the left. To move the trailer to the right, move your hand to the right. Always back up slowly and, if possible, have someone guide you.

Making Turns

Notice: Making very sharp turns while trailering could cause the trailer to come in contact with the vehicle. The vehicle could be damaged. Avoid making very sharp turns while trailering.

When turning with a trailer, make wider turns than normal so the trailer will not strike soft shoulders, curbs, road signs, trees or other objects. Use the turn signal well in advance and avoid jerky or sudden maneuvers.

Turn Signals When Towing a Trailer

The turn signal indicators on the instrument panel flash whenever signaling a turn or lane change. Properly hooked up, the trailer lamps also flash, telling other drivers the vehicle is turning, changing lanes or stopping.

When towing a trailer, the arrows on the instrument panel flash for turns even if the bulbs on the trailer are burned out. Check occasionally to be sure the trailer bulbs are still working.

Driving on Grades

Reduce speed and shift to a lower gear before starting down a long or steep downgrade. If the transmission is not shifted down, the brakes might have to be used so much that they would get hot and no longer work well.

The vehicle can tow in D (Drive). Use a lower gear if the transmission shifts too often.

When towing at high altitude on steep uphill grades, engine coolant boils at a lower temperature than at normal altitudes. If the engine is turned off immediately after towing at high altitude on steep uphill grades, the vehicle could show signs similar to engine overheating. To avoid this, let the engine run while parked, preferably on level ground, with the transmission in P (Park) for a few minutes before turning the engine off. If the overheat warning comes on, see *Engine Overheating on page 10-17*.

Parking on Hills

 **WARNING**

Parking the vehicle on a hill with the trailer attached can be dangerous. If something goes wrong, the rig could start to move. People can be injured, and both the vehicle and the trailer can be damaged. When possible, always park the rig on a flat surface.

If parking the rig on a hill:

1. Press the brake pedal, but do not shift into P (Park) yet. Turn the wheels into the curb if facing downhill or into traffic if facing uphill.
2. Have someone place chocks under the trailer wheels.
3. When the wheel chocks are in place, release the brake pedal until the chocks absorb the load.

4. Reapply the brake pedal. Then apply the parking brake and shift into P (Park).
5. Release the brake pedal.

Leaving After Parking on a Hill

1. Apply and hold the brake pedal.
2. Start the engine.
3. Shift into a gear.
4. Release the parking brake.
5. Let up on the brake pedal.
6. Drive slowly until the trailer is clear of the chocks.
7. Stop and have someone pick up and store the chocks.

Maintenance When Trailer Towing

The vehicle needs service more often when pulling a trailer. See this manual's Maintenance Schedule or Index for more information. Things that are especially important in

trailer operation are automatic transmission fluid, engine oil, axle lubricant, belts, cooling system and brake system. Inspect these before and during the trip.

Check periodically to see that all hitch nuts and bolts are tight.

Engine Cooling When Trailer Towing

The cooling system may temporarily overheat during severe operating conditions. See *Engine Overheating on page 10-17*.

Trailer Towing

Before pulling a trailer, there are three important considerations that have to do with weight:

- The weight of the trailer.
- The weight of the trailer tongue.
- The total weight on your vehicle's tires.

Weight of the Trailer

How heavy can a trailer safely be?

It should never weigh more than 454 kg (1,000 lbs). But even that can be too heavy.

It depends on how the rig is used. For example, speed, altitude, road grades, outside temperature, and how much the vehicle is used to pull a trailer are all important. It can depend on any special equipment on the vehicle, and the amount of tongue weight the vehicle can carry. See "Weight of the Trailer Tongue" later in this section for more information.

Maximum trailer weight is calculated assuming only the driver is in the tow vehicle and it has all the required trailering equipment. The weight of additional optional equipment, passengers, and cargo in the tow vehicle must be subtracted from the maximum trailer weight.

Ask your dealer for trailering information or advice, or write us at our Customer Assistance Offices. See *Customer Assistance Offices (U.S. and Canada)* on page 13-4 or *Customer Assistance Offices (Mexico)* on page 13-5 for more information.

Weight of the Trailer Tongue

The tongue load (A) of any trailer is an important weight to measure because it affects the total gross weight of the vehicle. The Gross Vehicle Weight (GVW) includes the curb weight of the vehicle, any cargo carried in it, and the people who will be riding in the vehicle.

If there are a lot of options, equipment, passengers or cargo in the vehicle, it will reduce the tongue weight the vehicle can carry, which will also reduce the trailer weight the vehicle can tow. If towing a trailer,

the tongue load must be added to the GVW because the vehicle will be carrying that weight, too. See *Vehicle Load Limits* on page 9-10 for more information.

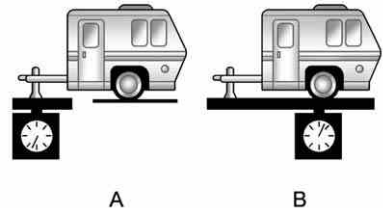

The trailer tongue (A) should weigh 10–15 percent of the total loaded trailer weight (B).

After loading the trailer, weigh the trailer and then the tongue, separately, to see if the weights are proper. If they are not, adjustments might be made by moving some items around in the trailer.

Total Weight on Your Vehicle's Tires

Be sure the vehicle's tires are inflated to the upper limit for cold tires. These numbers can be found on the Tire and Loading Information label. See *Vehicle Load Limits on page 9-10*. Make sure not to go over the GVW limit for the vehicle, including the weight of the trailer tongue.

Towing Equipment

Hitches

Use the correct hitch equipment. See your dealer or a hitch dealer for assistance.

- The rear bumper on the vehicle is not intended for hitches. Do not attach rental hitches or other bumper-type hitches to it. Use only a frame-mounted hitch that does not attach to the bumper.
- Will any holes be made in the body of the vehicle when the trailer hitch is installed? If there are, seal the holes when the hitch is removed. If the holes are not sealed, dirt, water, and deadly carbon monoxide (CO) from the exhaust can get into the vehicle. See *Engine Exhaust on page 9-21*.

Safety Chains

Always attach chains between the vehicle and the trailer. Cross the safety chains under the tongue of the trailer to help prevent the tongue from contacting the road if it becomes separated from the hitch. Leave enough slack so the rig can turn. Never allow safety chains to drag on the ground.

Trailer Brakes

Does the trailer have its own brakes? Be sure to read and follow the instructions for the trailer brakes so they are installed, adjusted, and maintained properly.

Because the vehicle has antilock brakes, do not tap into the vehicle's brake system. If this is done, both brake systems will not work well, or at all.

Conversions and Add-Ons

Add-On Electrical Equipment

Notice: Do not add anything electrical to the vehicle unless you check with your dealer first. Some electrical equipment can damage the vehicle and the damage would not be covered by the vehicle's warranty. Some add-on electrical equipment can keep other components from working as they should.

Add-on equipment can drain the vehicle's 12-volt battery, even if the vehicle is not operating.

The vehicle has an airbag system. Before attempting to add anything electrical to the vehicle, see *Servicing the Airbag-Equipped Vehicle on page 3-28* and *Adding Equipment to the Airbag-Equipped Vehicle on page 3-28*.

Vehicle Care

General Information

General Information	10-2
California Proposition 65 Warning	10-3
California Perchlorate Materials Requirements	10-3
Accessories and Modifications	10-3

Vehicle Checks

Doing Your Own Service Work	10-4
Hood	10-4
Engine Compartment Overview	10-5
Engine Oil	10-8
Engine Oil Life System	10-11
Automatic Transmission Fluid	10-12
Engine Air Cleaner/Filter	10-12
Cooling System	10-13
Engine Coolant	10-14
Engine Overheating	10-17
Overheated Engine Protection Operating Mode	10-18

Power Steering Fluid	10-19
Washer Fluid	10-19
Brakes	10-20
Brake Fluid	10-21
Battery	10-22
Starter Switch Check	10-23
Automatic Transmission Shift Lock Control Function Check	10-23
Ignition Transmission Lock Check	10-24
Park Brake and P (Park) Mechanism Check	10-24
Wiper Blade Replacement	10-24

Headlamp Aiming

Headlamp Aiming	10-25
-----------------------	-------

Bulb Replacement

Bulb Replacement	10-25
Halogen Bulbs	10-25
Taillamps, Turn Signal, and Stoplamps (LS and LT)	10-26
Taillamps, Turn Signal, and Stoplamps (LTZ)	10-27
Back-Up Lamps	10-28
License Plate Lamp	10-29
Replacement Bulbs	10-30

Electrical System

Electrical System Overload	10-30
Fuses	10-31
Engine Compartment Fuse Block	10-31
Instrument Panel Fuse Block	10-34
Rear Compartment Fuse Block	10-36

Wheels and Tires

Tires	10-38
Winter Tires	10-39
Low-Profile Tires	10-39
Tire Sidewall Labeling	10-39
Tire Designations	10-42
Tire Terminology and Definitions	10-42
Tire Pressure	10-45
Tire Pressure for High-Speed Operation	10-46
Tire Pressure Monitor System	10-47
Tire Pressure Monitor Operation	10-48
Tire Inspection	10-51
Tire Rotation	10-51

10-2 Vehicle Care

When It Is Time for New

Tires	10-52
Buying New Tires	10-53
Different Size Tires and Wheels	10-55
Uniform Tire Quality Grading	10-55
Wheel Alignment and Tire Balance	10-57
Wheel Replacement	10-57
Tire Chains	10-58
If a Tire Goes Flat	10-58
Tire Sealant and Compressor Kit	10-60
Storing the Tire Sealant and Compressor Kit	10-66
Tire Changing	10-66
Compact Spare Tire	10-75

Jump Starting

Jump Starting	10-76
---------------------	-------

Towing

Towing the Vehicle	10-79
Recreational Vehicle Towing	10-80

Appearance Care

Exterior Care	10-82
Interior Care	10-85
Floor Mats	10-87

General Information

For service and parts needs, visit your dealer. You will receive genuine GM parts and GM-trained and supported service people.

Genuine GM parts have one of these marks:

ACDelco[®]

Genuine  | **Parts**

 **Accessories**

California Proposition 65 Warning

Most motor vehicles, including this one, contain and/or emit chemicals known to the State of California to cause cancer and birth defects or other reproductive harm. Engine exhaust, many parts and systems, many fluids, and some component wear by-products contain and/or emit these chemicals.

California Perchlorate Materials Requirements

Certain types of automotive applications, such as airbag initiators, safety belt pretensioners, and lithium batteries contained in Remote Keyless Entry transmitters, may contain perchlorate materials. Special handling may be necessary. For additional information, see www.dtsc.ca.gov/hazardouswaste/perchlorate.

Accessories and Modifications

Adding non-dealer accessories or making modifications to the vehicle can affect vehicle performance and safety, including such things as airbags, braking, stability, ride and handling, emissions systems, aerodynamics, durability, and electronic systems like antilock brakes, traction control, and stability control. These accessories or modifications could even cause malfunction or damage not covered by the vehicle warranty.

Damage to vehicle components resulting from modifications or the installation or use of non-GM certified parts, including control module or software modifications, is not covered under the terms of the vehicle warranty and may affect remaining warranty coverage for affected parts.

GM Accessories are designed to complement and function with other systems on the vehicle. See your dealer to accessorize the vehicle using genuine GM Accessories installed by a dealer technician.

Also, see [Adding Equipment to the Airbag-Equipped Vehicle](#) on page 3-28.

Vehicle Checks

Doing Your Own Service Work

 **WARNING**

It can be dangerous to work on your vehicle if you do not have the proper knowledge, service manual, tools, or parts. Always follow owner manual procedures and consult the service manual for your vehicle before doing any service work.

If doing some of your own service work, use the proper service manual. It tells you much more about how to service the vehicle than this manual can. To order the proper service manual, see *Service Publications Ordering Information* on page 13-16.

This vehicle has an airbag system. Before attempting to do your own service work, see *Servicing the Airbag-Equipped Vehicle* on page 3-28.

Keep a record with all parts receipts and list the mileage and the date of any service work performed. See *Maintenance Records* on page 11-13.

Hood

To open the hood:



1. Pull the hood release handle with this symbol on it. It is located inside the vehicle to the left of the steering column.



2. Then go to the front of the vehicle and push the secondary hood release handle toward the driver side of the vehicle.
3. Lift the hood.
4. After the hood is slightly lifted, it will continue to open to the full position. Before closing the hood, be sure all the filler caps are on properly. Lower the hood until the lifting force of the strut is reduced, then release the hood to latch fully. Check to make sure the hood is closed and repeat the process if necessary.

Engine Compartment Overview

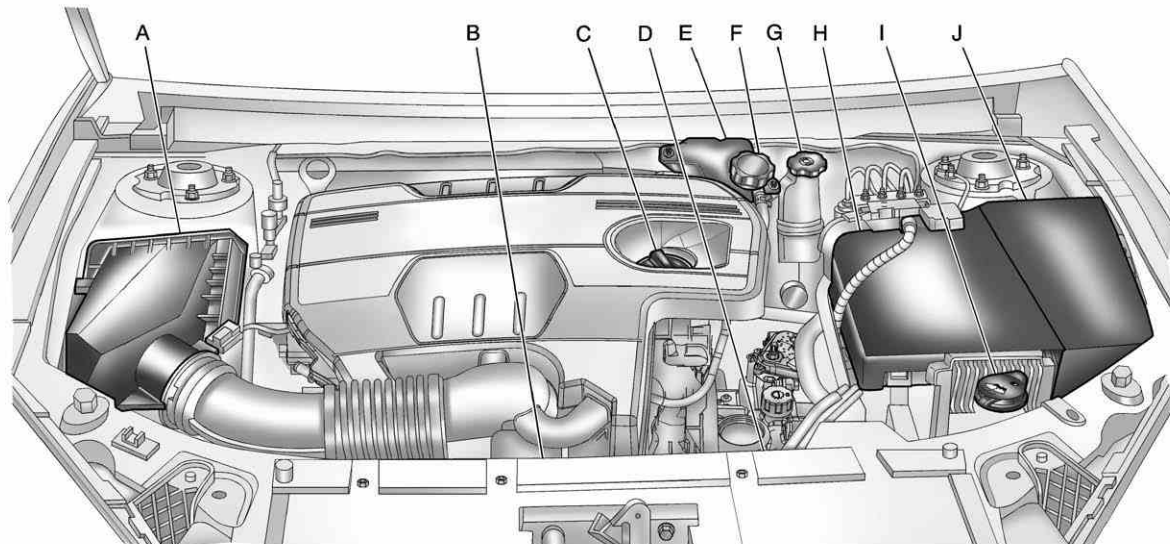

2.4 L L4 Engine

10-6 Vehicle Care

- A. *Engine Air Cleaner/Filter on page 10-12.*
- B. *Engine Cooling Fan (Out of View). See *Cooling System on page 10-13.**
- C. *Engine Oil Fill Cap. See "When to Add Engine Oil" under *Engine Oil on page 10-8.**
- D. *Engine Oil Dipstick (Out of View). See "Checking Engine Oil" under *Engine Oil on page 10-8.**
- E. *Engine Coolant Surge Tank. See *Engine Coolant on page 10-14.**
- F. *Pressure Cap. See *Cooling System on page 10-13.**
- G. *Brake Master Cylinder Reservoir. See "Brake Fluid" under *Brakes on page 10-20.**
- H. *Battery on page 10-22.*
- I. *Windshield Washer Fluid Reservoir. See "Adding Washer Fluid" under *Washer Fluid on page 10-19.**
- J. *See *Engine Compartment Fuse Block on page 10-31.**

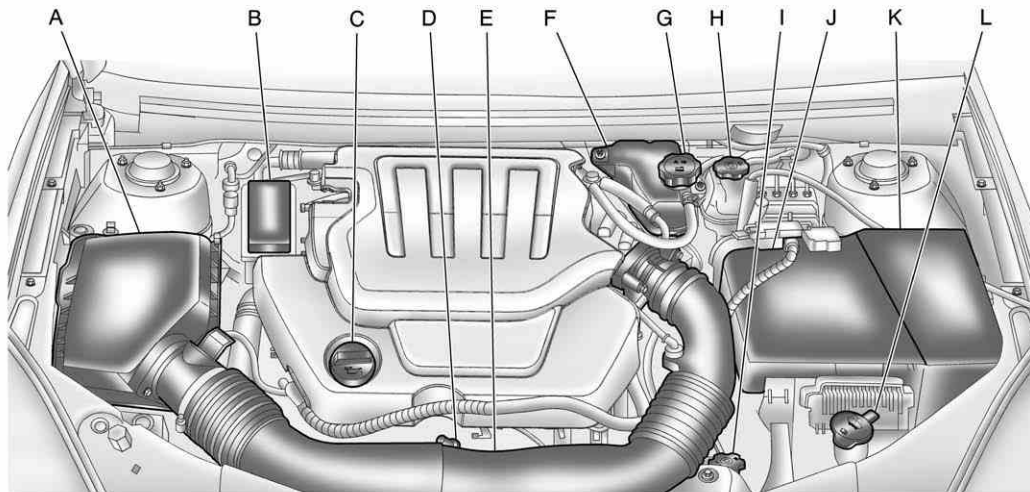

3.6 L V6 Engine

10-8 Vehicle Care

- A. *Engine Air Cleaner/Filter on page 10-12.*
- B. *Power Steering Fluid Reservoir. See Power Steering Fluid on page 10-19.*
- C. *Engine Oil Fill Cap. See "When to Add Engine Oil" under Engine Oil on page 10-8.*
- D. *Engine Oil Dipstick. See "Checking Engine Oil" under Engine Oil on page 10-8.*
- E. *Electric Engine Cooling Fans (Out of View). See Cooling System on page 10-13.*
- F. *Engine Coolant Surge Tank. See Engine Coolant on page 10-14.*
- G. *Pressure Cap. See Cooling System on page 10-13.*
- H. *Brake Master Cylinder Reservoir. See "Brake Fluid" under Brakes on page 10-20.*
- I. *Automatic Transmission Fluid Dipstick (Out of View). See "Checking the Fluid Level" under Automatic Transmission Fluid on page 10-12.*
- J. *See Battery on page 10-22.*
- K. *Engine Compartment Fuse Block on page 10-31.*
- L. *Windshield Washer Fluid Reservoir. See "Adding Washer Fluid" under Washer Fluid on page 10-19.*

Engine Oil

To ensure proper engine performance and long life, careful attention must be paid to engine oil. Following these simple, but important steps will help protect your investment:

- Always use engine oil approved to the proper specification and of the proper viscosity grade. See "Selecting the Right Engine Oil" in this section.
- Check the engine oil level regularly and maintain the proper oil level. See "Checking Engine Oil" and "When to Add Engine Oil" in this section.
- Change the engine oil at the appropriate time. See *Engine Oil Life System on page 10-11.*
- Always dispose of engine oil properly. See "What to Do with Used Oil" in this section.

Checking Engine Oil

It is a good idea to check the engine oil level at each fuel fill. In order to get an accurate reading, the vehicle must be on level ground. The engine oil dipstick handle is a yellow loop. See *Engine Compartment Overview on page 10-5* for the location of the engine oil dipstick.

Obtaining an accurate oil level reading is essential:

1. If the engine has been running recently, turn off the engine and allow several minutes for the oil to drain back into the oil pan. Checking the oil level too soon after engine shutoff will not provide an accurate oil level reading.
2. Pull out the dipstick and clean it with a paper towel or cloth, then push it back in all the way. Remove it again, keeping the tip down, and check the level.

When to Add Engine Oil



L4 Engine



V6 Engine

If the oil is below the MIN (minimum) mark for the L4 engine or below the cross-hatched area at the tip of the dipstick for the V6 engine, add 1 L (1 qt) of the recommended oil and then recheck the level. See "Selecting the Right Engine Oil" in this section for an explanation of what kind of oil to use. For engine oil crankcase capacity, see *Capacities and Specifications on page 12-2*.

Notice: Do not add too much oil. Oil levels above or below the acceptable operating range shown on the dipstick are harmful to the engine. If you find that you have an oil level above the operating range, i.e., the engine has so much oil that the oil level gets above the upper mark that shows the proper operating range, the engine could be damaged. You should drain out the excess oil or limit driving of the vehicle and seek a service professional to remove the excess amount of oil.

See *Engine Compartment Overview on page 10-5* for the location of the engine oil fill cap.

Add enough oil to put the level somewhere in the proper operating range. Push the dipstick all the way back in when through.

Selecting the Right Engine Oil

Selecting the right engine oil depends on both the proper oil specification and viscosity grade. See *Recommended Fluids and Lubricants* on page 11-11.

Specification

Use and ask for licensed engine oils with the dexos1™ approved certification mark. Engine oils meeting the requirements for the vehicle should have the dexos1 approved certification mark. This certification mark indicates that the oil has been approved to the dexos1 specification.



Notice: Failure to use the recommended engine oil or equivalent can result in engine

damage not covered by the vehicle warranty. Check with your dealer or service provider on whether the oil is approved to the dexos1 specification.

Viscosity Grade

SAE 5W-30 is the best viscosity grade for the vehicle. Do not use other viscosity grade oils such as SAE 10W-30, 10W-40, or 20W-50.

If in an area of extreme cold, where the temperature falls below -20°F (-29°C), an SAE 0W-30 oil should be used. An oil of this viscosity grade will provide easier cold starting for the engine at extremely low temperatures. When selecting an oil of the appropriate viscosity grade, always select an oil that meets the dexos1 specification or equivalent. See "Specification" for more information.

Engine Oil Additives/Engine Oil Flushes

Do not add anything to the oil. The recommended oils with the dexos specification and displaying the dexos certification mark are all that is needed for good performance and engine protection.

Engine oil system flushes are not recommended and could cause engine damage not covered by the vehicle warranty.

What to Do with Used Oil

Used engine oil contains certain elements that can be unhealthy for your skin and could even cause cancer. Do not let used oil stay on your skin for very long. Clean your skin and nails with soap and water, or a good hand cleaner. Wash or properly dispose of clothing or rags containing used engine oil. See the manufacturer's warnings about the use and disposal of oil products.

Used oil can be a threat to the environment. If you change your own oil, be sure to drain all the oil from the filter before disposal. Never dispose of oil by putting it in the trash or pouring it on the ground, into sewers, or into streams or bodies of water. Recycle it by taking it to a place that collects used oil.

Engine Oil Life System

When to Change Engine Oil

This vehicle has a computer system that indicates when to change the engine oil and filter. This is based on a combination of factors which include engine revolutions, engine temperature, and miles driven. Based on driving conditions, the mileage at which an oil change is indicated can vary considerably. For the oil life system to work properly, the system must be reset every time the oil is changed.

When the system has calculated that oil life has been diminished, it indicates that an oil change is necessary. A CHANGE OIL SOON message comes on. See *Engine Oil Messages on page 5-25*. Change the oil as soon as possible within the next 1 000 km (600 mi). It is possible that, if driving under the best conditions, the oil life system might indicate that an oil change is not necessary for up to a year. The engine oil and filter must be changed at least once a year and, at this time, the system must be reset. Your dealer has trained service people who will perform this work and reset the system. It is also important to check the oil regularly over the course of an oil drain interval and keep it at the proper level.

If the system is ever reset accidentally, the oil must be changed at 5 000 km (3,000 mi) since the last oil change. Remember to reset the oil life system whenever the oil is changed.

How to Reset the Engine Oil Life System

Reset the system whenever the engine oil is changed so that the system can calculate the next engine oil change. To reset the system:

1. Turn the ignition to ON/RUN, with the engine off.
2. Press and hold the DIC INFO and reset buttons, on the left side of the steering wheel, at the same time to enter the personalization menu. The OIL LIFE RESET message displays. See *Driver Information Center (DIC) on page 5-22* and *Engine Oil Messages on page 5-25*.
3. Press and hold the reset button until the DIC display shows ACKNOWLEDGED.
4. Turn the key to LOCK/OFF.

The system is reset when the CHANGE OIL SOON message is off.

10-12 Vehicle Care

If the CHANGE OIL SOON message comes back on when the vehicle is started, the engine oil life system has not reset. Repeat the procedure.

Automatic Transmission Fluid

It is not necessary to check the transmission fluid level.

A transmission fluid leak is the only reason for fluid loss. If a leak occurs, take the vehicle to the dealer and have it repaired as soon as possible.

Change the fluid and filter at the intervals listed in *Maintenance Schedule on page 11-3*, and be sure to use the transmission fluid listed in *Recommended Fluids and Lubricants on page 11-11*.

Notice: Use of the incorrect automatic transmission fluid may damage the vehicle, and the damages may not be covered by the vehicle warranty. Always use

the automatic transmission fluid listed in *Recommended Fluids and Lubricants on page 11-11*.

For the 2.4 L and 3.6 L engines, the transmission fluid will not reach the end of the dipstick unless the transmission is at operating temperature. If the transmission fluid level needs to be checked, please take the vehicle to the dealer.

Engine Air Cleaner/Filter

See *Engine Compartment Overview on page 10-5* for the location of the engine air cleaner/filter.

When to Inspect the Engine Air Cleaner/Filter

Inspect the air cleaner/filter at the scheduled maintenance intervals and replace it at the first oil change after each 80 000 km (50,000 mi) interval. See *Maintenance Schedule on page 11-3* for more information. If driving in dusty/dirty conditions, inspect the filter at each engine oil change.

How to Inspect the Engine Air Cleaner/Filter

To inspect the air cleaner/filter, remove the filter from the vehicle and lightly shake the filter to release loose dust and dirt. If the filter remains covered with dirt, a new filter is required.

To inspect or replace the engine air cleaner/filter:

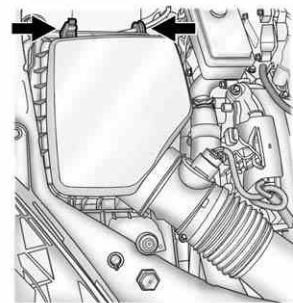

1. Remove the spring clamps that hold the cover on.
2. Lift off the cover.

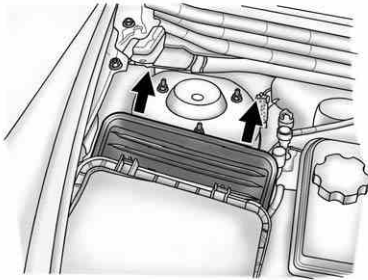

3. Inspect or replace the engine air cleaner/filter.
4. Align the filter correctly using the alignment tab.
5. Install the cover by guiding the tabs on the rim of the top cover into the bottom hinges and turn the cover down to close it.
6. The spring clips will engage easily, if the cover is properly seated.

⚠ WARNING

Operating the engine with the air cleaner/filter off can cause you or others to be burned. The air cleaner not only cleans the air; it helps to stop flames if the engine backfires. Use caution when working on the engine and do not drive with the air cleaner/filter off.

Notice: If the air cleaner/filter is off, dirt can easily get into the engine, which could damage it. Always have the air cleaner/filter in place when you are driving.

Cooling System

The cooling system allows the engine to maintain the correct working temperature.

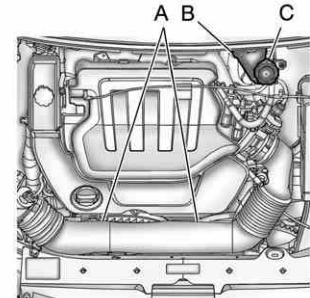

3.6 L V6 Engine Shown, 2.4 L L4 Engine Similar

- A. Engine Cooling Fans (Out of View)
- B. Engine Coolant Surge Tank
- C. Pressure Cap

WARNING

An electric engine cooling fan under the hood can start up even when the engine is not running and can cause injury. Keep hands, clothing, and tools away from any underhood electric fan.

WARNING

Heater and radiator hoses, and other engine parts, can be very hot. Do not touch them. If you do, you can be burned.

Do not run the engine if there is a leak. If you run the engine, it could lose all coolant. That could cause an engine fire, and you could be burned. Get any leak fixed before you drive the vehicle.

Notice: Using coolant other than DEX-COOL[®] can cause premature engine, heater core, or radiator corrosion. In addition, the engine coolant could require changing sooner, at 50 000 km (30,000 mi) or 24 months, whichever occurs first. Any repairs would not be covered by the vehicle warranty. Always use DEX-COOL (silicate-free) coolant in the vehicle.

Engine Coolant

The cooling system in the vehicle is filled with DEX-COOL[®] engine coolant. This coolant is designed to remain in the vehicle for 5 years or 240 000 km (150,000 mi), whichever occurs first.

The following explains the cooling system and how to check and add coolant when it is low. If there is a problem with engine overheating, see *Engine Overheating* on page 10-17.

What to Use

WARNING

Adding only plain water or some other liquid to the cooling system can be dangerous. Plain water and other liquids, can boil before the proper coolant mixture will. The coolant warning system is set for the proper coolant mixture. With plain water or the wrong mixture, the engine could get too hot but you would not get the overheat warning. The engine could catch fire and you or others could be burned. Use a 50/50 mixture of clean, drinkable water and DEX-COOL coolant.

Use a 50/50 mixture of clean, drinkable water and DEX-COOL coolant. If using this mixture, nothing else needs to be added. This mixture:

- Gives freezing protection down to -37°C (-34°F), outside temperature.
- Gives boiling protection up to 129°C (265°F), engine temperature.
- Protects against rust and corrosion.
- Will not damage aluminum parts.
- Helps keep the proper engine temperature.

Notice: If an improper coolant mixture is used, the engine could overheat and be badly damaged. The repair cost would not be covered by the vehicle warranty. Too much water in the mixture can freeze and crack the engine, radiator, heater core, and other parts.

Never dispose of engine coolant by putting it in the trash, pouring it on the ground, or into sewers, streams, or bodies of water. Have the coolant changed by an authorized service center, familiar with legal requirements regarding used coolant disposal. This will help protect the environment and your health.

Checking Coolant

The vehicle must be on a level surface when checking the coolant level.

Check to see if coolant is visible in the coolant surge tank. If the coolant inside the coolant surge tank is boiling, do not do anything else until it cools down. If coolant is visible but the coolant level is not at or above the FULL COLD mark, add a 50/50 mixture of clean, drinkable water and DEX-COOL coolant at the coolant surge tank, but be sure the cooling system is cool before this is done. See *Engine Overheating on page 10-17* for more information.

The coolant level should be at or above the FULL COLD mark on the coolant surge tank. If it is not, there may be a leak at the pressure cap or in the radiator hoses, heater hoses, radiator, water pump, or somewhere else in the cooling system.

How to Add Coolant to the Coolant Surge Tank

WARNING

An electric engine cooling fan under the hood can start up even when the engine is not running and can cause injury. Keep hands, clothing, and tools away from any underhood electric fan.

WARNING

Steam and scalding liquids from a hot cooling system can blow out and burn you badly. They are under pressure, and if you turn the surge tank pressure cap — even a little — they can come out at high speed. Never turn the cap when the cooling system, including the surge tank pressure cap, is hot. Wait for the cooling system and surge tank pressure cap to cool if you ever have to turn the pressure cap.

WARNING

You can be burned if you spill coolant on hot engine parts. Coolant contains ethylene glycol and it will burn if the engine parts are hot enough. Do not spill coolant on a hot engine.

Notice: This vehicle has a specific coolant fill procedure. Failure to follow this procedure could cause the engine to overheat and be severely damaged.

If coolant is needed, add the proper DEX-COOL coolant mixture at the coolant surge tank.



1. Remove the coolant surge tank pressure cap when the cooling system, including the coolant surge tank pressure cap and upper radiator hose, is no longer hot. Turn the pressure cap slowly counterclockwise about two or two and one-half turns.

If a hiss is heard, wait for that to stop. This will allow any pressure still left to be vented out the discharge hose.

2. Keep turning the pressure cap slowly, and remove it.
3. Fill the coolant surge tank with the proper mixture, to the FULL COLD mark. Wait about five minutes, then check to see if the level is below the mark. If the level is below the FULL COLD mark, add additional coolant to bring the level up to the mark. Repeat this procedure until the level remains constant at the FULL COLD mark for at least five minutes.
4. With the coolant surge tank pressure cap off, start the engine and let it run until the upper radiator hose can be felt getting hot. Watch out for the engine cooling fans.

By this time, the coolant level inside the coolant surge tank might be lower. If the level is lower than the FULL COLD mark, add more of the proper mixture to the coolant surge tank until the level reaches the FULL COLD mark.

5. Replace the pressure cap. Be sure the pressure cap is hand-tight and fully seated.

Notice: If the pressure cap is not tightly installed, coolant loss and possible engine damage may occur. Be sure the cap is properly and tightly secured.

Engine Overheating

The vehicle has several indicators to warn of engine overheating.

There is an engine coolant temperature gauge as well as an engine coolant temperature warning light on the vehicle's instrument panel cluster. See *Engine Coolant*

Temperature Gauge on page 5-19 and Engine Coolant Temperature Warning Light on page 5-19.

If it is decided not to lift the hood when this warning appears, but instead get service help right away. See *Roadside Assistance Program (U.S. and Canada) on page 13-7 or Roadside Assistance Program (Mexico) on page 13-9.*

If it is decided to lift the hood, make sure the vehicle is parked on a level surface.

Then check to see if the engine cooling fans are running. If the engine is overheating, both fans should be running. If they are not, do not continue to run the engine and have the vehicle serviced.

Notice: Engine damage from running the engine without coolant is not covered by the warranty.

If Steam is Coming from the Engine Compartment



WARNING

Steam from an overheated engine can burn you badly, even if you just open the hood. Stay away from the engine if you see or hear steam coming from it. Just turn it off and get everyone away from the vehicle until it cools down. Wait until there is no sign of steam or coolant before you open the hood.

If you keep driving when the engine is overheated, the liquids in it can catch fire. You or others could be badly burned. Stop the engine if it overheats, and get out of the vehicle until the engine is cool.

If No Steam is Coming from the Engine Compartment

If an engine overheat warning is displayed but no steam can be seen or heard, the problem may not be too serious. Sometimes the engine can get a little too hot when the vehicle:

- Climbs a long hill on a hot day.
- Stops after high-speed driving.
- Idles for long periods in traffic.
- Tows a trailer.

If the overheat warning is displayed with no sign of steam:

1. Turn the air off.
2. Turn the heater on to the highest temperature and to the highest fan speed. Open the windows as necessary.
3. In heavy traffic, let the engine idle in N (Neutral) while stopped. If it is safe to do so, pull off the road, shift to P (Park) or N (Neutral) and let the engine idle.

If the temperature overheat gauge is no longer in the overheat zone or an overheat warning no longer displays, the vehicle can be driven. Continue to drive the vehicle slowly for about 10 minutes. Keep a safe vehicle distance from the vehicle in front. If the warning does not come back on, continue to drive normally.

If the warning continues, pull over, stop, and park the vehicle right away.

If there is no sign of steam, idle the engine for three minutes while parked. If the warning is still displayed, turn off the engine until it cools down. Also, see “Overheated Engine Protection Operating Mode” following.

Overheated Engine Protection Operating Mode

This emergency operating mode allows the vehicle to be driven to a safe place in an emergency

situation. If an overheated engine condition exists, an overheat protection mode which alternates firing groups of cylinders helps prevent engine damage. In this mode, a significant loss in power and engine performance will be noticed. The temperature gauge will indicate an overheat condition exists. Driving extended km (mi) and/or towing a trailer in the overheat protection mode should be avoided.

Notice: After driving in the overheated engine protection operating mode, to avoid engine damage, allow the engine to cool before attempting any repair. The engine oil will be severely degraded. Repair the cause of coolant loss, change the oil and reset the oil life system. See *Engine Oil on page 10-8.*

Power Steering Fluid



See *Engine Compartment Overview* on page 10-5 for reservoir location.

When to Check Power Steering Fluid

Power steering fluid is used in all vehicles with the V6 engine. Vehicles with the 4-cylinder engine have electric power steering and do not use power steering fluid.

It is not necessary to regularly check power steering fluid unless a leak is suspected in the system, or an unusual noise is heard. A fluid loss in this system could indicate a problem. Have the system inspected and repaired.

How to Check Power Steering Fluid

To check the power steering fluid:

1. Turn the key off and let the engine compartment cool down.
2. Wipe the cap and the top of the reservoir clean.
3. Unscrew the cap and wipe the dipstick with a clean rag.
4. Replace the cap and completely tighten it.
5. Remove the cap again and look at the fluid level on the dipstick.

The fluid level should be between the MIN (Minimum) and MAX (Maximum) marks when the engine is cold, and at the MAX mark when the engine is hot. If the fluid is at the MIN mark when the engine is cold or hot, power steering fluid should be added.

The fluid level should be within the crosshatch area on the dipstick.

If the fluid is at or below the ADD or MIN mark on the dipstick, add just enough fluid to bring the level within the crosshatch area.

What to Use

To determine what kind of fluid to use, see *Recommended Fluids and Lubricants* on page 11-11. Always use the proper fluid.

Washer Fluid

What to Use

When windshield washer fluid is needed, be sure to read the manufacturer's instructions before use. If operating the vehicle in an area where the temperature may fall below freezing, use a fluid that has sufficient protection against freezing.

Adding Washer Fluid

When the windshield washer fluid reservoir is low, a LOW WASHER FLUID message displays on the

Driver Information Center (DIC). See *Driver Information Center (DIC)* on page 5-22 for more information.



Open the cap with the washer symbol on it. Add washer fluid until the tank is full. See *Engine Compartment Overview* on page 10-5 for reservoir location.

Notice

- **When using concentrated washer fluid, follow the manufacturer's instructions for adding water.**
- **Do not mix water with ready-to-use washer fluid. Water can cause the solution to freeze and damage the washer fluid tank and other**

parts of the washer system. Also, water does not clean as well as washer fluid.

- **Fill the washer fluid tank only three-quarters full when it is very cold. This allows for fluid expansion if freezing occurs, which could damage the tank if it is completely full.**
- **Do not use engine coolant (antifreeze) in the windshield washer. It can damage the windshield washer system and paint.**

Brakes

This vehicle has disc brakes. Disc brake pads have built-in wear indicators that make a high-pitched warning sound when the brake pads are worn and new pads are needed. The sound can come and go or be heard all the time the vehicle is moving, except when applying the brake pedal firmly.

WARNING

The brake wear warning sound means that soon the brakes will not work well. That could lead to a crash. When the brake wear warning sound is heard, have the vehicle serviced.

Notice: Continuing to drive with worn-out brake pads could result in costly brake repair.

Some driving conditions or climates can cause a brake squeal when the brakes are first applied or lightly applied. This does not mean something is wrong with the brakes.

Properly torqued wheel nuts are necessary to help prevent brake pulsation. When tires are rotated, inspect brake pads for wear and evenly tighten wheel nuts in the proper sequence to torque specifications in *Capacities and Specifications* on page 12-2.

Brake linings should always be replaced as complete axle sets.

Brake Pedal Travel

See your dealer if the brake pedal does not return to normal height, or if there is a rapid increase in pedal travel. This could be a sign that brake service might be required.

Brake Adjustment

Every time the brakes are applied, with or without the vehicle moving, the brakes adjust for wear.

Replacing Brake System Parts

The braking system on a vehicle is complex. Its many parts have to be of top quality and work well together if the vehicle is to have really good braking. The vehicle was designed and tested with top-quality brake parts. When parts of the braking system are replaced, be sure to get new, approved replacement parts.

If this is not done, the brakes might not work properly. For example, installing disc brake pads that are wrong for the vehicle, can change the balance between the front and rear brakes— for the worse. The braking performance expected can change in many other ways if the wrong replacement brake parts are installed.

Brake Fluid



The brake master cylinder reservoir is filled with DOT 3 brake fluid as indicated on the reservoir cap. See *Engine Compartment Overview on page 10-5* for the location of the reservoir.

There are only two reasons why the brake fluid level in the reservoir might go down:

- The brake fluid level goes down because of normal brake lining wear. When new linings are installed, the fluid level goes back up.
- A fluid leak in the brake hydraulic system can also cause a low fluid level. Have the brake hydraulic system fixed, since a leak means that sooner or later the brakes will not work well.

Do not top off the brake fluid. Adding fluid does not correct a leak. If fluid is added when the linings are worn, there will be too much fluid when new brake linings are installed. Add or remove brake fluid, as necessary, only when work is done on the brake hydraulic system.

WARNING

If too much brake fluid is added, it can spill on the engine and burn, if the engine is hot enough. You or others could be burned, and the vehicle could be damaged. Add brake fluid only when work is done on the brake hydraulic system.

When the brake fluid falls to a low level, the brake warning light comes on. See *Brake System Warning Light* on page 5-17.

What to Add

Use only new DOT 3 brake fluid from a sealed container. See *Recommended Fluids and Lubricants* on page 11-11.

Always clean the brake fluid reservoir cap and the area around the cap before removing it. This helps keep dirt from entering the reservoir.

WARNING

With the wrong kind of fluid in the brake hydraulic system, the brakes might not work well. This could cause a crash. Always use the proper brake fluid.

Notice

- **Using the wrong fluid can badly damage brake hydraulic system parts. For example, just a few drops of mineral-based oil, such as engine oil, in the brake hydraulic system can damage brake hydraulic system parts so badly that they will have to be replaced. Do not let someone put in the wrong kind of fluid.**

- **If brake fluid is spilled on the vehicle's painted surfaces, the paint finish can be damaged. Be careful not to spill brake fluid on the vehicle. If you do, wash it off immediately.**

Battery

Refer to the replacement number shown on the original battery label when a new battery is needed. See *Engine Compartment Overview* on page 10-5 for battery location.

WARNING

Battery posts, terminals, and related accessories contain lead and lead compounds, chemicals known to the State of California to cause cancer and reproductive harm. Wash hands after handling.

Vehicle Storage

WARNING

Batteries have acid that can burn you and gas that can explode. You can be badly hurt if you are not careful. See *Jump Starting on page 10-76* for tips on working around a battery without getting hurt.

Infrequent Usage: Remove the black, negative (-) cable from the battery to keep the battery from running down.

Extended Storage: Remove the black, negative (-) cable from the battery or use a battery trickle charger.

Starter Switch Check

WARNING

When you are doing this inspection, the vehicle could move suddenly. If the vehicle moves, you or others could be injured.

1. Before starting this check, be sure there is enough room around the vehicle.
2. Firmly apply both the parking brake and the regular brake. See *Parking Brake on page 9-26*.
Do not use the accelerator pedal, and be ready to turn off the engine immediately if it starts.
3. Try to start the engine in each gear. The vehicle should start only in P (Park) or N (Neutral).

If the vehicle starts in any other position, contact your dealer for service.

Automatic Transmission Shift Lock Control Function Check

WARNING

When you are doing this inspection, the vehicle could move suddenly. If the vehicle moves, you or others could be injured.

1. Before starting this check, be sure there is enough room around the vehicle. It should be parked on a level surface.
2. Firmly apply the parking brake. See *Parking Brake on page 9-26*.
Be ready to apply the regular brake immediately if the vehicle begins to move.

10-24 Vehicle Care

3. With the engine off, turn the ignition on, but do not start the engine. Without applying the regular brake, try to move the shift lever out of P (Park) with normal effort. If the shift lever moves out of P (Park), contact your dealer for service.

Ignition Transmission Lock Check

While parked, and with the parking brake set, try to turn the ignition to LOCK/OFF in each shift lever position.

- The ignition should turn to LOCK/OFF only when the shift lever is in P (Park).
- The ignition key should come out only in LOCK/OFF.

Contact your dealer if service is required.

Park Brake and P (Park) Mechanism Check

 **WARNING**

When you are doing this check, the vehicle could begin to move. You or others could be injured and property could be damaged. Make sure there is room in front of the vehicle in case it begins to roll. Be ready to apply the regular brake at once should the vehicle begin to move.

Park on a fairly steep hill, with the vehicle facing downhill. Keeping your foot on the regular brake, set the parking brake.

- To check the parking brake's holding ability: With the engine running and the transmission in N (Neutral), slowly remove foot pressure from the regular brake pedal. Do this until the vehicle is held by the parking brake only.

- To check the P (Park) mechanism's holding ability: With the engine running, shift to P (Park). Then release the parking brake followed by the regular brake.

Contact your dealer if service is required.

Wiper Blade Replacement

Windshield wiper blades should be inspected for wear or cracking. See *Maintenance Schedule on page 11-3* for more information.

It is a good idea to clean or replace the wiper blade assembly on a regular basis or when worn. For proper windshield wiper blade length and type, see *Maintenance Replacement Parts on page 11-12*.

Notice: Allowing the wiper arm to touch the windshield when no wiper blade is installed could damage the windshield. Any damage that occurs would not be

covered by your warranty. Do not allow the wiper arm to touch the windshield.

To replace the wiper blade:

1. Pull the windshield wiper arm connector away from the windshield.

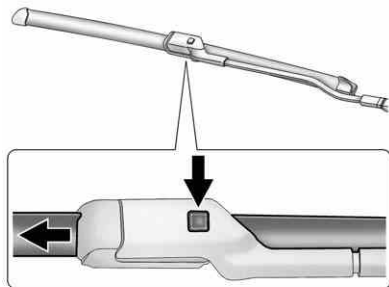

2. Press the button in the middle of the wiper arm connector, and pull the wiper blade away from the arm connector.
3. Remove the wiper blade.
4. Reverse steps 1 through 3 for wiper blade replacement.

Headlamp Aiming

Headlamp aim has been preset at the factory and should need no further adjustment.

However, if the vehicle is damaged in a crash, the headlamp aim may be affected. Aim adjustment to the low-beam headlamps may be necessary if oncoming drivers flash their high-beam headlamps at you (for vertical aim).

If the headlamps need to be re-aimed, it is recommended that the vehicle be taken to a dealer for service.

Bulb Replacement

For the proper type of replacement bulbs, see *Replacement Bulbs* on page 10-30.

For any bulb-changing procedure not listed in this section, contact your dealer.

Halogen Bulbs

WARNING

Halogen bulbs have pressurized gas inside and can burst if you drop or scratch the bulb. You or others could be injured. Be sure to read and follow the instructions on the bulb package.

Taillamps, Turn Signal, and Stoplamps (LS and LT)

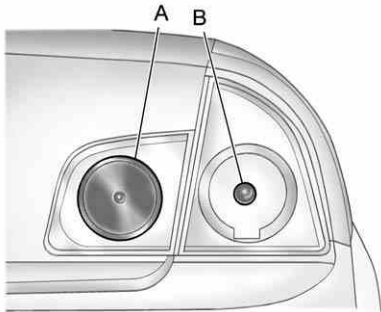

- A. Back-up Lamp
 - B. Stoplamp, Taillamp and Turn Signal Lamp
1. Open the trunk. See *Trunk* on page 2-9 for more information.

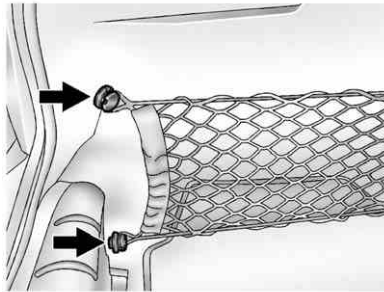

2. Remove the two rear convenience net hooks holding the trunk trim and move the trim aside.

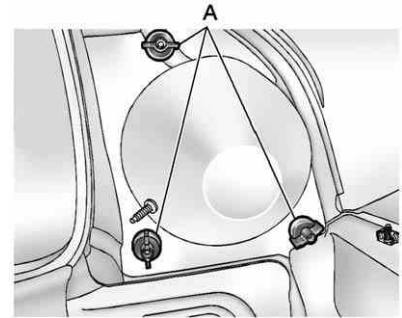

3. Remove the three wing nuts (A), which hold the taillamp assembly, from inside the trunk.
4. Remove the taillamp assembly.

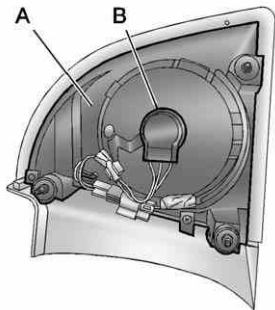

- 5. Turn the bulb socket (B) counterclockwise to remove it from the lamp assembly (A).
- 6. Pull the bulb from the socket (B).
- 7. Install a new bulb.
- 8. Reverse Steps 2 through 5 to reinstall the taillamp assembly (A).

Taillamps, Turn Signal, and Stoplamps (LTZ)

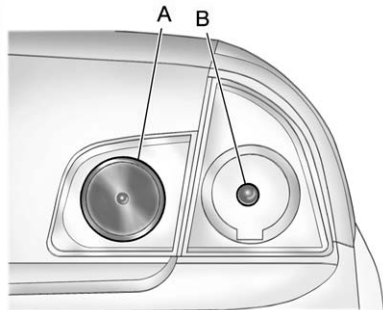

- A. Back-up Lamp
 - B. Stoplamp, Taillamp and Turn Signal Lamp
1. Open the trunk. See *Trunk on page 2-9* for more information.

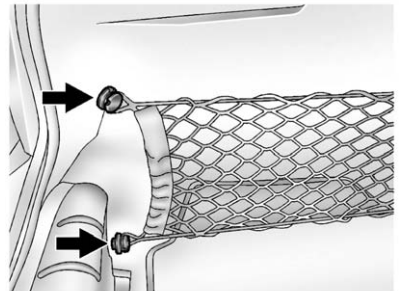

2. Remove the two rear convenience net hooks holding the trunk trim and move the trim aside.

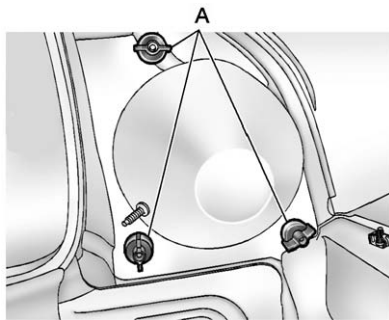

3. Remove the three wing nuts (A), which hold the taillamp assembly, from inside the trunk.
4. Remove the taillamp assembly.

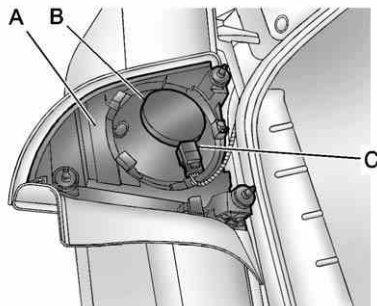

5. Disconnect the wiring harness connector (C) from the LED (B).
6. Turn the LED (B) counterclockwise to remove it.
7. Install a new LED (B).
8. Reverse Steps 2 through 6 to reinstall the taillamp assembly (A).

Back-Up Lamps

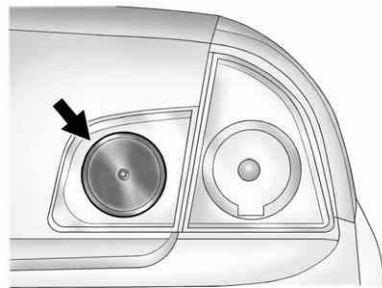

1. Open the trunk. See *Trunk* on page 2-9 for more information.

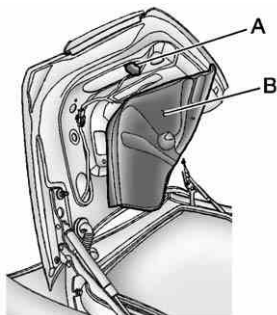

2. Remove the push pins holding the trunk trim (B).
3. Move the trim aside far enough to gain access to the bulb assembly (A).

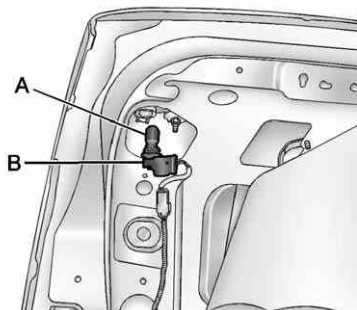

4. Turn the bulb socket (B) counterclockwise to remove it from the lamp assembly.
5. Pull the bulb (A) from the socket (B).
6. Install the new bulb.
7. Reverse Steps 1 through 4 to reinstall.

License Plate Lamp

To replace the license plate lamp bulb:

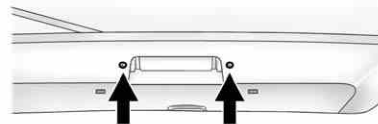

1. Remove the license plate bezel assembly by turning the two screws counterclockwise.
2. Turn and pull the license plate lamp assembly forward through the fascia opening.
3. Turn the bulb socket counterclockwise and pull the bulb straight out of the socket.

4. Push the new bulb in and turn it clockwise to install.
5. Reverse Steps 1 through 3 to reinstall.

Replacement Bulbs

Exterior Lamp	Bulb Number
Back-up Lamp	921
License Plate Lamp	168
Rear Turn Signal Lamp/Taillamp (LS and LT)	3157K LL
Rear LED Turn Signal Lamp/Taillamp (LTZ)	GM P/N 25874489

For replacement bulbs not listed here, contact the dealer.

Electrical System

Electrical System Overload

The vehicle has fuses and circuit breakers to protect against an electrical system overload.

When the current electrical load is too heavy, the circuit breaker opens and closes, protecting the circuit until the current load returns to normal or the problem is fixed. This greatly reduces the chance of circuit overload and fire caused by electrical problems.

Fuses and circuit breakers protect power devices in the vehicle.

Replace a bad fuse with a new one of the identical size and rating.

If there is a problem on the road and a fuse needs to be replaced, the same amperage fuse can be borrowed. Choose some feature of the vehicle that is not needed to use and replace it as soon as possible.

Headlamp Wiring

An electrical overload may cause the lamps to go on and off, or in some cases to remain off. Have the headlamp wiring checked right away if the lamps go on and off or remain off.

Windshield Wipers

If the wiper motor overheats due to heavy snow or ice, the windshield wipers will stop until the motor cools and will then restart.

Although the circuit is protected from electrical overload, overload due to heavy snow or ice may cause wiper linkage damage. Always clear ice and heavy snow from the windshield before using the windshield wipers.

If the overload is caused by an electrical problem and not snow or ice, be sure to get it fixed.

Fuses

The wiring circuits in the vehicle are protected from short circuits by fuses. This greatly reduces the chance of damage caused by electrical problems.

To check a fuse, look at the silver-colored band inside the fuse. If the band is broken or melted, replace the fuse. Be sure to replace a bad fuse with a new one of the identical size and rating.

Fuses of the same amperage can be temporarily borrowed from another fuse location, if a fuse goes out. Replace the fuse as soon as possible.

To identify and check fuses, circuit breakers, and relays, see *Engine Compartment Fuse Block on page 10-31*, *Instrument Panel Fuse Block on page 10-34*, and *Rear Compartment Fuse Block on page 10-36*.

Engine Compartment Fuse Block

The engine compartment fuse block is located on the driver side of the engine compartment, near the battery.

Notice: Spilling liquid on any electrical component on the vehicle may damage it. Always keep the covers on any electrical component.

10-32 Vehicle Care

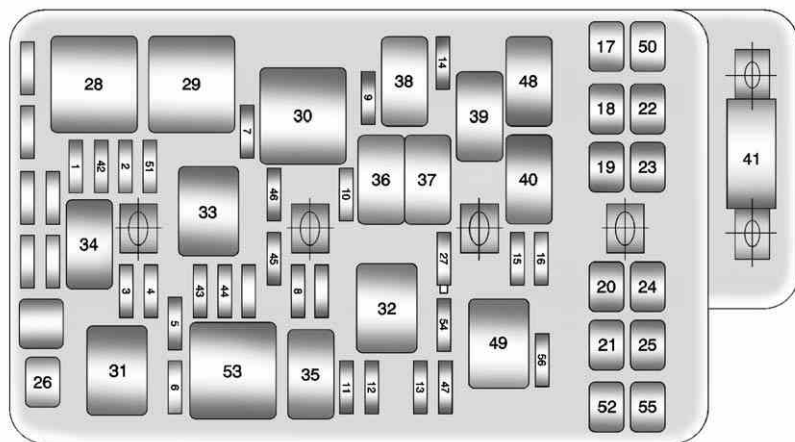

The vehicle may not be equipped with all of the fuses, relays, and features shown.

Fuses	Usage
1	Air Conditioner Clutch
2	Electronic Throttle Control
3	Not Used

Fuses	Usage
4	Transmission Control Module Ignition 1
5	Mass Airflow Sensor (LY7)
6	Emission

Fuses	Usage
7	Left Headlamp Low-Beam
8	Horn
9	Right Headlamp Low-Beam
10	Front Fog Lamps
11	Left Headlamp High-Beam
12	Right Headlamp High-Beam
13	Engine Control Module BATT
14	Windshield Wiper
15	Antilock Brake System (IGN 1)
16	Engine Control Module IGN 1
17	Cooling Fan 1
18	Cooling Fan 2

Fuses	Usage
19	Run Relay, Heating, Ventilation, Air Conditioning Blower
20	Body Control Module 1
21	Body Control Module Run/Crank
22	Rear Electrical Center 1
23	Rear Electrical Center 2
24	Antilock Brake System
25	Body Control Module 2
26	Starter
41	Electric Power Steering
42	Transmission Control Module Battery

Fuses	Usage
43	Ignition Module (LE9 & LE5); Injectors, Ignition Coils Odd (LY7)
44	Injectors (LE9 & LE5); Injectors, Ignition Coils Even (LY7)
45	Post Cat O2 Sensor Heaters (LY7)
46	Daytime Running Lamps
47	Center High-Mounted Stoplamp
50	Driver Power Window
51	Not Used
52	AIR Solenoid
54	Regulated Voltage Control
55	DC/AC Inverter
56	Antilock Brake System BATT

Relays	Usage
28	Cooling Fan 1
29	Cooling Fan Series/Parallel
30	Cooling Fan 2
31	Starter
32	Run/Crank, Ignition
33	Powertrain
34	Air Conditioning Clutch
35	High Beam
36	Front Fog Lamps
37	Horn
38	Low-Beam Headlamp
39	Windshield Wiper 1
40	Windshield Wiper 2
48	Daytime Running Lamps
49	Stoplamps
53	AIR Solenoid

10-34 Vehicle Care

Diodes	Usage
27	Wiper

Instrument Panel Fuse Block

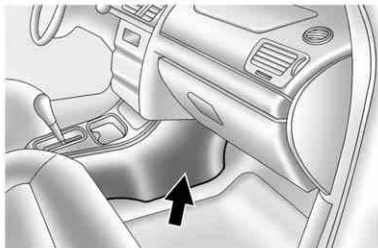

The instrument panel fuse block is located on the instrument panel near the floor on the passenger side of the vehicle.

Remove the panel cover to access the fuse block, then remove the fuse block cover to access the fuses.

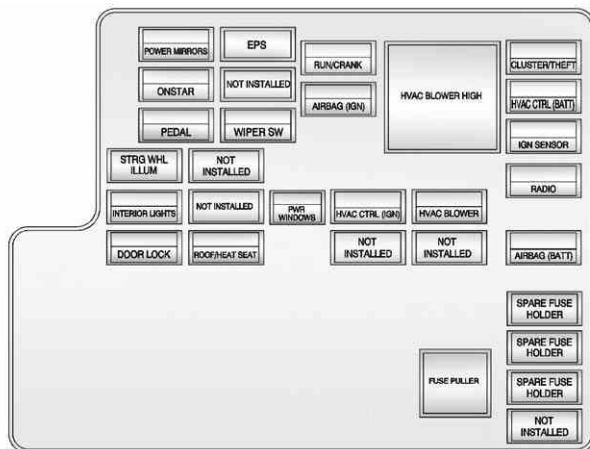

The vehicle may not be equipped with all of the fuses, relays and features shown.

Fuses	Usage
POWER MIRRORS	Power Mirrors
EPS	Electronic Power Steering

Fuses	Usage
RUN/CRANK	Cruise Control Switch, Passenger Airbag Status Indicator

Fuses	Usage
HVAC BLOWER HIGH	Heating Ventilation Air Conditioning Blower - High Speed Relay
CLUSTER / THEFT	Instrument Panel Cluster, Theft Deterrent System
ONSTAR	OnStar® (If Equipped)
NOT INSTALLED	Not Used
AIRBAG (IGN)	Airbag (Ignition)
HVAC CTRL (BATT)	Heating Ventilation Air Conditioning Control Diagnostic Link Connector (Battery)
PEDAL	Not Used
WIPER SW	Windshield Wiper/Washer Switch
IGN SENSOR	Ignition Switch

Fuses	Usage
STRG WHL ILLUM	Steering Wheel Illumination
NOT INSTALLED	Not Used
RADIO	Audio System
INTERIOR LIGHTS	Interior Lamps
NOT INSTALLED	Not Used
POWER WINDOWS	Power Windows
HVAC CTRL (IGN)	Heating Ventilation Air Conditioning Control (Ignition)
HVAC BLOWER	Heating Ventilation Air Conditioning Blower Switch
DOOR LOCK	Door Locks
ROOF/ HEAT SEAT	Sunroof, Heated Seat

Fuses	Usage
NOT INSTALLED	Not Used
NOT INSTALLED	Not Used
AIRBAG (BATT)	Airbag (Battery)
SPARE FUSE HOLDER	Spare Fuse Holder
SPARE FUSE HOLDER	Spare Fuse Holder
SPARE FUSE HOLDER	Spare Fuse Holder
SPARE FUSE HOLDER	Spare Fuse Holder
FUSE PULLER	Fuse Puller

Rear Compartment Fuse Block

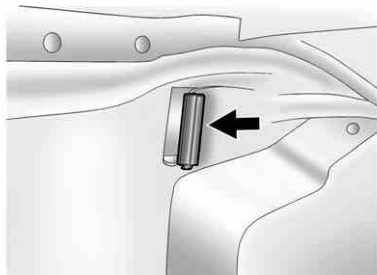

The rear compartment fuse block is located in the trunk of the vehicle. Access the fuse block through the trunk panel on the driver side of the rear cargo area.

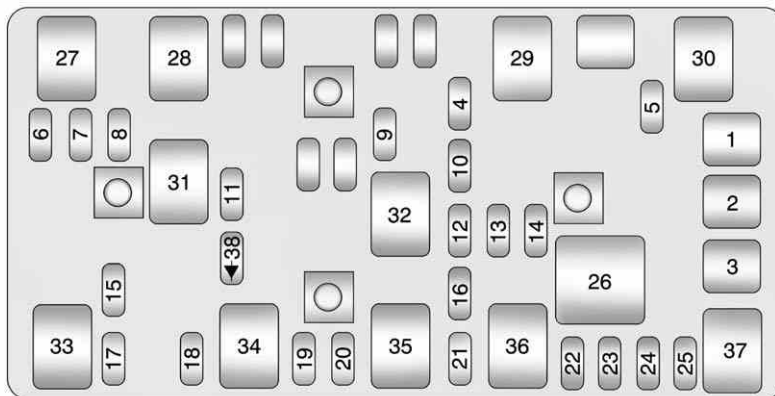

The vehicle may not be equipped with all of the fuses, relays, and features shown.

Fuses	Usage
1	Passenger Seat Controls
2	Driver Seat Controls
3	Not Used

Fuses	Usage
4	Not Used
5	Emission 2, Canister Vent Solenoid
6	Park Lamps, Instrument Panel Dimming

Fuses	Usage
7	Not Used
8	Not Used
9	Not Used
10	Sunroof Controls
11	Not Used
12	Not Used
13	Audio Amplifier
14	Heated Seat Controls
15	Not Used
16	Remote Keyless Entry (RKE) System, XM™ Satellite Radio (If Equipped)
17	Back-up Lamps
18	Not Used

Fuses	Usage
19	Not Used
20	Auxiliary Power Outlets
21	Not Used
22	Trunk Release
23	Rear Defog
24	Heated Mirrors
25	Fuel Pump

Relays	Usage
26	Rear Window Defogger
27	Park Lamps
28	Not Used
29	Not Used
30	Not Used

Relays	Usage
31	Not Used
32	Not Used
33	Back-up Lamps
34	Not Used
35	Not Used
36	Trunk Release
37	Fuel Pump
38 (Diode)	Cargo Lamp

Wheels and Tires

Tires

Every new GM vehicle has high-quality tires made by a leading tire manufacturer. See the warranty manual for information regarding the tire warranty and where to get service. For additional information refer to the tire manufacturer.

WARNING

- Poorly maintained and improperly used tires are dangerous.
- Overloading the tires can cause overheating as a result of too much flexing. There could be a blowout and a serious crash. See *Vehicle Load Limits* on page 9-10.

(Continued)

WARNING (Continued)

- Underinflated tires pose the same danger as overloaded tires. The resulting crash could cause serious injury. Check all tires frequently to maintain the recommended pressure. Tire pressure should be checked when the tires are cold.
- Overinflated tires are more likely to be cut, punctured, or broken by a sudden impact— such as when hitting a pothole. Keep tires at the recommended pressure.
- Worn or old tires can cause a crash. If the tread is badly worn, replace them.

(Continued)

WARNING (Continued)

- Replace any tires that have been damaged by impacts with potholes, curbs, etc.
- Improperly repaired tires can cause a crash. Only the dealer or an authorized tire service center should repair, replace, dismount, and mount the tires.
- Do not spin the tires in excess of 55 km/h (35 mph) on slippery surfaces such as snow, mud, ice, etc. Excessive spinning may cause the tires to explode.

See *Tire Pressure for High-Speed Operation* on page 10-46 for inflation pressure adjustment for high-speed driving.

Winter Tires

Consider installing winter tires on the vehicle if frequent driving on snow or ice covered roads is expected. All season tires provide good overall performance on most surfaces, but they may not offer the traction or the same level of performance as winter tires on snow or ice covered roads.

Winter tires, in general, are designed for increased traction on snow and ice covered roads. With winter tires, there may be decreased dry road traction, increased road noise, and shorter tread life. After changing to winter tires, be alert for changes in vehicle handling and braking.

See your dealer for details regarding winter tire availability and proper tire selection. Also, see *Buying New Tires on page 10-53*.

If using snow tires:

- Use tires of the same brand and tread type on all four wheel positions.
- Use only radial ply tires of the same size, load range, and speed rating as the original equipment tires.

Winter tires with the same speed rating as the original equipment tires may not be available for H, V, W, Y, and ZR speed rated tires. If winter tires with a lower speed rating are chosen, never exceed the tire's maximum speed capability.

Low-Profile Tires

If the vehicle has P225/50R18 or P225/50R17 size tires, they are classified as low-profile performance tires. These tires are designed for very responsive driving on wet or dry pavement, however, may produce more road noise and tend to wear faster.

Notice: Low-profile tires are more susceptible to damage from road hazards or curb impact than standard profile tires. Tire and/or wheel assembly damage can occur when coming into contact with road hazards like, potholes, or sharp edged objects, or when sliding into a curb. The warranty does not cover this type of damage. Keep tires set to the correct inflation pressure and, when possible, avoid contact with curbs, potholes, and other road hazards.

Tire Sidewall Labeling

Useful information about a tire is molded into its sidewall. The examples show a typical passenger vehicle tire and a compact spare tire sidewall.

10-40 Vehicle Care

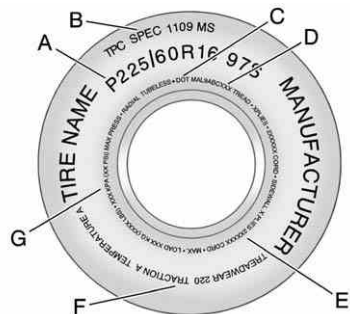

Passenger (P-Metric) Tire Example

(A) Tire Size: The tire size is a combination of letters and numbers used to define a particular tire's width, height, aspect ratio, construction type, and service description. See the "Tire Size" illustration later in this section for more detail.

(B) TPC Spec (Tire Performance Criteria Specification): Original equipment tires designed to GM's specific tire performance

criteria have a TPC specification code molded onto the sidewall. GM's TPC specifications meet or exceed all federal safety guidelines.

(C) DOT (Department of Transportation): The Department of Transportation (DOT) code indicates that the tire is in compliance with the U.S. Department of Transportation Motor Vehicle Safety Standards.

(D) Tire Identification Number (TIN): The letters and numbers following the DOT (Department of Transportation) code are the Tire Identification Number (TIN). The TIN shows the manufacturer and plant code, tire size, and date the tire was manufactured. The TIN is molded onto both sides of the tire, although only one side may have the date of manufacture.

(E) Tire Ply Material: The type of cord and number of plies in the sidewall and under the tread.

(F) Uniform Tire Quality Grading (UTQG): Tire manufacturers are required to grade tires based on three performance factors: treadwear, traction, and temperature resistance. For more information see *Uniform Tire Quality Grading on page 10-55*.

(G) Maximum Cold Inflation Load Limit: Maximum load that can be carried and the maximum pressure needed to support that load.

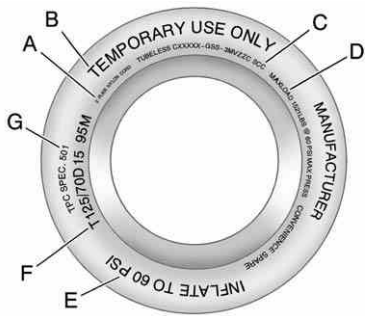

Compact Spare Tire Example

- (A) Tire Ply Material:** The type of cord and number of plies in the sidewall and under the tread.
- (B) Temporary Use Only:** The compact spare tire or temporary use tire has a tread life of approximately 5 000 km (3,000 mi) and should not be driven at speeds over 105 km/h (65 mph). The compact spare tire is for emergency use when a

regular road tire has lost air and gone flat. If the vehicle has a compact spare tire, see *Compact Spare Tire on page 10-75* and *If a Tire Goes Flat on page 10-58*.

(C) Tire Identification Number (TIN):

The letters and numbers following the DOT (Department of Transportation) code are the Tire Identification Number (TIN). The TIN shows the manufacturer and plant code, tire size, and date the tire was manufactured. The TIN is molded onto both sides of the tire, although only one side may have the date of manufacture.

(D) Maximum Cold Inflation Load Limit:

Maximum load that can be carried and the maximum pressure needed to support that load.

(E) Tire Inflation: The temporary use tire or compact spare tire should be inflated to 420 kPa (60 psi). For more information on tire pressure and inflation see *Tire Pressure on page 10-45*.

(F) Tire Size: A combination of letters and numbers define a tire's width, height, aspect ratio, construction type, and service description. The letter T as the first character in the tire size means the tire is for temporary use only.

(G) TPC Spec (Tire Performance Criteria Specification):

Original equipment tires designed to GM's specific tire performance criteria have a TPC specification code molded onto the sidewall. GM's TPC specifications meet or exceed all federal safety guidelines.

Tire Designations

Tire Size

The following is an example of a typical passenger vehicle tire size.

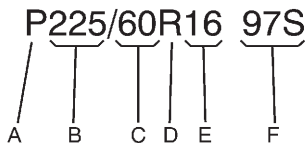

(A) Passenger (P-Metric) Tire:

The United States version of a metric tire sizing system. The letter P as the first character in the tire size means a passenger vehicle tire engineered to standards set by the U.S. Tire and Rim Association.

(B) Tire Width: The three-digit number indicates the tire section width in millimeters from sidewall to sidewall.

(C) Aspect Ratio: A two-digit number that indicates the tire height-to-width measurements. For example, if the tire size aspect ratio is 60, as shown in item C of the illustration, it would mean that the tire's sidewall is 60 percent as high as it is wide.

(D) Construction Code: A letter code is used to indicate the type of ply construction in the tire. The letter R means radial ply construction; the letter D means diagonal or bias ply construction; and the letter B means belted-bias ply construction.

(E) Rim Diameter: Diameter of the wheel in inches.

(F) Service Description: These characters represent the load index and speed rating of the tire. The load index represents the load carrying capacity a tire

is certified to carry. The speed rating is the maximum speed a tire is certified to carry a load.

Tire Terminology and Definitions

Air Pressure: The amount of air inside the tire pressing outward on each square inch of the tire. Air pressure is expressed in kPa (kilopascal) or psi (pounds per square inch).

Accessory Weight: The combined weight of optional accessories. Some examples of optional accessories are automatic transmission, power steering, power brakes, power windows, power seats, and air conditioning.

Aspect Ratio: The relationship of a tire's height to its width.

Belt: A rubber coated layer of cords that is located between the plies and the tread. Cords may be made from steel or other reinforcing materials.

Bead: The tire bead contains steel wires wrapped by steel cords that hold the tire onto the rim.

Bias Ply Tire: A pneumatic tire in which the plies are laid at alternate angles less than 90 degrees to the centerline of the tread.

Cold Tire Pressure: The amount of air pressure in a tire, measured in kPa (kilopascal) or psi (pounds per square inch) before a tire has built up heat from driving. See *Tire Pressure on page 10-45*.

Curb Weight: The weight of a motor vehicle with standard and optional equipment including the

maximum capacity of fuel, oil, and coolant, but without passengers and cargo.

DOT Markings: A code molded into the sidewall of a tire signifying that the tire is in compliance with the U.S. Department of Transportation (DOT) Motor Vehicle Safety Standards. The DOT code includes the Tire Identification Number (TIN), an alphanumeric designator which can also identify the tire manufacturer, production plant, brand, and date of production.

GVWR: Gross Vehicle Weight Rating. See *Vehicle Load Limits on page 9-10*.

GAWR FRT: Gross Axle Weight Rating for the front axle. See *Vehicle Load Limits on page 9-10*.

GAWR RR: Gross Axle Weight Rating for the rear axle. See *Vehicle Load Limits on page 9-10*.

Intended Outboard Sidewall: The side of an asymmetrical tire, that must always face outward when mounted on a vehicle.

Kilopascal (kPa): The metric unit for air pressure.

Light Truck (LT-Metric) Tire: A tire used on light duty trucks and some multipurpose passenger vehicles.

Load Index: An assigned number ranging from 1 to 279 that corresponds to the load carrying capacity of a tire.

Maximum Inflation Pressure: The maximum air pressure to which a cold tire can be inflated. The maximum air pressure is molded onto the sidewall.

Maximum Load Rating: The load rating for a tire at the maximum permissible inflation pressure for that tire.

Maximum Loaded Vehicle Weight: The sum of curb weight, accessory weight, vehicle capacity weight, and production options weight.

Normal Occupant Weight: The number of occupants a vehicle is designed to seat multiplied by 68 kg (150 lbs). See *Vehicle Load Limits* on page 9-10.

Occupant Distribution: Designated seating positions.

Outward Facing Sidewall: The side of an asymmetrical tire that has a particular side that faces outward when mounted on a vehicle. The side of the tire that contains a whitewall, bears white lettering, or bears manufacturer, brand, and/or

model name molding that is higher or deeper than the same moldings on the other sidewall of the tire.

Passenger (P-Metric) Tire: A tire used on passenger cars and some light duty trucks and multipurpose vehicles.

Recommended Inflation Pressure: Vehicle manufacturer's recommended tire inflation pressure as shown on the tire placard. See *Tire Pressure* on page 10-45 and *Vehicle Load Limits* on page 9-10.

Radial Ply Tire: A pneumatic tire in which the ply cords that extend to the beads are laid at 90 degrees to the centerline of the tread.

Rim: A metal support for a tire and upon which the tire beads are seated.

Sidewall: The portion of a tire between the tread and the bead.

Speed Rating: An alphanumeric code assigned to a tire indicating the maximum speed at which a tire can operate.

Traction: The friction between the tire and the road surface. The amount of grip provided.

Tread: The portion of a tire that comes into contact with the road.

Treadwear Indicators: Narrow bands, sometimes called wear bars, that show across the tread of a tire when only 1.6 mm (1/16 in) of tread remains. See *When It Is Time for New Tires* on page 10-52.

UTQGS (Uniform Tire Quality Grading Standards): A tire information system that provides consumers with ratings for a

tire's traction, temperature, and treadwear. Ratings are determined by tire manufacturers using government testing procedures. The ratings are molded into the sidewall of the tire. See *Uniform Tire Quality Grading on page 10-55*.

Vehicle Capacity Weight: The number of designated seating positions multiplied by 68 kg (150 lbs) plus the rated cargo load. See *Vehicle Load Limits on page 9-10*.

Vehicle Maximum Load on the Tire: Load on an individual tire due to curb weight, accessory weight, occupant weight, and cargo weight.

Vehicle Placard: A label permanently attached to a vehicle showing the vehicle capacity weight and the original equipment tire size and

recommended inflation pressure. See "Tire and Loading Information Label" under *Vehicle Load Limits on page 9-10*.

Tire Pressure

Tires need the correct amount of air pressure to operate effectively.

Notice: Neither tire underinflation nor overinflation is good. Underinflated tires, or tires that do not have enough air, can result in:

- **Tire overloading and overheating which could lead to a blowout.**
- **Premature or irregular wear.**
- **Poor handling.**
- **Reduced fuel economy.**

Overinflated tires, or tires that have too much air, can result in:

- **Unusual wear.**
- **Poor handling.**
- **Rough ride.**
- **Needless damage from road hazards.**

The Tire and Loading Information label on the vehicle indicates the original equipment tires and the correct cold tire inflation pressures. The recommended pressure is the minimum air pressure needed to support the vehicle's maximum load carrying capacity.

For additional information regarding how much weight the vehicle can carry, and an example of the Tire and Loading

Information label, see *Vehicle Load Limits* on page 9-10. How the vehicle is loaded affects vehicle handling and ride comfort. Never load the vehicle with more weight than it was designed to carry.

When to Check

Check the tires once a month or more. Do not forget the compact spare tire, if the vehicle has one. The cold compact spare should be at 420 kPa (60 psi). For additional information regarding the compact spare tire, see *Compact Spare Tire* on page 10-75.

How to Check

Use a good quality pocket-type gauge to check tire pressure. Proper tire inflation cannot be determined by looking at the tire. Check the tire inflation pressure when the tires are cold, meaning

the vehicle has not been driven for at least three hours or no more than 1.6 km (1 mi).

Remove the valve cap from the tire valve stem. Press the tire gauge firmly onto the valve to get a pressure measurement. If the cold tire inflation pressure matches the recommended pressure on the Tire and Loading Information label, no further adjustment is necessary. If the inflation pressure is low, add air until the recommended pressure is reached. If the inflation pressure is high, press on the metal stem in the center of the tire valve to release air.

Recheck the tire pressure with the tire gauge.

Return the valve caps on the valve stems to prevent leaks and keep out dirt and moisture.

Tire Pressure for High-Speed Operation



Driving at high speeds, 160 km/h (100 mph) or higher, puts an additional strain on tires. Sustained high-speed driving causes excessive heat buildup and can cause sudden tire failure. You could have a crash and you or others could be killed. Some high-speed rated tires require inflation pressure adjustment for high-speed operation. When speed limits and road conditions are such that a vehicle can be driven at high speeds, make sure the tires are rated for high-speed operation, in excellent condition, and set to the correct cold tire inflation pressure for the vehicle load.

Set the cold tire inflation pressure to 241 kPa (35 psi) for the front and rear tires, when operating the vehicle at high-speeds. Return the tires to the recommended cold tire inflation pressure when high-speed driving has ended. See *Vehicle Load Limits* on page 9-10 and *Tire Pressure* on page 10-45.

Tire Pressure Monitor System

The Tire Pressure Monitor System (TPMS) uses radio and sensor technology to check tire pressure levels. The TPMS sensors monitor the air pressure in your tires and transmit tire pressure readings to a receiver located in the vehicle.

Each tire, including the spare (if provided), should be checked monthly when cold and inflated to the inflation pressure recommended by the vehicle manufacturer on the vehicle placard or tire inflation pressure label. (If your vehicle has tires of a different size than the size

indicated on the vehicle placard or tire inflation pressure label, you should determine the proper tire inflation pressure for those tires.)

As an added safety feature, your vehicle has been equipped with a tire pressure monitoring system (TPMS) that illuminates a low tire pressure telltale when one or more of your tires is significantly under-inflated.

Accordingly, when the low tire pressure telltale illuminates, you should stop and check your tires as soon as possible, and inflate them to the proper pressure. Driving on a significantly under-inflated tire causes the tire to overheat and can lead to tire failure. Under-inflation also reduces fuel efficiency and tire tread life, and may affect the vehicle's handling and stopping ability.

Please note that the TPMS is not a substitute for proper tire maintenance, and it is the driver's responsibility to maintain correct tire

pressure, even if under-inflation has not reached the level to trigger illumination of the TPMS low tire pressure telltale.

Your vehicle has also been equipped with a TPMS malfunction indicator to indicate when the system is not operating properly. The TPMS malfunction indicator is combined with the low tire pressure telltale. When the system detects a malfunction, the telltale will flash for approximately one minute and then remain continuously illuminated. This sequence will continue upon subsequent vehicle start-ups as long as the malfunction exists.

When the malfunction indicator is illuminated, the system may not be able to detect or signal low tire pressure as intended. TPMS malfunctions may occur for a variety of reasons, including the installation of replacement or alternate tires or wheels on the vehicle that prevent the TPMS from functioning properly. Always check the TPMS malfunction telltale after replacing one or more

tires or wheels on your vehicle to ensure that the replacement or alternate tires and wheels allow the TPMS to continue to function properly.

See *Tire Pressure Monitor Operation* on page 10-48 for additional information.

Federal Communications Commission (FCC) Rules and with Industry Canada Standards

See *Radio Frequency Statement* on page 13-20 for information regarding Part 15 of the Federal Communications Commission (FCC) Rules and with Industry Canada Standards RSS-GEN/210/220/310.

Tire Pressure Monitor Operation

This vehicle may have a Tire Pressure Monitor System (TPMS). The TPMS is designed to warn the driver when a low tire pressure condition exists. TPMS sensors are

mounted onto each tire and wheel assembly, excluding the spare tire and wheel assembly. The TPMS sensors monitor the air pressure in the tires and transmits the tire pressure readings to a receiver located in the vehicle.



When a low tire pressure condition is detected, the TPMS turns on the low tire pressure warning light located on the instrument cluster. If the warning light comes on, stop as soon as possible and inflate the tires to the recommended pressure shown on the tire loading information label. See *Vehicle Load Limits* on page 9-10.

A message to check the pressure in a specific tire displays in the Driver Information Center (DIC). The low tire pressure warning light and the

DIC warning message come on at each ignition cycle until the tires are inflated to the correct inflation pressure. Using the DIC, tire pressure levels can be viewed. For additional information and details about the DIC operation and displays see *Tire Messages* on page 5-28.

The low tire pressure warning light may come on in cool weather when the vehicle is first started, and then turn off as the vehicle is driven. This could be an early indicator that the air pressure is getting low and needs to be inflated to the proper pressure.

A Tire and Loading Information label shows the size of the original equipment tires and the correct inflation pressure for the tires when they are cold. See *Vehicle Load Limits* on page 9-10, for an example of the Tire and Loading Information label and its location. Also see *Tire Pressure* on page 10-45.

The TPMS system can warn about a low tire pressure condition but it does not replace normal tire maintenance. See *Tire Inspection on page 10-51*, *Tire Rotation on page 10-51* and *Tires on page 10-38*.

Notice: Tire sealant materials are not all the same. A non-approved tire sealant could damage the TPMS sensors. TPMS sensor damage caused by using an incorrect tire sealant is not covered by the vehicle warranty. Always use only the GM-approved tire sealant available through your dealer or included in the vehicle.

Factory-installed Tire Inflator Kits use a GM approved liquid tire sealant. Using non-approved tire sealants could damage the TPMS sensors. See *Tire Sealant and Compressor Kit on page 10-60* for information regarding the inflator kit materials and instructions.

TPMS Malfunction Light and Message

The TPMS will not function properly if one or more of the TPMS sensors are missing or inoperable. When the system detects a malfunction, the low tire pressure warning light flashes for about one minute and then stays on for the remainder of the ignition cycle. A DIC warning message also displays. The malfunction light and DIC warning message come on at each ignition cycle until the problem is corrected. Some of the conditions that can cause these to come on are:

- One of the road tires has been replaced with the spare tire. The spare tire does not have a TPMS sensor. The malfunction light and the DIC message should go off after the road tire is replaced and the sensor matching process is performed successfully. See "TPMS Sensor Matching Process" later in this section.
- The TPMS sensor matching process was not done or not completed successfully after rotating the tires. The malfunction light and the DIC message should go off after successfully completing the sensor matching process. See "TPMS Sensor Matching Process" later in this section.
- One or more TPMS sensors are missing or damaged. The malfunction light and the DIC message should go off when the TPMS sensors are installed and the sensor matching process is performed successfully. See your dealer for service.
- Replacement tires or wheels do not match the original equipment tires or wheels. Tires and wheels other than those recommended could prevent the TPMS from functioning properly. See *Buying New Tires on page 10-53*.

- Operating electronic devices or being near facilities using radio wave frequencies similar to the TPMS could cause the TPMS sensors to malfunction.

If the TPMS is not functioning properly, it cannot detect or signal a low tire condition. See your dealer for service if the TPMS malfunction light and DIC message come on and stay on.

TPMS Sensor Matching Process

Each TPMS sensor has a unique identification code. The identification code needs to be matched to a new tire/wheel position after rotating the vehicle's tires or replacing one or more of the TPMS sensors. The TPMS sensor matching process should also be performed after replacing a spare tire with a road tire containing the TPMS sensor. The malfunction light and the DIC message should go off at the next ignition cycle. The sensors are matched to the tire/wheel positions,

using a TPMS relearn tool, in the following order: driver side front tire, passenger side front tire, passenger side rear tire, and driver side rear. See your dealer for service or to purchase a relearn tool.

There are two minutes to match the first tire/wheel position, and five minutes overall to match all four tire/wheel positions. If it takes longer, the matching process stops and must be restarted.

The TPMS matching process is:

1. Set the parking brake.
2. Turn the ignition to ON/RUN with the engine off.
3. Press and hold the Remote Keyless Entry (RKE) transmitter's LOCK and UNLOCK buttons, at the same time, for about five seconds to start the TPMS learn mode. The horn sounds twice indicating the TPMS receiver is ready and in learn mode.
4. Start with the driver side front tire. The driver side front turn signal also comes on to indicate that corner's sensor is ready to be learned.
5. Place the relearn tool against the tire sidewall, near the valve stem. Then press the button to activate the TPMS sensor. A horn chirp confirms that the sensor identification code has been matched to this tire and wheel position.
6. The passenger side front turn signal comes on to indicate that corner sensor is ready to be learned. Proceed to the passenger side front tire and repeat the procedure in Step 5.
7. The passenger side rear turn signal comes on to indicate that corner sensor is ready to be learned. Proceed to the passenger side rear tire and repeat the procedure in Step 5.

8. The driver side rear turn signal comes on to indicate that corner sensor is ready to be learned. Proceed to the driver side rear tire, and repeat the procedure in Step 5.
9. After hearing the single horn chirp for the driver side rear tire, two additional horn chirps sound to indicate the tire learning process is done. Turn the ignition switch to LOCK/OFF.

If no tires are learned after entering the TPMS learn mode, or if communication with the receiver stops, or if the time limit has expired, turn the ignition switch to LOCK/OFF and start over beginning with Step 2.
10. Set all four tires to the recommended air pressure level as indicated on the Tire and Loading Information label.

Tire Inspection

We recommend that the tires, including the spare tire, if the vehicle has one, be inspected for signs of wear or damage at least once a month.

Replace the tire if:

- The indicators at three or more places around the tire can be seen.
- There is cord or fabric showing through the tire's rubber.
- The tread or sidewall is cracked, cut, or snagged deep enough to show cord or fabric.
- The tire has a bump, bulge, or split.

- The tire has a puncture, cut, or other damage that cannot be repaired well because of the size or location of the damage.

Tire Rotation

Tires should be rotated every 12 000 km (7,500 mi). See *Maintenance Schedule on page 11-3*.

Tires are rotated to achieve a uniform wear for all tires. The first rotation is the most important.

Any time unusual wear is noticed, rotate the tires as soon as possible and check the wheel alignment. Also check for damaged tires or wheels. See *When It Is Time for New Tires on page 10-52* and *Wheel Replacement on page 10-57*.

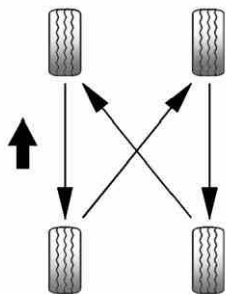

Use this rotation pattern when rotating the tires.

Do not include the compact spare tire in the tire rotation.

Adjust the front and rear tires to the recommended inflation pressure on the Tire and Loading Information label after the tires have been rotated. See *Tire Pressure* on page 10-45 and *Vehicle Load Limits* on page 9-10.

Reset the Tire Pressure Monitor System. See *Tire Pressure Monitor Operation* on page 10-48.

Check that all wheel nuts are properly tightened. See “Wheel Nut Torque” under *Capacities and Specifications* on page 12-2.

WARNING

Rust or dirt on a wheel, or on the parts to which it is fastened, can make wheel nuts become loose after time. The wheel could come off and cause an accident. When changing a wheel, remove any rust or dirt from places where the wheel attaches to the vehicle. In an emergency, a cloth or a paper towel can be used; however, use a scraper or wire brush later to remove all rust or dirt.

Lightly coat the center of the wheel hub with wheel bearing grease after a wheel change or tire rotation to prevent corrosion or rust build-up. Do not get grease on the flat wheel mounting surface or on the wheel nuts or bolts.

When It Is Time for New Tires

Factors such as maintenance, temperatures, driving speeds, vehicle loading, and road conditions affect the wear rate of the tires.

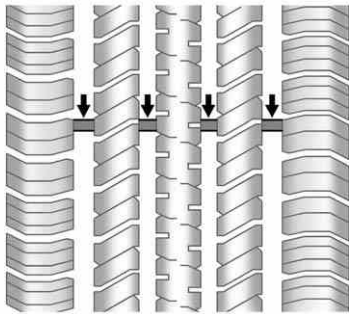

Treadwear indicators are one way to tell when it is time for new tires. Treadwear indicators appear when the tires have only 1.6 mm (1/16 in) or less of tread remaining. See *Tire Inspection on page 10-51* and *Tire Rotation on page 10-51* for more information.

The rubber in tires ages over time. This also applies for the spare tire, if the vehicle has one, even if it is never used. Multiple conditions including temperatures, loading conditions, and inflation pressure

maintenance affect how fast aging takes place. Tires will typically need to be replaced due to wear before they may need to be replaced due to age. Consult the tire manufacturer for more information on when tires should be replaced.

Vehicle Storage

Tires age when stored normally mounted on a parked vehicle. Park a vehicle that will be stored for at least a month in a cool, dry, clean area away from direct sunlight to slow aging. This area should be free of grease, gasoline, or other substances that can deteriorate rubber.

Parking for an extended period can cause flat spots on the tires that may result in vibrations while driving. When storing a vehicle for at least a month, remove the tires or raise the vehicle to reduce the weight from the tires.

Buying New Tires

GM has developed and matched specific tires for the vehicle. The original equipment tires installed were designed to meet General Motors Tire Performance Criteria Specification (TPC Spec) system rating. When replacement tires are needed, GM strongly recommends buying tires with the same TPC Spec rating.

GM's exclusive TPC Spec system considers over a dozen critical specifications that impact the overall performance of the vehicle, including brake system performance, ride and handling, traction control, and tire pressure monitoring performance. GM's TPC Spec number is molded onto the tire's sidewall near the tire size. If the tires have an all-season tread design, the TPC Spec number

10-54 Vehicle Care

will be followed by MS for mud and snow. See *Tire Sidewall Labeling on page 10-39* for additional information.

GM recommends replacing all the tires at the same time. Uniform tread depth on all tires will help to maintain the performance of the vehicle. Braking and handling performance may be adversely affected if all the tires are not replaced at the same time. See *Tire Inspection on page 10-51* and *Tire Rotation on page 10-51* for information on proper tire rotation.

WARNING

Tires could explode during improper service. Attempting to mount or dismount a tire could cause injury or death.

(Continued)

WARNING (Continued)

Only your dealer or authorized tire service center should mount or dismount the tires.

WARNING

Mixing tires of different sizes, brands, or types may cause loss of control of the vehicle, resulting in a crash or other vehicle damage. Use the correct size, brand, and type of tires on all wheels.

WARNING

Using bias-ply tires on the vehicle may cause the wheel rim flanges to develop cracks after many miles of driving.

(Continued)

WARNING (Continued)

A tire and/or wheel could fail suddenly and cause a crash. Use only radial-ply tires with the wheels on the vehicle.

If the vehicle tires must be replaced with a tire that does not have a TPC Spec number, make sure they are the same size, load range, speed rating, and construction (radial) as the original tires.

Vehicles that have a tire pressure monitoring system could give an inaccurate low-pressure warning if non-TPC Spec rated tires are installed. See *Tire Pressure Monitor System on page 10-47*.

The Tire and Loading Information label indicates the original equipment tires on the vehicle. See *Vehicle Load Limits on page 9-10* for the label location and more information about the Tire and Loading Information label.

Different Size Tires and Wheels

If wheels or tires are installed that are a different size than the original equipment wheels and tires, vehicle performance, including its braking, ride and handling characteristics, stability, and resistance to rollover may be affected. If the vehicle has electronic systems such as antilock brakes, rollover airbags, traction control, and electronic stability control, the performance of these systems can also be affected.

WARNING

If different sized wheels are used, there may not be an acceptable level of performance and safety if tires not recommended for those wheels are selected. This increases the chance of a crash and serious injury. Only use GM specific wheel and tire systems developed for the vehicle, and have them properly installed by a GM certified technician.

See *Buying New Tires on page 10-53* and *Accessories and Modifications on page 10-3* for additional information.

Uniform Tire Quality Grading

Quality grades can be found where applicable on the tire sidewall between tread shoulder and maximum section width. For example:

Treadwear 200 Traction AA Temperature A

The following information relates to the system developed by the United States National Highway Traffic Safety Administration (NHTSA), which grades tires by treadwear, traction, and temperature performance. This applies only to vehicles sold in the United States. The grades are molded on the sidewalls of most passenger car tires. The Uniform Tire Quality Grading (UTQG) system does not apply to deep tread, winter-type snow tires, space-saver, or temporary

use spare tires, tires with nominal rim diameters of 10 to 12 inches (25 to 30 cm), or to some limited-production tires.

While the tires available on General Motors passenger cars and light trucks may vary with respect to these grades, they must also conform to federal safety requirements and additional General Motors Tire Performance Criteria (TPC) standards.

All Passenger Car Tires Must Conform to Federal Safety Requirements In Addition To These Grades.

Treadwear

The treadwear grade is a comparative rating based on the wear rate of the tire when tested under controlled conditions on a specified government test

course. For example, a tire graded 150 would wear one and a half (1½) times as well on the government course as a tire graded 100. The relative performance of tires depends upon the actual conditions of their use, however, and may depart significantly from the norm due to variations in driving habits, service practices and differences in road characteristics and climate.

Traction – AA, A, B, C

The traction grades, from highest to lowest, are AA, A, B, and C. Those grades represent the tire's ability to stop on wet pavement as measured under controlled conditions on specified government test surfaces of asphalt and concrete. A tire marked C may have poor traction performance. Warning: The traction grade

assigned to this tire is based on straight-ahead braking traction tests, and does not include acceleration, cornering, hydroplaning, or peak traction characteristics.

Temperature – A, B, C

The temperature grades are A (the highest), B, and C, representing the tire's resistance to the generation of heat and its ability to dissipate heat when tested under controlled conditions on a specified indoor laboratory test wheel. Sustained high temperature can cause the material of the tire to degenerate and reduce tire life, and excessive temperature can lead to sudden tire failure. The grade C corresponds to a level of performance which all passenger car tires must meet under the Federal Motor Safety Standard No. 109. Grades B and

A represent higher levels of performance on the laboratory test wheel than the minimum required by law. Warning: The temperature grade for this tire is established for a tire that is properly inflated and not overloaded. Excessive speed, underinflation, or excessive loading, either separately or in combination, can cause heat buildup and possible tire failure.

Wheel Alignment and Tire Balance

The tires and wheels were aligned and balanced at the factory to provide the longest tire life and best overall performance. Adjustments to wheel alignment and tire balancing will not be necessary on a regular basis. However, check the alignment if there is unusual tire wear or if the vehicle is pulling to one side or the other. If the vehicle vibrates when driving on a smooth

road, the tires and wheels might need to be rebalanced. See your dealer for proper diagnosis.

Wheel Replacement

Replace any wheel that is bent, cracked, or badly rusted or corroded. If wheel nuts keep coming loose, the wheel, wheel bolts, and wheel nuts should be replaced. If the wheel leaks air, replace it. Some aluminum wheels can be repaired. See your dealer if any of these conditions exist.

Your dealer will know the kind of wheel that is needed.

Each new wheel should have the same load-carrying capacity, diameter, width, offset, and be mounted the same way as the one it replaces.

Replace wheels, wheel bolts, wheel nuts, or Tire Pressure Monitor System (TPMS) sensors with new GM original equipment parts.

WARNING

Using the wrong replacement wheels, wheel bolts, or wheel nuts can be dangerous. It could affect the braking and handling of the vehicle. Tires can lose air, and cause loss of control, causing a crash. Always use the correct wheel, wheel bolts, and wheel nuts for replacement.

Notice: The wrong wheel can also cause problems with bearing life, brake cooling, speedometer or odometer calibration, headlamp aim, bumper height, vehicle ground clearance, and tire or tire chain clearance to the body and chassis.

See *If a Tire Goes Flat* on page 10-58 for more information.

Used Replacement Wheels

 **WARNING**

Replacing a wheel with a used one is dangerous. How it has been used or how far it has been driven may be unknown. It could fail suddenly and cause a crash. When replacing wheels, use a new GM original equipment wheel.

Tire Chains

 **WARNING**

Do not use tire chains. There is not enough clearance. Tire chains used on a vehicle without the proper amount of clearance can cause damage to the brakes,

(Continued)

WARNING (Continued)

suspension, or other vehicle parts. The area damaged by the tire chains could cause loss of control and a crash.

Use another type of traction device only if its manufacturer recommends it for the vehicle's tire size combination and road conditions. Follow that manufacturer's instructions. To avoid vehicle damage, drive slow and readjust or remove the traction device if it contacts the vehicle. Do not spin the wheels. If traction devices are used, install them on the front tires.

If a Tire Goes Flat

It is unusual for a tire to blow out while driving, especially if the tires are maintained properly. See *Tires on page 10-38*. If air goes out of a tire, it is much more likely to leak out slowly. But if there is ever a blowout, here are a few tips about what to expect and what to do:

If a front tire fails, the flat tire creates a drag that pulls the vehicle toward that side. Take your foot off the accelerator pedal and grip the steering wheel firmly. Steer to maintain lane position, and then gently brake to a stop, well off the road, if possible.

A rear blowout, particularly on a curve, acts much like a skid and may require the same correction as used in a skid. Stop pressing the accelerator pedal and steer to straighten the vehicle. It may be very bumpy and noisy. Gently brake to a stop, well off the road, if possible.

 **WARNING**

Driving on a flat tire will cause permanent damage to the tire. Re-inflating a tire after it has been driven on while severely underinflated or flat may cause a blowout and a serious crash. Never attempt to re-inflate a tire that has been driven on while severely underinflated or flat. Have your dealer or an authorized tire service center repair or replace the flat tire as soon as possible.

 **WARNING**

Lifting a vehicle and getting under it to do maintenance or repairs is dangerous without the appropriate safety equipment and training. If a jack is provided with the vehicle, it is designed only for changing a flat tire. If it is used for anything else, you or others could be badly injured or killed if the vehicle slips off the jack. If a jack is provided with the vehicle, only use it for changing a flat tire.

If a tire goes flat, avoid further tire and wheel damage by driving slowly to a level place, well off the road, if possible. Turn on the hazard warning flashers. See *Hazard Warning Flashers on page 6-4*.

 **WARNING**

Changing a tire can be dangerous. The vehicle can slip off the jack and roll over or fall causing injury or death. Find a level place to change the tire. To help prevent the vehicle from moving:

1. Set the parking brake firmly.
2. Put an automatic transmission in P (Park) or a manual transmission in 1 (First) or R (Reverse).
3. Turn off the engine and do not restart while the vehicle is raised.
4. Do not allow passengers to remain in the vehicle.
5. Place wheel blocks on both sides of the tire at the opposite corner of the tire being changed.

10-60 Vehicle Care

This vehicle may come with a jack and spare tire or a tire sealant and compressor kit. To use the jacking equipment to change a spare tire safely, follow the instructions below. Then see *Tire Changing on page 10-66*. To use the tire sealant and compressor kit, see *Tire Sealant and Compressor Kit on page 10-60*.

When the vehicle has a flat tire (B), use the following example as a guide to assist you in the placement of wheel blocks (A).

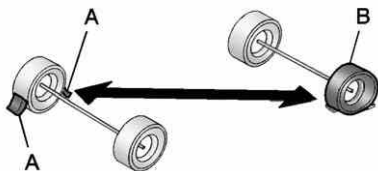

- A. Wheel Block
- B. Flat Tire

The following information explains how to repair or change a tire.

Tire Sealant and Compressor Kit

⚠ WARNING

Idling a vehicle in an enclosed area with poor ventilation is dangerous. Engine exhaust may enter the vehicle. Engine exhaust contains carbon monoxide (CO) which cannot be seen or smelled. It can cause unconsciousness and even death. Never run the engine in an enclosed area that has no fresh air ventilation. For more information, see *Engine Exhaust on page 9-21*.

⚠ WARNING

Overinflating a tire could cause the tire to rupture and you or others could be injured. Be sure to read and follow the tire sealant and compressor kit instructions and inflate the tire to its recommended pressure. Do not exceed the recommended pressure.

⚠ WARNING

Storing the tire sealant and compressor kit or other equipment in the passenger compartment of the vehicle could cause injury. In a sudden stop or collision, loose equipment could strike someone. Store the tire sealant and compressor kit in its original location.

If this vehicle has a tire sealant and compressor kit, there may not be a spare tire, tire changing equipment, and on some vehicles there may not be a place to store a tire.

The tire sealant and compressor can be used to temporarily seal punctures up to 6 mm (¼ in) in the tread area of the tire. It can also be used to inflate an under inflated tire.

If the tire has been separated from the wheel, has damaged sidewalls, or has a large puncture, the tire is too severely damaged for the tire sealant and compressor kit to be effective. See *Roadside Assistance Program (U.S. and Canada)* on page 13-7 or *Roadside Assistance Program (Mexico)* on page 13-9.

Read and follow all of the tire sealant and compressor kit instructions.

The kit includes:

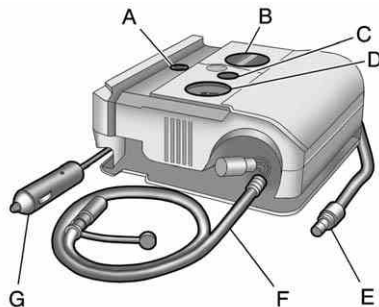

- A. On/Off Button
- B. Selector Switch (Sealant/Air or Air Only)
- C. Pressure Relief Button
- D. Pressure Gauge
- E. Air Only Hose (Black)
- F. Sealant/Air Hose (Clear)
- G. Power Plug

Tire Sealant

Read and follow the safe handling instructions on the label adhered to the compressor.

Check the tire sealant expiration date on the sealant canister. The sealant canister should be replaced before its expiration date. Replacement sealant canisters are available at your local dealer. See "Removal and Installation of the Sealant Canister" following.

There is only enough sealant to seal one tire. After usage, the sealant canister and sealant/air hose assembly must be replaced. See "Removal and Installation of the Sealant Canister" following.

Using the Tire Sealant and Compressor Kit to Temporarily Seal and Inflate a Punctured Tire

Follow the directions closely for correct sealant usage.

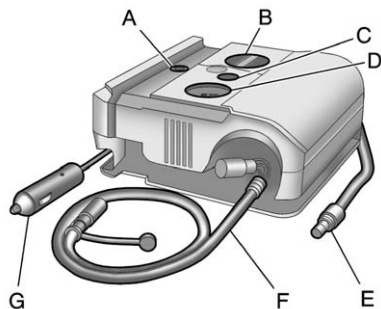

When using the tire sealant and compressor kit during cold temperatures, warm the kit in a heated environment for five minutes. This will help to inflate the tire faster.

If a tire goes flat, avoid further tire and wheel damage by driving slowly to a level place. Turn on the hazard warning flashers. See *Hazard Warning Flashers* on page 6-4.

See *If a Tire Goes Flat* on page 10-58 for other important safety warnings.

Do not remove any objects that have penetrated the tire.

1. Remove the tire sealant and compressor kit from its storage location. See *Storing the Tire Sealant and Compressor Kit* on page 10-66.

2. Unwrap the sealant/air hose (F) and the power plug (G).

3. Place the kit on the ground.

Make sure the tire valve stem is positioned close to the ground so the hose will reach it.

4. Remove the valve stem cap from the flat tire by turning it counterclockwise.

5. Attach the sealant/air hose (F) onto the tire valve stem. Turn it clockwise until it is tight.

6. Plug the power plug (G) into the accessory power outlet in the vehicle. Unplug all items from other accessory power outlets. See *Power Outlets* on page 5-7.

If the vehicle has an accessory power outlet, do not use the cigarette lighter.

If the vehicle only has a cigarette lighter, use the cigarette lighter.

Do not pinch the power plug cord in the door or window.

7. Start the vehicle. The vehicle must be running while using the air compressor.

8. Turn the selector switch (B) clockwise to the Sealant + Air position.

9. Press the on/off (A) button to turn the tire sealant and compressor kit on.

The compressor will inject sealant and air into the tire.

The pressure gauge (D) will initially show a high pressure while the compressor pushes the sealant into the tire. Once the sealant is completely dispersed into the tire, the pressure will

quickly drop and start to rise again as the tire inflates with air only.

10. Inflate the tire to the recommended inflation pressure using the pressure gauge (D). The recommended inflation pressure can be found on the Tire and Loading Information label. See *Tire Pressure on page 10-45*.

The pressure gauge (D) may read higher than the actual tire pressure while the compressor is on. Turn the compressor off to get an accurate pressure reading. The compressor may be turned on/off until the correct pressure is reached.

Notice: If the recommended pressure cannot be reached after approximately 25 minutes, the vehicle should not be driven farther. The tire is too severely damaged and the tire sealant and compressor kit cannot inflate the tire. Remove the power plug from

the accessory power outlet and unscrew the inflating hose from the tire valve. See *Roadside Assistance Program (U.S. and Canada) on page 13-7 or Roadside Assistance Program (Mexico) on page 13-9*.

11. Press the on/off button (A) to turn the tire sealant and compressor kit off.

The tire is not sealed and will continue to leak air until the vehicle is driven and the sealant is distributed in the tire; therefore, Steps 12 through 18 must be done immediately after Step 11.

Be careful while handling the tire sealant and compressor kit as it could be warm after usage.

12. Unplug the power plug (G) from the accessory power outlet in the vehicle.

13. Turn the sealant/air hose (F) counterclockwise to remove it from the tire valve stem.
14. Replace the tire valve stem cap.
15. Return the sealant/air hose (F) and the power plug (G) back in their original locations.



16. If the flat tire was able to inflate to the recommended inflation pressure, remove the maximum speed label from the sealant canister and place it in a highly visible location. Do not exceed the speed on this label until the damaged tire is repaired or replaced.
17. Return the equipment to its original storage location in the vehicle.

18. Immediately drive the vehicle 8 km (5 mi) to distribute the sealant in the tire.
19. Stop at a safe location and check the tire pressure. Refer to Steps 1 through 11 under “Using the Tire Sealant and Compressor Kit without Sealant to Inflate a Tire (Not Punctured).”

If the tire pressure has fallen more than 68 kPa (10 psi) below the recommended inflation pressure, stop driving the vehicle. The tire is too severely damaged and the tire sealant cannot seal the tire. See *Roadside Assistance Program (U.S. and Canada)* on page 13-7 or *Roadside Assistance Program (Mexico)* on page 13-9.

- If the tire pressure has not dropped more than 68 kPa (10 psi) from the recommended inflation pressure, use the compressor kit to inflate the tire to the recommended inflation pressure.
20. Wipe off any sealant from the wheel, tire, and vehicle.
 21. Dispose of the used sealant canister and sealant/air hose (F) assembly at a local dealer or in accordance with local state codes and practices.
 22. Replace it with a new canister available from your dealer.
 23. After temporarily sealing a tire using the tire sealant and compressor kit, take the vehicle to an authorized dealer within 161 km (100 mi) of driving to have the tire repaired or replaced.

Using the Tire Sealant and Compressor Kit without Sealant to Inflate a Tire (Not Punctured)

To use the air compressor to inflate a tire with air only and not sealant:

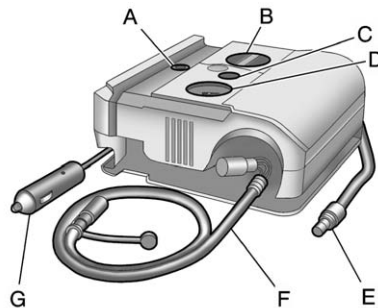

If a tire goes flat, avoid further tire and wheel damage by driving slowly to a level place. Turn on the hazard warning flashers. See *Hazard Warning Flashers* on page 6-4.

See *If a Tire Goes Flat* on page 10-58 for other important safety warnings.

1. Remove the tire sealant and compressor kit from its storage location. See *Storing the Tire Sealant and Compressor Kit on page 10-66*.
2. Unwrap the air only hose (E) and the power plug (G).
3. Place the kit on the ground.
Make sure the tire valve stem is positioned close to the ground so the hose will reach it.
4. Remove the tire valve stem cap from the flat tire by turning it counterclockwise.
5. Attach the air only hose (E) onto the tire valve stem by turning it clockwise until it is tight.
6. Plug the power plug (G) into the accessory power outlet in the vehicle. Unplug all items from other accessory power outlets. See *Power Outlets on page 5-7*.
If the vehicle has an accessory power outlet, do not use the cigarette lighter.

If the vehicle only has a cigarette lighter, use the cigarette lighter.

Do not pinch the power plug cord in the door or window.

7. Start the vehicle. The vehicle must be running while using the air compressor.
8. Turn the selector switch (B) counterclockwise to the Air Only position.
9. Press the on/off (A) button to turn the compressor on.
The compressor will inflate the tire with air only.
10. Inflate the tire to the recommended inflation pressure using the pressure gauge (D). The recommended inflation pressure can be found on the Tire and Loading Information label. See *Tire Pressure on page 10-45*.

The pressure gauge (D) may read higher than the actual tire pressure while the compressor is on. Turn the compressor off

- to get an accurate reading. The compressor may be turned on/off until the correct pressure is reached. If the tire is inflated higher than the recommended pressure, press the pressure relief button (C), if equipped, until the proper pressure reading is reached. This option is only functional when using the air only hose (E).
11. Press the on/off button (A) to turn the tire sealant and compressor kit off.
Be careful while handling the tire sealant and compressor kit as it could be warm after usage.
 12. Unplug the power plug (G) from the accessory power outlet in the vehicle.
 13. Disconnect the air only hose (E) from the tire valve stem, by turning it counterclockwise, and replace the tire valve stem cap.

10-66 Vehicle Care

14. Return the air only hose (E) and the power plug (G) back to their original locations.
15. Return the equipment to its original storage location in the vehicle.

Removal and Installation of the Sealant Canister

To remove the sealant canister:



1. Remove the plastic cover.
2. Unscrew the connector (B) from the canister (A).

3. Pull up on the canister (A) to remove it.
4. Replace with a new canister which is available from your dealer.
5. Push the new canister into place.
6. Screw the connector (B) to the canister (A).
7. Slide the plastic cover back on.

Storing the Tire Sealant and Compressor Kit

The tire sealant and compressor kit is located in the trunk.

1. Open the trunk. See *Trunk* on page 2-9.
2. Lift the cover.

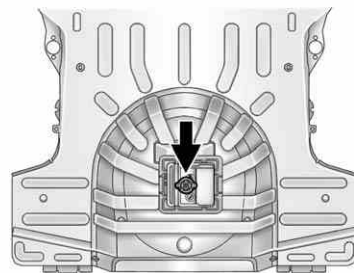

3. Turn the retainer clockwise and remove the tire sealant and compressor kit.

To store the tire sealant and compressor kit, reverse the steps.

Tire Changing

Removing the Spare Tire and Tools

The equipment you will need is in the trunk.

1. Open the trunk. See *Trunk* on page 2-9 for more information.

2. Remove the spare tire cover.



- 3. Turn the wing nut counterclockwise and remove it. Then remove the compact spare tire. See *Compact Spare Tire on page 10-75* for more information.
- 4. Remove the wing nut holding the jack in place.
- 5. Remove the jack and wheel wrench

Tire Changing Tools

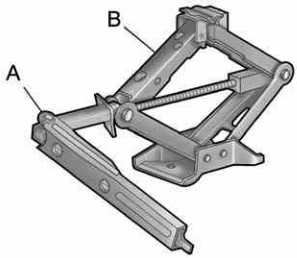

- A. Wheel Wrench
- B. Jack

The tools you will be using include the wheel wrench (A) and jack (B).

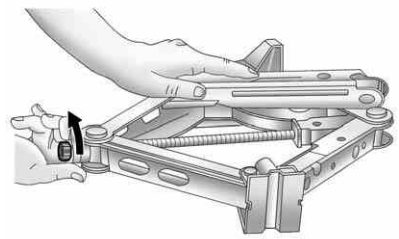

- 1. Turn the wing nut counterclockwise to loosen wheel wrench.
- 2. Unhook the wheel wrench from the jack.

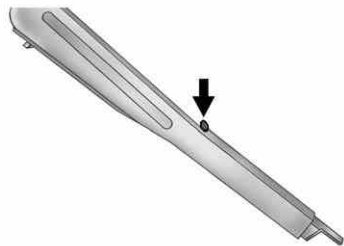

3. Extend the handle on the wheel wrench by pressing the button and pulling on the end of the wrench. You must do this before using the wheel wrench.

Removing the Flat Tire and Installing the Spare Tire

1. Do a safety check before proceeding. See *If a Tire Goes Flat on page 10-58*.
2. If the vehicle has a wheel cover or hubcap that has plastic wheel nut caps, loosen the plastic nut caps. You might need to use the wheel wrench to loosen them. Do not pry off wheel covers or center caps that have plastic wheel nut caps.
3. Remove the wheel cover or center cap from the wheel to locate the wheel nuts.

If the vehicle has a wheel cover or hubcap without plastic wheel nut caps, gently pry on the edge of the plastic wheel trim to remove it from the wheel to locate the wheel nuts.

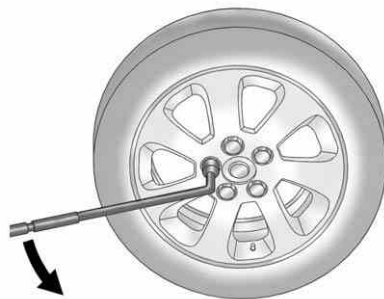

4. Use the wrench to loosen all the wheel nuts. Do not remove them yet.

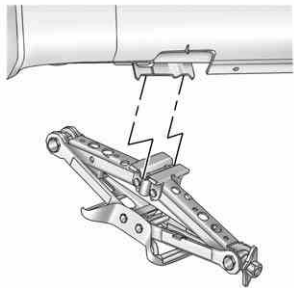

5. Position the lift head at the jack location nearest the flat tire. Make sure all of the jack lift head is touching the jacking flange under the body. Do not place the jack under a body panel.
6. Put the compact spare tire near the flat tire.

⚠ WARNING

Getting under a vehicle when it is lifted on a jack is dangerous. If the vehicle slips off the jack, you could be badly injured or killed. Never get under a vehicle when it is supported only by a jack.

⚠ WARNING

Raising the vehicle with the jack improperly positioned can damage the vehicle and even make the vehicle fall. To help avoid personal injury and vehicle damage, be sure to fit the jack lift head into the proper location before raising the vehicle.

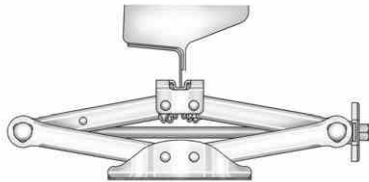

7. Raise the vehicle by turning the wrench clockwise. Raise the vehicle far enough off the ground so there is enough room for the compact spare tire to fit.

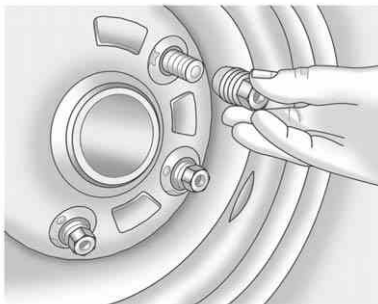

8. Remove all of the wheel nuts.
9. Remove the flat tire.

WARNING

Rust or dirt on a wheel, or on the parts to which it is fastened, can make wheel nuts become loose after time. The wheel could come off and cause an accident. When changing a wheel, remove any rust or dirt from places where the wheel attaches to the vehicle. In an emergency, a cloth or a paper towel can be used; however, use a scraper or wire brush later to remove all rust or dirt.

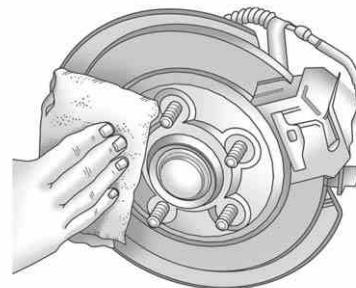

10. Remove any rust or dirt from the wheel bolts, mounting surfaces and spare wheel.
11. Install the compact spare tire.

WARNING

Never use oil or grease on bolts or nuts because the nuts might come loose. The vehicle's wheel could fall off, causing a crash.

12. Put the wheel nuts back on with the rounded end toward the wheel. Tighten each nut by hand or with the wrench until the wheel is held against the hub.

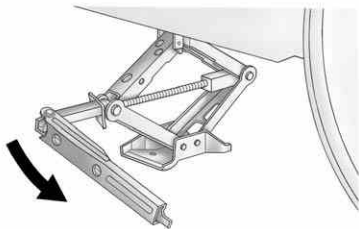

13. Lower the vehicle by turning the wrench counterclockwise. Lower the jack completely.

⚠ WARNING

Wheel nuts that are improperly or incorrectly tightened can cause the wheels to become loose or come off. The wheel nuts should be tightened with a torque wrench to the proper torque specification after replacing. Follow the torque specification supplied by the aftermarket manufacturer when using accessory locking wheel nuts. See *Capacities and Specifications on page 12-2* for original equipment wheel nut torque specifications.

Notice: Improperly tightened wheel nuts can lead to brake pulsation and rotor damage. To avoid expensive brake repairs, evenly tighten the wheel nuts in the proper sequence and to the proper torque specification. See *Capacities and Specifications on page 12-2* for the wheel nut torque specification.

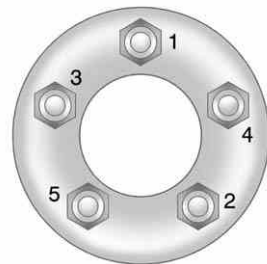

14. Tighten the wheel nuts firmly in a crisscross sequence, as shown, with the wheel wrench.

Notice: Wheel covers will not fit on the vehicle's compact spare. If you try to put a wheel cover on the compact spare, the cover or the spare could be damaged.

Do not try to put a wheel cover on the compact spare tire. It will not fit. Store the wheel cover and wheel nut caps in the trunk until you have the flat tire repaired or replaced.

Storing a Flat Tire and Tools

WARNING

Storing a jack, a tire, or other equipment in the passenger compartment of the vehicle could cause injury. In a sudden stop or collision, loose equipment could strike someone. Store all these in the proper place.

To store the flat tire and jack in the compact spare tire compartment:

1. Open the trunk. See *Trunk* on page 2-9.
2. Remove the bolt extension (in the yellow sleeve) from the jack and remove the center cap from the wheel.

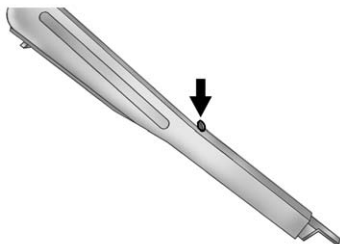

3. Collapse the wrench using the same button used to extend it.
4. Attach the wrench to the jack by placing the tab on the wrench into the hole on the side of the jack. Then place the wrench handle over the tab on the side of the jack.

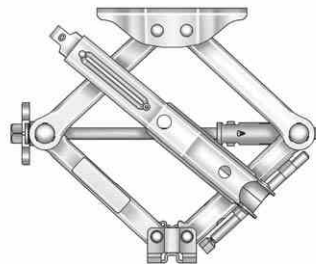

5. Raise the jack to the height shown and lock the wrench onto the jack.

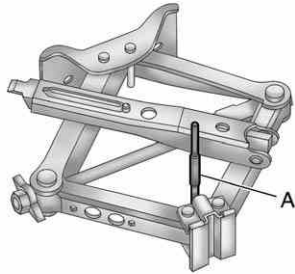

6. Place the jack over the bolt (A) on the floor, making sure it contacts the bolt. Thread the jack retainer nut until it contacts the jack.

7. With the valve stem up, place the tire on the compartment floor with the rear of the tire under the trim panel. The tire may not lay completely flat.
8. Line up the bolt with the wheel center.
9. With the yellow cap in place to prevent the wheel from being scratched, screw the bolt extension onto the bolt through the wheel center hole.
10. Remove the yellow cap from the bolt extension.
11. Secure the tire and wheel with the larger wing nut.

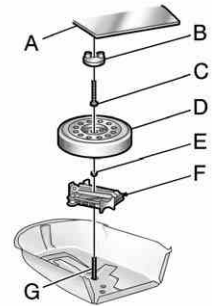

- A. Cover
- B. Wing Nut
- C. Extension
- D. Flat Tire (valve stem up)
- E. Nut
- F. Jack
- G. Bolt

The compact spare is for temporary use only. Replace the compact spare tire with a full-size tire as soon as you can. See *Compact Spare Tire on page 10-75*.

Storing the Spare Tire and Tools

⚠ WARNING

Storing a jack, a tire, or other equipment in the passenger compartment of the vehicle could cause injury. In a sudden stop or collision, loose equipment could strike someone. Store all these in the proper place.

1. Open the trunk. See *Trunk* on page 2-9.

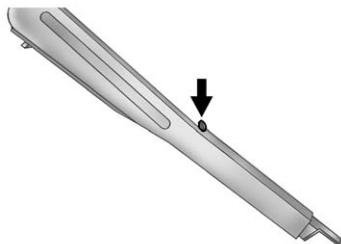

2. Collapse the wrench using the same button used to extend it.
3. Attach the wrench to the jack by placing the tab on the wrench into the hole on the side of the jack. Then place the wrench handle over the tab on the side of the jack.

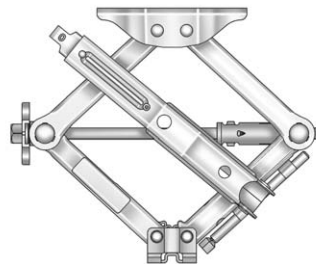

4. Raise the jack to the height shown and lock the wrench onto the jack.
5. Place the jack in the spare tire well. Make sure the stow bolt goes through the hole in the center of the wrench on the jack, with the base of the jack towards the front of the vehicle. Turn the jack retainer nut until it firmly contacts the wrench. Do not over tighten.

- Place the compact spare into the tire compartment with the stow bolt going through the center hole of the wheel.
- Turn the spare tire retainer nut until it firmly contacts the wheel. Do not over tighten.

Compact Spare Tire

WARNING

Driving with more than one compact spare tire at a time could result in loss of braking and handling. This could lead to a crash and you or others could be injured. Use only one compact spare tire at a time.

If this vehicle has a compact spare tire it was fully inflated when the vehicle was new, however, it can lose air after a time. Check the inflation pressure regularly. It should be 60 psi (420 kPa).

After installing the compact spare on the vehicle, stop as soon as possible and make sure the spare tire is correctly inflated. The compact spare is made to perform well at speeds up to 65 mph (105 km/h) for distances up to 3,000 miles (5 000 km), so you can finish your trip and have the full-size tire repaired or replaced at your convenience. Of course, it is best to replace the spare with a full-size tire as soon as possible. The spare tire will last longer and be in good shape in case it is needed again.

Notice: When the compact spare is installed, do not take the vehicle through an automatic car wash with guide rails. The compact spare can get caught on the rails which can damage the tire, wheel, and other parts of the vehicle.

Do not use the compact spare on other vehicles.

Do not mix the compact spare tire or wheel with other wheels or tires. They will not fit. Keep the spare tire and its wheel together.

Notice: Tire chains will not fit the compact spare. Using them can damage the vehicle and can damage the chains too. Do not use tire chains on the compact spare.

Jump Starting

For more information about the vehicle battery, see *Battery* on page 10-22.

If the battery has run down, you may want to use another vehicle and some jumper cables to start your vehicle. Be sure to use the following steps to do it safely.

 **WARNING**

Batteries can hurt you. They can be dangerous because:

- They contain acid that can burn you.
- They contain gas that can explode or ignite.
- They contain enough electricity to burn you.

If you do not follow these steps exactly, some or all of these things can hurt you.

Notice: Ignoring these steps could result in costly damage to the vehicle that would not be covered by the warranty.

Trying to start the vehicle by pushing or pulling it will not work, and it could damage the vehicle.

1. Check the other vehicle. It must have a 12-volt battery with a negative ground system.

Notice: Only use a vehicle that has a 12-volt system with a negative ground for jump starting. If the other vehicle does not have a 12-volt system with a negative ground, both vehicles can be damaged.

2. Get the vehicles close enough so the jumper cables can reach, but be sure the vehicles are not touching each other. If they are, it could cause a ground connection you do not want.

You would not be able to start your vehicle, and the bad grounding could damage the electrical systems.

To avoid the possibility of the vehicles rolling, set the parking brake firmly on both vehicles involved in the jump start procedure. Put an automatic transmission in P (Park) or a manual transmission in N (Neutral) before setting the parking brake.

Notice: If any accessories are left on or plugged in during the jump starting procedure, they could be damaged. The repairs would not be covered by the vehicle warranty. Whenever possible, turn off or unplug all accessories on either vehicle when jump starting the vehicle.

3. Turn off the ignition on both vehicles. Unplug unnecessary accessories plugged into the cigarette lighter or the accessory power outlet. Turn off the radio

and all lamps that are not needed. This will avoid sparks and help save both batteries. And it could save the radio!

4. Open the hoods and locate the batteries. Find the positive (+) and negative (-) terminal locations on each vehicle. Your vehicle's positive (+) terminal and negative (-) terminal are located under a black cover on the battery. See *Engine Compartment Overview on page 10-5* for more information on location. Remove the cover to access the positive (+) and negative (-) terminals.

 WARNING
An electric fan can start up even when the engine is not running and can injure you. Keep hands, clothing and tools away from any underhood electric fan.

 WARNING
Using a match near a battery can cause battery gas to explode. People have been hurt doing this, and some have been blinded. Use a flashlight if you need more light. Be sure the battery has enough water. You do not need to add water to the battery installed in your new vehicle. But if a battery has filler caps, be sure the right amount of fluid is there. If it is low, add water to take care of that first. If you do not, explosive gas could be present. Battery fluid contains acid that can burn you. Do not get it on you. If you accidentally get it in your eyes or on your skin, flush the place with water and get medical help immediately.

 WARNING
Fans or other moving engine parts can injure you badly. Keep your hands away from moving parts once the engine is running.

5. Check that the jumper cables do not have loose or missing insulation. If they do, you could get a shock. The vehicles could be damaged too.

Before you connect the cables, here are some things you should know. Positive (+) will go to positive (+) or to a remote positive (+) terminal if the vehicle has one. Negative (-) will go to a heavy, unpainted metal engine part or to a remote negative (-) terminal if the vehicle has one.

10-78 Vehicle Care

Do not connect positive (+) to negative (-) or you will get a short that would damage the battery and maybe other parts too. And do not connect the negative (-) cable to the negative (-) terminal on the dead battery because this can cause sparks.

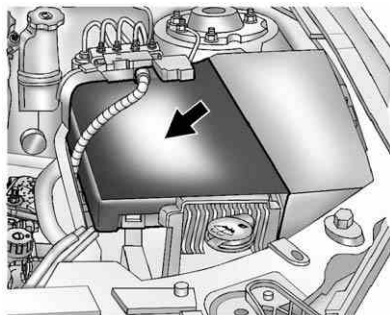

6. Connect the red positive (+) cable to the positive (+) terminal of the dead battery. Use a remote positive (+) terminal if the vehicle has one.

7. Do not let the other end touch metal. Connect it to the positive (+) terminal of the good battery. Use a remote positive (+) terminal if the vehicle has one.
8. Now connect the black negative (-) cable to the negative (-) terminal of the good battery. Use a remote negative (-) terminal if the vehicle has one.

Do not let the other end touch anything until the next step. The other end of the negative (-) cable *does not* go to the dead battery. It goes to a heavy, unpainted metal engine part or to a remote negative (-) terminal on the vehicle with the dead battery.

9. Connect the other end of the negative (-) cable at least 18 inches (45 cm) away from the dead battery, but not near engine parts that move.

The electrical connection is just as good there, and the chance of sparks getting back to the battery is much less.

10. Now start the vehicle with the good battery and run the engine for a while.
11. Try to start the vehicle that had the dead battery. If it will not start after a few tries, it probably needs service.

Notice: If the jumper cables are connected or removed in the wrong order, electrical shorting may occur and damage the vehicle. The repairs would not be covered by the vehicle warranty. Always connect and remove the jumper cables in the correct order, making sure that the cables do not touch each other or other metal.

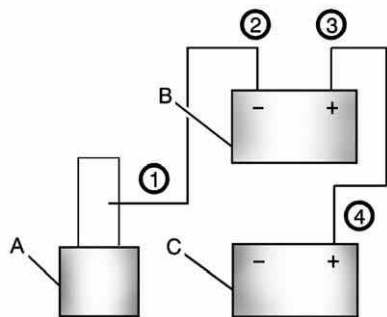

Jumper Cable Removal

- A. Heavy, Unpainted Metal Engine Part or Remote Negative (-) Terminal
- B. Good Battery or Remote Positive (+) and Remote Negative (-) Terminals
- C. Dead Battery or Remote Positive (+) Terminal

To disconnect the jumper cables from both vehicles, do the following:

1. Disconnect the black negative (-) cable from the vehicle that had the dead battery.
2. Disconnect the black negative (-) cable from the vehicle with the good battery.
3. Disconnect the red positive (+) cable from the vehicle with the good battery.
4. Disconnect the red positive (+) cable from the other vehicle.
5. Return the caps over the positive (+) and negative (-) terminals to their original positions.

Towing

Towing the Vehicle

Notice: To avoid damage, the disabled vehicle should be towed with all four wheels off the ground. Care must be taken with vehicles that have low ground clearance and/or special equipment. Always flatbed on a car carrier.

Consult your dealer or a professional towing service if the disabled vehicle must be towed. See *Roadside Assistance Program (U.S. and Canada)* on page 13-7 or *Roadside Assistance Program (Mexico)* on page 13-9.

To tow the vehicle behind another vehicle for recreational purposes, such as behind a motor home, see "Recreational Vehicle Towing" in this section.

Recreational Vehicle Towing

Recreational vehicle towing means towing the vehicle behind another vehicle – such as behind a motor home. The two most common types of recreational vehicle towing are known as dinghy towing and dolly towing. Dinghy towing is towing the vehicle with all four wheels on the ground. Dolly towing is towing the vehicle with two wheels on the ground and two wheels up on a device known as a dolly.

Here are some important things to consider before recreational vehicle towing:

- What's the towing capacity of the towing vehicle? Be sure to read the tow vehicle manufacturer's recommendations.

- How far will the vehicle be towed? Some vehicles have restrictions on how far and how long they can tow.
- Does the vehicle have the proper towing equipment? See your dealer or trailering professional for additional advice and equipment recommendations.
- Is the vehicle ready to be towed? Just as preparing the vehicle for a long trip, make sure the vehicle is prepared to be towed.

Dinghy Towing

When dinghy towing, the vehicle should be run at the beginning of each day and at each RV fuel stop for about five minutes. This will ensure proper lubrication of transmission components.

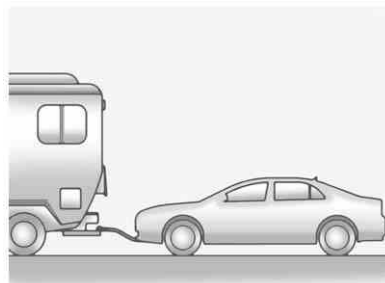

To dinghy tow the vehicle from the front with all four wheels on the ground:

1. Position the vehicle to tow and then secure it to the towing vehicle.
2. Shift the transmission to P (Park) and turn the ignition to LOCK/OFF.
3. Set the parking brake.

4. To prevent the battery from draining while the vehicle is being towed, remove the following fuse from the instrument panel fuse block: (IGN SENSOR). See *Instrument Panel Fuse Block* on page 10-34 for more information.
5. Turn the ignition to ACC/ ACCESSORY.
6. Shift the transmission to N (Neutral).
7. Release the parking brake.

Remember to reinstall the IGN SENSOR fuse once the destination has been reached.

Notice: If 105 km/h (65 mph) is exceeded while towing the vehicle, it could be damaged. Never exceed 105 km/h (65 mph) while towing the vehicle.

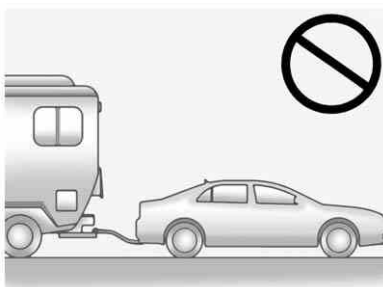

Notice: Towing the vehicle from the rear could damage it. Also, repairs would not be covered by the vehicle warranty. Never have the vehicle towed from the rear.

Dolly Towing

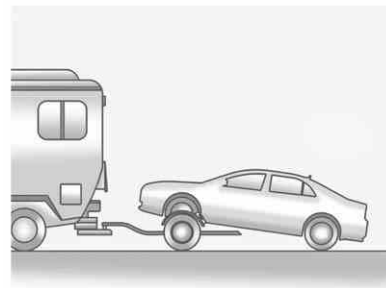

Tow the vehicle with the two rear wheels on the ground and the front wheels on a dolly:

To tow the vehicle with two wheels on the ground and a dolly:

1. Put the front wheels on a dolly.
2. Put the gear shift lever in P (Park).

3. Set the parking brake.
4. Remove the key from the ignition.
5. Secure the vehicle to the dolly.
6. Release the parking brake.

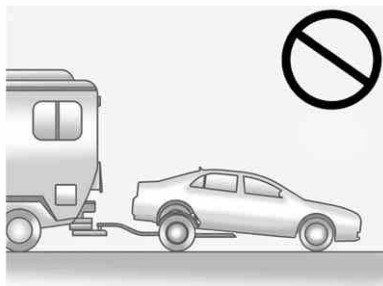

Notice: Towing the vehicle from the rear could damage it. Also, repairs would not be covered by the vehicle warranty. Never have the vehicle towed from the rear.

Appearance Care

Exterior Care

Washing the Vehicle

To preserve the vehicle's finish, wash it often and out of direct sunlight.

Notice: Do not use petroleum based, acidic, or abrasive cleaning agents as they can damage the vehicle's paint, metal, or plastic parts. If damage occurs, it would not be covered by the vehicle's warranty. Approved cleaning products can be obtained from your dealer. Follow all manufacturer directions regarding correct product usage, necessary safety precautions, and appropriate disposal of any vehicle care product.

Notice: Avoid using high pressure washes closer than 30 cm (12 in) to the surface of the vehicle. Use of power washers

exceeding 8,274 kPa (1,200 psi) can result in damage or removal of paint and decals.

Rinse the vehicle well, before washing and after, to remove all cleaning agents completely. If they are allowed to dry on the surface, they could stain.

Dry the finish with a soft, clean chamois or an all-cotton towel to avoid surface scratches and water spotting.

Finish Care

Application of aftermarket clearcoat sealant/wax materials is not recommended. If painted surfaces are damaged, see your dealer to have the damage assessed and repaired. Foreign materials such as calcium chloride and other salts, ice melting agents, road oil and tar, tree sap, bird droppings, chemicals from industrial chimneys, etc., can damage the vehicle's finish if they remain on painted surfaces. Wash the vehicle as soon as possible.

If necessary, use non-abrasive cleaners that are marked safe for painted surfaces to remove foreign matter.

Occasional hand waxing or mild polishing should be done to remove residue from the paint finish. See your dealer for approved cleaning products.

Notice: Machine compounding or aggressive polishing on a basecoat/clearcoat paint finish may damage it. Use only non-abrasive waxes and polishes that are made for a basecoat/clearcoat paint finish on the vehicle.

To keep the paint finish looking new, keep the vehicle garaged or covered whenever possible.

Protecting Exterior Bright Metal Parts

Regularly clean bright metal parts with water or chrome polish on chrome or stainless steel trim, if necessary.

For aluminum, never use auto or chrome polish, steam, or caustic soap to clean. A coating of wax, rubbed to a high polish, is recommended for all bright metal parts.

Cleaning Exterior Lamps/Lenses and Emblems

Use only lukewarm or cold water, a soft cloth, and a car washing soap to clean exterior lamps and lenses. Follow instructions under "Washing the Vehicle" later in this section.

Windshield and Wiper Blades

Clean the outside of the windshield with glass cleaner.

Clean rubber blades using a lint-free cloth or paper towel soaked with windshield washer fluid or a mild detergent. Wash the windshield thoroughly when cleaning the blades. Bugs, road grime, sap, and a buildup of vehicle wash/wax treatments may cause wiper streaking.

Replace the wiper blades if they are worn or damaged. Damage can be caused by extreme dusty conditions, sand, salt, heat, sun, snow, and ice.

Weatherstrips

Apply silicone grease on weatherstrips to make them last longer, seal better, and not stick or squeak. See *Recommended Fluids and Lubricants* on page 11-11.

Tires

Use a stiff brush with tire cleaner to clean the tires.

Notice: Using petroleum-based tire dressing products on the vehicle may damage the paint finish and/or tires. When applying a tire dressing, always wipe off any overspray from all painted surfaces on the vehicle.

Wheels and Trim — Aluminum or Chrome

Use a soft, clean cloth with mild soap and water to clean the wheels. After rinsing thoroughly with clean water, dry with a soft, clean towel. A wax may then be applied.

Keep the wheels clean using a soft, clean cloth with mild soap and water. Rinse with clean water. After rinsing thoroughly, dry with a soft, clean towel. A wax may then be applied.

Notice: Chrome wheels and other chrome trim may be damaged if the vehicle is not washed after driving on roads that have been sprayed with magnesium, calcium, or sodium chloride. These chlorides are used on roads for conditions such as ice and dust. Always wash the chrome with soap and water after exposure.

Notice: To avoid surface damage, do not use strong soaps, chemicals, abrasive polishes,

cleaners, brushes, or cleaners that contain acid on aluminum or chrome-plated wheels. Use only approved cleaners. Also, never drive a vehicle with aluminum or chrome-plated wheels through an automatic car wash that uses silicone carbide tire cleaning brushes. Damage could occur and the repairs would not be covered by the vehicle warranty.

Steering, Suspension, and Chassis Components

Visually inspect front and rear suspension and steering system for damaged, loose, or missing parts or signs of wear. Inspect the power steering for proper hook-up, binding, leaks, cracks, chafing, etc. Visually check constant velocity joints, rubber boots, and axle seals for leaks.

Body Component Lubrication

Lubricate all key lock cylinders, hood hinges, liftgate hinges, and the steel fuel door hinge unless the

components are plastic. Applying silicone grease on weatherstrips with a clean cloth will make them last longer, seal better, and not stick or squeak.

Underbody Maintenance

Use plain water to flush dirt and debris from the vehicle's underbody. Your dealer or an underbody car washing system can do this. If not removed, rust and corrosion can develop.

Sheet Metal Damage

If the vehicle is damaged and requires sheet metal repair or replacement, make sure the body repair shop applies anti-corrosion material to parts repaired or replaced to restore corrosion protection.

Original manufacturer replacement parts will provide the corrosion protection while maintaining the vehicle warranty.

Finish Damage

Quickly repair minor chips and scratches with touch-up materials available from your dealer to avoid corrosion. Larger areas of finish damage can be corrected in your dealer's body and paint shop.

Chemical Paint Spotting

Airborne pollutants can fall upon and attack painted vehicle surfaces causing blotchy, ring-shaped discolorations, and small, irregular dark spots etched into the paint surface.

Interior Care

To prevent dirt particle abrasions, regularly clean the vehicle's interior. Immediately remove any soils. Note that newspapers or dark garments that can transfer color to home furnishings can also permanently transfer color to the vehicle's interior.

Use a soft bristle brush to remove dust from knobs and crevices on the instrument cluster. Using a mild soap solution, immediately remove hand lotions, sunscreen, and insect repellent from all interior surfaces or permanent damage may result.

Your dealer may have products for cleaning the interior. Use cleaners specifically designed for the surfaces being cleaned to prevent permanent damage. To prevent overspray, apply all cleaners directly to the cleaning cloth. Cleaners should be removed quickly. Never allow cleaners to remain on the surface being cleaned for extended periods of time.

Cleaners may contain solvents that can become concentrated in the interior. Before using cleaners, read and adhere to all safety instructions on the label. While cleaning the interior, maintain adequate ventilation by opening the doors and windows.

To prevent damage, do not clean the interior using the following cleaners or techniques:

- Never use a razor or any other sharp object to remove a soil from any interior surface.
- Never use a brush with stiff bristles.
- Never rub any surface aggressively or with excessive pressure.
- Do not use laundry detergents or dishwashing soaps with degreasers. For liquid cleaners, use approximately 20 drops per 3.78 L (1 gal) of water. A concentrated soap solution will leave a residue that creates streaks and attracts dirt. Do not use solutions that contain strong or caustic soap.
- Do not heavily saturate the upholstery when cleaning.
- Do not use solvents or cleaners containing solvents.

Interior Glass

To clean, use a terry cloth fabric dampened with water. Wipe droplets left behind with a clean dry cloth. Commercial glass cleaners may be used, if necessary, after cleaning the interior glass with plain water.

Notice: To prevent scratching, never use abrasive cleaners on automotive glass. Abrasive cleaners or aggressive cleaning may damage the rear window defogger.

Fabric/Carpet

Start by vacuuming the surface using a soft brush attachment. If a rotating brush attachment is being used during vacuuming, only use it on the floor carpet. Before cleaning, gently remove as much of the soil as possible using one of the following techniques:

- Gently blot liquids with a paper towel. Continue blotting until no more soil can be removed.

- For solid soils, remove as much as possible prior to vacuuming.

To clean:

1. Saturate a clean lint-free colorfast cloth with water or club soda. Microfiber cloth is recommended to prevent lint transfer to the fabric or carpet.
2. Remove excess moisture by gently wringing until water does not drip from the cleaning cloth.
3. Start on the outside edge of the soil and gently rub toward the center. Fold the cleaning cloth to a clean area frequently to prevent forcing the soil in to the fabric.
4. Continue gently rubbing the soiled area until there is no longer any color transfer from the soil to the cleaning cloth.
5. If the soil is not completely removed, use a mild soap solution followed only by club soda or plain water.

If the soil is not completely removed, it may be necessary to use a commercial upholstery cleaner or spot lifter. Test a small hidden area for colorfastness before using a commercial upholstery cleaner or spot lifter. If ring formation occurs, clean the entire fabric or carpet.

Following the cleaning process, a paper towel can be used to blot excess moisture.

Instrument Panel, Vinyl, and Other Plastic Surfaces

Use a soft microfiber cloth dampened with water to remove dust and loose dirt. For a more thorough cleaning, use a soft microfiber cloth dampened with a mild soap solution.

Notice: Soaking or saturating leather, especially perforated leather, as well as other interior surfaces, may cause permanent damage. Wipe excess moisture from these surfaces after

cleaning and allow them to dry naturally. Never use heat, steam, spot lifters or spot removers. Do not use cleaners that contain silicone or wax-based products. Cleaners containing these solvents can permanently change the appearance and feel of leather or soft trim and are not recommended.

Do not use cleaners that increase gloss, especially on the instrument panel. Reflected glare can decrease visibility through the windshield under certain conditions.

Notice: Use of air fresheners may cause permanent damage to plastics and painted surfaces. If an air freshener comes in contact with any plastic or painted surface in the vehicle, blot immediately and clean with a soft cloth dampened with a mild soap solution. Damage caused by air fresheners would not be covered by the vehicle warranty.

Floor Mats

WARNING

If a floor mat is the wrong size or is not properly installed, it can interfere with the pedals. Interference with the pedals can cause unintended acceleration and/or increased stopping distance which can cause a crash and injury. Make sure the floor mat does not interfere with the pedals.

Use the following guidelines for proper floor mat usage.

- The original equipment floor mats were designed for your vehicle. If the floor mats need replacing, it is recommended that GM certified floor mats be purchased. Non-GM floor mats may not fit properly and may interfere with the accelerator or brake pedal. Always check that the floor mats do not interfere with the pedals.
- Use the floor mat with the correct side up. Do not turn it over.
- Do not place anything on top of the driver side floor mat.

10-88 Vehicle Care

- Use only a single floor mat on the driver side.
- Do not place one floor mat on top of another.

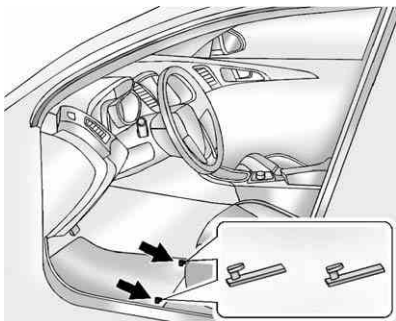

The driver side floor mat is held in place by two hooks.

Removing and Replacing the Floor Mat

1. Pull up on the rear of the mat to remove it from the hooks.
2. Reinstall the floor mat by lining up the openings in the floor mat over the hooks and push it down into position.
3. Make sure the floor mat is properly secured and verify that it does not interfere with the pedals.

Service and Maintenance

General Information

General Information 11-1

Maintenance Schedule

Maintenance Schedule 11-3

Special Application Services

Special Application
Services 11-8

Additional Maintenance and Care

Additional Maintenance
and Care 11-8

Recommended Fluids, Lubricants, and Parts

Recommended Fluids and
Lubricants 11-11

Maintenance Replacement
Parts 11-12

Maintenance Records

Maintenance Records 11-13

General Information

Your vehicle is an important investment. This section describes the required maintenance for the vehicle. Follow this schedule to help protect against major repair expenses resulting from neglect or inadequate maintenance. It may also help to maintain the value of the vehicle if it is sold. It is the responsibility of the owner to have all required maintenance performed.

Your dealer has trained technicians who can perform required maintenance using genuine replacement parts. They have up-to-date tools and equipment for fast and accurate diagnostics. Many dealers have extended evening and Saturday hours, courtesy transportation, and online scheduling to assist with service needs.

Your dealer recognizes the importance of providing competitively priced maintenance and repair services. With trained technicians, the dealer is the place for routine maintenance such as oil changes and tire rotations and additional maintenance items like tires, brakes, batteries, and wiper blades.

Notice: Damage caused by improper maintenance can lead to costly repairs and may not be covered by the vehicle warranty. Maintenance intervals, checks, inspections, recommended fluids, and lubricants are important to keep the vehicle in good working condition.

The Tire Rotation and Required Services are the responsibility of the vehicle owner. It is recommended to have your dealer perform these services every 12 000 km/7,500 mi. Proper vehicle maintenance helps to keep the vehicle in good working condition, improves fuel economy, and reduces vehicle emissions.

11-2 Service and Maintenance

Because of the way people use vehicles, maintenance needs vary. There may need to be more frequent checks and services. The Additional Required Services - Normal are for vehicles that:

- Carry passengers and cargo within recommended limits on the Tire and Loading Information label. See *Vehicle Load Limits on page 9-10*.
- Are driven on reasonable road surfaces within legal driving limits.
- Use the recommended fuel. See *Recommended Fuel on page 9-34*.

Refer to the information in the Maintenance Schedule Additional Required Services - Normal chart.

The Additional Required Services - Severe are for vehicles that are:

- Mainly driven in heavy city traffic in hot weather.
- Mainly driven in hilly or mountainous terrain.
- Frequently towing a trailer.
- Used for high speed or competitive driving.
- Used for taxi, police, or delivery service.

Refer to the information in the Maintenance Schedule Additional Required Services - Severe chart.

WARNING

Performing maintenance work can be dangerous and can cause serious injury. Perform maintenance work only if the required information, proper tools, and equipment are available. If they are not, see your dealer to have a trained technician do the work. See *Doing Your Own Service Work on page 10-4*.

Maintenance Schedule

Owner Checks and Services

At Each Fuel Stop

- Check the engine oil level. See *Engine Oil on page 10-8*.

Once a Month

- Check the tire inflation pressures. See *Tire Pressure on page 10-45*.
- Inspect the tires for wear. See *Tire Inspection on page 10-51*.
- Check the windshield washer fluid level. See *Washer Fluid on page 10-19*.

Engine Oil Change

When the CHANGE OIL SOON message displays, have the engine oil and filter changed within the next 1 000 km/600 mi. If driven under the best conditions, the engine oil life system might not indicate the need for vehicle service for more than a year. The engine oil and filter must be changed at least once a year and the oil life system must be reset. Your trained dealer technician can perform this work. If the engine oil life system is reset accidentally, service the vehicle within 5 000 km/3,000 mi since the last service. Reset the oil life system when the oil is changed. See *Engine Oil Life System on page 10-11*.

Tire Rotation and Required Services Every 12 000 km/7,500 mi

Rotate the tires, if recommended for the vehicle, and perform the following services. See *Tire Rotation on page 10-51*.

- Check engine oil level and oil life percentage. If needed, change engine oil and filter, and reset oil life system. See *Engine Oil on page 10-8* and *Engine Oil Life System on page 10-11*.
- Check engine coolant level. See *Engine Coolant on page 10-14*.
- Check windshield washer fluid level. See *Washer Fluid on page 10-19*.
- Visually inspect windshield wiper blades for wear, cracking, or contamination. See *Exterior Care on page 10-82*. Replace worn or damaged wiper blades. See *Wiper Blade Replacement on page 10-24*.

11-4 Service and Maintenance

- Check tire inflation pressures. See *Tire Pressure* on page 10-45.
- Inspect tire wear. See *Tire Inspection* on page 10-51.
- Visually check for fluid leaks.
- Inspect engine air cleaner filter. See *Engine Air Cleaner/Filter* on page 10-12.
- Inspect brake system.
- Visually inspect steering, suspension, and chassis components for damaged, loose, or missing parts or signs of wear. See *Exterior Care* on page 10-82.
- Check restraint system components. See *Safety System Check* on page 3-16.
- Visually inspect fuel system for damage or leaks.
- Visually inspect exhaust system and nearby heat shields for loose or damaged parts.
- Lubricate body components. See *Exterior Care* on page 10-82.
- Check starter switch. See *Starter Switch Check* on page 10-23.
- Check automatic transmission shift lock control function. See *Automatic Transmission Shift Lock Control Function Check* on page 10-23.
- Check ignition transmission lock. See *Ignition Transmission Lock Check* on page 10-24.
- Check parking brake and automatic transmission park mechanism. See *Park Brake and P (Park) Mechanism Check* on page 10-24.
- Check accelerator pedal for damage, high effort, or binding. Replace if needed.
- Visually inspect gas strut for signs of wear, cracks, or other damage. Check the hold open ability of the strut. See your dealer if service is required.
- Check tire sealant expiration date, if equipped. See *Tire Sealant and Compressor Kit* on page 10-60.
- Inspect sunroof track and seal, if equipped. See *Sunroof* on page 2-18.

11-6 Service and Maintenance

Footnotes — Maintenance Schedule Additional Required Services — Normal

a) Check all fuel and vapor lines and hoses for proper hook-up, routing, and condition. Check that the purge valve, if the vehicle has one, works properly. Replace as needed.

b) Or every four years, whichever comes first.

c) Or every five years, whichever comes first. See *Cooling System on page 10-13*.

d) Or every 10 years, whichever comes first. Inspect for fraying, excessive cracking, or damage; replace, if needed.

11-8 Service and Maintenance

Footnotes — Maintenance Schedule Additional Required Services — Severe

a) Check all fuel and vapor lines and hoses for proper hook-up, routing, and condition. Check that the purge valve, if the vehicle has one, works properly. Replace as needed.

b) Or every four years, whichever comes first.

c) Or every five years, whichever comes first. See *Cooling System on page 10-13*.

d) Or every 10 years, whichever comes first. Inspect for fraying, excessive cracking, or damage; replace, if needed.

Special Application Services

- Severe Commercial Use Vehicles Only: Lubricate chassis components every 5 000 km/3,000 mi.
- Have underbody flushing service performed once a year.

Additional Maintenance and Care

Your vehicle is an important investment and caring for it properly may help to avoid future costly repairs. To maintain vehicle performance, additional maintenance services may be required. It is recommended that your dealer perform these services — their trained dealer technicians know your vehicle best. Your dealer can also perform a thorough assessment with a multi-point inspection to recommend when your vehicle may need attention. The following list is intended to explain the services and conditions to look for that may indicate services are required.

Battery

The battery supplies power to start the engine and operate any additional electrical accessories.

- To avoid break-down or failure to start the vehicle, maintain a battery with full cranking power.
- Trained dealer technicians have the diagnostic equipment to test the battery and ensure that the connections and cables are corrosion-free.

Belts

- Belts may need replacing if they squeak or show signs of cracking or splitting.
- Trained dealer technicians can inspect the belts and recommend replacement when necessary.

Brakes

Brakes stop the vehicle and are crucial to safe driving.

- Signs of brake wear may include chirping, grinding, or squealing noises, or difficulty stopping.
- Trained dealer technicians have access to tools and equipment to inspect the brakes and recommend quality parts engineered for the vehicle.

Fluids

Proper fluid levels and approved fluids protect the vehicle's systems and components. See *Recommended Fluids and Lubricants on page 11-11* for GM approved fluids.

- Engine oil and windshield washer fluid levels should be checked at every fuel fill.
- Instrument cluster lights may come on to indicate that fluids may be low and need to be filled.

Hoses

Hoses transport fluids and should be regularly inspected to ensure that there are no cracks or leaks.

With a multi-point inspection, your dealer can inspect the hoses and advise if replacement is needed.

Lamps

Properly working headlamps, taillamps, and brake lamps are important to see and be seen on the road.

- Signs that the headlamps need attention include dimming, failure to light, cracking, or damage. The brake lamps need to be checked periodically to ensure that they light when braking.
- With a multi-point inspection, your dealer can check the lamps and note any concerns.

Shocks and Struts

Shocks and struts help aid in control for a smoother ride.

- Signs of wear may include steering wheel vibration, bounce/sway while braking, longer stopping distance, or uneven tire wear.

11-10 Service and Maintenance

- As part of the multi-point inspection, trained dealer technicians can visually inspect the shocks and struts for signs of leaking, blown seals, or damage, and can advise when service is needed.

Tires

Tires need to be properly inflated, rotated, and balanced. Maintaining the tires can save money, fuel, and can reduce the risk of tire failure.

- Signs that the tires need to be replaced include three or more visible treadwear indicators; cord or fabric showing through the rubber; cracks or cuts in the tread or sidewall; or a bulge or split in the tire.
- Trained dealer technicians can inspect and recommend the right tires. Your dealer can also provide tire/wheel balancing services to ensure smooth vehicle operation at all speeds. Your dealer sells and services name brand tires.

Vehicle Care

To help keep the vehicle looking like new, vehicle care products are available from your dealer. For information on how to clean and protect the vehicle's interior and exterior, see *Interior Care on page 10-85* and *Exterior Care on page 10-82*.

Wheel Alignment

Wheel alignment is critical for ensuring that the tires deliver optimal wear and performance.

- Signs that the alignment may need to be adjusted include pulling, improper vehicle handling, or unusual tire wear.
- Your dealer has the required equipment to ensure proper wheel alignment.

Windshield

For safety, appearance, and the best viewing, keep the windshield clean and clear.

- Signs of damage include scratches, cracks, and chips.
- Trained dealer technicians can inspect the windshield and recommend proper replacement if needed.

Wiper Blades

Wiper blades need to be cleaned and kept in good condition to provide a clear view.

- Signs of wear include streaking, skipping across the windshield, and worn or split rubber.
- Trained dealer technicians can check the wiper blades and replace them when needed.

Recommended Fluids, Lubricants, and Parts

Recommended Fluids and Lubricants

Usage	Fluid/Lubricant
Engine Oil	Use only engine oil licensed to the dexos1 specification, or equivalent, of the proper SAE viscosity grade. ACDelco dexos1 Synthetic Blend is recommended. See <i>Engine Oil on page 10-8</i> .
Engine Coolant	50/50 mixture of clean, drinkable water and use only DEX-COOL Coolant. See <i>Engine Coolant on page 10-14</i> .
Hydraulic Brake System	DOT 3 Hydraulic Brake Fluid (GM Part No. 88862806, in Canada 88862807).
Windshield Washer	Optikleen [®] Washer Solvent.
Hydraulic Power Steering System (if equipped)	GM Power Steering Fluid (GM Part No. 89021184, in Canada 89021186).
Automatic Transmission	DEXRON [®] -VI Automatic Transmission Fluid.
Key Lock Cylinders	Multi-Purpose Lubricant, Superlube (GM Part No. 12346241, in Canada 10953474).
Hood Latch Assembly, Secondary Latch, Pivots, Spring Anchor, and Release Pawl	Lubriplate Lubricant Aerosol (GM Part No. 12346293, in Canada 992723) or lubricant meeting requirements of NLGI #2, Category LB or GC-LB.

11-12 Service and Maintenance

Usage	Fluid/Lubricant
Hood and Door Hinges	Multi-Purpose Lubricant, Superlube (GM Part No. 12346241, in Canada 10953474).
Weatherstrip Conditioning	Weatherstrip Lubricant (GM Part No. 3634770, in Canada 10953518) or Dielectric Silicone Grease (GM Part No. 12345579, in Canada 992887).

Maintenance Replacement Parts

Replacement parts identified below by name, part number, or specification can be obtained from your dealer.

Part	GM Part Number	ACDelco Part Number
Engine Air Cleaner/Filter	22676970	A1627C
Engine Oil Filter		
2.4L L4 Engine	12605566	PF457G
3.6L V6 Engine	12600224	PF48
Spark Plugs		
2.4L L4 Engine	12625058	41-103
3.6L V6 Engine	12622561	41-109
Wiper Blades		
Driver Side – 60.0 cm (23.6 in)	25800624	—
Passenger Side – 53.0 cm (21.0 in)	25800623	—

Technical Data

Vehicle Identification

Vehicle Identification Number (VIN)	12-1
Service Parts Identification Label	12-1

Vehicle Data

Capacities and Specifications	12-2
Engine Drive Belt Routing ...	12-4

Vehicle Identification

Vehicle Identification Number (VIN)



This legal identifier is in the front corner of the instrument panel, on the left side of the vehicle. It can be seen through the windshield from outside. The VIN also appears on the Vehicle Certification and Service Parts labels and certificates of title and registration.

Engine Identification

The eighth character in the VIN is the engine code. This code identifies the vehicle's engine, specifications, and replacement parts. See "Engine Specifications" under *Capacities and Specifications* on page 12-2 for the vehicle's engine code.

Service Parts Identification Label

This label, on the inside of the glove box, has the following information:

- Vehicle Identification Number (VIN).
- Model designation.
- Paint information.
- Production options and special equipment.

Do not remove this label from the vehicle.

Vehicle Data

Capacities and Specifications

Application	Capacities	
	Metric	English
Air Conditioning Refrigerant R134a	For the air conditioning system refrigerant charge amount, see the refrigerant label located under the hood. See your dealer for more information.	
Engine Cooling System		
2.4L L4 Engine	7.1 L	7.5 qt
3.6L V6 Engines	9.4 L	9.9 qt
Engine Oil with Filter		
2.4L L4 Engine	4.7 L	5.0 qt
3.6L V6 Engine	5.7 L	6.0 qt
Fuel Tank	61.7 L	16.3 gal
Transmission Fluid*		
2.4L L4 Engine with 6— Speed Automatic Transmission (RPO MH8)— (Drain and Refill)	5.0 L	5.3 qt
3.6L V6 Engine with 6— Speed Automatic Transmission (RPO MH2)— (Drain and Refill)	6.0 L	6.3 qt

Application	Capacities	
	Metric	English
Wheel Nut Torque	140 N•m	100 ft lb
*See <i>Automatic Transmission Fluid</i> on page 10-12 for information on checking fluid level.		
All capacities are approximate. When adding, be sure to fill to the approximate level, as recommended in this manual. Recheck fluid level after filling.		

Engine Specifications

Engine	VIN Code	Transmission	Spark Plug Gap
2.4L L4 Engine	U	Automatic	1.01 mm (0.040 in)
2.4L L4 Engine	0	Automatic	1.01 mm (0.040 in)
3.6L V6 Engine	7	Automatic	1.10 mm (0.044 in)

12-4 Technical Data

Engine Drive Belt Routing

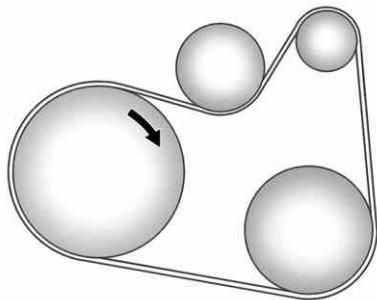

2.4L L4 Engine

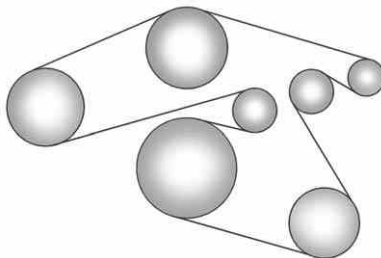

3.6L V6 Engine

Customer Information

Customer Information

Customer Satisfaction Procedure (U.S. and Canada)	13-1
Customer Satisfaction Procedure (Mexico)	13-3
Customer Assistance Offices (U.S. and Canada)	13-4
Customer Assistance Offices (Mexico)	13-5
Customer Assistance for Text Telephone (TTY) Users (U.S. and Canada)	13-6
Online Owner Center	13-6
GM Mobility Reimbursement Program (U.S. and Canada)	13-7
Roadside Assistance Program (U.S. and Canada)	13-7
Roadside Assistance Program (Mexico)	13-9
Scheduling Service Appointments (U.S. and Canada)	13-12

Courtesy Transportation Program (U.S. and Canada)	13-13
Collision Damage Repair (U.S. and Canada)	13-14
Service Publications Ordering Information	13-16

Reporting Safety Defects

Reporting Safety Defects to the United States Government	13-17
Reporting Safety Defects to the Canadian Government	13-18
Reporting Safety Defects to General Motors	13-18

Vehicle Data Recording and Privacy

Vehicle Data Recording and Privacy	13-19
Vehicle Data Recording	13-19
OnStar®	13-20
Radio Frequency Identification (RFID)	13-20
Radio Frequency Statement	13-20

Customer Information

Customer Satisfaction Procedure (U.S. and Canada)

Your satisfaction and goodwill are important to your dealer and to Chevrolet. Normally, any concerns with the sales transaction or the operation of the vehicle will be resolved by your dealer's sales or service departments. Sometimes, however, despite the best intentions of all concerned, misunderstandings can occur. If your concern has not been resolved to your satisfaction, the following steps should be taken:

STEP ONE: Discuss your concern with a member of dealership management. Normally, concerns can be quickly resolved at that level. If the matter has already been reviewed with the sales, service, or parts manager, contact the owner of your dealership or the general manager.

13-2 Customer Information

STEP TWO: If after contacting a member of dealership management, it appears your concern cannot be resolved by your dealership without further help, in the U.S., call the Chevrolet Customer Assistance Center at 1-800-222-1020. In Canada, call General Motors of Canada Customer Care Centre at 1-800-263-3777 (English), or 1-800-263-7854 (French).

We encourage you to call the toll-free number in order to give your inquiry prompt attention. Have the following information available to give the Customer Assistance representative:

- Vehicle Identification Number (VIN). This is available from the vehicle registration or title, or the plate at the top left of the instrument panel and visible through the windshield.
- Dealership name and location.
- Vehicle delivery date and present mileage.

When contacting Chevrolet, remember that your concern will likely be resolved at a dealer's facility. That is why we suggest following Step One first.

STEP THREE — U.S. Owners:

Both General Motors and your dealer are committed to making sure you are completely satisfied with your new vehicle. However, if you continue to remain unsatisfied after following the procedure outlined in Steps One and Two, you can file with the Better Business Bureau (BBB) Auto Line® Program to enforce your rights.

The BBB Auto Line Program is an out-of-court program administered by the Council of Better Business Bureaus to settle automotive disputes regarding vehicle repairs or the interpretation of the New Vehicle Limited Warranty. Although you may be required to resort to this informal dispute resolution program prior to filing a court action, use of the program is free of charge and your

case will generally be heard within 40 days. If you do not agree with the decision given in your case, you may reject it and proceed with any other venue for relief available to you.

You may contact the BBB Auto Line Program using the toll-free telephone number or write them at the following address:

BBB Auto Line Program
Council of Better Business
Bureaus, Inc.
4200 Wilson Boulevard
Suite 800
Arlington, VA 22203-1838

Telephone: 1-800-955-5100
www.dr.bbb.org/goauto

This program is available in all 50 states and the District of Columbia. Eligibility is limited by vehicle age, mileage, and other factors. General Motors reserves the right to change eligibility limitations and/or discontinue its participation in this program.

STEP THREE — Canadian

Owners: In the event that you do not feel your concerns have been addressed after following the procedure outlined in Steps One and Two, General Motors of Canada Limited wants you to be aware of its participation in a no-charge Mediation/Arbitration Program. General Motors of Canada Limited has committed to binding arbitration of owner disputes involving factory-related vehicle service claims. The program provides for the review of the facts involved by an impartial third party arbiter, and may include an informal hearing before the arbiter. The program is designed so that the entire dispute settlement process, from the time you file your complaint to the final decision, should be completed in about 70 days. We believe our impartial program offers advantages over courts in most jurisdictions because it is informal, quick, and free of charge.

For further information concerning eligibility in the Canadian Motor Vehicle Arbitration Plan (CAMVAP), call toll-free 1-800-207-0685, or call the General Motors Customer Care Centre, 1-800-263-3777 (English), 1-800-263-7854 (French), or write to:

The Mediation/Arbitration Program
c/o Customer Care Centre
General Motors of Canada Limited
Mail Code: CA1-163-005
1908 Colonel Sam Drive
Oshawa, Ontario L1H 8P7

Your inquiry should be accompanied by the Vehicle Identification Number (VIN).

Customer Satisfaction Procedure (Mexico)

Did you get the Warranty Extension Plan? This plan is recommended by General Motors to supplement the warranty included with the new vehicle purchase.

See your dealer for details.

Customer Assistance Procedure

Owner satisfaction and goodwill are very important to your dealer and General Motors.

Normally, any problem with the transaction, sale, or usage of the vehicle must be handled by your dealer sales or service departments.

13-4 Customer Information

However, we recognize that despite the good intentions of all parties involved, sometimes a misunderstanding may occur.

If you have a problem that has not been satisfactorily handled through the normal means, we suggest the following steps:

STEP ONE

Explain your case to your dealer service agent, service manager, dealer sales agent, or sales manager, depending on your case.

Make sure that they have all necessary information. They are interested in your continual satisfaction.

STEP TWO

If you are not satisfied, please contact the general manager or your dealership owner to ask for their help. If they are not able to resolve your case, ask them to contact the right people at General Motors for support, if needed.

STEP THREE

If your case is not resolved in a reasonable amount of time by your dealer, please call the General Motors Customer Assistance Center (CAC) and provide the following information:

- Name
- Address
- Phone number
- Model year
- Brand
- Vehicle Identification Number (VIN)
- Mileage
- Delivery date
- Description of the problem
- Dealership name
- Dealership address

See *Customer Assistance Offices (U.S. and Canada)* on page 13-4 or *Customer Assistance Offices (Mexico)* on page 13-5.

Customer Assistance Offices (U.S. and Canada)

Chevrolet encourages customers to call the toll-free number for assistance. However, if a customer wishes to write or e-mail Chevrolet, the letter should be addressed to:

United States

Chevrolet Motor Division
Chevrolet Customer
Assistance Center
P.O. Box 33170
Detroit, MI 48232-5170
www.Chevrolet.com

1-800-222-1020
1-800-833-2438 (For Text
Telephone Devices (TTYs))
Roadside Assistance:
1-800-243-8872

From Puerto Rico:

1-800-496-9992 (English)
1-800-496-9993 (Spanish)

From U.S. Virgin Islands:

1-800-496-9994

Canada

General Motors of Canada Limited
Customer Care Centre, Mail Code:
CA1-163-005

1908 Colonel Sam Drive
Oshawa, Ontario L1H 8P7
www.gm.ca

1-800-263-3777 (English)
1-800-263-7854 (French)
1-800-263-3830 (For Text
Telephone devices (TTYs))
Roadside Assistance:
1-800-268-6800

Overseas

Please contact the local General
Motors Business Unit.

Mexico, Central America, and Caribbean Islands/Countries (Except Puerto Rico and U.S. Virgin Islands)

General Motors de Mexico,
S. de R.L. de C.V.
Customer Assistance Center
Av. Ejercito Nacional #843
Col. Granada
C.P. 11520, Mexico, D.F.

01-800-466-0800
Long Distance: 011-52-53 29 0800

Customer Assistance Offices (Mexico)

To contact the Customer Assistance
Center (CAC), use the phone
numbers listed in this section.

Customer assistance is available
Monday through Friday, 08:00 to
20:00 hours, and Saturdays from
08:00 to 15:00 hours.

All e-mail inquiries to the Customer
Assistance Center (CAC) should be
sent to: cac.chevrolet@gm.com.

Mexico

From Mexico City
5329-0811

From Other Mexico Locations
01-800-466-0811

United States and Canada
1-866-466-8190

Costa Rica
00-800-052-1005

Guatemala
1-800-999-5252

Panama
00-800-052-0001

Dominican Republic
1-888-751-5301

El Salvador
800-6273

Honduras
800-0122-6101

Customer Assistance for Text Telephone (TTY) Users (U.S. and Canada)

To assist customers who are deaf, hard of hearing, or speech-impaired and who use Text Telephones (TTYs), Chevrolet has TTY equipment available at its Customer Assistance Center. Any TTY user in the U.S. can communicate with Chevrolet by dialing: 1-800-833-2438. TTY users in Canada can dial 1-800-263-3830.

Online Owner Center

Manage your vehicle (U.S.) at chevrolet.com. Click on “Owners,” then “Manage My Chevrolet/Owners Login.”

Information and services customized for your specific vehicle — all in one convenient place.

- Digital owner manual, warranty information, and more.

- Storage for online service and maintenance records.
- Chevrolet dealer locator for service nationwide.
- Exclusive privileges and offers.
- Recall notices for your specific vehicle.
- OnStar and GM Cardmember Services Earnings summaries.

Other Helpful Links

Chevrolet — www.chevrolet.com

Chevrolet Merchandise — www.chevymall.com

Help Center — www.chevrolet.com/pages/mds/helpcenter/faq.do

- FAQ
- Contact Us

Chevrolet Owner Centre (Canada) chevroletowner.ca

Take a trip to the Chevrolet Owner Centre:

- Chat live with online help representatives.
- Use the Vehicle Tools section.
- Access third party enthusiast sites and social media networks.
- Locate owner resources such as lease-end, financing, and warranty information.
- Retrieve your favorite articles, quizzes, tips and multimedia galleries organized into the Features and Auto Care Sections.
- Download the owner manual for your vehicle, quickly and easily.
- Find the Chevrolet - recommended maintenance services for your vehicle.

GM Mobility Reimbursement Program (U.S. and Canada)



This program is available to qualified applicants for cost reimbursement of eligible aftermarket adaptive equipment required for the vehicle, such as hand controls or a wheelchair/scooter lift for the vehicle.

For more information on the limited offer, visit www.gmmobility.com or call the GM Mobility Assistance Center at 1-800-323-9935. Text Telephone (TTY) users, call 1-800-833-9935.

General Motors of Canada also has a Mobility Program. Call 1-800-GM-DRIVE (463-7483) for details. TTY users call 1-800-263-3830.

Roadside Assistance Program (U.S. and Canada)

For U.S.-purchased vehicles, call **1-800-243-8872; (Text Telephone (TTY): 1-888-889-2438)**.

For Canadian-purchased vehicles, call **1-800-268-6800**.

Service is available 24 hours a day, 365 days a year.

Calling for Assistance

When calling Roadside Assistance, have the following information ready:

- Your name, home address, and home telephone number.
- Telephone number of your location.

- Location of the vehicle.
- Model, year, color, and license plate number of the vehicle.
- Odometer reading, Vehicle Identification Number (VIN), and delivery date of the vehicle.
- Description of the problem.

Coverage

Services are provided up to 5 years/160 000 km (100,000 mi), whichever comes first.

In the U.S., anyone driving the vehicle is covered. In Canada, a person driving the vehicle without permission from the owner is not covered.

Roadside Assistance is not a part of the New Vehicle Limited Warranty. Chevrolet and General Motors of Canada Limited reserve the right to make any changes or discontinue the Roadside Assistance program at any time without notification.

13-8 Customer Information

Chevrolet and General Motors of Canada Limited reserve the right to limit services or payment to an owner or driver if they decide the claims are made too often, or the same type of claim is made many times.

Services Provided

- **Emergency Fuel Delivery:** Delivery of enough fuel for the vehicle to get to the nearest service station.
- **Lock-Out Service:** Service to unlock the vehicle if you are locked out. A remote unlock may be available if you have OnStar. For security reasons, the driver must present identification before this service is given.
- **Emergency Tow from a Public Road or Highway:** Tow to the nearest Chevrolet dealer for warranty service, or if the vehicle was in a crash and cannot be driven. Assistance is also given when the vehicle is stuck in the sand, mud, or snow.

- **Flat Tire Change:** Service to change a flat tire with the spare tire. The spare tire, if equipped, must be in good condition and properly inflated. It is the owner's responsibility for the repair or replacement of the tire if it is not covered by the warranty.
- **Battery Jump Start:** Service to jump start a dead battery.

Services Not Included in Roadside Assistance

- Impound towing caused by violation of any laws.
- Legal fines.
- Mounting, dismounting, or changing of snow tires, chains, or other traction devices.
- Towing or services for vehicles driven on a non-public road or highway.

Services Specific to Canadian Purchased Vehicles

- **Fuel Delivery:** Reimbursement is approximately \$5 Canadian. Diesel fuel delivery may be restricted. Propane and other fuels are not provided through this service.
- **Lock-Out Service:** Vehicle registration is required.
- **Trip Routing Service:** Detailed maps of North America are provided when requested either with the most direct route or the most scenic route. There is a limit of six requests per year. Additional travel information is also available. Allow three weeks for delivery.

- **Trip Interruption Benefits and Assistance:** Must be over 250 kilometers from where your trip was started to qualify. General Motors of Canada Limited requires pre-authorization, original detailed receipts, and a copy of the repair orders. Once authorization has been received, the Roadside Assistance advisor will help to make arrangements and explain how to receive payment.
- **Alternative Service:** If assistance cannot be provided right away, the Roadside Assistance advisor may give permission to get local emergency road service. You will receive payment, up to \$100, after sending the original receipt to Roadside Assistance. Mechanical failures may be covered, however any cost for parts and labor for repairs not covered by the warranty are the owner responsibility.

Roadside Assistance Program (Mexico)

As a new owner, your vehicle is automatically enrolled in the Roadside Assistance program. The services are available at no cost under the terms and conditions of the program. The Roadside Assistance program is not part of, or included, in the coverage provided by the New Vehicle Limited Warranty.

Roadside Assistance provides assistance to the driver and passengers while driving the vehicle within your city of residence or on any passable road in Mexico, the United States, and Canada. Services are subject to the limitations described in the following pages. Program coverage varies by country.

Roadside Assistance is available 24 hours a day, 365 days of the year.

This program expires two years from the date of the invoice for the vehicle, regardless of vehicle mileage and changes in vehicle ownership.

For more information about the renewal of this program at the end of its term, contact the Chevrolet Customer Assistance Center at 01-800-466-0800.

Services Provided

- **Flat Tire Change:** If unable to change a flat tire, Roadside Assistance will provide towing service to the nearest authorized Chevrolet dealership. It is the owner's responsibility for the repair or replacement of the tire. This service is limited to the transfer of the vehicle to the repair facility.
- **Emergency Fuel Delivery:** Delivery of enough fuel for the vehicle to get to the nearest service station.

13-10 Customer Information

- **Lock-Out Service:** Service to unlock the vehicle if you are locked out.
- **Battery Jump Start:** Service to jump start a dead battery.
- ***Emergency Messages:** Transmission of urgent phone messages.
- ***Emergency Calls:** Call for emergency services.
- ***Dealership Location Assistance:** Information regarding addresses and telephone numbers for Chevrolet dealers.
- **Emergency Towing:** Tow to the nearest dealer for warranty service if the vehicle cannot be driven.

If the vehicle is involved in an accident during the commission of a crime, administrative violation, or breach of traffic regulations, Roadside Assistance will not provide

service. When the vehicle is not accessible to be towed, all maneuvers required to access it will be at the owner's expense.

If the vehicle is in another city outside of your residence, Roadside Assistance is limited to moving the vehicle to the nearest dealer. If you would like the vehicle moved to a different dealer, you will be asked to cover the difference in cost at the time of the move.

If the vehicle cannot be received by the nearest Chevrolet dealer due to scheduling conflicts, the vehicle will be taken to a safe place where it will remain for up to 48 hours until it can be taken to the dealer. If the storage costs exceed the amount authorized, the owner is responsible to pay the difference at the time of service. Contact Roadside Assistance for more information on authorized amounts.

- ***Trip Interruption:** This service is provided if you are prevented from further usage of your vehicle while traveling and it is not possible for the nearest Chevrolet dealership to repair the vehicle the same day, requiring the vehicle to stay at the dealership for a night or more. If this happens, in addition to the previously listed services and prior to confirmation by the dealership, you are entitled to choose one of the following alternatives, within the limits of existing Roadside Assistance program guidelines. If the costs exceed the amount authorized for these services, you must pay the difference at the time of service.

Roadside Assistance will coordinate hotel accommodations for all vehicle travelers for up to two nights.

A rental car will be provided for up to two days and the vehicle must be returned to its original destination, excluding vehicles with a carrying capacity greater than 3.5 tons.

Complimentary Transportation: If you prefer to continue your trip to the intended destination or return to your place of residence, and the trip requires more than eight hours driving on the road, transportation for the driver and passengers by first class bus or coach commercial airline will be provided to a location chosen by Roadside Assistance, depending on availability at the chosen destination. Restrictions apply based on vehicle specifications.

If you are on the road, taxi service to the nearest bus station or airport will be provided.

- ***Complimentary Transportation for Vehicle Pick Up:** Transportation to pick up your vehicle after repairs are complete. Once the dealer has reported that the vehicle has been repaired, Roadside Assistance will provide bus or commercial airline one-way service (subject to availability) for the person designated by you to collect your vehicle at the dealership's location if you or the designated person are not in the same town or city as the dealership.

*These services are not provided for U.S. or Canada residents. All services provided in the U.S. and Canada are at the owner's expense and will be reimbursed by Roadside Assistance.

Services Not Included in Roadside Assistance

Roadside Assistance does not cover or reimburse services for the following:

- Events caused by fraud or bad faith by the driver.
- Vehicle immobilization situations due to a major force or unforeseen circumstances, such as natural phenomena of an extraordinary nature, earthquakes, volcanic eruptions, and other cyclonic storms.
- Vehicle immobilization situations arising from car accidents caused by the driver of the vehicle or third parties. This means any occurrence that causes physical injury to the occupants and/or the vehicle caused by external forces.
- Acts of terrorism, riot or uproar, armed forces or police actions which prevent timely delivery of assistance services.

13-12 Customer Information

- Food service, beverages, telephone calls, or other extra costs. Accommodation costs apply only to Mexico per the terms and conditions of the Roadside Assistance program.
- Any damage to the vehicle without intent, derived from the services provided.
- Cost of towing a trailer when choosing a Chevrolet dealer that is nearest to the temporary storage facility for the disabled vehicle.
- Cost of all maneuvers required to access the vehicle when it is not available to be towed.
- Cost of fuel provided.

Routine vehicle repair costs are not covered by the Roadside Assistance program. For more information, see your new vehicle warranty.

Contacting Roadside Assistance

Roadside Assistance services are of no cost to you and available 24 hours a day, 365 days a year. Costs are only incurred in situations that exceed the limits of the program, some of which are listed previously in this section.

To contact Roadside Assistance by phone, use the following numbers:

Mexico

01-800-466-0800

United States

1-866-466-8901

Canada

1-800-268-6800

E-mail

asistencia.chevrolet@gm.com

Chevrolet reserves the right to make any changes or discontinue the Roadside Assistance program at any time without notification.

Scheduling Service Appointments (U.S. and Canada)

When the vehicle requires warranty service, contact your dealer and request an appointment. By scheduling a service appointment and advising the service consultant of your transportation needs, your dealer can help minimize your inconvenience.

If the vehicle cannot be scheduled into the service department immediately, keep driving it until it can be scheduled for service, unless, of course, the problem is safety related. If it is, please call your dealership, let them know this, and ask for instructions.

If your dealer requests you to bring the vehicle for service, you are urged to do so as early in the work day as possible to allow for same-day repair.

Courtesy Transportation Program (U.S. and Canada)

To enhance your ownership experience, we and our participating dealers are proud to offer Courtesy Transportation, a customer support program for vehicles with the Bumper-to-Bumper (Base Warranty Coverage period in Canada), extended powertrain, and/or hybrid-specific warranties in both the U.S. and Canada.

Several Courtesy Transportation options are available to assist in reducing inconvenience when warranty repairs are required.

Courtesy Transportation is not a part of the New Vehicle Limited Warranty. A separate booklet entitled "Limited Warranty and Owner Assistance Information" furnished with each new vehicle provides detailed warranty coverage information.

Transportation Options

Warranty service can generally be completed while you wait. However, if you are unable to wait, GM helps to minimize inconvenience by providing several transportation options. Depending on the circumstances, your dealer can offer one of the following:

Shuttle Service

Shuttle service is the preferred means of offering Courtesy Transportation. Dealers may provide shuttle service to get you to your destination with minimal interruption of your daily schedule. This includes one-way or round-trip shuttle service within reasonable time and distance parameters of your dealer's area.

Public Transportation or Fuel Reimbursement

If the vehicle requires overnight warranty repairs, and public transportation is used instead of your dealer's shuttle service, the expense must be supported by

original receipts and can only be up to the maximum amount allowed by GM for shuttle service. In addition, for U.S. customers, should you arrange transportation through a friend or relative, limited reimbursement for reasonable fuel expenses may be available. Claim amounts should reflect actual costs and be supported by original receipts. See your dealer for information regarding the allowance amounts for reimbursement of fuel or other transportation costs.

Courtesy Rental Vehicle

Your dealer may arrange to provide you with a courtesy rental vehicle or reimburse you for a rental vehicle that you obtain if the vehicle is kept for an overnight warranty repair. Rental reimbursement will be limited and must be supported by original receipts. This requires that you sign and complete a rental agreement and meet state/provincial, local, and rental vehicle provider requirements. Requirements vary and may include minimum age requirements,

13-14 Customer Information

insurance coverage, credit card, etc. You are responsible for fuel usage charges and may also be responsible for taxes, levies, usage fees, excessive mileage, or rental usage beyond the completion of the repair.

It may not be possible to provide a like vehicle as a courtesy rental.

Additional Program Information

All program options, such as shuttle service, may not be available at every dealer. Please contact your dealer for specific information about availability. All Courtesy Transportation arrangements will be administered by appropriate dealer personnel.

General Motors reserves the right to unilaterally modify, change, or discontinue Courtesy Transportation at any time and to resolve all questions of claim eligibility pursuant to the terms and conditions described herein at its sole discretion.

Collision Damage Repair (U.S. and Canada)

If the vehicle is involved in a collision and it is damaged, have the damage repaired by a qualified technician using the proper equipment and quality replacement parts. Poorly performed collision repairs diminish the vehicle resale value, and safety performance can be compromised in subsequent collisions.

Collision Parts

Genuine GM Collision parts are new parts made with the same materials and construction methods as the parts with which the vehicle was originally built. Genuine GM Collision parts are the best choice to ensure that the vehicle's designed appearance, durability, and safety are preserved. The use of Genuine GM parts can help maintain the GM New Vehicle Limited Warranty.

Recycled original equipment parts may also be used for repair. These parts are typically removed from vehicles that were total losses in prior crashes. In most cases, the parts being recycled are from undamaged sections of the vehicle. A recycled original equipment GM part may be an acceptable choice to maintain the vehicle's originally designed appearance and safety performance; however, the history of these parts is not known. Such parts are not covered by the GM New Vehicle Limited Warranty, and any related failures are not covered by that warranty.

Aftermarket collision parts are also available. These are made by companies other than GM and may not have been tested for the vehicle. As a result, these parts may fit poorly, exhibit premature durability/corrosion problems, and may not perform properly in subsequent collisions. Aftermarket parts are not covered by the GM New Vehicle

Limited Warranty, and any vehicle failure related to such parts is not covered by that warranty.

Repair Facility

GM also recommends that you choose a collision repair facility that meets your needs before you ever need collision repairs. Your dealer may have a collision repair center with GM-trained technicians and state-of-the-art equipment, or be able to recommend a collision repair center that has GM-trained technicians and comparable equipment.

Insuring the Vehicle

Protect your investment in the GM vehicle with comprehensive and collision insurance coverage. There are significant differences in the quality of coverage afforded by various insurance policy terms. Many insurance policies provide reduced protection to the GM vehicle by limiting compensation for

damage repairs through the use of aftermarket collision parts. Some insurance companies will not specify aftermarket collision parts. When purchasing insurance, we recommend that you ensure that the vehicle will be repaired with GM original equipment collision parts. If such insurance coverage is not available from your current insurance carrier, consider switching to another insurance carrier.

If the vehicle is leased, the leasing company may require you to have insurance that ensures repairs with Genuine GM Original Equipment Manufacturer (OEM) parts or Genuine Manufacturer replacement parts. Read the lease carefully, as you may be charged at the end of the lease for poor quality repairs.

If a Crash Occurs

If there has been an injury, call emergency services for help. Do not leave the scene of a crash until all matters have been taken care of.

Move the vehicle only if its position puts you in danger, or you are instructed to move it by a police officer.

Give only the necessary information to police and other parties involved in the crash.

For emergency towing see *Roadside Assistance Program (U.S. and Canada)* on page 13-7 or *Roadside Assistance Program (Mexico)* on page 13-9.

Gather the following information:

- Driver name, address, and telephone number.
- Driver license number.
- Owner name, address, and telephone number.
- Vehicle license plate number.
- Vehicle make, model, and model year.
- Vehicle Identification Number (VIN).

13-16 Customer Information

- Insurance company and policy number.
- General description of the damage to the other vehicle.

Choose a reputable repair facility that uses quality replacement parts. See “Collision Parts” earlier in this section.

If the airbag has inflated, see *What Will You See after an Airbag Inflates?* on page 3-22.

Managing the Vehicle Damage Repair Process

In the event that the vehicle requires damage repairs, GM recommends that you take an active role in its repair. If you have a pre-determined repair facility of choice, take the vehicle there, or have it towed there. Specify to the facility that any required replacement collision parts be original equipment parts, either new Genuine GM parts or recycled original GM parts. Remember, recycled parts will not be covered by the GM vehicle warranty.

Insurance pays the bill for the repair, but you must live with the repair. Depending on your policy limits, your insurance company may initially value the repair using aftermarket parts. Discuss this with the repair professional, and insist on Genuine GM parts. Remember, if the vehicle is leased, you may be obligated to have the vehicle repaired with Genuine GM parts, even if your insurance coverage does not pay the full cost.

If another party's insurance company is paying for the repairs, you are not obligated to accept a repair valuation based on that insurance company's collision policy repair limits, as you have no contractual limits with that company. In such cases, you can have control of the repair and parts choices as long as the cost stays within reasonable limits.

Service Publications Ordering Information

Service Manuals

Service Manuals have the diagnosis and repair information on the engines, transmission, axle, suspension, brakes, electrical, steering, body, etc.

Service Bulletins

Service Bulletins give additional technical service information needed to knowledgeably service General Motors cars and trucks. Each bulletin contains instructions to assist in the diagnosis and service of the vehicle.

Owner Information

Owner publications are written specifically for owners and intended to provide basic operational information about the vehicle. The Owner Manual includes the Maintenance Schedule for all models.

In-Portfolio: Includes a Portfolio, Owner Manual, and Warranty Booklet.

RETAIL SELL PRICE:
\$35.00 (U.S.) plus handling and shipping fees.

Without Portfolio: Owner Manual only.

RETAIL SELL PRICE:
\$25.00 (U.S.) plus handling and shipping fees.

Current and Past Models

Technical Service Bulletins and Manuals are available for current and past model GM vehicles.

ORDER TOLL FREE:
1-800-551-4123 Monday – Friday
8:00 AM – 6:00 PM Eastern Time

For Credit Card Orders Only
(VISA-MasterCard-Discover), visit
Helm, Inc. at: www.helminc.com.

Or write to:

Helm, Incorporated
Attention: Customer Service
47911 Halyard Drive
Plymouth, MI 48170

Prices are subject to change without notice and without incurring obligation. Allow ample time for delivery.

All listed prices are quoted in U.S. funds. Make checks payable in U.S. funds.

Reporting Safety Defects

Reporting Safety Defects to the United States Government

If you believe that your vehicle has a defect which could cause a crash or could cause injury or death, you should immediately inform the National Highway Traffic Safety Administration (NHTSA) in addition to notifying General Motors.

If NHTSA receives similar complaints, it may open an investigation, and if it finds that a safety defect exists in a group of vehicles, it may order a recall and remedy campaign. However, NHTSA cannot become involved in individual problems between you, your dealer, or General Motors.

13-18 Customer Information

To contact NHTSA, you may call the Vehicle Safety Hotline toll-free at 1-888-327-4236 (TTY: 1-800-424-9153); go to <http://www.safercar.gov>; or write to:

Administrator, NHTSA
1200 New Jersey Avenue, S.E.
Washington, D.C. 20590

You can also obtain other information about motor vehicle safety from <http://www.safercar.gov>.

Reporting Safety Defects to the Canadian Government

If you live in Canada, and you believe that the vehicle has a safety defect, notify Transport Canada immediately, and notify General Motors of Canada Limited. Call Transport Canada at 1-800-333-0510 or write to:

Transport Canada
Road Safety Branch
80 rue Noel
Gatineau, QC J8Z 0A1

Reporting Safety Defects to General Motors

In addition to notifying NHTSA (or Transport Canada) in a situation like this, notify General Motors.

Call 1-800-222-1020, or write:

Chevrolet Motor Division
Chevrolet Customer
Assistance Center
P.O. Box 33170
Detroit, MI 48232-5170

In Canada, call 1-800-263-3777 (English) or 1-800-263-7854 (French), or write:

General Motors of Canada Limited
Customer Care Centre,
Mail Code: CA1-163-005
1908 Colonel Sam Drive
Oshawa, Ontario L1H 8P7

Vehicle Data Recording and Privacy

The vehicle has a number of computers that record information about the vehicle's performance and how it is driven. For example, the vehicle uses computer modules to monitor and control engine and transmission performance, to monitor the conditions for airbag deployment and deploy them in a crash, and, if equipped, to provide antilock braking to help the driver control the vehicle. These modules may store data to help the dealer technician service the vehicle. Some modules may also store data about how the vehicle is operated, such as rate of fuel consumption or average speed. These modules may retain personal preferences, such as radio presets, seat positions, and temperature settings.

Vehicle Data Recording

This vehicle may be equipped with a module that records data in certain crash or near crash-like situations, such as when an air bag deploys or the vehicle hits a road obstacle.

This data could help provide a better understanding of the circumstances in which crashes and injuries occur. Some data may be related to the vehicle dynamics and safety systems operation. The data may show:

- How various systems in the vehicle were operating.
- Whether or not the driver and passenger safety belts were buckled/fastened.
- If and how far the driver was pressing the accelerator and/or brake pedal.
- How fast the vehicle was traveling.

This data could provide an understanding of the circumstances in which crashes and injuries occur. Data could be recorded by the vehicle only if a non-trivial crash situation occurs; no data are recorded under normal driving conditions and no personal data are recorded. However, other parties, such as law enforcement, could combine recorded data with the type of personally identifying data routinely acquired during a crash investigation.

To read recorded data, special equipment is required, and access to the vehicle or the module is needed. In addition to the vehicle manufacturer, other parties, such as law enforcement, that have the special equipment, can read the information if they have access to the vehicle or the module.

GM will not access this data or share it with others except: with the consent of the vehicle owner or, if the vehicle is leased, with the consent of the lessee; in response to an official request by police or similar government office; as part of GM's defense of litigation through the discovery process; or, as required by law. Data that GM collects or receives may also be used for GM research needs or may be made available to others for research purposes, where a need is shown and the data is not tied to a specific vehicle or vehicle owner.

OnStar®

If the vehicle has OnStar® and an active subscription to the OnStar® services, refer to the OnStar® Terms and Conditions for information on data collection and use. See *OnStar Overview on page 14-1*.

Radio Frequency Identification (RFID)

RFID technology is used in some vehicles for functions such as tire pressure monitoring and ignition system security, as well as in connection with conveniences such as Remote Keyless Entry (RKE) transmitters for remote door locking/unlocking and starting, and in-vehicle transmitters for garage door openers. RFID technology in GM vehicles does not use or record personal information or link with any other GM system containing personal information.

Radio Frequency Statement

This vehicle has systems that operate on a radio frequency that comply with Part 15 of the Federal Communications Commission (FCC) rules and with Industry Canada Standards RSS-GEN/210/220/310.

Operation is subject to the following two conditions:

1. The device may not cause harmful interference.
2. The device must accept any interference received, including interference that may cause undesired operation of the device.

Changes or modifications to any of these systems by other than an authorized service facility could void authorization to use this equipment.

OnStar

OnStar Overview

OnStar Overview 14-1

OnStar Services

Emergency 14-2

Security 14-2

Navigation 14-2

Connections 14-3

Diagnostics 14-5

OnStar Additional Information

OnStar Additional
Information 14-5

OnStar Overview



If equipped, this vehicle has a comprehensive, in-vehicle system that can connect to a live Advisor for Emergency, Security, Navigation, Connection, and Diagnostic Services.

The OnStar system status light is next to the OnStar buttons. If the status light is:

- Solid Green: System is ready.
- Flashing Green: On a call.
- Red: Indicates a problem.

Push  or call 1-888-4-ONSTAR (1-888-466-7827) to speak to an Advisor.

Push  to:

- Make a call, end a call, or answer an incoming call.
- Give OnStar Hands-Free Calling voice commands.
- Give OnStar Turn-by-Turn Navigation voice commands. Requires the available Directions and Connections service plan.

Push  to connect to a live Advisor to:

- Verify account information or update contact information.
- Get driving directions. Requires the available Directions and Connections service plan.
- Receive On-Demand Diagnostics for a check on the vehicle's key operating systems.
- Receive Roadside Assistance.

Push  to get a priority connection to an Emergency Advisor available 24/7 to:

- Get help for an emergency.
- Be a Good Samaritan or respond to an AMBER Alert.
- Get crisis assistance and evacuation routes.

OnStar Services

Emergency

With Automatic Crash Response, the built-in system can automatically connect to help in a crash even if you cannot ask for it.

Push  to connect to an Emergency Advisor. GPS technology is used to identify the vehicle location and can provide critical information to emergency personnel. The Advisor is also trained to offer critical assistance in emergency situations.

Security

OnStar provides services like Stolen Vehicle Assistance, Remote Ignition Block, and Roadside Assistance, if the vehicle is equipped with these services. OnStar can unlock the vehicle doors remotely, if it is equipped with automatic door locks, and can help police locate the vehicle if it is stolen.

Navigation

OnStar navigation requires the Directions and Connections service plan.

Push  to receive directions or have them sent to the vehicle navigation screen. Destinations can also be forwarded to the vehicle from Google Maps™ or MapQuest.com. The OnStar mapping database is continuously updated. Visit www.onstar.com for coverage maps.

Turn-by-Turn Navigation

1. Push  to connect to a live Advisor.
2. Request directions.
3. Directions are downloaded to the vehicle.
4. Follow the voice-guided commands.

Using Voice Commands During a Planned Route

Cancel Route

1. Push . System responds: "OnStar ready," then a tone. Say "Cancel route." System responds: "Would you like to cancel route directions to your destination?"
2. Say "Yes." System responds: "OK, route canceled."
3. Say "Goodbye." Exits voice commands.

Route Preview

1. Push . System responds: "OnStar ready," then a tone.
2. Say "Route Preview." System responds with the next three maneuvers.
3. Say "Goodbye." Exits voice commands.

Repeat

1. Push . System responds: "OnStar ready," then a tone.
2. Say "Repeat." System responds with the last direction given, then responds with "OnStar ready," then a tone.
3. Say "Goodbye." Exits voice commands.

Get My Destination

1. Push . System responds: "OnStar ready," then a tone.
2. Say "Get my destination." System responds with miles to the destination, then responds with "OnStar ready," then a tone.
3. Say "Goodbye." Exits voice commands.

Other Navigation Services Available from OnStar

OnStar eNav: Allows subscribers to send destinations from Google Maps™ and MapQuest.com to their

Turn-by-Turn Navigation or screen-based navigation system. When ready, the directions will be downloaded to the vehicle.

Destination Download: Push , then request the Advisor to download directions to the navigation system in the vehicle. After the call ends, push the "Go" button on the navigation screen to begin driving directions.

Destinations can also be downloaded on the go. For information about eNav, Destination Download, and coverage maps visit www.onstar.com.

Connections

OnStar Hands-Free Calling allows calls to be made and received from the vehicle. The vehicle can also be controlled from a cell phone through the OnStar mobile app. See www.onstar.com for coverage maps.

Hands-Free Calling

1. Push . System responds: "OnStar ready."
2. Say "Dial." System responds: "Please say the name or number to call."
3. Say the entire number without pausing, including a "1" and the area code. System responds: "OK calling."

Retrieve My Number

1. Push . System responds: "OnStar ready."
2. Say "My Number." System responds: "Your OnStar Hands-Free Calling number is."

End a Call

Push . System responds: "Call ended."

Store a Name Tag for Speed Dialing

1. Push . System responds: "OnStar ready."
2. Say "Store." System responds: "Please say the number you would like to store."
3. Say the entire number without pausing. System responds: "Please say the name tag."
4. Pick a name tag. "System responds: "About to store <name tag>. Does that sound OK?"
5. Say "Yes" or "No" to try again. System responds: "OK, storing <name tag>."

Place a Call Using a Stored Number

1. Push . System responds: "OnStar ready."
2. Say "Call <name tag>." System responds: "OK, calling <name tag>."

Verify Minutes and Expiration

Push  and say "minutes" then "verify" to check how many minutes remain and their expiration date.

OnStar Mobile App

With an iPhone® or Android™-based mobile device, an OnStar mobile app can be downloaded. The vehicle can be remote started, if equipped, or the doors can be unlocked from anywhere there is cell phone service. It can also check the fuel level, tire pressure, and oil life. It can connect to an OnStar Advisor anytime. For OnStar mobile app compatibility or further information, see www.onstar.com.

Diagnostics

OnStar Vehicle Diagnostics will perform a vehicle check every month. It will check the engine, transmission, antilock brakes, and major vehicle systems. It also checks the tire pressures, if the vehicle is equipped with the Tire Pressure Monitoring System. If a diagnostics check is needed between e-mails, push , and an Advisor can run a check.

OnStar Additional Information

Transferring Service

Push  to request account transfer eligibility information. The Advisor can assist in canceling or removing account information. If OnStar receives information that vehicle ownership has changed, OnStar may send a voice message to the vehicle, requesting updated account information.

Reactivation for Subsequent Owners

Push  and follow the prompts to speak to an Advisor as soon as possible after acquiring the vehicle. The Advisor will update vehicle records and will explain the OnStar service offers and options available.

How OnStar Service Works

Automatic Crash Response, Emergency Services, Crisis Assist, Stolen Vehicle Assistance, Vehicle Diagnostics, Remote Door Unlock, Roadside Assistance, Turn-by-Turn Navigation, and Hands-Free Calling are available on most vehicles. Not all OnStar services are available everywhere or on all vehicles. For more information, a full description of OnStar services, system limitations, and OnStar terms and conditions, see www.onstar.com (U.S.) or www.onstar.ca (Canada); contact OnStar at 1-888-4-ONSTAR (1-888-466-7827) or TTY 1-877-248-2080; or push  to speak with an Advisor.

OnStar services require a vehicle electrical system, wireless service, and GPS satellite technologies to be available and operating for features to function properly. These systems may not operate if the battery is discharged or disconnected.

OnStar service cannot work unless your vehicle is in a place where OnStar has an agreement with a wireless service provider for service in that area, and the wireless service provider has coverage, network capacity, reception, and technology compatible with OnStar's service. Service involving location information about the vehicle cannot work unless GPS signals are available, unobstructed, and compatible with the OnStar hardware. OnStar service may not

work if the OnStar equipment is not properly installed or it has not been properly maintained. If equipment or software is added, connected, or modified, OnStar service may not work. Other problems beyond OnStar's control may prevent service such as hills, tall buildings, tunnels, weather, electrical system design and architecture of the vehicle, damage to the vehicle in a crash, or wireless phone network congestion or jamming.

See *Radio Frequency Statement on page 13-20* for information regarding Part 15 of the Federal Communications Commission (FCC) rules and Industry Canada Standards RSS-GEN/210/220/310.

Services for People with Disabilities

Advisors provide services to help subscribers with physical disabilities and medical conditions.

Push  for help with:

- Locating a gas station with an attendant to pump gas.
- Finding a hotel, restaurant, etc., that meets accessibility needs.
- Providing directions to the closest hospital or pharmacy in urgent situations.

TTY Users

OnStar has the ability to communicate to the deaf, hard-of-hearing, or speech-impaired customers while in the vehicle. The available dealer-installed TTY system can provide in-vehicle access to all of the OnStar services, except Virtual Advisor and OnStar Turn-by-Turn Navigation.

Onstar.com

The website provides access to account information, manages the OnStar subscription, and allows viewing of videos of each service. Get subscription plan pricing and sign up for OnStar Vehicle Diagnostics. Click on the “My Account” tab on the home page.

OnStar Personal Identification Number (PIN)

A PIN is needed to access some of the OnStar services, like Remote Door Unlock and Stolen Vehicle Assistance. You will be prompted to change the PIN the first time when speaking with an Advisor. To change the OnStar PIN, call OnStar and provide the Advisor with the current number.

Warranty

OnStar equipment may be warranted as part of the new-vehicle limited warranty. The manufacturer of the vehicle furnishes detailed warranty information.

Languages

The vehicle can be programmed to respond in French or Spanish.

Push  and ask an Advisor.

Advisors can speak French or Spanish.

Potential Issues

Some OnStar services are disabled after five days. OnStar cannot perform Remote Door Unlock or Stolen Vehicle Assistance after the vehicle has been off continuously for five days. After five days, OnStar can contact Roadside Assistance and a locksmith to help gain access to the vehicle.

Global Positioning System (GPS)

- Obstruction of the GPS can occur in a large city with tall buildings; in parking garages; around airports; in tunnels, underpasses, or parking garages; or in an area with very dense trees. If GPS signals are not available, the OnStar system should still operate to call OnStar. However, OnStar could have difficulty identifying the exact location.
- In emergency situations, OnStar can use the last stored GPS location to send to emergency responders.
- A temporary loss of GPS can cause loss of the ability to send a Turn-by-Turn Navigation route. The Advisor may give a verbal route or may ask for a call back after the vehicle is driven into an open area.

Cellular and GPS Antennas

Avoid placing items over or near the antenna to prevent blocking cellular and GPS signal reception. Cellular reception is required for OnStar to send remote signals to the vehicle.

Unable to Connect to OnStar Message

If there is limited cellular coverage or the cellular network has reached maximum capacity, this message may come on. Push  to try the call again or try again after driving a few miles into another cellular area.

Vehicle and Power Issues

OnStar services require a vehicle electrical system, wireless service, and GPS satellite technologies to be available and operating for features to function properly. These systems may not operate if the battery is discharged or disconnected.

Add-on Electrical Equipment

The OnStar system is integrated into the electrical architecture of the vehicle. Do not add any electrical equipment. See *Add-On Electrical Equipment on page 9-45*. Added electrical equipment may interfere with the operation of the OnStar system and cause it to not operate.

Privacy

The complete OnStar Privacy Statement may be found at www.onstar.com. Privacy-sensitive users of wireless communications are cautioned that the privacy of any information sent via wireless cellular communications cannot be assured. Third parties may unlawfully intercept or access transmissions and private communications without consent.

A

Accessories and
Modifications 10-3

Accessory Power 9-18

Add-On Electrical
Equipment 9-45

Additional Information,
OnStar® 14-5

Adjustments
Lumbar, Front Seats 3-4

Air Cleaner/Filter, Engine 10-12

Air Conditioning 8-5

Air Vents 8-9

Airbag System
Check 3-29
How Does an Airbag
Restrain? 3-22
Passenger Sensing
System 3-24
What Makes an Airbag
Inflate? 3-22
What Will You See after an
Airbag Inflates? 3-22

Airbag System (cont'd)
When Should an Airbag
Inflate? 3-21
Where Are the Airbags? 3-19

Airbags
Adding Equipment to the
Vehicle 3-28
Passenger Status Indicator 5-13
Readiness Light 5-12
Servicing Airbag-Equipped
Vehicles 3-28
System Check 3-17

Alarm System
Anti-theft 2-11

AM-FM Radio 7-6

Antenna
Satellite Radio 7-13

Anti-theft
Alarm System 2-11

Antilock Brake
System (ABS) 9-25
Warning Light 5-17

Appearance Care
Exterior 10-82
Interior 10-85

Assistance Program,
Roadside 13-7, 13-9

Audio Players 7-13
CD 7-13

Audio System
Backglass Antenna 7-12
Radio Reception 7-12
Theft-Deterrent Feature 7-2

Automatic
Climate Control System 8-5
Door Locks 2-8
Headlamp System 6-3
Transmission 9-22
Transmission Fluid 10-12

Automatic Transmission
Manual Mode 9-23
Shift Lock Control
Function Check 10-23

Auxiliary
Devices 7-18

B

Battery	10-22
Jump Starting	10-76
Load Management	6-6
Power Protection	6-7
Blade Replacement, Wiper ...	10-24
Bluetooth	7-23
Brake	
System Warning Light	5-17
Brakes	10-20
Antilock	9-25
Assist	9-26
Fluid	10-21
Parking	9-26
System Messages	5-25
Braking	9-3
Break-In, New Vehicle	9-14
Bulb Replacement	10-30
Back-up Lamps	10-28
Fog Lamps	6-5
Halogen Bulbs	10-25
Headlamp Aiming	10-25

Bulb Replacement (cont'd)	
Headlamps	10-25
License Plate Lamps	10-29
Taillamps, Turn	
Signal, and	
Stoptlamps	10-26, 10-27
Buying New Tires	10-53

C

Calibration	5-4
California	
Fuel Requirements	9-34
Perchlorate Materials	
Requirements	10-3
Warning	10-3
Canadian Vehicle Owners	iii
Capacities and	
Specifications	12-2
Carbon Monoxide	
Engine Exhaust	9-21
Trunk	2-9
Winter Driving	9-8

Cautions, Danger, and	
Warnings	iv
CD Player	7-13
Center Console Storage	4-3
Chains, Tire	10-58
Charging System Light	5-14
Check	
Engine Light	5-14
Ignition	
Transmission Lock	10-24
Child Restraints	
Infants and Young	
Children	3-32
Lower Anchors and	
Tethers for Children	3-38
Older Children	3-30
Securing	3-45, 3-47
Systems	3-34
Cleaning	
Exterior Care	10-82
Interior Care	10-85

Climate Control Systems 8-1
 Air Conditioning 8-1
 Automatic 8-5
 Heating 8-1
 Clock 5-5
 Cluster, Instrument 5-9
 Collision Damage Repair 13-14
 Compact Spare Tire 10-75
 Compass 5-4
 Compressor Kit, Tire
 Sealant 10-60
 Connections, OnStar® 14-3
 Control of a Vehicle 9-3
 Convenience Net 4-4
 Convex Mirrors 2-13
 Coolant
 Engine 10-14
 Engine Temperature
 Gauge 5-11
 Engine Temperature
 Warning Light 5-19
 Cooling System 10-13
 Courtesy Transportation
 Program 13-13

Cruise Control 9-31
 Light 5-21
 Messages 5-25
 Cupholders 4-1
 Customer Assistance 13-6
 Offices 13-4, 13-5
 Text Telephone (TTY)
 Users 13-6
 Customer Information
 Service Publications
 Ordering Information 13-16
 Customer Satisfaction
 Procedure 13-1, 13-3

D

Damage Repair, Collision 13-14
 Danger, Warnings, and
 Cautions iv
 Data Recording
 Vehicle 13-19
 Daytime Running
 Lamps (DRL) 6-2
 Defensive Driving 9-2
 Delayed Headlamps 6-4
 Delayed Locking 2-8

Devices, Auxiliary 7-18
 Diagnostics, OnStar® 14-5
 Distracted Driving 9-2
 Dome Lamps 6-6
 Door
 Ajar Messages 5-25
 Ajar Reminder 2-8
 Delayed Locking 2-8
 Locks 2-7
 Power Locks 2-7
 Drive Belt Routing, Engine 12-4
 Driver Information
 Center (DIC) 5-22
 Driving
 Characteristics and
 Towing Tips 9-39
 Defensive 9-2
 Drunk 9-3
 For Better Fuel Economy 1-21
 Highway Hypnosis 9-7
 Hill and Mountain Roads 9-7
 If the Vehicle is Stuck 9-9
 Loss of Control 9-5
 Off-Road Recovery 9-5

Driving (cont'd)	
Vehicle Load Limits	9-10
Wet Roads	9-6
Winter	9-8

E

E85 Fuel	9-36
Electrical Equipment, Add-On	9-45
Electrical System	
Engine Compartment	
Fuse Block	10-31
Fuses	10-31
Instrument Panel Fuse	
Block	10-34
Overload	10-30
Rear Compartment Fuse	
Block	10-36
Electronic Stability Control	9-29
Electronic Stability Control (ESC) Off Light	5-18

Electronic Stability Control (ESC)/Traction Control System (TCS) Indicator Warning Light	5-19
Emergency, OnStar®	14-2
Engine	
Air Cleaner/Filter	10-12
Check and Service Engine	
Soon Light	5-14
Compartment Overview	10-5
Coolant	10-14
Coolant Temperature	
Gauge	5-11
Coolant Temperature Warning Light	5-19
Cooling System	10-13
Drive Belt Routing	12-4
Exhaust	9-21
Heater	9-18
Oil Life System	10-11
Oil Messages	5-25
Overheated Protection	
Operating Mode	10-18

Engine (cont'd)	
Overheating	10-17
Power Messages	5-26
Pressure Light	5-20
Running While Parked	9-21
Starting	9-17
Entry/Exit Lighting	6-6
Equipment, Towing	9-44
Extender, Safety Belt	3-16
Exterior Lamp Controls	6-1
Exterior Lamps Off Reminder ...	6-2

F

Filter,	
Engine Air Cleaner	10-12
Flash-to-Pass	6-2
Flashers, Hazard Warning	6-4
Flat Tire	10-58
Changing	10-66
Floor Mats	10-87

Fluid
 Automatic Transmission 10-12
 Brakes 10-21
 Power Steering 10-19
 Washer 10-19
 Fog Lamps
 Bulb Replacement 6-5
 Front Seats
 Adjustment 3-3
 Heated 3-6
 Front Storage 4-2
 Fuel 9-33
 Additives 9-35
 E85 (85% Ethanol) 9-36
 Economy Driving 1-21
 Filling a Portable Fuel
 Container 9-38
 Filling the Tank 9-37
 Foreign Countries 9-35
 Gasoline Specifications 9-34
 Gauge 5-10
 Recommended 9-34
 Requirements, California 9-34
 System Messages 5-26

Fuses 10-31
 Engine Compartment
 Fuse Block 10-31
 Instrument Panel Fuse
 Block 10-34
 Rear Compartment Fuse
 Block 10-36

G

Gasoline
 Specifications 9-34
 Gauges
 Engine Coolant
 Temperature 5-11
 Fuel 5-10
 Odometer 5-10
 Speedometer 5-10
 Tachometer 5-10
 Trip Odometer 5-10
 Warning Lights and
 Indicators 5-8

General Information
 Service and Maintenance 11-1
 Towing 9-39
 Vehicle Care 10-2
 Glove Box 4-1
 GM Mobility Reimbursement
 Program 13-7

H

Halogen Bulbs 10-25
 Hazard Warning Flashers 6-4
 Head Restraints 3-2
 Headlamps
 Aiming 10-25
 Automatic 6-3
 Bulb Replacement 10-25
 Daytime Running
 Lamps (DRL) 6-2
 Delayed 6-4
 Flash-to-Pass 6-2
 High-Beam On Light 5-21
 High/Low Beam Changer 6-2

Heated Front Seats 3-6
Heated Mirrors 2-14
Heater
 Engine 9-18
Heating and Air
 Conditioning 8-1, 8-5
High-Beam On Light 5-21
High-Speed Operation 10-46
Highway Hypnosis 9-7
Hill and Mountain Roads 9-7
Hood 10-4
Horn 5-3
How to Wear Safety Belts
 Properly 3-10

I

Ignition Positions 9-15
Ignition Transmission Lock
 Check 10-24
Immobilizer 2-12
Infants and Young Children,
 Restraints 3-32

Infotainment 7-1
Instrument Cluster 5-9
Instrument Panel
 Storage Area 4-1
Introduction iii

J

Jump Starting 10-76

K

Key and Lock Messages 5-26
Keyless Entry
 Remote (RKE) System 2-3
Keys 2-2

L

Labeling, Tire Sidewall 10-39
Lamps
 Daytime Running (DRL) 6-2
 Dome 6-6
 Exterior Controls 6-1

Lamps (cont'd)
 Exterior Lamps Off
 Reminder 6-2
 License Plate 10-29
 Malfunction Indicator 5-14
 Messages 5-26
 Reading 6-6
Lap-Shoulder Belt 3-11
LATCH System
 Replacing Parts after a
 Crash 3-45
LATCH, Lower Anchors and
 Tethers for Children 3-38
Light
 Electronic Stability Control
 (ESC), Off 5-18
 Electronic Stability Control
 (ESC)/Traction Control
 System (TCS) Indicator
 Warning 5-19
Lighting
 Entry/Exit 6-6
 Illumination Control 6-5
 Parade Dimming 6-6

Lights

- Airbag Readiness 5-12
- Antilock Brake System (ABS) Warning 5-17
- Brake System Warning 5-17
- Charging System 5-14
- Cruise Control 5-21
- Engine Coolant Temperature Warning 5-19
- Engine Oil Pressure 5-20
- Flash-to-Pass 6-2
- High-Beam On 5-21
- High/Low Beam Changer 6-2
- Safety Belt Reminders 5-12
- Security 5-21
- Tire Pressure 5-20
- Traction Off 5-18

Locks

- Automatic Door 2-8
- Delayed Locking 2-8
- Door 2-7

Locks (cont'd)

- Lockout Protection 2-8
- Power Door 2-7
- Safety 2-8
- Loss of Control 9-5
- Low-Profile Tires 10-39
- Lower Anchors and Tethers for Children (LATCH System) 3-38
- Lumbar Adjustment 3-4
- Front Seats 3-4

M

Maintenance

- Records 11-13
- Maintenance Schedule Recommended Fluids and Lubricants 11-11
- Malfunction Indicator Lamp 5-14
- Manual Mode 9-23

Messages

- Airbag System 5-28
- Brake System 5-25
- Door Ajar 5-25
- Engine Oil 5-25
- Engine Power 5-26
- Fuel System 5-26
- Key and Lock 5-26
- Lamp 5-26
- Ride Control System 5-26
- Service Vehicle 5-28
- Tire 5-28
- Vehicle 5-25
- Vehicle Reminder 5-29
- Washer Fluid 5-29

Mirrors

- Automatic Dimming Rearview 2-14
- Convex 2-13
- Heated 2-14
- Manual Rearview 2-14
- Power 2-14

Monitor System, Tire Pressure 10-47

N

- Navigation
 - OnStar® 14-2
- Net, Convenience 4-4
- New Vehicle Break-In 9-14

O

- Odometer 5-10
 - Trip 5-10
- Off-Road
 - Recovery 9-5
- Oil
 - Engine 10-8
 - Engine Oil Life System 10-11
 - Messages 5-25
 - Pressure Light 5-20
- Older Children, Restraints 3-30
- Online Owner Center 13-6
- OnStar®
 - Additional Information 14-5
 - Connections 14-3
 - Diagnostics 14-5

- OnStar® (cont'd)
 - Emergency 14-2
 - Navigation 14-2
 - Overview 14-1
 - Security 14-2
 - System, In Brief 1-22
- Operation, Infotainment
 - System 7-2
- Ordering
 - Service Publications 13-16
- Outlets
 - Power 5-7
- Overheated Engine
 - Protection
 - Operating Mode 10-18
- Overheating, Engine 10-17
- Overview, OnStar® 14-1

P

- Parade Dimming 6-6
- Park
 - Shifting Into 9-19
 - Shifting Out of 9-20

- Parking
 - Brake 9-26
 - Brake and P (Park)
 - Mechanism Check 10-24
 - Over Things That Burn 9-20
- Passenger Airbag Status
 - Indicator 5-13
- Passenger Sensing System ... 3-24
- Perchlorate Materials
 - Requirements, California 10-3
- Personalization
 - Vehicle 5-29
- Phone
 - Bluetooth 7-23
- Power
 - Door Locks 2-7
 - Mirrors 2-14
 - Outlets 5-7
 - Protection, Battery 6-7
 - Retained Accessory (RAP) ... 9-18
 - Seat Adjustment 3-4
 - Steering Fluid 10-19
 - Windows 2-16

Pregnancy, Using Safety Belts 3-15

Privacy

 Radio Frequency Identification (RFID) 13-20

Program

 Courtesy Transportation 13-13

Proposition 65 Warning, California 10-3

R

Radio Frequency Identification (RFID) 13-20

 Statement 13-20

Radios

 AM-FM Radio 7-6

 Reception 7-12

 Satellite 7-8

Reading Lamps 6-6

Rear Seats 3-7

Rearview Mirrors 2-14

 Automatic Dimming 2-14

Reclining Seatbacks 3-4

Recommended

 Fuel 9-34

Recommended Fluids and Lubricants 11-11

Records

 Maintenance 11-13

Recreational Vehicle

 Towing 10-80

Reimbursement Program, GM Mobility 13-7

Remote Keyless Entry (RKE) System 2-2, 2-3

Remote Vehicle Start 2-5

Replacement Bulbs 10-30

Replacement Parts

 Airbags 3-29

 Maintenance 11-12

Replacing Airbag System 3-29

Replacing LATCH System

 Parts after a Crash 3-45

Replacing Safety Belt System Parts after a Crash ... 3-16

Reporting Safety Defects

 Canadian Government 13-18

 General Motors 13-18

 U.S. Government 13-17

Restraints

 Where to Put 3-36

Retained Accessory Power (RAP) 9-18

Ride Control Systems 9-29

 Electronic Stability (ESC) 9-29

 Messages 5-26

Roads

 Driving, Wet 9-6

Roadside Assistance

 Program 13-7, 13-9

Roof

 Sunroof 2-18

Rotation, Tires 10-51

Routing, Engine Drive Belt 12-4

Running the Vehicle While Parked 9-21

S

- Safety Belts 3-8
 - Care 3-16
 - Extender 3-16
 - How to Wear Safety Belts
 - Properly 3-10
 - Lap-Shoulder Belt 3-11
 - Reminders 5-12
 - Replacing after a Crash 3-16
 - Use During Pregnancy 3-15
- Safety Defects Reporting
 - Canadian Government 13-18
 - General Motors 13-18
 - U.S. Government 13-17
- Safety Locks 2-8
- Safety System Check 3-16
- Satellite Radio 7-8
- Scheduling Appointments 13-12
- Sealant Kit, Tire 10-60
- Seats
 - Adjustment, Front 3-3
 - Head Restraints 3-2
 - Heated Front 3-6
 - Lumbar Adjustment, Front 3-4
- Seats (cont'd)
 - Power Adjustment, Front 3-4
 - Rear 3-7
 - Reclining Seatbacks 3-4
- Securing Child Restraints 3-45, 3-47
- Security
 - Light 5-21
 - OnStar® 14-2
 - Vehicle 2-11
- Service
 - Accessories and Modifications 10-3
 - Doing Your Own Work 10-4
 - Engine Soon Light 5-14
 - Maintenance Records 11-13
 - Maintenance, General
 - Information 11-1
 - Parts Identification Label 12-1
 - Publications Ordering
 - Information 13-16
 - Scheduling Appointments ... 13-12
 - Vehicle Messages 5-28
- Servicing the Airbag 3-28
- Shift Lock Control Function
 - Check, Automatic Transmission 10-23
- Shifting
 - Into Park 9-19
 - Out of Park 9-20
- Signals, Turn and Lane-Change 6-4
- Spare Tire
 - Compact 10-75
- Specifications and Capacities 12-2
- Speedometer 5-10
- Start Vehicle, Remote 2-5
- Starter Switch Check 10-23
- Starting the Engine 9-17
- Steering 9-3
 - Fluid, Power 10-19
 - Wheel Adjustment 5-2
 - Wheel Controls 5-2

Storage Areas
 Center Console 4-3
 Convenience Net 4-4
 Front 4-2
 Glove Box 4-1
 Instrument Panel 4-1
 Storing the Tire Sealant
 and Compressor Kit 10-66
 Stuck Vehicle 9-9
 Sun Visors 2-17
 Sunroof 2-18
 Symbols iv
 System
 Infotainment 7-1

T

Tachometer 5-10
 Taillamps
 Turn Signal and
 Stoplamps 10-26, 10-27
 Text Telephone (TTY) Users ... 13-6
 Theft-Deterrent Systems 2-12
 Immobilizer 2-12

Time 5-5
 Tires
 Buying New Tires 10-53
 Chains 10-58
 Changing 10-66
 Compact Spare 10-75
 Designations 10-42
 Different Size 10-55
 If a Tire Goes Flat 10-58
 Inflation Monitor System ... 10-48
 Inspection 10-51
 Low Profile 10-39
 Messages 5-28
 Pressure 10-46
 Pressure Light 5-20
 Pressure Monitor System ... 10-47
 Rotation 10-51
 Sealant and
 Compressor Kit 10-60
 Sealant and Compressor
 Kit, Storing 10-66
 Sidewall Labeling 10-39

Tires (cont'd)
 Terminology and
 Definitions 10-42
 Uniform Tire Quality
 Grading 10-55
 Wheel Alignment and Tire
 Balance 10-57
 Wheel Replacement 10-57
 When It Is Time for New
 Tires 10-52
 Winter 10-39
 Towing
 Driving Characteristics 9-39
 Equipment 9-44
 General Information 9-39
 Recreational Vehicle 10-80
 Trailer 9-42
 Vehicle 10-79
 Traction
 Control System (TCS) 9-27
 Off Light 5-18

Trailer	
Towing	9-42
Transmission	
Automatic	9-22
Fluid, Automatic	10-12
Transportation Program,	
Courtesy	13-13
Trip Odometer	5-10
Trunk	2-9
Turn and Lane-Change	
Signals	6-4

U

Uniform Tire Quality	
Grading	10-55
Using This Manual	iv

V

Vehicle	
Canadian Owners	iii
Control	9-3
Identification	
Number (VIN)	12-1

Vehicle (cont'd)	
Load Limits	9-10
Messages	5-25
Personalization	5-29
Reminder Messages	5-29
Remote Start	2-5
Security	2-11
Towing	10-79
Vehicle Care	
Storing the Tire Sealant	
and Compressor Kit	10-66
Tire Pressure	10-45
Vehicle Data Recording	13-19
Ventilation, Air	8-9
Visors	2-17

W

Warning	
Brake System Light	5-17
Warning Lights, Gauges, and	
Indicators	5-8

Warnings	iv
Cautions and Danger	iv
Hazard Flashers	6-4
Washer Fluid	10-19
Messages	5-29
Wheels	
Alignment and Tire	
Balance	10-57
Different Size	10-55
Replacement	10-57
When It Is Time for New	
Tires	10-52
Where to Put the Restraint	3-36
Windows	2-15
Power	2-16
Windshield	
Wiper/Washer	5-3
Winter	
Driving	9-8
Winter Tires	10-39
Wiper Blade Replacement	10-24