

'98

CORVETTE



**Chevrolet
backs every
1998 Corvette
under warranty
with the
following
services**

**Bumper-to-Bumper
3-years/36,000 miles
(60 000 km)
Limited Warranty**

**Courtesy
Transportation**

**24-hour
Roadside Assistance**

1-800-243-8872

(In Canada, call 1-800-268-6800)
that provides in an emergency:

- Free locksmith/key service assistance
- Free jump starting assistance
- Free fuel delivery assistance
- Free non-warranty towing assistance

THE INFORMATION ON THE NEXT FEW PAGES IS TO HELP YOU FIND THE MOST COMMONLY REFERRED TO TOPICS QUICKLY. FOR INFORMATION NOT INCLUDED HERE, PLEASE USE THE TABLE OF CONTENTS OR THE INDEX IN THE MANUAL.

Safety

Section 1

Wearing a safety belt correctly is one of the most important things you and your passengers can do. This section contains very important information about safety belt usage, air bags and child restraints.

Adjusting the Seat

Page 1-2

One of the first things you'll probably want to do when you get in your new vehicle is adjust the power seats. Depending on your vehicle, you may either be able to do this manually or with power controls.

Maintaining the Temperature

Page 3-2

Read through these pages to learn more about how to use the heating, cooling, defogging and defrosting features in your vehicle.

Setting the Clock

Page 3-12

To set clock, press and hold HR until the correct hour appears. Press and hold MN until the correct minute appears.

Features and Controls

Sections
2 & 3

Audio

Section 3

Included in this section is a picture of the overall instrument panel (page 2-0). The location of the features and controls you will use are noted here. Refer to the following pages for information about:

- Power Door Locks [Page 2-4](#)
 - Power Windows [Page 2-40](#)
 - Tilt Steering Wheel [Page 2-41](#)
 - Turn Signal Lever [Page 2-42](#)
 - Changing the High /Low Beams [Page 2-45](#)
 - Windshield Wipers and Washer [Page 2-45, 2-46](#)
 - Cruise Control [Page 2-47](#)
 - Turning on Headlamps and Other Lamps [Page 2-43](#)
 - Fog Lamps [Page 2-51](#)
 - Power/Heated Remote Control Mirrors [Page 2-54](#)
 - Warning Lights, Gages and Messages [Page 2-77](#)
 - Rear Window Defogger [Page 3-11](#)
-
- AM-FM Stereo with Cassette Tape or CD Player with Automatic Tone Control [Page 3-12, 3-17](#)
 - Trunk - Mounted CD Changer [Page 3-21](#)
 - Theft - Deterrent feature [Page 3-25](#)

**Problems That
May Occur
While
Driving**

Section 5

Although we hope you'll never run into trouble on the road, refer to the following pages for help with some of the most common problems that may occur.

- **How to turn on your hazard warning flashers** [Page 5-2](#)
- **How to jump start your vehicle** [Page 5-3](#)
- **How your vehicle should be towed** [Page 5-8](#)
- **What to do when your engine overheats** [Page 5-13](#)

**Special Features
That May Be
On Your
Vehicle**

Section 2

- **Remote Function Actuation System** [Page 2-6](#)
- **Universal Theft-Deterrent System** [Page 2-17](#)
- **PASS-Key[®]** [Page 2-18](#)
- **Selective Real Time Damping** [Page 2-39](#)
- **Security Shade** [Page 2-55](#)
- **Accessory Outlet** [Page 2-59](#)
- **Roof Panel** [Page 2-60](#)
- **Convertible Top** [Page 2-68](#)
- **Driver Information Center (DIC)** [Page 2-87](#)



The 1998 Chevrolet Corvette Owner's Manual

1-1 Seats and Restraint Systems

This section tells you how to use your seats and safety belts properly. It also explains the air bag system.

2-1 Features and Controls

This section explains how to start and operate your vehicle.

3-1 Comfort Controls and Audio Systems

This section tells you how to adjust the ventilation and comfort controls and how to operate your audio system.

4-1 Your Driving and the Road

Here you'll find helpful information and tips about the road and how to drive under different conditions.

5-1 Problems on the Road

This section tells what to do if you have a problem while driving, such as a flat tire or overheated engine, etc.

6-1 Service and Appearance Care

Here the manual tells you how to keep your vehicle running properly and looking good.

7-1 Maintenance Schedule

This section tells you when to perform vehicle maintenance and what fluids and lubricants to use.

8-1 Customer Assistance Information

This section tells you how to contact Chevrolet for assistance and how to get service and owner publications. It also gives you information on "Reporting Safety Defects" on page 8-10.

9-1 Index

Here's an alphabetical listing of almost every subject in this manual. You can use it to quickly find something you want to read.

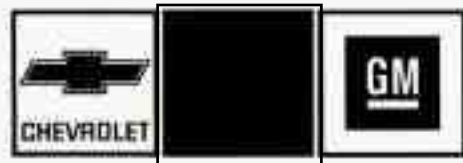

GENERAL MOTORS, GM, the GM Emblem, CHEVROLET, the CHEVROLET Emblem and the name CORVETTE are registered trademarks of General Motors Corporation.

This manual includes the latest information at the time it was printed. We reserve the right to make changes in the product after that time without further notice. For vehicles first sold in Canada, substitute the name "General Motors of Canada Limited" for Chevrolet Motor Division whenever it appears in this manual.

Please keep this manual in your vehicle, so it will be there if you ever need it when you're on the road. If you sell the vehicle, please leave this manual in it so the new owner can use it.



We support voluntary technician certification.

For Canadian Owners Who Prefer a French Language Manual:

Aux propriétaires canadiens: Vous pouvez vous procurer un exemplaire de ce guide en français chez votre concessionnaire ou au:

DGN Marketing Services Ltd.
1500 Bonhill Rd.
Mississauga, Ontario L5T 1C7

Litho in U.S.A.
Part No. 10282340 A First Edition

© Copyright General Motors Corporation 1997
All Rights Reserved



CORVETTE: THE AMERICAN DREAM MACHINE

In the early '50s, it was only a designer's dream. Today the Corvette stands alone as America's dream car -- a testament to its unmistakable charisma and the excitement it inspires. Unique styling, powerful performance and an undeniable panache have made Corvette one of the most celebrated sports cars in the world.

In 1953, Corvette produced 300 new lightweight fiberglass roadsters. A handful went to project engineers, General Motors managers, and a select group of movie stars and celebrities. With a two-speed Powerglide automatic transmission, Blue Flame six-cylinder engine, and gleaming Polo White exterior, the Corvette began its drive into the heart of America.

Designers freshened up the 'Vette in 1956 by adding a removable hardtop and the famous Corvette "coves." The sculptured body enhanced its sporty look, and a standard 210-horsepower Chevy V8 engine solidified Corvette's reputation as a production race car.

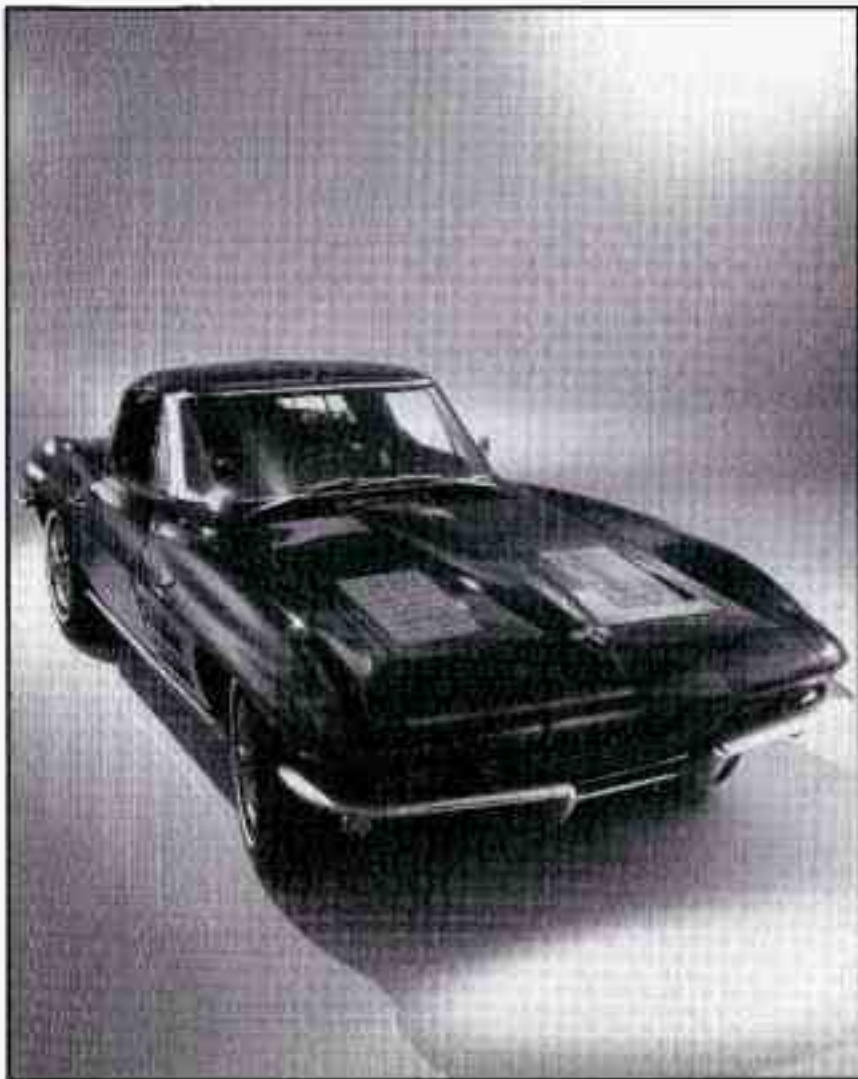

In 1963, Corvette hit the road with an eye-catching new look -- the Sting Ray coupe. An instant success, the now-classic Sting Ray featured concealed headlamps and a unique split rear window. The split window would only be offered in 1963, making this model among the most prized Corvettes ever built.



Restyled inside and out for 1968, this 'Vette sported a lean and hungry shape, creating a sense of motion even when standing still. And for the first time, Corvette offered removable roof panels.



For its 25th anniversary, the 1978 Corvette paced the 62nd Annual Indianapolis 500 and received a new fastback roofline with a wide expanse of glass that wrapped around the sides.



In 1984, the fourth generation of America's favorite sports car anticipated the future with a sleek look and advanced technology that provided superior handling and performance. Windshield angle was the sheerest of any domestic vehicle, cornering ability the tightest of any production car. In short, the 1984 redesign enhanced the Corvette's reputation as a leader in the world sports car market.

After 44 years of production, Corvette only got better. The fifth-generation Corvette arrived in 1997, featuring a completely restyled body and a new, all-aluminum, 5.7 Liter, 345-horsepower LS1 V8 engine. The structure of the fifth-generation redesign is the stiffest ever developed in 44 years of Corvette production, resulting in unparalleled ride quality and outstanding handling. Also unique to the new Corvette is a rear-mounted transmission.

Available as a Coupe for 1997, the new Corvette offered such standard features as extended-mobility tires, a Bose audio system, and a new, latch-operated roof designed for easy removal.

With many design cues inspired by the classic models of the 1960s, the new fifth-generation Corvette is an impressive combination of sleek styling and world-class sports car performance. For 1998, in addition to the Coupe, a convertible is reintroduced.



CORVETTE ASSEMBLY PLANT

The Corvette Assembly Plant in Bowling Green, Kentucky is one of the most sophisticated and computerized automobile assembly facilities in the world. To build your 1998 Corvette, over 1,025 employees teamed up with the 58 high-tech robots that assist in a variety of processes, from welding to painting.

The Bowling Green facility is Corvette's third home since 1953. Since beginning production in June of 1981, it has become one of Kentucky's most popular tourist attractions.

Corvette Assembly Plant tours are available. For dates and times, call (502) 745-8419. Reservations are required for groups of 10 or more. For more information, call (502) 745-8228.

The new National Corvette Museum, located near the assembly plant, opened its doors in September of 1994. It is also attracting tourists to the area. For more information, call 1-800-53-VETTE or (502) 781-7973.

How to Use this Manual

Many people read their owner's manual from beginning to end when they first receive their new vehicle. If you do this, it will help you learn about the features and controls for your vehicle. In this manual, you'll find that pictures and words work together to explain things quickly.

Index

A good place to look for what you need is the Index in back of the manual. It's an alphabetical list of what's in the manual, and the page number where you'll find it.

Safety Warnings and Symbols

You will find a number of safety cautions in this book. We use a box and the word **CAUTION** to tell you about things that could hurt you if you were to ignore the warning.



CAUTION:

These mean there is something that could hurt you or other people.

In the caution area, we tell you what the hazard is. Then we tell you what to do to help avoid or reduce the hazard. Please read these cautions. If you don't, you or others could be hurt.



You will also find a circle with a slash through it in this book. This safety symbol means "Don't," "Don't do this" or "Don't let this happen."

Vehicle Damage Warnings

Also, in this book you will find these notices:

NOTICE:

These mean there is something that could damage your vehicle.

In the notice area, we tell you about something that can damage your vehicle. Many times, this damage would not be covered by your warranty, and it could be costly. But the notice will tell you what to do to help avoid the damage.

When you read other manuals, you might see CAUTION and NOTICE warnings in different colors or in different words.

You'll also see warning labels on your vehicle. They use the same words, CAUTION or NOTICE.

Vehicle Symbols

These are some of the symbols you may find on your vehicle.

For example, these symbols are used on an original battery:

CAUTION
POSSIBLE
INJURY



PROTECT
EYES BY
SHIELDING



CAUSTIC
BATTERY
ACID COULD
CAUSE
BURNS



AVOID
SPARKS OR
FLAMES



SPARK OR
FLAME
COULD
EXPLODE
BATTERY



These symbols are important for you and your passengers whenever your vehicle is driven:

DOOR LOCK
UNLOCK



FASTEN
SEAT
BELTS



POWER
WINDOW



AIR BAG



These symbols have to do with your lamps:

MASTER
LIGHTING
SWITCH



TURN
SIGNALS



PARKING
LAMPS

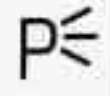

HAZARD
WARNING
FLASHER



DAYTIME
RUNNING
LAMPS

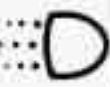

FOG LAMPS



These symbols are on some of your controls:

WINDSHIELD
WIPER



WINDSHIELD
WASHER



WINDSHIELD
DEFROSTER



REAR
WINDOW
DEFOGGER



VENTILATING
FAN



These symbols are used on warning and indicator lights:

ENGINE
COOLANT
TEMP



BATTERY
CHARGING
SYSTEM



BRAKE



COOLANT



ENGINE OIL
PRESSURE



ANTI-LOCK
BRAKES



Here are some other symbols you may see:

FUSE



LIGHTER



HORN



SPEAKER



FUEL





Section 1 Seats and Restraint Systems

Here you'll find information about the seats in your Corvette and how to use your safety belts properly. You can also learn about some things you should *not* do with air bags and safety belts.

1-2	Seats and Seat Controls	1-18	Air Bag System
1-5	Safety Belts: They're for Everyone	1-25	Children
1-10	Here Are Questions Many People Ask About Safety Belts -- and the Answers	1-27	Child Restraints
1-11	How to Wear Safety Belts Properly	1-34	Larger Children
1-11	Driver Position	1-37	Safety Belt Extender
1-17	Safety Belt Use During Pregnancy	1-37	Checking Your Restraint Systems
1-18	Passenger Position	1-38	Replacing Restraint System Parts After a Crash

Seats and Seat Controls

This part tells you about the seats -- how to adjust them, and also about reclining seatbacks and seatback latches.

Manual Front Seat (Option, Passenger Only)

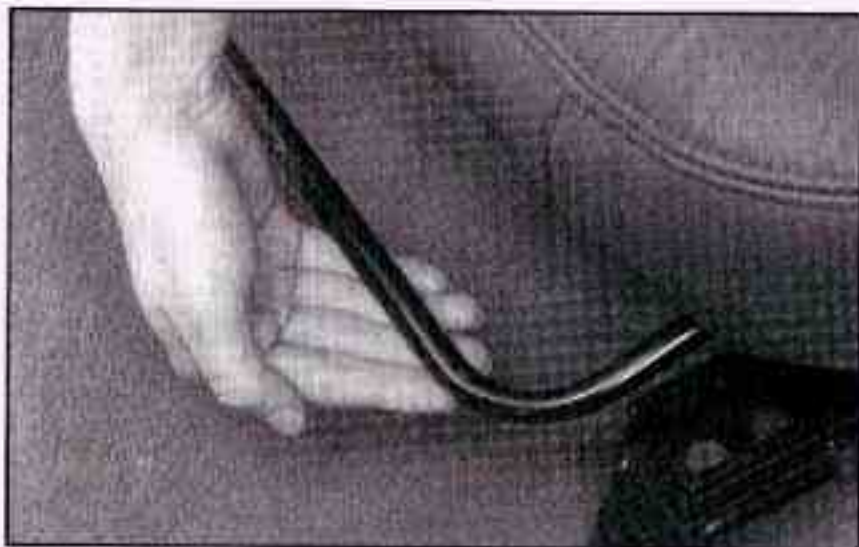

Pull up on the lever in front of the seat to unlock it. Slide the seat to where you want it. Then release the lever and try to move the seat with your body to make sure the seat is locked into place.

Power Seat



The switch for the power seats is located on the side of each seat, near the base.

Different parts of the power seat control move different parts of your seat. If you move the whole control, the whole seat will move. The back of the control will raise or lower the back of the seat, and the front of the control will raise or lower the front of the seat.

Move the control to the front or to the back to move the seat forward or backward. Move the control up to raise the seat and down to lower it.

Your preferred seat position can be stored and recalled if you have the memory option. See "Memory" in the Index.

Sport Seat (Option)

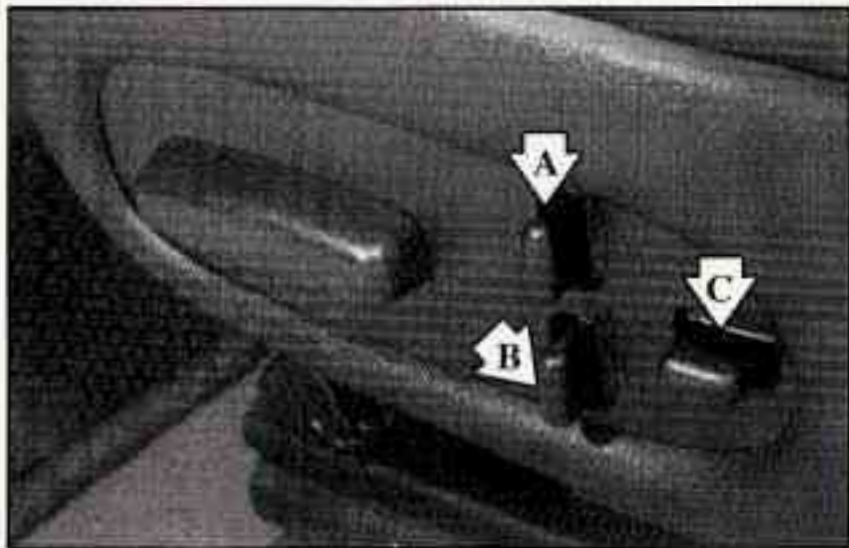

In addition to the power seat control, there are three other switches that help you change the shape of your seat. There are two lumbar supports (A and B) for the middle and lower back. There's also a side bolster switch (C) that adjusts the sides of the seat around you to give you more lateral support.

For lumbar support, move each switch (A and B) forward to inflate or rearward to deflate.

Move the side bolster switch (C) up for more side support and down for less support.

Reclining Seatbacks

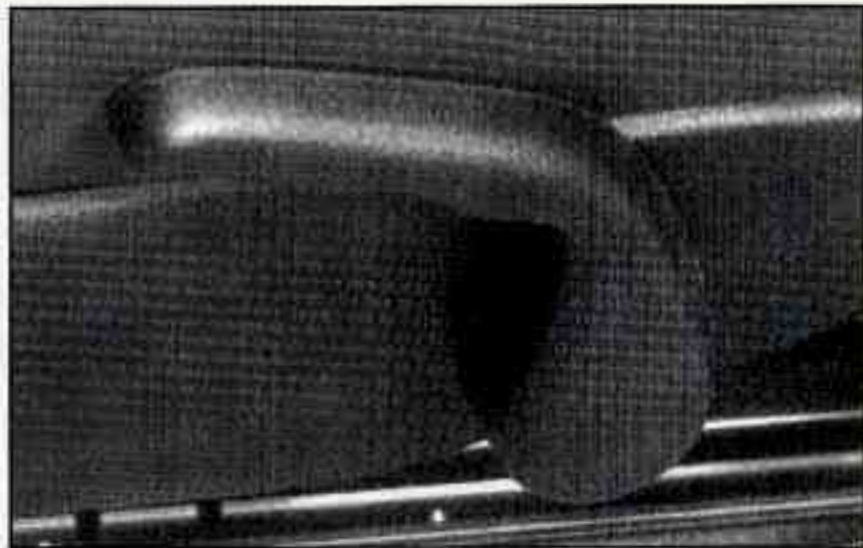

The lever for the reclining seatback is located on the side of each seat, near the base.

To adjust the seatback, pull up on the lever and tilt the seatback to where you want it. Release the lever to lock the seatback into place.



But don't have a seatback reclined if your vehicle is moving.

CAUTION:

Sitting in a reclined position when your vehicle is in motion can be dangerous. Even if you buckle up, your safety belts can't do their job when you're reclined like this.

The shoulder belt can't do its job because it won't be against your body. Instead, it will be in front of you. In a crash you could go into it, receiving neck or other injuries.

The lap belt can't do its job either. In a crash the belt could go up over your abdomen. The belt forces would be there, not at your pelvic bones. This could cause serious internal injuries.

For proper protection when the vehicle is in motion, have the seatback upright. Then sit well back in the seat and wear your safety belt properly.

Seatback Latches

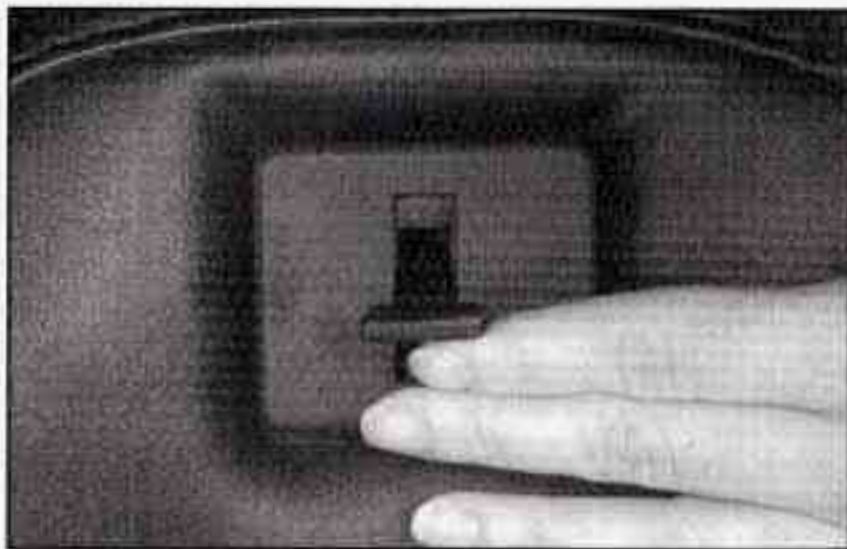

Both seatbacks fold forward to give you access to the rear area. To fold a seatback forward, lift this latch and pull the seatback forward. The seatback will lock down in this position. To unlock, lift up on the latch and push the seatback rearward. When you return the seatback to its original position, make sure the seatback is locked.



CAUTION:

If the seatback isn't locked, it could move forward in a sudden stop or crash. That could cause injury to the person sitting there. Always press rearward on the seatback to be sure it is locked.

Safety Belts: They're for Everyone

This part of the manual tells you how to use safety belts properly. It also tells you some things you should not do with safety belts.

And it explains the air bag system.

⚠ CAUTION:

Don't let anyone ride where he or she can't wear a safety belt properly. If you are in a crash and you're not wearing a safety belt, your injuries can be much worse. You can hit things inside the vehicle or be ejected from it. You can be seriously injured or killed. In the same crash, you might not be if you are buckled up. Always fasten your safety belt, and check that your passenger's belt is fastened properly too.

⚠ CAUTION:

It is extremely dangerous to ride in a cargo area, inside or outside of a vehicle. In a collision, people riding in these areas are more likely to be seriously injured or killed. Do not allow people to ride in any area of your vehicle that is not equipped with seats and safety belts. Be sure everyone in your vehicle is in a seat and using a safety belt properly.



Your vehicle has a light that comes on as a reminder to buckle up. (See "Safety Belt Reminder Light" in the Index.)

In most states and Canadian provinces, the law says to wear safety belts. Here's why: *They work.*

You never know if you'll be in a crash. If you do have a crash, you don't know if it will be a bad one.

A few crashes are mild, and some crashes can be so serious that even buckled up a person wouldn't survive. But most crashes are in between. In many of them, people who buckle up can survive and sometimes walk away. Without belts they could have been badly hurt or killed.

After more than 30 years of safety belts in vehicles, the facts are clear. In most crashes buckling up does matter ... a lot!

Why Safety Belts Work

When you ride in or on anything, you go as fast as it goes.

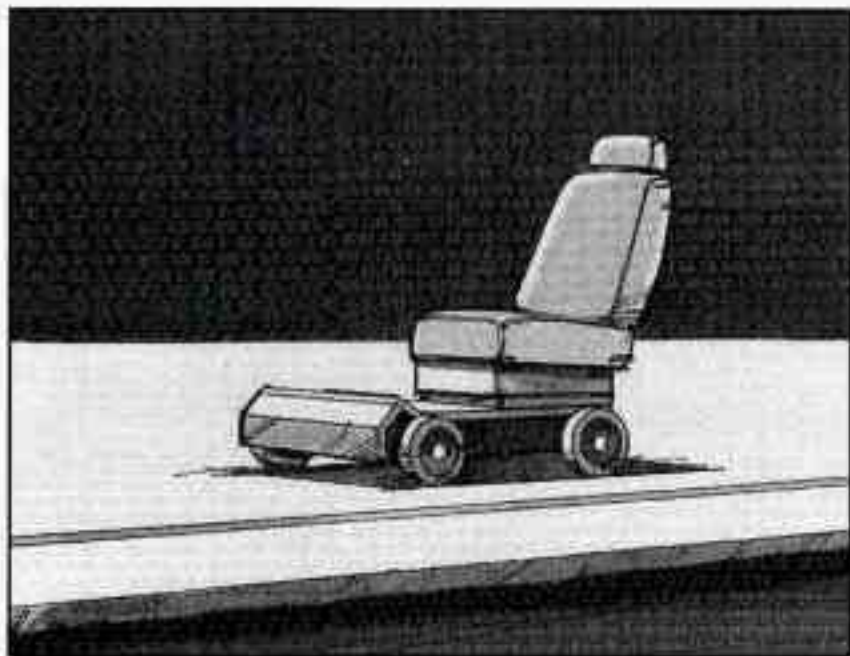

Take the simplest vehicle. Suppose it's just a seat on wheels.

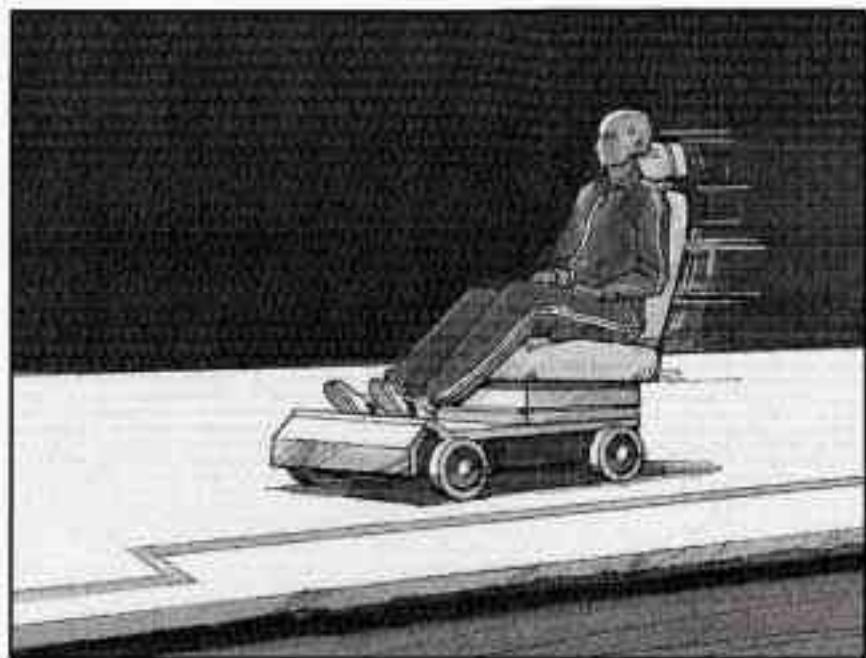

Put someone on it.

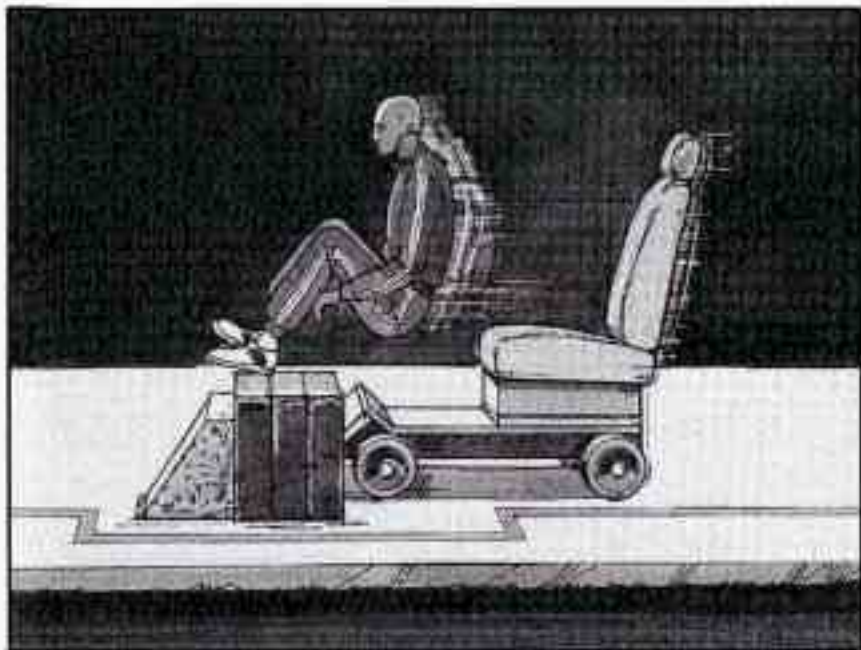

Get it up to speed. Then stop the vehicle. The rider doesn't stop.



The person keeps going until stopped by something. In a real vehicle, it could be the windshield ...



or the instrument panel ...

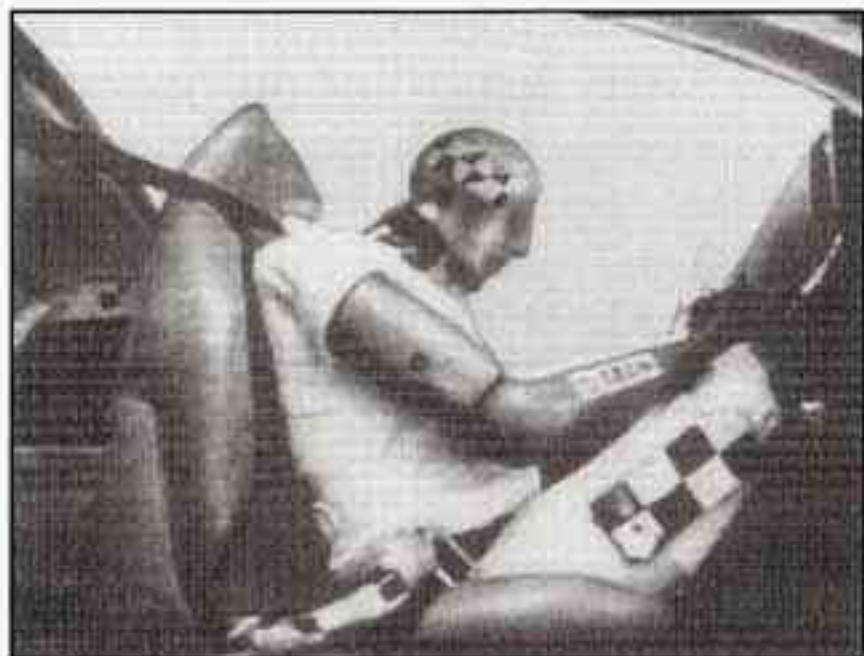

or the safety belts!

With safety belts, you slow down as the vehicle does. You get more time to stop. You stop over more distance, and your strongest bones take the forces. That's why safety belts make such good sense.

Here Are Questions Many People Ask About Safety Belts -- and the Answers

Q: Won't I be trapped in the vehicle after an accident if I'm wearing a safety belt?

A: You *could* be -- whether you're wearing a safety belt or not. But you can unbuckle a safety belt, even if you're upside down. And your chance of being conscious during and after an accident, so you *can* unbuckle and get out, is *much* greater if you are belted.

Q: If my vehicle has air bags, why should I have to wear safety belts?

A: Air bags are in many vehicles today and will be in most of them in the future. But they are supplemental systems only; so they work *with* safety belts -- not instead of them. Every air bag system ever offered for sale has required the use of safety belts. Even if you're in a vehicle that has air bags, you still have to buckle up to get the most protection. That's true not only in frontal collisions, but especially in side and other collisions.

Q: If I'm a good driver, and I never drive far from home, why should I wear safety belts?

A: You may be an excellent driver, but if you're in an accident -- even one that isn't your fault -- you and your passenger can be hurt. Being a good driver doesn't protect you from things beyond your control, such as bad drivers.

Most accidents occur within 25 miles (40 km) of home. And the greatest number of serious injuries and deaths occur at speeds of less than 40 mph (65 km/h).

Safety belts are for everyone.

How to Wear Safety Belts Properly

Adults

This part is only for people of adult size.

Be aware that there are special things to know about safety belts and children. And there are different rules for smaller children and babies. If a child will be riding in your vehicle, see the part of this manual called "Children." Follow those rules for everyone's protection.

First, you'll want to know which restraint systems your vehicle has.

We'll start with the driver position.

Driver Position

This part describes the driver's restraint system.

Lap-Shoulder Belt

The driver has a lap-shoulder belt. Here's how to wear it properly.

1. Close and lock the door.
2. Adjust the seat (to see how, see "Seats" in the Index) so you can sit up straight.



3. Pick up the latch plate and pull the belt across you. Don't let it get twisted.

When the lap portion of the belt is pulled out all the way, it will lock. If it does, let it go back all the way and start again. See "Lap Belt Cinch Feature" in the Index.

4. Push the latch plate into the buckle until it clicks.

Pull up on the latch plate to make sure it is secure. If the belt isn't long enough, see "Safety Belt Extender" at the end of this section.

Make sure the release button on the buckle is positioned so you would be able to unbuckle the safety belt quickly if you ever had to.

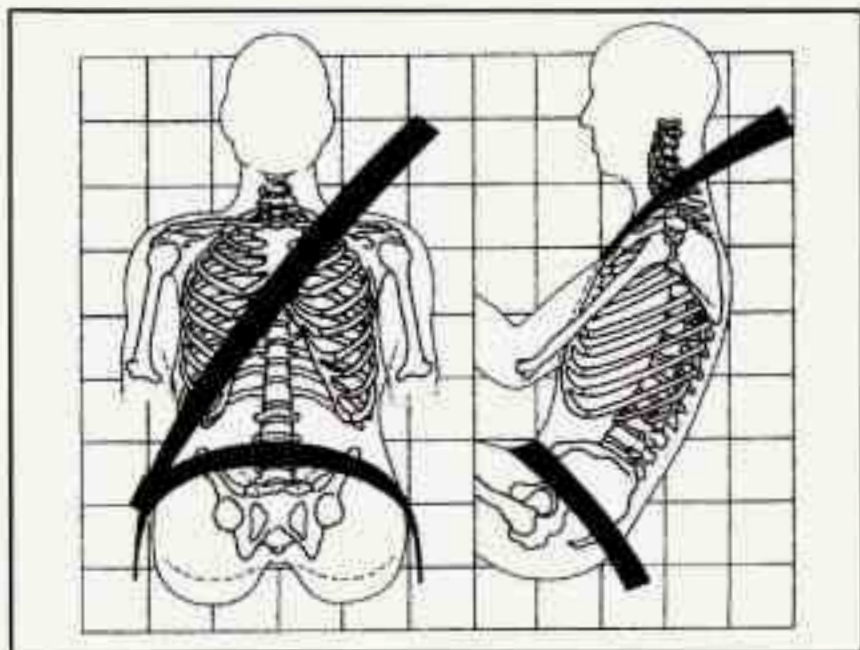

The lap part of the belt should be worn low and snug on the hips, just touching the thighs. In a crash, this applies force to the strong pelvic bones. And you'd be less likely to slide under the lap belt. If you slid under it, the belt would apply force at your abdomen. This could cause serious or even fatal injuries. The shoulder belt should go over the shoulder and across the chest. These parts of the body are best able to take belt restraining forces.

The safety belt locks if there's a sudden stop or crash.

Lap Belt Cinch Feature

If you do not want the lap belt to move freely, pull the lap belt out all the way to set the lock. To permit the lap belt to move freely again, unbuckle the belt, let it retract all the way, and buckle up again.

Q: What's wrong with this?

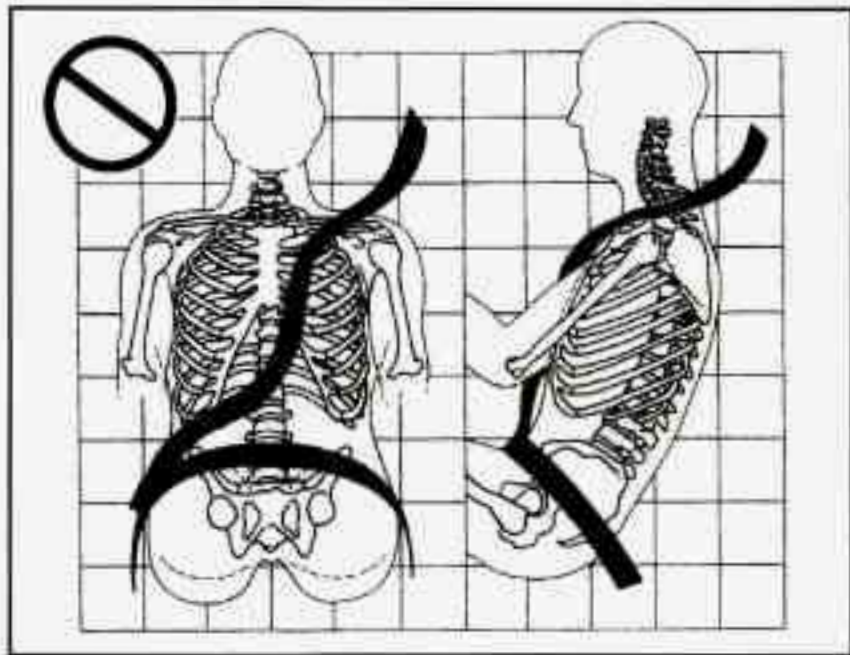

A: The shoulder belt is too loose. It won't give nearly as much protection this way.

⚠ CAUTION:

You can be seriously hurt if your shoulder belt is too loose. In a crash, you would move forward too much, which could increase injury. The shoulder belt should fit against your body.

Q: What's wrong with this?

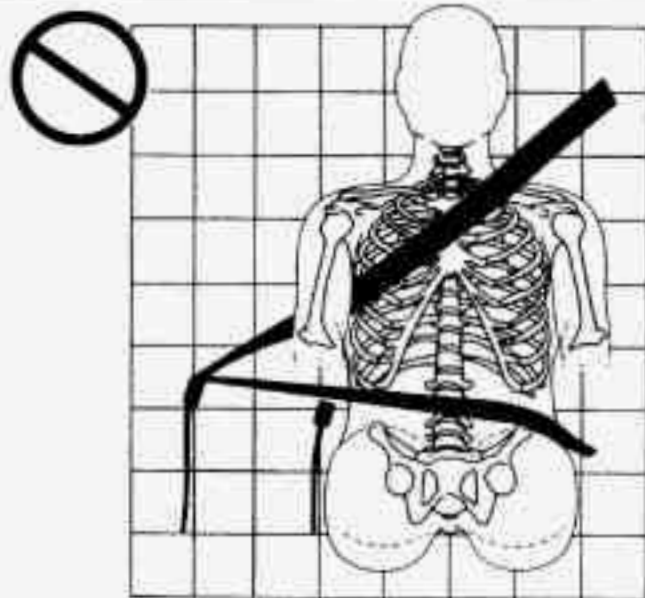

⚠ CAUTION:

You can be seriously injured if your belt is buckled in the wrong place like this. In a crash, the belt would go up over your abdomen. The belt forces would be there, not at the pelvic bones. This could cause serious internal injuries. Always buckle your belt into the buckle nearest you.

A: The belt is buckled in the wrong place.

Q: What's wrong with this?

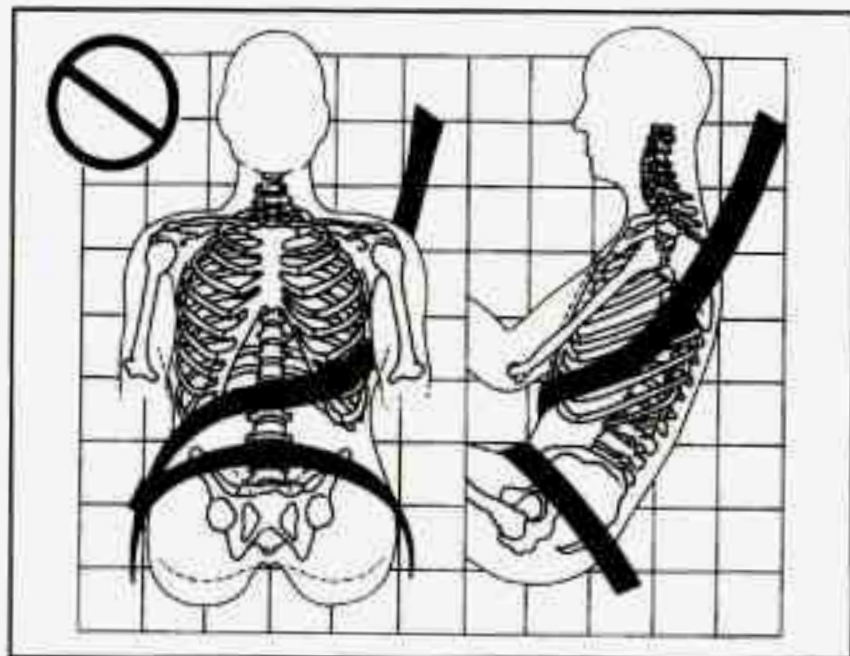

A: The shoulder belt is worn under the arm. It should be worn over the shoulder at all times.

⚠ CAUTION:

You can be seriously injured if you wear the shoulder belt under your arm. In a crash, your body would move too far forward, which would increase the chance of head and neck injury. Also, the belt would apply too much force to the ribs, which aren't as strong as shoulder bones. You could also severely injure internal organs like your liver or spleen.

Q: What's wrong with this?

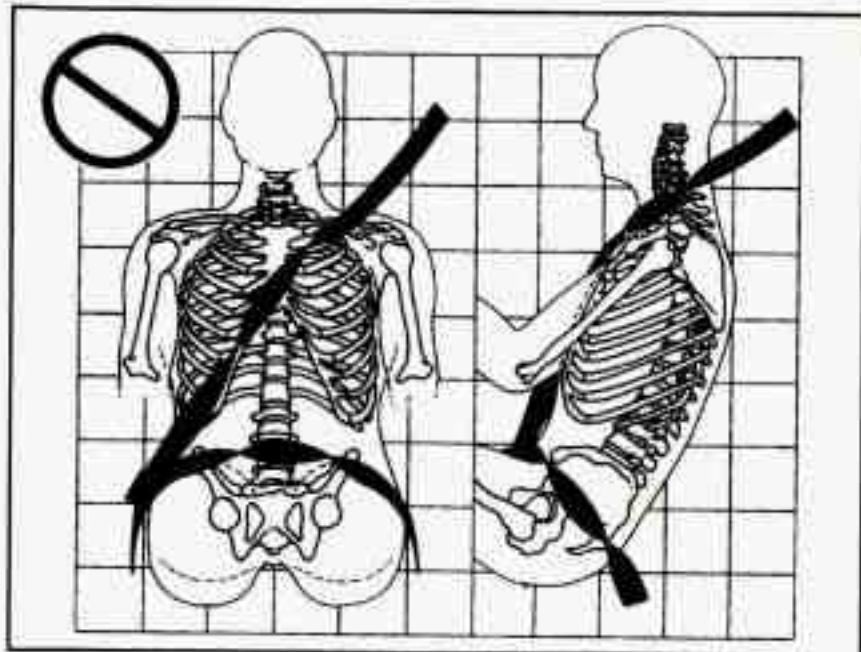

⚠ CAUTION:

You can be seriously injured by a twisted belt. In a crash, you wouldn't have the full width of the belt to spread impact forces. If a belt is twisted, make it straight so it can work properly, or ask your dealer to fix it.

A: The belt is twisted across the body.



To unlatch the belt, just push the button on the buckle. The belt should go back out of the way.

Before you close the door, be sure the belt is out of the way. If you slam the door on it, you can damage both the belt and your vehicle.

Safety Belt Use During Pregnancy

Safety belts work for everyone, including pregnant women. Like all occupants, they are more likely to be seriously injured if they don't wear safety belts.

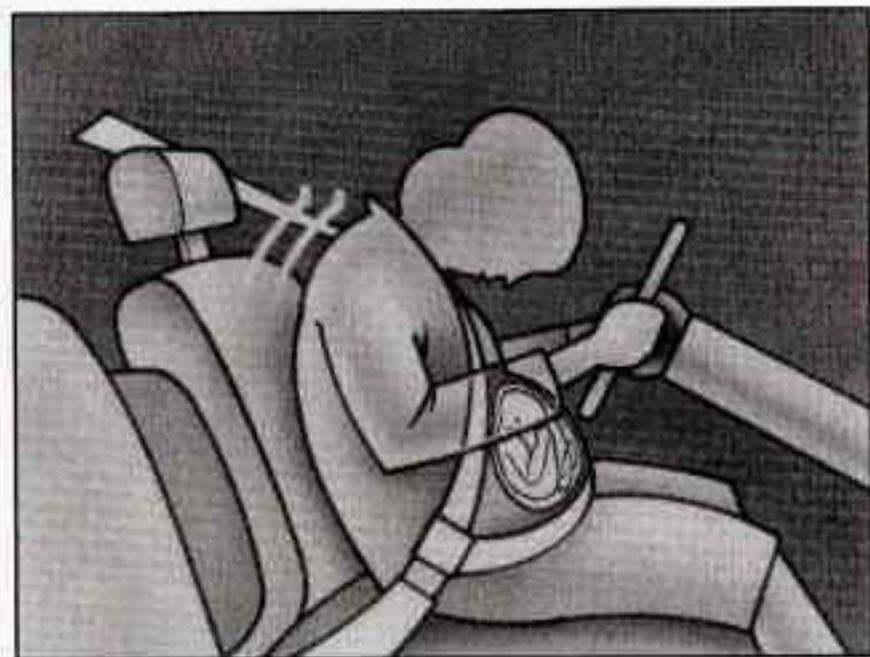

A pregnant woman should wear a lap-shoulder belt, and the lap portion should be worn as low as possible, below the rounding, throughout the pregnancy.

The best way to protect the fetus is to protect the mother. When a safety belt is worn properly, it's more likely that the fetus won't be hurt in a crash. For pregnant women, as for anyone, the key to making safety belts effective is wearing them properly.

Passenger Position

To learn how to wear the passenger's safety belt properly, see "Driver Position" earlier in this section.

The passenger's safety belt works the same way as the driver's safety belt -- except for one thing. If you ever pull the lap portion of the belt out all the way, you will engage the child restraint locking feature. If this happens, just let the belt go back all the way and start again.

Air Bag System

This part explains the air bag system.

Your vehicle has two air bags -- one air bag for the driver and another air bag for the passenger.

Here are the most important things to know about the air bag system:



CAUTION:

You can be severely injured or killed in a crash if you aren't wearing your safety belt -- even if you have air bags. Wearing your safety belt during a crash helps reduce your chance of hitting things inside the vehicle or being ejected from it. Air bags are "supplemental restraints" to the safety belts. All air bags are designed to work with safety belts, but don't replace them. Air bags are designed to work only in moderate to severe crashes where the front of your vehicle hits something. They aren't designed to inflate at all in rollover, rear, side or low-speed frontal crashes. Everyone in your vehicle should wear a safety belt properly -- whether or not there's an air bag for that person.

 **CAUTION:**

Air bags inflate with great force, faster than the blink of an eye. If you're too close to an inflating air bag, it could seriously injure you. Safety belts help keep you in position before and during a crash. Always wear your safety belt, even with air bags. The driver should sit as far back as possible while still maintaining control of the vehicle.

 **CAUTION:**

Children who are up against, or very close to, an air bag when it inflates can be seriously injured or killed. Air bags plus lap-shoulder belts offer the best protection for adults and older children, but not for young children and infants. Neither the vehicle's safety belt system nor its air bag system is designed for them. Young children and infants need the protection that a child restraint system can provide. Always secure children properly in your vehicle. To read how, see the part of this manual called "Children" and see the caution labels on the sunvisors and the passenger's safety belt.



There is an air bag readiness light on the instrument panel, which shows the air bag symbol.

The system checks the air bag electrical system for malfunctions. The light tells you if there is an electrical problem. See "Air Bag Readiness Light" in the Index for more information.

How the Air Bag System Works

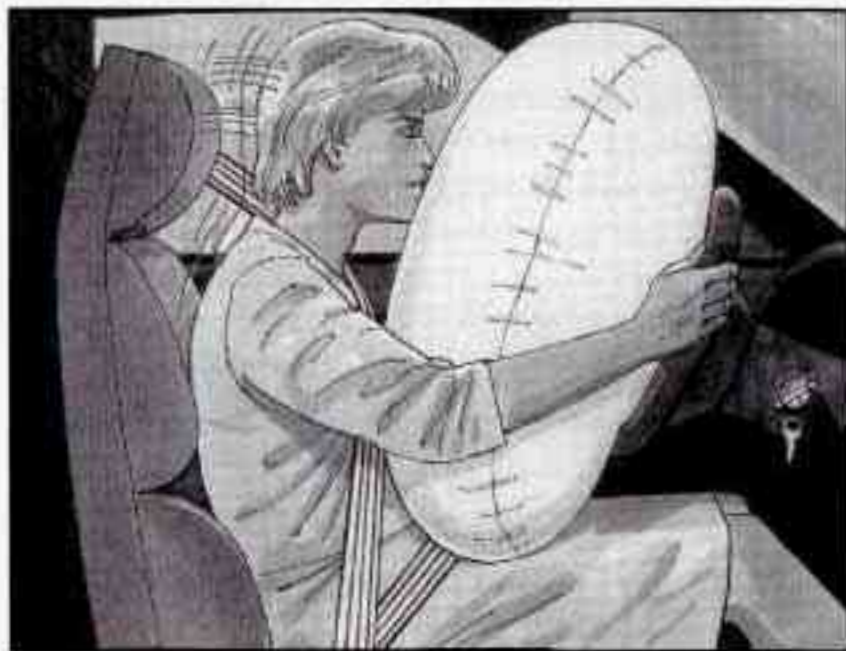

Where are the air bags?

The driver's air bag is in the middle of the steering wheel.



⚠ CAUTION:

If something is between an occupant and an air bag, the bag might not inflate properly or it might force the object into that person. The path of an inflating air bag must be kept clear. Don't put anything between an occupant and an air bag, and don't attach or put anything on the steering wheel hub or on or near any other air bag covering.

The passenger's air bag is in the instrument panel on the passenger's side.

When should an air bag inflate?

An air bag is designed to inflate in a moderate to severe frontal or near-frontal crash. The air bag will inflate only if the impact speed is above the system's designed "threshold level." If your vehicle goes straight into a wall that doesn't move or deform, the threshold level is about 9 to 15 mph (14 to 24 km/h). The threshold level can vary, however, with specific vehicle design, so that it can be somewhat above or below this range. If your vehicle strikes something that will move or deform, such as a parked car, the threshold level will be higher. The air bag is not designed to inflate in rollovers, side impacts or rear impacts, because inflation would not help the occupant.

It is possible that in a crash only one of the two air bags in your Corvette will deploy. This is rare, but can happen in a crash just severe enough to make an air bag inflate.

In any particular crash, no one can say whether an air bag should have inflated simply because of the damage to a vehicle or because of what the repair costs were. Inflation is determined by the angle of the impact and how quickly the vehicle slows down in frontal or near-frontal impacts.

What makes an air bag inflate?

In an impact of sufficient severity, the air bag sensing system detects that the vehicle is in a crash. The sensing system triggers a release of gas from the inflator, which inflates the air bag. The inflator, air bag and related hardware are all part of the air bag modules inside the steering wheel and in the instrument panel in front of the passenger.

How does an air bag restrain?

In moderate to severe frontal or near-frontal collisions, even belted occupants can contact the steering wheel or the instrument panel. Air bags supplement the protection provided by safety belts. Air bags distribute the force of the impact more evenly over the occupant's upper body, stopping the occupant more gradually. But air bags would not help you in many types of collisions, including rollovers, rear impacts and side impacts, primarily because an occupant's motion is not toward those air bags. Air bags should never be regarded as anything more than a supplement to safety belts, and then only in moderate to severe frontal or near-frontal collisions.

What will you see after an air bag inflates?

After an air bag inflates, it quickly deflates, so quickly that some people may not even realize the air bag inflated. Some components of the air bag module -- the steering wheel hub for the driver's air bag, or the instrument panel for the passenger's bag -- will be hot for a short time. The parts of the bag that come into contact with you may be warm, but not too hot to touch. There will be some smoke and dust coming from vents in the deflated air bags. Air bag inflation doesn't prevent the driver from seeing or from being able to steer the vehicle, nor does it stop people from leaving the vehicle.

CAUTION:

When an air bag inflates, there is dust in the air. This dust could cause breathing problems for people with a history of asthma or other breathing trouble. To avoid this, everyone in the vehicle should get out as soon as it is safe to do so. If you have breathing problems but can't get out of the vehicle after an air bag inflates, then get fresh air by opening a window or door.

In many crashes severe enough to inflate an air bag, windshields are broken by vehicle deformation. Additional windshield breakage may also occur from the passenger air bag.

- Air bags are designed to inflate only once. After they inflate, you'll need some new parts for your air bag system. If you don't get them, the air bag system won't be there to help protect you in another crash. A new system will include air bag modules and possibly other parts. The service manual for your vehicle covers the need to replace other parts.
- Your vehicle is equipped with a diagnostic module, which records information about the air bag system. The module records information about the readiness of the system, when the sensors are activated and driver's safety belt usage at deployment.
- Let only qualified technicians work on your air bag system. Improper service can mean that your air bag system won't work properly. See your dealer for service.

NOTICE:

If you damage the covering for the driver's or the passenger's air bag, the bag may not work properly. You may have to replace the air bag module in the steering wheel or both the air bag module and the instrument panel for the passenger's air bag. Do not open or break the air bag coverings.

Servicing Your Air Bag-Equipped Vehicle

Air bags affect how your vehicle should be serviced. There are parts of the air bag system in several places around your vehicle. You don't want the system to inflate while someone is working on your vehicle. Your dealer and the Corvette Service Manual have information about servicing your vehicle and the air bag system. To purchase a service manual, see "Service and Owner Publications" in the Index.



CAUTION:

For up to 10 minutes after the ignition key is turned off and the battery is disconnected, an air bag can still inflate during improper service. You can be injured if you are close to an air bag when it inflates. Avoid yellow wires, wires wrapped with yellow tape or yellow connectors. They are probably part of the air bag system. Be sure to follow proper service procedures, and make sure the person performing work for you is qualified to do so.

The air bag system does not need regular maintenance.

Children

Everyone in a vehicle needs protection! That includes infants and all children smaller than adult size. Neither the distance to be traveled nor the age and size of the traveler changes the need, for everyone, to use safety restraints. In fact, the law in every state in the United States and in every Canadian province says children up to some age must be restrained while in a vehicle.

Smaller Children and Babies

CAUTION:

Children who are up against, or very close to, an air bag when it inflates can be seriously injured or killed. Air bags plus lap-shoulder belts offer the best protection for adults and older children, but not for young children and infants. Neither the vehicle's safety belt system nor its air bag system is designed for them. Young children and infants need the protection that a child restraint system can provide. Always secure children properly in your vehicle.

CAUTION:

A very young child's hip bones are so small that a regular belt might not stay low on the hips, as it should. Instead, the belt will likely be over the child's abdomen. In a crash, the belt would apply force right on the child's abdomen, which could cause serious or fatal injuries. Smaller children and babies should always be restrained in a child restraint. However, infants, who should be restrained in a rear-facing child restraint, cannot ride safely in this vehicle. The instructions for the restraint will say whether it is the right type and size for your child. If a forward-facing child restraint is suitable for your child, be sure the child is always properly restrained while riding in this vehicle.

Infants need complete support, including support for the head and neck. This is necessary because an infant's neck is weak and its head weighs so much compared with the rest of its body. In a crash, an infant in a rear-facing restraint settles into the restraint, so the crash forces can be distributed across the strongest part of the infant's body, the back and shoulders. A baby should be secured in an appropriate infant restraint, but you shouldn't secure that type of restraint in this vehicle because of the air bag risk.



⚠ CAUTION:

Never hold a baby in your arms while riding in a vehicle. A baby doesn't weigh much -- until a crash. During a crash a baby will become so heavy you can't hold it. For example, in a crash at only 25 mph (40 km/h), a 12-lb. (5.5 kg) baby will suddenly become a 240-lb. (110 kg) force on your arms. The baby would be almost impossible to hold.

Child Restraints

Every time infants and young children ride in vehicles, they should have protection provided by appropriate restraints.

Q: What are the different types of add-on child restraints?

A: Add-on child restraints are available in four basic types. When selecting a child restraint, take into consideration not only the child's weight and size, but also whether or not the restraint will be compatible with the motor vehicle in which it will be used.

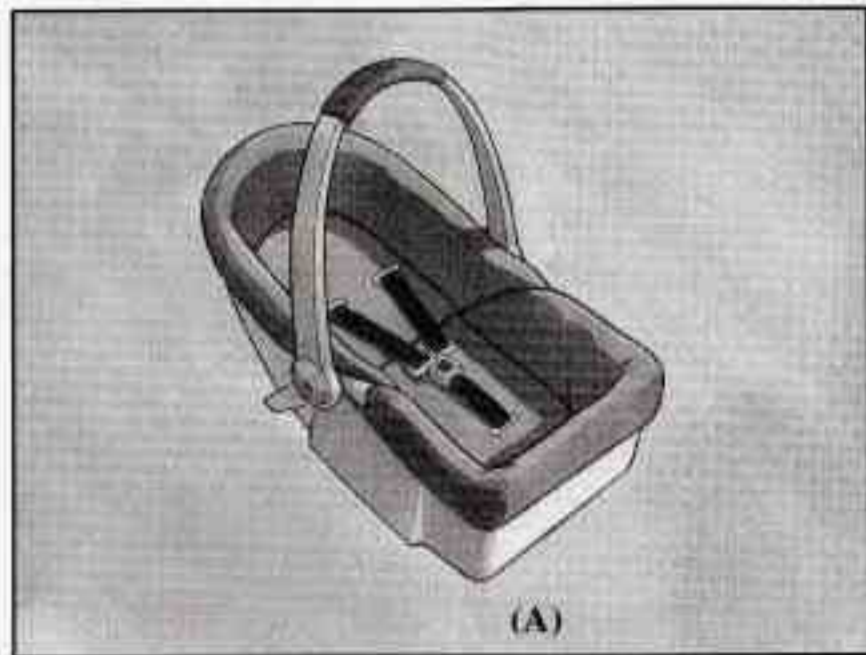

An infant car bed (A) is a special bed made for use in a motor vehicle. It's an infant restraint system designed to restrain or position a child on a continuous flat surface. With an infant car bed, make sure that the infant's head rests toward the center of the vehicle.



(B)



(C)

A rear-facing infant restraint (B) positions an infant to face the rear of the vehicle. Rear-facing infant restraints are designed for infants of up to about 20 lbs. (9 kg) and about one year of age. This type of restraint faces the rear so that the infant's head, neck and body can have the support they need in a crash. Some infant seats come in two parts -- the base stays secured in the vehicle and the seat part is removable.



A forward-facing child restraint (C-E) positions a child upright to face forward in the vehicle. These forward-facing restraints are designed to help protect children who are from 20 to 40 lbs. (9 to 18 kg) and about 26 to 40 inches (66 to 102 cm) in height, or up to around four years of age. One type, a convertible restraint, is designed to be used either as a rear-facing infant seat or a forward-facing child seat.

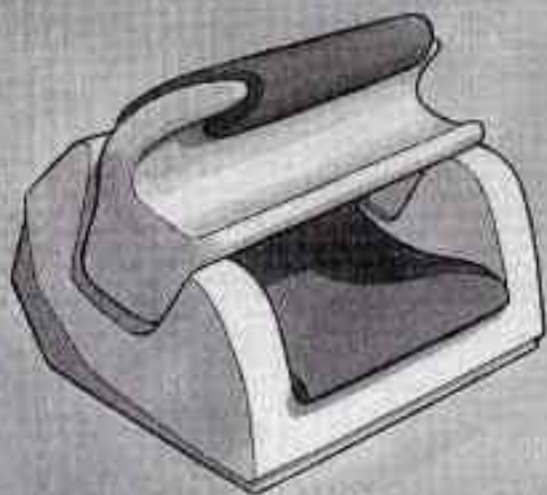

(F)

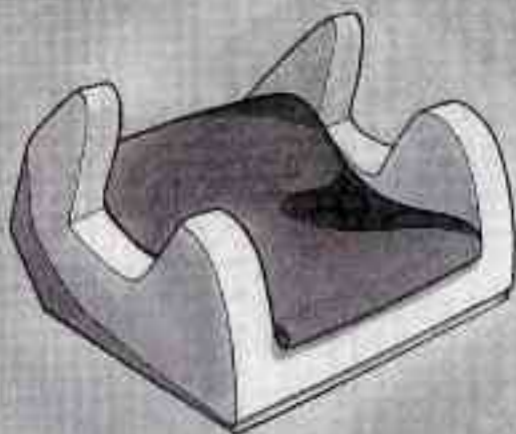

(G)

A booster seat (F, G) is designed for children who are about 40 to 60 lbs. (18 to 27 kg) and about four to eight years of age. It's designed to improve the fit of the vehicle's safety belt system. Booster seats with shields use lap-only belts; however, booster seats without shields use lap-shoulder belts. Booster seats can also help a child to see out the window.

When choosing a child restraint, be sure the child restraint is designed to be used in a vehicle. If it is, it will have a label saying that it meets Federal Motor Vehicle Safety Standards.

Then follow the instructions for the restraint. You may find these instructions on the restraint itself or in a booklet, or both. These restraints use the belt system in your vehicle, but the child also has to be secured within the restraint to help reduce the chance of personal injury. The instructions that come with the child restraint will show you how to do that. Both the owner's manual and the child restraint instructions are important, so if either one of these is not available, obtain a replacement copy from the manufacturer.

The child restraint must be secured properly in the passenger seat.

Keep in mind that an unsecured child restraint can move around in a collision or sudden stop and injure people in the vehicle. Be sure to properly secure any child restraint in your vehicle -- even when no child is in it.

Top Strap

Some child restraints have a top strap. Don't use a restraint like that in your vehicle because the top strap anchor cannot be installed properly. You shouldn't use this type of child restraint without anchoring the top strap.

Securing a Child Restraint in the Passenger Seat Position

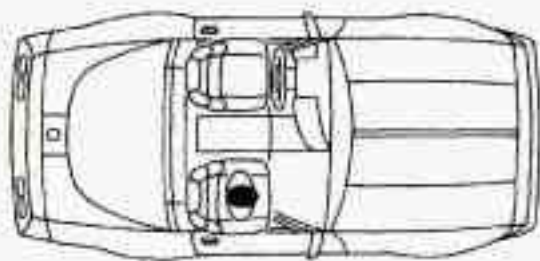

Your vehicle has a passenger air bag. *Never* put a rear-facing child restraint in this vehicle. Here's why:

CAUTION:

A child in a rear-facing child restraint can be seriously injured if the passenger's air bag inflates. This is because the back of a rear-facing child restraint would be very close to the inflating air bag. Do not use a rear-facing child restraint in this vehicle.

If a forward-facing child restraint is suitable for your child, always move the passenger seat as far back as it will go.

You'll be using the lap-shoulder belt. See the earlier part about the top strap if the child restraint has one. Be sure to follow the instructions that came with the child restraint. Secure the child in the child restraint when and as the instructions say.

1. Because your vehicle has a passenger air bag, always move the seat as far back as it will go before securing a forward-facing child restraint. (See "Seats" in the Index.)
2. Put the restraint on the seat.
3. Pick up the latch plate, and run the lap and shoulder portions of the vehicle's safety belt through or around the restraint. The child restraint instructions will show you how.

If the shoulder belt goes in front of the child's face or neck, put it behind the child restraint.



4. Buckle the belt. Make sure the release button is positioned so you would be able to unbuckle the safety belt quickly if you ever had to.

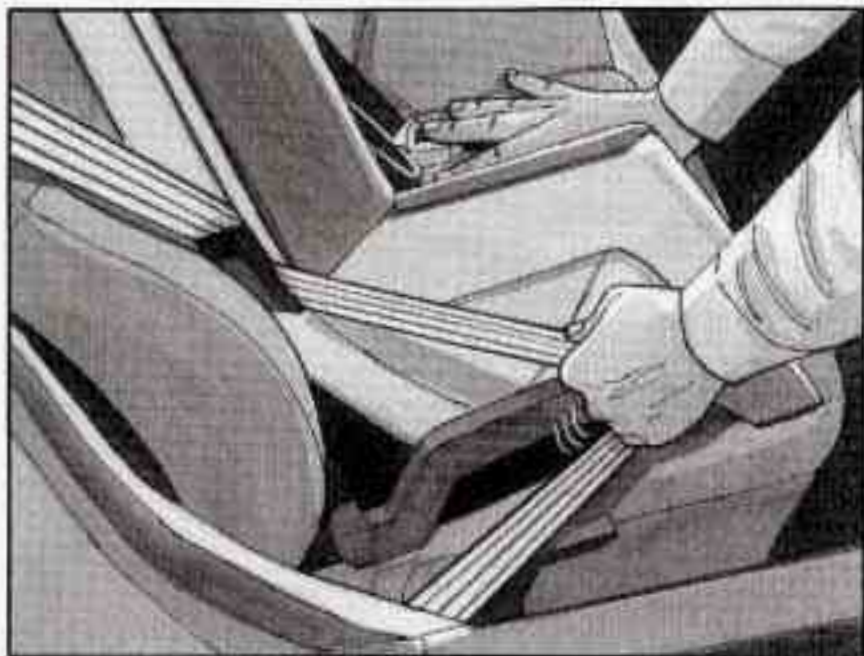

5. Pull the rest of the lap belt all the way out of the retractor to set the lock.



6. To tighten the belt, feed the lap belt back into the retractor while you push down on the child restraint. You may find it helpful to use your knee to push down on the child restraint as you tighten the belt.
7. Push and pull the child restraint in different directions to be sure it is secure.

To remove the child restraint, just unbuckle the vehicle's safety belt and let it go back all the way. The safety belt will move freely again and be ready to work for an adult or larger child passenger.

Larger Children



Children who have outgrown child restraints should wear the vehicle's safety belts.

- Children who aren't buckled up can be thrown out in a crash.
- Children who aren't buckled up can strike other people who are.



Q: What if a child is wearing a lap-shoulder belt, but the child is so small that the shoulder belt is very close to the child's face or neck?

A: Move the child toward the center of the vehicle, but be sure that the shoulder belt still is on the child's shoulder, so that in a crash the child's upper body would have the restraint that belts provide.

⚠ CAUTION:

Never do this.

Here two children are wearing the same belt. The belt can't properly spread the impact forces. In a crash, the two children can be crushed together and seriously injured. A belt must be used by only one person at a time.



⚠ CAUTION:

Never do this.

Here a child is sitting in a seat that has a lap-shoulder belt, but the shoulder part is behind the child. If the child wears the belt in this way, in a crash the child might slide under the belt. The belt's force would then be applied right on the child's abdomen. That could cause serious or fatal injuries.

The lap portion of the belt should be worn low and snug on the hips, just touching the child's thighs. This applies belt force to the child's pelvic bones in a crash.

Safety Belt Extender

If the vehicle's safety belt will fasten around you, you should use it.

But if a safety belt isn't long enough to fasten, your dealer will order you an extender. It's free. When you go in to order it, take the heaviest coat you will wear, so the extender will be long enough for you. The extender will be just for you, and just for the seat in your vehicle that you choose. Don't let someone else use it, and use it only for the seat it is made to fit. To wear it, just attach it to the regular safety belt.

Checking Your Restraint Systems

Now and then, make sure the safety belt reminder light and all your belts, buckles, latch plates, retractors and anchorages are working properly. Look for any other loose or damaged safety belt system parts. If you see anything that might keep a safety belt system from doing its job, have it repaired.

Torn or frayed safety belts may not protect you in a crash. They can rip apart under impact forces. If a belt is torn or frayed, get a new one right away.

Also look for any opened or broken air bag covers, and have them repaired or replaced. (The air bag system does not need regular maintenance.)

Replacing Restraint System Parts After a Crash

If you've had a crash, do you need new belts?

After a very minor collision, nothing may be necessary. But if the belts were stretched, as they would be if worn during a more severe crash, then you need new belts.



If you ever see a label on the driver's or passenger's safety belt that says to replace the belt, be sure to do so. Then the new belt will be there to help protect you in a collision. You would see this label on the belt near the latch plate.

If belts are cut or damaged, replace them. Collision damage also may mean you will need to have safety belt or seat parts repaired or replaced. New parts and repairs may be necessary even if the belt wasn't being used at the time of the collision.

If an air bag inflates, you'll need to replace air bag system parts. See the part on the air bag system earlier in this section.



Section 2 Features and Controls

Here you can learn about the many standard and optional features on your vehicle, and information on starting, shifting and braking. Also explained are the instrument panel and the warning systems that tell you if everything is working properly -- and what to do if you have a problem.

- | | | | |
|------|--|------|---|
| 2-4 | Door Locks | 2-37 | Parking Over Things That Burn |
| 2-5 | Memory (Option) | 2-37 | Engine Exhaust |
| 2-6 | Remote Function Actuation System | 2-38 | Running Your Engine While You're Parked
(Automatic Transmission) |
| 2-14 | Remote Hatch/Trunk Lid Release | 2-39 | Limited-Slip Rear Axle |
| 2-17 | Universal Theft-Deterrent System | 2-39 | Selective Real Time Damping (Option) |
| 2-18 | PASS-Key [®] | 2-40 | Windows |
| 2-20 | New Vehicle "Break-In" | 2-42 | Turn Signal/Multifunction Lever |
| 2-21 | Ignition Switch | 2-50 | Exterior Lamps |
| 2-22 | Starting Your Engine | 2-52 | Interior Lamps |
| 2-24 | Engine Coolant Heater (Canada Only) | 2-53 | Mirrors |
| 2-26 | Automatic Transmission Operation | 2-54 | Storage Compartments |
| 2-29 | Manual Transmission Operation | 2-60 | Roof Panel (Coupe) |
| 2-32 | Parking Brake | 2-68 | Convertible Top (Option) |
| 2-34 | Shifting Into PARK (P)
(Automatic Transmission Models Only) | 2-74 | Instrument Panel |
| 2-36 | Shifting Out of PARK (P)
(Automatic Transmission) | 2-77 | Warning Lights, Gages and Messages |
| 2-36 | Parking Your Vehicle (Manual Transmission) | 2-87 | Driver Information Center (DIC) |

Keys

CAUTION:

Leaving young children in a vehicle with the ignition key is dangerous for many reasons. A child or others could be badly injured or even killed.

They could operate power windows or other controls or even make the vehicle move. Don't leave the keys in a vehicle with young children.





One key is used for the ignition, the doors and all other locks.

When a new vehicle is delivered, the dealer gives the first owner a key and a bar coded tag. Both the key and the tag are attached to a key ring.

The heavy paper tag has a code on it that tells your dealer or a qualified locksmith how to make extra keys. Keep the bar-coded tag in a safe place. If you lose your key, you'll be able to have a new one made easily using this tag. If your key doesn't have a tag and you need a new ignition key, go to your Chevrolet dealer for the correct key code.

If you ever do get locked out of your vehicle, call the Chevrolet Roadside Assistance Center at 1-800-CHEV-USA. (Canadian customers call 1-800-268-2800.)

NOTICE:

Your vehicle has a number of features that can help prevent theft. But you can have a lot of trouble getting into your vehicle if you ever lock your key inside. You may even have to damage your vehicle to get in. So be sure you have an extra key.

Door Locks

CAUTION:

Unlocked doors can be dangerous.

Passengers -- especially children -- can easily open the doors and fall out. When a door is locked, the inside handle won't open it.

Outsiders can easily enter through an unlocked door when you slow down or stop your vehicle.

This may not be so obvious: You increase the chance of being thrown out of the vehicle in a crash if the doors aren't locked. Wear safety belts properly, lock your doors, and you will be far better off whenever you drive your vehicle.

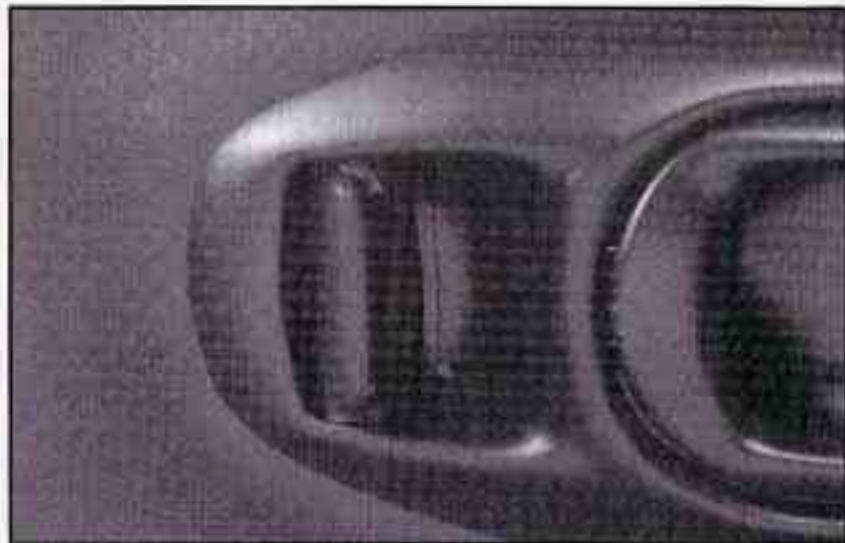

To lock the door from the inside, move the lock control on the door forward. To unlock it, move the lock control on the door backward.

There are several ways to lock and unlock your vehicle.

From the outside, use your door key or the key fob transmitter.

If your theft-deterrent system is armed, unlock the doors only with the key or the transmitter to avoid setting off the alarm. See "Universal Theft-Deterrent" in the Index.

Power Door Locks

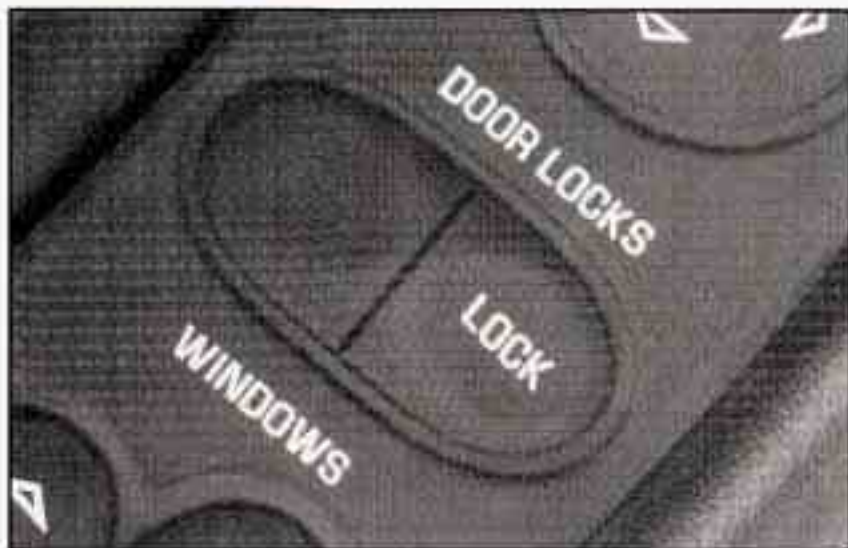

Press the power door unlock/lock switch on either door to lock or unlock both doors at once.

Leaving Your Vehicle

If you are leaving the vehicle, take your key, open your door and set the locks from inside. Then get out and close the door.

Your vehicle has a Remote Function Actuator, or key fob transmitter function that can also lock your vehicle as you walk away from it. See "Remote Function Actuation System" in the Index.

Memory (Option)



MEMORY can store and recall the vehicle settings for the driver's seat position, the outside rearview mirror position, comfort control temperature, fan speed and mode settings, radio presets, tone, volume, playback mode (AM/FM, Tape or CD), last displayed station, compact disc position and audio tape direction.

The MEMORY buttons are located on the driver's side door, above the power mirror buttons. The MEMORY buttons can store and recall the vehicle settings for up to three drivers. Use button "1" to store the vehicle settings for the first driver, button "2" for a second driver or press buttons 1 and 2 simultaneously for a third driver.

To store your vehicle settings, press and hold a MEMORY button. The light will glow steady for one second and then flash once when the settings are completed.

To recall your settings, press your MEMORY button. The light above the button will flash until the correct vehicle settings are achieved, then glow for three seconds when completed.

Your memory settings will also be recalled when you press the active door UNLOCK button on the key fob transmitter.

Drivers 1, 2 and 3 correspond to the order in which your key fob transmitters were programmed. (See "Fob Training" in the Index.)

Memory recall will not work if the vehicle is moving, the ignition key is removed or a power seat, mirror or memory switch is being used. Memory recall will be temporarily interrupted during engine crank.

Remote Function Actuation System

Your vehicle has a passive/active Remote Function Actuation (RFA) system that allows you to lock and unlock your doors, unlock your hatch/trunk lid, turn the panic alarm on and off and disarm or arm your theft-deterrent system. When using one of the key fob transmitters supplied with your vehicle, the passive range distance is as much as 30 feet (9 m) away from the vehicle on the driver's side and 20 feet (6 m) away on the passenger's side. The active range distance is as much as 100 feet (30 m) away.



Your vehicle comes standard with two transmitters, and up to three can be matched to your vehicle.

See "Matching Transmitter(s) to Your Vehicle" later in this section.

Your RFA system operates on a radio frequency subject to Federal Communications Commission (FCC) Rules and with Industry Canada.

This device complies with Part 15 of the FCC Rules. Operation is subject to the following two conditions: (1) this device may not cause harmful interference, and (2) this device must accept any interference received, including interference that may cause undesired operation.

This device complies with RSS-210 of Industry Canada. Operation is subject to the following two conditions: (1) this device may not cause interference, and (2) this device must accept any interference received, including interference that may cause undesired operation of the device.

Changes or modifications to this system by other than an authorized service facility could void authorization to use this equipment.

If you ever notice a decrease in the key fob transmitter range, try doing one of the following:

- Check to determine if battery replacement is necessary. See the instructions that follow.
- Check the distance. You may be too far from your vehicle. You may need to stand closer during rainy or snowy weather.
- Check the location. Other vehicles or objects may be blocking the signal. Take a few steps to the left or right, hold the transmitter higher, and try again.
- Check to make sure that an electronic device such as a cellular phone or lap top computer is not causing interference.
- Try to resynchronize the transmitter by pressing and holding the LOCK and UNLOCK buttons for seven seconds when standing next to the vehicle.
- If you're still having trouble, see your dealer or a qualified technician for service.

Operation

You don't have to do anything for the RFA to work when the passive feature is on.



You can turn on the passive feature by moving the transmitter's slider switch to *ON*. Now, when you move toward your vehicle with the key fob transmitter, the system will automatically disarm your theft-deterrent system and unlock the driver's door or both depending on how the system is programmed. If it's dark enough outside, your interior lamps will come on.

You can also use the buttons on the transmitter to actively unlock your vehicle. Press **UNLOCK** once to unlock the driver's door, or press **UNLOCK** again within 10 seconds to unlock both doors.

The hatch/trunk lid will unlock when the button with the trunk symbol is pressed, as long as the ignition is turned to the **OFF** position.

If you move out of range with the slider switch set to **ON**, the key fob transmitter will:

- Lock the doors after five seconds.
- Arm the theft-deterrent system.
- Sound the horn to let you know the doors are locked (if you have set your options to do so). (See "Driver Information Center Controls and Displays" in the Index.)
- Turn off the interior lamps.

The system has a feature that makes it difficult for you to lock your keys in your vehicle. If you leave your keys *in the ignition* and attempt to lock the doors, the vehicle will not lock and a chime will sound to remind you that the keys are in the ignition. If the door lock is pressed again, within five seconds, the doors will lock and the keys can be locked in the car. If you leave the keys *in the ignition* and move away with the key fob transmitter, the doors still will not lock. You should notice that the horn doesn't sound and return to get your keys out of the ignition.

The system will allow you to lock your keys in the vehicle if you didn't leave them in the ignition. You should, however, be able to use the key fob transmitter to get them out as long as the passive slide switch is in the ON position. After 15 seconds of no motion, the key fob transmitter shuts down to save the battery. Wait about 30 seconds, then rock the vehicle. The key fob transmitter should "wake up" and unlock the doors.

This system can't guarantee that you will never be locked out of your vehicle. If the battery is low or if the key fob transmitter is in a place where the signal can't get to the antenna, it won't unlock the doors. Always remember to take your keys with you.

Panic Alarm Button

When you press the special horn button on the key fob transmitter, your vehicle's horn will sound. This panic alarm button will allow you to attract attention, if needed.

If the horn alarm sounds, there are three ways to turn it off:

- Push the panic alarm button on the key fob transmitter again.
- Wait 90 seconds, and the horn will turn off by itself or
- Turn the key to any position in the ignition switch, except OFF.

RFA Settings

You can adjust the settings on the system through the Driver Information Center (DIC). You can have just the driver's or both door locks passively unlock, change the type of alarm used by the theft-deterrent, or have lamps come on when you approach the vehicle. See "Driver Information Center Controls and Displays" in the Index.

Turning the Passive System Off

You can disable the passive feature by moving the transmitter's slider switch to OFF. The vehicle will no longer automatically disarm your theft-deterrent system or unlock the doors, however, you will be able to actively control use of the door locks, the hatch/trunk lid release and the panic alarm using the four transmitter buttons. (These buttons also work when the passive feature is on.)

Make sure to fully slide the switch to either side when turning the key fob transmitter on and off. You should feel a double click when sliding the switch back and forth.

You can also check whether the passive system is on or off by closing the door and moving away from the vehicle with the keys and transmitter. If the doors lock, the passive system is on.

If you are working around your vehicle and keeping your keys with you, you might want to turn the RFA passive system off. If you don't, the transmitter will keep locking and unlocking your doors.

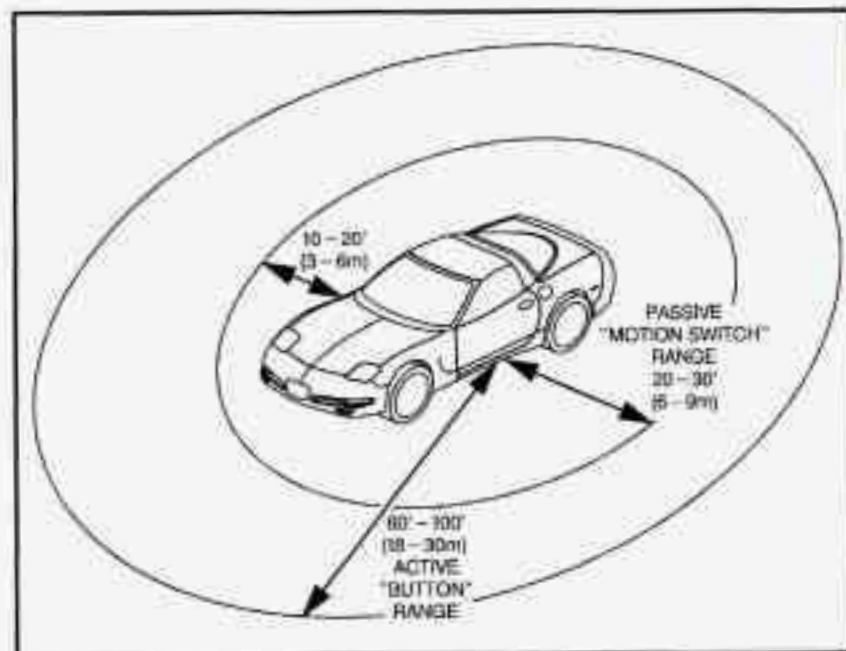

Transmitter Range

The active range (using one of the four buttons) of the key fob transmitter is approximately 60 to 100 feet (18 to 30 m). The passive range (having the slider switch set to ON) is approximately 10 to 20 feet (3 to 6 m) on the passenger's side of the vehicle and 20 to 30 feet (6 to 9 m) on the driver's side.

Resynchronizing Your Transmitter

Your RFA system uses a continually changing code for increased security. Normally, the receiver in your vehicle will keep track of this changing code. If your vehicle does not respond to your transmitter, do the following to determine what's wrong:

1. Get closer to the vehicle and try pressing a button again. Your battery may be low (If so, see "Battery Replacement" in the Index).
2. While standing close to your vehicle, press the LOCK and UNLOCK buttons on your transmitter at the same time and hold for seven seconds. This will attempt to resynchronize the security code in your RFA key fob transmitter.
3. When resynchronization is achieved, the horn will chirp.

Loss of synchronization will occur after transmitter battery replacement or disconnection of the vehicle's battery.

If attempts to resynchronize your transmitter to the vehicle are not successful, you may need to match the transmitter to the vehicle.

Matching Transmitter(s) To Your Vehicle

Each key fob transmitter is coded to prevent another transmitter from unlocking your vehicle. If a transmitter is lost or stolen, a replacement can be purchased through your dealer. Remember to bring any remaining transmitters with you when you go to your dealer. When the dealer matches the replacement transmitter to your vehicle, any remaining transmitters must also be matched. Once your dealer has coded the new transmitter, the lost transmitter will not unlock your vehicle. Each vehicle can have only three transmitters matched to it.

To match transmitters to your vehicle:

1. Turn the ignition key to the ON position.
2. Clear any warning messages on the Driver Information Center (DIC) by pressing the RESET button.
3. Press the OPTIONS button on the DIC several times until the blank page is displayed, then press and hold the RESET button for two seconds.

4. When the message FOB TRAINING is displayed, push the RESET button once. The message HOLD LK + UNLK 1ST FOB will be displayed.
5. Press and hold the LOCK and UNLOCK buttons on the transmitter simultaneously for 15 seconds.
6. When a transmitter is learned, the DIC will display FOB LEARNED and then prompt you to learn the next transmitter.
7. Repeat Steps 5 and 6 for each additional transmitter.
8. Remove the key from the ignition.

The programming mode will shut off if:

- You don't program any transmitters for two minutes.
- You take the key out of the ignition.
- You have programmed three transmitters.

Battery Replacement

Under normal use, the battery in your key fob transmitter should last about 18 months.

You can tell the battery is weak if the transmitter won't work at the normal range in any location. If you have to get close to your vehicle before the transmitter works, it's probably time to change the battery.

NOTICE:

When replacing the battery, use care not to touch any of the circuitry. Static from your body transferred to these surfaces may damage the transmitter.

Replacing Your Battery

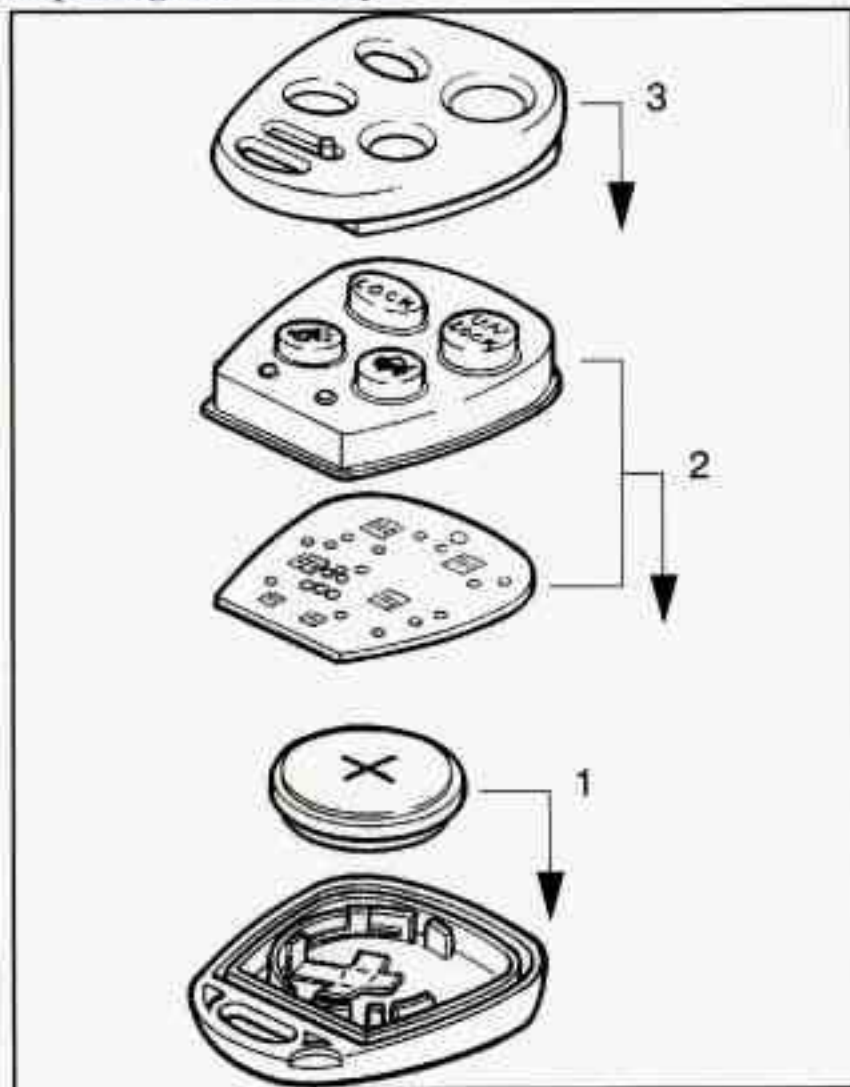

1. Insert a coin into the slot on the back of the transmitter and gently pry apart the front and back.
2. Gently pull the battery out of the transmitter.
3. Put the new battery in the transmitter, positive (+) side up. Use a battery, type CR2450, or equivalent.
4. Reassemble the transmitter in the order shown. Make sure to put it together in the correct order so water won't get in.
5. Resynchronize the transmitter. (See "Resynchronizing Your Transmitter" under Remote Function Actuation System in the Index.)
6. Test the transmitter.

Remote Hatch/Trunk Lid Release



To use the remote hatch/trunk lid release on automatic transmission vehicles, your vehicle must be in **PARK (P)** or **NUETRAL (N)**. For manual transmissions, set the parking brake. See "Parking Brake" in the Index.

Press the button with the trunk symbol on it, located at the left side of the steering column on the instrument panel, to release the hatch/trunk lid from inside your vehicle.

The key fob transmitter will also release the hatch/trunk lid. See "Remote Function Actuation System" in the Index.

If your vehicle is equipped with a hatch and you have lost battery power, use the manual release cables to open the hatch. To access the cables, remove the two access panels located in the rear of the trunk area. There is one cable located underneath each access panel. (See "Storage Compartments" in the Index for more information.)

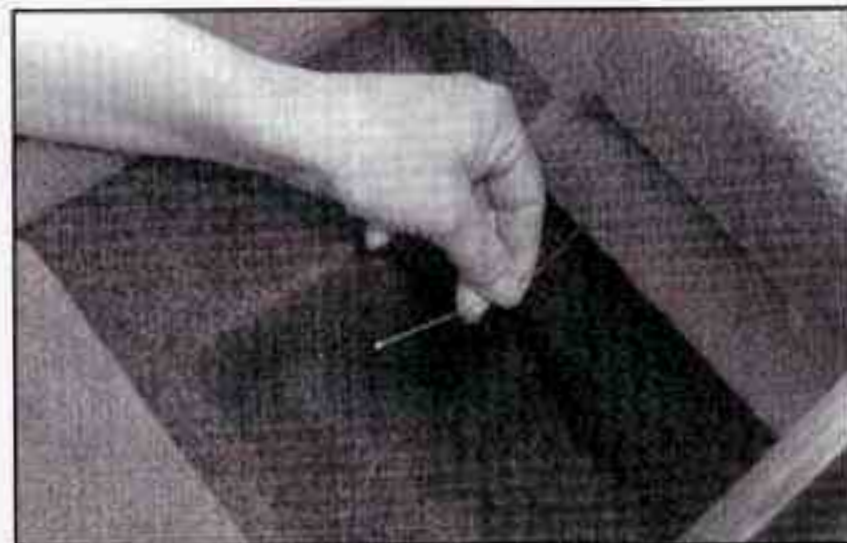

Pull each cable straight down for each latch to release the hatch.

If your vehicle is equipped with a convertible top and you have lost battery power, use the manual release cable to open the trunk lid. To access the cable, remove the center access panel located in the rear of the trunk area. (See “Storage Compartments” in the Index for more information.)



Pull the cable straight down to release the trunk lid.

CAUTION:

It can be dangerous to drive with the hatch/trunk lid open because carbon monoxide (CO) gas can come into your vehicle. You can't see or smell CO. It can cause unconsciousness and even death.

If you must drive with the hatch/trunk lid open or if electrical wiring or other cable connections must pass through the seal between the body and the hatch/trunk lid:

- **Make sure all windows are shut.**
- **Turn the fan on your heating or cooling system to its highest speed with the setting on BI-LEVEL or VENT. That will force outside air into your vehicle. See “Comfort Controls” in the Index.**
- **If you have air outlets on or under the instrument panel, open them all the way. See “Engine Exhaust” in the Index.**

NOTICE:

If you put things in the hatch/trunk area, be sure they won't break the glass when you close it.

Never slam the hatch/trunk lid down. You could break the glass or damage the defogger grid.

When you close the hatch/trunk lid, make sure you pull down from the center, not the sides. If you pull the hatch/trunk lid down from the side too often, the weatherstrip can be damaged.

NOTICE:

Do not store heavy or sharp objects in the three storage compartments located in the hatch/trunk area. If you do, the objects could damage the underbody.

Theft

Vehicle theft is big business, especially in some cities. Although your vehicle has a number of theft-deterrent features, we know that nothing we put on it can make it impossible to steal. However, there are ways you can help.

Key in the Ignition

If you leave your vehicle with the keys inside, it's an easy target for joy riders or professional thieves -- so don't do it.

When you park your vehicle and open the driver's door, you'll hear a tone reminding you to remove your key from the ignition and take it with you. Always do this. Your steering wheel will be locked, and so will your ignition. If you have an automatic transmission, taking your key out also locks your transmission. And remember to lock the doors.

Parking at Night

Park in a lighted spot, close all windows and lock your vehicle. Remember to keep your valuables out of sight. Put them in a storage area, or take them with you.

Parking Lots

If you park in a lot where someone will be watching your vehicle, it's best to lock it up and take your keys. But what if you have to leave your key? Do not leave valuables in your vehicle, since there would be no place to secure them.

Universal Theft-Deterrent System



SECURITY

Your Corvette has a theft-deterrent alarm system. With this system, the SECURITY light will flash as you open the door (if your ignition is off).

This light reminds you to arm the theft-deterrent system. To arm the system, do the following:

To arm the system, do the following:

1. Press the LOCK button on the key fob transmitter, as mentioned earlier, OR
2. Walk out of range with the passive switch on OR
3. Open the door. (The SECURITY light should flash.) Lock the door with the power door lock switch. The SECURITY light will stop flashing and stay on. Close all the doors. The SECURITY light should go off.

Now, if a door or the hatch/trunk lid is opened without the key or the key fob transmitter system, the alarm will go off. Your horn will sound for two minutes, then it will go off to save battery power. And, your vehicle won't start.

The theft-deterrent system won't arm if you lock the doors with a key, the manual door lock, or if you power lock (from the inside) the vehicle after the doors are closed.

If your passenger stays in the vehicle when you leave with the keys, have the passenger lock the vehicle after the doors are closed. This way the alarm won't arm, and your passenger won't set it off.

Always use your key or the key fob transmitter to unlock a door. Unlocking a door any other way will set off the alarm. If you do set off the alarm, there are four ways to stop it:

- Unlock any door with your key.
- Put the key in the ignition.
- Press the UNLOCK button on the key fob transmitter.
- Walk into range with the passive switch on.

Testing the Alarm

1. Make sure the rear hatch/trunk lid is latched.
2. Lower a window on the door.
3. Manually arm the system with the power door lock switch.
4. Close the doors and wait 15 seconds.
5. Reach through the open window and press the power unlock button. Now open the door. The alarm should sound.
6. Turn off the alarm.

If the alarm is inoperative, check to see if the horn works. If not, check the horn fuse. See "Fuses and Circuit Breakers" in the Index. If the horn works, but the alarm doesn't go off, see your dealer.

PASS-Key[®]



Your vehicle is equipped with the PASS-Key (Personalized Automotive Security System) theft-deterrent system. PASS-Key is a passive theft-deterrent system. It works when you insert or remove the key from the ignition.

PASS-Key uses a resistor pellet in the ignition key that matches a decoder in your vehicle.

When the PASS-Key system senses that someone is using the wrong key, it shuts down the vehicle's starter and fuel systems. For about three minutes, the starter won't work and fuel won't go to the engine. If someone tries to start your vehicle again or uses another key during this time, the shutdown period will start over again. This discourages someone from randomly trying different keys with different resistor pellets in an attempt to make a match.

The key must be clean and dry before it's inserted in the ignition or the engine may not start. If the SECURITY light comes on, the key may be dirty or wet.

If this happens and the starter won't work, turn the ignition off. Clean and dry the key, wait three minutes and try again. If the starter still won't work, wait three minutes and try the other ignition key. At this time, you may also want to check the fuses (see "Fuses and Circuit Breakers" in the Index). If the starter won't work with the other key, your vehicle needs service. If your vehicle does start, the first ignition key may be faulty. See your dealer or a locksmith who can service the PASS-Key.

If you accidentally use a key that has a damaged or missing resistor pellet, you will see no SECURITY light. You don't have to wait three minutes before trying the proper key.

If the resistor pellet is damaged or missing, the starter won't work. Use the other ignition key, and see your dealer or a locksmith who can service the PASS-Key to have a new key made.

If the SECURITY light comes on while driving, have your vehicle serviced as soon as possible.

If you lose or damage a PASS-Key ignition key, see your dealer or a locksmith who can service PASS-Key. In an emergency, call the Chevrolet Roadside Assistance Center at 1-800-CHEV-USA (1-800-243-8872). In Canada, call 1-800-268-6800.

New Vehicle “Break-In”

NOTICE:

Your vehicle doesn't need an elaborate “break-in.” But it will perform better in the long run if you follow these guidelines:

- Keep your speed at 55 mph (88 km/h) or less for the first 500 miles (805 km).
- Don't drive at any one speed -- fast or slow -- for the first 500 miles (805 km). Don't make full-throttle starts.
- Avoid making hard stops for the first 200 miles (322 km) or so. During this time your new brake linings aren't yet broken in. Hard stops with new linings can mean premature wear and earlier replacement. Follow this breaking-in guideline every time you get new brake linings.

Ignition Switch

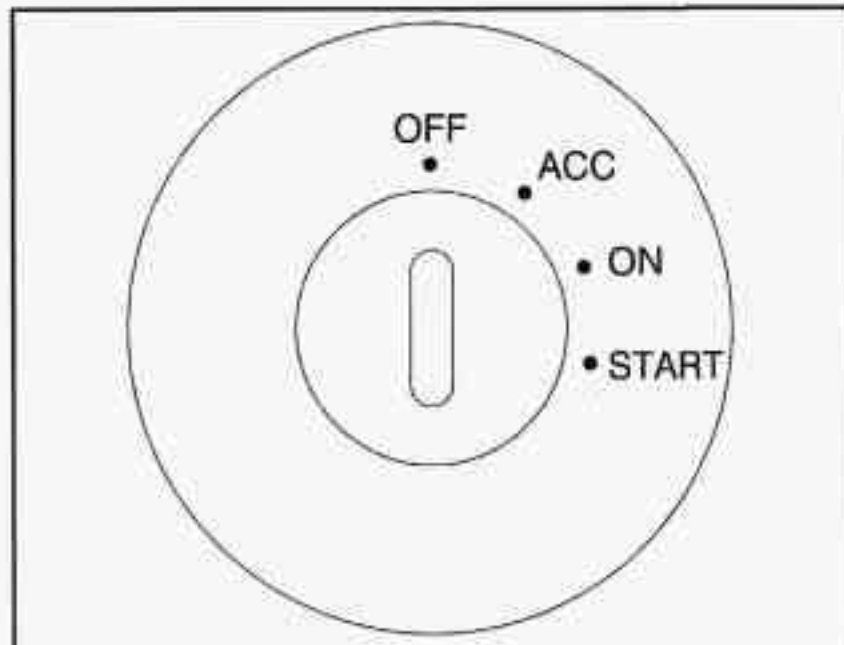

With the key in the ignition switch, you can turn the switch to four positions.

OFF: The only position from which you can remove the key. Removing the key locks your steering wheel, ignition and automatic transmission.

If you have an automatic transmission, the ignition switch can't be turned to OFF unless the shift lever is in PARK (P).

ACC: The position in which you can operate your electrical power accessories. With the key in this position, the automatic transmission and steering column will unlock.

ON: The position to which the switch returns after you start the engine and release the switch. The switch stays in the ON position when the engine is running. But even when the engine is not running, you can use ON to operate your electrical power accessories and to display some instrument panel messages and telltales.

START: Starts the engine. When the engine starts, release the key. The ignition switch will return to ON for normal driving.

When the engine is not running, ACC and ON allow you to operate your electrical accessories, such as the radio.

A warning tone will sound if you open the driver's door when the ignition is in OFF or ACC and the key is in the ignition.



CAUTION:

Removing the key from the ignition switch will lock the steering column and result in a loss of ability to steer the vehicle. This could cause a collision. If you need to turn the engine off while the vehicle is moving, turn the key to ACC.

NOTICE:

If your key seems stuck in OFF and you can't turn it, be sure you are using the correct key; if so, is it all the way in? Turn the key only with your hand. Using a tool to force it could break the key or the ignition switch. If none of this works, then your vehicle needs service.

Retained Accessory Power (RAP)

With RAP, your power windows and the audio system will continue to work for up to 15 minutes after the ignition key is turned to OFF and neither door is opened. If a door is opened, the audio system and power windows will shut off.

Starting Your Engine

This vehicle has a computer system that monitors engine speed, throttle and pedal position, and records the current status.

Automatic Transmission

Move your shift lever to PARK (P) or NEUTRAL (N). Your engine won't start in any other position -- that's a safety feature. To restart when you're already moving, use NEUTRAL (N) only.

NOTICE:

Don't try to shift to PARK (P) if your Corvette is moving. If you do, you could damage the transmission. Shift to PARK (P) only when your vehicle is stopped.

Manual Transmission

The gear selector should be in NEUTRAL (N). Hold the clutch pedal to the floor and start the engine. Your vehicle won't start if the clutch pedal is not all the way down -- that's a safety feature.

Starting Your Engine

1. Without pushing the accelerator pedal, turn the ignition key to START. When the engine starts, let go of the key. The idle speed will go down as your engine gets warm.

NOTICE:

Holding your key in START for longer than 15 seconds at a time will cause your battery to be drained much sooner. And the excessive heat can damage your starter motor.

2. If it doesn't start within 10 seconds, push the accelerator pedal all the way to the floor, while you hold the ignition key in START. When the engine starts, let go of the key and let up on the accelerator pedal. Wait about 15 seconds between each try to help avoid draining your battery or damaging your starter.

When starting your engine in very cold weather (below 0°F or -18°C), do this:

1. With your foot off the accelerator pedal, turn the ignition key to START and hold it there. When the engine starts, let go of the key. Use the accelerator pedal to maintain engine speed, if you have to, until your engine has run for a while.
2. If your engine still won't start (or starts but then stops), it could be flooded with too much gasoline. Try pushing your accelerator pedal all the way to the floor and holding it there as you hold the key in START for about three seconds. If the vehicle starts briefly but then stops again, do the same thing, but this time keep the pedal down for five or six seconds. This clears the extra gasoline from the engine.

NOTICE:

Your engine is designed to work with the electronics in your vehicle. If you add electrical parts or accessories, you could change the way the engine operates. Before adding electrical equipment, check with your dealer. If you don't, your engine might not perform properly.

If you ever have to have your vehicle towed, see the part of this manual that tells how to do it without damaging your vehicle. See "Towing Your Vehicle" in the Index.

Starter Interlock Feature

For your convenience and to avoid damage to your starter, your vehicle is equipped with a starter interlock feature. This feature will not allow you to crank the engine when the vehicle is already running.

Racing or Other Competitive Driving

See your Warranty Book before using your vehicle for racing or other competitive driving.

NOTICE:

If you use your vehicle for racing or other competitive driving, your engine may use more oil than it would with normal use. Low oil levels can damage the engine. Be sure to check the oil level often during racing or other competitive driving and keep the level at or near the upper mark on the engine oil dipstick. You may need to add oil. See "Adding Oil" under "Engine" in the Index.

Engine Coolant Heater (Canada Only)

The engine coolant heater is located on the driver's side of the engine under the manifold. The electrical cord is attached to the generator bracket assembly, between the generator and the windshield washer fluid tank.



In very cold weather, 0°F (-18°C) or colder, the engine coolant heater can help. You'll get easier starting and better fuel economy during engine warm-up. Usually, the coolant heater should be plugged in a minimum of four hours prior to starting your vehicle.

To Use the Engine Coolant Heater

1. Turn off the engine.
2. Open the hood and unwrap the electrical cord. With headlamps closed, route the cord in the opening between the left hand headlamp door and the fender panel. Do not pinch the cord when closing the hood.
3. Plug it into a normal, grounded 110-volt AC outlet.

CAUTION:

Plugging the cord into an ungrounded outlet could cause an electrical shock. Also, the wrong kind of extension cord could overheat and cause a fire. You could be seriously injured. Plug the cord into a properly grounded three-prong 110-volt AC outlet. If the cord won't reach, use a heavy-duty three-prong extension cord rated for at least 15 amps.

4. Before starting the engine, be sure to unplug and store the cord as it was before to keep it away from moving engine parts. If you don't, it could be damaged.

How long should you keep the coolant heater plugged in? The answer depends on the outside temperature, the kind of oil you have, and some other things. Instead of trying to list everything here, we ask that you contact your dealer in the area where you'll be parking your vehicle. The dealer can give you the best advice for that particular area.

Automatic Transmission Operation



There are several different positions for your shift lever.

PARK (P): This locks your rear wheels. It's the best position to use when you start your engine because your vehicle can't move easily.

CAUTION:

It is dangerous to get out of your vehicle if the shift lever is not fully in **PARK (P)** with the parking brake firmly set. Your vehicle can roll. Don't leave your vehicle when the engine is running unless you have to. If you have left the engine running, the vehicle can move suddenly. You or others could be injured. To be sure your vehicle won't move, even when you're on fairly level ground, always set your parking brake and move the shift lever to **PARK (P)**.

See "Shifting Into **PARK (P)**" in the Index.

Be sure the shift lever is fully in **PARK (P)** range before starting the engine. Your vehicle has a brake-transmission shift interlock. You have to fully apply your regular brakes before you can shift from **PARK (P)** when the ignition key is in the **ON** position. If you cannot shift out of **PARK (P)**, ease pressure on the shift lever -- push the shift lever all the way into **PARK (P)** and release the shift lever button as you maintain brake application. Then press the shift lever button and move the shift lever into the gear you wish. (If you do not apply the brake after 15 seconds once the ignition is turned on, you will receive a **PRESS BRAKE BEFORE SHIFT** message in the Driver Information Center.) See "Shifting Out of **PARK (P)**" in the Index.

REVERSE (R): Use this gear to back up.

NOTICE:

Shifting to **REVERSE (R)** while your vehicle is moving forward could damage your transmission. Shift to **REVERSE (R)** only after your vehicle is stopped.

To rock your vehicle back and forth to get out of snow, ice or sand without damaging your transmission, see "Stuck: In Sand, Mud, Ice or Snow" in the Index.

NEUTRAL (N): In this position, your engine doesn't connect with the wheels. To restart when you're already moving, use **NEUTRAL (N)** only. Also, use **NEUTRAL (N)** when your vehicle is being towed.



CAUTION:

Shifting out of **PARK (P)** or **NEUTRAL (N)** while your engine is "racing" (running at high speed) is dangerous. Unless your foot is firmly on the brake pedal, your vehicle could move very rapidly. You could lose control and hit people or objects. Don't shift out of **PARK (P)** or **NEUTRAL (N)** while your engine is racing.

NOTICE:

Damage to your transmission caused by shifting out of PARK (P) or NEUTRAL (N) with the engine racing isn't covered by your warranty.

AUTOMATIC OVERDRIVE (O): This position is for normal driving.

THIRD (3): This position is also used for normal driving, however, it offers more power and lower fuel economy than AUTOMATIC OVERDRIVE (O).

Here are some times you might choose THIRD (3) instead of AUTOMATIC OVERDRIVE (O):

- When driving on hilly, winding roads.
- When going down a steep hill.

SECOND (2): This position gives you more power but lower fuel economy. You can use SECOND (2) on hills. It can help control your speed as you go down steep mountain roads, but then you would also want to use your brakes off and on.

FIRST (1): This position gives you even more power (but lower fuel economy) than SECOND (2). You can use it on very steep hills, or in deep snow or mud. If the selector lever is put in FIRST (1), the transmission won't shift into first gear until the vehicle is going slowly enough.

NOTICE:

If your rear wheels can't rotate, don't try to drive. This might happen if you were stuck in very deep sand or mud or were up against a solid object. You could damage your transmission. Also, if you stop when going uphill, don't hold your vehicle there with only the accelerator pedal. This could overheat and damage the transmission. Use your brakes or shift into PARK (P) to hold your vehicle in position on a hill.

Maximum engine speed is limited to protect driveline components from improper operation.

Manual Transmission Operation

6-Speed

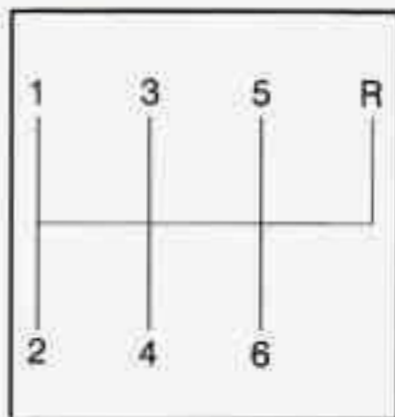

This is your shift pattern. Here's how to operate your transmission:

FIRST (1): Press the clutch pedal and shift into FIRST (1). Then slowly let up on the clutch pedal as you press the accelerator pedal.

You can shift into FIRST (1) when you're going less than 40 mph (64 km/h). If you've come to a complete stop and it's hard to shift into FIRST (1), put the shift lever in NEUTRAL (N) and let up on the clutch. Press the clutch pedal back down. Then shift into FIRST (1).

SECOND (2): Press the clutch pedal as you let up on the accelerator pedal and shift into SECOND (2). Then, slowly let up on the clutch pedal as you press the accelerator pedal.

THIRD (3), FOURTH (4), FIFTH (5) AND SIXTH (6): Shift into THIRD (3), FOURTH (4), FIFTH (5) and SIXTH (6) the same way you do for SECOND (2). Slowly let up on the clutch pedal as you press the accelerator pedal.

To stop, let up on the accelerator pedal and press the brake pedal. Just before the vehicle stops, press the clutch pedal and the brake pedal, and shift to NEUTRAL (N).

NEUTRAL (N): Use this position when you start or idle your engine. Your shift lever is in NEUTRAL (N) when it is centered in the shift pattern, not in any other gear.

REVERSE (R): To back up, press down the clutch pedal and shift into REVERSE (R). Just apply pressure to get the lever past FIFTH (5) and SIXTH (6) into REVERSE (R). Let up on the clutch pedal slowly while pressing the accelerator pedal.

Your six-speed manual transmission has a feature that allows you to safely shift into REVERSE (R) while the vehicle is rolling (at less than 5 mph (8 km/h)). You will be locked out if you try to shift into REVERSE (R) while your vehicle is moving faster than 5 mph (8 km/h). If you have turned your ignition off and wish to park your car in REVERSE (R), you will have to move the shift lever quickly to the right, and immediately forward into gear.

Shift Speeds (Manual Transmission)

This chart shows when to shift to the next higher gear for best fuel economy.

Manual Transmission Recommended Shift Speeds in mph (km/h)					
Engine	Acceleration Shift Speed				
	1 to 2	2 to 3	3 to 4	4 to 5	5 to 6
All Engines	15 (24)	25 (40)	40 (64)	45 (72)	50 (80)

If your engine speed drops below 900 rpm, or if the engine is not running smoothly, you should downshift to the next lower gear. You may have to downshift two or more gears to keep the engine running smoothly or for good performance.

NOTICE:

When you are shifting gears, don't move the gearshift lever around needlessly. This can damage parts of the transmission and may require costly repair. Shift directly into the next appropriate gear.

One to Four Light (Manual Transmission)

1 TO 4
SHIFT

When this light comes on, you can only shift from FIRST (1) to FOURTH (4) instead of FIRST (1) to SECOND (2). You must complete the shift into FOURTH (4) to deactivate this feature. This helps you get the best possible fuel economy.

After shifting to FOURTH (4), you may downshift to a lower gear if you prefer.

NOTICE:

Do not try to force the shift lever into SECOND (2) or THIRD (3) when the ONE TO FOUR light comes on. Do not try to re-engage FIRST (1) after starting to shift into FOURTH (4). You will damage your transmission. Shift only from FIRST (1) to FOURTH (4) when the light comes on.

This light will come on when:

- The engine coolant temperature is higher than 120°F (49°C), and
- You are going 15 to 19 mph (24 to 31 km/h) and
- You are at 21 percent throttle or less.

Downshifting (Manual Transmission)

Do not downshift into the gear shown below at a speed greater than shown in the table:

FIRST (1)	50 mph (80 km/h)
SECOND (2)	74 mph (119 km/h)
THIRD (3)	101 mph (163 km/h)
FOURTH (4)	130 mph (209 km/h)

NOTICE:

If you skip more than one gear when you downshift, or if you race the engine when you downshift, you can damage the clutch, driveshaft or transmission.

The six-speed transmission has a spring that centers the shift lever near **THIRD (3)** and **FOURTH (4)**. This spring helps you know which gear you are in when you are shifting. Be careful when shifting from **FIRST (1)** to **SECOND (2)** or downshifting from **SIXTH (6)** to **FIFTH (5)**. The springs will try to pull the gearshift lever toward **FOURTH (4)** and **THIRD (3)**. Make sure you move the lever into **SECOND (2)** or **FIFTH (5)**. If you let the lever move in the direction of the pulling, you may end up shifting from **FIRST (1)** to **FOURTH (4)** or from **SIXTH (6)** to **THIRD (3)**.



CAUTION:

If you skip more than one gear when you downshift, you could lose control of your vehicle. And you could injure yourself or others. Don't shift from **SIXTH (6) to **THIRD (3)**, **FIFTH (5)** to **SECOND (2)** or **FOURTH (4)** to **FIRST (1)**.**

Parking Brake



To set the parking brake, hold the brake pedal down. Pull the parking brake lever. This sets your parking brake. If the ignition is on, the brake system warning light will come on.



NOTICE:

Driving with the parking brake on can cause your rear brakes to overheat. You may have to replace them, and you could also damage other parts of your vehicle. Make sure the brake warning light is not on before driving.

To release the parking brake, hold the brake pedal down. Hold the release button in as you move the brake lever all the way down.

Shifting Into PARK (P) (Automatic Transmission Only)

CAUTION:

It can be dangerous to get out of your vehicle if the shift lever is not fully in PARK (P) with the parking brake firmly set. Your vehicle can roll. If you have left the engine running, the vehicle can move suddenly. You or others could be injured. To be sure your vehicle won't move, even when you're on fairly level ground, use the steps that follow.



- Hold the brake pedal down with your right foot and set the parking brake.
- Move the shift lever into the PARK (P) position by holding in the button on the lever and pushing the lever all the way toward the front of your vehicle.
- Turn the ignition key to OFF.
- Remove the key and take it with you. If you can remove the key from your ignition, your vehicle is in PARK (P).

Leaving Your Vehicle With the Engine Running (Automatic Transmission Only)

CAUTION:

It can be dangerous to leave your vehicle with the engine running. Your vehicle could move suddenly if the shift lever is not fully in PARK (P) with the parking brake firmly set. And, if you leave the vehicle with the engine running, it could overheat and even catch fire. You or others could be injured. Don't leave your vehicle with the engine running unless you have to.

Torque Lock (Automatic Transmission)

If you are parking on a hill and you don't shift your transmission into PARK (P) properly, the weight of the vehicle may put too much force on the parking pawl in the transmission. You may find it difficult to pull the shift lever out of PARK (P). This is called "torque lock." To prevent torque lock, set the parking brake and then shift into PARK (P) properly before you leave the driver's seat. To find out how, see "Shifting Into PARK (P)" in the Index.

When you are ready to drive, move the shift lever out of PARK (P) *before* you release the parking brake.

If torque lock does occur, you may need to have another vehicle push yours a little uphill to take some of the pressure from the parking pawl in the transmission, so you can pull the shift lever out of PARK (P).

Shifting Out of PARK (P) (Automatic Transmission)

Your vehicle has a brake-transmission shift interlock. You have to fully apply your regular brake before you can shift from PARK (P) when the ignition is in the ON position. See “Automatic Transmission Operation” in the Index.

As a prompt, you will see a message in the Driver Information Center (DIC) that will say **PRESS BRAKE BEFORE SHIFT** within 15 seconds unless the brake is pressed.

If you cannot shift out of PARK (P), ease pressure on the shift lever -- push the shift lever all the way into PARK (P) and release the shift lever button as you maintain brake application. Then press the shift lever button and move the shift lever into the gear you wish.

If you ever hold the brake pedal down but still can't shift out of PARK (P), try this:

1. Turn the key to the ACC position.
2. Apply and hold the brake until the end of Step 4.
3. Shift to NEUTRAL (N).
4. Start the engine and then shift to the drive gear you want.
5. Have your vehicle inspected by your dealer as soon as possible.

Parking Your Vehicle (Manual Transmission)

Before you get out of your vehicle, put your manual transmission in REVERSE (R) and firmly apply the parking brake.

Parking Over Things That Burn



CAUTION:

Things that can burn could touch hot exhaust parts under your vehicle and ignite. Don't park over papers, leaves, dry grass or other things that can burn.

Engine Exhaust

CAUTION:

Engine exhaust can kill. It contains the gas carbon monoxide (CO), which you can't see or smell. It can cause unconsciousness and death.

You might have exhaust coming in if:

- Your exhaust system sounds strange or different.
- Your vehicle gets rusty underneath.
- Your vehicle was damaged in a collision.
- Your vehicle was damaged when driving over high points on the road or over road debris.
- Repairs weren't done correctly.
- Your vehicle or exhaust system had been modified improperly.

If you ever suspect exhaust is coming into your vehicle:

- Drive it only with all the windows down to blow out any CO; and
- Have your vehicle fixed immediately.

Running Your Engine While You're Parked (Automatic Transmission)

It's better not to park with the engine running. But if you ever have to, here are some things to know.

CAUTION:

Idling the engine with the climate control system off could allow dangerous exhaust into your vehicle (see the earlier Caution under "Engine Exhaust").

Also, idling in a closed-in place can let deadly carbon monoxide (CO) into your vehicle even if the fan switch is at the highest setting. One place this can happen is a garage. Exhaust -- with CO -- can come in easily. NEVER park in a garage with the engine running.

Another closed-in place can be a blizzard. (See "Blizzard" in the Index.)

CAUTION:

It can be dangerous to get out of your vehicle if the shift lever is not fully in PARK (P) with the parking brake firmly set. Your vehicle can roll. Don't leave your vehicle when the engine is running unless you have to. If you've left the engine running, the vehicle can move suddenly. You or others could be injured. To be sure your vehicle won't move, even when you're on fairly level ground, always set your parking brake and move the shift lever to PARK (P).

Follow the proper steps to be sure your vehicle won't move. See "Shifting Into PARK (P)" in the Index.

Limited-Slip Rear Axle

Your limited-slip rear axle can give you additional traction on snow, mud, ice, sand or gravel. It works like a standard axle most of the time, but when one of the rear wheels has no traction and the other does, this feature will allow the wheel with traction to move the vehicle.

Selective Real Time Damping (Option)

You may have a ride control system on your vehicle called Selective Real Time Damping (SRTD). The system provides the following performance benefits:

- Reduced impact harshness
- Improved road isolation
- Improved high-speed stability
- Improved handling response



This knob is on the center console. Turn it to select the suspension characteristic of your choice.

TOUR: Use for normal city and highway driving. Provides a smooth, soft ride.

SPORT: Use where road conditions or personal preference demand more control. Provides more “feel,” or response to the road conditions.

PERF: Use for performance driving. Provides a tight, firm ride and precise response to road conditions.

You can select a setting at any time. Based on road conditions, steering wheel angle and your vehicle speed, the system automatically adjusts to provide the best ride and handling. Select a new setting whenever driving conditions change.

There are three Driver Information Center messages that are displayed when a malfunction occurs with the SRTD system. Refer to “Driver Information Center Warnings and Messages” in the Index.

Windows

Power Windows



With power windows, switches on the door control each window when the ignition is on or when RAP is present. (See “Retained Accessory Power” in the Index.)

Express-Down Window

Both the driver's and passenger's window switches have an express-down feature. Press AUTO and hold for less than one-third of a second and release. The window will lower completely. To stop express-down feature from lowering the window completely, simply press the switch again.

You can also open the window any amount by pressing and releasing the switch.

Horn

To sound the horn, press either horn symbol on your steering wheel.

Tilt Wheel



A tilt wheel allows you to adjust the steering wheel.

You can also raise it to the highest level to give your legs more room when you exit and enter the vehicle.

To tilt the wheel, hold the steering wheel and pull the lever toward you. Move the steering wheel to a comfortable level, then release the lever to lock the wheel into place.

Turn Signal/Multifunction Lever

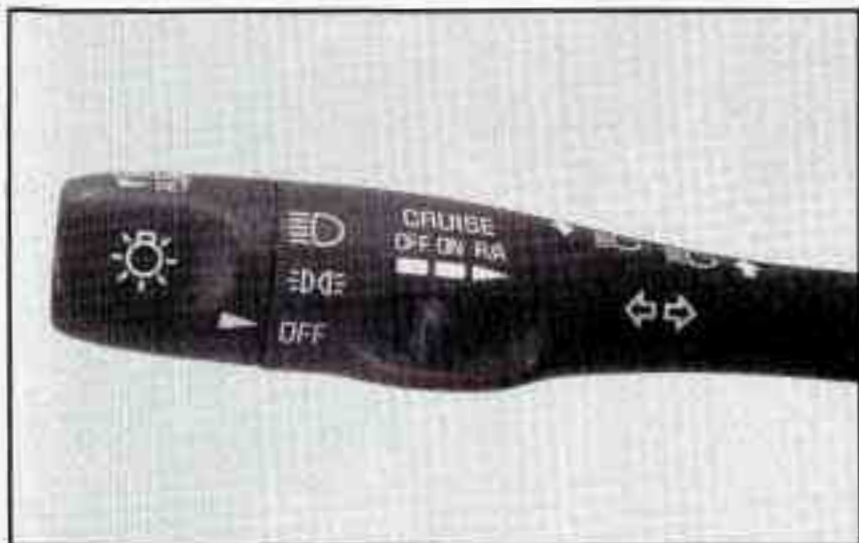

The multifunction lever on the left side of the steering column includes your:

- Turn Signal and Lane Change Control
- Headlamp High/Low-Beam Changer
- Cruise Control
- Headlamps Switch
- Flash-To-Pass

Turn and Lane Change Signals

The turn signal has two upward (for right) and two downward (for left) positions. These positions allow you to signal a turn or a lane change.

To signal a turn, move the multifunction lever all the way up or down. When the turn is finished, the lever will return automatically.

A chime will remind you if you leave your turn signal on for more than 3/4 of a mile (1.2 km) of driving.

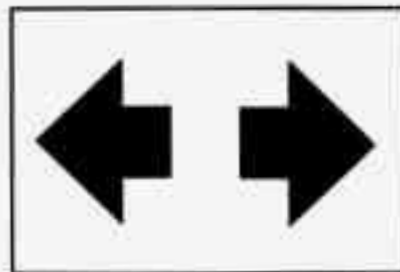

A green arrow on the instrument cluster will flash in the direction of the turn or lane change.

To signal a lane change, just raise or lower the lever until the arrow starts to flash. Hold it there until you complete your lane change. The lever will return by itself when you release it.

As you signal a turn or a lane change, if the arrows flash faster than normal, a signal bulb may be burned out.

If a bulb is burned out, replace it to help avoid an accident. If the arrows don't go on at all when you signal a turn, check the fuses and check for burned-out bulbs. (See "Fuses and Circuit Breakers" in the Index.)

Headlamps

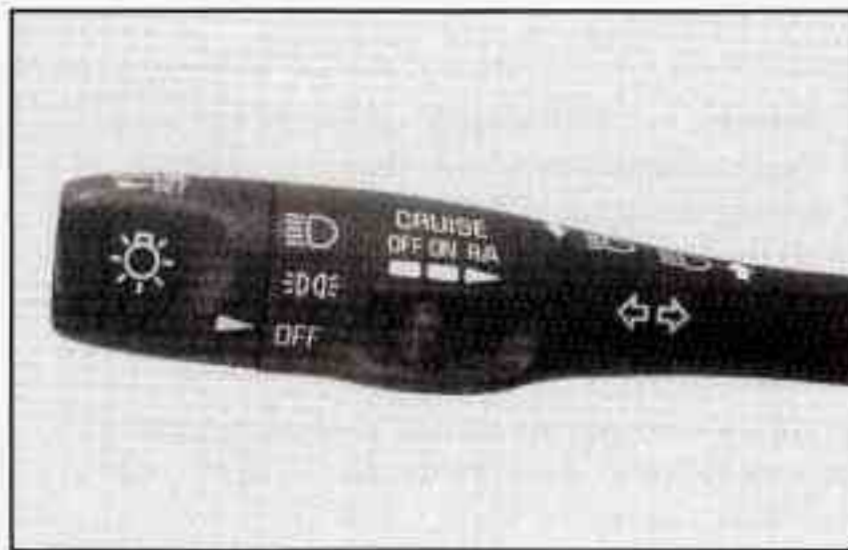

The headlamp band controls these lamps:

- Headlamps
- Taillamps
- Parking lamps
- Sidemarkers lamps

 Turn the band to this symbol to turn on your headlamps and other operating lamps.

 Turn the band to this symbol to turn on your parking and other operating lamps without your headlamps.

Turn the band to OFF to turn off the lamps.

To read your odometer with the ignition off, turn on your parking lamps.

Headlamp Doors



The headlamp doors are designed to open when you turn the headlamps on, and close when you turn the headlamps and parking lamps off. If you turn the headlamps on, then turn the headlamp switch back to the parking lamps setting, the headlamp doors will stay open.

You can open the doors manually using the knob next to the headlamp assembly. Turn the knob to the left until the doors are open.

The headlamp doors should be open when driving in icy or snowy conditions to prevent the doors from freezing closed and when washing the vehicle to help clean the headlamps.

NOTICE:

In order to avoid possible contact of the hood to the headlamp doors, care should be taken in raising the hood with the headlamps up, or shut off the lamps prior to opening the hood.

Lamps On Reminder

If you turn the ignition off and leave the headlamps or parking lamps on and open the door, you will hear a chime.

Headlamp High/Low-Beam Changer

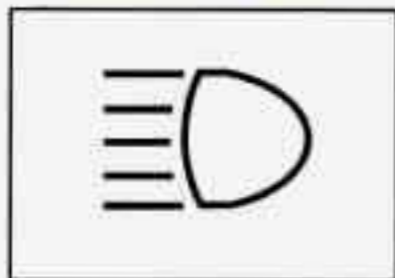

To change the headlamps from low beam to high or high to low, push the turn signal lever all the way forward.

When the high beams are on, this light on the instrument panel also will be on. To change the headlamps from high to low, pull the lever rearward.

Flash-To-Pass

Momentarily pull the turn signal lever toward you. The high-beam indicator will flash to indicate to the other driver that you intend to pass. If the low-beam headlamps are off and you have the optional fog lamps on, the fog lamps will flash.

Windshield Wipers

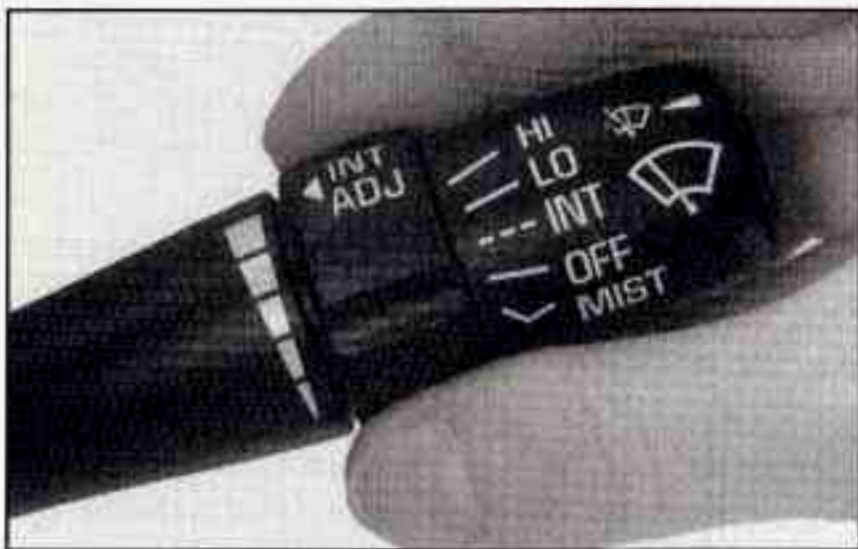

You can control the windshield wipers by moving the lever with the wiper symbol on it. This lever is located on the right side of your steering column.

For a single wiping cycle, push the lever down to MIST. Hold it there until the wipers start, then let go. The wipers will stop after one cycle. If you want more cycles, hold the lever on MIST longer.

You can set the wiper speed for a long or short delay between wipes. This can be very useful in light rain or snow. Push the lever up to INT (intermittent), then turn the band, located on the lever, to adjust the delay time. Rotate the band up for a shorter delay, down for a longer delay. The wiper speed can only be adjusted when the lever is in the INT position, not in HI or LO.

For steady wiping at low speed, move the lever up to the LO position. For steady high-speed wiping, move the lever up further, to HI. To stop the wipers, move the lever down to OFF.

Be sure to clear ice and snow from the wiper blades before using them. If they're frozen to the windshield, carefully loosen or thaw them. If your blades do become damaged, get new blades or blade inserts.

Heavy snow or ice can overload your wipers. A circuit breaker will stop them until the motor cools. Clear away snow or ice to prevent an overload.

Windshield Washer

The lever on the right side of your steering column also controls your windshield washer. There is a push button at the end of the lever. To spray washer fluid on the windshield, push the button and hold it. The washer will spray until you release the button. The wipers will continue to clear the window for about six seconds after the button is released and then stop or return to your preset speed.



CAUTION:

In freezing weather, don't use your washer until the windshield is warmed. Otherwise the washer fluid can form ice on the windshield, blocking your vision.

If the fluid in the windshield washer fluid reservoir is low, the message LOW WASHER FLUID will appear on the Driver Information Center (DIC) display. It will take 60 seconds after the bottle is refilled for this message to turn off. For information on the correct washer fluid mixture to use, see "Windshield Washer Fluid" and "Recommended Fluids and Lubricants" in the Index.

Cruise Control

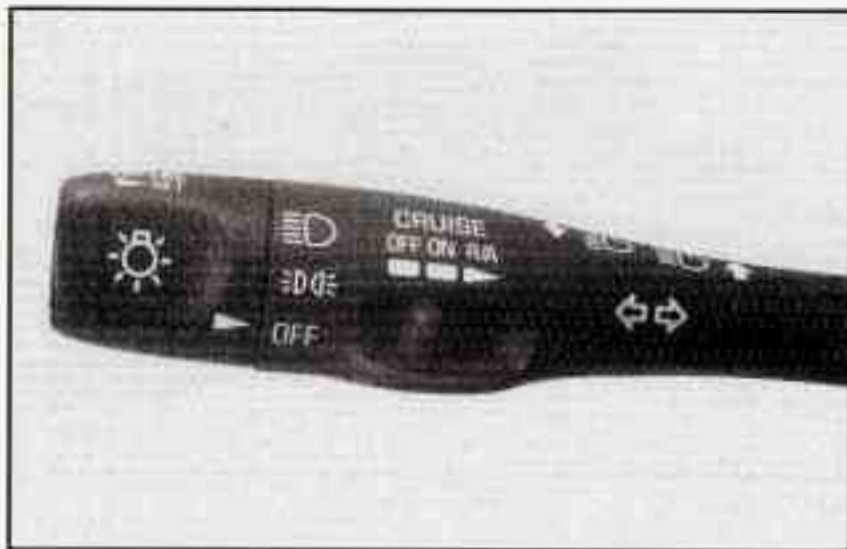

With cruise control, you can maintain a speed of about 25 mph (40 km/h) or more without keeping your foot on the accelerator. This can really help on long trips. Cruise control does not work at speeds below about 25 mph (40 km/h).

When using cruise control, the accelerator pedal will return to its fully-released position and will not move while cruise control is engaged.

The Driver Information Center (DIC) will display the cruise set speed in a digital number. For example, the

DIC will say CRUISE SET 60 mph (97 km/h). When you apply your brakes or push the clutch pedal, the cruise control disengages. The DIC will show CRUISE DISENGAGED. See “DIC Warnings and Messages” in the Index.

CAUTION:

- Cruise control can be dangerous where you can't drive safely at a steady speed. So, don't use your cruise control on winding roads or in heavy traffic.
- Cruise control can be dangerous on slippery roads. On such roads, fast changes in tire traction can cause needless wheel spinning, and you could lose control. Don't use cruise control on slippery roads.

If your vehicle is in cruise control when the traction control system begins to limit wheel spin, the cruise control will automatically disengage. (See “Traction Control System” in the Index.) When road conditions allow you to safely use it again, you may turn the cruise control back on.

Setting Cruise Control

CAUTION:

If you leave your cruise control switch on when you're not using cruise, you might hit a button and go into cruise when you don't want to. You could be startled and even lose control. Keep the cruise control switch off until you want to use it.

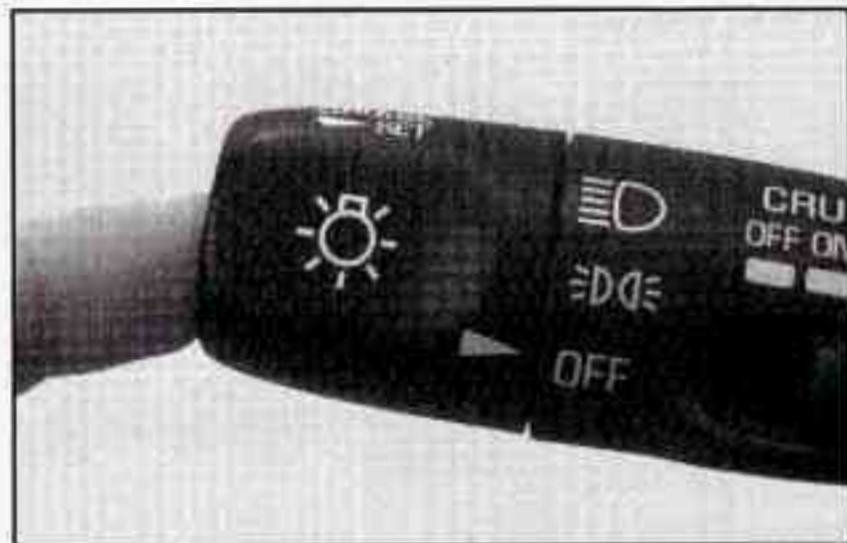

1. Move the cruise control switch to ON.
2. Get up to the speed you want.
3. Push the SET/COAST button at the end of the lever and release it. The cruise set speed will be displayed by the Driver Information Center (DIC).
4. Take your foot off the accelerator pedal. The pedal will return to an "idle" position.

Resuming a Set Speed

Suppose you set your cruise control at a desired speed and then you apply the brake or clutch pedal. This, of course, disengages the cruise control. But you don't need to reset it.

Once you're going about 25 mph (40 km/h) or more, you can move the cruise control switch to R/A (Resume/Accelerate) for about half a second. The Driver Information Center (DIC) will display the cruise set speed.

You'll go right back up to your chosen speed and stay there.

Increasing Speed While Using Cruise Control

There are two ways to go to a higher speed:

1. Use the accelerator pedal to get to the higher speed. The speed will not begin to increase until sufficient pedal travel is achieved. Push the button at the end of the lever, then release the button and the accelerator pedal. You'll now cruise at the higher speed.

The Driver Information Center (DIC) will display the cruise set speed.

2. Move the cruise switch to R/A. Hold it there until you get up to the speed you want, then release the switch. To increase your speed in very small amounts, move the switch to R/A for less than half a second, then release it. Each time you do this, your vehicle will go about 1 mph (1.6 km/h) faster.

The DIC will display the cruise set speed.

Reducing Speed While Using Cruise Control

There are two ways to reduce your speed while using cruise control:

- Push in the button at the end of the lever until you reach the lower speed you want, then release it.

The Driver Information Center (DIC) will display the cruise set speed.

- To slow down in very small amounts, push the button for less than half a second. Each time you do this, you'll go 1 mph (1.6 km/h) slower.

The DIC will display the cruise set speed.

Passing Another Vehicle While Using Cruise Control

Use the accelerator pedal to increase your speed. When you take your foot off the pedal, your vehicle will slow down to the cruise control speed you set earlier.

Using Cruise Control on Hills

How well your cruise control will work on hills depends upon your speed, load and the steepness of the hills. When going downhill, you may have to brake or shift to a lower gear to keep your speed down. Of course, applying the brake takes you out of cruise control. Many drivers find this to be too much trouble and don't use cruise control on steep hills.

Getting Out of Cruise Control

There are two ways to turn off the cruise control:

- Step lightly on the brake pedal or push the clutch pedal, if you have a manual transmission vehicle; or
- Move the cruise switch to OFF.

The DIC will display the message "CRUISE DISENGAGED."

Erasing Speed Memory

When you turn off the cruise control or the ignition, your cruise control set speed memory is erased.

Exterior Lamps

Daytime Running Lamps

Daytime Running Lamps (DRL) can make it easier for others to see the front of your vehicle during the day. DRL can be helpful in many different driving conditions, but they can be especially helpful in the short periods after dawn and before sunset.

The DRL system will make your front turn signal lamps come on when:

- the ignition is on,
- the headlamp switch is off and
- the parking brake is released.

When the DRL are on, only your front turn signal lamps will be on. The taillamps, sidemarker and other lamps will not be on.

When you turn on your headlamps, your front turn signal lamps (DRL) will go out. The other lamps that come on with your headlamps will also come on.

On vehicles built for Canada, when it's dark enough outside, your front turn signal lamps will automatically go out and your headlamps will come on. The other lamps that come on with your headlamps will also come on. When it's bright enough outside, the headlamps will go off, and your front turn signal lamps (DRL) will come on.

Also on Canadian vehicles, there is a light sensor in the defroster grille, at the base of the windshield and the instrument panel. This sensor makes the DRL work automatically, so be sure it isn't covered.

As with any vehicle, you should turn on the regular headlamp system when you need it.

Fog Lamps (Option)



Use your fog lamps for better vision in foggy or misty conditions. Your parking lamps or low-beam headlamps must be on or your fog lamps won't work.

To turn the fog lamps on, push the button located on the instrument panel to the left of the steering column. A light on the button will come on when the fog lamps are on. Push the button again to turn the fog lamps off.

Interior Lamps

Instrument Panel Brightness Control



This button controls the brightness of your instrument panel lights when your headlamps or parking lamps are on.

Push and release the button and it will pop out. Turn the button clockwise (to the right) to brighten the lights or counterclockwise (to the left) to dim them.

The instrument panel brightness knob has an added feature called Parade Mode to assist you in seeing certain instrument panel controls if your headlamps are on in the daylight. Right before turning the courtesy lamps on by turning the button all the way to the right, the radio, Driver Information Center (DIC) display and heating and air conditioning controls will come on at their maximum brightness. This will occur only with the parking lamps or headlamps on.

Courtesy Lamps

When any door or the hatch/trunk lid is opened, the interior lamps will go on (unless it's bright outside). The lamps will stay on for about 30 seconds or until you turn on the ignition.

You can also turn on the courtesy lamps by turning the interior brightness control button all the way to the right.

Be sure not to have this knob turned all the way down with the lamps on during the day. Your Driver Information Center (DIC) may not be visible.

Reading Lamps

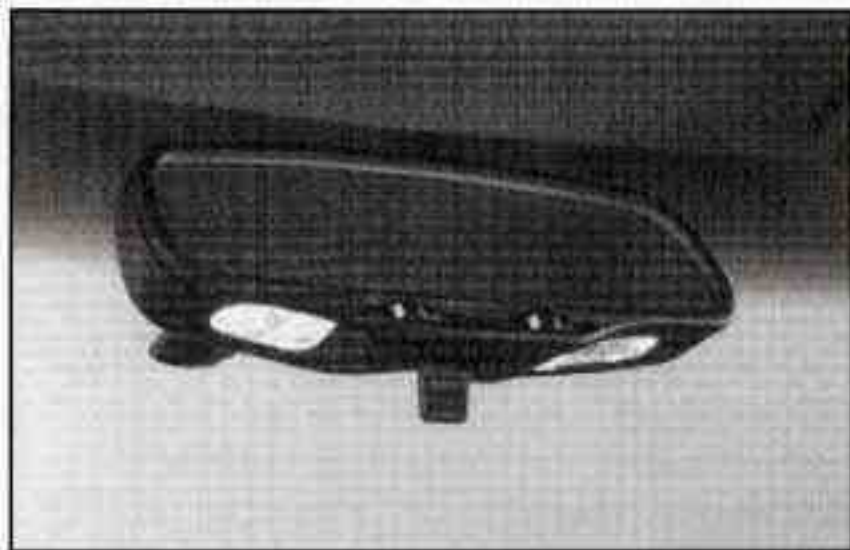

Your inside rearview mirror includes two reading lamps. The lamps will go on when a door is opened. When the doors are closed and the ignition is on, each lamp can be turned on individually by moving the switch (each lamp has its own switch) to ON.

There is also an interior console flood lamp located underneath the rearview mirror which comes on with the headlamps or parking lamps.

Inadvertent Load Control

If the underhood lamp, vanity mirror lamps, reading lamps, console or glove box lamps are accidentally left on, the power load will time out after 15 minutes. To reset it, all of the above lamps must be turned off or the key must be in the ON position.

Mirrors

Inside Day/Night Rearview Mirror

An inside rearview mirror is attached above your windshield. The mirror has pivots so that you can adjust it.

You can adjust the mirror for day or night driving. Pull the tab for night driving to reduce glare. Push the tab for daytime driving.

Power/Heated Remote Control Mirrors



The electric mirror control is on the driver's door. To adjust either mirror, press the LT (left) or RT (right) switch to select the mirror, then press the arrows to adjust the direction of the mirror. The selected mirror will stay on for 20 seconds after the last adjustment. An indicator light will come on above the mirror that you select.

Your preferred mirror position can be stored if you have the memory option. See "Memory" in the Index.

For operation of the heated outside mirrors, see "Rear Window Defogger" in the Index.

Convex Outside Mirror

Your passenger's side mirror is convex. A convex mirror's surface is curved so you can see more from the driver's seat.

CAUTION:

A convex mirror can make things (like other vehicles) look farther away than they really are. If you cut too sharply into the right lane, you could hit a vehicle on your right. Check your inside mirror or glance over your shoulder before changing lanes.

Storage Compartments

Instrument Panel Cupholder

The cupholder is located on the center console. To open it, place your thumb on the left side of the lid and raise the right side with your index finger.

Center Console

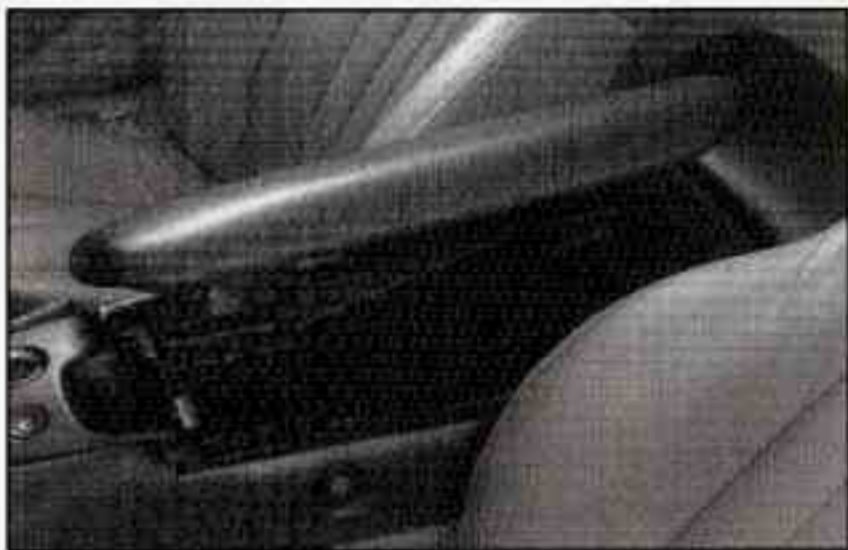

To use this storage area, pull up the lid on the driver's side front edge of the console and swing it to the passenger's side.

You can use the key to lock and unlock the console. Don't leave the key in the lock, or it could be damaged when the driver sits down.

The fuel fill door release and accessory outlet are located inside the console.

Security Shade (Option)

The security shade can provide hidden storage in the rear area of your vehicle. The shade is also helpful in blocking the glare from the removeable roof when it is stored in the rear compartment.

Using the Security Shade

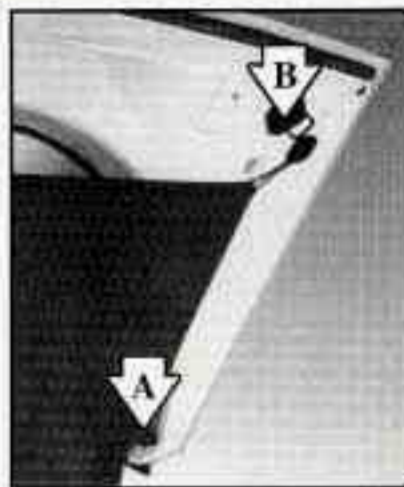

1. Hook the elastic loops on the front corners (A) of the shade to the T-nuts located on the front corners of the rear hatch frame.

2. Hook the elastic loops on the rear corners (B) of the shade to the hooks recessed inside the rear hatch frame, near the rear corners.

Rear Storage

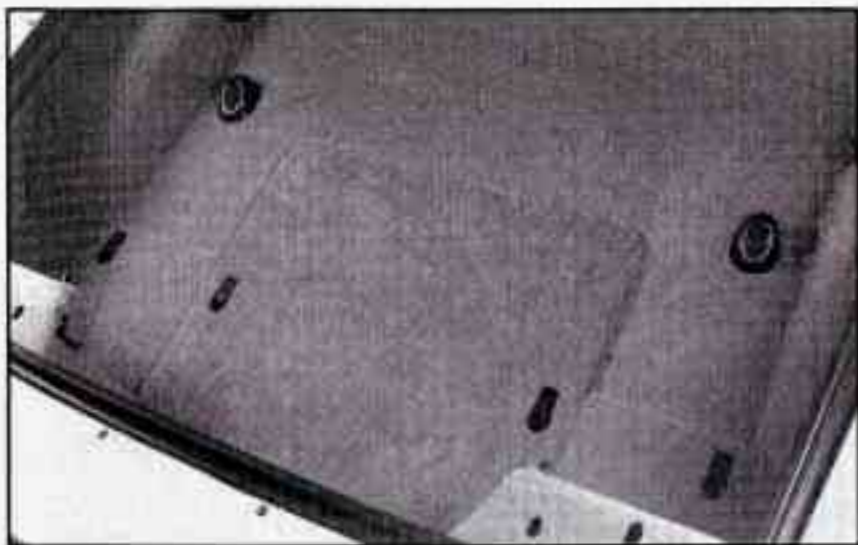

There are three rear storage compartments in the floor of the rear hatch/trunk area.

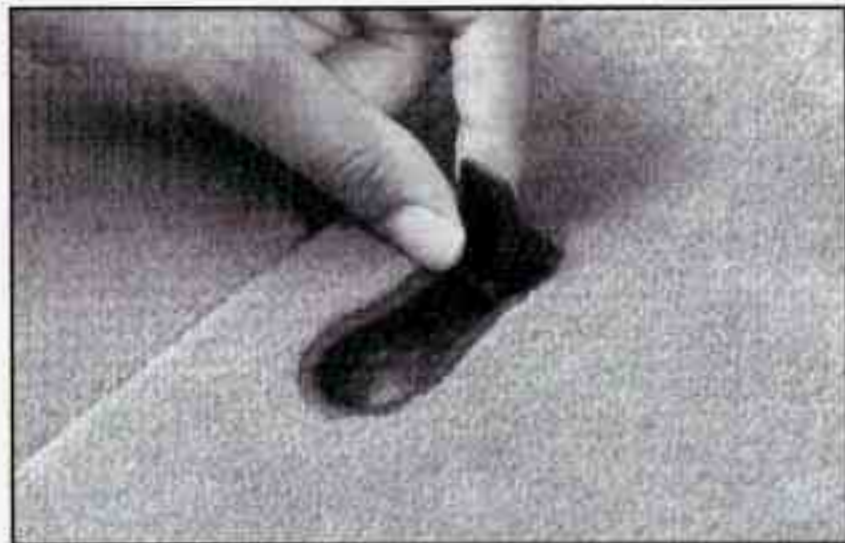

To access the center storage compartment, pull up on the two latches to release the carpet lid.

Remove the carpet lid. There are two other storage compartments, one on each side of the center compartment. Each of these compartments has one latch which operates the same as the two on the center carpet lid.

NOTICE:

If your vehicle has a compact disc player, it is stored in the center rear storage compartment. To help avoid damage to the compact disc player, do not store items such as liquids or sharp objects that could puncture or cut the compact disc player or wiring.

NOTICE:

Do not store heavy or sharp objects in the three storage compartments located in the hatch/trunk area. If you do, the objects could damage the underbody.

Convenience Net (Option)

Your vehicle may have a convenience net. You will see it on the back wall of the rear area of the vehicle.

Put small loads, like grocery bags, in the net. It can help keep them from falling over during sharp turns or quick starts and stops. The net is not for larger, heavier loads.

You can unhook the net and place it in one of the rear storage pockets when you are not using it. On coupe models only, a vinyl storage bag has also been provided.

Ashtray and Cigarette Lighter

The ashtray is located on the instrument panel, next to the lighter. To use the ashtray, lift up on the bottom of the door.

NOTICE:

Don't put papers and other things that burn into your ashtray. If you do, cigarettes or other smoking materials could set them on fire, causing damage.

NOTICE:

Loose objects (such as paper clips) can lodge behind and beneath the ashtray lid and prevent movement of the lid. Avoid putting small loose objects near the ashtray.

To use the lighter, push it in all the way and let go. When it's ready, it will pop back by itself.

NOTICE:

Don't hold a cigarette lighter in with your hand while it is heating. If you do, it won't be able to back away from the heating element when it's ready. That can make it overheat, damaging the lighter and the heating element.

Sun Visors

To block out glare, you can swing down the visors. You can also swing them to the side.

Visor Vanity Mirror

Pull down the sun visor and lift the cover to expose the vanity mirror. When the cover is lifted, the lamps will come on automatically, even if the ignition is off.

Accessory Outlet

This outlet is located inside the center console, on the forward left side. Remove the tethered cap to use the outlet. The outlet can be used to connect electrical equipment such as a cellular phone or CB radio. Be sure to follow the installation instructions included with the equipment. Replace the cap when the outlet is not in use.

NOTICE:

When using the accessory outlet:

- **The maximum load of any electrical equipment should not exceed 15 amps.**
- **Be sure to turn off any electrical equipment when not in use. Leaving electrical equipment on for extended periods can drain your battery.**

We recommend that you see a qualified technician or your dealer for the proper installation of your equipment.

Floor Mats (Option)

Your vehicle's floor mats are specially designed to remain in position under your feet and out of reach of the accelerator pedal. The driver's side floor mat is held in place by two locator hooks and the passenger's side is held in place by one.

Be sure that the driver's side floor mat is properly placed on the floor so that it does not block the movement of the accelerator pedal.

How to Remove and Replace the Floor Mats

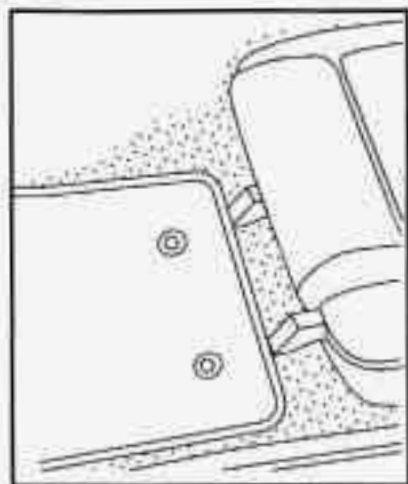

To remove the floor mats, pull up on the rear of the mat to disconnect from the locator hooks.

To reinstall the floor mats, line up the openings in the floor mat over the locator hooks and push down into place.

For proper cleaning instructions of the carpeted floor mats, see "Fabric Protection" in the Index.

Roof Panel (Coupe)

Removing the Roof Panel



CAUTION:

Don't try to remove the roof panel while the vehicle is moving. Trying to remove the roof panel while the vehicle is moving could cause an accident. The panel could fall into the vehicle and cause you to lose control, or it could fly off and strike another vehicle. You or others could be injured. Remove the roof panel only when the vehicle is parked.

Until you are sure you can remove the panel alone, have someone help you.

NOTICE:

To avoid damage to the roof panel, paint and weatherstripping do not drop or rest it on its edges. Place the roof panel in the egg-shaped stowage receivers after removing it from the vehicle.



1. Park on a level surface; set the parking brake firmly and shift an automatic transmission into PARK (P). Shift a manual transmission into REVERSE (R). Turn the ignition key to OFF. Lower both sunshades and rotate them toward the door glass.
2. Open the rear liftgate and remove any items that may interfere with proper storage of the roof panel. Also install the two egg-shaped stowage receivers into the floor of the rear storage compartment. Secure both receivers into their proper positions by turning them to the left.
3. Lower the windows and open the doors.

There are two latches on the front of the roof panel near each door (A), and one rear latch (B).

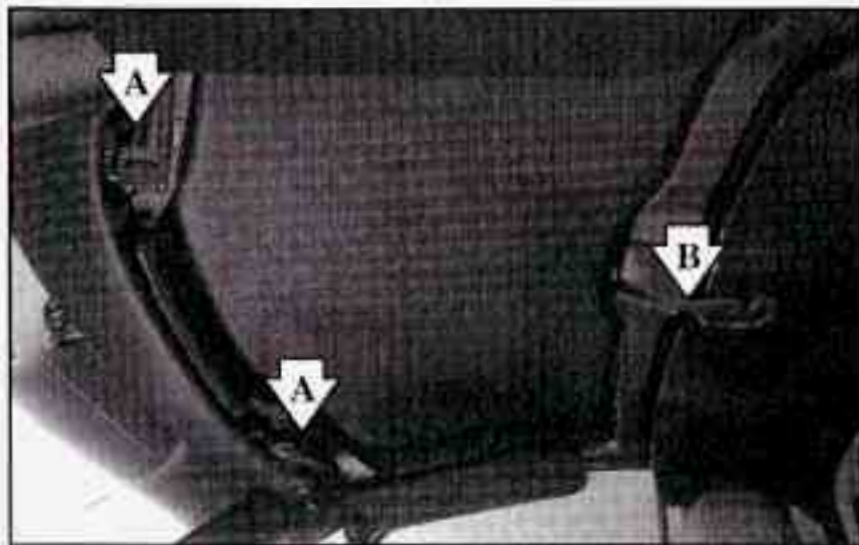

4. To unlock the front of the roof panel, pull down each of the front handles. Grasp the handles with your fingers and pull each toward you. Complete a 180° rotation toward the center of the vehicle. Then push up on each of the handles.



5. To unlock the rear of the roof panel, press the latch release button with your thumb and pull down the latch lever with your fingers.
6. After releasing the latches, return the sun visors to the forward position.
7. Stand on one side of the vehicle and, if necessary, have your helper stand on the other side. Together, carefully lift the front edge of the panel up and forward, and out of the vehicle opening.
8. When the panel is loosened from the vehicle, one person should grasp the roof panel as close to the center of the car as possible and lift away the panel.

Storing the Roof Panel

CAUTION:

If the roof panel is not stored properly, it could be thrown about the vehicle in a crash or sudden maneuver. People in the vehicle could be injured. Whenever you store the roof panel in the vehicle, always be sure that it is stored securely in the rear area using the storage pins.

NOTICE:

To avoid damage to the roof panel, paint and weatherstripping, do not drop or rest it on its edges. Place the roof panel in the egg-shaped stowage receivers after removing it from the vehicle.

1. Turn the roof panel so that the rear edge of the panel is facing the storage area. The locating pins (at the rear of the panel) should point toward the egg-shaped stowage receivers on the floor of the center compartment.
2. Push the panel forward until the pins bottom out in the receivers.

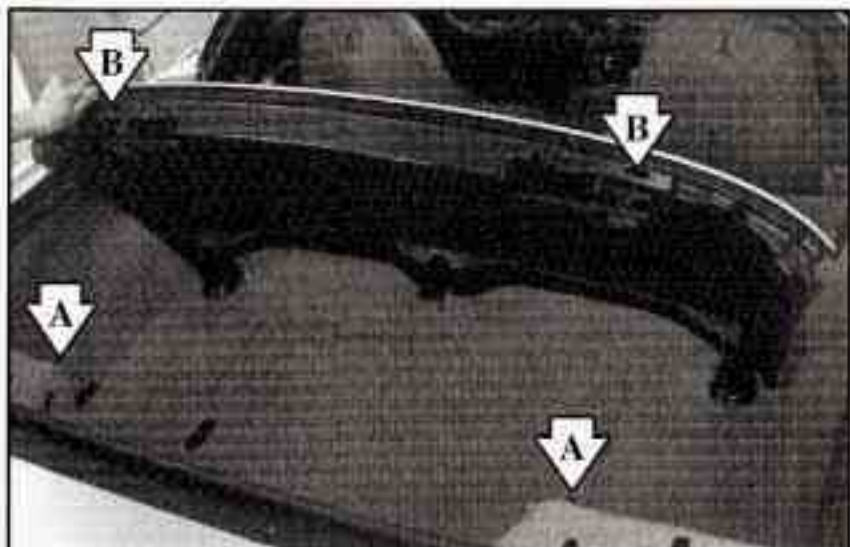

3. There are two spring-loaded storage pins on the rear wall of the storage compartment (A). These storage pins go into the slots on each side of the roof panel (B).

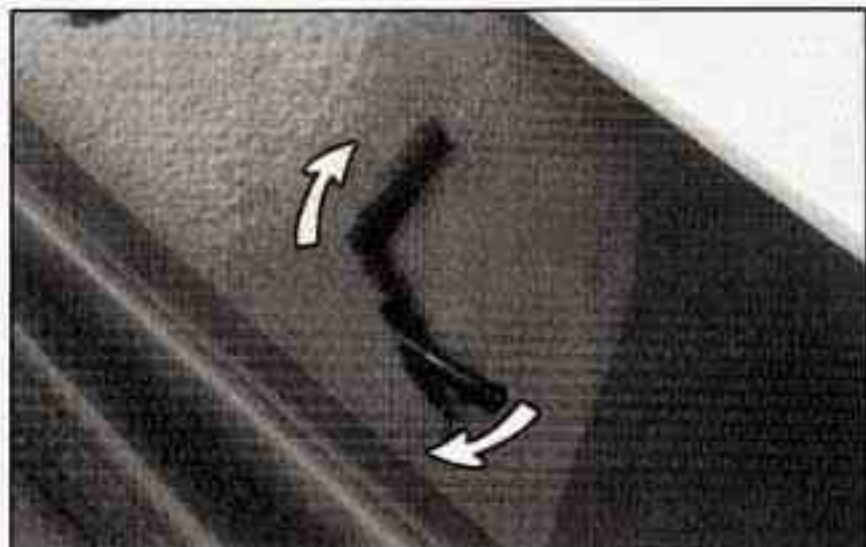

4. Gently lower the roof panel onto the carpet ledge. Then, pull each release rearward and upward to place the storage pins into the holes of the roof panel.

5. Gently lift and lower the roof panel to be sure it is locked into place.

Installing the Roof Panel

CAUTION:

An improperly attached roof panel may fall into or fly off the vehicle. You or others could be injured. After installing the roof panel, always check that it is firmly attached by pushing up on the underside of the panel. Check now and then to be sure the roof panel is firmly in place.

NOTICE:

To avoid damage to the roof panel, paint and weatherstripping, do not drop or rest it on its edges.

1. Check to be sure that the front handles and rear latch on the ceiling are in their opened positions before attempting to install the roof panel.
2. If the roof panel is stored in the rear area, grasp it with your right hand at the middle edge near the seatbacks, and with your left hand at the middle of the edge closest to you. Reverse the steps described previously under "Storing the Roof Panel."
3. Remove the roof panel from the storage compartment.
4. In most cases, it is easier to install the removable roof with two people rather than one. Place the roof panel over the vehicle.



6. Rotate the front handles toward the side doors to the closed position.
7. Hook the rear latch by pushing the lever up to the locked position.
8. Grasp and tug the roof panel up and down and side-to-side to make sure the roof panel is securely installed.

5. Position the rear edge of the roof panel to the weatherstrip on the back of the roof opening (A). Then align the pins at the rear of the roof panel weatherstrip with the receiving cup in the body weatherstrip (B). Gently lower the front edge of the roof panel to the front of the body opening (C).

Convertible Top (Option)

The following procedures explain the proper operation of your convertible top.

NOTICE:

Certain automatic car washes may cause damage to your vehicle. The top fabric can be damaged by top cleaning brushes.

For care and cleaning of your convertible top, see "Cleaning Your Convertible Top" in the index.

When lowering and raising the convertible top, you will use the following:

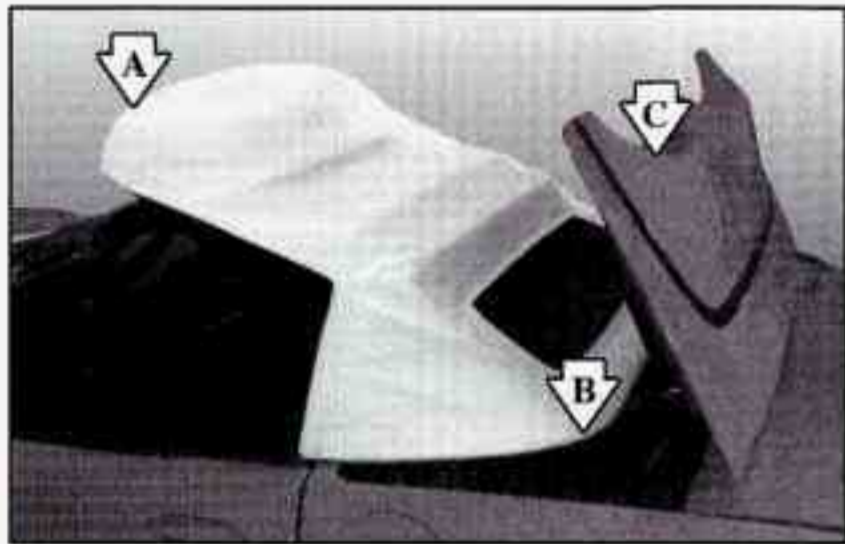

- A. Front Edge of the Convertible Top
- B. Rear Edge of the Convertible Top
- C. Storage Compartment Lid

Lowering Your Convertible Top

NOTICE:

Don't leave your convertible out with the top down for any long periods of time. The sun and rain can damage your seat material and other things inside your vehicle.

1. Set the parking brake firmly. Shift an automatic transmission into PARK (P). Shift a manual transmission into REVERSE (R). Turn the ignition key to OFF. Lower both sunshades and rotate them toward the door glass.

NOTICE:

Before lowering the convertible top into the storage area, be sure there are no objects in the way of the folded, stored top. The weight of a stored top on items in the storage area may cause the convertible top back glass to break.



2. Unlock the front of the convertible top by lowering the latch handles and turning them inward. Push the latch handles back to the up position.

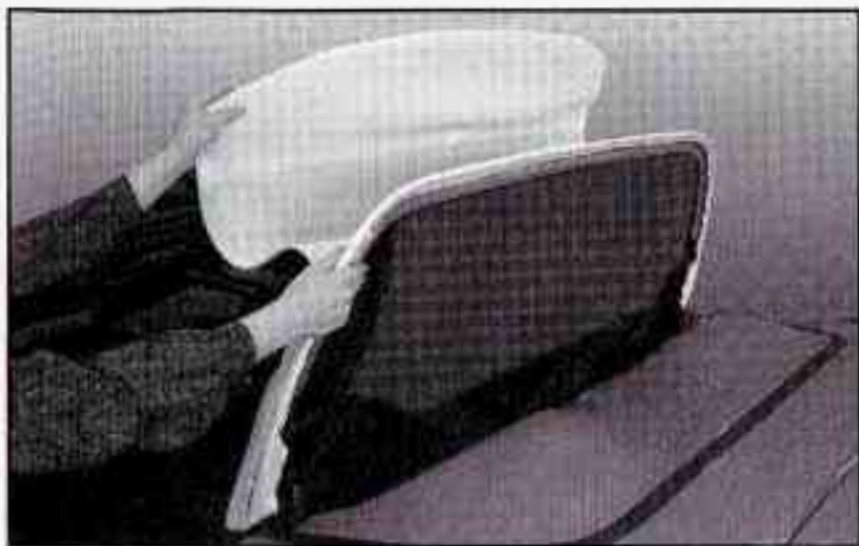

3. Lift upward on the front edge (A) of the convertible top off of the windshield frame. Then lift upward on the rear edge (B) of the convertible top to be vertical off the storage compartment lid (C). The front edge (A) and rear edge (B) should be straight up and down.



4. Tilt the driver's seatback forward and press the storage compartment release button located on the underside of the storage compartment lid (C) behind the driver's seat. Then raise the storage compartment lid (C). While attempting to raise the lid, if the lid does not release and you hear three chimes, check to make sure the trunk lid is closed. Also, the lid will not release if the alarm is turned on or the trunk lid is open.

After pressing the release button, the driver and passenger door glass should retract to the full-down position.

If your vehicle has lost battery power, you can still open the storage compartment lid (C) using the manual release cable.

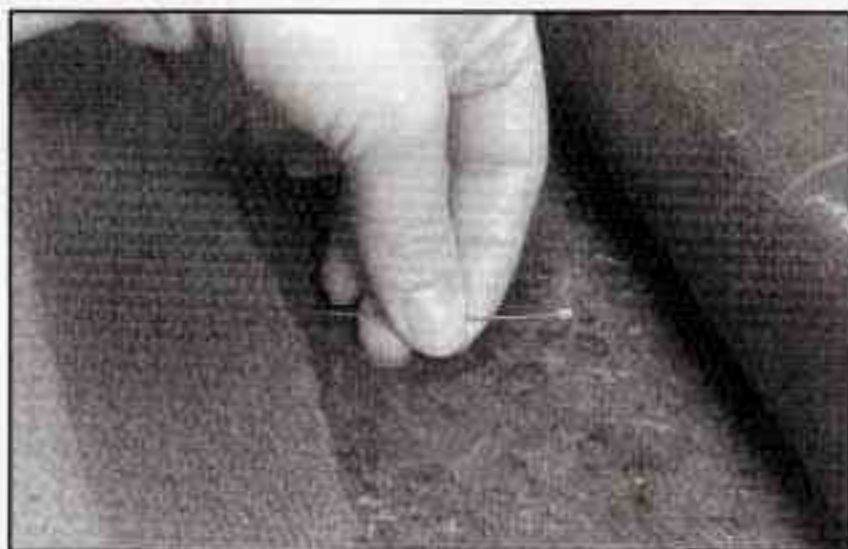

The cable is located underneath the carpeting behind the driver and passenger seats in the center of the vehicle. When using the manual release, you must first open the doors to prevent damage to the seals. To access the cable, lift and pull back the carpeting. Then pull the cable to release the storage compartment lid if needed.

NOTICE:

Be sure that the rear edge (B) of the convertible top is in the full-down position before lowering the top into the storage compartment or damage to the top may occur.

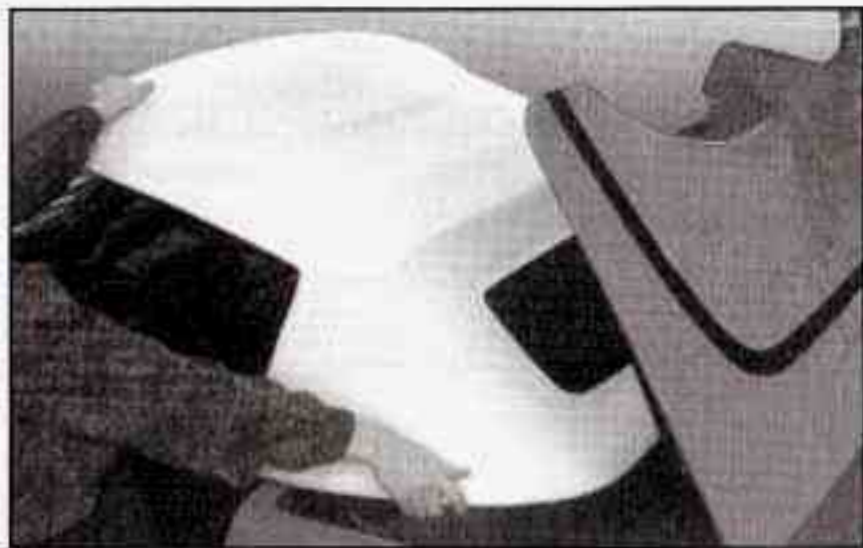

5. Push forward on the front edge (A) of the convertible top to allow the rear edge (B) of the convertible top to be rotated to its full-down position.



Raising Your Convertible Top

1. Park on a level surface, set the parking brake firmly and shift an automatic transmission into PARK (P). Shift a manual transmission into REVERSE (R). Lower both windows and sunshades and turn the ignition key to OFF.



6. Then move the top rearward to its fully-stored position.
7. After the top is stored, apply one even push on the center of the front edge (A) of the convertible top to assure the top is fully retracted.
8. Close the storage compartment lid (C) by closing with a swift firm motion.

2. Tilt the driver's seat forward and press the storage compartment release button, or use the manual release cable if battery power has been lost. Lift the storage compartment lid (C). (After pressing the release button, the driver and passenger door glass should retract to the full-down position, if they have not already been lowered.)

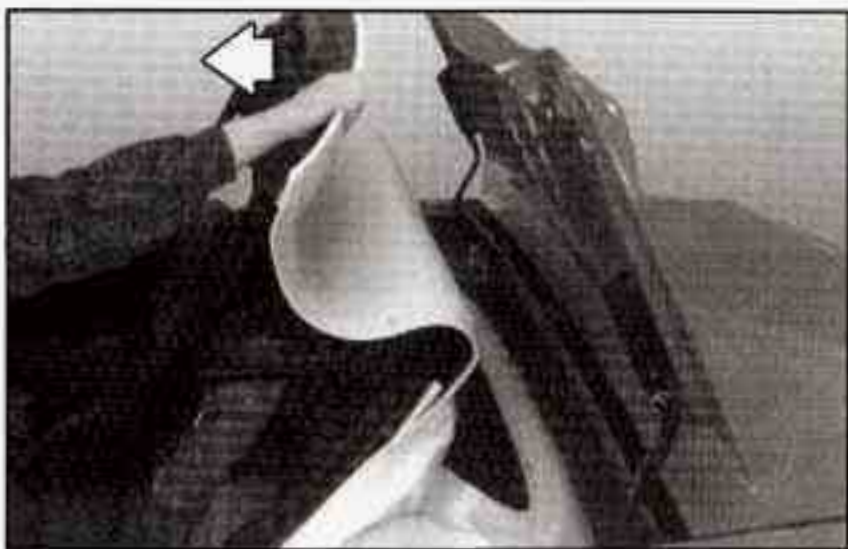

3. Pull the top up by firmly gripping the front edge (A) of the convertible top with your hand and applying a brisk firm upward and forward motion to get the top in the full-up position.



4. Lift the rear edge (B) of the convertible top to its full-up position by first raising the front edge (A).
5. Close the storage compartment lid (C) by closing with a swift, firm motion.
6. Lower the rear edge (B) of the convertible top by first slightly pushing the front edge (A) of the convertible top forward.
7. Push the front edge (A) of the convertible top down from the outside of the vehicle, or pull the front edge (A) of the convertible top down from the center pull-down handle located in the inside of the vehicle. Rotate the latches outward to secure the top in the up position.

Instrument Panel

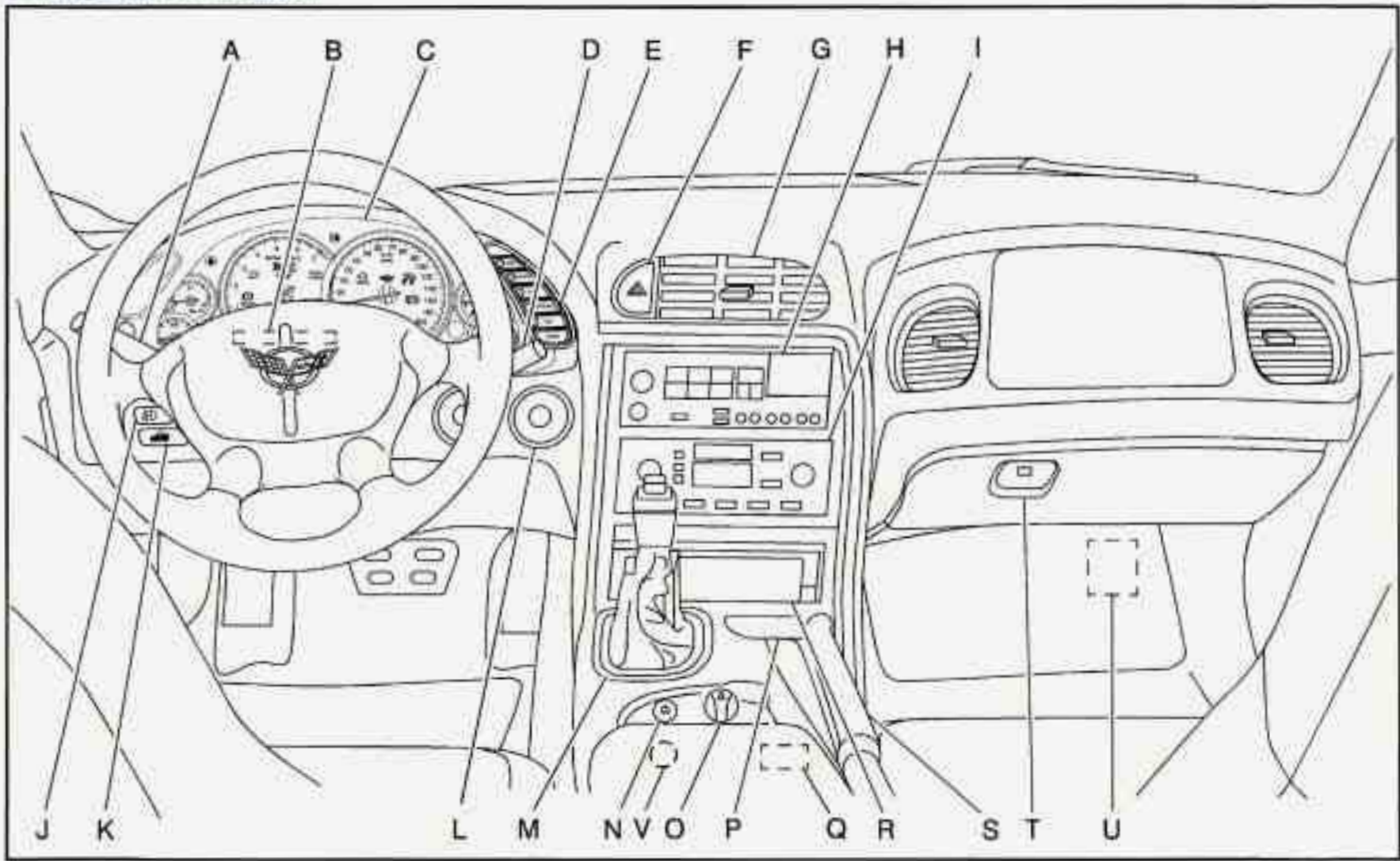

- A. Turn Signal/Multifunction Lever
- B. Driver Information Center (DIC)
- C. Instrument Panel Cluster
- D. Windshield Wiper/Washer Lever
- E. DIC Buttons
- F. Hazard Warning Flasher Button
- G. Center Air Vent
- H. Audio System
- I. Comfort Controls
- J. Fog Lamp Button (Option)
- K. Remote Hatch Release Button (Coupe) or Remote Trunk Release Button (Convertible)
- L. Ignition Switch
- M. Shift Lever (Automatic Shown)
- N. Traction Control System (TCS) Switch
- O. Selective Real Time Damping (Option)
- P. Instrument Panel Cupholder
- Q. Remote Fuel Door Release Button
- R. Ashtray & Cigarette Lighter
- S. Parking Brake
- T. Glove Box
- U. Instrument Panel Fuse Block
- V. Power Accessory Outlet

Instrument Panel Cluster

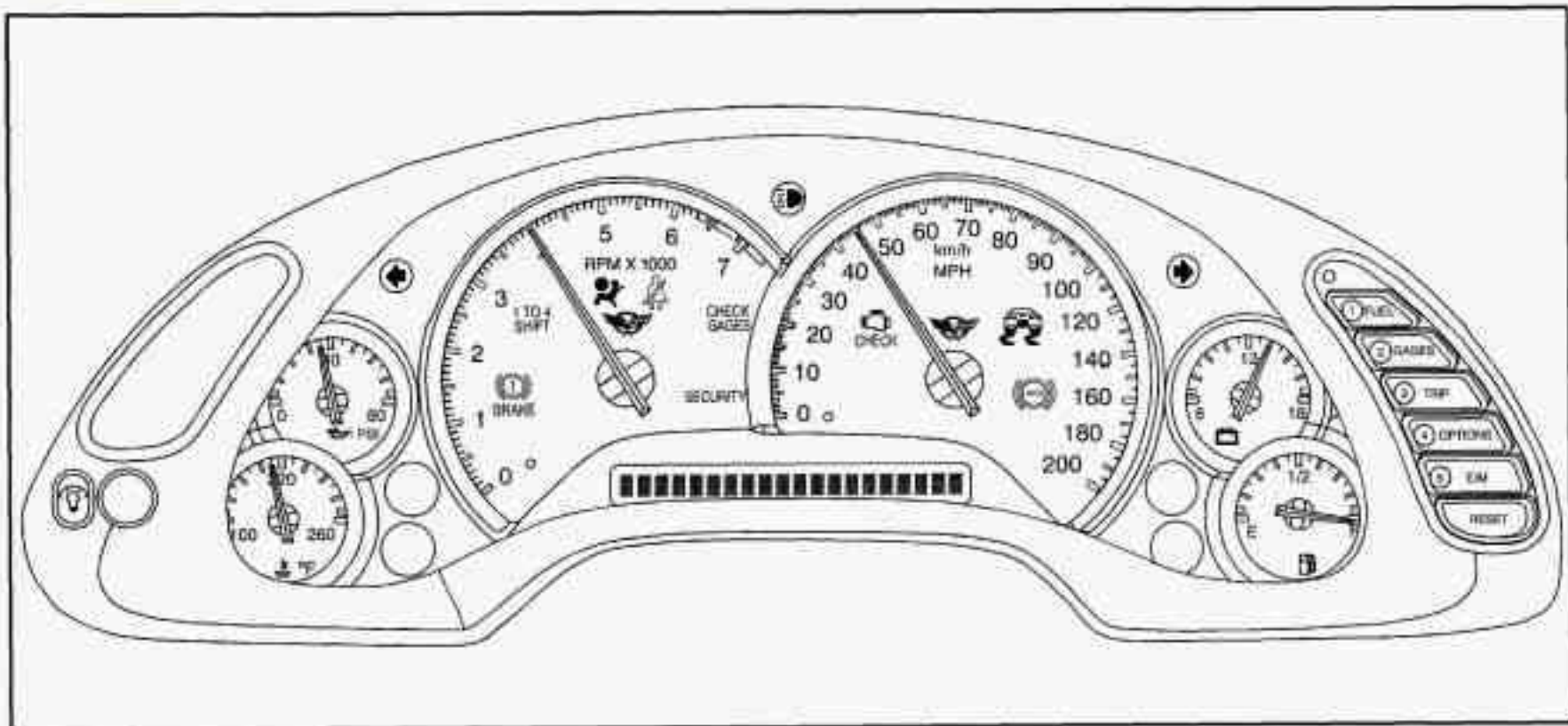

Your instrument cluster and Driver Information Center (DIC) are designed to let you know at a glance how your vehicle is running. You'll know how fast you're going, about how much fuel you have left and many other things you'll need to know to drive safely and economically.

Speedometer

Your speedometer lets you see your speed in either miles per hour (mph) or kilometers per hour (km/h).

You may note that there are **not** two separate scales for mph and km/h. When you press the E/M (English/Metric) button on the Driver Information Center (DIC), the cluster will calculate the proper speed and move the needle to the correct position. Either the MPH or the km/h telltale will illuminate, depending on which measurement you choose.

Tachometer

The tachometer displays the engine speed in thousands of revolutions per minute (rpm).

Fuel will shut off at about 6200 rpm.

If you continue to drive your vehicle at the fuel shut off rpm, you could damage your engine. Be sure to operate your vehicle below the fuel shut off rpm or reduce your rpm quickly when the fuel shuts off.

Warning Lights, Gages and Messages

This part describes the warning lights and gages that may be on your vehicle. The pictures will help you locate them.

Warning lights and gages can signal that something is wrong before it becomes serious enough to cause an expensive repair or replacement. Paying attention to your warning lights and gages could also save you or others from injury.

Warning lights come on when there may be or is a problem with one of your vehicle's functions. As you will see in the details on the next few pages, some warning lights come on briefly when you start the engine just to let you know they're working. If you are familiar with this section, you should not be alarmed when this happens.

Gages can indicate when there may be or is a problem with one of your vehicle's functions. Often gages and warning lights work together to let you know when there's a problem with your vehicle.

When one of the warning lights comes on and stays on when you are driving, or when one of the gages shows there may be a problem, check the section that tells you what to do about it. Please follow this manual's advice. Waiting to do repairs can be costly -- and even dangerous. So please get to know your warning lights and gages. They're a big help.

Your vehicle also has a Driver Information Center that works along with the warning lights and gages. See "Driver Information Center" in the Index.

Safety Belt Reminder Light

When the key is turned to ON or START, a chime will come on for about eight seconds to remind people to fasten their safety belts, unless the driver's safety belt is already buckled.



The safety belt light will also come on and stay on until the driver's belt is buckled.

Air Bag Readiness Light

There is an air bag readiness light on the instrument panel, which shows a deployed air bag symbol. The system checks the air bag's electrical system for malfunctions. The light tells you if there is an electrical problem. The system check includes the air bag sensors, the air bag modules, the wiring and the diagnostic module. For more information on the air bag system, see "Air Bag" in the Index.



This light will come on when you start your engine, and it will flash for a few seconds. Then the light should go out. This means the system is ready.

If the air bag readiness light stays on after you start the engine or comes on when you are driving, your air bag system may not work properly. Have your vehicle serviced right away.

The air bag readiness light should flash for a few seconds when you turn the ignition key to ON. If the light doesn't come on then, have it fixed so it will be ready to warn you if there is a problem.

Voltmeter

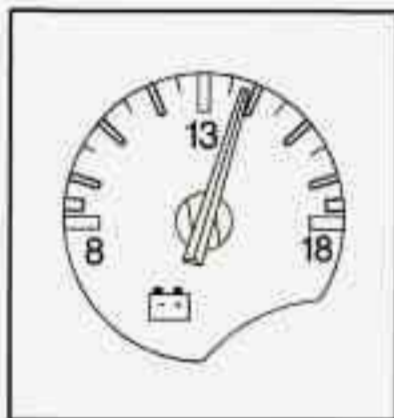

When the key is in the ON position with the engine not running, the voltmeter shows the voltage output of your battery. When the engine is running, it shows the voltage output of the charging system.

The reading will change as the rate of charge changes (with engine speed, for example), but if the voltmeter reads at 9 volts or below, your instrument panel and other systems may shut down. The Driver Information Center (DIC) will read **LOW VOLTAGE** when your vehicle is at 10 volts or below. Have it checked right away. Driving with the voltmeter reading at 10 volts or below could drain your battery and disable your vehicle.

Brake System Warning Light

Your vehicle's hydraulic brake system is divided into two parts. If one part isn't working, the other part can still work and stop you. For good braking, though, you need both parts working well.



This light should come on when you turn the ignition key to **START**. If it doesn't come on then, have it fixed so it will be ready to warn you if there's a problem.

If this warning light stays on after you start the engine, the parking brake may not be set or there could be a brake problem. Refer to "Parking Brake" in the Index to see if it is set. If the parking brake is not set, have your brake system inspected right away.

If the light comes on while you are driving and you have a **LOW BRAKE FLUID** message showing on the DIC, pull off the road and stop carefully. You may notice that the pedal is harder to push. Or, the pedal may go closer to the floor. It may take longer to stop. If the light is still on, have the vehicle towed for service. (See “Towing Your Vehicle” in the Index.)

 **CAUTION:**

Your brake system may not be working properly if the brake warning light is on. Driving with the brake warning light on can lead to an accident. If the light is still on after you've pulled off the road and stopped carefully, have the vehicle towed for service.

Anti-Lock Brake System Warning Light

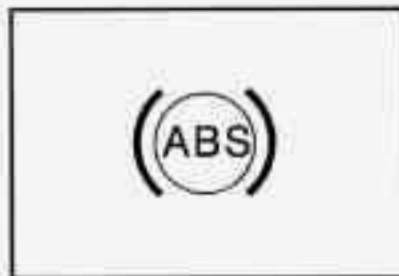

With the anti-lock brake system, the light will come on when you start your engine and may stay on for several seconds. That's normal.

If the light stays on, turn the ignition to OFF. Or, if the light comes on when you're driving, stop as soon as possible and turn the ignition off. Then start the engine again to reset the system. If the light still stays on, or comes on again while you're driving, your vehicle needs service. If the regular brake system warning light isn't on, you still have brakes, but you don't have anti-lock brakes. If the regular brake system warning light is also on, you don't have anti-lock brakes and there's a problem with your regular brakes. See “Brake System Warning Light” earlier in this section.

The anti-lock brake system warning light should come on briefly when you turn the ignition key to ON. If the light doesn't come on then, have it fixed so it will be ready to warn you if there is a problem.

Traction Control System (TCS) Light

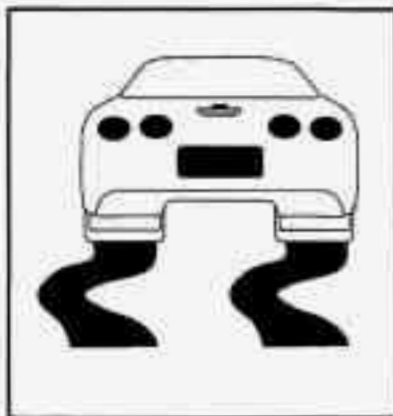

This light should come on briefly as you start the engine. If the light doesn't come on then, have it fixed so it will be ready to warn you if there's a problem.

If it stays on, or comes on and the DIC shows a **SERVICE TRACTION SYSTEM** message when you're driving, there's a problem with your TCS system and your vehicle needs service. When this light is on, the system will not limit wheel spin. Adjust your driving accordingly. If the driver turns off the Traction Control System by pressing the button on the console, the TCS system light will come on and the **TRACTION SYSTEM OFF** message will show on the DIC.

Engine Coolant Temperature Gage



This gage shows the engine coolant temperature. If the gage pointer moves into the shaded area, your engine is too hot!

This means that your engine coolant has overheated. If you have been operating your vehicle under normal driving conditions, you should pull off the road, stop your vehicle and turn off the engine as soon as possible. (The larger tick marks are in increments of 30 ° below 220°F (104°C) and in increments of 10 ° above 220 °F (104°C).)

In "Problems on the Road," this manual shows what to do. See "Engine Overheating" in the Index.

Malfunction Indicator Lamp (Check Engine Light)



Your vehicle is equipped with a computer which monitors operation of the fuel, ignition and emission control systems.

This system is called OBD II (On-Board Diagnostics-Second Generation) and is intended to assure that emissions are at acceptable levels for the life of the vehicle, helping to produce a cleaner environment. The CHECK ENGINE light comes on to indicate that there is a problem and service is required. Malfunctions often will be indicated by the system before any problem is apparent. This may prevent more serious damage to your vehicle. This system is also designed to assist your service technician in correctly diagnosing any malfunction.

NOTICE:

If you keep driving your vehicle with this light on, after a while, your emission controls may not work as well, your fuel economy may not be as good and your engine may not run as smoothly. This could lead to costly repairs that may not be covered by your warranty.

This light should come on, as a check to show you it is working, when the ignition is on and the engine is not running. If the light doesn't come on, have it repaired. This light will also come on during a malfunction in one of two ways:

- **Light Flashing** -- A misfire condition has been detected. A misfire increases vehicle emissions and may damage the emission control system on your vehicle. Dealer or qualified service center diagnosis and service may be required.
- **Light On Steady** -- An emission control system malfunction has been detected on your vehicle. Dealer or qualified service center diagnosis and service may be required.

If the Light Is Flashing

The following may prevent more serious damage to your vehicle:

- Reducing vehicle speed.
- Avoiding hard accelerations.
- Avoiding steep uphill grades.

If the light stops flashing and remains on steady, see “If the Light Is On Steady” following.

If the light continues to flash, when it is safe to do so, *stop the vehicle*. Find a safe place to park your vehicle. Turn the key off, wait at least 10 seconds and restart the engine. If the light remains on steady, see “If the Light Is On Steady” following. If the light is still flashing, follow the previous steps, and drive the vehicle to your dealer or qualified service center for service.

If the Light Is On Steady

You may be able to correct the emission system malfunction by considering the following:

Did you just drive through a deep puddle of water?

If so, your electrical system may be wet. The condition will usually be corrected when the electrical system dries out. A few driving trips should turn the light off.

Have you recently changed brands of fuel?

If so, be sure to fuel your vehicle with quality fuel (see “Fuel” in the Index). Poor fuel quality will cause your engine not to run as efficiently as designed. You may notice this as stalling after start-up, stalling when you put the vehicle into gear, misfiring, hesitation on acceleration or stumbling on acceleration. (These conditions may go away once the engine is warmed up.) This will be detected by the system and cause the light to turn on.

If you experience one or more of these conditions, change the fuel brand you use. It will require at least one full tank of the proper fuel to turn the light off.

If none of the above steps have made the light turn off, have your dealer or qualified service center check the vehicle. Your dealer has the proper test equipment and diagnostic tools to fix any mechanical or electrical problems that may have developed.

Engine Oil Pressure Gage

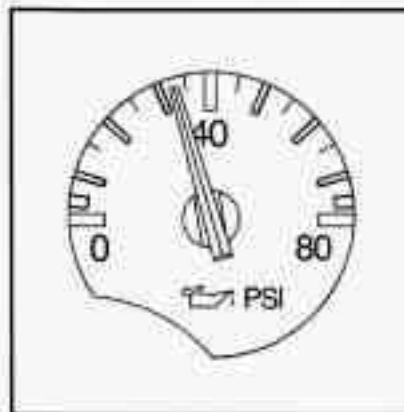

The engine oil pressure gage shows the engine oil pressure in psi (pounds per square inch) or kPa (kilopascals) when the engine is running.

Oil pressure should be 20 to 80 psi (140 to 550 kPa). (In certain situations such as long, extended idles on hot days, it could read as low as 6 psi (40 kPa) and still be considered normal.) It may vary with engine speed, outside temperature and oil viscosity, but readings above the shaded area show the normal operating range. Readings in the shaded area tell you that the engine is low on oil, or that you might have some other oil problem. See "Engine Oil" in the Index.

The engine oil pressure can also be displayed using the GAGES button on the Driver Information Center (DIC). See "Driver Information Center" in the Index.

CAUTION:

Don't keep driving if the oil pressure is low. If you do, your engine can become so hot that it catches fire. You or others could be burned. Check your oil as soon as possible and have your vehicle serviced.

NOTICE:

Damage to your engine from neglected oil problems can be costly and is not covered by your warranty.

Check Gages Light

**CHECK
GAGES**

This light will come on briefly when you are starting the engine. If the light comes on and stays on while you are driving, check your gages to see if they are in the warning areas.

This light can come on for the following reasons:

- Low Oil Pressure
- High Coolant Temperature
- High or Low Battery Voltage
- Low Fuel Level

Security Light

SECURITY

This light comes on to remind you to arm your theft-deterrent system. If it comes on and stays on when your ignition is on, there may be a problem with your theft-deterrent system.

See "Universal Theft-Deterrent" and "PASS-Key System" in the Index.

Fuel Gage

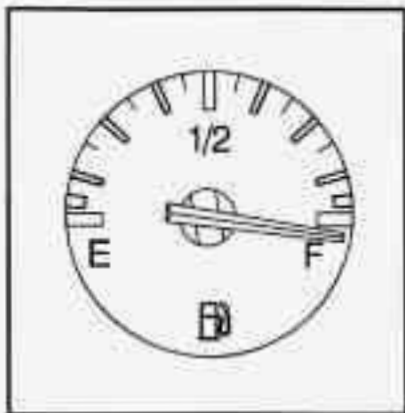

Your fuel gage shows about how much fuel is in your tank.

When the needle approaches the red zone, **RESERVE FUEL** will appear on the Driver Information Center (DIC) display. When the needle approaches the "E", **LOW FUEL** will appear on the display.

Press **RESET** to let the vehicle know that you have acknowledged a DIC message(s). Pressing **RESET** will also turn off a DIC message but the **LOW FUEL** message will come on again in 10 minutes if you have not added fuel to the vehicle.

Here are three concerns some owners have had about the fuel gage. All these situations are normal and do not indicate that anything is wrong with the fuel gage.

- At the gas station, the fuel pump shuts off before the gage reads **FULL (F)**.
- It takes more (or less) fuel to fill up than the gage reads. For example, the gage reads half full, but it took more (or less) than half of the tank's capacity to fill it.
- The gage moves a little when you turn, stop or speed up.

You can use the DIC to display more detailed fuel information. Each time you press **FUEL**, one of the following will appear in the DIC.

- **AVERAGE:** The fuel economy calculated for the current tank of fuel, or since you last reset the display.
- **INST:** The fuel economy calculated for your current driving conditions.
- **RANGE:** The distance you can drive before refueling.
- **BLANK:** The fuel gage is displayed alone.

You should reset the fuel information display every time you refuel. To reset the display, press **FUEL** until **AVERAGE** appears. Then, press **RESET** on the DIC.

Driver Information Center (DIC)

The Driver Information Center (DIC) will display information about how your vehicle is functioning, as well as warning messages if a system problem is detected. The DIC display area is located in the instrument cluster below the speedometer and tachometer, directly above the steering column.

The following buttons are on the DIC control panel which is located to the right of the cluster:

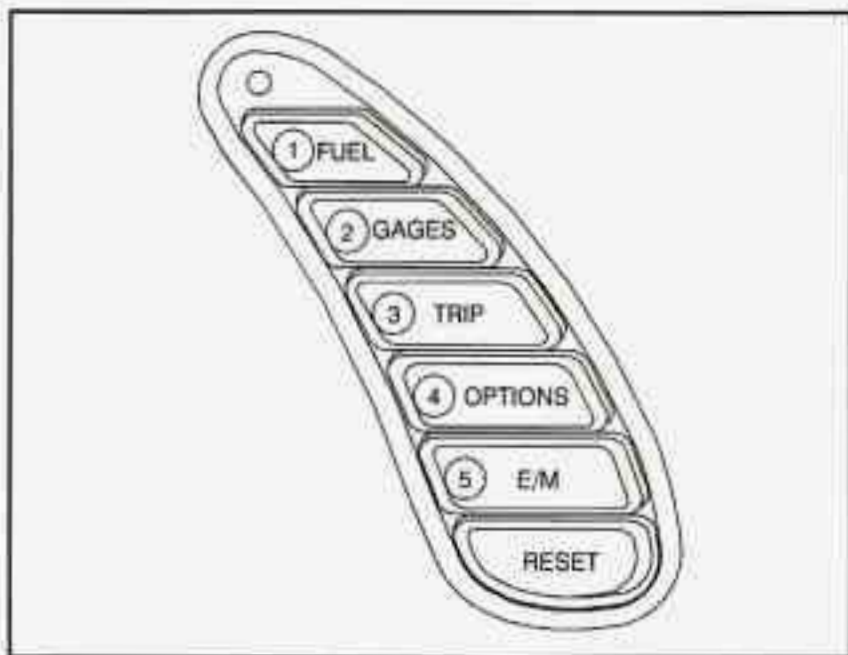

1 FUEL: Press this button to display fuel information such as fuel economy and range.

2 GAGES: Use this button to display gage information like oil pressure and temperature, coolant temperature, transmission fluid temperature, battery voltage and front/rear tire pressures.

3 TRIP: Use this button to display your total and trip miles, the elapsed time function, your average speed and the oil life.

4 OPTIONS: This button allows you to choose personal options available with your vehicle such as security, door locks, easy entry seats and language.

5 E/M: Use this button to change the display between English and metric units.

RESET: This button, used along with the other buttons, will reset system functions and turn off or acknowledge messages on the DIC.

At the top of the DIC control buttons is a light sensor. Be sure not to block the sensor or your lighting functions may be disrupted.

DIC Controls and Displays

Turn on the system by turning the ignition to ON. When you turn on the ignition, the DIC will be in the mode last displayed when the engine was turned off. Each DIC button allows you to scroll through a menu. A blank page ends each menu.

If a problem is detected, a diagnostic message will appear on the display. Press RESET to acknowledge any current warning or service messages. The following pages will show the messages you can see on the DIC display by pressing the DIC buttons.

1 FUEL

The FUEL button displays average fuel economy and instantaneous fuel economy calculated for your specific driving conditions and range.

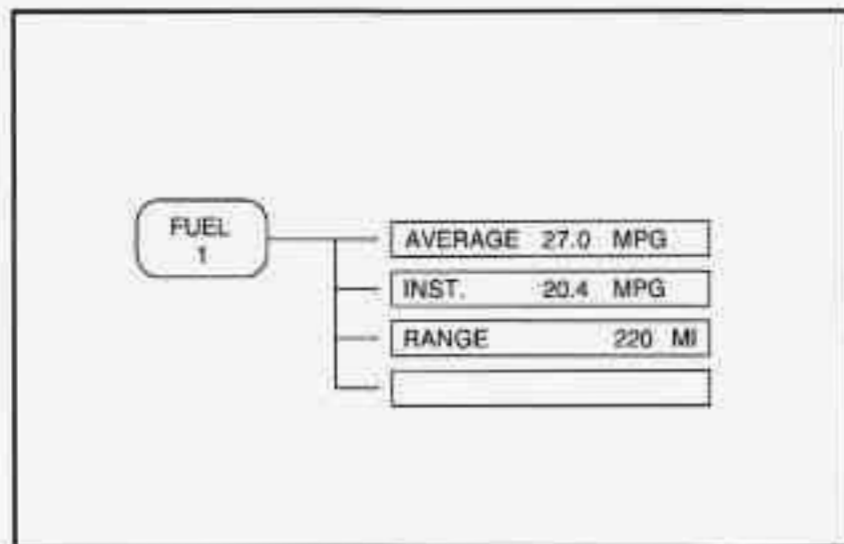

Press the FUEL button to display average fuel economy, such as:

- AVERAGE 20.1 MPG or
- AVERAGE 5.3 L/100 km

The average fuel economy is viewed as a long-term approximation of your overall driving conditions. If you press RESET in this mode while you're driving, the system will begin figuring fuel economy from that point in time.

Press FUEL again to display instantaneous fuel economy, such as:

- INST. 20.1 MPG or
- INST. 5.3 L/100 km

Press FUEL again to display the range, such as:

- RANGE 20 MI or
- RANGE 32 km

The range calculates the remaining distance you can drive without refueling. It's based on fuel economy and the fuel remaining in the tank.

If the range is lower than 30 miles (48 km), the display will read RANGE LOW.

The fuel economy data used to determine fuel range is an average of recent driving conditions. As your driving conditions change, this data is gradually updated. Resetting the fuel range causes the fuel economy data to be updated immediately. Press RESET to reset the fuel range.

2 GAGES

The GAGES button allows you to scroll through the functions listed below when you press it.

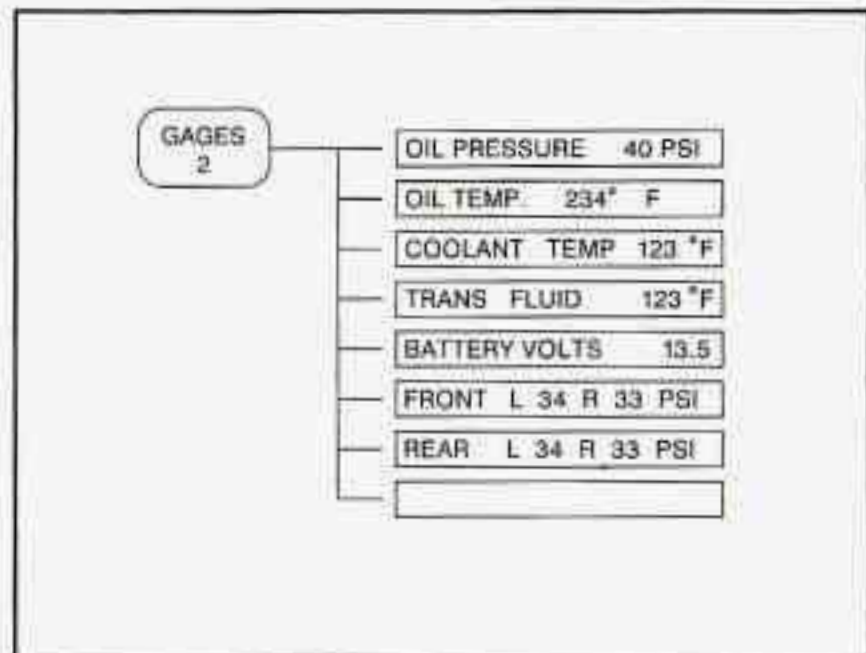

Press the GAGE button to display the oil pressure, such as:

- OIL PRESSURE 40 PSI or
- OIL PRESSURE 276 kPa

Press the GAGE button again to display the oil temperature, such as:

- OIL TEMP 234 ° F or
- OIL TEMP 112 ° C

Press the GAGE button again to display the coolant temperature, such as:

- COOLANT TEMP 123 ° F or
- COOLANT TEMP 51 ° C

Press the GAGE button again to display the transmission fluid temperature (automatics only), such as:

- TRANS FLUID 123 ° F or
- TRANS FLUID 51 ° C

Press the GAGE button again to display the battery voltage, such as:

- BATTERY 13.5 VOLTS

Press the GAGE button again to display the tire pressure for the front tires (left and right), such as:

- FRONT L34 R33 PSI or
- FRONT L 234 R228 kPa

Press the GAGE button again to display the tire pressure for the rear tires (left and right), such as:

- REAR L34 R33 PSI or
- REAR L234 R228 kPa

3 TRIP

The TRIP button allows you to scroll through the functions listed below when you press it.

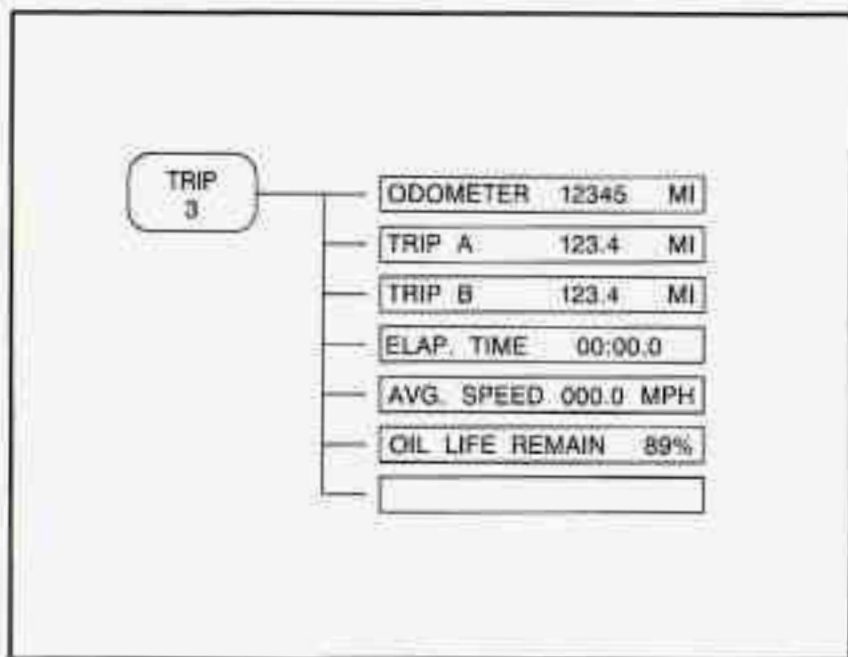

Odometer

The odometer shows how far your vehicle has been driven in either miles or kilometers. Press the TRIP button to display odometer readings such as:

- ODOMETER 12345 MI or
- ODOMETER 20008 km

Without the keys being in the ignition, you can also display the odometer by turning on the parking lamps.

Trip Odometers

There are two trip odometers. Press the TRIP button and TRIP A will be displayed. Press it again and TRIP B will be displayed. TRIP A could be used to track the distance to a destination. TRIP B could be used to track maintenance periods.

- TRIP A 130.5 MI or
- TRIP A 209.9 km
- TRIP B 300.5 MI or
- TRIP B 483.5 km

The trip odometers can be reset by pushing the RESET button on the DIC. Both of the trip odometers can be used simultaneously.

Miles Since Last Ignition Feature

You can also display number of miles driven since you last started the car if you press and hold the RESET button for two seconds, then release. The miles (or kilometers) since the last ignition cycle will be set into the trip odometer.

Elapsed Time

Press the TRIP button until ELAP. TIME is displayed, such as ELAP. TIME 00: 00 : 00.

When the ignition is in the ON position, the DIC can be used as a stopwatch. The display can show hours, minutes, seconds and hundredths of a second. The elapsed time indicator will record up to 99 hours, 59 minutes and 59 seconds, then it will reset to zero and continue counting. (Hundredths are shown up to 59 minutes, 59 seconds and 99 hundredths). The display appears as ELAP. TIME 00: 00 : 00 in the elapsed time function.

You can start or stop the elapsed time by pressing RESET. To reset the elapsed time to zero, stop the timer by pressing RESET. Then press and hold RESET for two seconds and release.

Average Speed

Press the TRIP button until the average speed is displayed, such as:

- AVERAGE SPEED 62 MPH or
- AVERAGE SPEED 100 km/h

Press reset in this mode to start calculating the average speed. Press and hold RESET to clear.

Engine Oil Life

Press the TRIP button until the engine oil life is displayed, such as OIL LIFE REMAIN 89%.

This is an estimate of the engine oil's remaining useful life. It will show 99% when the system is reset after an oil change. It will alert you to change your oil on a schedule consistent with your driving conditions.

When the remaining oil life is low, the system will alert you with the message CHANGE OIL SOON.

When the oil life is down to zero, you will receive the message CHANGE OIL NOW.

To reset the OIL LIFE reminder after an oil change:

1. With the ignition on, press the TRIP button so the OIL LIFE percentage is displayed.
2. Press RESET and hold for two seconds. The word RESET will appear, then OIL LIFE 99%.

Remember, you must reset the OIL LIFE yourself after each oil change. It will not reset itself. Also, be careful not to reset the OIL LIFE accidentally at any time other than when the oil has just been changed. It can't be reset accurately until the next oil change.

The DIC does not replace the need to maintain your vehicle as recommended in the Maintenance Schedule in this manual. Also, the oil change reminder will not detect dusty conditions or engine malfunctions that may affect the oil. If you drive in dusty areas, change your oil after every 3,000 miles (5 000 km) or three months, whichever occurs first, unless the DIC instructs you to do so sooner. Also, the oil change reminder does not measure how much oil you have in your engine, so be sure to check your oil level often. See "Engine Oil" in the Index.

4 OPTIONS

This button allows you to choose personal options available with your vehicle, such as security, door locks, easy entry seats and language. Some of these functions work along with the key fob transmitter.

When returning to the options menu, the first item of the options list will always be displayed, not the one you were last in when you changed buttons.

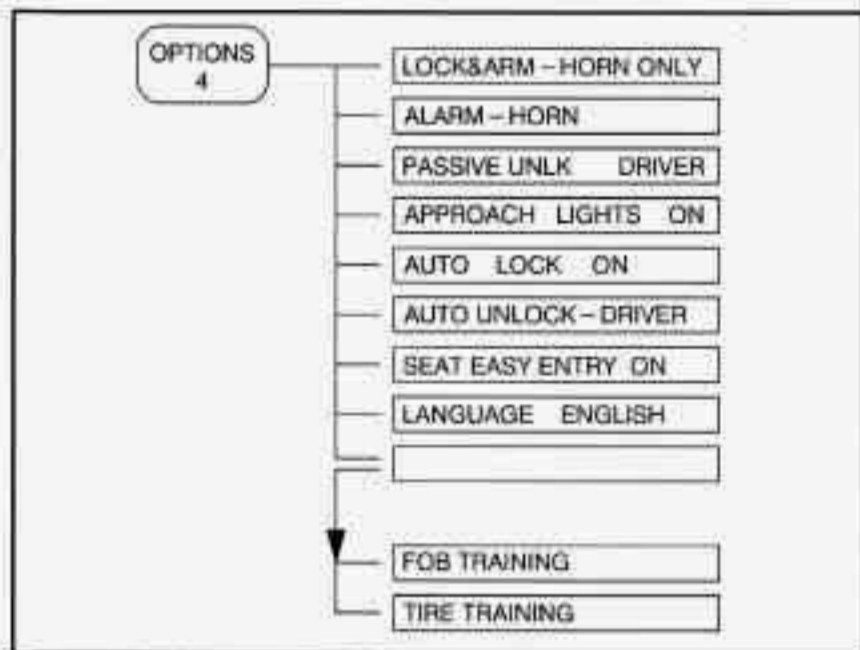

The following are the options listed under the OPTIONS button:

Lock and Arm

Press the OPTIONS button until LOCK & ARM appears on the display, then use the RESET button to page through the following selections:

- LOCK & ARM OFF
- LOCK & ARM HORN ONLY
- LOCK & ARM LIGHTS ONLY
- LOCK & ARM HORN & LTS

If you choose LOCK & ARM OFF, you will receive no security feedback when locking or unlocking your vehicle.

If you choose LOCK & ARM HORN ONLY, only the horn will chirp to let you know when your alarm system has armed when locking your vehicle.

If you choose LOCK & ARM LIGHTS, only your exterior lamps will flash to let you know when your alarm system has armed when locking your vehicle.

If you choose LOCK & ARM HORN & LTS, the horn will chirp and the exterior lamps will flash briefly to let you know the system has armed when locking your vehicle.

Alarm

Press the **OPTIONS** button until **ALARM** appears on the display, then use the **RESET** button to page through the following selections:

- **ALARM HORN**
- **ALARM HORN & LIGHTS**

If you choose **ALARM HORN**, the horn will sound during an alarm. If you choose **ALARM HORN & LIGHTS**, the horn will sound and the interior and exterior lamps will flash during an alarm.

Passive Unlock

Press the **OPTIONS** button until **PASSIVE UNLOCK** appears on the display, then use the **RESET** button to page through the following selections:

- **PASSIVE UNLOCK- DRIVER**
- **PASSIVE UNLOCK- BOTH**

If you choose the **PASSIVE UNLOCK- DRIVER**, only the driver's door lock will be programmed to passively unlock. The driver's door will passively unlock when you approach the vehicle with the key fob transmitter slider switch set to **ON**.

If you choose **PASSIVE UNLOCK- BOTH**, the driver and passenger's door locks will be programmed to passively unlock. The driver and passenger doors will passively unlock when you approach the vehicle with the key fob transmitter slider switch set to **ON**.

See "Remote Function Actuation (RFA) System" in the Index for more information.

Approach Lights

Press the **OPTIONS** button until **APPROACH LIGHTS** appears on the display, then use the **RESET** button to page through the following choices:

- **APPROACH LIGHTS ON**
- **APPROACH LIGHTS OFF**

If you choose **APPROACH LIGHTS ON**, the fog lamps, front turn signal, rear back-up and courtesy lamps will come on for 30 seconds as you approach the vehicle with the key fob transmitter. This will occur only when it is dark outside.

APPROACH LIGHTS OFF turns off this option.

See "Remote Function Actuation (RFA) System" in the Index for more information.

Auto Lock

Press the **OPTIONS** button until **AUTO LOCK** appears on the display, then use the **RESET** button to page through the following choices:

- **AUTO LOCK ON**
- **AUTO LOCK OFF**

If you choose **AUTO LOCK ON**, both doors will automatically lock when the vehicle exceeds 10 mph (16 km/h) in a manual transmission. In a vehicle with an automatic transmission, both doors will automatically lock when you move the shifter out of **PARK (P)**.

Choose **AUTO LOCK OFF** to turn this option off.

Auto Unlock

The **AUTO UNLOCK** will be available only if **AUTO LOCK** is set to **ON**.

Press the **OPTIONS** button until **AUTO UNLOCK** appears on the display, then use the **RESET** button to page through the following choices:

- **AUTO UNLOCK - DRIVER**
- **AUTO UNLOCK - BOTH**
- **AUTO UNLOCK OFF**

If you choose **AUTO UNLOCK - DRIVER**, the driver's door will automatically unlock when you turn the vehicle off and pull the key out of the ignition.

Choose **AUTO UNLOCK - BOTH**, and both doors will automatically unlock when you turn the vehicle off and pull the key out of the ignition.

AUTO UNLOCK OFF turns off this option.

Easy Entry

The easy entry feature will only be available if the vehicle is equipped with the memory option.

Press the **OPTIONS** button until **SEAT EASY ENTRY** appears on the display, then use the **RESET** button to page through the following choices:

- **SEAT EASY ENTRY ON**
- **SEAT EASY ENTRY OFF**

If you choose **SEAT EASY ENTRY ON**, when you turn the ignition off and remove the key, the seat will automatically move back for an easy exit or an easy entrance when returning to the vehicle.

SEAT EASY ENTRY OFF turns off this option.

Languages

You can select which language the DIC will display its messages in. Press the **OPTIONS** button until the word **LANGUAGES** appears on the display, then use the **RESET** button to page through the following choices:

- LANGUAGE ENGLISH
- LANGUAGE FRENCH
- LANGUAGE GERMAN
- LANGUAGE SPANISH

Blank Page

There is a blank page at the end of the **OPTIONS** menu. When the blank page is displayed, you can access the following items:

FOB TRAINING: This option allows you to match the RFA transmitter(s) to your vehicle. You can access this option by pressing and holding **RESET** for two seconds while you are on the blank page at the end of the **OPTIONS** menu. The message **FOB TRAINING** will be displayed. See “Matching Transmitter(s) To Your Vehicle” in the Index.

TIRE TRAINING: The Tire Pressure Monitor (TPM) operates with battery-powered sensors that are located inside the valve stems on each tire. Each sensor has a unique ID code so the vehicle knows the tire location of the sensor. When the vehicle reaches a speed of greater than 15 mph (24 km/h), the sensors begin to send the tire pressure readings to a receiver inside the vehicle. These readings are displayed when using the **GAGES** button on the DIC. If you are unable to display your tire pressures while the vehicle speed is greater than 15 mph (24 km/h), you may need to have your sensor ID codes learned by the vehicle. See your dealer.

DIC Warnings and Messages

The following messages and warnings may appear in the DIC display. The DIC display area is located in the instrument cluster below the speedometer and tachometer, directly above the steering column. You may receive more than one message at a time. Messages will appear one behind the other. To acknowledge a message and remove it from the display, press **RESET**. You may scroll through the messages that may have been sent at the same time. The message center is continuously updated with the vehicle performance status.

ABS ACTIVE (Anti-Lock Brake System Active) - : When your anti-lock system is adjusting brake pressure to help avoid a braking skid, the ABS ACTIVE message will be displayed.

Slippery road conditions may exist if this message is displayed, so adjust your driving accordingly. The message will stay on for a few seconds after the system stops adjusting brake pressure.

SERVICE ABS (Anti-Lock Brake System) - : If the SERVICE ABS message is displayed when you are driving, stop as soon as possible and turn the ignition off. Then start the engine again to reset the system. If the message stays on, or comes back on again while you are driving, your vehicle is in need of service. If the regular brake system warning light isn't on, you still have brakes, but don't have anti-lock brakes. If the regular brake system light is also on, you don't have anti-lock brakes and there is a problem with your brakes. See "Brake System Warning Light" earlier in this section.

If the SERVICE ABS message is being displayed, your traction control system and the optional active handling system will also be disabled. The driver information center will scroll three messages SERVICE ABS, SERVICE TRACTION SYS. and SERVICE ACTIVE HNDLG and the instrument cluster car icon will be

illuminated. The driver can acknowledge these messages by pressing the reset button three times. When the service message is displayed the computer controlled systems will not assist the driver and you should have the system repaired as soon as possible. Adjust your driving accordingly.

SERVICE COLUMN LOCK: The system that controls the locking and unlocking of the steering column may not work properly. Have the vehicle towed to a dealer for service.

LOW OIL PRESSURE: You will hear four chimes and the CHECK GAGES telltale will come on when this message is displayed. To acknowledge the warning, press the RESET button. After you press the RESET button, a message will be displayed and you will hear a chime every minute until the vehicle is serviced. If you do not press RESET, the message will remain on the digital display until the vehicle is serviced.

Low oil pressure may be the result of a combination of low oil level and abrupt changes in the vehicle's direction. When this warning is displayed, you should not operate the engine at high RPM or make fast abrupt moves. When convenient, you should check the oil level. See "Engine Oil" in the Index.

LOW OIL LEVEL: Press RESET to acknowledge that you have read the message and to remove it from the display. The message will reappear every 10 minutes until this condition changes.

You will hear two chimes when this message is displayed. If this message appears after starting your engine, your engine oil level may be too low. You may need to add oil. See "Engine Overheating" in the Index.

REDUCED ENGINE POWER: You will hear chimes continuously when this message is displayed. To acknowledge that you have read the message and to remove it from the display, press RESET. The message will reappear every 15 seconds until this condition changes.

If the Driver Information Center displays the REDUCED ENGINE POWER message and the CHECK ENGINE light comes on, a noticeable reduction in the vehicle's performance may occur. If the REDUCED ENGINE POWER message is displayed but there is no reduction in performance, proceed to your destination. The performance may be reduced the next time the vehicle is driven.

The vehicle may be driven at a reduced speed while the REDUCED ENGINE POWER message is displayed, but acceleration and speed may be reduced. Anytime the CHECK ENGINE light stays on, the vehicle should be taken to an authorized Chevrolet dealer as soon as possible for diagnosis and repair.

Also, refer to "Malfunction Indicator Lamp" (Check Engine Light) in the Index. If the REDUCED ENGINE POWER message is displayed in combination with the COOLANT OVER TEMP message, see "Engine Overheating" in the Index.

SERVICE VEHICLE SOON: If this message appears on the DIC, there may be an electrical or another system problem with your vehicle. Have your vehicle checked by your dealer if this message keeps appearing.

CHARGE SYSTEM FAULT: Press RESET to acknowledge that you have read the message and to remove it from the display. The message will reappear every 10 minutes until this condition changes. You will hear two chimes when this message is displayed.

If this message comes on while you are driving, you may have a problem with the electrical charging system. It could indicate that you have a loose or broken drive belt or another electrical problem. Have it checked right away. Driving while this light is on could drain your battery.

If you must drive a short distance with the message on, be certain to turn off your accessories, such as the radio and air conditioner.

TRACTION SYS ACTIVE - : When your traction control system is limiting wheel spin, the **TRACTION SYS ACTIVE** message will be displayed. Slippery road conditions may exist if this message is displayed, so adjust your driving accordingly. The message will stay on for a few seconds after the traction control system stops limiting wheel spin.

TRACTION SYSTEM-ON: This message is displayed when you decide to turn on the TCS by pressing the switch on the console. This message will shut off automatically on its own.

TRACTION SYSTEM-OFF: You will hear a single quick tone when this message is displayed. This message comes on and stays on when the TCS button on the console is pressed to turn the system off. To acknowledge this message, press **RESET**.

SERVICE TRACTION SYSTEM - : If the **SERVICE TRACTION SYS** message is displayed when you are driving, there is a problem with your Traction Control System and your vehicle is in need of service. When this message is displayed, the system will not limit wheel spin. Adjust your driving accordingly.

If you have the optional Active Handling System, the **SERVICE ACTIVE HNDLG** message will also be displayed and the instrument cluster car icon will also be illuminated. The driver can acknowledge both messages by pressing the reset button two times which will also turn off the instrument cluster icon. When the service messages are displayed, the computer controlled systems will not assist the driver in controlling the vehicle. Have the system repaired as soon as possible. Adjust your driving accordingly.

SERVICE RIDE CONTROL: This message is used to indicate to the driver that the Selective Real Time Damping (SRTD) system has detected a malfunction and that the system must be serviced. The **SERVICE RIDE CONTROL** message will always come on when a failure is detected by the Selective Real Time Damping system. If a fault is present in the SRTD which causes the shocks to be in their full soft condition, the **SERVICE RIDE CONTROL**, **SHOCKS INOPERATIVE** and **MAXIMUM 80 MPH (129 km/h)** will display together. You will never get a **SHOCKS INOPERATIVE** and **MAXIMUM SPEED 80 MPH (129 km/h)** message without a **SERVICE RIDE CONTROL** message.

SHOCKS INOPERATIVE: You will hear four chimes when this message is displayed. To acknowledge that you have read the message and to remove it from the display, press **RESET**. The message will reappear every 10 minutes until this condition changes.

This message indicates that a malfunction is present in the Selective Real Time Damping system which is causing the shocks to be in their full soft mode. This is a warning to the driver that the vehicle handling may be affected. Have your vehicle serviced as soon as possible.

MAXIMUM SPEED 80 MPH (129 km/h): You will hear four chimes when this message is displayed. To acknowledge the warning, press **RESET**. After you press **RESET**, a message will reappear every 10 minutes until this condition changes.

This message indicates that the vehicle speed will be limited to 80 mph (129 km/h) when the shock absorber system has failed and the shocks are in their full soft mode. Have your vehicle serviced as soon as possible.

LOW COOLANT: You will hear two chimes when this message is displayed. To acknowledge the warning, press **RESET**. After you press **RESET**, a message will reappear and you will hear a chime every 10 minutes until this condition changes.

This message indicates that the coolant in the system is low. You may need to add coolant. See "Engine Overheating" in the Index.

COOLANT OVER TEMP: You will hear four chimes and the **CHECK GAGES** telltale will come on when this message is displayed. To acknowledge the warning, press the **RESET** button. After you press the **RESET** button, a message will be displayed and you will hear a chime every minute until this condition changes. If you do not press **RESET**, the message will remain on the digital display until the condition changes.

If the engine coolant exceeds 255°F (124°C), this message is displayed. If you have been operating your vehicle under normal driving conditions, you should pull off from the road, stop your vehicle and turn off the engine as soon as possible. You can monitor the coolant temperature with the GAGES button on the DIC or the engine coolant gage on the instrument panel cluster. See "Engine Overheating" in the Index.

HIGH OIL TEMPERATURE REDUCE ENGINE RPM: You will hear four chimes when this message is displayed. To acknowledge the warning, press the RESET button. After you press the RESET button, a message will be displayed and you will hear a chime every minute until this condition changes. If you do not press RESET, the message will remain on the digital display until the condition changes.

If the engine oil temperature exceeds 320°F (160°C), this message is displayed. You should check the engine coolant temperature and engine oil level. If your engine is too hot, see "Engine Overheating" in the Index. Your vehicle may need service, so see your dealer. You can monitor the oil temperature with the GAGES button on the DIC.

HIGH TRANS TEMP: You will hear four chimes when this message is displayed. To acknowledge this warning, press the RESET button. After you press the RESET button, the message will be displayed every 10 minutes until the condition changes. If you do not press RESET, the message remains on the display until the condition changes.

If the transmission fluid temperature rises above 263°F (128°C) or rises rapidly, this message is displayed. The transmission may shift gears or apply the torque converter clutch to reduce the fluid temperature. Driving aggressively or driving on long hills can cause the transmission fluid temperature to be higher than normal. If this message appears, you may continue to drive at a slower speed. You should also monitor the transmission fluid temperature and allow it to cool to at least 230°F (110°C). The transmission fluid temperature can be monitored with the GAGES button on the DIC. See "Automatic Transmission Fluid" in the Index. You should also check the engine coolant temperature. If it is also hot, see "Engine Overheating" in the Index.

If the HIGH TRANS TEMP message is displayed during normal vehicle operation on flat roads, your vehicle may need service. See your dealer for an inspection.

LOW TIRE PRESSURE - (LF, LR, RF, RR): You will hear two chimes when this message is displayed. To acknowledge the warning, press RESET. After you press RESET, a message will reappear and you will hear a chime every 10 minutes until this condition changes. This message indicates that the pressure in one of your tires is less than 25 psi (172 kPa). Next to the LOW TIRE PRESSURE message, you can see either LF (left front), LR (left rear), RF (right front) or RR (right rear) to indicate to you which tire is low on pressure. You can receive more than one tire pressure message at a time. To read other messages that may have been sent at the same time, press RESET. If a tire pressure message appears on the DIC, stop as soon as you can. Have the tire pressures checked and set to those shown on your Tire Loading Information Label. See "Extended Mobility Tires" in the Index.



CAUTION:

When the LOW TIRE PRESSURE or FLAT TIRE message is displayed on the Driver Information Center, your vehicle's handling capabilities will be reduced during severe maneuvers. If you drive too fast, you could lose control of your vehicle. You or others could be injured. Don't drive over 55 mph (90 km/h) when the LOW TIRE PRESSURE or FLAT TIRE message is displayed. Drive cautiously, and check your tire pressures as soon as you can.

FLAT TIRE - (LF, LR, RF, RR): You will hear two chimes when this message is displayed followed by the message MAX SPEED 55 MPH (90 km/h). If this message appears, do not drive your vehicle above these limits. The next message to appear is REDUCED HANDLING. Adjust your driving accordingly. To acknowledge these warnings, press RESET. After you press RESET, a message will reappear and you will hear a chime every 10 minutes until this condition changes. This message indicates that the pressure in one of your tires is lower than 5 psi (34 kPa). Next to the FLAT TIRE message, you can see either LF (left front), LR (left rear), RF (right front) or RR (right rear) to indicate to you which tire is flat. You can receive more than one tire pressure message at a time. To read other messages that may have been sent at the same time, press RESET. If a tire pressure message appears on the DIC, stop as soon as you can. Have the tire pressures checked and set to those shown on your Tire Loading Information Label. See "Extended Mobility Tires" and "Tire Inflation" in the Index.



CAUTION:

When the LOW TIRE PRESSURE or FLAT TIRE message is displayed on the Driver Information Center, your vehicle's handling capabilities will be reduced during severe maneuvers. If you drive too fast, you could lose control of your vehicle. You or others could be injured. Don't drive over 55 mph (90 km/h) when the LOW TIRE PRESSURE or FLAT TIRE message is displayed. Drive cautiously, and check your tire pressures as soon as you can.

HIGH TIRE PRESSURE - (LF, LR, RF, RR): You will hear two chimes when this message is displayed. To acknowledge the warning, press RESET. After you press RESET, a message will reappear and you will hear a chime every 10 minutes until this condition changes. This message indicates that the pressure in one of your tires is higher than 42 psi (290 kPa). Next to the HIGH TIRE PRESSURE message, you can see either LF (left front), LR (left rear), RF (right front) or RR (right rear) to indicate to you which tire is higher than 42 psi (290 kPa). You can receive more than one tire pressure message at a time. To read other messages that may have been sent at the same time, press RESET. If a tire pressure message appears on the DIC, stop as soon as you can. Have the tire pressures checked and set to those shown on your Tire Loading Information Label. See “Extended Mobility Tires” and “Tire Inflation” in the Index.

SERVICE TIRE MON SYS: If this message comes on, a part on the Tire Pressure Monitor (TPM) is not working properly. If you drive your vehicle while any of the four sensors are missing or inoperable, the warning will come on in approximately 10 minutes. If all four sensors are missing, the warning will come on in approximately 15 to 20 minutes. (All the sensors would be missing, for example, if you put different wheels on your vehicle without transferring the sensors.) If the warning comes on and stays on, there may be a problem with the TPM. See your dealer.

Other Messages

Here are more messages that you can receive on your Driver Information Center. To acknowledge a message and read another message that may have come on at the same time, press the RESET button.

- BRAKE BEFORE SHIFT
(Automatic Transmissions Only)
- CHANGE OIL NOW
- CHANGE OIL SOON
- CRUISE DISENGAGED
- CRUISE SET __ MPH (__ km/h)
- DOOR AJAR
- ENGINE PROTECTION REDUCE ENGINE RPM
- HATCH AJAR (Coupe)
- TRUNK AJAR (Convertible)
- HIGH VOLTAGE
- LOW BRAKE FLUID (See "Brake Fluid" in the Index)
- LOW COOLANT (See "Engine Overheating" in the Index)
- LOW FUEL (fuel range is less than 50 miles (80 km))
- LOW VOLTAGE
- LOW WASHER FLUID
- PULL KEY - WAIT 10 SEC
- RESERVE FUEL
- UPSHIFT NOW



Section 3 Comfort Controls and Audio Systems

In this section, you'll find out how to operate the comfort control and audio systems offered with your vehicle. Be sure to read about the particular systems supplied with your vehicle.

- | | | | |
|------|---|------|--|
| 3-2 | Comfort Controls | 3-17 | AM-FM Stereo with Compact Disc Player and Automatic Tone Control (If Equipped) |
| 3-2 | Manual Comfort Controls | 3-21 | Trunk Mounted CD Changer |
| 3-4 | Automatic Electronic Dual Climate Control System (If Equipped) | 3-25 | Theft-Deterrent Feature |
| 3-9 | Sensors | 3-27 | Understanding Radio Reception |
| 3-10 | Air Conditioning | 3-27 | Tips About Your Audio System |
| 3-11 | Heating | 3-28 | Care of Your Cassette Tape Player |
| 3-11 | Defogging and Defrosting | 3-29 | Care of Your Compact Discs |
| 3-12 | Audio Systems | 3-29 | Care of Your Compact Disc Player |
| 3-12 | Setting the Clock for All Systems | 3-29 | Power Mast Antenna (Option) |
| 3-12 | AM-FM Stereo with Cassette Tape Player and Automatic Tone Control | 3-30 | Integrated Windshield and Rear Window Antennas (Option) |
| 3-17 | CD Adapter Kits | | |

Comfort Controls

This section tells you how to make your air system work for you. Your comfort control system uses ozone-friendly R-134a refrigerant.

With these systems, you can control the heating, cooling and ventilation in your vehicle. Your vehicle also has a flow-through ventilation system described later in this section.

Manual Comfort Controls



Fan Knob

The left knob is the fan knob and selects the force of air you want. Turn the knob to the right to increase fan speed and to the left to decrease fan speed. The fan must be turned on for the air conditioning compressor to operate.

Temperature Knob

The center knob controls the temperature of the air coming through the system. Turn it to the left (toward the blue area) for cooler air. Turn it to the right (toward the red area) for warmer air.

Mode Knob

The right knob selects the direction of where the air will enter the vehicle.





UPPER: This setting directs most of the air through the instrument panel outlets with a very small amount of air directed to the lower outlets.



BI-LEVEL: This setting directs air into your vehicle in two ways. Cooler air is directed toward your upper body through the instrument panel outlets, while warmer air is directed through the lower outlets.

 **LOWER:** This setting directs most of the air through the lower ducts to the floor area of the vehicle with some of the air also directed toward the windshield and side window vents.

 **DEFOG:** This setting divides the air between the windshield and lower outlets with a small amount directed toward the side window vents. This is useful when fog appears on the windshield or side glass due to rain or snowy conditions.

 **DEFROST:** Use this setting to quickly remove fog or frost from the windshield. This setting directs most of the airflow to the windshield with a small amount directed toward the lower and side window outlets.

Mode Buttons

These buttons control the air intake, the air conditioning and the rear window defogger operation.

 **FRESH AIR:** Press this button and it will bring outside air into your vehicle. The light on the button will come on when operating. Use this setting while trying to defrost or defog windows to help clear moisture.

 **RECIRCULATE:** Press this button to limit the amount of fresh air entering your vehicle by recirculating most of the air inside your vehicle. The light on the button will come on when operating. This setting is helpful when you are trying to cool the air quickly or to limit odors entering your vehicle. RECIRCULATE cannot be used while in the DEFROST or DEFOG modes.

 **A/C:** This button turns the air conditioning compressor off or on under most conditions. The light on the A/C button comes on when the compressor is operating. The air conditioning does not operate at temperatures below approximately 35°F to 40°F (2°C to 4°C). The air conditioning cools and dehumidifies the air coming into the vehicle. The air conditioning cannot be turned off in DEFROST as it helps to remove moisture from the vehicle. It also helps to keep the windows clear.

The air conditioning may be forced off at high engine speeds or high engine oil or coolant temperatures.

Automatic Electronic Dual Climate Control System (If Equipped)



Your vehicle may be equipped with a Dual Zone Electronic Climate Control System. This system can automatically adjust and control temperature output, fan speed, air delivery mode, air conditioning operation and air intake. You can use the AUTO (automatic) setting or override the automatic operation with manual control settings. The control settings will be remembered each time you turn the ignition off and restart in the same settings. You can use the Memory option to store and recall your settings. (See “Memory” in the Index.)

Digital Display

The digital display shows readings in Fahrenheit or Celsius by pressing the E/M button (English/Metric) on the Driver Information Center (DIC). When you start the vehicle, the display will show the current fan speed, air delivery mode and the driver-set temperature for approximately five seconds and then show the outside temperature.

When the system is fully in the automatic mode, the word AUTO will also appear on the display. If you have selected a manual fan speed, then the fan symbol will appear on the display. If a manual air delivery mode has been selected, the delivery mode symbol will appear on the display.

Driver Set Temperature Knob

The DRIVER knob changes the temperature on the driver's and passenger's side of the vehicle. Turn the knob to the right to increase the temperature and to the left to decrease the temperature. Whenever you turn this knob, the temperature will be displayed for approximately five seconds along with the current fan speed and air delivery mode.

When adjusting the temperature, start with a driver-set temperature of 73°F (23°C) until you determine your comfort zone. If you choose 60°F (16°C), the system will remain at maximum cooling and will not automatically adjust fan speed or air delivery. If you choose 90°F (32°C), the system will remain at maximum heating and will not automatically adjust fan speed or air delivery. Choosing either maximum setting will not cause the system to heat or cool any faster. Turning the knob past either maximum setting has no effect on the operation of the system.

Passenger Temperature Offset

The PASSENGER knob changes the temperature on the passenger's side of the vehicle. When the knob is in the 12 o'clock position, the passenger's temperature is the same as the driver's. Turn the knob to the right for warmer air on the passenger's side, to the left for cooler air. If the driver-set temperature is set at 60°F (16°C) or 90°F (32°C), turning the passenger knob has no effect because the system is locked at a maximum setting.

Automatic Operation

Press the AUTO button to place the entire system in the automatic mode. After a five second display of the

current settings, only the word AUTO and the outside temperature will be shown on the digital display. The system will operate to achieve your comfort set temperature as quickly as possible. If you have set the driver temperature at 60°F (16°C) or 90°F (32°C), the system will not operate automatically until a different temperature is selected. The AUTO control system works best with the windows up and the removable roof installed or the convertible top up.

A Typical Cold Weather Example:

Your vehicle has been parked outside overnight in cold weather (below 32°F/ 0°C) and you have set the driver temperature at 73°F (23°C) and have selected the AUTO mode. The system will automatically adjust the temperature output to maximum heating. The fan will start at a low speed. This is to avoid blowing cold air into the vehicle. The length of the delay depends on the amount of time since the engine was last started, the outside temperature and the engine coolant temperature. As the coolant warms up, the fan speed will gradually increase. Air will flow to the floor with some air to the windshield to prevent fogging under most normal conditions.

As the interior of the vehicle warms up to your comfort set temperature, the fan speed will decrease and the temperature output may become cooler. If the interior temperature continues to warm up due to heating from the sun or outside temperature increases, the system may switch to other air delivery modes (typically DEFOG or BI-LEVEL).

A Typical Hot Weather Example:

Your vehicle has been parked outside all day in hot weather (above 70°F/ 21°C) and you have set the driver temperature at 73°F (23°C) and have selected the AUTO mode. The system will automatically adjust the temperature output to maximum cooling. The blower will start at a low speed momentarily to push the hot air to the floor of the vehicle and then go to a higher blower speed with cold airflow out of the instrument panel outlets. A small amount of airflow will continue through the lower ducts to cool the floor area.

The air intake may start in the recirculated mode for maximum cooling performance. As the interior of the vehicle cools down to your comfort set temperature, the fan speed will decrease and the temperature output may become warmer. The air intake may shift from recirculation to fresh air mode. If the interior continues

to cool due to a decrease in the amount of heat the vehicle is absorbing from the sun or a decrease in the outside temperature, the system could switch to other air delivery modes (typically BI-LEVEL or DEFOG).

Manual Settings

With the Dual Zone Electronic Climate Control, there are several manual settings you can use to control the system and override the AUTO operation. You can program the fan speed, air delivery mode, air intake mode and control the air conditioning operation using these settings. The system will still determine the temperature output level based on the driver-set temperature and the passenger temperature offset.

 **FAN SPEED:** Press the button with the fan switch on it to manually lock in the current fan speed and to stop the automatic fan speed control. Pressing the arrows will delete AUTO from the digital display. The fan graphics with the fan speed bars will be shown. To increase the fan speed so that more air flows into the vehicle, press the UP arrow on the fan switch. To decrease the fan speed and airflow, press the DOWN arrow. The AUTO button must be pressed to return to the automatic fan control.

MODE: Press the MODE button to manually lock in the current air delivery setting and to stop the automatic mode control. Pressing the MODE button will delete AUTO from the digital display and the mode graphics will be shown. To change the setting, press the MODE button again. The AUTO button must be pressed to return to the automatic mode selection.

 **UPPER:** This setting directs most of the air through the instrument panel outlets and a very small amount to the lower outlets.

 **BI-LEVEL:** This setting directs air into your vehicle in two ways. Cooler air is directed toward your upper body through the instrument panel outlets, while warmer air is directed through the lower outlets.

 **LOWER:** This setting directs most of the air to the floor area and some of it toward the windshield and side window vents.

 **DEFOG:** This setting divides the air between the windshield and lower outlets and a small amount toward the side window vents. This is useful when fog appears on the windshield or side glass due to rain or snowy conditions.

Mode Buttons

These buttons control climate control ON/OFF, air intake, front defrost, rear defrost and the air conditioning operation.

 **OFF:** Press the OFF button to turn off the climate control system. This is the only setting that fully shuts off the fan. The digital display will show only the outside temperature. You can still adjust the driver set temperature, the passenger temperature offset and the air intake mode while in OFF.

 **A/C:** This button turns the air conditioning compressor on or off, except in the FRONT defrost mode. The light on the A/C button will come on when the compressor is operating in either the automatic or manual mode. The air conditioning may also be forced off at high engine speeds. The light on the A/C button will flash if pressed when air conditioning operation is not allowed.

 **FRESH AIR:** Press this button to provide fresh air from the outside. The light on this air intake button will come on to show when it is operating. When in the AUTO mode, the system automatically selects FRESH AIR instead of RECIRCULATE, as required, to control the temperature in the vehicle. By pressing FRESH AIR, the system will lock into the fresh air mode. Any adjustment to the air intake must then be made manually. FRESH AIR should be used when trying to defrost or defog windows to help reduce moisture inside the vehicle.

 **RECIRCULATE:** Press this button to limit the amount of fresh air entering the vehicle. The light on this air intake button will come on to show when it is operating. RECIRCULATE is helpful when you are trying to cool the air quickly or trying to limit odors and dust from entering the vehicle. When in the AUTO mode, the system automatically selects RECIRCULATE to cool the vehicle's temperature. By pressing this button, the system will lock into the recirculated air mode. Any adjustment to the air intake must then be made manually. The recirculated air mode is not allowed in the front defrost or defog modes as fresh air helps reduce moisture inside the vehicle.

 **FRONT:** Press the FRONT defrost button to quickly remove fog or frost from the windshield. This setting directs most of the airflow to the windshield and a small amount toward the lower and side window outlets. The light on the button will come on and the digital display will show the defrost mode symbol and fan speed when the front defrost mode is being used. Pressing FRONT defrost again will return the system to the last operating mode.

If the system is in FRONT defrost when you shut the engine off, it will restart in FRONT defrost unless the engine is off for longer than 40 minutes. If the engine is off longer than 40 minutes, the system will restart in the operating mode you had set prior to FRONT defrost.

The air conditioning cools and dehumidifies air coming into the vehicle. It also operates in defrost to help remove moisture from the vehicle. The air conditioning does not operate at temperatures below approximately 35°F to 40°F (2°C to 4°C). If the system is operating in the AUTO mode, turning the air conditioning off will delete AUTO from the digital display and show current mode and fan settings. The AUTO button must be pressed to return to the automatic mode operation.

Sensors

The Dual Zone Electronic Climate Control System uses several sensors to control operation and display information.

Solar Load Sensor

This sensor is located on the top right side of the defroster grille. The defroster grille is on the top of the instrument panel.

The sensor monitors the sun's solar radiation and uses this information as part of the automatic climate control system when operating in the AUTO mode.

Be careful not to put anything over the sensor. It cannot compensate for changes in the amount of heat the vehicle is absorbing from the sun when covered.

Outside Air Temperature Sensor

This sensor is located in the air intake under the front bumper of the vehicle. Information from this sensor is used for the outside air temperature readings shown on the digital display for the automatic climate control system.

If the outside temperature goes up, the displayed temperature will not change until:

- The vehicle's speed is above 20 mph (32 km/h) for one and a half minutes.
- The vehicle's speed is above 45 mph (72 km/h) for one minute.

These delays help prevent false readings. If the temperature goes down, the outside temperature display is updated immediately.

If your vehicle has been turned off for more than three hours, the current outside temperature will be shown when you start the vehicle. If it has been turned off for less than three hours, the temperature will be recalled from the previous vehicle operation.

Inside Temperature Sensor

This sensor is located just left of the ignition switch. The automatic climate control system uses this sensor to receive information so if you block or cover it, the system will not function properly.

Air Conditioning

On very hot days, your vehicle will cool down more quickly and economically if you open the windows long enough to let hot inside air escape. Then keep your windows closed in order to allow the air conditioning to work best. Maximum cooling will occur when the RECIRCULATE setting is operating, airflow direction is in the upper mode, and the temperature control knob (on a manual climate control system) is turned all the way to the blue area. These settings will be selected by the Automatic Electronic Dual Climate Control System if operating in AUTO when maximum cooling is required.

When the air conditioning is on, you may sometimes notice slight changes in your vehicle's engine performance and power. This is normal. The system is designed to help fuel economy while maintaining the desired cooling level.

The air conditioning removes moisture from the air, so you may notice water dripping from under your vehicle when it is idling or after it has been turned off. This is normal.

Heating

The heater works best if you keep your windows closed. Maximum heating will occur when airflow direction is in the lower mode and the temperature control knob (on a manual climate control system) is all the way in the red area. These settings will be selected by the Automatic Electronic Dual Climate Control System if operating in AUTO when maximum heating is required.

The BI-LEVEL setting is designed for use on sunny days when the air is only moderately warm or cool. On days like these, the sun may adequately warm your upper body, but your lower body may not be warm enough. The BI-LEVEL setting will direct cooler airflow to your upper body and warmer air to the floor area.

If you have the optional engine coolant heater and use it during cold weather 0°F (-18°C) or lower, your heating system will provide heat more quickly because the coolant is already warmed. See "Engine Coolant Heater" in the Index.

Rear Window Defogger

 This button turns the rear defogger and heated outside mirrors on. The light on the button will come on when operating. The system automatically shuts off after approximately 10 minutes. If further defogging is desired, press the button again.

The rear window defogger operates only when the engine is running.

The rear window defogger uses a warming grid to remove fog from the rear window. Do not attach anything like a temporary vehicle license or a decal across the defogger grid on the rear window.

NOTICE:

Don't use a razor blade or something sharp on the inside of the rear window. If you do, you could cut or damage the warming grid, and repairs wouldn't be covered by your warranty.

Defogging and Defrosting

To rapidly defrost the windshield, the FRONT defrost mode (electronic dual climate control system) or defrost mode (manual control system) should be used and the fan speed should be adjusted to the highest speed. With the manual control system, turn the temperature control knob all the way to the red area.

To keep the windshield clear and provide heated air to the floor area of the vehicle, use the DEFOG setting.

Your vehicle is equipped with side window defogger vents located near the side rearview mirrors.

Ventilation System

Your vehicle's flow-through ventilation system supplies outside air into the vehicle when it is moving. Outside air will also enter the vehicle when the fan is running.

Ventilation Tips

- Keep the hood and front air inlet free of ice, snow or any other obstruction (such as leaves). The heater and defroster will work far better, reducing the chance of fogging the inside of the windows.

- When you enter a vehicle in cold weather, turn the blower fan to the highest speed for a few moments before driving off. This helps clear the intake outlets of snow and moisture, and reduces the chance of fogging the inside of the windows.
- Keep the area around the base of the center instrument panel console and air path under the seats clear of objects. This helps air circulate throughout your vehicle.

Audio Systems

Your Delco Electronics audio system has been designed to operate easily and give years of listening pleasure. You will get the most enjoyment out of it if you acquaint yourself with it first. Find out what your Delco Electronics system can do and how to operate all its controls, to be sure you're getting the most out of the advanced engineering that went into it.

Setting the Clock for All Systems

Press and hold HR until the correct hour appears. Press and hold MN until the correct minute appears.

AM-FM Stereo with Cassette Tape Player and Automatic Tone Control



Included with the AM-FM Stereo with Cassette Tape Player and Automatic Tone Control, are six Bose[®] amplified speakers. See your dealer for details.

Playing the Radio

PWR-VOL: Press this knob to turn the system on and off. To increase volume, turn the knob to the right. Turn it to the left to decrease volume. The knob is capable of rotating continuously.

RECALL: Press this button to recall the station being played. If you press the button when the ignition is off, the clock will show for a few seconds.

SCV: Your system has a feature called Speed-Compensated-Volume (SCV). With SCV, your audio system adjusts automatically to make up for road and wind noise as you drive. Set the volume at the desired level. Move the control ring behind the upper knob to the right to adjust the SCV. Then, as you drive, SCV automatically increases the volume, as necessary, to overcome noise at any particular speed. The volume level should always sound the same to you as you drive. If you don't want to use SCV, turn the control all the way down. Each notch on the control ring allows for more volume compensation at faster vehicle speeds.

Finding a Station

AM-FM: Press this button to switch between AM, FMI and FM2. The display shows your selection.

TUNE: Press this knob lightly so it extends. Turn it to choose radio stations. Push the knob back into its stored position when you're not using it.

SEEK: Press the right or left arrow to go to the next higher or lower station. The sound will mute while seeking.

SCAN: Press one of the SEEK arrows for two seconds, and SCAN will appear in the display. Use SCAN to listen to stations for a few seconds. The radio will go to a station, stop for a few seconds, then go on to the next station. Press SEEK again to stop scanning. The sound will mute while scanning.

PUSHBUTTONS: The six numbered pushbuttons let you return to your favorite stations. You can set up to 18 stations (six AM, six FMI and six FM2). Just:

1. Turn the radio on.
2. Press AM-FM to select the band.
3. Tune in the desired station.
4. Press AUTO TONE to select the equalization that best suits the type of station selected.

5. Press and hold one of the six numbered buttons. The sound will mute. When it returns, release the button. Whenever you press that numbered button, the station you set will return and the AUTO TONE equalization that you selected will also be automatically selected for that button.
6. Repeat the steps for each pushbutton.

P.SCAN: Press this button to listen to each of your favorite stations stored on your pushbuttons for a few seconds. The radio will scan through each of the stations stored on your pushbuttons, except those stations with weak reception. The AUTO TONE setting stored for that pushbutton will be automatically chosen. Press P.SCAN or one of the pushbuttons again to stop scanning. P.SCAN will be displayed whenever the tuner is in the P.SCAN mode. The channel number (P1-P6) will appear momentarily just before the frequency is displayed. In FM mode, this function will scan through both FM1 and FM2 preset stations and FM1 or FM2 will appear on the display.

Setting the Tone

BASS: Press this knob lightly so it extends. Turn the knob to the right to increase bass and to the left to decrease bass. When you use this control, the radio's AUTO TONE setting will switch to manual and the AUTO TONE display will go blank.

TREB: Press this knob lightly so it extends. Turn the knob to the right to increase treble and to the left to decrease treble. When you use this control, the radio's AUTO TONE setting will switch to manual and the AUTO TONE display will go blank. If a station is weak or noisy, you may want to decrease the treble.

Push these knobs back into their stored positions when you're not using them.

AUTO TONE: This feature allows you to choose preset bass and treble equalization settings designed for country/western, classical, news, rock, pop and jazz stations. C/W will appear on the display when you first press AUTO TONE. Each time you press it, another setting will appear on the display. Press it again after JAZZ appears and the AUTO TONE display will go blank. Tone control will return to the BASS and TREB knobs. Also, if you use the BASS and TREB knobs, control will return to them and the AUTO TONE display will go blank.

Adjusting the Speakers

BAL: Press this knob lightly so it extends. Turn the knob to the right for the right speakers and to the left for the left speakers. The middle position balances the sound between the speakers.

FADE: Press this knob lightly so it extends. Turn the knob to the right to adjust the sound to the front speakers and to the left for the rear speakers. The middle position balances the sound between the speakers.

Push these knobs back into their stored positions when you're not using them.

Playing a Cassette Tape

Your tape player is built to work best with tapes that are 30 to 45 minutes long on each side. Tapes longer than that are so thin they may not work well in this player. If a tape is inserted when the ignition is on but the radio is off, the tape will begin playing. A tape symbol is shown in the center of the graphic display whenever a tape is inserted. When a tape is active, the tape symbol will be accompanied by a direction arrow.

While the tape is playing, use the VOL, AUTO TONE, BAL, FADE, BASS and TREB controls just as you do for the radio. Other controls may have different functions when a tape is inserted. The display will show the tape symbol and an arrow to show which side of the tape is playing.

If you hear nothing or hear just a garbled sound, it may not be in squarely. Press EJECT to remove the tape and start over.

The player is able to detect a tight or broken tape, and will eject the tape. The radio will go back to playing the last station selected.

The player automatically senses the cassette for metal or CrO₂ and sets the pre-emphasis. Anytime a tape is inserted, the top side is selected to play first.

PREV (I): Press this button or the left SEEK arrow to go to the previous selection on the tape if the current selection has been playing for less than eight seconds. If the PREV button is pressed and the current selection has been playing for more than eight seconds, it will go to the beginning of the current selection. Your tape must have at least three seconds of silence between each selection for PREV or SEEK to work. The tape direction arrow blinks during PREV or SEEK operation. The sound will mute during PREV or SEEK operation. Press this button or one of the SEEK arrows again to return to normal play.

PROG (2): Press this button to play the other side of the tape.

NEXT (3): Press this button or the right SEEK arrow to go to the next selection on the tape. If you hold the button or press it more than once, the player will continue moving forward through the tape. Your tape must have at least three seconds of silence between each selection for NEXT or SEEK to work. The tape direction arrow blinks during NEXT or SEEK operation. The sound will mute during NEXT or SEEK operation. Press this button or one of the SEEK arrows again to return to normal play.

REV (4): Press this button to reverse the tape rapidly. Press it again to return to playing speed. The radio will play the last-selected station while the tape reverses.

DD (5): Press this button to reduce background noise. Note that the double-D symbol will appear on the display.

Dolby[®] Noise Reduction is manufactured under a license from Dolby Laboratories Licensing Corporation. Dolby and the double-D symbol are trademarks of Dolby Laboratories Licensing Corporation.

FWD (6): Press this button to advance quickly to another part of the tape. Press the button again to return

to playing speed. The radio will play the last-selected station while the tape advances.

AM-FM: Press this button to play the radio when a tape is in the player.

TAPE AUX: Press this button to change to the tape function when the radio is on. The tape symbol with an arrow will appear on the display when the tape is active. If your system is equipped with a remote playback device, pressing this button a second time will allow the remote device to play.

EJECT: Press this button to remove the tape. The radio will play. EJECT may be activated with either the ignition or radio off. Cassettes may be loaded with the radio off if this button is pressed first. If you leave a cassette tape in the player while listening to the radio, it may become warm.

CLN: If this message appears on the display, the cassette tape player needs to be cleaned. It will still play tapes, but you should clean it as soon as possible to prevent damage to the tapes and player. See "Care of Your Cassette Tape Player" in the Index. After you clean the player, press and hold EJECT for five seconds to reset the CLN indicator. The radio will display --- to show the indicator was reset.

CD Adapter Kits

It is possible to use a CD adapter kit with your cassette tape player after activating the bypass feature on your tape player.

To activate the bypass feature, use the following steps:

1. Turn the ignition on.
2. Turn the radio off.
3. Press TAPE AUX and hold for five seconds.
4. After five seconds, the tape symbol on the display will flash. While the symbol is flashing, insert the adapter. The radio will turn on. The CD player will work now.

This override feature will remain active until EJECT is pressed.

AM-FM Stereo with Compact Disc Player and Automatic Tone Control (If Equipped)



Included with the AM-FM Stereo with Compact Disc Player and Automatic Tone Control, are six Bose[®] amplified speakers. See your dealer for details.

Playing the Radio

PWR-VOL: Press this knob to turn the system on and off. To increase volume, turn the knob to the right. Turn it to the left to decrease volume. The knob is capable of rotating continuously.

RECALL: Press this button to recall the station being played. If you press the button when the ignition is off, the clock will show for a few seconds.

SCV: Your system has a feature called Speed-Compensated-Volume (SCV). With SCV, your audio system adjusts automatically to make up for road and wind noise as you drive. Set the volume at the desired level. Move the control ring behind the upper knob to the right to adjust the SCV. Then, as you drive, SCV automatically increases the volume, as necessary, to overcome noise at any particular speed. The volume level should always sound the same to you as you drive. If you don't want to use SCV, turn the control all the way down. Each notch on the control ring allows for more volume compensation at faster vehicle speeds.

Finding a Station

AM-FM: Press this button to switch between AM, FM1 and FM2. The display shows your selection.

TUNE: Press this knob lightly so it extends. Turn it to choose radio stations. Push the knob back into its stored position when you're not using it.

SEEK: Press the right or left arrow to go to the next higher or lower station. The sound will mute while seeking.

SCAN: Press one of the SEEK arrows for two seconds, and SCAN will appear on the display. Use SCAN to listen to stations for a few seconds. The radio will go to a station, stop for a few seconds, then go on to the next station. Press SEEK again to stop scanning. The sound will mute while scanning.

PUSHBUTTONS: The six numbered pushbuttons let you return to your favorite stations. You can set up to 18 stations (six AM, six FM1 and six FM2). Just:

1. Turn the radio on.
2. Press AM-FM to select the band.
3. Tune in the desired station.
4. Press AUTO TONE to select the equalization that best suits the type of station selected.

5. Press and hold one of the six numbered buttons. The sound will mute. When it returns, release the button. Whenever you press that numbered button, the station you set will return and the AUTO TONE equalization that you selected will also be automatically selected for that button.
6. Repeat the steps for each pushbutton.

P.SCAN: Press this button to listen to each of your favorite stations stored on your pushbuttons for a few seconds. The radio will scan through each of the stations stored on your pushbuttons, except those stations with weak reception. The AUTO TONE setting stored for that pushbutton will be automatically chosen. Press P.SCAN or one of the pushbuttons again to stop scanning. P.SCAN will be displayed whenever the tuner is in the P.SCAN mode. The channel number (P1-P6) will appear momentarily just before the frequency is displayed. In FM mode, this function will scan through both FM1 and FM2 preset stations and FM1 or FM2 will appear on the display.

Setting the Tone

BASS: Press this knob lightly so it extends. Turn the knob to the right to increase bass and to the left to decrease bass. When you use this control, the radio's AUTO TONE setting will switch to manual and the AUTO TONE display will go blank.

TREB: Press this knob lightly so it extends. Turn the knob to the right to increase treble and to the left to decrease treble. When you use this control, the radio's AUTO TONE setting will switch to manual and the AUTO TONE display will go blank. If a station is weak or noisy, you may want to decrease the treble.

Push these knobs back into their stored positions when you're not using them.

AUTO TONE: This feature allows you to choose preset bass and treble equalization settings designed for country/western, classical, news, rock, pop and jazz stations. C/W will appear on the display when you first press AUTO TONE. Each time you press it, another setting will appear on the display. Press it again after JAZZ appears and the AUTO TONE display will go blank. Tone control will return to the BASS and TREB knobs. Also, if you use the BASS and TREB knobs, control will return to them and the AUTO TONE display will go blank.

Adjusting the Speakers

BAL: Press this knob lightly so it extends. Turn the knob to the right for the right speakers and to the left for the left speakers. The middle position balances the sound between the speakers.

FADE: Press this knob lightly so it extends. Turn the knob to the right to adjust the sound to the front speakers and to the left for the rear speakers. The middle position balances the sound between the speakers.

Push these knobs back into their stored positions when you're not using them.

Playing a Compact Disc

Insert a disc partway into the slot, label side up. The player will pull it in. The disc should begin playing. The display will show CD and the CD symbol. If you want to insert a compact disc with the ignition off, first press **RECALL** or **EJECT**.

If you're driving on a very rough road or if it's very hot, the disc may not play and **ERR** (error) may appear on the display. Press **RECALL** to take **ERR** off the display. When things get back to normal, the disc should play. If the disc comes out, it could be that:

- The disc is upside down.
- It is dirty, scratched or wet.
- It is very humid. (If so, wait about an hour and try again.)

PREV (1): Press this button or the left **SEEK** arrow to go to the previous track if the current selection has been playing for less than eight seconds. If the **PREV** button is pressed and the current selection has been playing for more than eight seconds, it will go to the beginning of the current selection. If you hold the button or press it more than once, the player will continue moving back through the disc. The sound will mute while seeking.

RDM (2): Press this button to hear the tracks in random, rather than sequential, order. **RANDOM** will show on the display. Press **RDM** again to turn off random play. **RDM** is reset to off when the disc is ejected.

NEXT (3): Press this button or the right **SEEK** arrow to go to the next track. If you hold the button or press it more than once, the player will continue moving forward through the disc. The sound will mute while seeking.

REV (4): Press and hold this button to quickly reverse within a track. Release it to play the passage. You can use the counter reading on the display to locate a passage more easily.

FWD (6): Press and hold this button to advance quickly within a track. Release it to resume playing. You can use the counter reading on the display to locate a passage easily.

RECALL: Press this button to see which track is playing. Press it again within five seconds to see how long it has been playing (elapsed time). The track number also appears when you change the volume or when a new track starts to play.

AM-FM: Press this button to play the radio when a disc is in the player. The letters CD will go off the display.

CD AUX: Press this button to change to the disc function when the radio is on. A CD icon will appear on the display when the disc is in the player, whether it is active or not. If your system is equipped with a remote playback device, pressing this button a second time will allow the remote device to play.

EJECT: Press this button to remove the disc. The radio will play. The disc will start at the first track when you reinsert it.

If you turn off the ignition or radio with a disc in the player, it will stay in the player. When you turn on the ignition or system, the disc will start playing where it was stopped. If you press EJECT but don't remove the disc, the player will pull the disc back in to protect it after about one minute. If you leave a compact disc in the player while listening to the radio, it may become warm.

Trunk Mounted CD Changer (If Equipped)



Your vehicle may be equipped with a trunk mounted CD changer. It is located in the rear center storage compartment. See "Rear Storage" in the Index for more information.

With the optional compact disc changer, you can play up to 12 discs continuously. Normal size discs may be played using the trays supplied in the magazine. The small discs (8 cm) can be played only with specially designed trays.

NOTICE:

Heavy objects in the center storage area which may shift or slide while driving could damage your CD changer. Protect your CD changer by not placing heavy, moveable objects in the center storage area.

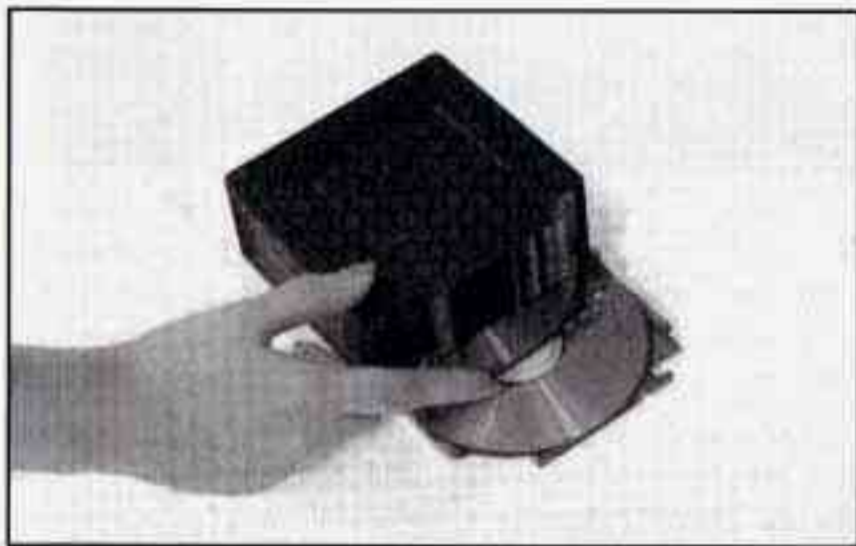

You must first load the magazine with discs before you can play a compact disc. Each of the 12 trays holds one disc. Press the button on the back of the magazine and pull gently on one of the trays. Load the trays from bottom to top, placing a disc on the tray label side down. If you load a disc label side up, the disc will not play and an error will occur. Gently push the tray back into the magazine slot. Repeat this procedure for loading up to 12 discs in the magazine.

Once you have loaded the discs in the magazine, slide open the door of the compact disc (CD) changer. Push the magazine into the changer in the direction of the arrow marked on top of the magazine.

Close the door by sliding it all the way to the left. If the door is left partially open, the changer will not operate and an error will occur. When the door is closed, the changer will begin checking for discs in the magazine. This will continue for up to two minutes depending on the number of discs loaded.

To eject the magazine from the player, slide the CD changer door all the way open. The magazine will automatically eject. Remember to keep the door closed whenever possible to keep dirt and dust from getting inside the changer.

Whenever a CD magazine with discs is loaded in the changer, the CD symbol will appear on the radio display. If the CD changer is checking the magazine for CDs, the CD symbol will flash on the display until the changer is ready to play. When a CD begins playing, a disc and track number will be displayed. The disc numbers are listed on the front of the magazine.

If your vehicle is equipped with the AM-FM Stereo with Cassette Tape Player and Automatic Tone Control, the following buttons are used for the trunk mounted CD changer except the EJECT button for ejecting the CD magazine.

PREV (1): Press this button or the SEEK left arrow to go to the previous track if the current selection has been playing for less than eight seconds. If the PREV button is pressed and the current selection has been playing for more than eight seconds, it will go to the beginning of the current selection. If you hold or press this button more than once, the player will continue moving back through the disc. The sound will mute while seeking.

PROG (2): Press this button to select a disc. The disc number and track number will be displayed.

NEXT (3): Press this button or the SEEK right arrow to go to the next track. If you hold the button or press it more than once, the player will continue moving forward through the disc. The sound will mute while seeking.

REV (4): Press and hold this button to reverse quickly through a track selection. Release it to resume playing.

FWD (6): Press and hold this button to advance quickly through a track selection. Release it to resume playing.

SEEK: Press the right arrow to seek to the next selection on the CD. Press the left arrow to search for the previous selection on the CD. The sound will mute while seeking.

P.SCAN: Press this button to hear the tracks in random, rather than sequential, order. RANDOM will appear on the display. Press P.SCAN again to turn off random play.

TAPE AUX: Press this button if you have a disc loaded in the changer and the radio is turned on, to play a compact disc. Press AM-FM to return to the radio when a compact disc is playing. Press TAPE AUX to switch between the tape and compact disc if both are loaded.

To eject the disc holder in the trunk mounted CD changer, slide the CD changer door all the way open and the disc holder will automatically eject.

If your vehicle is equipped with the AM-FM Stereo with CD Player and Automatic Tone Control, the following buttons are used for the trunk mounted CD changer except the EJECT button for ejecting the CD magazine.

PREV (1): Press this button or the SEEK left arrow to go to the previous track if the current selection has been playing for less than eight seconds. If the PREV button is pressed and the current selection has been playing for more than eight seconds, it will go to the beginning of the current selection. If you hold or press this button more than once, the player will continue moving back through the disc. The sound will mute while seeking.

RDM (2): Press this button to hear the tracks in random, rather than sequential, order. RANDOM will appear on the display. Press RDM again to turn off random play.

NEXT (3): Press this button or the SEEK right arrow to go to the next track. If you hold the button or press it more than once, the player will continue moving forward through the disc. The sound will mute while seeking.

REV (4): Press and hold this button to reverse quickly through a track selection. Release it to resume playing.

(5): Press this button to select a disc. The disc number and track number will be displayed.

FWD (6): Press and hold this button to advance quickly through a track selection. Release it to resume playing.

SEEK: Press the right arrow to seek to the next selection on the CD. Press the left arrow to search for the previous selection on the CD. The sound will mute while seeking.

CD AUX: Press this button if you have a disc loaded in the changer and the radio is turned on, to play a compact disc. Press AM-FM to return to the radio when a compact disc is playing. Press CD AUX to switch between the trunk mounted CD changer and compact disc if both are loaded.

To eject the disc holder in the trunk mounted CD changer, slide the CD changer door all the way open and the disc holder will automatically eject.

Compact Disc Changer Errors

If an error occurs while trying to play a CD in the compact disc changer, the following conditions may have caused the error:

- The road is too rough. The disc should play when the road is smoother.
- The disc is dirty, scratched, wet or loaded label side up.
- The air is very humid. If so, wait about an hour and try again.
- The CD changer door is open. Completely close the changer door to restore normal operation.

- An empty magazine is inserted in the CD changer. Try the magazine again with a disc loaded on one of the trays.

If any error occurs repeatedly or if an error cannot be corrected, please contact your dealer.

Theft-Deterrent Feature

THEFTLOCK™ is designed to discourage theft of your radio. It works by using a secret code to disable all radio functions whenever battery power is removed.

The THEFTLOCK feature for the radio may be used or ignored. If ignored, the system plays normally and the radio is not protected by the feature. If THEFTLOCK is activated, your radio will not operate if stolen.

When THEFTLOCK is activated, the radio will display LOC to indicate a locked condition anytime battery power has been interrupted. If your battery loses power for any reason, you must unlock the radio with the secret code before it will operate.

Activating the Theft-Deterrent Feature

The instructions which follow explain how to enter your secret code to activate the THEFTLOCK system. It is recommended that you read through all nine steps before starting the procedure.

NOTE: If you allow more than 15 seconds to elapse between any steps, the radio automatically reverts to time and you must start the procedure over at Step 4.

1. Write down any three or four-digit number from 000 to 1999 and keep it in a safe place separate from the vehicle.
2. Turn the ignition to ACCESSORY or ON.
3. Turn the radio off.
4. Press the 1 and 4 buttons together. Hold them down until --- shows on the display. Next you will use the secret code number which you have written down.
5. Press MN and 000 will appear on the display.
6. Press MN again to make the last two digits agree with your code.
7. Press HR to make the first one or two digits agree with your code.
8. Press AM-FM after you have confirmed that the code matches the secret code you have written down. The display will show REP to let you know that you need to repeat Steps 5 through 7 to confirm your secret code.
9. Press AM-FM and this time the display will show SEC to let you know that your radio is secure. The indicator by the volume control will begin flashing when the ignition is turned off.

Unlocking the Theft-Deterrent Feature After a Power Loss

Enter your secret code as follows; pause no more than 15 seconds between steps:

1. LOC appears when the ignition is on.
2. Press MN and 000 will appear on the display.
3. Press MN again to make the last two digits agree with your code.
4. Press HR to make the first one or two digits agree with your code.
5. Press AM-FM after you have confirmed that the code matches the secret code you have written down. The display will show SEC, indicating the radio is now operable and secure.

If you enter the wrong code eight times, INOP will appear on the display. You will have to wait an hour with the ignition on before you can try again. When you try again, you will only have three chances to enter the correct code before INOP appears.

If you lose or forget your code, contact your dealer.

Disabling the Theft-Deterrent Feature

Enter your secret code as follows; pause no more than 15 seconds between steps:

1. Turn the ignition to ACCESSORY or ON.
2. Turn the radio off.
3. Press the 1 and 4 buttons together. Hold them down until SEC shows on the display.
4. Press MN and 000 will appear on the display.
5. Press MN again to make the last two digits agree with your code.
6. Press HR to make the first one or two digits agree with your code.
7. Press AM-FM after you have confirmed that the code matches the secret code you have written down. The display will show ---, indicating that the radio is no longer secured.

If the code entered is incorrect, SEC will appear on the display. The radio will remain secured until the correct code is entered.

When battery power is removed and later applied to a secured radio, the radio won't turn on and LOC will appear on the display.

To unlock a secured radio, see "Unlocking the Theft-Deterrent Feature After a Power Loss" earlier in this section.

Understanding Radio Reception

AM

The range for most AM stations is greater than for FM, especially at night. The longer range, however, can cause stations to interfere with each other. AM can pick up noise from things like storms and power lines. Try reducing the treble to reduce this noise if you ever get it.

FM Stereo

FM stereo will give you the best sound, but FM signals will reach only about 10 to 40 miles (16 to 65 km). Tall buildings or hills can interfere with FM signals, causing the sound to come and go.

Tips About Your Audio System

Hearing damage from loud noise is almost undetectable until it is too late. Your hearing can adapt to higher volumes of sound. Sound that seems normal can be loud and harmful to your hearing. Take precautions by adjusting the volume control on your radio to a safe sound level before your hearing adapts to it.

To help avoid hearing loss or damage:

- Adjust the volume control to the lowest setting.
- Increase volume slowly until you hear comfortably and clearly.

NOTICE:

Before you add any sound equipment to your vehicle -- like a tape player, CB radio, mobile telephone or two-way radio -- be sure you can add what you want. If you can, it's very important to do it properly. Added sound equipment may interfere with the operation of your vehicle's engine, Delco Electronics radio or other systems, and even damage them. Your vehicle's systems may interfere with the operation of sound equipment that has been added improperly.

So, before adding sound equipment, check with your dealer and be sure to check Federal rules covering mobile radio and telephone units.

Care of Your Cassette Tape Player

A tape player that is not cleaned regularly can cause reduced sound quality, ruined cassettes or a damaged mechanism. Cassette tapes should be stored in their cases away from contaminants, direct sunlight and extreme heat. If they aren't, they may not operate properly or may cause failure of the tape player.

Your tape player should be cleaned regularly after every 50 hours of use. Your radio may display CLN to indicate that you have used your tape player for 50 hours without resetting the tape clean timer. If this message appears on the display, your cassette tape player needs to be cleaned. It will still play tapes, but you should clean it as soon as possible to prevent damage to your tapes and player. If you notice a reduction in sound quality, try a known good cassette to see if it is the tape or the tape player at fault. If this other cassette has no improvement in sound quality, clean the tape player.

Cleaning may be done with a scrubbing action, non-abrasive cleaning cassette with pads which scrub the tape head as the hubs of the cleaner cassette turn. It is normal for the cassette to eject while cleaning. Insert the cassette at least three times to ensure thorough cleaning. A scrubbing action cleaning cassette is available through your dealership.

You may also choose a non-scrubbing action, wet-type cleaner which uses a cassette with a fabric belt to clean the tape head. This type of cleaning cassette will not eject and, it may not clean as thoroughly as the scrubbing type cleaner.

After you clean the player, press and hold EJECT for five seconds to reset the CLN indicator. The radio will display --- to show the indicator was reset.

Cassettes are subject to wear and the sound quality may degrade over time. Always make sure the cassette tape is in good condition before you have your tape player serviced.

Care of Your Compact Discs

Handle discs carefully. Store them in their original cases or other protective cases and away from direct sunlight and dust. If the surface of a disc is soiled, dampen a clean, soft cloth in a mild, neutral detergent solution and clean it, wiping from the center to the edge.

Be sure never to touch the signal surface when handling discs. Pick up discs by grasping the outer edges or the edge of the hole and the outer edge.

Care of Your Compact Disc Player

The use of CD lens cleaner discs is not advised, due to the risk of contaminating the lens of the CD optics with lubricants internal to the CD mechanism.

Power Antenna Mast Care (Option)

Your power antenna will look its best and work well if it's cleaned from time to time. To clean the antenna mast:

1. Turn on the ignition and radio to raise the antenna.
2. Dampen a clean cloth with mineral spirits or equivalent solvent.
3. Wipe the cloth over the mast sections, removing any dirt.
4. Wipe dry with a clean cloth.
5. Make the antenna go up and down by turning the radio or ignition off and on.
6. Repeat if necessary.

NOTICE:

Don't lubricate the power antenna. Lubrication could damage it.

NOTICE:

Before entering an automatic car wash, turn off your radio to make the power antenna go down. This will prevent the mast from possibly getting damaged. If the antenna does not go down when you turn the radio off, it may be damaged or need to be cleaned. In either case, lower the antenna by hand by carefully pressing the antenna down.

If the mast portion of your antenna is damaged, you can easily replace it. See your dealer for a replacement kit and follow the instructions in the kit.

Integrated Windshield and Rear Window Antennas (Option)

The antennas in your vehicle are located in the windshield and the rear window. The connectors are at the top of the windshield and the top of the rear window above the rear window defogger.



Section 4 Your Driving and the Road

Here you'll find information about driving on different kinds of roads and in varying weather conditions. We've also included many other useful tips on driving.

4-2	Defensive Driving	4-16	Driving in Rain and on Wet Roads
4-2	Drunken Driving	4-19	City Driving
4-5	Control of a Vehicle	4-20	Freeway Driving
4-6	Braking	4-21	Before Leaving on a Long Trip
4-10	Steering	4-22	Highway Hypnosis
4-12	Off-Road Recovery	4-22	Hill and Mountain Roads
4-12	Passing	4-24	Winter Driving
4-13	Loss of Control	4-29	Loading Your Vehicle
4-15	Driving at Night	4-30	Towing A Trailer



Assume that pedestrians or other drivers are going to be careless and make mistakes. Anticipate what they might do. Be ready for their mistakes.

Rear-end collisions are about the most preventable of accidents. Yet they are common. Allow enough following distance. It's the best defensive driving maneuver, in both city and rural driving. You never know when the vehicle in front of you is going to brake or turn suddenly.

Drunken Driving

Death and injury associated with drinking and driving is a national tragedy. It's the number one contributor to the highway death toll, claiming thousands of victims every year.

Alcohol affects four things that anyone needs to drive a vehicle:

- Judgment
- Muscular Coordination
- Vision
- Attentiveness.

Defensive Driving

The best advice anyone can give about driving is: Drive defensively.

Please start with a very important safety device in your Corvette: Buckle up. (See "Safety Belts" in the Index.)

Defensive driving really means "be ready for anything." On city streets, rural roads or freeways, it means "always expect the unexpected."

Police records show that almost half of all motor vehicle-related deaths involve alcohol. In most cases, these deaths are the result of someone who was drinking and driving. In recent years, over 17,000 annual motor vehicle-related deaths have been associated with the use of alcohol, with more than 300,000 people injured.

Many adults -- by some estimates, nearly half the adult population -- choose never to drink alcohol, so they never drive after drinking. For persons under 21, it's against the law in every U.S. state to drink alcohol. There are good medical, psychological and developmental reasons for these laws.

The obvious way to solve this highway safety problem is for people never to drink alcohol and then drive. But what if people do? How much is "too much" if the driver plans to drive? It's a lot less than many might think. Although it depends on each person and situation, here is some general information on the problem.

The Blood Alcohol Concentration (BAC) of someone who is drinking depends upon four things:

- The amount of alcohol consumed
- The drinker's body weight
- The amount of food that is consumed before and during drinking

- The length of time it has taken the drinker to consume the alcohol.

According to the American Medical Association, a 180-lb. (82 kg) person who drinks three 12-ounce (355 ml) bottles of beer in an hour will end up with a BAC of about 0.06 percent. The person would reach the same BAC by drinking three 4-ounce (120 ml) glasses of wine or three mixed drinks if each had 1-1/2 ounces (45 ml) of a liquor like whiskey, gin or vodka.

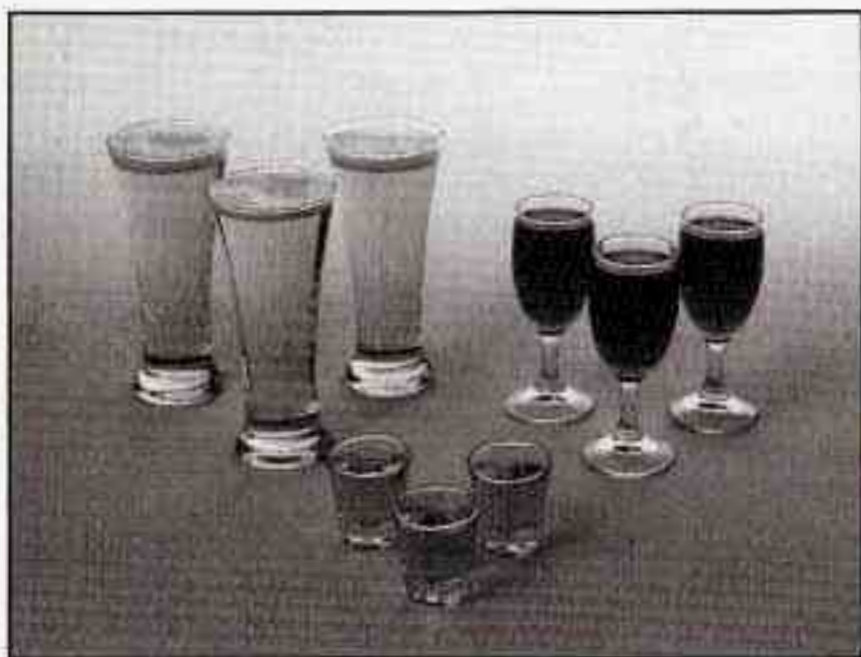

It's the amount of alcohol that counts. For example, if the same person drank three double martinis (3 ounces or 90 ml of liquor each) within an hour, the person's BAC would be close to 0.12 percent. A person who consumes food just before or during drinking will have a somewhat lower BAC level.

There is a gender difference, too. Women generally have a lower relative percentage of body water than men. Since alcohol is carried in body water, this means that a woman generally will reach a higher BAC level than a man of her same body weight when each has the same number of drinks.

The law in many U.S. states sets the legal limit at a BAC of 0.10 percent. In a growing number of U.S. states, and throughout Canada, the limit is 0.08 percent. In some other countries, it's even lower. The BAC limit for all commercial drivers in the United States is 0.04 percent.

The BAC will be over 0.10 percent after three to six drinks (in one hour). Of course, as we've seen, it depends on how much alcohol is in the drinks, and how quickly the person drinks them.

But the ability to drive is affected well below a BAC of 0.10 percent. Research shows that the driving skills of many people are impaired at a BAC approaching

0.05 percent, and that the effects are worse at night. All drivers are impaired at BAC levels above 0.05 percent. Statistics show that the chance of being in a collision increases sharply for drivers who have a BAC of 0.05 percent or above. A driver with a BAC level of 0.06 percent has doubled his or her chance of having a collision. At a BAC level of 0.10 percent, the chance of this driver having a collision is 12 times greater; at a level of 0.15 percent, the chance is 25 times greater!

The body takes about an hour to rid itself of the alcohol in one drink. No amount of coffee or number of cold showers will speed that up. "I'll be careful" isn't the right answer. What if there's an emergency, a need to take sudden action, as when a child darts into the street? A person with even a moderate BAC might not be able to react quickly enough to avoid the collision.

There's something else about drinking and driving that many people don't know. Medical research shows that alcohol in a person's system can make crash injuries worse, especially injuries to the brain, spinal cord or heart. This means that when anyone who has been drinking -- driver or passenger -- is in a crash, that person's chance of being killed or permanently disabled is higher than if the person had not been drinking.

CAUTION:

Drinking and then driving is very dangerous. Your reflexes, perceptions, attentiveness and judgment can be affected by even a small amount of alcohol. You can have a serious -- or even fatal -- collision if you drive after drinking. Please don't drink and drive or ride with a driver who has been drinking. Ride home in a cab; or if you're with a group, designate a driver who will not drink.

Control of a Vehicle

You have three systems that make your vehicle go where you want it to go. They are the brakes, the steering and the accelerator. All three systems have to do their work at the places where the tires meet the road.

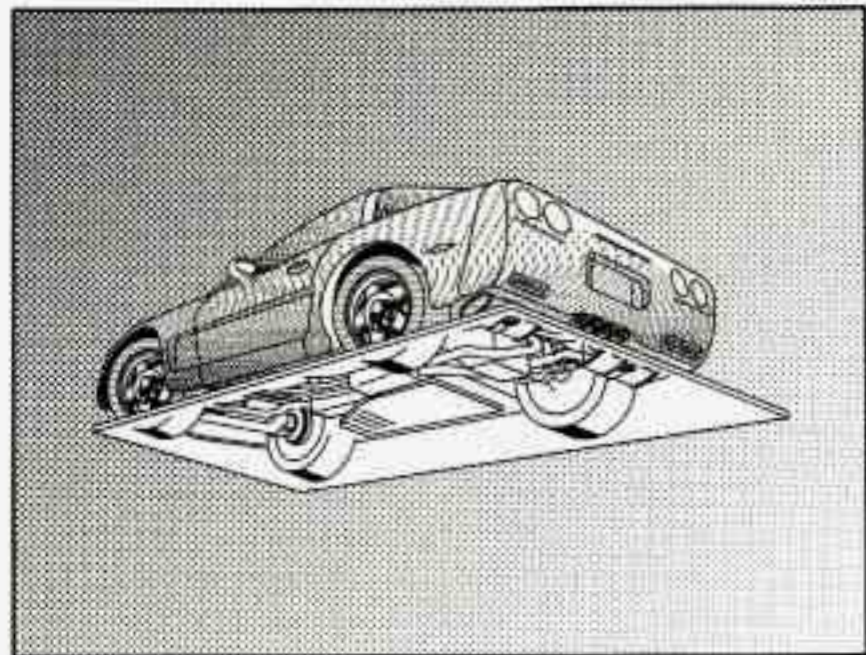

Sometimes, as when you're driving on snow or ice, it's easy to ask more of those control systems than the tires and road can provide. That means you can lose control of your vehicle.

Braking

Braking action involves *perception time* and *reaction time*.

First, you have to decide to push on the brake pedal. That's *perception time*. Then you have to bring up your foot and do it. That's *reaction time*.

Average *reaction time* is about 3/4 of a second. But that's only an average. It might be less with one driver and as long as two or three seconds or more with another. Age, physical condition, alertness, coordination and eyesight all play a part. So do alcohol, drugs and frustration. But even in 3/4 of a second, a vehicle moving at 60 mph (100 km/h) travels 66 feet (20 m). That could be a lot of distance in an emergency, so keeping enough space between your vehicle and others is important.

And, of course, actual stopping distances vary greatly with the surface of the road (whether it's pavement or gravel); the condition of the road (wet, dry, icy); tire-tread; the condition of your brakes; the weight of the vehicle and the amount of brake force applied.

Avoid needless heavy braking. Some people drive in spurts -- heavy acceleration followed by heavy braking -- rather than keeping pace with traffic. This is a mistake. Your brakes may not have time to cool between hard stops. Your brakes will wear out much faster if you do a lot of heavy braking. If you keep pace with the traffic and allow realistic following distances, you will eliminate a lot of unnecessary braking. That means better braking and longer brake life.

If your engine ever stops while you're driving, brake normally but don't pump your brakes. If you do, the pedal may get harder to push down. If your engine stops, you will still have some power brake assist. But you will use it when you brake. Once the power assist is used up, it may take longer to stop and the brake pedal will be harder to push.

Anti-Lock Brakes (ABS)

Your vehicle has anti-lock brakes (ABS). ABS is an advanced electronic braking system that will help prevent a braking skid.

When you start your engine and begin to drive away, your anti-lock brake system will check itself. You may hear a momentary motor or clicking noise while this test is going on, and you may even notice that your brake pedal moves a little. This is normal.



If there's a problem with the anti-lock brake system, this warning light will stay on. See "Anti-Lock Brake System Warning Light" in the Index.



Here's how anti-lock works. Let's say the road is wet. You're driving safely. Suddenly an animal jumps out in front of you.

You slam on the brakes. Here's what happens with ABS.

A computer senses that wheels are slowing down. If one of the wheels is about to stop rolling, the computer will separately work the brakes at each front wheel and at both rear wheels.

The anti-lock system can change the brake pressure faster than any driver could. The computer is programmed to make the most of available tire and road conditions.



You can steer around the obstacle while braking hard.

As you brake, your computer keeps receiving updates on wheel speed and controls braking pressure accordingly.

Remember: Anti-lock doesn't change the time you need to get your foot up to the brake pedal or always decrease

stopping distance. If you get too close to the vehicle in front of you, you won't have time to apply your brakes if that vehicle suddenly slows or stops. Always leave enough room up ahead to stop, even though you have anti-lock brakes.

Using Anti-Lock

Don't pump the brakes. Just hold the brake pedal down firmly and let anti-lock work for you. You may hear a motor or clicking noise and feel the brake pedal move a little during a stop, but this is normal.

Traction Control System (TCS)

Your vehicle has a traction control system called TCS that limits wheel spin. This is especially useful in slippery road conditions. The system operates only if it senses that the rear wheels are spinning too much or are beginning to lose traction. When this happens, the system works the rear brakes and reduces engine power (by closing the throttle and managing engine spark) to limit wheel spin.

The TRACTION SYSTEM ACTIVE message will come on when the TCS system is limiting wheel spin. See "TRACTION SYSTEM ACTIVE Message" in the Index. You may feel or hear the system working, but this is normal.

If your vehicle is in cruise control when the TCS system begins to limit wheel spin, the cruise control will automatically disengage. When road conditions allow you to safely use it again, you may re-engage the cruise control. (See "Cruise Control" in the Index.)

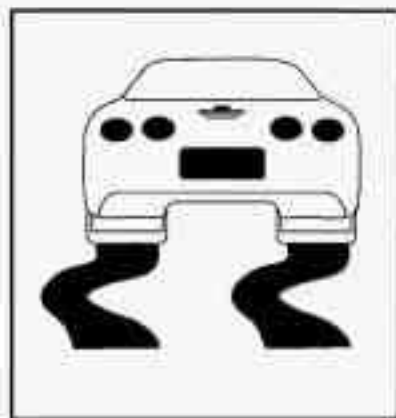

The SERVICE TRACTION SYSTEM message and the TCS warning light will come on to let you know if there's a problem with your TCS system. See "SERVICE TRACTION SYSTEM Message" in the Index.

When this light and the SERVICE TRACTION SYSTEM message are on, the system will not limit wheel spin. Adjust your driving accordingly.

The TCS system automatically comes on whenever you start your vehicle. To limit wheel spin, especially in slippery road conditions, you should always leave the system on. But you can turn the TCS system off if you ever need to.



To turn the system off, press the button located on the console. You can turn the system ON or OFF at any time by pressing the TCS switch. The DIC will display the appropriate message when you push the button.

Braking in Emergencies

With anti-lock, you can steer and brake at the same time. In many emergencies, steering can help you more than even the very best braking.

Steering

Power Steering

If you lose power steering assist because the engine stops or the system is not functioning, you can steer but it will take much more effort.

Steering Tips

Driving on Curves

It's important to take curves at a reasonable speed.

A lot of the "driver lost control" accidents mentioned on the news happen on curves. Here's why:

Experienced driver or beginner, each of us is subject to the same laws of physics when driving on curves. The traction of the tires against the road surface makes it possible for the vehicle to change its path when you turn the front wheels. If there's no traction, inertia will keep the vehicle going in the same direction. If you've ever tried to steer a vehicle on wet ice, you'll understand this.

The traction you can get in a curve depends on the condition of your tires and the road surface, the angle at which the curve is banked, and your speed. While you're in a curve, speed is the one factor you can control.

Suppose you're steering through a sharp curve. Then you suddenly accelerate. Both control systems -- steering and acceleration -- have to do their work where the tires meet the road. Adding the sudden acceleration can demand too much of those places. You can lose control. Refer to "Traction Control System" in the Index.

What should you do if this ever happens? Ease up on the accelerator pedal, steer the vehicle the way you want it to go, and slow down.

Speed limit signs near curves warn that you should adjust your speed. Of course, the posted speeds are based on good weather and road conditions. Under less favorable conditions you'll want to go slower.

If you need to reduce your speed as you approach a curve, do it before you enter the curve, while your front wheels are straight ahead.

Try to adjust your speed so you can "drive" through the curve. Maintain a reasonable, steady speed. Wait to accelerate until you are out of the curve, and then accelerate gently into the straightaway.

Steering in Emergencies

There are times when steering can be more effective than braking. For example, you come over a hill and find a truck stopped in your lane, or a car suddenly pulls out from nowhere, or a child darts out from between parked cars and stops right in front of you. You can avoid these problems by braking -- if you can stop in time. But sometimes you can't; there isn't room. That's the time for evasive action -- steering around the problem.

Your vehicle can perform very well in emergencies like these. First apply your brakes. (See "Braking in Emergencies" earlier in this section.) It is better to remove as much speed as you can from a possible collision. Then steer around the problem, to the left or right depending on the space available.



An emergency like this requires close attention and a quick decision. If you are holding the steering wheel at the recommended 9 and 3 o'clock positions, you can turn it a full 180 degrees very quickly without removing either hand. But you have to act fast, steer quickly, and just as quickly straighten the wheel once you have avoided the object.

The fact that such emergency situations are always possible is a good reason to practice defensive driving at all times and wear safety belts properly.

Off-Road Recovery

You may find that your right wheels have dropped off the edge of a road onto the shoulder while you're driving.

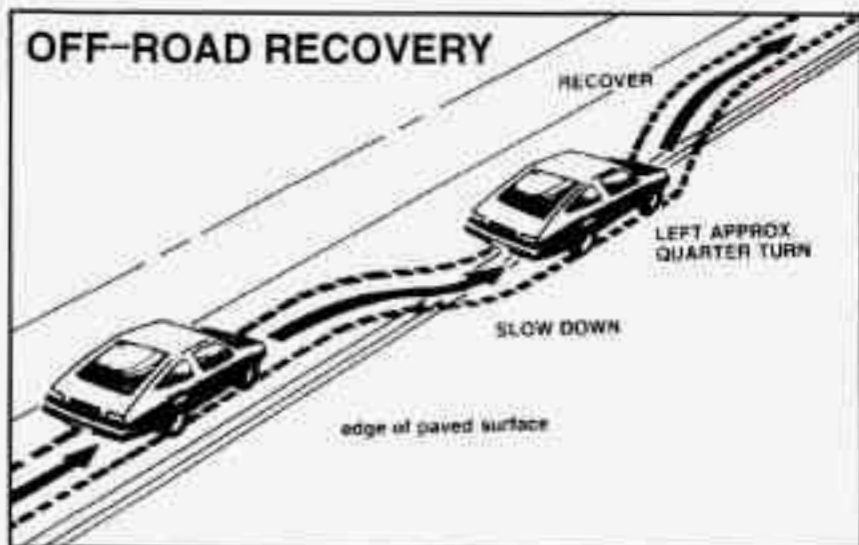

If the level of the shoulder is only slightly below the pavement, recovery should be fairly easy. Ease off the accelerator and then, if there is nothing in the way, steer so that your vehicle straddles the edge of the pavement. You can turn the steering wheel up to one-quarter turn until the right front tire contacts the pavement edge. Then turn your steering wheel to go straight down the roadway.

Passing

The driver of a vehicle about to pass another on a two-lane highway waits for just the right moment, accelerates, moves around the vehicle ahead, then goes back into the right lane again. A simple maneuver?

Not necessarily! Passing another vehicle on a two-lane highway is a potentially dangerous move, since the passing vehicle occupies the same lane as oncoming traffic for several seconds. A miscalculation, an error in judgment, or a brief surrender to frustration or anger can suddenly put the passing driver face to face with the worst of all traffic accidents -- the head-on collision.

So here are some tips for passing:

- "Drive ahead." Look down the road, to the sides and to crossroads for situations that might affect your passing patterns. If you have any doubt whatsoever about making a successful pass, wait for a better time.
- Watch for traffic signs, pavement markings and lines. If you can see a sign up ahead that might indicate a turn or an intersection, delay your pass. A broken center line usually indicates it's all right to pass (providing the road ahead is clear). Never cross a solid line on your side of the lane or a double solid line, even if the road seems empty of approaching traffic.

- Do not get too close to the vehicle you want to pass while you're awaiting an opportunity. For one thing, following too closely reduces your area of vision, especially if you're following a larger vehicle. Also, you won't have adequate space if the vehicle ahead suddenly slows or stops. Keep back a reasonable distance.
- When it looks like a chance to pass is coming up, start to accelerate but stay in the right lane and don't get too close. Time your move so you will be increasing speed as the time comes to move into the other lane. If the way is clear to pass, you will have a "running start" that more than makes up for the distance you would lose by dropping back. And if something happens to cause you to cancel your pass, you need only slow down and drop back again and wait for another opportunity.
- If other cars are lined up to pass a slow vehicle, wait your turn. But take care that someone isn't trying to pass you as you pull out to pass the slow vehicle. Remember to glance over your shoulder and check the blind spot.
- Check your mirrors, glance over your shoulder, and start your left lane change signal before moving out of the right lane to pass. When you are far enough ahead of the passed vehicle to see its front in your inside mirror, activate your right lane change signal and move back into the right lane. (Remember that your right outside mirror is convex. The vehicle you just passed may seem to be farther away from you than it really is.)
- Try not to pass more than one vehicle at a time on two-lane roads. Reconsider before passing the next vehicle.
- Don't overtake a slowly moving vehicle too rapidly. Even though the brake lamps are not flashing, it may be slowing down or starting to turn.
- If you're being passed, make it easy for the following driver to get ahead of you. Perhaps you can ease a little to the right.

Loss of Control

Let's review what driving experts say about what happens when the three control systems (brakes, steering and acceleration) don't have enough friction where the tires meet the road to do what the driver has asked.

In any emergency, don't give up. Keep trying to steer and constantly seek an escape route or area of less danger.

Skidding

In a skid, a driver can lose control of the vehicle.

Defensive drivers avoid most skids by taking reasonable care suited to existing conditions, and by not “overdriving” those conditions. But skids are always possible.

The three types of skids correspond to your vehicle’s three control systems. In the braking skid, your wheels aren’t rolling. In the steering or cornering skid, too much speed or steering in a curve causes tires to slip and lose cornering force. And in the acceleration skid, too much throttle causes the driving wheels to spin.

A cornering skid is best handled by easing your foot off the accelerator pedal.

Remember: Any traction control system helps avoid only the acceleration skid.

If your TCS system is off, then an acceleration skid is also best handled by easing your foot off the accelerator pedal.

If your vehicle starts to slide, ease your foot off the accelerator pedal and quickly steer the way you want the vehicle to go. If you start steering quickly enough, your vehicle may straighten out. Always be ready for a second skid if it occurs.

Of course, traction is reduced when water, snow, ice, gravel or other material is on the road. For safety, you’ll want to slow down and adjust your driving to these conditions. It is important to slow down on slippery surfaces because stopping distance will be longer and vehicle control more limited.

While driving on a surface with reduced traction, try your best to avoid sudden steering, acceleration or braking (including engine braking by shifting to a lower gear). Any sudden changes could cause the tires to slide. You may not realize the surface is slippery until your vehicle is skidding. Learn to recognize warning clues -- such as enough water, ice or packed snow on the road to make a “mirrored surface” -- and slow down when you have any doubt.

Remember: Any anti-lock brake system (ABS) helps avoid only the braking skid.

Driving at Night

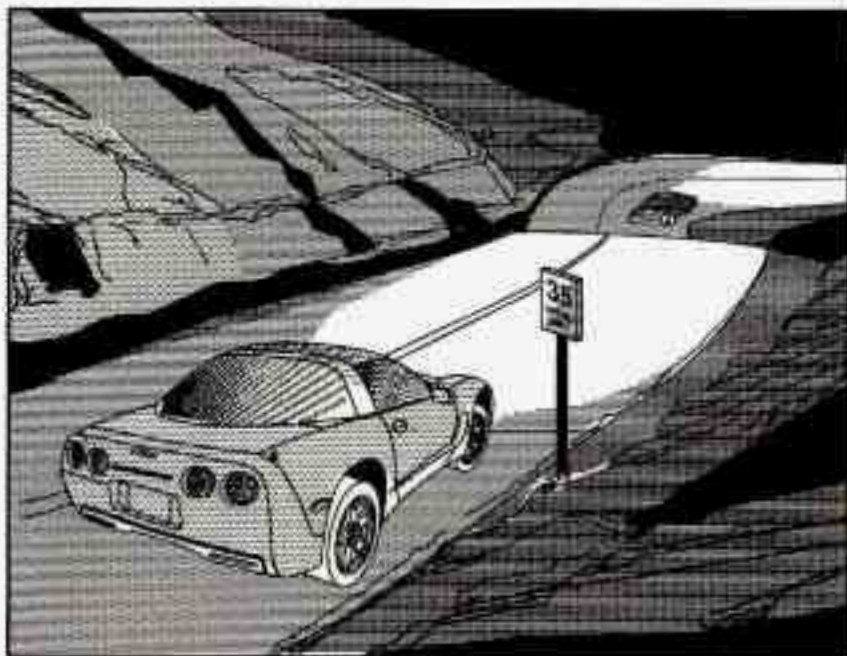

Night driving is more dangerous than day driving. One reason is that some drivers are likely to be impaired -- by alcohol or drugs, with night vision problems, or by fatigue.

Here are some tips on night driving.

- Drive defensively.

- Don't drink and drive.
- Adjust your inside rearview mirror to reduce the glare from headlamps behind you.
- Since you can't see as well, you may need to slow down and keep more space between you and other vehicles.
- Slow down, especially on higher speed roads. Your headlamps can light up only so much road ahead.
- In remote areas, watch for animals.
- If you're tired, pull off the road in a safe place and rest.

Night Vision

No one can see as well at night as in the daytime. But as we get older these differences increase. A 50-year-old driver may require at least twice as much light to see the same thing at night as a 20-year-old.

What you do in the daytime can also affect your night vision. For example, if you spend the day in bright sunshine you are wise to wear sunglasses. Your eyes will have less trouble adjusting to night. But if you're driving, don't wear sunglasses at night. They may cut down on glare from headlamps, but they also make a lot of things invisible.

Driving in Rain and on Wet Roads



You can be temporarily blinded by approaching headlamps. It can take a second or two, or even several seconds, for your eyes to readjust to the dark. When you are faced with severe glare (as from a driver who doesn't lower the high beams, or a vehicle with misaimed headlamps), slow down a little. Avoid staring directly into the approaching headlamps.

Keep your windshield and all the glass on your vehicle clean -- inside and out. Glare at night is made much worse by dirt on the glass. Even the inside of the glass can build up a film caused by dust. Dirty glass makes lights dazzle and flash more than clean glass would, making the pupils of your eyes contract repeatedly.

Remember that your headlamps light up far less of a roadway when you are in a turn or curve. Keep your eyes moving; that way, it's easier to pick out dimly lighted objects. Just as your headlamps should be checked regularly for proper aim, so should your eyes be examined regularly. Some drivers suffer from night blindness -- the inability to see in dim light -- and aren't even aware of it.

Rain and wet roads can mean driving trouble. On a wet road, you can't stop, accelerate or turn as well because your tire-to-road traction isn't as good as on dry roads. And, if your tires don't have much tread left, you'll get even less traction. It's always wise to go slower and be cautious if rain starts to fall while you are driving. The surface may get wet suddenly when your reflexes are tuned for driving on dry pavement.

The heavier the rain, the harder it is to see. Even if your windshield wiper blades are in good shape, a heavy rain can make it harder to see road signs and traffic signals, pavement markings, the edge of the road and even people walking.

It's wise to keep your windshield wiping equipment in good shape and keep your windshield washer tank filled with washer fluid. Replace your windshield wiper inserts when they show signs of streaking or missing areas on the windshield, or when strips of rubber start to separate from the inserts.

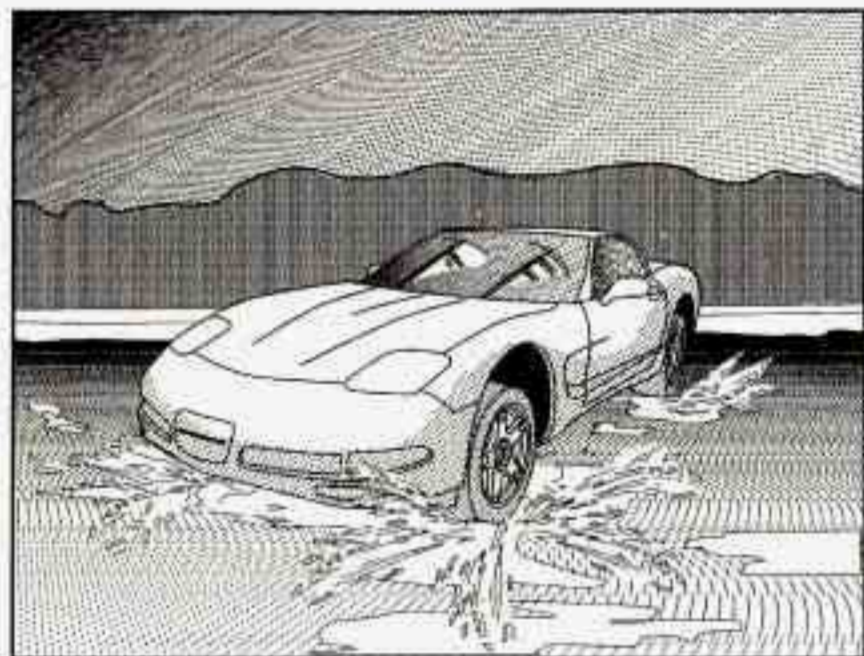

Driving too fast through large water puddles or even going through some car washes can cause problems, too. The water may affect your brakes. Try to avoid puddles. But if you can't, try to slow down before you hit them.

CAUTION:

Wet brakes can cause accidents. They won't work as well in a quick stop and may cause pulling to one side. You could lose control of the vehicle.

After driving through a large puddle of water or a car wash, apply your brake pedal lightly until your brakes work normally.

Hydroplaning

Hydroplaning is dangerous. So much water can build up under your tires that they can actually ride on the water. This can happen if the road is wet enough and you're going fast enough. When your vehicle is hydroplaning, it has little or no contact with the road.

Hydroplaning doesn't happen often. But it can if your tires do not have much tread or if the pressure in one or more is low. It can happen if a lot of water is standing on the road. If you can see reflections from trees, telephone poles or other vehicles, and raindrops "dimple" the water's surface, there could be hydroplaning.

Hydroplaning usually happens at higher speeds. There just isn't a hard and fast rule about hydroplaning. The best advice is to slow down when it is raining.

Driving Through Deep Standing Water

NOTICE:

If you drive too quickly through deep puddles or standing water, water can come in through your engine's air intake and badly damage your engine. Never drive through water that is slightly lower than the underbody of your vehicle. If you can't avoid deep puddles or standing water, drive through them very slowly.

Some Other Rainy Weather Tips

- Besides slowing down, allow some extra following distance. And be especially careful when you pass another vehicle. Allow yourself more clear room ahead, and be prepared to have your view restricted by road spray.
- Have good tires with proper tread depth. (See "Tires" in the Index.)

City Driving



One of the biggest problems with city streets is the amount of traffic on them. You'll want to watch out for what the other drivers are doing and pay attention to traffic signals.

Here are ways to increase your safety in city driving:

- Know the best way to get to where you are going. Get a city map and plan your trip into an unknown part of the city just as you would for a cross-country trip.
- Try to use the freeways that rim and crisscross most large cities. You'll save time and energy. (See the next part, "Freeway Driving.")
- Treat a green light as a warning signal. A traffic light is there because the corner is busy enough to need it. When a light turns green, and just before you start to move, check both ways for vehicles that have not cleared the intersection or may be running the red light.

Freeway Driving

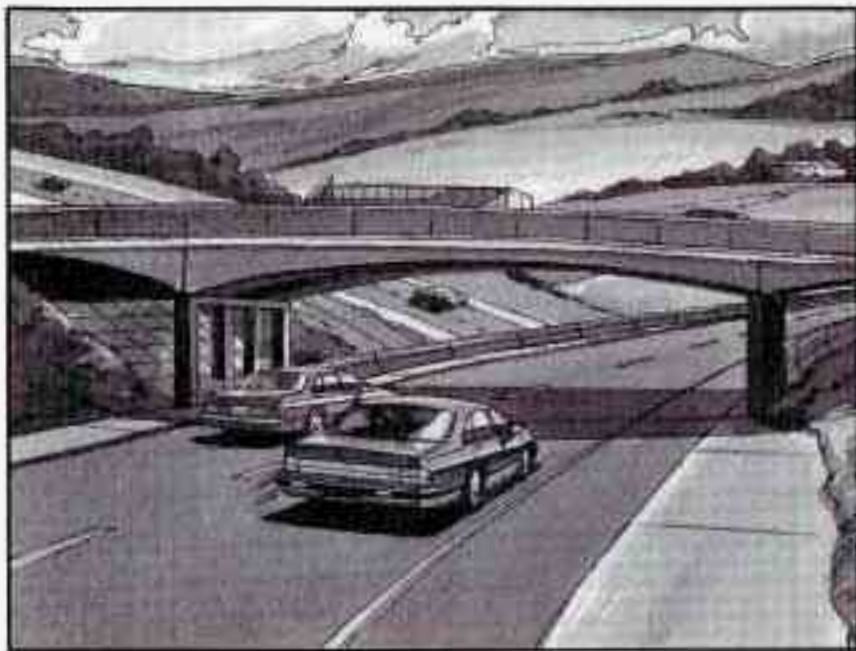

Mile for mile, freeways (also called thruways, parkways, expressways, turnpikes or superhighways) are the safest of all roads. But they have their own special rules.

The most important advice on freeway driving is: Keep up with traffic and keep to the right. Drive at the same speed most of the other drivers are driving. Too-fast or too-slow driving breaks a smooth traffic flow. Treat the left lane on a freeway as a passing lane.

At the entrance, there is usually a ramp that leads to the freeway. If you have a clear view of the freeway as you drive along the entrance ramp, you should begin to check traffic. Try to determine where you expect to blend with the flow. Try to merge into the gap at close to the prevailing speed. Switch on your turn signal, check your mirrors and glance over your shoulder as often as necessary. Try to blend smoothly with the traffic flow.

Once you are on the freeway, adjust your speed to the posted limit or to the prevailing rate if it's slower. Stay in the right lane unless you want to pass.

Before changing lanes, check your mirrors. Then use your turn signal.

Just before you leave the lane, glance quickly over your shoulder to make sure there isn't another vehicle in your "blind" spot.

Once you are moving on the freeway, make certain you allow a reasonable following distance. Expect to move slightly slower at night.

When you want to leave the freeway, move to the proper lane well in advance. If you miss your exit, do not, under any circumstances, stop and back up. Drive on to the next exit.

The exit ramp can be curved, sometimes quite sharply.

The exit speed is usually posted.

Reduce your speed according to your speedometer, not to your sense of motion. After driving for any distance at higher speeds, you may tend to think you are going slower than you actually are.

Before Leaving on a Long Trip

Make sure you're ready. Try to be well rested. If you must start when you're not fresh -- such as after a day's work -- don't plan to make too many miles that first part of the journey. Wear comfortable clothing and shoes you can easily drive in.

Is your vehicle ready for a long trip? If you keep it serviced and maintained, it's ready to go. If it needs service, have it done before starting out. Of course, you'll find experienced and able service experts in GM dealerships all across North America. They'll be ready and willing to help if you need it.

Here are some things you can check before a trip:

- *Windshield Washer Fluid:* Is the reservoir full? Are all windows clean inside and outside?
- *Wiper Blades:* Are they in good shape?
- *Fuel, Engine Oil, Other Fluids:* Have you checked all levels?
- *Lamps:* Are they all working? Are the lenses clean?
- *Tires:* They are vitally important to a safe, trouble-free trip. Is the tread good enough for long-distance driving? Are the tires all inflated to the recommended pressure?
- *Weather Forecasts:* What's the weather outlook along your route? Should you delay your trip a short time to avoid a major storm system?
- *Maps:* Do you have up-to-date maps?

Highway Hypnosis

Is there actually such a condition as “highway hypnosis”? Or is it just plain falling asleep at the wheel? Call it highway hypnosis, lack of awareness, or whatever.

There is something about an easy stretch of road with the same scenery, along with the hum of the tires on the road, the drone of the engine, and the rush of the wind against the vehicle that can make you sleepy. Don't let it happen to you! If it does, your vehicle can leave the road in *less than a second*, and you could crash and be injured.

What can you do about highway hypnosis? First, be aware that it can happen.

Then here are some tips:

- Make sure your vehicle is well ventilated, with a comfortably cool interior.
- Keep your eyes moving. Scan the road ahead and to the sides. Check your rearview mirrors and your instruments frequently.
- If you get sleepy, pull off the road into a rest, service or parking area and take a nap, get some exercise, or both. For safety, treat drowsiness on the highway as an emergency.

Hill and Mountain Roads



Driving on steep hills or mountains is different from driving in flat or rolling terrain.

If you drive regularly in steep country, or if you're planning to visit there, here are some tips that can make your trips safer and more enjoyable.

- Keep your vehicle in good shape. Check all fluid levels and also the brakes, tires, cooling system and transmission. These parts can work hard on mountain roads.
- Know how to go down hills. The most important thing to know is this: let your engine do some of the slowing down. Shift to a lower gear when you go down a steep or long hill.

 **CAUTION:**

If you don't shift down, your brakes could get so hot that they wouldn't work well. You would then have poor braking or even none going down a hill. You could crash. Shift down to let your engine assist your brakes on a steep downhill slope.

 **CAUTION:**

Coasting downhill in NEUTRAL (N) or with the ignition off is dangerous. Your brakes will have to do all the work of slowing down. They could get so hot that they wouldn't work well. You would then have poor braking or even none going down a hill. You could crash. Always have your engine running and your vehicle in gear when you go downhill.

- Know how to go uphill. You may want to shift down to a lower gear. The lower gears help cool your engine and transmission, and you can climb the hill better.
- Stay in your own lane when driving on two-lane roads in hills or mountains. Don't swing wide or cut across the center of the road. Drive at speeds that let you stay in your own lane.
- As you go over the top of a hill, be alert. There could be something in your lane, like a stalled car or an accident.

- You may see highway signs on mountains that warn of special problems. Examples are long grades, passing or no-passing zones, a falling rocks area or winding roads. Be alert to these and take appropriate action.

Winter Driving

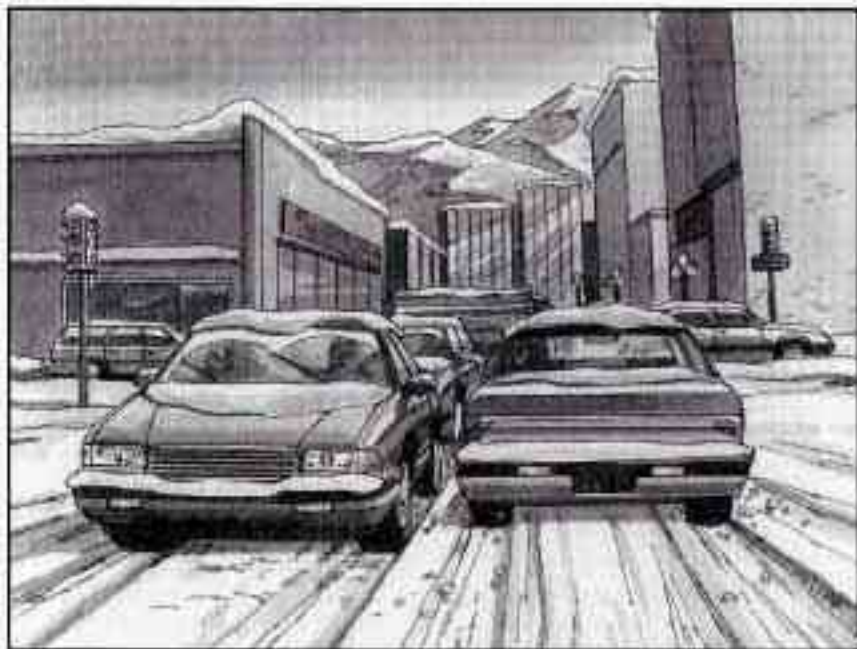

Here are some tips for winter driving:

- Have your vehicle in good shape for winter.
- You may want to put winter emergency supplies in your vehicle.

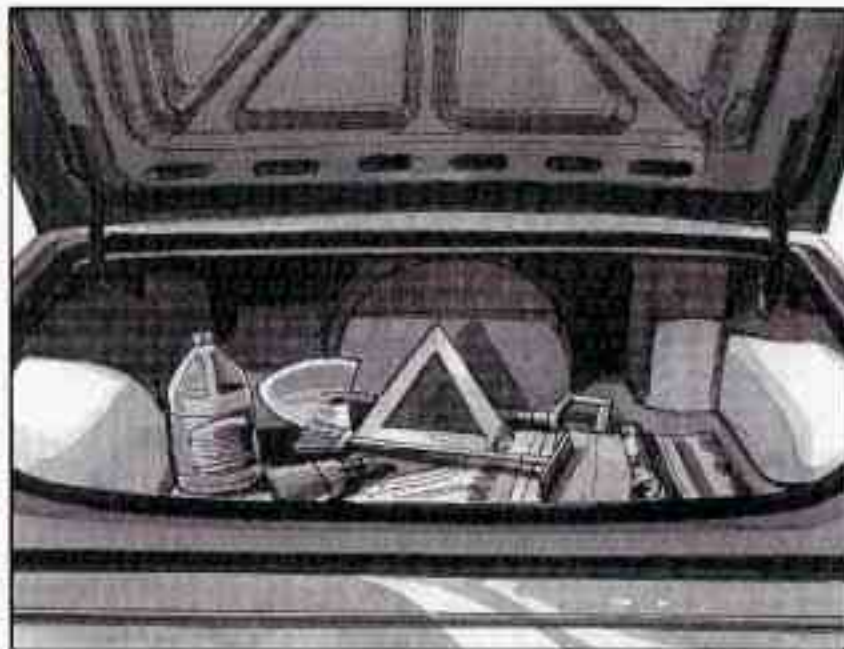

Include an ice scraper, a small brush or broom, a supply of windshield washer fluid, a rag, some winter outer clothing, a small shovel, a flashlight, a red cloth and a couple of reflective warning triangles. And, if you will be driving under severe conditions, include a small bag of sand, a piece of old carpet or a couple of burlap bags to help provide traction. Be sure you properly secure these items in your vehicle.

Driving on Snow or Ice

Most of the time, those places where your tires meet the road probably have good traction.

However, if there is snow or ice between your tires and the road, you can have a very slippery situation. You'll have a lot less traction or "grip" and will need to be very careful.

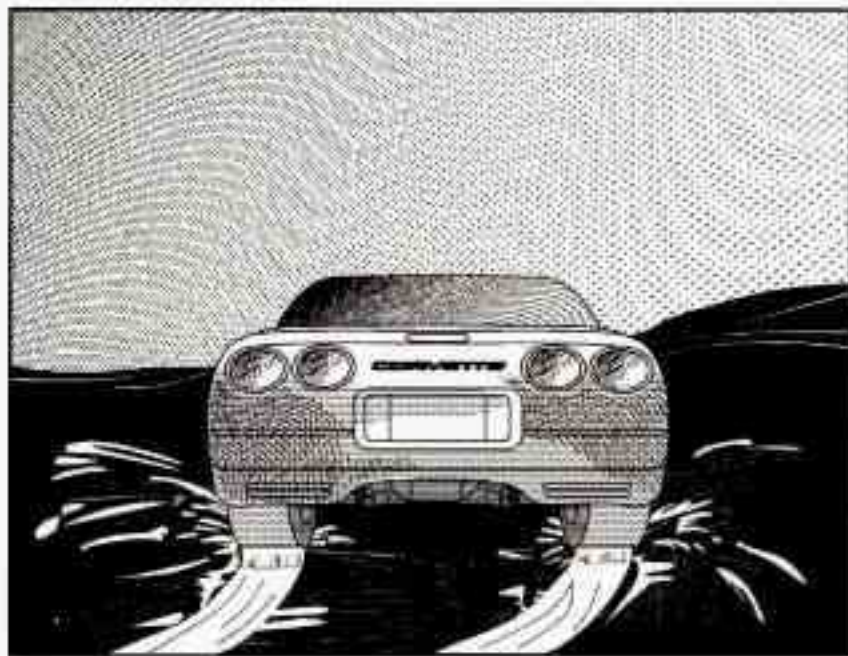

What's the worst time for this? "Wet ice." Very cold snow or ice can be slick and hard to drive on. But wet ice can be even more trouble because it may offer the least traction of all. You can get wet ice when it's about freezing (32°F; 0°C) and freezing rain begins to fall. Try to avoid driving on wet ice until salt and sand crews can get there.

Whatever the condition -- smooth ice, packed, blowing or loose snow -- drive with caution.

Keep your traction control system on. It improves your ability to accelerate when driving on a slippery road. Even though your vehicle has the TCS system, you'll want to slow down and adjust your driving to the road conditions. See "Traction Control System" in the Index.

Your anti-lock brakes improve your vehicle's stability when you make a hard stop on a slippery road. Even though you have the anti-lock braking system, you'll want to begin stopping sooner than you would on dry pavement. See "Anti-Lock" in the Index.

- Allow greater following distance on any slippery road.
- Watch for slippery spots. The road might be fine until you hit a spot that's covered with ice. On an otherwise clear road, ice patches may appear in shaded areas where the sun can't reach: around clumps of trees, behind buildings or under bridges. Sometimes the surface of a curve or an overpass may remain icy when the surrounding roads are clear. If you see a patch of ice ahead of you, brake before you are on it. Try not to brake while you're actually on the ice, and avoid sudden steering maneuvers.

If You're Caught in a Blizzard

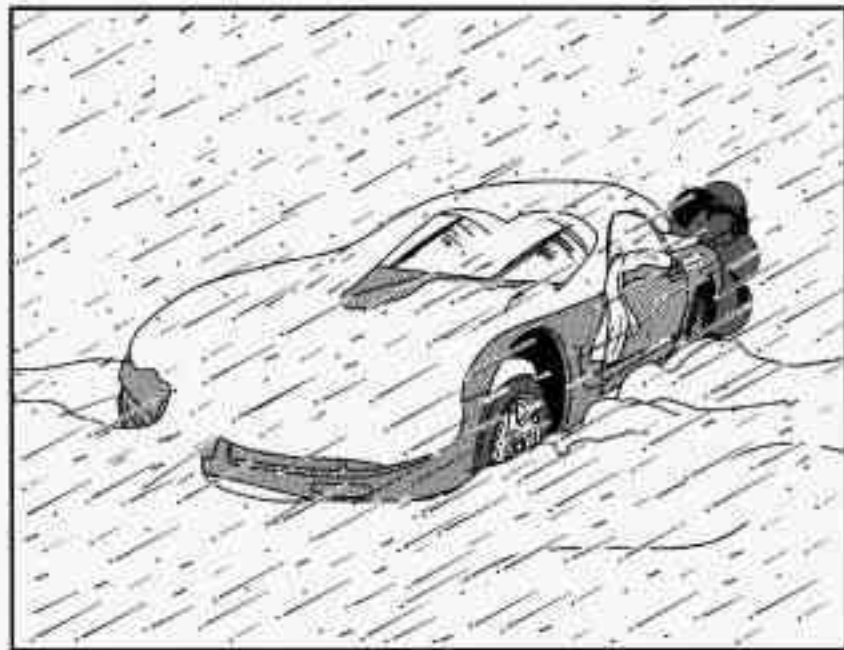

If you are stopped by heavy snow, you could be in a serious situation. You should probably stay with your vehicle unless you know for sure that you are near help and you can hike through the snow. Here are some things to do to summon help and keep yourself and your passengers safe:

- Turn on your hazard flashers.
- Tie a red cloth to your vehicle to alert police that you've been stopped by the snow.
- Put on extra clothing or wrap a blanket around you. If you have no blankets or extra clothing, make body insulators from newspapers, burlap bags, rags, floor mats -- anything you can wrap around yourself or tuck under your clothing to keep warm.

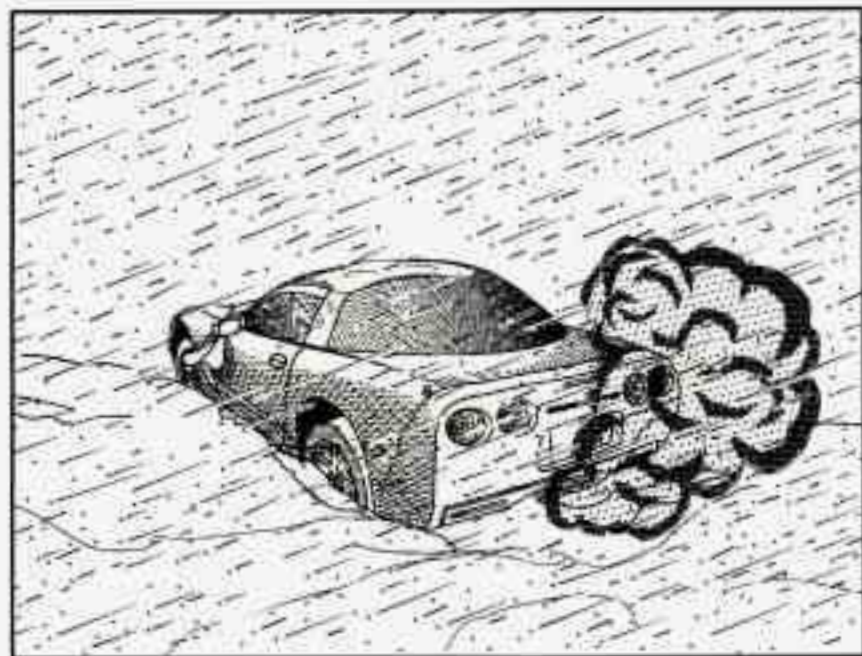

You can run the engine to keep warm, but be careful.

 **CAUTION:**

Snow can trap exhaust gases under your vehicle. This can cause deadly CO (carbon monoxide) gas to get inside. CO could overcome you and kill you. You can't see it or smell it, so you might not know it is in your vehicle. Clear away snow from around the base of your vehicle, especially any that is blocking your exhaust pipe. And check around again from time to time to be sure snow doesn't collect there.

Open a window just a little on the side of the vehicle that's away from the wind. This will help keep CO out.

Run your engine only as long as you must. This saves fuel. When you run the engine, make it go a little faster than just idle. That is, push the accelerator slightly. This uses less fuel for the heat that you get and it keeps the battery charged. You will need a well-charged battery to restart the vehicle, and possibly for signaling later on with your headlamps. Let the heater run for a while.

Then, shut the engine off and close the window almost all the way to preserve the heat. Start the engine again and repeat this only when you feel really uncomfortable from the cold. But do it as little as possible. Preserve the fuel as long as you can. To help keep warm, you can get out of the vehicle and do some fairly vigorous exercises every half hour or so until help comes.

CAUTION:

Do not load your vehicle any heavier than the GVWR, or either the maximum front or rear GAWR. If you do, parts on your vehicle can break, or it can change the way your vehicle handles. These could cause you to lose control. Also, overloading can shorten the life of your vehicle.

NOTICE:

Your warranty does not cover parts or components that fail because of overloading.

If you put things inside your vehicle -- like suitcases, tools, packages or anything else -- they will go as fast as the vehicle goes. If you have to stop or turn quickly, or if there is a crash, they'll keep going.

CAUTION:

Things you put inside your vehicle can strike and injure people in a sudden stop or turn, or in a crash.

- Put things in the rear area of your vehicle. Try to spread the weight evenly.
- Never stack heavier things, like suitcases, inside the vehicle so that some of them are above the tops of the seats.
- Don't leave an unsecured child restraint in your vehicle.
- When you carry something inside the vehicle, secure it whenever you can.

Towing A Trailer

Your Corvette is neither designed nor intended to tow a trailer.



Section 5 Problems on the Road

Here you'll find what to do about some problems that can occur on the road.

5-2 Hazard Warning Flashers
5-3 Jump Starting
5-8 Towing Your Vehicle
5-13 Engine Overheating

5-16 Cooling System
5-22 If a Tire Goes Flat
5-22 If You're Stuck: In Sand, Mud, Ice or Snow

Hazard Warning Flashers

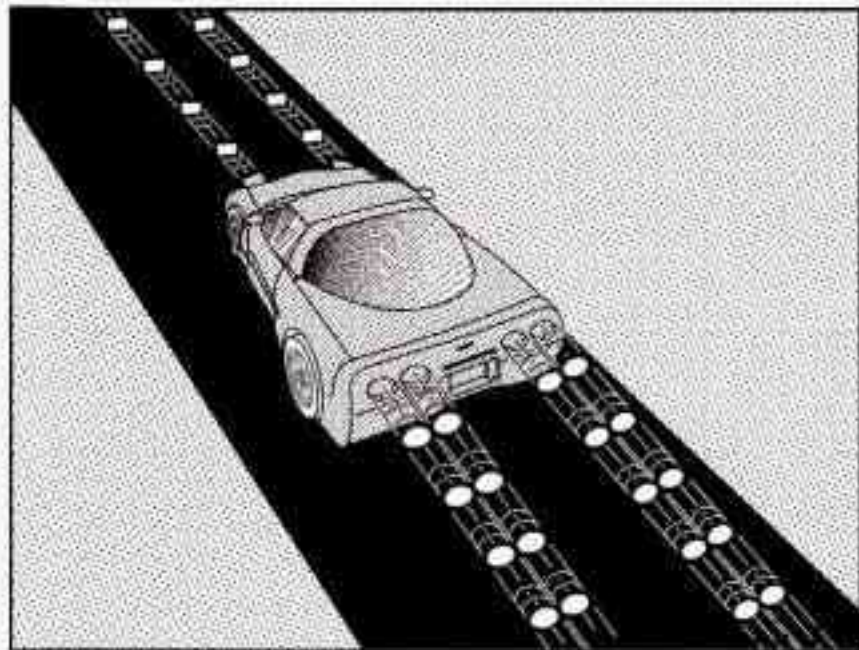

Your hazard warning flashers let you warn others. They also let police know you have a problem. Your front and rear turn signal lamps will flash on and off.



Press this button to make your front and rear turn signal lamps flash on and off.

The hazard warning flashers will work once the button is pressed, regardless of the key position.

To turn off the flashers, push the hazard button.

When the hazard warning flashers are on, your turn signals won't work.

Other Warning Devices

If you carry reflective triangles, you can set one up at the side of the road about 300 feet (100 m) behind your vehicle.

Jump Starting

If your battery has run down, you may want to use another vehicle and some jumper cables to start your Corvette. But please use the following steps to do it safely.

NOTICE:

Ignoring these steps could result in costly damage to your vehicle that wouldn't be covered by your warranty.

Trying to start your Corvette by pushing or pulling it could damage your vehicle, even if you have a manual transmission. And if you have an automatic transmission, it won't start that way.



CAUTION:

Batteries can hurt you. They can be dangerous because:

- They contain acid that can burn you.
- They contain gas that can explode or ignite.
- They contain enough electricity to burn you.

If you don't follow these steps exactly, some or all of these things can hurt you.

1. Check the other vehicle. It must have a 12-volt battery with a negative ground system.

NOTICE:

If the other system isn't a 12-volt system with a negative ground, both vehicles can be damaged.

2. Get the vehicles close enough so the jumper cables can reach, but be sure the vehicles aren't touching each other. If they are, it could cause a ground connection you don't want. You wouldn't be able to start your Corvette, and the bad grounding could damage the electrical systems.
3. Turn off the ignition on both vehicles. Unplug unnecessary accessories plugged into the cigarette lighter or accessory plug. Turn off all lamps that aren't needed as well as radios. This will avoid sparks and help save both batteries. In addition, it could save your radio!

NOTICE:

If you leave your radio on, it could be badly damaged. The repairs wouldn't be covered by your warranty.

4. Open the hoods and locate the batteries. Find the positive (+) and negative (-) terminals on each.



CAUTION:

An electric fan can start up even when the engine is not running and can injure you. Keep hands, clothing and tools away from any underhood electric fan.

 **CAUTION:**

Using a match near a battery can cause battery gas to explode. People have been hurt doing this, and some have been blinded. Use a flashlight if you need more light.

Be sure the battery has enough water. You don't need to add water to the Delco Freedom[®] battery installed in every new GM vehicle. But if a battery has filler caps, be sure the right amount of fluid is there. If it is low, add water to take care of that first. If you don't, explosive gas could be present.

Battery fluid contains acid that can burn you. Don't get it on you. If you accidentally get it in your eyes or on your skin, flush the place with water and get medical help immediately.

5. Check that the jumper cables don't have loose or missing insulation. If they do, you could get a shock. The vehicles could be damaged, too.

Before you connect the cables, here are some basic things you should know. Positive (+) will go to positive (+) and negative (-) will go to an unpainted metal engine part or a body metal surface. Don't connect positive (+) to negative (-) or you will get a short that would damage the battery and maybe other parts, too. And don't connect negative (-) to negative (-) on the dead battery, as this can cause sparks. Follow Step 9 carefully.

 **CAUTION:**

Fans or other moving engine parts can injure you badly. Keep your hands away from moving parts once the engine is running.



6. Positive (+) goes to positive (+) and negative (-) goes to a metal engine part. Connect the red positive (+) cable to the positive (+) terminal of the vehicle with the dead battery. Use a remote positive (+) terminal if the vehicle has one.



7. Don't let the other end touch metal. Connect it to the positive (+) terminal of the good battery. Use a remote positive (+) terminal if the vehicle has one.



8. Now connect the black negative (-) cable to the good battery's negative (-) terminal. Don't let the other end touch anything until the next step.

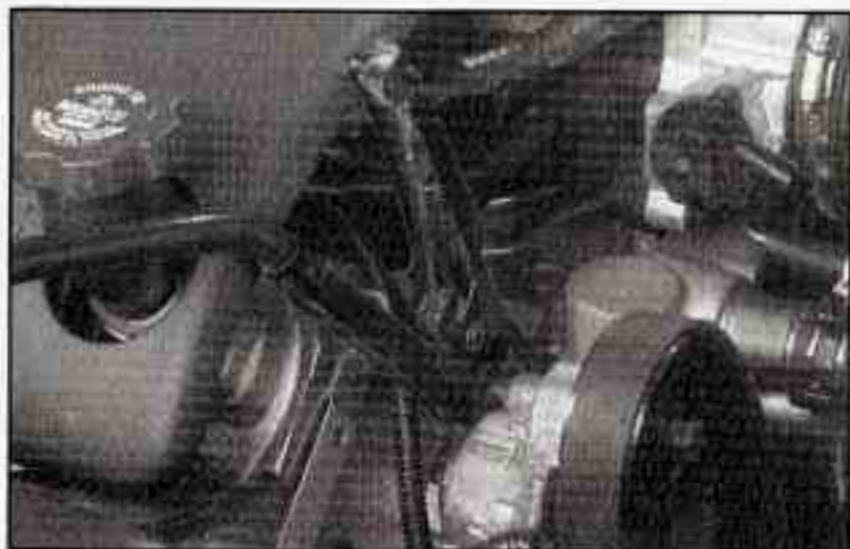

- The other end of the negative (-) cable doesn't go to the dead battery. It goes to a heavy, unpainted metal part on the engine of the vehicle with the dead battery. Attach the cable at least 18 inches (46 cm) away from the dead battery, but not near engine parts that move. The electrical connection is just as good there, but the chance of sparks getting back to the battery is much less.
- Now start the vehicle with the good battery and run the engine for a while.

- Try to start the vehicle with the dead battery. If it won't start after a few tries, it probably needs service.
- Remove the cables in reverse order to prevent electrical shorting. Take care that they don't touch each other or any other metal.

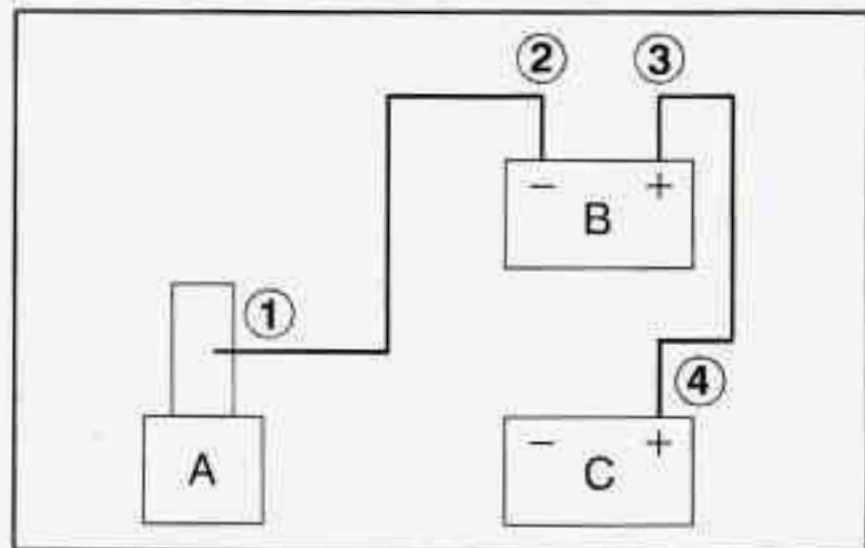

- A. Heavy Metal Engine Part
- B. Good Battery
- C. Dead Battery

Towing Your Vehicle

Try to have a GM dealer or a professional towing service tow your vehicle. They can provide the right equipment and know-how to tow your vehicle without damage.

If your vehicle has been changed or modified since it was factory new by adding aftermarket items like fog lamps, aero skirting, or special tires and wheels, these instructions and illustrations may not be correct.

Before you do anything, turn on the hazard warning flashers.

When you call, tell the towing service:

- That your vehicle cannot be towed with sling-type equipment.
- That your vehicle has rear-wheel drive.
- The make, model and year of your vehicle.
- Whether you can still move the shift lever.

- If there was an accident, what was damaged.
- If the vehicle is to be towed from the rear with a wheel-lift truck, a front dolly will be required.

When the towing service arrives, let the tow operator know that this manual contains detailed towing instructions and illustrations. The operator may want to see them.



 **CAUTION:**

To help avoid injury to you or others:

- Never let passengers ride in a vehicle that is being towed.
- Never tow faster than safe or posted speeds.
- Never tow with damaged parts not fully secured.
- Never get under your vehicle after it has been lifted by the tow truck.
- Always secure the vehicle on each side with separate safety chains when towing it.
- Use only R-hooks.

 **CAUTION:**

A vehicle can fall from a car carrier if it isn't adequately secured. This can cause a collision, serious personal injury and vehicle damage. The vehicle should be tightly secured with chains or steel cables before it is transported.

Don't use substitutes (ropes, leather straps, canvas webbing, etc.) that can be cut by sharp edges underneath the towed vehicle. Always use R-hooks inserted in the front and rear R-hook slots. Never use J-hooks. They will damage drivetrain and suspension components.

When your vehicle is being towed, have the ignition key in the OFF position. The steering wheel should be clamped in a straight-ahead position, with a clamping device designed for towing service. Do not use the vehicle's steering column lock for this. The transmission should be in NEUTRAL (N) and the parking brake released.

Front Towing

Tow Limits -- 35 mph (55 km/h), 50 miles (80 km)

NOTICE:

Do not tow with sling-type equipment or bumper, fog lamps and air dam damage will occur. Use wheel-lift or car-carrier equipment. Additional ramping may be required for car-carrier equipment. Use safety chains and wheel straps. Use the shipping slots for car-carrier securing. Don't have your vehicle towed on the rear wheels unless you have to. If the vehicle must be towed on the rear wheels, don't exceed the tow limits or your transmission will be damaged.

NOTICE: (Continued)

NOTICE: (Continued)

Towing a vehicle over rough surfaces could damage the vehicle. Damage can occur from vehicle to ground or vehicle to wheel-lift equipment. To help avoid damage, install a towing dolly and raise the vehicle until adequate clearance is obtained between the ground and/or wheel-lift equipment.

Do not attach winch cables or J-hooks to suspension components when using car-carrier equipment. Always use R-hooks inserted in the shipping slots.

NOTICE:

When using wheel-lift equipment, front tire to ground clearance distance must be a minimum of 17 inches (43 cm) and a maximum of 22 inches (56 cm) or damage will occur.

Rear Towing

NOTICE:

Do not tow with sling-type equipment or the rear bumper will be damaged. Use wheel-lift or car-carrier equipment. Additional ramping may be required for car-carrier equipment. Use safety chains and wheel straps. Use the shipping slots for car-carrier securing. When using wheel-lift equipment, a towing dolly must be used under the front wheels or vehicle damage will occur. When using wheel-lift equipment, rear tire to ground clearance distance must be a minimum of 13 inches (33 cm) and a maximum of 18 inches (46 cm) or damage will occur.

NOTICE: (Continued)

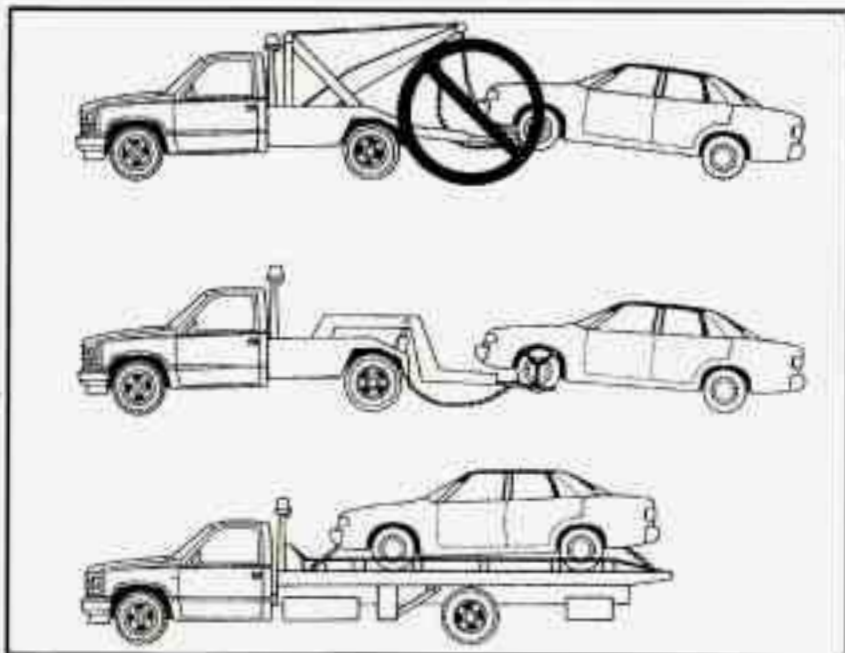

NOTICE: (Continued)

Towing a vehicle over rough surfaces could damage the vehicle. Damage can occur from vehicle to ground or vehicle to wheel-lift equipment. Install a towing dolly and raise the vehicle until adequate clearance is obtained between the ground and/or wheel-lift equipment.

Do not attach winch cables or J-hooks to suspension components when using car-carrier equipment. Always use R-hooks inserted into the shipping slots.

Do not allow chains to contact springs as damage to springs could result.

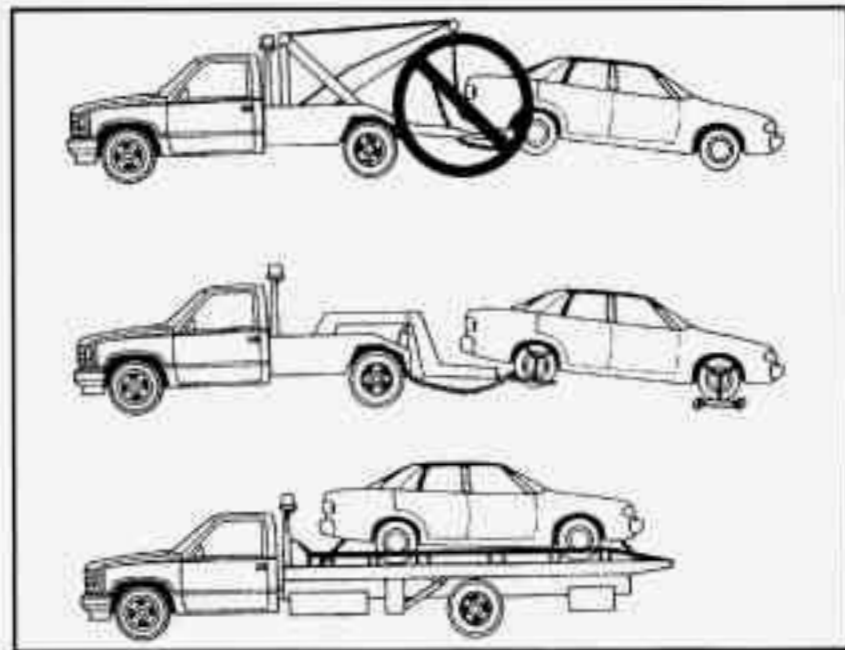
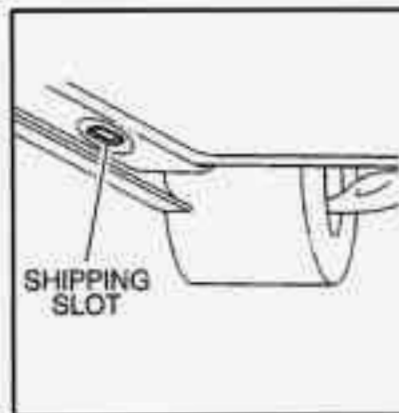

Engine Overheating

You will find an engine coolant temperature gage on the instrument cluster and a COOLANT OVER TEMP message on the Driver Information Center (DIC).

Overheated Engine Protection Operating Mode

Should a low coolant condition exist and the messages COOLANT OVERTEMP and REDUCED ENGINE POWER are displayed, along with the Check Engine light, an overheat protection mode which alternates firing groups of four cylinders helps prevent engine damage. In this mode, you will notice a loss in power and engine performance. This operating mode allows your vehicle to be driven to a safe place in an emergency; you may drive up to 50 miles (80 km).

NOTICE:

After driving in the overheated engine protection operating mode, to avoid engine damage, allow the engine to cool before attempting any repair. The engine oil will be severely degraded. Repair the cause of coolant loss, change the oil and reset the oil life monitor. See “Engine Oil, When to Change” in the Index.

If Steam Is Coming From Your Engine

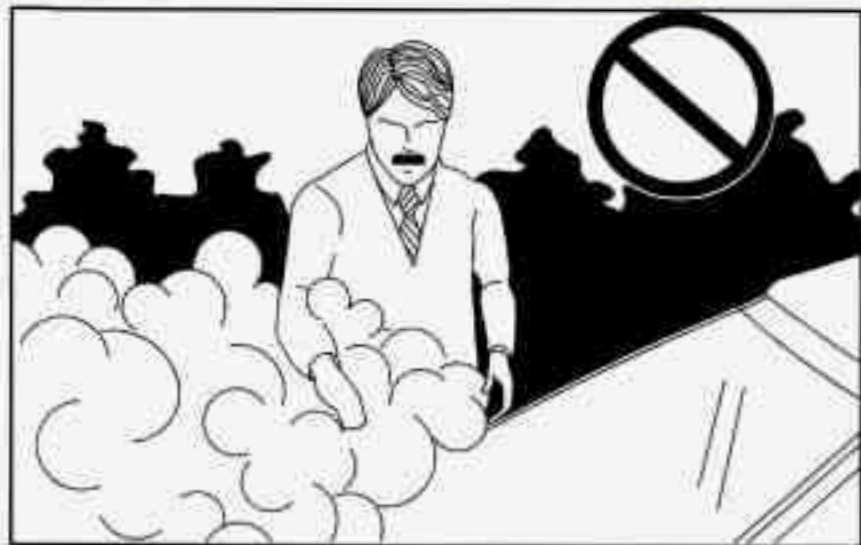

CAUTION:

Steam from an overheated engine can burn you badly, even if you just open the hood. Stay away from the engine if you see or hear steam coming from it. Just turn it off and get everyone away from the vehicle until it cools down. Wait until there is no sign of steam or coolant before you open the hood.

If you keep driving when your engine is overheated, the liquids in it can catch fire. You or others could be badly burned. Stop your engine if it overheats, and get out of the vehicle until the engine is cool.

NOTICE:

If your engine catches fire because you keep driving with no coolant, your vehicle can be badly damaged. The costly repairs would not be covered by your warranty. See “Overheated Engine Protection Operating Mode” in the Index.

If No Steam Is Coming From Your Engine

If you get the overheat warning but see or hear no steam, the problem may not be too serious. Sometimes the engine can get a little too hot when you:

- Climb a long hill on a hot day.
- Stop after high-speed driving.
- Idle for long periods in traffic.

If you get the overheat warning with no sign of steam, try this for a minute or so:

1. Turn off your air conditioner.

2. Turn on your heater to full hot at the highest fan speed and open the window as necessary.
3. If you're in a traffic jam, shift to NEUTRAL (N); otherwise, shift to the highest gear while driving -- AUTOMATIC OVERDRIVE (Ⓢ) or THIRD (3) for automatic transmissions.

If you no longer have the overheat warning, you can drive. Just to be safe, drive slower for about 10 minutes. If the warning doesn't come back on, you can drive normally.

If the warning continues, pull over, stop, and park your vehicle right away.

If there's still no sign of steam, you can idle the engine for two or three minutes while you're parked, to see if the warning stops. But then, if you still have the warning, *turn off the engine and get everyone out of the vehicle until it cools down.* Also, see “Overheated Engine Protection Operating Mode” listed previously in this section.

You may decide not to lift the hood but to get service help right away.

Cooling System

When you decide it's safe to lift the hood, here's what you'll see:

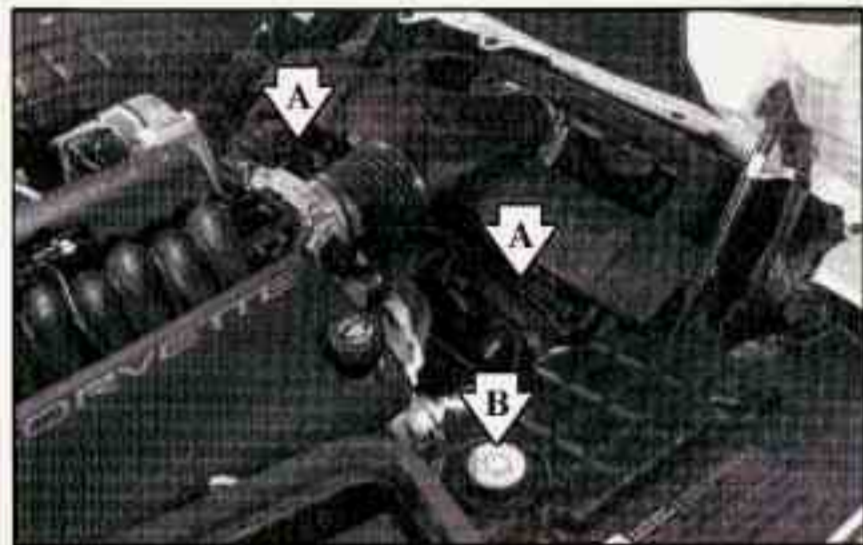

- A. Electric Engine Fans
- B. Coolant Surge Tank

CAUTION:

An electric engine cooling fan under the hood can start up even when the engine is not running and can injure you. Keep hands, clothing and tools away from any underhood electric fan.

If the coolant inside the coolant surge tank is boiling, don't do anything else until it cools down.



The coolant level should be at or above the FULL COLD mark.

If it isn't, you may have a leak in the radiator hoses, heater hoses, radiator, water pump or somewhere else in the cooling system.

 **CAUTION:**

Heater and radiator hoses, and other engine parts, can be very hot. Don't touch them. If you do, you can be burned.

Don't run the engine if there is a leak. If you run the engine, it could lose all coolant. That could cause an engine fire, and you could be burned. Get any leak fixed before you drive the vehicle.

NOTICE:

Engine damage if you keep running your engine without coolant isn't covered by your warranty. See "Overheated Engine Protection Operating Mode" in the Index.

If there seems to be no leak, with the engine on, check to see if the electric engine cooling fans are running. If the engine is overheating, both fans should be running. If they aren't, your vehicle needs service.

How to Add Coolant to the Coolant Surge Tank

If you haven't found a problem yet, but the coolant level isn't at the FULL COLD mark, add a 50/50 mixture of *clean water* (preferably distilled) and DEX-COOL[®] coolant at the coolant surge tank, but be sure the cooling system, including the coolant surge tank pressure cap, is cool before you do it. (See "Engine Coolant" in the Index for more information.)

CAUTION:

Steam and scalding liquids from a hot cooling system can blow out and burn you badly. They are under pressure, and if you turn the coolant surge tank pressure cap -- even a little -- they can come out at high speed. Never turn the cap when the cooling system, including the coolant surge tank pressure cap, is hot. Wait for the cooling system and coolant surge tank pressure cap to cool if you ever have to turn the pressure cap.

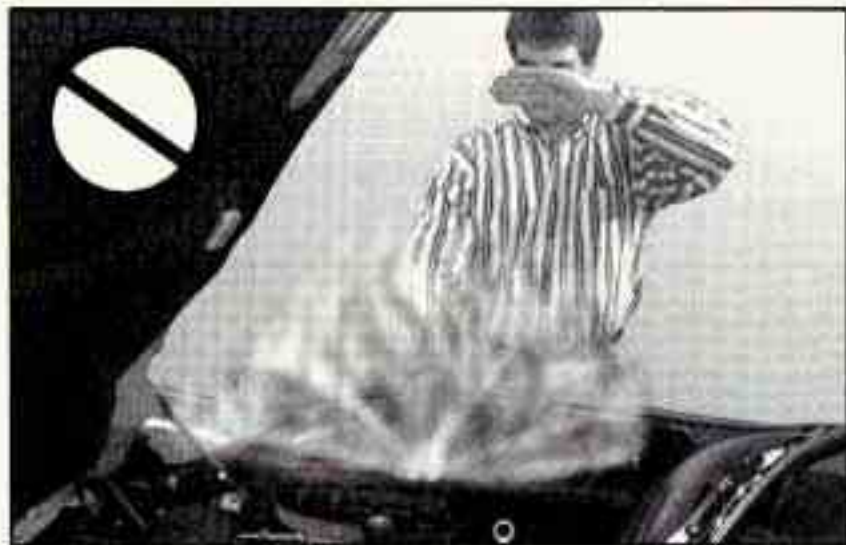

 **CAUTION:**

Adding only plain water to your cooling system can be dangerous. Plain water, or some other liquid like alcohol, can boil before the proper coolant mixture will. Your vehicle's coolant warning system is set for the proper coolant mixture. With plain water or the wrong mixture, your engine could get too hot but you wouldn't get the overheat warning. Your engine could catch fire and you or others could be burned. Use a 50/50 mixture of clean water and DEX-COOL[®] coolant.

NOTICE:

In cold weather, water can freeze and crack the engine, radiator, heater core and other parts. So use the recommended coolant.

 **CAUTION:**

You can be burned if you spill coolant on hot engine parts. Coolant contains ethylene glycol and it will burn if the engine parts are hot enough. Don't spill coolant on a hot engine.



1. You can remove the coolant surge tank pressure cap when the cooling system, including the coolant surge tank pressure cap and upper radiator hose, is no longer hot. Turn the pressure cap slowly about one-quarter turn to the left and then stop.

If you hear a hiss, wait for that to stop. A hiss means there is still some pressure left.

2. Then keep turning the pressure cap slowly, and remove it.

3. Then fill the coolant surge tank with the proper mixture, up to the FULL COLD mark.



4. With the coolant surge tank pressure cap off, start the engine and let it run until you can feel the upper radiator hose getting hot. Watch out for the engine cooling fans.

By this time, the coolant level inside the coolant surge tank may be lower. If the level is lower, add more of the proper mixture to the coolant surge tank until the level reaches the **FULL COLD** mark.

5. Then replace the pressure cap. Be sure the pressure cap is tight.

If a Tire Goes Flat

Your Corvette has neither a spare tire nor tire changing equipment, because it was built with Goodyear Extended Mobility Tires (EMT). See “Extended Mobility Tires” in the Index.

CAUTION:

Because your vehicle has no spare tire, no tire changing equipment, and no provisions to store a tire in the vehicle, special tools and procedures are required if a tire needs to be serviced. If these tools and procedures aren't used, you or others could be injured and your vehicle could be damaged. Always be sure the proper tools and procedures, as described in the GM Corvette Service Manual, are used.

To order a service manual, see “Service and Owner Publications” in the Index.

If You're Stuck: In Sand, Mud, Ice or Snow

What you don't want to do when your vehicle is stuck is to spin your wheels too fast. The method known as “rocking” can help you get out when you're stuck, but you must use caution.

CAUTION:

If you let your tires spin at high speed, they can explode, and you or others could be injured. And, the transmission or other parts of the vehicle can overheat. That could cause an engine compartment fire or other damage. When you're stuck, spin the wheels as little as possible. Don't spin the wheels above 35 mph (55 km/h) as shown on the speedometer.

NOTICE:

Spinning your wheels can destroy parts of your vehicle as well as the tires. If you spin the wheels too fast while shifting your transmission back and forth, you can destroy your transmission.

For information about using tire chains on your vehicle, see "Tire Chains" in the Index.

Rocking Your Vehicle To Get It Out

First, turn your steering wheel left and right. That will clear the area around your front wheels. You should turn your TCS System off. (See "Traction Control System" in the Index.) Then shift back and forth between REVERSE (R) and a forward gear, spinning the wheels as little as possible. For a manual transmission, shift slowly between either FIRST (1) or SECOND (2) and REVERSE (R), allowing the wheels to stop before shifting into gear. Release the accelerator pedal while you shift, and press lightly on the accelerator pedal when the transmission is in gear. If that doesn't get you out after a few tries, you may need to be towed out. If you do need to be towed out, see "Towing Your Vehicle" in the Index.



Section 6 Service and Appearance Care

Here you will find information about the care of your vehicle. This section begins with service and fuel information, and then it shows how to check important fluid and lubricant levels. There is also technical information about your vehicle, and a part devoted to its appearance care.

6-2	Service	6-52	Appearance Care
6-3	Fuel	6-52	Cleaning the Inside of Your Vehicle
6-8	Filling a Portable Fuel Container	6-54	Care of Safety Belts
6-12	Engine Oil	6-54	Cleaning Glass Surfaces
6-16	Air Cleaner	6-55	Weatherstrips
6-18	Automatic Transmission Fluid	6-55	Cleaning a Removable Roof Panel
6-19	Manual Transmission Fluid	6-56	Cleaning the Outside of Your Vehicle
6-20	Hydraulic Clutch	6-57	Cleaning Your Convertible Top
6-21	Rear Axle	6-58	Cleaning Aluminum Wheels
6-22	Engine Coolant	6-58	Cleaning Tires
6-26	Surge Tank Pressure Cap	6-59	Finish Damage
6-26	Power Steering Fluid	6-59	Underbody Maintenance
6-27	Windshield Washer Fluid	6-61	Appearance Care Materials Chart
6-29	Brakes	6-62	Vehicle Identification Number (VIN)
6-32	Battery	6-62	Service Parts Identification Label
6-33	Bulb Replacement	6-62	Electrical System
6-37	Windshield Wiper Blade Replacement	6-69	Replacement Bulbs
6-40	Tires	6-70	Capacities and Specifications

Service

Your dealer knows your vehicle best and wants you to be happy with it. We hope you'll go to your dealer for all your service needs. You'll get genuine GM parts and GM-trained and supported service people.

We hope you'll want to keep your GM vehicle all GM. Genuine GM parts have one of these marks:

ACDelco[®]

Genuine



Goodwrench

Doing Your Own Service Work

If you want to do some of your own service work, you'll want to use the proper Corvette Service Manual. It tells you much more about how to service your vehicle than this manual can. To order the proper service manual, see "Service and Owner Publications" in the Index.

Your vehicle has an air bag system. Before attempting to do your own service work, see "Servicing Your Air Bag-Equipped Vehicle" in the Index.

You should keep a record with all parts receipts and list the mileage and the date of any service work you perform. See "Maintenance Record" in the Index.

CAUTION:

You can be injured and your vehicle could be damaged if you try to do service work on a vehicle without knowing enough about it.

CAUTION: (Continued)

CAUTION: (Continued)

- **Be sure you have sufficient knowledge, experience, the proper replacement parts and tools before you attempt any vehicle maintenance task.**
- **Be sure to use the proper nuts, bolts and other fasteners. “English” and “metric” fasteners can be easily confused. If you use the wrong fasteners, parts can later break or fall off. You could be hurt.**

Adding Equipment to the Outside of Your Vehicle

Things you might add to the outside of your vehicle can affect the airflow around it. This may cause wind noise and affect windshield washer performance. Check with your dealer before adding equipment to the outside of your vehicle.

Fuel

Use premium unleaded gasoline rated at 91 octane or higher for best performance. You may use middle grade or regular unleaded gasolines, but your vehicle may not accelerate as well.

At a minimum, the gasoline you use should meet specifications ASTM D4814 in the United States and CGSB 3.5-M93 in Canada. Improved gasoline specifications have been developed by the American Automobile Manufacturers Association (AAMA) for better vehicle performance and engine protection. Gasolines meeting the AAMA specification could provide improved driveability and emission control system protection compared to other gasolines.

Be sure the posted octane for premium is at least 91 (at least 89 for middle grade and 87 for regular). If the octane is less than 87, you may get a heavy knocking noise when you drive. If it's bad enough, it can damage your engine.

If you're using fuel rated at the recommended octane or higher and you hear heavy knocking, your engine needs service. But don't worry if you hear a little pinging noise when you're accelerating or driving up a hill. That's normal, and you don't have to buy a higher octane fuel to get rid of pinging. It's the heavy, constant knock that means you have a problem.

If your vehicle is certified to meet California Emission Standards (indicated on the underhood emission control label), it is designed to operate on fuels that meet California specifications. If such fuels are not available in states adopting California emissions standards, your

vehicle will operate satisfactorily on fuels meeting federal specifications, but emission control system performance may be affected. The malfunction indicator lamp on your instrument panel may turn on and/or your vehicle may fail a smog-check test. If this occurs, return to your authorized Corvette dealer for diagnosis to determine the cause of failure. In the event it is determined that the cause of the condition is the type of fuels used, repairs may not be covered by your warranty.

Some gasolines that are not reformulated for low emissions contain an octane-enhancing additive called methylcyclopentadienyl manganese tricarbonyl (MMT); ask your service station operator whether or not his fuel contains MMT. General Motors does not recommend the use of such gasolines. If fuels containing MMT are used, spark plug life may be reduced and your emission control system performance may be affected. The malfunction indicator lamp on your instrument panel may turn on. If this occurs, return to your authorized Corvette dealer for service.

To provide cleaner air, all gasolines in the United States are now required to contain additives that will help prevent deposits from forming in your engine and fuel system, allowing your emission control system to function properly. Therefore, you should not have to add anything to the fuel. In addition, gasolines containing

oxygenates, such as ethers and ethanol, and reformulated gasolines may be available in your area to help clean the air. General Motors recommends that you use these gasolines if they comply with the specifications described earlier.

NOTICE:

Your vehicle was not designed for fuel that contains methanol. Don't use it. It can corrode metal parts in your fuel system and also damage plastic and rubber parts. That damage wouldn't be covered under your warranty.

Fuels in Foreign Countries

If you plan on driving in another country outside the United States or Canada, the proper fuel may be hard to find. Never use leaded gasoline or any other fuel not recommended in the previous text on fuel. Costly repairs caused by use of improper fuel wouldn't be covered by your warranty.

To check on fuel availability, ask an auto club, or contact a major oil company that does business in the country where you'll be driving.

You can also write us at the following address for advice. Just tell us where you're going and give your Vehicle Identification Number (VIN).

General Motors Overseas Distribution Corporation
1908 Colonel Sam Drive
Oshawa, Ontario L1H 8P7

Filling Your Tank

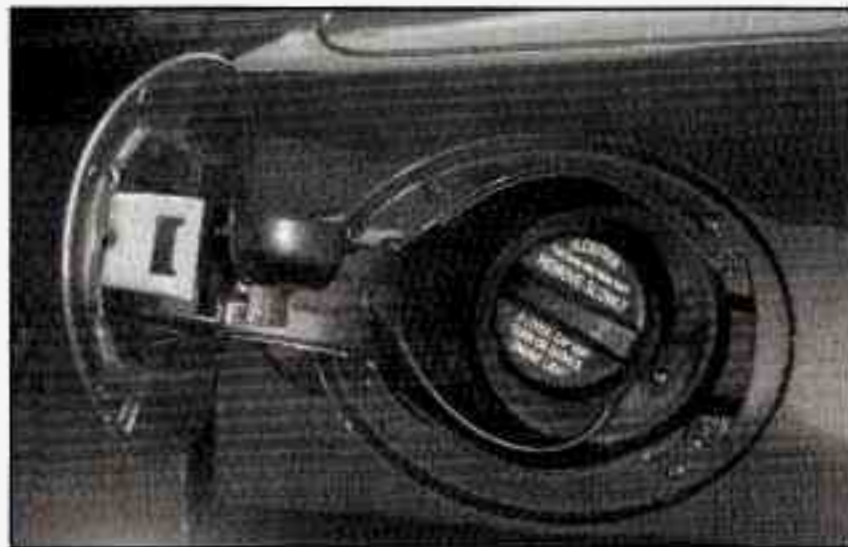

The fuel filler door is on the driver's side of the vehicle. The fuel cap is attached by a tether for your convenience.

CAUTION:

Gasoline vapor is highly flammable. It burns violently, and that can cause very bad injuries. Don't smoke if you're near gasoline or refueling your vehicle. Keep sparks, flames and smoking materials away from gasoline.



The fuel filler door release is the black button at the front of the center console storage compartment.

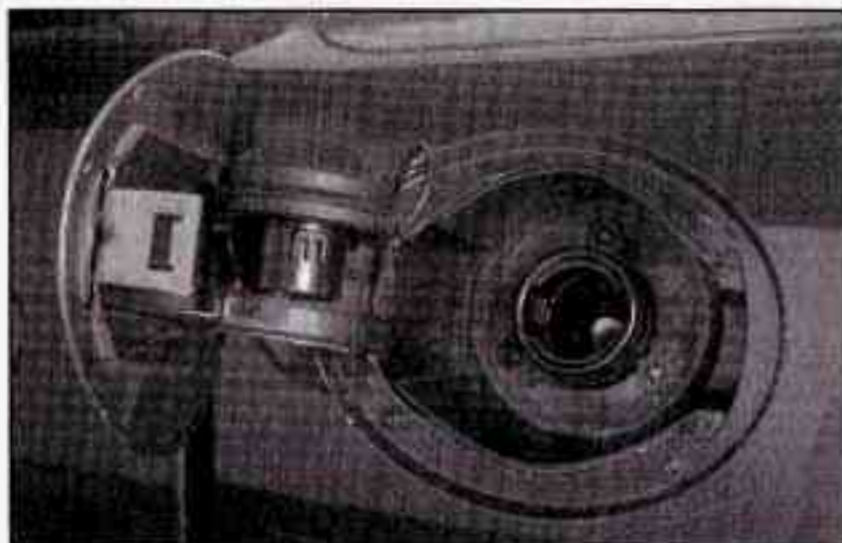

If your fuel filler door release won't operate, there is a manual release tab. The tab is located against the upper trim on the driver's side in the rear compartment.

While refueling, place the cap in the holder on the fuel filler door to prevent damage to your vehicle's finish.

To remove the cap, turn it slowly to the left (counterclockwise). The cap has a spring in it; if you let go of the cap too soon, it will spring back to the right.



CAUTION:

If you get gasoline on yourself and then something ignites it, you could be badly burned. Gasoline can spray out on you if you open the fuel filler cap too quickly. This spray can happen if your tank is nearly full, and is more likely in hot weather. Open the fuel filler cap slowly and wait for any “hiss” noise to stop. Then unscrew the cap all the way.

Be careful not to spill gasoline. Clean gasoline from painted surfaces as soon as possible. See “Cleaning the Outside of Your Vehicle” in the Index.

When you put the cap back on, turn it to the right (clockwise) until you hear a clicking sound. Make sure you fully install the cap.

NOTICE:

If you need a new cap, be sure to get the right type. Your dealer can get one for you. If you get the wrong type, it may not fit or have proper venting, and your fuel tank and emissions system might be damaged.

Filling a Portable Fuel Container

CAUTION:

Never fill a portable fuel container while it is in your vehicle. Static electricity discharge from the container can ignite the gasoline vapor. You can be badly burned and your vehicle damaged if this occurs. To help avoid injury to you and others:

- Dispense gasoline only into approved containers.
- Do not fill a container while it is inside a vehicle, in a vehicle's trunk, pickup bed or on any surface other than the ground.
- Bring the fill nozzle in contact with the inside of the fill opening before operating the nozzle. Contact should be maintained until the filling is complete.
- Don't smoke while pumping gasoline.

Checking Things Under the Hood

CAUTION:

An electric fan under the hood can start up and injure you even when the engine is not running. Keep hands, clothing and tools away from any underhood electric fan.

CAUTION:

Things that burn can get on hot engine parts and start a fire. These include liquids like gasoline, oil, coolant, brake fluid, windshield washer and other fluids, and plastic or rubber. You or others could be burned. Be careful not to drop or spill things that will burn onto a hot engine.

Hood Release

NOTICE:

In order to avoid possible contact of the hood to the headlamp doors, care should be taken in raising the hood with the headlamps up, or shut off the lamps prior to opening the hood.

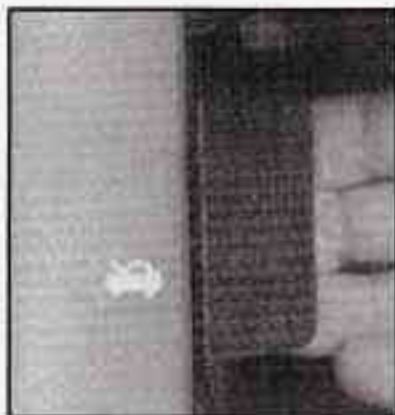

To open the hood, first pull the handle inside the vehicle.



Then go to the side of the vehicle and pull up on the rear edge of the hood, near the windshield.

You'll see the following when you open the hood:

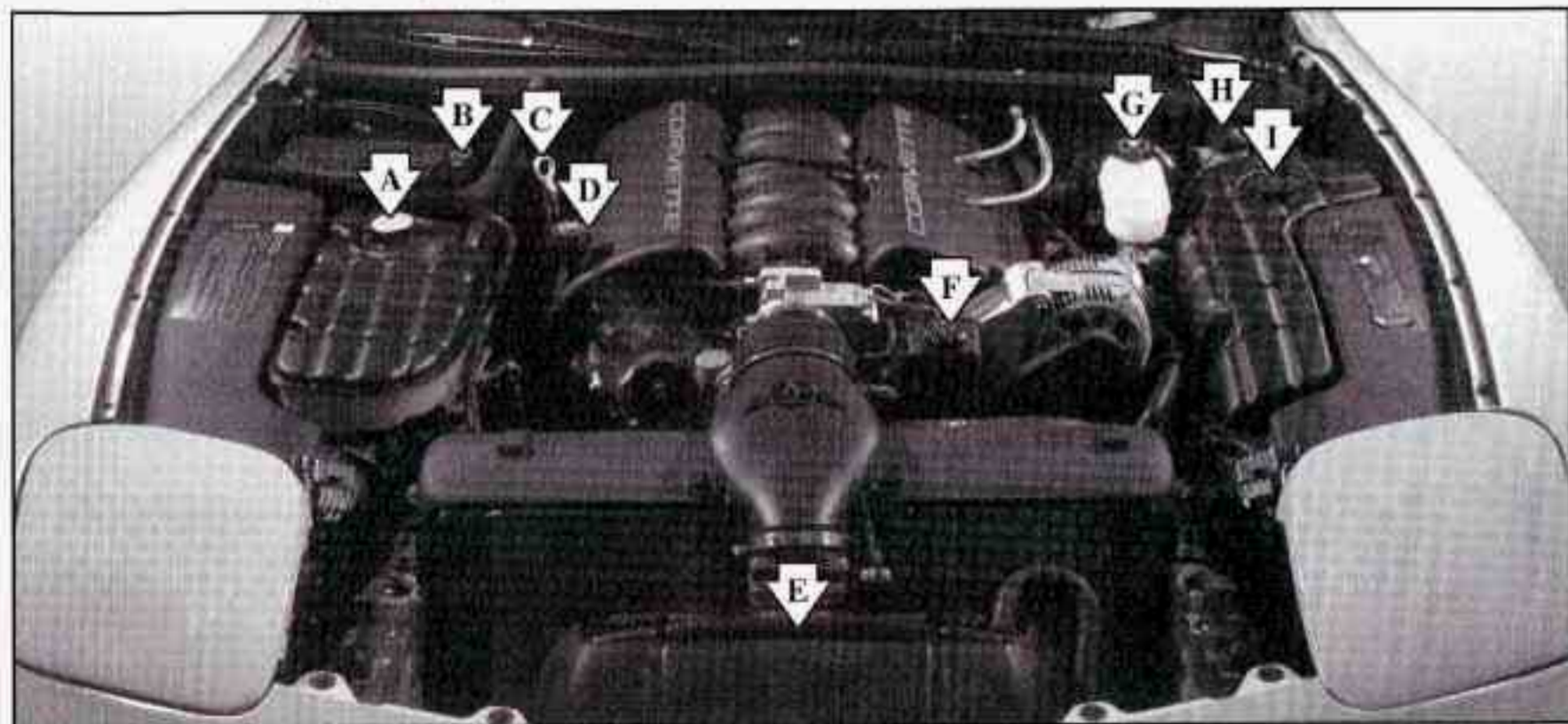

- A. Coolant Surge Tank and Pressure Cap
- B. Battery
- C. Engine Oil Dipstick
- D. Engine Oil Fill Cap
- E. Air Cleaner

- F. Power Steering Fluid Reservoir
- G. Brake Fluid Reservoir
- H. Hydraulic Clutch Fluid Reservoir (If Equipped)
- I. Windshield Washer Fluid Reservoir

Before closing the hood, be sure all the filler caps are on properly. Then, just pull the hood down and close it firmly.

Engine Oil

If the LOW OIL LEVEL message on the Driver Information Center comes on, it means you need to check your engine oil level right away. For more information, see "Driver Information Center" in the Index. You should check your engine oil level regularly; this is an added reminder.

It's a good idea to check your engine oil level every time you get fuel. In order to get an accurate reading, the oil must be warm and the vehicle must be on level ground.



The engine oil dipstick is next to the coolant surge tank. The dipstick handle is a round, yellow loop.

Turn off the engine and give the oil a few minutes to drain back into the oil pan. If you don't, the oil dipstick might not show the actual level.

Checking Engine Oil

Pull out the dipstick and clean it with a paper towel or a cloth, then push it back in all the way. Remove it again, keeping the tip down.

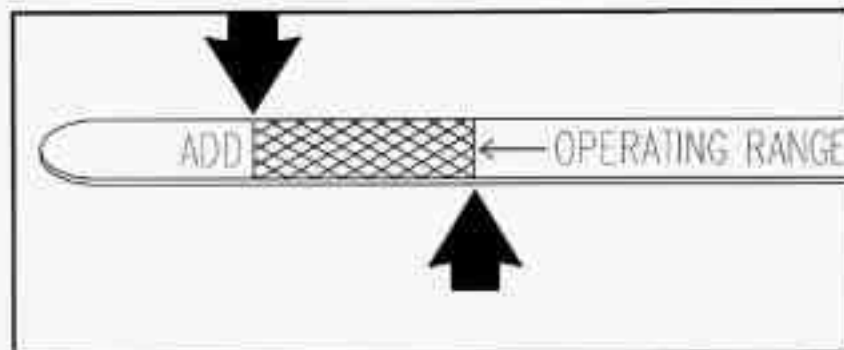

When to Add Engine Oil

If the oil is at or below the ADD mark, you'll need to add at least one quart of oil. But you must use the right kind. This part explains what kind of oil to use. For crankcase capacity, see "Capacities and Specifications" in the Index.

NOTICE:

Don't add too much oil. If your engine has so much oil that the oil level gets above the upper mark that shows the proper operating range, your engine could be damaged.



The engine oil fill cap is on top of the right valve rocker arm cover.

Be sure to fill it enough to put the level somewhere in the proper operating range. Push the dipstick all the way back in when you're through.

What Kind of Engine Oil to Use

Look for two things:

- GM4718M

The Corvette engine requires a special oil meeting GM Standard GM4718M. Oils meeting this Standard may be identified as synthetic. However, not all *synthetic* oils will meet this GM Standard. You should look for and use only an oil that meets GM Standard GM4718M.

NOTICE:

If you use oils that don't have the GM4718M Standard designation, you can cause engine damage not covered by your warranty.

RECOMMENDED SAE VISCOSITY GRADE ENGINE OILS

FOR BEST FUEL ECONOMY AND COLD STARTING, SELECT THE LOWEST SAE VISCOSITY GRADE OIL FOR THE EXPECTED TEMPERATURE RANGE.

**HOT
WEATHER**



**COLD
WEATHER**

**LOOK
FOR THIS
SYMBOL**



DO NOT USE SAE 20W-50 OR ANY OTHER GRADE OIL NOT RECOMMENDED

- **SAE 5W-30**

As shown in the viscosity chart, SAE 5W-30 is best for your vehicle. However, you can use SAE 10W-30 if it's going to be 0°F (-18°C) or above.

These numbers on an oil container show its viscosity, or thickness. Do not use other viscosity oils such as SAE 20W-50.



Oils meeting these requirements should also have the "Starburst" symbol on the container.

This symbol indicates that the oil has been certified by the American Petroleum Institute (API). Do not use any oil which does not carry this Starburst symbol.

You should look for this on the oil container, and use *only* those oils that are identified as meeting GM Standard 4718M and have the Starburst symbol on the front of the oil container.

Your Corvette engine is filled at the factory with a Mobil 1[®] synthetic oil, which meets all requirements for your vehicle.

Substitute Engine Oil: When adding oil to maintain engine oil level, oil meeting GM Standard GM4718M may not be available. You can add substitute oil designated SAE 5W-30 with the “Starburst” symbol at all temperatures. If temperatures are above 0°F (-18°C), you may substitute SAE 10W-30 with the “Starburst” symbol. Substitute oil not meeting GM Standard GM4718M should not be used for an oil change.

Engine Oil Additives

Don't add anything to your oil. Your dealer is ready to advise if you think something should be added.

When to Change Engine Oil

Your Corvette has an Engine Oil Life Monitor. This feature will let you know when to change your oil and filter -- usually between 3,000 miles (5 000 km) and 10,000 miles (16 000 km) since your last oil change.

Under severe conditions, the indicator may come on before 3,000 miles (5 000 km). Never drive your vehicle more than 10,000 miles (16 000 km) or 12 months (whichever occurs first) without an oil change. Use engine oil meeting the GM Standard GM4718M.

The system won't detect dust in the oil. So, if you drive in a dusty area, be sure to change your oil every 3,000 miles (5 000 km) or sooner if the CHANGE OIL light comes on. Remember to reset the Engine Oil Life Monitor when the oil has been changed. For more information, see “Engine Oil Life Monitor” in the Index.

When Changing the Engine Oil

There is a special procedure for changing engine oil, contact your dealer for additional information or the procedure can be found in a Corvette Service Manual. To purchase a service manual, see “Service and Owner Publications” in the Index.

How to Reset the Engine Oil Life Monitor

Press RESET to acknowledge the CHANGE OIL SOON warning. The oil page will then show a message such as OIL LIFE 0%. To reset the monitor, press and hold RESET for two seconds. You will then receive a message such as OIL LIFE 99%.

What to Do with Used Oil

Did you know that used engine oil contains certain elements that may be unhealthy for your skin and could even cause cancer? Don't let used oil stay on your skin for very long. Clean your skin and nails with soap and water, or a good hand cleaner. Wash or throw away clothing or rags containing used engine oil. (See the manufacturer's warnings about the use and disposal of oil products.)

Used oil can be a real threat to the environment. If you change your own oil, be sure to drain all free-flowing oil from the filter before disposal. Don't ever dispose of oil by putting it in the trash, pouring it on the ground, into sewers, or into streams or bodies of water. Instead, recycle it by taking it to a place that collects used oil. If you have a problem properly disposing of your used oil, ask your dealer, a service station or a local recycling center for help.

Air Cleaner

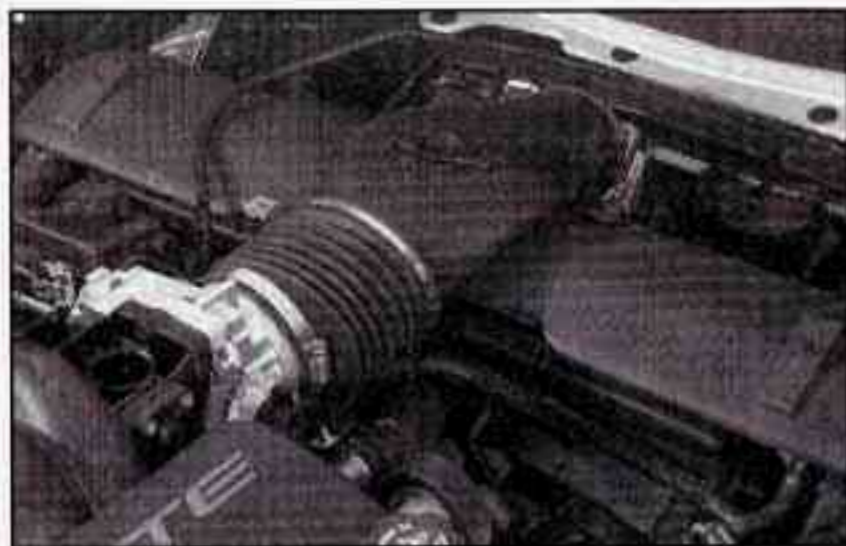

Refer to the Maintenance Schedule to determine when to replace the air filter.

See "Scheduled Maintenance Services" in the Index.

⚠ CAUTION:

Operating the engine with the air cleaner off can cause you or others to be burned. The air cleaner not only cleans the air, it stops flame if the engine backfires. If it isn't there, and the engine backfires, you could be burned. Don't drive with it off, and be careful working on the engine with the air cleaner off.

NOTICE:

If the air cleaner is off, a backfire can cause a damaging engine fire. And, dirt can easily get into your engine, which will damage it. Always have the air cleaner in place when you're driving.

Air Filter Replacement

To remove the air filter:

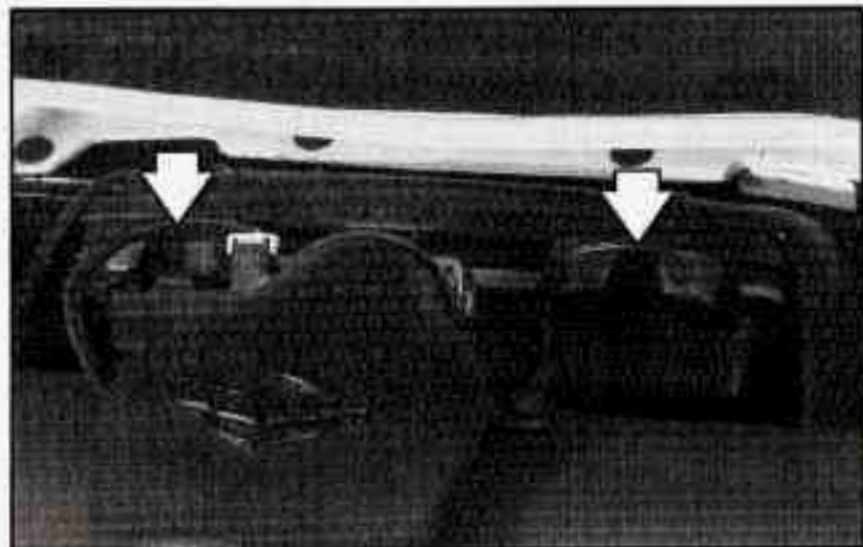

1. Pull up on the clips on each side to release the assembly.



2. Pull the assembly out.
3. Replace the filter.
4. Push the assembly back into place.
5. Fasten the clips.

Automatic Transmission Fluid

How to Check

Because this operation is difficult, you may choose to have this done at your dealer service department. It is not necessary to check the transmission fluid level. A transmission fluid leak is the only reason for fluid loss. If a leak occurs, take the vehicle to your dealer service department and have it repaired as soon as possible.

There is a special procedure for checking and changing the transmission fluid. Contact your dealer for additional information or the procedure can be found in a Corvette Service Manual. To purchase a service manual, see "Service and Owner Publications" in the Index.

NOTICE:

We recommend that only fluid labeled DEXRON[®]-III be used, because fluid with that label is made specially for your automatic transmission. Damage caused by fluid other than DEXRON[®]-III is not covered by your new vehicle warranty.

Change both the fluid and filter every 50,000 miles (80 000 km) if the vehicle is mainly driven under one of these conditions:

- In heavy city traffic where the outside temperature regularly reaches 90°F (32°C) or higher.
- In hilly or mountainous terrain.
- High performance operation.

If you do not use your vehicle under one of these conditions. Change the fluid and filter every 100,000 miles (166 000 km).

See “Scheduled Maintenance Services” in the Index for the proper service intervals for the transmission fluid and filter.

Manual Transmission Fluid

When to Check

A good time to have it checked is when the engine oil is changed. However, the fluid in your manual transmission doesn't require changing.

How to Check

Because this operation can be difficult, you may choose to have this done at your Chevrolet dealership Service Department.

If you do it yourself, be sure to follow all the instructions here, or you could get a false reading.

NOTICE:

Too much or too little fluid can damage your transmission. Too much can mean that some of the fluid could come out and fall on hot exhaust system parts, starting a fire. Be sure to get an accurate reading if you check your transmission fluid.

Check the fluid level only when your engine is off, the vehicle is parked on a level place and the transmission is cool enough for you to rest your fingers on the transmission case.

Then, follow these steps:

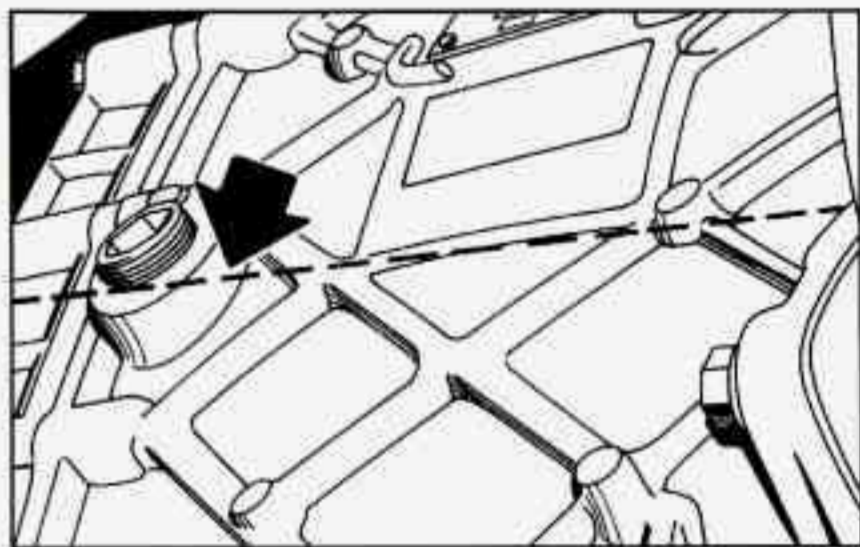

1. Remove the filler plug.
2. Check that the lubricant level is up to the bottom of the filler plug hole.
3. If the fluid level is good, install the plug and be sure it is fully seated. If the fluid level is low, add more fluid as described in the next steps.

How to Add Fluid

Here's how to add fluid. Refer to the Maintenance Schedule to determine what kind of fluid to use. See "Recommended Fluids and Lubricants" in the Index.

1. Remove the filler plug.
2. Add fluid at the filler plug hole. Add only enough fluid to bring the fluid level up to the bottom of the filler plug hole.
3. Install the filler plug. Be sure the plug is fully seated.
4. Tighten the plug to 20 lb.-ft. (27 N·m).

Hydraulic Clutch

The clutch linkage in your vehicle is self-adjusting. The clutch master cylinder reservoir is filled with hydraulic clutch fluid.

It is not necessary to regularly check clutch fluid unless you suspect there is a leak in the system. Adding fluid won't correct a leak.

A fluid loss in this system could indicate a problem. Have the system inspected and repaired.

When to Check and What to Use



Refer to the Maintenance Schedule to determine how often you should check the fluid level in your clutch master cylinder reservoir and for the proper fluid. See “Owner Checks and Services” and “Recommended Fluids and Lubricants” in the Index.

How To Check and Add Fluid

The clutch master cylinder is on the driver’s side of the engine compartment, near the fender.

To check the fluid, remove the cap and rubber seal.



Fluid should be added if the fluid level is below the step on the inside of the reservoir. There are additional instructions on the reservoir cap.

Replace the rubber seal and cap.

Rear Axle

When to Check Lubricant

Refer to the Maintenance Schedule to determine how often to check the lubricant. See “Periodic Maintenance Inspections” in the Index.

How to Check Lubricant

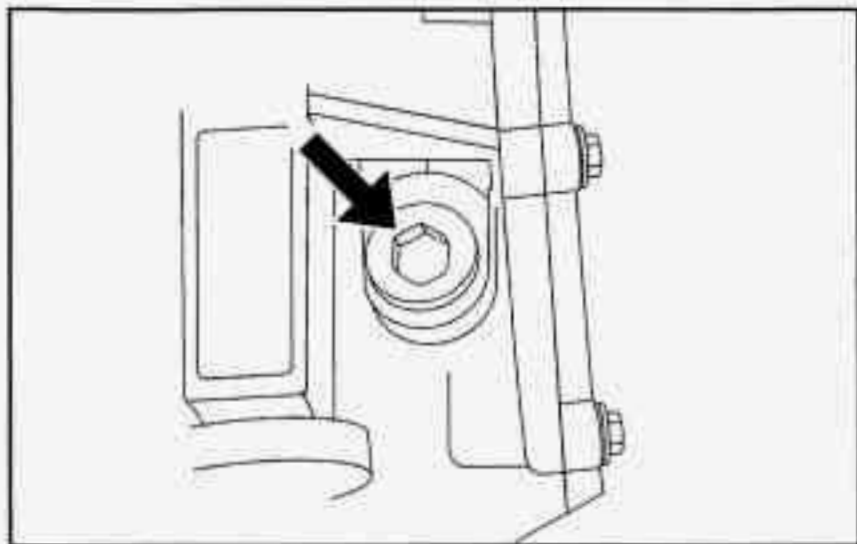

If the level is below the bottom of the filler plug hole, you'll need to add some lubricant. Add enough lubricant to raise the level to the bottom of the filler plug hole.

What to Use

To add lubricant when the level is low, use Axle Lubricant (GM Part No. 12345977) or SAE 80W-90 GL-5 gear lubricant. To completely refill after draining, add 4 ounces (118 ml) of Limited-Slip Differential Lubricant Additive (GM Part No. 1052358). Then fill to

the bottom of the filler plug hole with Axle Lubricant (GM Part No. 12345977) or SAE 80W-90 GL-5 gear lubricant.

Engine Coolant

The cooling system in your vehicle is filled with DEX-COOL[®] engine coolant. This coolant is designed to remain in your vehicle for 5 years or 150,000 miles (240 000 km), whichever occurs first, if you add only DEX-COOL[®] extended life coolant.

The following explains your cooling system and how to add coolant when it is low. If you have a problem with engine overheating, see "Engine Overheating" in the Index.

A 50/50 mixture of water and DEX-COOL[®] coolant will:

- Give freezing protection down to -34°F (-37°C).
- Give boiling protection up to 265°F (129°C).
- Protect against rust and corrosion.
- Help keep the proper engine temperature.
- Let the warning lights and gauges work as they should.

NOTICE:

When adding coolant, it is important that you use only DEX-COOL[®] (silicate-free) coolant.

If coolant other than DEX-COOL is added to the system, premature engine, heater core or radiator corrosion may result. In addition, the engine coolant will require change sooner -- at 30,000 miles (50 000 km) or 24 months, whichever occurs first. Damage caused by the use of coolant other than DEX-COOL[®] is not covered by your new vehicle warranty.

What to Use

Use a mixture of one-half *clean water* (preferably distilled) and one-half DEX-COOL[®] coolant which won't damage aluminum parts. If you use this mixture, you don't need to add anything else.



CAUTION:

Adding only plain water to your cooling system can be dangerous. Plain water, or some other liquid like alcohol, can boil before the proper coolant mixture will. Your vehicle's coolant warning system is set for the proper coolant mixture. With plain water or the wrong mixture, your engine could get too hot but you wouldn't get the overheat warning. Your engine could catch fire and you or others could be burned. Use a 50/50 mixture of clean water and DEX-COOL[®] coolant.

NOTICE:

If you use an improper coolant mixture, your engine could overheat and be badly damaged. The repair cost wouldn't be covered by your warranty. Too much water in the mixture can freeze and crack the engine, radiator, heater core and other parts.

If you have to add coolant more than four times a year, have your dealer check your cooling system.

NOTICE:

If you use the proper coolant, you don't have to add extra inhibitors or additives which claim to improve the system. These can be harmful.

Checking Coolant



The coolant surge tank is in the engine compartment behind the headlamp.

 **CAUTION:**

Turning the surge tank pressure cap when the engine and radiator are hot can allow steam and scalding liquids to blow out and burn you badly. Never turn the surge tank pressure cap -- even a little -- when the engine and radiator are hot.

When your engine is cold, the coolant level should be at the FULL COLD mark. Don't overfill the surge tank. Too much coolant can result in an overflow when the fluid is hot.

If the LOW COOLANT message comes on, it means you're low on engine coolant.

Adding Coolant

If you need more coolant, add the proper DEX-COOL[®] coolant mixture *at the surge tank*, but only when the engine is cool.

 **CAUTION:**

You can be burned if you spill coolant on hot engine parts. Coolant contains ethylene glycol, and it will burn if the engine parts are hot enough. Don't spill coolant on a hot engine.

When replacing the pressure cap, make sure it is tight.

Surge Tank Pressure Cap

NOTICE:

The surge tank pressure cap is a 15 psi (105 kPa) pressure-type cap and must be tightly installed to prevent coolant loss and possible engine damage from overheating.

When you replace the surge tank pressure cap, a GM cap is recommended.

Thermostat

Engine coolant temperature is controlled by a thermostat in the engine coolant system. The thermostat stops the flow of coolant through the radiator until the coolant reaches a pre-set temperature.

When you replace the thermostat, a GM thermostat is recommended.

Power Steering Fluid



When to Check Power Steering Fluid

It is not necessary to regularly check power steering fluid unless you suspect there is a leak in the system or you hear an unusual noise. A fluid loss in this system could indicate a problem. Have the system inspected and repaired.

How To Check Power Steering Fluid

When the engine compartment is cool, wipe the cap and the top of the reservoir clean, then unscrew the cap and wipe the dipstick with a clean rag. Replace the cap and completely tighten it. Then remove the cap again and look at the fluid level on the dipstick.

The level should be at the FULL COLD mark. If necessary, add only enough fluid to bring the level up to the mark.

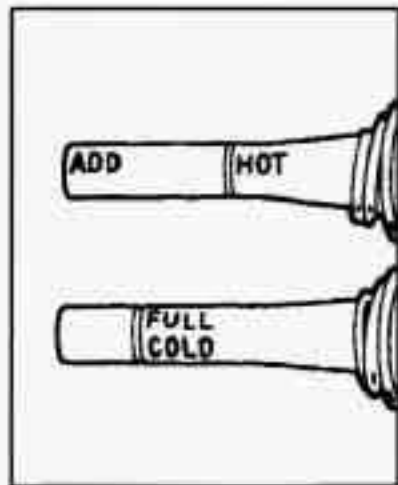

- When the engine compartment is hot, the level should be at the HOT mark.
- When the engine compartment is cool, the level should be at the FULL COLD mark.

What to Use

To determine what kind of fluid to use, see "Recommended Fluids and Lubricants" in the Index. Always use the proper fluid. Failure to use the proper fluid can cause leaks and damage hoses and seals.

Windshield Washer Fluid

What to Use

When you need windshield washer fluid, be sure to read the manufacturer's instructions before use. If you will be operating your vehicle in an area where the temperature may fall below freezing, use a fluid that has sufficient protection against freezing.

Adding Washer Fluid



Open the cap labeled **WASHER FLUID ONLY**. Add washer fluid until the tank is full.

NOTICE:

- When using concentrated washer fluid, follow the manufacturer's instructions for adding water.
- Don't mix water with ready-to-use washer fluid. Water can cause the solution to freeze and damage your washer fluid tank and other parts of the washer system. Also, water doesn't clean as well as washer fluid.
- Fill your washer fluid tank only three-quarters full when it's very cold. This allows for expansion if freezing occurs, which could damage the tank if it is completely full.
- Don't use engine coolant (antifreeze) in your windshield washer. It can damage your washer system and paint.

Brakes

Brake Fluid



Your brake master cylinder reservoir is here. It is filled with DOT-3 brake fluid.

There are only two reasons why the brake fluid level in the reservoir might go down. The first is that the brake fluid goes down to an acceptable level during normal brake lining wear. When new linings are put in, the fluid level

goes back up. The other reason is that fluid is leaking out of the brake system. If it is, you should have your brake system fixed, since a leak means that sooner or later your brakes won't work well, or won't work at all.

So, it isn't a good idea to "top off" your brake fluid. Adding brake fluid won't correct a leak. If you add fluid when your linings are worn, then you'll have too much fluid when you get new brake linings. You should add (or remove) brake fluid, as necessary, only when work is done on the brake hydraulic system.

CAUTION:

If you have too much brake fluid, it can spill on the engine. The fluid will burn if the engine is hot enough. You or others could be burned, and your vehicle could be damaged. Add brake fluid only when work is done on the brake hydraulic system.

Refer to the Maintenance Schedule to determine when to check your brake fluid. See "Periodic Maintenance Inspections" in the Index.

Checking Brake Fluid

You can check the brake fluid without taking off the cap. Just look at the brake fluid reservoir. The fluid level should be above the MIN mark on the reservoir. If it isn't, have your brake system checked to see if there is a leak.

After work is done on the brake hydraulic system, make sure the level is between the MIN and MAX marks.

What to Add

When you do need brake fluid, use only DOT-3 brake fluid -- such as Delco Supreme 11[®] (GM Part No. 12377967). Use new brake fluid from a sealed container only.

Always clean the brake fluid reservoir cap and the area around the cap before removing it. This will help keep dirt from entering the reservoir.



CAUTION:

With the wrong kind of fluid in your brake system, your brakes may not work well, or they may not even work at all. This could cause a crash. Always use the proper brake fluid.

NOTICE:

- **Using the wrong fluid can badly damage brake system parts. For example, just a few drops of mineral-based oil, such as engine oil, in your brake system can damage brake system parts so badly that they'll have to be replaced. Don't let someone put in the wrong kind of fluid.**
- **If you spill brake fluid on your vehicle's painted surfaces, the paint finish can be damaged. Be careful not to spill brake fluid on your vehicle. If you do, wash it off immediately. See "Appearance Care" in the Index.**

Brake Wear

Your vehicle has four-wheel disc brakes.

Disc brake pads have built-in wear indicators that make a high-pitched warning sound when the brake pads are worn and new pads are needed. The sound may come and go or be heard all the time your vehicle is moving (except when you are pushing on the brake pedal firmly).

CAUTION:

The brake wear warning sound means that soon your brakes won't work well. That could lead to an accident. When you hear the brake wear warning sound, have your vehicle serviced.

NOTICE:

Continuing to drive with worn-out brake pads could result in costly brake repair.

Some driving conditions or climates may cause a brake squeal when the brakes are first applied or lightly applied. This does not mean something is wrong with your brakes.

Brake linings should always be replaced as complete axle sets.

See "Brake System Inspection" in Section 7 of this manual under Part C "Periodic Maintenance Inspections."

Brake Pedal Travel

See your dealer if the brake pedal does not return to normal height, or if there is a rapid increase in pedal travel. This could be a sign of brake trouble.

Brake Adjustment

As you make brake stops, your disc brakes automatically adjust for wear.

Replacing Brake System Parts

The braking system on a modern vehicle is complex. Its many parts have to be of top quality and work well together if the vehicle is to have really good braking. Your vehicle was designed and tested with top-quality GM brake parts. When you replace parts of your braking system -- for example, when your brake linings wear down and you have to have new ones put in -- be sure you get new approved GM replacement parts. If you don't, your brakes may no longer work properly. For example, if someone puts in brake linings that are wrong for your vehicle, the balance between your front and rear brakes can change -- for the worse. The braking performance you've come to expect can change in many other ways if someone puts in the wrong replacement brake parts.

Battery

Every new Corvette has a Delco Freedom[®] battery. You never have to add water to one of these. When it's time for a new battery, we recommend a Delco Freedom battery. Get one that has the replacement number shown on the original battery's label. For battery replacement, see your dealer or the Corvette Service Manual. To purchase a service manual, see "Service and Owner

Publications" in the Index. After the battery has been replaced, refer to the "Remote Function Actuation System" in the Index to resynchronize your transmitter(s).

Vehicle Storage

If you're not going to drive your vehicle for 25 days or more, remove the black, negative (-) cable from the battery. This will help keep your battery from running down.

CAUTION:

Batteries have acid that can burn you and gas that can explode. You can be badly hurt if you aren't careful. See "Jump Starting" in the Index for tips on working around a battery without getting hurt.

Contact your dealer to learn how to prepare your vehicle for longer storage periods.

Also, for your audio system, see "Theft-Deterrent Feature" in the Index.

Bulb Replacement

For the proper type of replacement bulb, see “Replacement Bulbs” in the Index.

Halogen Bulbs

CAUTION:

Halogen bulbs have pressurized gas inside and can burst if you drop or scratch the bulb. You or others could be injured. Be sure to read and follow the instructions on the bulb package.

Headlamps/Highbeam

1. The headlamps need to be halfway open. Turn the headlamp switch on, then quickly back to the parking lamps setting. You may have to do this a few times to get the half-open position.



2. You can also open the headlamps manually by turning the adjuster to the left.

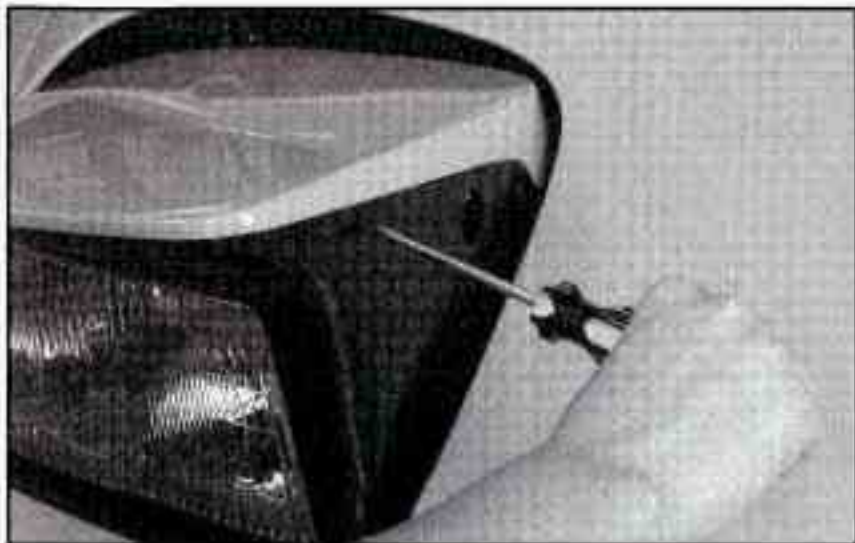

3. Remove the screws on each side of the headlamp bezel.
4. Open the hood.
5. To remove the bezel, pull the sides slightly outward and tilt the bezel forward. Pull the clip centered above the lens outward. Be careful not to scratch the paint.

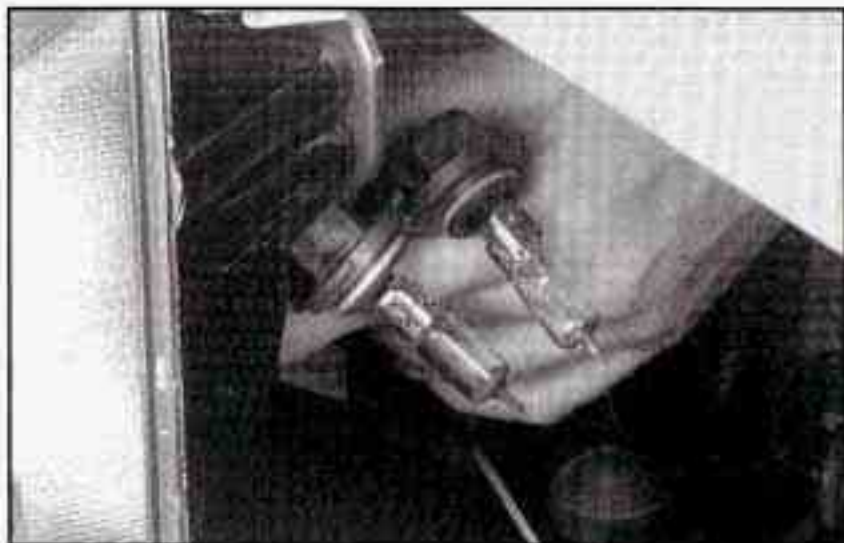

6. Reach behind the lamp and turn the bulb to the left (counterclockwise) to remove it. Don't touch the halogen bulbs. The inner bulb is the high beam and the outer bulb is the low beam.
7. Disconnect the desired bulb from the wiring harness.
8. Reverse the steps with a new bulb.

Front Turn Signal Lamps

1. Remove the front fascia close out panel attaching bolts.
2. Remove the front fascia close out panel.
3. Grasp the cooling duct and pull to release it from the front fascia, then reposition it. This will give you better access to the bulb.
4. Squeeze the tab on the socket and turn it to the left (counterclockwise) to remove the socket with the bulb.
5. Remove the bulb from the socket.
6. Reverse the steps with a new bulb.

Front Sidemarkers Lamps

1. Follow Steps 1 through 3 in "Front Turn Signal Lamps" described previously.
2. Turn the socket one-quarter of a turn to the left and pull it out.
3. Pull the bulb straight out of the socket.
4. Reverse the steps with a new bulb.

Rear Turn Signal and Taillamps

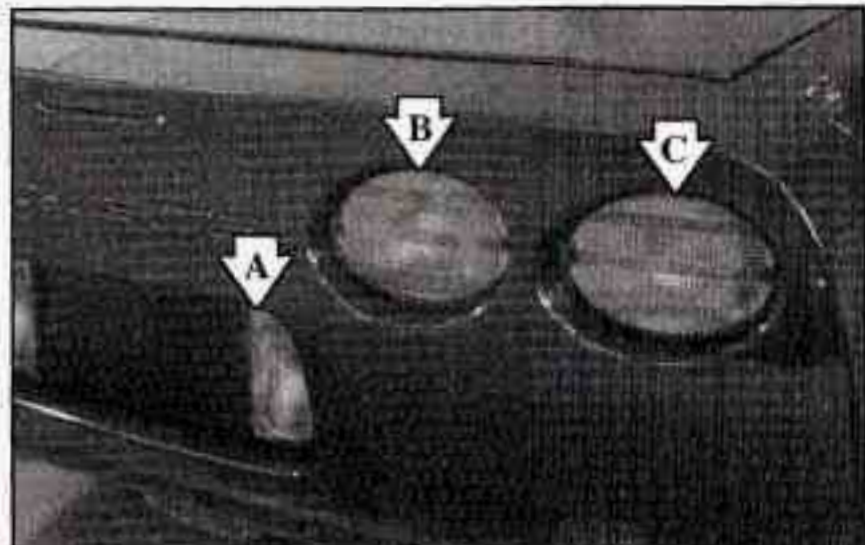

- A. Back-up Lamp
- B. Inboard Taillamp
- C. Outboard Taillamp

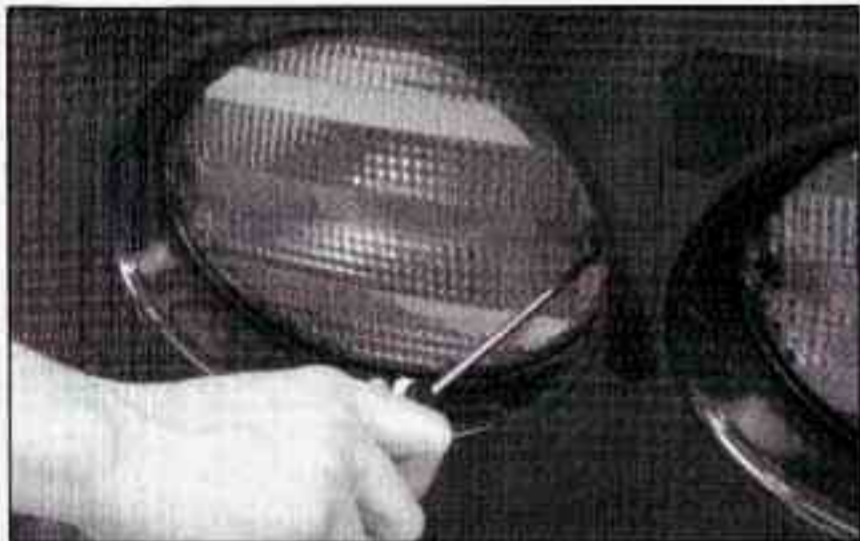

1. Remove the screws.
2. Pull the taillamp housing assembly out.

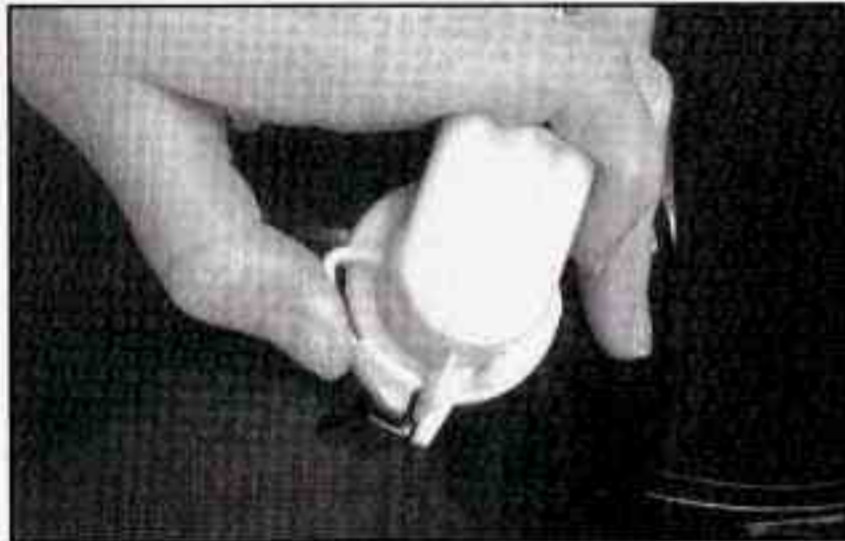

3. To remove the socket with the bulb, squeeze the tab while you turn the socket to the left (counterclockwise).



4. Remove the bulb from the socket.
5. Reverse the steps with a new bulb.

Back-Up Lamps

You can access the back-up lamps through the inboard taillamp opening. See "Rear Turn Signal and Taillamps" in the Index.

1. Squeeze the tab on the socket while turning it to the left to remove it from the assembly.
2. Remove the bulb from the socket.

3. Reverse the steps with a new bulb.

For any bulb replacement procedures not listed here, please see your dealership.

Windshield Wiper Blade Replacement

It's a good idea to clean or replace the wiper blade assembly every six months. For the proper windshield wiper blade length and type, see "Replacement Parts" in the Index.

NOTICE:

Use care when removing or installing a blade assembly. Accidental bumping can cause the arm to fall back and strike the windshield.

To remove the wiper blade assembly:

1. Open the hood to gain access to the windshield wipers.
2. Lift the wiper arm until it locks into a vertical position.

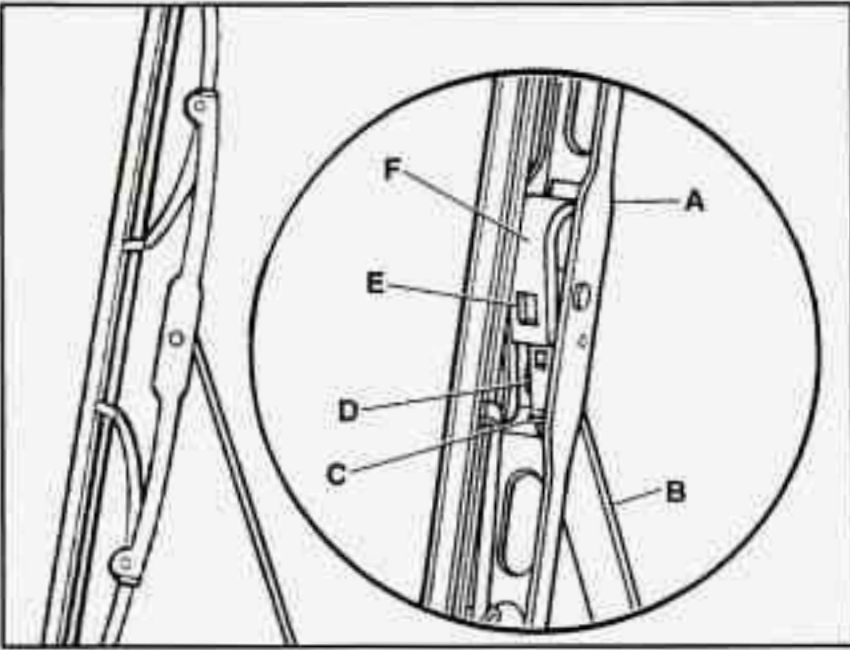

- A. Blade Assembly
- B. Arm Assembly
- C. Locking Tab
- D. Blade Pivot
- E. Hook Slot
- F. Arm Hook

3. Press down on the blade assembly pivot locking tab. Pull down on the blade assembly to release it from the wiper arm hook.
4. Remove the insert from the blade assembly. The insert has two notches at one end that are locked by the bottom claws of the blade assembly. At the notched end, pull the insert from the blade assembly.

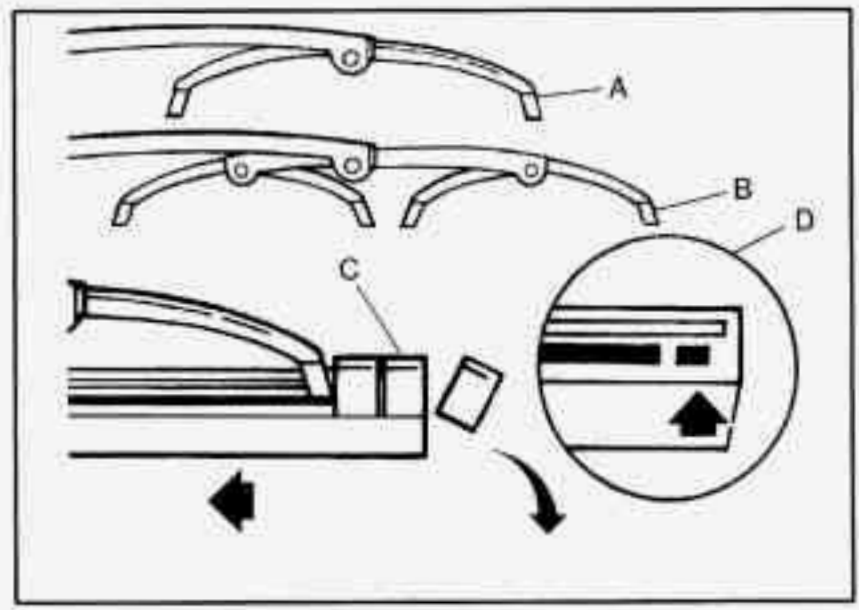

To install the new wiper insert:

1. Slide the insert (D), notched end last, into the end with two blade claws (A). Slide the insert all the way through the blade claws at the opposite end (B). Plastic caps (C) will be forced off as the insert is fully installed.
2. Be sure the notches are locked by the bottom claws. Make sure that all other claws are properly locked on both sides of the insert slots.

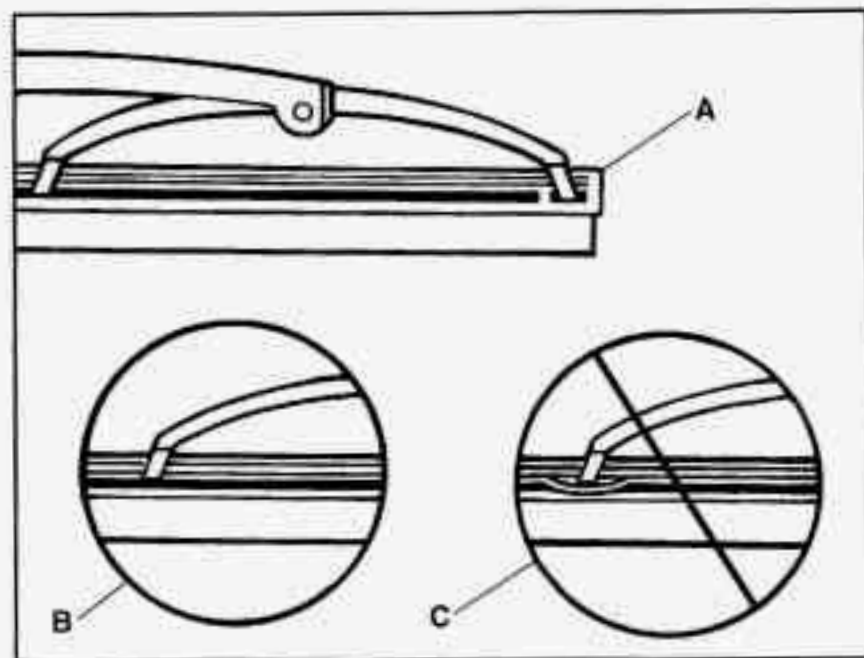

A. Claw in Notch

B. Correct Installation

C. Incorrect Installation

3. Put the blade assembly pivot in the wiper arm hook. Pull up until the pivot locking tab locks in the hook slot.
4. Carefully lower the wiper arm and blade assembly into the windshield.

Tires

Your new vehicle comes with high-quality tires made by a leading tire manufacturer. If you ever have questions about your tire warranty and where to obtain service, see your Corvette Warranty booklet for details.



CAUTION:

Poorly maintained and improperly used tires are dangerous.

- **Overloading your tires can cause overheating as a result of too much friction. You could have an air-out and a serious accident. See “Loading Your Vehicle” in the Index.**
- **Underinflated tires pose the same danger as overloaded tires. The resulting accident could cause serious injury. Check all tires frequently to maintain the recommended pressure. Tire pressure should be checked when your tires are cold.**
- **Overinflated tires are more likely to be cut, punctured or broken by a sudden impact -- such as when you hit a pothole. Keep tires at the recommended pressure.**
- **Worn, old tires can cause accidents. If your tread is badly worn, or if your tires have been damaged, replace them.**

Extended Mobility Tires

Your vehicle, when new, had Goodyear Extended Mobility Tires (EMT). There's no spare tire, no tire changing equipment and no place to store a tire in the vehicle. Extended Mobility Tires perform so well without any air that a Tire Pressure Monitor (TPM) is used to alert you if a tire has lost pressure.

The Tire Pressure Monitor (TPM) has a sensor on each road wheel that transmits to a receiver on the instrument panel.

The system operates on a radio frequency subject to Federal Communications Commission (FCC) Rules and with Industry and Science Canada.

This device complies with Part 15 of the FCC Rules. Operation is subject to the following two conditions: (1) this device may not cause harmful interference, and (2) this device must accept any interference received, including interference that may cause undesired operation.

This device complies with RSS-210 of Industry and Science Canada. Operation is subject to the following two conditions: (1) this device may not cause interference, and (2) this device must accept any interference received, including interference that may cause undesired operation of the device.

Changes or modifications to this system by other than an authorized service facility could void authorization to use this equipment.

If a tire's inflation pressure is between 5 psi (35 kPa) and 25 psi (170 kPa), you will see a message on the Driver Information Center. This message will show which tire is underinflated and two chimes will sound. An example would be **LOW TIRE PRESSURE-LR**. This would mean that the inflation pressure in your left rear tire is between 5 psi (35 kPa) and 25 psi (170 kPa). If the inflation pressure in the tire drops below 5 psi (35 kPa), the message would read **FLAT TIRE-LR** and four chimes will sound. See "Driver Information Center" in the Index.

The TPM will also alert you if a tire's pressure is higher than 42 psi (290 kPa). The message will show which tire is overinflated and two chimes will sound. An example would be **HIGH PRESSURE-LR**. This would mean that the inflation pressure in your left rear tire is higher than 42 psi (290 kPa). See "Driver Information Center" in the Index.

If a tire pressure message appears on the Driver Information Center, stop as soon as you can. Have the tire pressures checked and set to those shown on your Tire Loading Information label. See "Inflation -- Tire Pressure" in the Index.

 **CAUTION:**

When the LOW TIRE PRESSURE or FLAT TIRE message is displayed on the Driver Information Center, your vehicle's handling capabilities will be reduced during severe maneuvers. If you drive too fast, you could lose control of your vehicle. You or others could be injured. Don't drive over 55 mph (90 km/h) when the LOW TIRE PRESSURE or FLAT TIRE message is displayed. Drive cautiously, and check your tire pressures as soon as you can.

cushion between the road and the wheel. Because you won't have this cushion when driving on a deflated tire, try to avoid potholes that could damage your wheel and require replacement of it.

Some road hazards can damage a tire beyond repair. This damage could occur even before you've driven on the tire in a deflated condition. When a tire has been damaged, or if you've driven any distance on a deflated EMT, check with an authorized Goodyear EMT Service Center to determine whether the tire can be repaired or should be replaced. To maintain your vehicle's extended mobility feature, all replacement tires must be Extended Mobility Tires. As soon as possible, contact the nearest authorized Chevrolet or Goodyear EMT servicing facility for inspection and repair or replacement. Call Chevrolet at 1-800-CHEV-USA (1-800-243-8872) or Goodyear at 1-800-789-9878 24-hours a day for information on the location of the nearest EMT servicing facility. In Canada, contact the Customer Communication Center at 1-800-263-3777, or Canadian Roadside Assistance at 1-800-268-6800. You can also use the Goodyear number listed above to locate an authorized EMT servicing facility.

If a tire goes flat, you won't need to stop on the side of the road to change the tire. You can just keep on driving. The shorter the distance you drive and the slower the speed, the greater the chance that the tire will not have to be replaced. If you drive on a deflated EMT for 50 miles (80 km) or less and at speeds of 55 mph (90 km/h) or less, there is a good chance that the tire can be repaired. The tire can operate effectively with no air pressure for up to 200 miles (320 km) at speeds up to 55 mph (90 km/h), but the tire would then have to be replaced. When a tire is filled with air, it provides a



CAUTION:

Extended mobility tires are constructed differently than other tires and could explode during improper service. You or others could be injured or killed if you attempt to repair, replace, dismount, or mount an extended mobility tire. Let only an authorized Goodyear EMT Service Center repair, replace, dismount and mount extended mobility tires.

The valve stems on your extended mobility tires have sensors that are part of the TPM. These sensors contain batteries which are designed to last for 10 years under normal driving conditions. See your dealer if you ever need to have a wheel replaced, or if the batteries in the sensors ever need replacement.

NOTICE:

Using liquid sealants can damage the tire valves and tire pressure monitor sensors in your extended mobility tires. This damage would not be covered by warranty. Don't use liquid sealants in your extended mobility tires.

If you feel that winter tires are needed for your driving conditions, Goodyear Eagle M+S EMT tires are available in your original equipment sizes from an authorized Goodyear EMT retailer. These tires will improve snow traction while maintaining your Corvette's extended mobility feature. When using winter tires on your vehicle, be sure to use them on all four wheels see "Buying New Tires" in the Index.

Inflation -- Tire Pressure

The Tire-Loading Information label, which is on the rear edge of the driver's door shows the correct inflation pressures for your tires when they're cold. "Cold" means your vehicle has been sitting for at least three hours or driven no more than 1 mile (1.6 km).

NOTICE:

Don't let anyone tell you that underinflation or overinflation is all right. It's not. If your tires don't have enough air (underinflation), you can get the following:

- Too much flexing
- Too much heat
- Tire overloading
- Bad wear
- Bad handling
- Bad fuel economy.

NOTICE: (Continued)

NOTICE: (Continued)

If your tires have too much air (overinflation), you can get the following:

- Unusual wear
- Bad handling
- Rough ride
- Needless damage from road hazards.

When to Check

Check your tires once a month or more.

How to Check

With the Tire Pressure Monitor, you can check tire inflation pressures while driving. After you've reached a speed of 15 mph (24 kmh) or more, press and release the GAGES button on the Driver Information Center (DIC) until the front tire pressures are displayed. Then, press and release the GAGES button for the rear tire pressures. If the display doesn't show tire pressure, or if the SERVICE TIRE MON SYS message appears, see your dealer for service.

Tire Rotation

The tires on your Corvette are directional and are different sizes front to rear. Due to this, your tires should not be rotated. Each tire and wheel should be used only in the position it is in.

When It's Time for New Tires

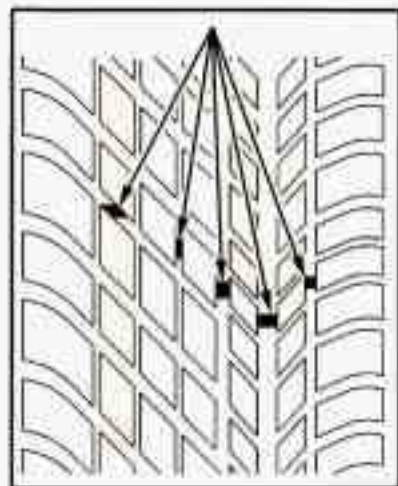

One way to tell when it's time for new tires is to check the treadwear indicators, which will appear when your tires have only 1/16 inch (1.6 mm) or less of tread remaining.

You need a new tire if any of the following statements are true:

- You can see the indicators at three or more places around the tire.
- You can see cord or fabric showing through the tire's rubber.

- The tread or sidewall is cracked, cut or snagged deep enough to show cord or fabric.
- The tire has a bump, bulge or split.
- The tire has a puncture, cut or other damage that can't be repaired well because of the size or location of the damage.

Buying New Tires

To find out what kind and size of tires you need, look at the Tire-Loading Information label.

The tires installed on your vehicle when it was new had a Tire Performance Criteria Specification (TPC Spec) number on each tire's sidewall. When you get new tires, get ones with that same TPC Spec number. That way your vehicle will continue to have tires that are designed to give proper endurance, handling, speed rating, traction, ride and other things during normal service on your vehicle. If your tires have an all-season tread design, the TPC number will be followed by an "MS" (for mud and snow).

If you ever replace your tires with those not having a TPC Spec number, make sure they are the same size, load range, speed rating and construction type (bias, bias-belted or radial) as your original tires.

 **CAUTION:**

Mixing tires could cause you to lose control while driving. If you mix tires of different sizes (other than those originally installed on your vehicle) or types (radial and bias-belted tires), the vehicle may not handle properly, and you could have a crash. Using tires of different sizes (other than those originally installed on your vehicle) may also cause damage to your vehicle. Be sure to use the correct size and type tires on all four wheels.

 **CAUTION:**

If you use bias-ply tires on your vehicle, the wheel rim flanges could develop cracks after many miles of driving. A tire and/or wheel could fail suddenly, causing a crash. Use only radial-ply tires with the wheels on your vehicle.

If you feel that winter tires are needed, see “Extended Mobility Tires” in the Index.

Uniform Tire Quality Grading

The following information relates to the system developed by the United States National Highway Traffic Safety Administration, which grades tires by treadwear, traction and temperature performance. (This applies only to vehicles sold in the United States.) The grades are molded on the sidewalls of most passenger car tires. The Uniform Tire Quality Grading system does not apply to deep tread, winter-type snow tires, space-saver or temporary use spare tires, tires with nominal rim diameters of 10 to 12 inches (25 to 30 cm), or to some limited-production tires.

While the tires available on General Motors passenger cars and light trucks may vary with respect to these grades, they must also conform to Federal safety requirements and additional General Motors Tire Performance Criteria (TPC) standards.

Treadwear

The treadwear grade is a comparative rating based on the wear rate of the tire when tested under controlled conditions on a specified government test course. For example, a tire graded 150 would wear one and a half (1 1/2) times as well on the government course as a tire graded 100. The relative performance of tires depends upon the actual conditions of their use, however, and may depart significantly from the norm due to variations in driving habits, service practices and differences in road characteristics and climate.

Traction -- A, B, C

The traction grades, from highest to lowest, are A, B, and C, and they represent the tire's ability to stop on wet pavement as measured under controlled conditions on specified government test surfaces of asphalt and concrete. A tire marked C may have poor traction performance.

Warning: The traction grade assigned to this tire is based on braking (straight ahead) traction tests and does not include cornering (turning) traction.

Temperature -- A, B, C

The temperature grades are A (the highest), B, and C, representing the tire's resistance to the generation of heat and its ability to dissipate heat when tested under controlled conditions on a specified indoor laboratory test wheel. Sustained high temperature can cause the material of the tire to degenerate and reduce tire life, and excessive temperature can lead to sudden tire failure. The grade C corresponds to a level of performance which all passenger car tires must meet under the Federal Motor Vehicle Safety Standard No. 109. Grades B and A represent higher levels of performance on the laboratory test wheel than the minimum required by law.

Warning: The temperature grade for this tire is established for a tire that is properly inflated and not overloaded. Excessive speed, underinflation, or excessive loading, either separately or in combination, can cause heat buildup and possible tire failure.

Wheel Alignment and Tire Balance

The wheels on your vehicle were aligned and balanced carefully at the factory to give you the longest tire life and best overall performance.

Scheduled wheel alignment and wheel balancing are not needed. However, if you notice unusual tire wear or your vehicle pulling one way or the other, the alignment may need to be reset. If you notice your vehicle vibrating when driving on a smooth road, your wheels may need to be rebalanced.

Wheel Replacement

Replace any wheel that is bent, cracked, or badly rusted or corroded. If wheel nuts keep coming loose, the wheel, wheel bolts and wheel nuts should be replaced. If the wheel leaks air, replace it (except some aluminum wheels, which can sometimes be repaired). See your dealer if any of these conditions exist.

Your dealer will know the kind of wheel you need.

Each new wheel should have the same load-carrying capacity, diameter, width, offset and be mounted the same way as the one it replaces.

If you need to replace any of your wheels, wheel bolts or wheel nuts, replace them only with new GM original equipment parts. This way, you will be sure to have the right wheel, wheel bolts and wheel nuts for your Corvette model.

 **CAUTION:**

Using the wrong replacement wheels, wheel bolts or wheel nuts on your vehicle can be dangerous. It could affect the braking and handling of your vehicle, make your tires lose air and make you lose control. You could have a collision in which you or others could be injured. Always use the correct wheel, wheel bolts and wheel nuts for replacement.

NOTICE:

The wrong wheel can also cause problems with bearing life, brake cooling, speedometer or odometer calibration, headlamp aim, bumper height, vehicle ground clearance and tire clearance to the body and chassis.

 **CAUTION:**

Rust or dirt on the wheel, or on the parts to which it is fastened, can make the wheel nuts become loose after a time. The wheel could come off and cause an accident. When you change a wheel, remove any rust or dirt from the places where the wheel attaches to the vehicle. In an emergency, you can use a cloth or paper towel to do this; but be sure to use a scraper or wire brush later, if you need to, to get all the rust or dirt off.

 **CAUTION:**

Never use oil or grease on studs or nuts. If you do, the nuts might come loose. Your wheel could fall off, causing a serious accident.

 **CAUTION:**

Incorrect wheel nuts or improperly tightened wheel nuts can cause the wheel to become loose and even come off. This could lead to an accident. Be sure to use the correct wheel nuts. If you have to replace them, be sure to get new GM original equipment wheel nuts.

NOTICE:

Improperly tightened wheel nuts can lead to brake pulsation and rotor damage. To avoid expensive brake repairs, evenly tighten the wheel nuts in the proper sequence and to the proper torque specification.

Used Replacement Wheels

 **CAUTION:**

Putting a used wheel on your vehicle is dangerous. You can't know how it's been used or how far it's been driven. It could fail suddenly and cause an accident. If you have to replace a wheel, use a new GM original equipment wheel.

Using the Wheel Lock Key

The wheel lock key sits in a small depression in the trunk rail directly under the left-hand rear compartment cover.

Your vehicle's wheel lock key has a unique registration number. The registration number is printed on a card included in your lock nut package. Also, on this card, is lost key replacement information. This number is not recorded by GM or your dealer, so be sure not to lose this card. You will need the information if you ever lose your wheel lock key.

If you or someone else is going to remove the wheels on your vehicle, make sure that the special wheel nut socket and wheel lock key are being used.

NOTICE:

Your wheels could be damaged if the wheel nut socket is not used to remove your vehicle's wheels.

The wheel nut socket can be used with an air wrench or a torque wrench. The wheel lock key can be used with a torque wrench, but not with an air or impact wrench.

NOTICE:

Your wheel lock key or lock nuts could be damaged if an air or impact wrench is used with this key.

Tire Chains

NOTICE:

Don't use tire chains. They can damage your vehicle because there's not enough clearance. Use another type of traction device only if its manufacturer recommends it for use on your vehicle and tire size combination and road conditions. Follow that manufacturer's instructions. To help avoid damage to your vehicle, drive slowly, readjust or remove the device if it's contacting your vehicle, and don't spin your wheels.

If you do find traction devices that will fit, install them on the rear tires.

Appearance Care

Remember, cleaning products can be hazardous. Some are toxic. Others can burst into flame if you strike a match or get them on a hot part of the vehicle. Some are dangerous if you breathe their fumes in a closed space. When you use anything from a container to clean your vehicle, be sure to follow the manufacturer's warnings and instructions. And always open your doors or windows when you're cleaning the inside.

Never use these to clean your vehicle:

- Gasoline
- Benzene
- Naphtha
- Carbon Tetrachloride
- Acetone
- Paint Thinner
- Turpentine
- Lacquer Thinner
- Nail Polish Remover

They can all be hazardous -- some more than others -- and they can all damage your vehicle, too.

Don't use any of these unless this manual says you can. In many uses, these will damage your vehicle:

- Alcohol
- Laundry Soap
- Bleach
- Reducing Agents

Cleaning the Inside of Your Vehicle

Use a vacuum cleaner often to get rid of dust and loose dirt. Wipe vinyl or leather with a clean, damp cloth.

Your dealer has two cleaners, Multi-Purpose Interior Cleaner and Capture Non-Solvent Dry Spot and Soil Remover. They will clean normal spots and stains very well. You can get GM-approved cleaning products from your dealer. (See "Appearance Care and Materials" in the Index.)

Here are some cleaning tips:

- Always read the instructions on the cleaner label.

- Clean up stains as soon as you can -- before they set.
- Carefully scrape off any excess stain.
- Use a clean cloth or sponge, and change to a clean area often. A soft brush may be used if stains are stubborn.
- If a ring forms after spot cleaning, clean the entire area immediately or it will set.

Fabric Protection

Your Corvette has carpet that has been treated with Scotchgard™ Fabric Protector, a 3M product. It protects fabrics by repelling oil and water, which are the carriers of most stains. Even with this protection, you still need to clean your carpet often to keep it looking new.

Further information on cleaning is available by calling 1-800-433-3296 (in Minnesota, 1-800-642-6167).

Cleaning Vinyl

Use warm water and a clean cloth.

- Rub with a clean, damp cloth to remove dirt. You may have to do it more than once.
- Things like tar, asphalt and shoe polish will stain if you don't get them off quickly. Use a clean cloth and a vinyl/leather cleaner. See your dealer for this product.

Cleaning Coated Moldings

These moldings are around the hatch opening in your Corvette's rear area.

- When lightly soiled, wipe with a sponge or soft lint-free cloth dampened with water.
- When heavily soiled, use warm soapy water.

Cleaning Leather

Use a soft cloth with lukewarm water and a mild soap or saddle soap and wipe dry with a soft cloth. Then, let the leather dry naturally. Do not use heat to dry.

- For stubborn stains, use a leather cleaner. See your dealer for this product.
- *Never* use oils, varnishes, solvent-based or abrasive cleaners, furniture polish or shoe polish on leather.
- Soiled or stained leather should be cleaned immediately. If dirt is allowed to work into the finish, it can harm the leather.

Cleaning the Top of the Instrument Panel

Use only mild soap and water to clean the top surfaces of the instrument panel. Sprays containing silicones or waxes may cause annoying reflections in the windshield and even make it difficult to see through the windshield under certain conditions.

Cleaning Interior Plastic Components

Use only a mild soap and water solution on a soft cloth or sponge. Commercial cleaners may affect the surface finish.

Cleaning Soft-Touch Paint Surfaces

Use only mild soap and water to clean the Soft-Touch paint surfaces in your Corvette.

Cleaning the Security Shade and Convenience Net

Wash with warm water and mild detergent, rinse with cold water and tumble dry on low. Do not use chlorine bleach.

Care of Safety Belts

Keep belts clean and dry.



CAUTION:

Do not bleach or dye safety belts. If you do, it may severely weaken them. In a crash, they might not be able to provide adequate protection. Clean safety belts only with mild soap and lukewarm water.

Cleaning Glass Surfaces

Glass should be cleaned often. GM Glass Cleaner (GM Part No. 1050427) or a liquid household glass cleaner will remove normal tobacco smoke and dust films on interior glass.

Don't use abrasive cleaners on glass, because they may cause scratches. Avoid placing decals on the inside rear window, since they may have to be scraped off later. If abrasive cleaners are used on the inside of the rear window, an electric defogger element may be damaged. Any temporary license should not be attached across the defogger grid.

Cleaning the Outside of the Windshield and Wiper Blades

If the windshield is not clear after using the windshield washer, or if the wiper blade chatters when running, wax, sap or other material may be on the blade or windshield.

Clean the outside of the windshield with GM Windshield Cleaner, Bon Ami[®] Powder (non-scratching glass cleaning powder), GM Part No. 1050011. The windshield is clean if beads do not form when you rinse it with water.

If you use a glass treatment or conditioner containing ethyl alcohol or ethyl sulfate on your glass, be sure to remove the acrylic roof panel, if so equipped. These products may damage the panel.

Grime from the windshield will stick to the wiper blades and affect their performance. Clean the blade by wiping vigorously with a cloth soaked in full-strength windshield washer solvent. Then rinse the blade with water.

Check the wiper blades and clean them as necessary; replace blades that look worn.

Weatherstrips

Silicone grease on weatherstrips will make them last longer, seal better, and not stick or squeak. Apply silicone grease with a clean cloth at least every six months. During very cold, damp weather more frequent application may be required. (See “Recommended Fluids and Lubricants” in the Index.)

Cleaning a Removable Roof Panel

Special care is necessary when cleaning, removing and/or storing the roof panel.

- Flush with water to remove dust and dirt, then dry the panel.
- Clean the panel with GM Glass Cleaner. Leave the cleaner on the panel for one minute, then wipe the panel with a soft, lint-free cloth.
- Don't use abrasive cleaning materials.

If water drops are frequently allowed to dry on the roof panel, impurities in the water will adhere to the top. These impurities may etch or mar the finish. When the panel gets wet, you should dry it off.

NOTICE:

Do not use a glass treatment or conditioner containing ethyl alcohol or ethyl sulfate on the roof panel. These products may damage the panel.

Cleaning the Outside of Your Vehicle

The paint finish on your vehicle provides beauty, depth of color, gloss retention and durability.

Washing Your Vehicle

The best way to preserve your vehicle's finish is to keep it clean by washing it often with lukewarm or cold water.

Don't wash your vehicle in the direct rays of the sun. Don't use strong soaps or chemical detergents. Use liquid hand, dish or car washing (mild detergent) soaps. You can get GM-approved cleaning products from your dealer. (See "Appearance Care and Materials" in the Index.) Don't use cleaning agents that are petroleum based, or that contain acid or abrasives. All cleaning agents should be flushed promptly and not allowed to dry on the surface, or they could stain. Dry the finish with a soft, clean chamois or an all-cotton towel to avoid surface scratches and water spotting.

High pressure car washes may cause water to enter your vehicle.

NOTICE:

Conveyor systems on some automatic car washes may damage a Corvette. They may not have enough clearance for the undercarriage or for the wide rear tires.

Check with the manager before using a car wash.

Cleaning Exterior Lamps/Lenses

Use lukewarm or cold water, a soft cloth and a liquid hand, dish or car washing (mild detergent) soap to clean exterior lamps and lenses. Follow instructions under "Washing Your Vehicle."

Finish Care

Occasional waxing or mild polishing of your vehicle by hand may be necessary to remove residue from the paint finish. You can get GM-approved cleaning products from your dealer. (See "Appearance Care and Materials" in the Index.)

Your Corvette has a “basecoat/clearcoat” paint finish. The clearcoat gives more depth and gloss to the colored basecoat. Always use waxes and polishes that are non-abrasive and made for a basecoat/clearcoat paint finish.

NOTICE:

Machine compounding or aggressive polishing on a basecoat/clearcoat paint finish may dull the finish or leave swirl marks.

Foreign materials such as calcium chloride and other salts, ice melting agents, road oil and tar, tree sap, bird droppings, chemicals from industrial chimneys, etc., can damage your vehicle’s finish if they remain on painted surfaces. Wash the vehicle as soon as possible. If necessary, use non-abrasive cleaners that are marked safe for painted surfaces to remove foreign matter.

Exterior painted surfaces are subject to aging, weather and chemical fallout that can take their toll over a period of years. You can help to keep the paint finish looking new by keeping your vehicle garaged or covered whenever possible.

Cleaning Your Convertible Top

Your convertible top should be cleaned often. If you use an automatic car wash, use one with water jets and hanging cloths. High pressure car washes may cause water to enter your vehicle.

When you hand wash the top, do it in partial shade. Use a mild soap, lukewarm water and a soft sponge. A chamois or cloth may leave lint on the top, and a brush can chafe the threads in the top fabric. Don’t use detergents, harsh cleaners, solvents or bleaching agents.

Wet the entire vehicle and wash the top evenly to avoid spots or rings. Let the soap remain on the fabric for a few minutes. When the top is really dirty, use a mild foam-type cleaner. Thoroughly rinse the entire vehicle, then let the top dry in direct sunlight.

To protect the convertible top:

- After you wash the vehicle, make sure the top is completely dry before you lower it.
- Don’t get any cleaner on the vehicle’s painted finish; it could leave streaks.
- If you decide to go through an automatic car wash, ask the manager if the equipment could damage your top.

Cleaning Aluminum Wheels

Keep your wheels clean using a soft clean cloth with mild soap and water. Rinse with clean water. After rinsing thoroughly, dry with a soft clean towel. A wax may then be applied.

The surface of these wheels is similar to the painted surface of your vehicle. Don't use strong soaps, chemicals, abrasive polishes, abrasive cleaners or abrasive cleaning brushes on them because you could damage the surface.

Don't take your vehicle through an automatic car wash that has silicon carbide tire cleaning brushes. These brushes can also damage the surface of these wheels.

Cleaning Tires

To clean your tires, use a stiff brush with a tire cleaner.

NOTICE:

When applying a tire dressing always take care to wipe off any overspray or splash from all painted surfaces on the body or wheels of the vehicle. Petroleum-based products may damage the paint finish.

Finish Damage

Any stone chips, fractures or deep scratches in the finish should be repaired right away.

Minor chips and scratches can be repaired with touch-up materials available from your dealer or other service outlets. Larger areas of finish damage can be corrected in your dealer's body and paint shop.

Magnesium Wheel Finish

NOTICE:

Improper paint repair or refinishing can cause corrosion damage to a magnesium wheel. See your dealer if a magnesium wheel needs paint repair or refinishing.

Underbody Maintenance

Chemicals used for ice and snow removal and dust control can collect on the underbody. If these are not removed, accelerated corrosion (rust) can occur on the underbody parts such as fuel lines, frame, floor pan and exhaust system even though they have corrosion protection.

At least every spring, flush these materials from the underbody with plain water. Clean any areas where mud and other debris can collect. Dirt packed in closed areas of the frame should be loosened before being flushed. Your dealer or an underbody car washing system can do this for you.

Fiberglass Springs

NOTICE:

Don't use corrosive or acidic cleaning agents, engine degreasers, aluminum cleaning agents or other harsh solvents to clean fiberglass springs; they'll damage the springs.

Chemical Paint Spotting

Some weather and atmospheric conditions can create a chemical fallout. Airborne pollutants can fall upon and attack painted surfaces on your vehicle. This damage can take two forms: blotchy, ringlet-shaped discolorations, and small irregular dark spots etched into the paint surface.

Although no defect in the paint job causes this, GM will repair, at no charge to the owner, the surfaces of new vehicles damaged by this fallout condition within 12 months or 12,000 miles (20 000 km) of purchase, whichever occurs first.

Appearance Care Materials Chart

PART NUMBER	SIZE	DESCRIPTION	USAGE
994954	23 in. x 25 in.	Polishing Cloth – Wax Treated	Exterior polishing cloth
1050172	16 oz. (0.473 L)	Tar and Road Oil Remover	Removes tar, road oil and asphalt
1050173	16 oz. (0.473 L)	Chrome Cleaner and Polish	Use on chrome, stainless steel, nickel, copper and brass
1050174	16 oz. (0.473 L)	White Sidewall Tire Cleaner	Removes soil and black marks from whitewalls
1050214	32 oz. (0.946 L)	Vinyl Cleaner	Cleans vinyl tops, upholstery and convertible tops
1050427	23 oz. (0.680 L)	Glass Cleaner	Removes dirt, grime, smoke and fingerprints
1052870	16 oz. (0.473 L)	Wash Wax Concentrate	Cleans and lightly waxes
1052918**	8 oz. (0.237 L)	Armor All™ Protectant	Protects leather, wood, acrylics, Plexiglas™, plastic, rubber and vinyl
1052925	16 oz. (0.473 L)	Multi-Purpose Interior Cleaner	Cleans carpets, seats, interior trim, door panels and floor mats
1052929	16 oz. (0.473 L)	Wheel Cleaner	Spray on and rinse with water
1052930	8 oz. (0.237 L)	Capture Dry Spot Remover	Attracts, absorbs and removes soils
12345002	16 oz. (0.473 L)	Armor All™ Cleaner	Cleans and shines a variety of surface types
12345721	2.5 sq. ft.	Synthetic Chamois	Shines vehicle without scratching
12345725	12 oz. (0.354 L)	Silicone Tire Shine	Spray on tire shine
12377964	16 oz. (0.473 L)	Finish Enhancer	Removes dust, fingerprints and surface contaminants
12377966	16 oz. (0.473 L)	Cleaner Wax	Removes light scratches and oxidation and protects finish
12377984	16 oz. (0.473 L)	Surface Cleaner	Removes contaminants, blemishes and swirl marks
See your General Motors Parts Department for these products. See "Fluids and Lubricants" in the Index.			** Not recommended for use on instrument panel vinyl.

Vehicle Identification Number (VIN)

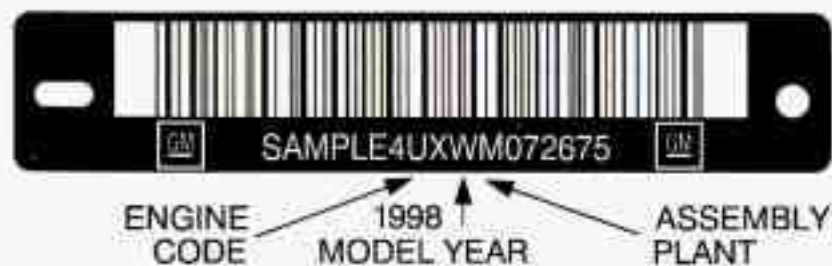

This is the legal identifier for your vehicle. It appears on a plate in the front corner of the instrument panel, on the driver's side. You can see it if you look through the windshield from outside your vehicle. The VIN also appears on the Vehicle Certification and Service Parts labels and the certificates of title and registration.

Engine Identification

The 8th character in your VIN is the engine code. This code will help you identify your engine, specifications and replacement parts.

Service Parts Identification Label

You'll find this label on the cover assembly for the rear left-hand compartment storage pocket. It's very helpful if you ever need to order parts. On this label is:

- your VIN,

- the model designation,
- paint information and
- a list of all production options and special equipment.

Be sure that this label is not removed from the vehicle.

Electrical System

Add-On Electrical Equipment

NOTICE:

Don't add anything electrical to your vehicle unless you check with your dealer first. Some electrical equipment can damage your vehicle and the damage wouldn't be covered by your warranty. Some add-on electrical equipment can keep other components from working as they should.

Your vehicle has an air bag system. Before attempting to add anything electrical to your vehicle, see "Servicing Your Air Bag-Equipped Corvette" in the Index.

Accessory Power Plug

This plug can be used to connect electrical equipment such as a cellular phone or CB radio. The accessory power plug is located behind the passenger side toe-board at the top left corner near the body control module. Be sure to follow the installation instructions included with the equipment.

To use the accessory power plug:

1. Remove the toe-board panel by lifting up on the latches at the top of each corner of the panel.
2. Locate the black connector at the left top corner of the compartment near the body control module above the two white diagnostic connectors.
3. Disconnect the connector pigtail by pulling forward on the plastic locking tab and pull the connection apart from the wire harness.

The plug has three separate wires:

- The orange wire connects to battery power.
- The yellow wire connects to ignition power. Power is only available in the ignition ON position.
- The black wire connects to ground.

NOTICE:

When using the accessory plug:

- **DO NOT splice wires directly into the vehicle electrical wire harness. If done incorrectly, splicing may cause damage to your electrical system and would not be covered by the vehicle's warranty.**
- **The maximum load of any electrical equipment should not exceed 15 amps.**
- **Be sure to turn off any electrical equipment when not in use. Leaving electrical equipment on for extended periods of time can drain your battery.**
- **DO NOT use this plug if the electrical equipment requires frequent connecting and disconnecting. This may cause excessive wear on the accessory plug and damage your electrical system and the damage would not be covered by your warranty.**

Headlamps

The headlamp wiring is protected by a circuit breaker. An electrical overload will cause the lamps to go on and off, or in some cases to remain off. If this happens, have your headlamp wiring checked right away.

Windshield Wipers

The windshield wiper motor is protected by a fuse and an internal circuit breaker. If the motor overheats due to heavy snow, etc., the wiper will stop until the motor cools. If the overload is caused by some electrical problem and not snow, etc., be sure to get it fixed.

Power Windows and Other Power Options

Circuit breakers protect the power seats and other power accessories. When the current load is too heavy, the circuit breaker opens and closes, protecting the circuit until the problem is fixed or goes away.

Fuses and Circuit Breakers

The wiring circuits in your vehicle are protected from short circuits by a combination of maxi-fuses, mini-fuses and circuit breakers. This greatly reduces the chance of fires caused by electrical problems.

Look at the silver-colored band inside the fuse. If the band is broken or melted, replace the fuse. Be sure you

replace a bad fuse with a new one of the identical size and rating.

If you ever have a problem on the road and don't have a spare fuse, you can borrow one that has the same amperage. Just pick some feature of your vehicle that you can get along without -- like the radio or cigarette lighter -- and use its fuse, if it is the correct amperage. Replace it as soon as you can.

Instrument Panel Fuse Block



The interior fuse center is on the passenger's side of the vehicle, under the instrument panel and under the toe-board. Remove the toe-board and carpet covering to access the fuse block. Then turn the fuse block door knob and pull the door to access the fuses.

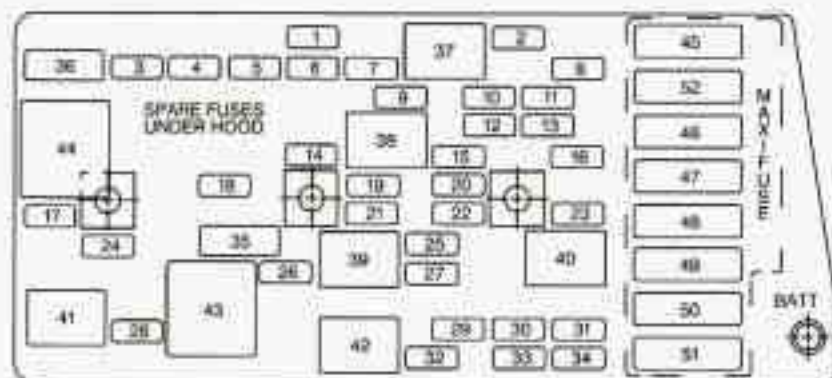

Fuse Usage

- 1 Console Cigarette Lighter
- 2 Monitored (Inadvertent) Load Control
- 3 Lumbar Seat
- 4 Driver Seat Control Module
- 5 Radio

Fuse Usage

- 6 Parking Lamps, Taillamps
- 7 Cigarette Lighter
- 8 Stop Hazard Flashers
- 9 Body Control Module
- 10 Windshield Wiper/Washer
- 11 Accessory Power
- 12 Blank
- 13 Body Control Module
- 14 Crank
- 15 Hazard/Turn Signal
- 16 Air Bag
- 17 TONN REL (Convertible Only)
- 18 HVAC Controls
- 19 Instrument Panel Control
- 20 Cruise Control
- 21 Brake-Transmission Shift Interlock
- 22 Body Control Module - Ignition 3

Fuse	Usage
23	Body Control Module - Ignition 2
24	Radio Antenna
25	Body Control Module - Ignition 1, Instrument Panel Control
26	Hatch/Trunk Release
27	HVAC Controls
28	Bose Speakers
29	Diagnostic
30	Right Door Control Module
31	Power Feed Door Right
32	Fuel Tank Door
33	Door Control Module Left
34	Power Feed Door Left
35	Driver Power Seat (Circuit Breaker)
36	Passenger Power Seat (Circuit Breaker)
37	Micro Relay - Monitored (Inadvertent) Load Control

Fuse	Usage
38	Micro Relay - Right Daytime Running Lamp
39	Micro Relay - Hatch Release
40	Micro Relay - Left Daytime Running Lamp
41	TONN REL (Convertible Only)
42	Micro Relay - Courtesy Lamps
43	Bose Mini Relay - Speakers
44	Mini Relay - Rear Defogger
45	Maxifuse - Ignition 1
46	Maxifuse - Rear Defogger
47	Blank
48	Maxifuse - Ignition 2
49	Maxifuse - Blower Motor
50	Starter
51	Blank
52	Maxi Circuit Breaker - Headlamps

Engine Compartment Fuse Block



There is one fuse block in the engine compartment located on the passenger's side of the vehicle in front of the battery.

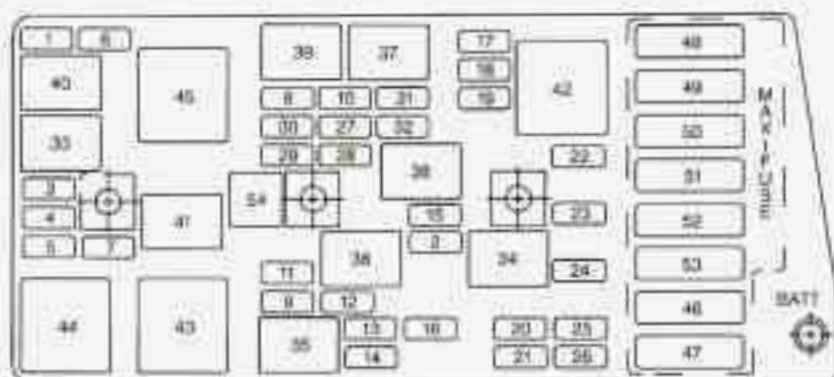

Fuse	Usage
1	ABS TRANS
2	Approach
3	Right Headlamp Motor
4	Left Headlamp Motor
5	BLANK
6	Fog Lamp

Fuse	Usage
7	Selective Real Time Damping
8	Headlamp Low Beam Right
9	Headlamp High Beam Right
10	Headlamp Low Beam Left
11	Horn
12	Headlamp High Beam Left
13	Fuel Pump
14	Cooling Fan - Ignition 3
15	Oxygen Sensor
16	Powertrain Control Module
17	Throttle Control
18	Injector 2
19	Engine Ignition
20	Blank
21	Blank
22	Injector 1
23	Powertrain Control Module

Fuse	Usage
24	Air Conditioning
25	Blank
26	Blank
27	Spare
28	Spare
29	Spare
30	Spare
31	Spare
32	Spare
33	Micro Relay - Air Pump
34	Micro Relay - Air Conditioner and Clutch
35	Micro Relay - Fuel Pump
36	Micro Relay - Horn
37	Micro Relay - ABS TRANS
38	Micro Relay - Back-Up Lamps
39	Micro Relay - Fog Lamp

Fuse	Usage
40	Micro Relay - AIR Solenoid
41	Micro Relay - Selective Real Time Damping
42	Mini Relay - Ignition
43	Mini Relay - Cooling Fan 2
44	Mini Relay - Cooling Fan 3
45	Mini Relay - Cooling Fan 1
46	Maxi-Fuse - Cooling Fan 2
47	Blank
48	Blank
49	Maxi-Fuse - Cooling Fan 1
50	Maxi-Fuse - Air Pump
51	Blank
52	Maxi-Fuse - Anti-Lock Brakes
53	Anti-Lock Brakes and Selective Real Time Damping Electronics
54	Fuse Puller

Replacement Bulbs

Automatic Transmission Indicator	194
Console Compartment Flood	LED
Glove Box Lamp	194
Mirror Reading Lamps	212-2
Visor Vanity Mirror	37
Underhood	211-2
IP Courtesy Lamps	194
Rear Courtesy	PC168
Headlamp High-Beam	9005
Headlamp Low-Beam	9006
Fog	893
Front Parking/Turn Signal	3157 NAK
Back-Up	2057
Front Sidemarker	194
Rear Sidemarker	194
Stop/Tail Turn Signal	3057
Center High-Mounted Stoplamp	LED
License	194

Capacities and Specifications

Engine

Type	V8
VIN Engine Code	
LS1	G
Fuel Delivery	Sequential Multi-Port Fuel Injection (SFI)
Valve Arrangement	Overhead Valve
Piston Displacement	5.7L
Bore	3.90 inches (9.9 cm)
Stroke	3.62 inches (9.2 cm)
Compression Ratio	
LS1	10.1:1
Horsepower	
LS1	345
Firing Order	1-8-7-2-6-5-4-3
Thermostat Temperature	
Specification	187°F (86°C)

Replacement Parts

Air Cleaner Filter	A917C
Battery	78A-72H
Coolant Surge Tank Cap ...	GM Part No. 10296465 15 psi (105 kPa)
Engine Oil Filter	PF44
PCV Valve	799C
Serpentine Belt	
AC Compressor	GM Part No. 12556609 or equivalent
Water Pump, Generator, Power Steering Pump ...	GM Part No. 12555225 or equivalent
Spark Plug	41-931 (0.60 inch Gap)
Thermostat	GM Part No. 12555717 or equivalent
Windshield Wiper Blade	
Length	22 inches (55.9 cm)
Type	9 mm x 3 mm Shephard's Hook

Wheel Nuts

Wheel Nut Torque 100 lb-ft (140 N-m)

Capacities (Approximate)

The following approximate capacities are given in United States and metric conversions.

Air Conditioning ... See the refrigerant information label under the hood.

Automatic Transmission

Drain and Refill 5 quarts (4.7 L)

Overhaul 10.8 quarts (10.2 L)

Coolant System

LS1 (with M30 automatic transmission) 12.6 quarts (11.9 L)

LS1 (with MM6 manual transmission) 12.9 quarts (12.2 L)

Crankcase

With Filter Change 6.5 quarts (6.1 L)

Fuel Tank 19.1 gallons (72.3 L)

Manual Transmission

(Overhaul) 4.1 quarts (3.81 L)

Rear Axle

Lubricant 1.5 quarts (1.42 L)

Limited Slip Additive 4 ounces (118 ml)

Tire Pressures See Tire-Loading Information label on rear edge of driver's door.

NOTE: All capacities are approximate. When adding, be sure to fill to the appropriate level, as recommended in this manual. Recheck fluid level after filling.

Vehicle Dimensions

Wheelbase 104.5 inches (265.4 cm)

Tread

Front 62.1 inches (157.7 cm)

Rear 62 inches (157.4 cm)

Length 179.7 inches (456.4 cm)

Width 73.6 inches (186.9 cm)

Height 47.7 inches (121.1 cm)

Power Curves

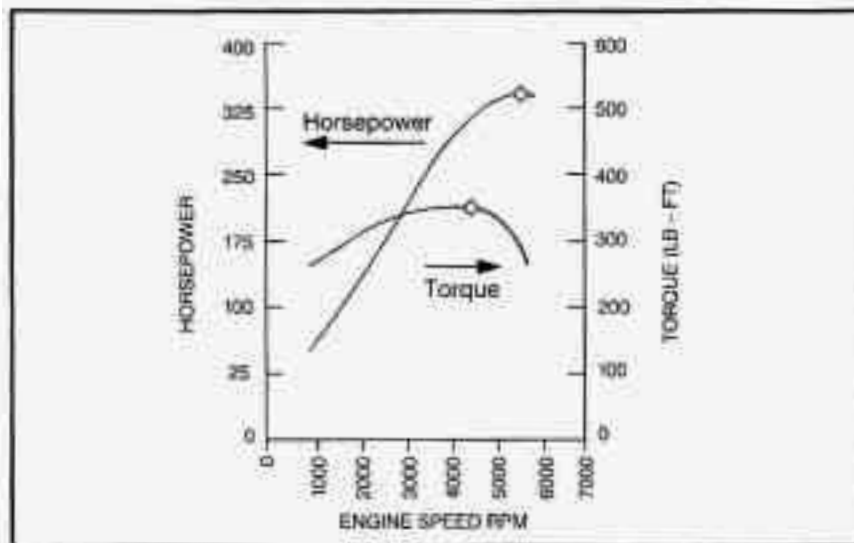

Accessory Belt Routing

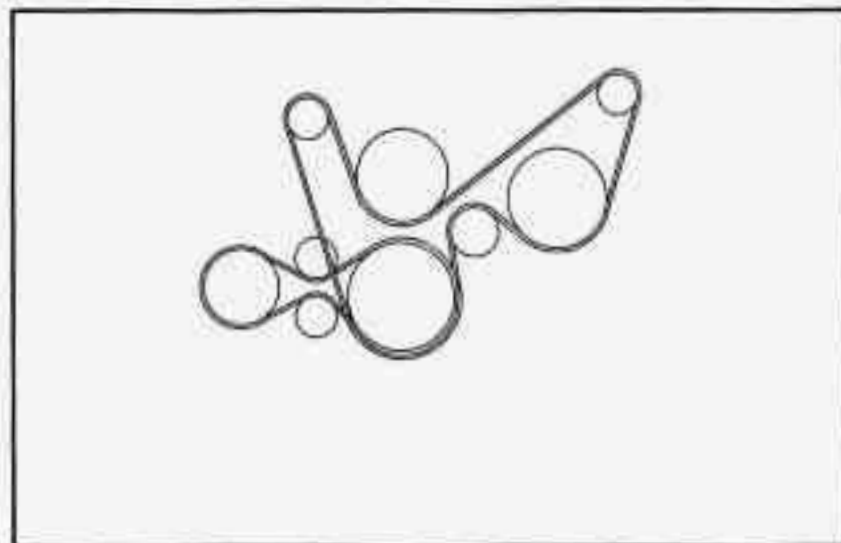

Air Conditioning Refrigerants

Not all air conditioning refrigerants are the same. If the air conditioning system in your vehicle needs refrigerant, be sure the proper refrigerant is used. If you're not sure, ask your dealer.

 **NOTES**



Section 7 Maintenance Schedule

This section covers the maintenance required for your Corvette. Your vehicle needs these services to retain its safety, dependability and emission control performance.

7-2	Introduction	7-11	Part B: Owner Checks and Services
7-2	Your Vehicle and the Environment	7-15	Part C: Periodic Maintenance Inspections
7-3	How This Section is Organized	7-16	Part D: Recommended Fluids and Lubricants
7-4	Part A: Scheduled Maintenance Services	7-18	Part E: Maintenance Record
7-5	Maintenance Schedule		

**IMPORTANT:
KEEP ENGINE OIL
AT THE PROPER
LEVEL AND CHANGE AS
RECOMMENDED**



***Protection
Plan***

Introduction

Your Vehicle and the Environment

Proper vehicle maintenance not only helps to keep your vehicle in good working condition, but also helps the environment. All recommended maintenance procedures are important. Improper vehicle maintenance can even affect the quality of the air we breathe. Improper fluid levels or the wrong tire inflation can increase the level of emissions from your vehicle. To help protect our environment, and to keep your vehicle in good condition, please maintain your vehicle properly.

Have you purchased the GM Protection Plan? The Plan supplements your new vehicle warranties. See your Warranty and Owner Assistance booklet, or your GM dealer for details.

How This Section is Organized

The remainder of this section is divided into five parts:

“Part A: Scheduled Maintenance Services” shows what to have done and how often. Some of these services can be complex, so unless you are technically qualified and have the necessary equipment, you should let your dealer’s service department or another qualified service center do these jobs.

CAUTION:

Performing maintenance work on a vehicle can be dangerous. In trying to do some jobs, you can be seriously injured. Do your own maintenance work only if you have the required know-how and the proper tools and equipment for the job. If you have any doubt, have a qualified technician do the work.

If you are skilled enough to do some work on your vehicle, you will probably want to get the service information. See “Service and Owner Publications” in the Index.

“Part B: Owner Checks and Services” tells you what should be checked and when. It also explains what you can easily do to help keep your vehicle in good condition.

“Part C: Periodic Maintenance Inspections” explains important inspections that your dealer’s service department or another qualified service center should perform.

“Part D: Recommended Fluids and Lubricants” lists some recommended products to help keep your vehicle properly maintained. These products, or their equivalents, should be used whether you do the work yourself or have it done.

“Part E: Maintenance Record” provides a place for you to record the maintenance performed on your vehicle. Whenever any maintenance is performed, be sure to write it down in this part. This will help you determine when your next maintenance should be done. In addition, it is a good idea to keep your maintenance receipts. They may be needed to qualify your vehicle for warranty repairs.

Part A: Scheduled Maintenance Services

Using Your Maintenance Schedule

We at General Motors want to help you keep your vehicle in good working condition. But we don't know exactly how you'll drive it. You may drive very short distances only a few times a week. Or you may drive long distances all the time in very hot, dusty weather. You may use your vehicle in making deliveries. Or you may drive it to work, to do errands or in many other ways.

Because of all the different ways people use their vehicles, maintenance needs vary. You may even need more frequent checks and replacements than you'll find in the schedules in this section. So please read this section and note how you drive. If you have any questions on how to keep your vehicle in good condition, see your GM dealer.

This part tells you the maintenance services you should have done and when you should schedule them. If you go to your dealer for your service needs, you'll know that GM-trained and supported service people will perform the work using genuine GM parts.

The proper fluids and lubricants to use are listed in Part D. Make sure whoever services your vehicle uses these. All parts should be replaced and all necessary repairs done before you or anyone else drives the vehicle.

This schedule is for vehicles that:

- carry passengers and cargo within recommended limits. You will find these limits on your vehicle's Tire-Loading Information label. See "Loading Your Vehicle" in the Index.
- are driven on reasonable road surfaces within legal driving limits.
- use the recommended fuel. See "Fuel" in the Index.

Maintenance Schedule

The services shown in this schedule up to 100,000 miles (160 000 km) should be performed after 100,000 miles (160 000 km) at the same intervals. The services shown at 150,000 miles (240 000 km) should be performed at the same interval after 150,000 miles (240 000 km).

See "Owner Checks and Services" and "Periodic Maintenance Inspections" following.

Footnotes

† The U.S. Environmental Protection Agency or the California Air Resources Board has determined that the failure to perform this maintenance item will not nullify the emissions warranty or limit recall liability prior to the completion of the vehicle's useful life. We, however, urge that all recommended maintenance services be performed at the indicated intervals and the maintenance be recorded.

* Your Corvette has an Engine Oil Life Monitor. This monitor will show you when to change the oil -- usually between 3,000 miles (5 000 km) and 10,000 miles (16 000 km) since your last oil change. Under severe conditions, the indicator may come on before 3,000 miles (5 000 km). Never drive your vehicle more than 10,000 miles (16 000 km) or 12 months without an oil change. Use engine oil meeting the GM Standard GM4718M.

The Engine Oil Life Monitor won't detect dust in the oil. So if you drive in a dusty area, be sure to change your oil every 3,000 miles (5 000 km) or sooner if the CHANGE OIL light comes on. Remember to reset the Oil Life Monitor when the oil has been changed. For more information, see "Engine Oil Life Monitor" in the Index.

Maintenance Schedule

10,000 Miles (16 000 km)

- Check the Engine Oil Life Monitor. If engine oil and filter are changed, reset the Engine Oil Life Monitor. See "Engine Oil" in the Index.
An Emission Control Service. (See footnote *.)
- Inspect air cleaner filter if you are driving in dusty conditions. Replace filter if necessary. *An Emission Control Service.* (See footnote †.)

20,000 Miles (32 000 km)

- Check the Engine Oil Life Monitor. If engine oil and filter are changed, reset the Engine Oil Life Monitor. See "Engine Oil" in the Index.
An Emission Control Service. (See footnote *.)
- Inspect air cleaner filter if you are driving in dusty conditions. Replace filter if necessary. *An Emission Control Service.* (See footnote †.)

30,000 Miles (48 000 km)

- Check the Engine Oil Life Monitor. If engine oil and filter are changed, reset the Engine Oil Life Monitor. See "Engine Oil" in the Index.
An Emission Control Service. (See footnote *.)
- Replace air cleaner filter. *An Emission Control Service.*
- Inspect fuel tank, cap and lines for damage or leaks. Inspect fuel cap gasket for any damage. Replace parts as needed.
An Emission Control Service. (See footnote †.)

DATE	
ACTUAL MILEAGE	SERVICED BY:

DATE	
ACTUAL MILEAGE	SERVICED BY:

DATE	
ACTUAL MILEAGE	SERVICED BY:

Maintenance Schedule

40,000 Miles (64 000 km)

- Check the Engine Oil Life Monitor. If engine oil and filter are changed, reset the Engine Oil Life Monitor. See "Engine Oil" in the Index.
An Emission Control Service. (See footnote *.)
- Inspect air cleaner filter if you are driving in dusty conditions. Replace filter if necessary.
An Emission Control Service. (See footnote †.)

50,000 Miles (80 000 km)

- Check the Engine Oil Life Monitor. If engine oil and filter are changed, reset the Engine Oil Life Monitor. See "Engine Oil" in the Index.
An Emission Control Service. (See footnote *.)
- Inspect air cleaner filter if you are driving in dusty conditions. Replace filter if necessary.
An Emission Control Service. (See footnote †.)
- Change automatic transmission fluid and filter if the vehicle is mainly driven under one or more of these conditions:
 - In heavy city traffic where the outside temperature regularly reaches 90°F (32°C) or higher.
 - In hilly or mountainous terrain.
 - Uses such as high performance operation.

If you do not use your vehicle under any of these conditions, change the fluid and filter at 100,000 miles (166 000 km). Manual transmission fluid doesn't require change.

DATE	
ACTUAL MILEAGE	SERVICED BY:

DATE	
ACTUAL MILEAGE	SERVICED BY:

Maintenance Schedule

60,000 Miles (96 000 km)

- Check the Engine Oil Life Monitor. If engine oil and filter are changed, reset the Engine Oil Life Monitor. See "Engine Oil" in the Index.
*An Emission Control Service. (See footnote *.)*
- Replace air cleaner filter. *An Emission Control Service.*
- Inspect fuel tank, cap and lines for damage or leaks. Inspect fuel cap gasket for any damage. Replace parts as needed.
An Emission Control Service. (See footnote †.)
- Inspect engine accessory drive belt. *An Emission Control Service.*

70,000 Miles (112 000 km)

- Check the Engine Oil Life Monitor. If engine oil and filter are changed, reset the Engine Oil Life Monitor. See "Engine Oil" in the Index.
*An Emission Control Service. (See footnote *.)*
- Inspect air cleaner filter if you are driving in dusty conditions. Replace filter if necessary. *An Emission Control Service. (See footnote †.)*

80,000 Miles (128 000 km)

- Check the Engine Oil Life Monitor. If engine oil and filter are changed, reset the Engine Oil Life Monitor. See "Engine Oil" in the Index.
*An Emission Control Service. (See footnote *.)*
- Inspect air cleaner filter if you are driving in dusty conditions. Replace filter if necessary. *An Emission Control Service. (See footnote †.)*

DATE	
ACTUAL MILEAGE	SERVICED BY:

DATE	
ACTUAL MILEAGE	SERVICED BY:

DATE	
ACTUAL MILEAGE	SERVICED BY:

Maintenance Schedule

90,000 Miles (144 000 km)

- Check the Engine Oil Life Monitor. If engine oil and filter are changed, reset the Engine Oil Life Monitor. See "Engine Oil" in the Index.
*An Emission Control Service. (See footnote *.)*
- Replace air cleaner filter. *An Emission Control Service.*
- Inspect fuel tank, cap and lines for damage or leaks. Inspect fuel cap gasket for any damage. Replace parts as needed.
An Emission Control Service. (See footnote †.)

100,000 Miles (160 000 km)

- Check the Engine Oil Life Monitor. If engine oil and filter are changed, reset the Engine Oil Life Monitor. See "Engine Oil" in the Index.
*An Emission Control Service. (See footnote *.)*
- Inspect air cleaner filter if you are driving in dusty conditions. Replace filter if necessary. *An Emission Control Service. (See footnote †.)*
- Replace spark plugs. *An Emission Control Service.*
- Inspect spark plug wires. *An Emission Control Service.*

DATE	
ACTUAL MILEAGE	SERVICED BY:

DATE	
ACTUAL MILEAGE	SERVICED BY:

(Continued)

Maintenance Schedule

100,000 Miles (160 000 km) (Continued)

- Change automatic transmission fluid and filter if the vehicle is mainly driven under one or more of these conditions:
 - In heavy city traffic where the outside temperature regularly reaches 90°F (32°C) or higher.
 - In hilly or mountainous terrain.
 - Uses such as high performance operation.Manual transmission fluid doesn't require change.
- If you haven't used your vehicle under severe conditions listed previously and, therefore, haven't changed your automatic transmission fluid, change both the fluid and the filter. Manual transmission fluid doesn't require change.

150,000 Miles (240 000 km)

- Drain, flush and refill the cooling system (or every 60 months since last service, whichever occurs first). See "Engine Coolant" in the Index for what to use.
An Emission Control Service.

DATE	
ACTUAL MILEAGE	SERVICED BY:

Part B: Owner Checks and Services

Listed below are owner checks and services which should be performed at the intervals specified to help ensure the safety, dependability and emission control performance of your vehicle.

Be sure any necessary repairs are completed at once. Whenever any fluids or lubricants are added to your vehicle, make sure they are the proper ones, as shown in Part D.

At Each Fuel Fill

It is important for you or a service station attendant to perform these underhood checks at each fuel fill.

Engine Oil Level Check

Check the engine oil level and add the proper oil if necessary. See "Engine Oil" in the Index for further details.

Engine Coolant Level Check

Check the engine coolant level and add DEX-COOL[®] coolant mixture if necessary. See "Engine Coolant" in the Index for further details.

Windshield Washer Fluid Level Check

Check the windshield washer fluid level in the windshield washer tank and add the proper fluid if necessary. See "Windshield Washer Fluid" in the Index for further details.

At Least Once a Month

Tire Inflation Check

Make sure tires are inflated to the correct pressures. See "Tires" in the Index for further details.

Cassette Deck Service

Clean cassette deck. Cleaning should be done every 50 hours of tape play. See "Audio Systems" in the Index for further details.

Power Antenna Service

Clean power antenna mast. See "Audio Systems" in the Index for further details.

At Least Twice a Year

Restraint System Check

Make sure the safety belt reminder light and all your belts, buckles, latch plates, retractors and anchorages are working properly. Look for any other loose or damaged safety belt system parts. If you see anything that might keep a safety belt system from doing its job, have it repaired. Have any torn or frayed safety belts replaced.

Also look for any opened or broken air bag coverings, and have them repaired or replaced. (The air bag system does not need regular maintenance.)

Wiper Blade Check

Inspect wiper blades for wear or cracking. Replace blade inserts that appear worn or damaged or that streak or miss areas of the windshield. Also see "Wiper Blades, Cleaning" in the Index.

Manual Transmission Check

Check the transmission fluid level; add if needed. See "Manual Transmission" in the Index. Check for leaks. A fluid loss may indicate a problem. Have the system inspected and repaired if needed.

Automatic Transmission Inspection

It is not necessary to check the transmission fluid level. A transmission fluid leak is the only reason for fluid loss. Check for leaks. If a leak occurs, take the vehicle to your GM dealership Service Department and have it repaired as soon as possible.

At Least Once a Year

Key Lock Cylinders Service

Lubricate the key lock cylinders with the lubricant specified in Part D.

Body Lubrication Service

Lubricate all body door hinges. Also lubricate all hinges and latches, including those for the hood, rear compartment, console door and any folding seat hardware. Part D tells you what to use. More frequent lubrication may be required when exposed to a corrosive environment.

Starter Switch Check

CAUTION:

When you are doing this check, the vehicle could move suddenly. If it does, you or others could be injured. Follow the steps below.

1. Before you start, be sure you have enough room around the vehicle.
2. Firmly apply both the parking brake (see “Parking Brake” in the Index if necessary) and the regular brake.

NOTE: Do not use the accelerator pedal, and be ready to turn off the engine immediately if it starts.

3. On automatic transmission vehicles, try to start the engine in each gear. The starter should work only in PARK (P) or NEUTRAL (N). If the starter works in any other position, your vehicle needs service.

On manual transmission vehicles, put the shift lever in NEUTRAL (N), push the clutch down halfway and try to start the engine. The starter should work only when the clutch is pushed down all the way to the floor. If the starter works when the clutch isn't pushed all the way down, your vehicle needs service.

Brake-Transmission Shift Interlock (BTSI) Check (Automatic Transmission)

CAUTION:

When you are doing this check, the vehicle could move suddenly. If it does, you or others could be injured. Follow the steps below.

1. Before you start, be sure you have enough room around the vehicle. It should be parked on a level surface.
2. Firmly apply the parking brake (see “Parking Brake” in the Index if necessary).

NOTE: Be ready to apply the regular brake immediately if the vehicle begins to move.

3. With the engine off, turn the key to the ON position, but don't start the engine. Without applying the regular brake, try to move the shift lever out of PARK (P) with normal effort. If the shift lever moves out of PARK (P), your vehicle's BTSI needs service.

Ignition Automatic Transmission Lock Check

While parked, and with the parking brake set, try to turn the ignition key to OFF in each shift lever position. The key should turn to OFF only when the shift lever is in PARK (P).

On all vehicles, the key should come out only in OFF.

Parking Brake and Automatic Transmission PARK (P) Mechanism Check

CAUTION:

When you are doing this check, your vehicle could begin to move. You or others could be injured and property could be damaged. Make sure there is room in front of your vehicle in case it begins to roll. Be ready to apply the regular brake at once should the vehicle begin to move.

Park on a fairly steep hill, with the vehicle facing downhill. Keeping your foot on the regular brake, set the parking brake.

- To check the parking brake's holding ability: With the engine running and transmission in NEUTRAL (N), slowly remove foot pressure from the regular brake pedal. Do this until the vehicle is held by the parking brake only.
- To check the PARK (P) mechanism's holding ability: With the engine running, shift to PARK (P). Then release all brakes.

Underbody Flushing Service

At least every spring, use plain water to flush any corrosive materials from the underbody. Take care to clean thoroughly any areas where mud and other debris can collect.

Part C: Periodic Maintenance Inspections

Listed below are inspections and services which should be performed at least twice a year (for instance, each spring and fall). You should let your dealer's service department or other qualified service center do these jobs. Make sure any necessary repairs are completed at once.

Proper procedures to perform these services may be found in a service manual. See "Service and Owner Publications" in the Index.

Steering and Suspension Inspection

Inspect the front and rear suspension and steering system for damaged, loose or missing parts; signs of wear or lack of lubrication. Inspect the power steering lines and hoses for proper hook-up, binding, leaks, cracks, chafing, etc.

Tire and Wheel Inspection

Inspect the tires for uneven wear or damage. If there is irregular or premature wear, check the wheel alignment. Inspect for damaged wheels.

Exhaust System Inspection

Inspect the complete exhaust system. Inspect the body near the exhaust system. Look for broken, damaged,

missing or out-of-position parts as well as open seams, holes, loose connections or other conditions which could cause a heat build-up in the floor pan or could let exhaust fumes into the vehicle. See "Engine Exhaust" in the Index.

Radiator and Heater Hose Inspection

Inspect the hoses and have them replaced if they are cracked, swollen or deteriorated. Inspect all pipes, fittings and clamps; replace as needed. Clean the outside of the radiator and air conditioning condenser. To help ensure proper operation, a pressure test of the cooling system and pressure cap is recommended at least once a year.

Rear Axle Service

Check the gear lubricant level in the rear axle and add if needed. See "Rear Axle" in the Index. A fluid loss may indicate a problem. Check the axle and repair it if needed.

Brake System Inspection

Inspect the complete system. Inspect brake lines and hoses for proper hook-up, binding, leaks, cracks, chafing, etc. Inspect disc brake pads for wear and rotors for surface condition. Inspect other brake parts, including calipers, parking brake, etc. You may need to have your brakes inspected more often if your driving habits or conditions result in frequent braking.

Part D: Recommended Fluids and Lubricants

NOTE: Fluids and lubricants identified below by name, part number or specification may be obtained from your dealer.

USAGE	FLUID/LUBRICANT
Engine Oil	The engine requires a special Engine Oil meeting GM Standard GM4718M. Oils meeting this Standard may be identified as synthetic, and should also be identified with the American Petroleum Institute Certified For Gasoline Engines "Starburst" symbol. However, not all Synthetic API oils with the Starburst symbol will meet this GM Standard. You should look for and use only an oil that meets GM Standard GM4718M. For the proper viscosity, see "Engine Oil" in the Index.

USAGE	FLUID/LUBRICANT
Engine Coolant	50/50 mixture of clean water (preferably distilled) and use only GM Goodwrench [®] DEX-COOL [™] or Havoline [®] DEX-COOL [™] Coolant. See "Engine Coolant" in the Index.
Hydraulic Brake System	Delco Supreme 11 [®] Brake Fluid (GM Part No. 12377967 or equivalent DOT-3 Brake Fluid).
Hydraulic Clutch System	Hydraulic Clutch Fluid (GM Part No. 12345347 or equivalent DOT-3 Brake Fluid).
Power Steering System	GM Synthetic Power Steering Fluid (GM Part No. 12345866 or 12345867 or equivalent).
Manual Transmission	DEXRON [®] -III Automatic Transmission Fluid.
Automatic Transmission	DEXRON [®] -III Automatic Transmission Fluid.

USAGE	FLUID/LUBRICANT
Key Lock Cylinders	Multi-Purpose Lubricant, Superlube [™] (GM Part No. 12346241 or equivalent).
Rear Axle (Limited-Slip Differential)	Axle Lubricant (GM Part No. 12345977) and 4 ounces (118 ml) of Limited-Slip Differential Lubricant Additive (GM Part No. 1052358 or equivalent) where required. See "Rear Axle" in the Index.
Windshield Washer Solvent	GM Optikleem [®] Washer Solvent (GM Part No. 1051515) or equivalent.

USAGE	FLUID/LUBRICANT
Hood Latch Assembly, Pivots, Spring Anchor and Release Pawl	Lubriplate Lubricant Aerosol (GM Part No. 12346293 or equivalent) or lubricant meeting requirements of NLGI # 2, Category LB or GC-LB.
Hood and Door Hinges	Multi-Purpose Lubricant, Superlube [™] (GM Part No. 12346241 or equivalent).
Weatherstrip Conditioning	Dielectric Silicone Grease (GM Part No. 12345579 or equivalent).

Part E: Maintenance Record

After the scheduled services are performed, record the date, odometer reading and who performed the service in the boxes provided after the maintenance interval.

Any additional information from "Owner Checks and Services" or "Periodic Maintenance" can be added on the following record pages. Also, you should retain all maintenance receipts. Your owner information portfolio is a convenient place to store them.

Maintenance Record

DATE	ODOMETER READING	SERVICED BY	MAINTENANCE PERFORMED

Maintenance Record

DATE	ODOMETER READING	SERVICED BY	MAINTENANCE PERFORMED

Maintenance Record

DATE	ODOMETER READING	SERVICED BY	MAINTENANCE PERFORMED



Section 8 Customer Assistance Information

Here you will find out how to contact Chevrolet if you need assistance. This section also tells you how to obtain service publications and how to report any safety defects.

8-2	Customer Satisfaction Procedure	8-10	Warranty Information
8-4	Customer Assistance for Text Telephone (TTY) Users	8-10	Reporting Safety Defects to the United States Government
8-5	Chevrolet Roadside Assistance Program	8-11	Reporting Safety Defects to the Canadian Government
8-7	Canadian Roadside Assistance	8-11	Reporting Safety Defects to General Motors
8-8	Courtesy Transportation	8-11	Ordering Service and Owner Publications in Canada
8-9	GM Participation in an Alternative Dispute Resolution Program		

Customer Satisfaction Procedure



Chevrolet dealers have the facilities, trained technicians and up-to-date information to promptly address any concerns you may have. However, if a concern has not been resolved to your complete satisfaction, take the following steps:

STEP ONE -- Discuss your concern with a member of dealership management. Normally, concerns can be quickly resolved at that level. If the matter has already been reviewed with the sales, service or parts manager, contact the owner of the dealership or the general manager.

STEP TWO -- If after contacting a member of dealership management, it appears your concern cannot be resolved by the dealership without further help, contact the Chevrolet Customer Assistance Center by calling 1-800-222-1020. In Canada, contact GM of Canada Customer Communication Centre in Oshawa by calling 1-800-263-3777 (English) or 1-800-263-7854 (French).

For help outside of the United States and Canada, call the following numbers as appropriate:

- In Mexico: (525) 625-3256
- In Puerto Rico: 1-800-496-9992 (English) or 1-800-496-9993 (Spanish)
- In the U.S. Virgin Islands: 1-800-496-9994
- In the Dominican Republic: 1-800-751-4135 (English) or 1-800-751-4136 (Spanish)
- In the Bahamas: 1-800-389-0009
- In Bermuda, Barbados, Antigua and the British Virgin Islands: 1-800-534-0122
- In all other Caribbean countries: (809) 763-1315
- In other overseas locations, call GM Overseas Distribution Corporation in Canada at: (905) 644-4112.

For prompt assistance, please have the following information available to give the Customer Assistance Representative:

- Your name, address, home and business telephone numbers
- Vehicle Identification Number (This is available from the vehicle registration or title, or the plate at the top left of the instrument panel and visible through the windshield.)
- Dealership name and location
- Vehicle delivery date and present mileage
- Nature of concern

We encourage you to call us so we can give your inquiry prompt attention. However, if you wish to write Chevrolet, address your inquiry to:

Chevrolet Motor Division
Chevrolet Customer Assistance Center
P.O. Box 7047
Troy, MI 48007-7047

In Canada, write to:

General Motors of Canada Limited
Customer Communication Centre, 163-005
1908 Colonel Sam Drive
Oshawa, Ontario L1H 8P7

Refer to your Warranty and Owner Assistance Information booklet for addresses of GM Overseas offices.

When contacting Chevrolet, please remember that your concern will likely be resolved in the dealership, using the dealer's facilities, equipment and personnel. That is why we suggest you follow Step One first if you have a concern.

Customer Assistance for Text Telephone (TTY) Users

To assist customers who are deaf, hard of hearing, or speech-impaired and who use Text Telephones (TTYs), Chevrolet has TTY equipment available at its Customer Assistance Center. Any TTY user can communicate with Chevrolet by dialing: 1-800-833-CHEV. (TTY users in Canada can dial 1-800-263-3830.)

Chevrolet Roadside Assistance Program

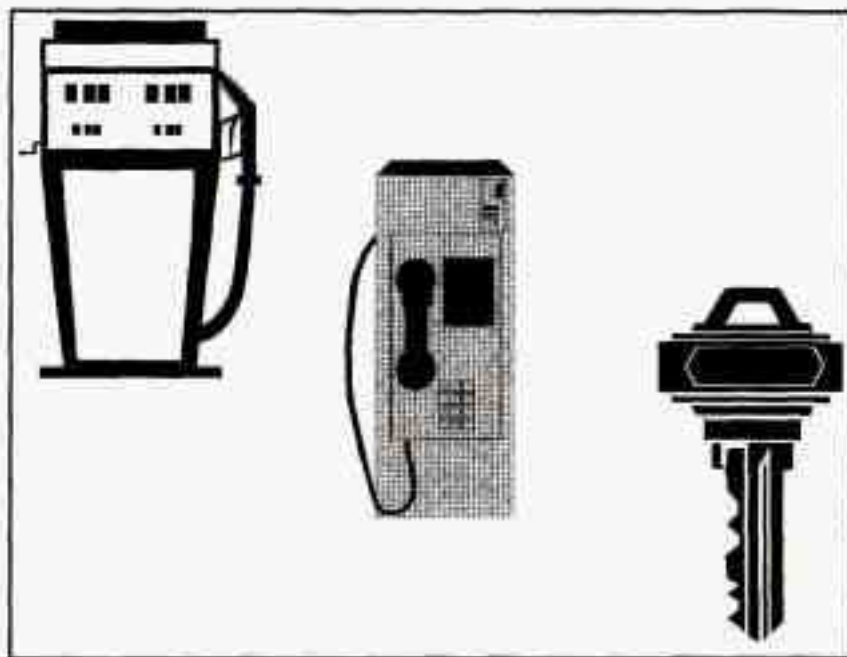

To enhance Chevrolet's strong commitment to customer satisfaction, Chevrolet is excited to announce the establishment of the Chevrolet Roadside Assistance Center. As the owner of a 1998 Chevrolet, membership in Roadside Assistance is free.

Roadside Assistance is available 24 hours a day, 365 days a year, by calling 1-800-CHEV-USA (1-800-243-8872). This toll-free number will provide you over-the-phone roadside assistance with minor mechanical problems. If your problem cannot be resolved over the phone, our advisors have access to a nationwide network of dealer recommended service providers. Roadside membership is free, however some services may incur costs.

Roadside offers two levels of service to the customer, *Basic Care* and *Courtesy™ Care*:

- Toll-free number, 1-800-CHEV-USA
- Free towing for warranty repairs
- Basic over-the-phone technical advice
- Available dealer services at reasonable costs (i.e., wrecker services, locksmith/key service, glass repair, etc.)

ROADSIDE *Courtesy*[™] *Care* PROVIDES:

- Roadside *Basic Care* services (as outlined previously)
Plus:
- FREE Non-Warranty Towing (to the closest dealer from a legal roadway)
- FREE Locksmith/Key Service (when keys are lost on the road or locked inside)
- FREE Jump Start (at home or on the road)
- FREE Fuel Delivery (\$5 of fuel delivered on the road)

Chevrolet offers *Courtesy Transportation* for customers needing warranty service. *Courtesy Transportation* will be offered in conjunction with the coverage provided by the Bumper to Bumper New Vehicle Limited Warranty to eligible purchasers of 1998 Chevrolet passenger car and light duty trucks. (Please see your selling dealer for details.)

Note: *Courtesy Care* is available to retail and retail lease customers operating 1998 and newer Chevrolet vehicles for a period of 3 years/36,000 miles (60 000 km), whichever occurs first. All *Courtesy Care* services must be pre-arranged by Chevrolet Roadside or dealer Service Management.

Basic Care and *Courtesy Care* are not part of or included in the coverage provided by the New Vehicle Limited Warranty. Chevrolet reserves the right to modify or discontinue *Basic Care* and *Courtesy Care* at any time.

For complete program details, see your Chevrolet dealer to obtain a Roadside Assistance Center brochure.

The Roadside Assistance Center uses companies that will provide you with quality and priority service. When roadside services are required, our advisors will explain any payment obligations that may be incurred for utilizing outside services.

For prompt assistance when calling, please have the following available to give to the advisor:

- Vehicle Identification Number (VIN)
- License plate number
- Vehicle color
- Vehicle location
- Telephone number where you can be reached
- Vehicle mileage
- Description of problem

Please refer to the Roadside Assistance brochure inside your owner information portfolio for full program details.

Canadian Roadside Assistance

Vehicles purchased in Canada have an extensive Roadside Assistance program accessible from anywhere in Canada or the United States. Please refer to the separate brochure provided by the dealer or call 1-800-268-6800 for emergency services.

Courtesy Transportation

Chevrolet offers Courtesy Transportation for customers needing warranty service. Courtesy Transportation will be offered in conjunction with the coverage provided by the Bumper to Bumper New Vehicle Limited Warranty to retail purchasers of 1998 Chevrolet passenger cars and light duty trucks (please see your selling dealer for details).

Courtesy Transportation includes:

- One way shuttle ride for any warranty repair completed during the same day.
- Up to \$30 maximum daily vehicle rental allowance for any overnight warranty repair up to five days, OR
- Up to \$30 maximum daily cab, bus or other transportation allowance in lieu of rental for any overnight warranty repair up to five days, OR
- Up to \$10 daily fuel allowance for rides provided by another person (i.e., friend, neighbor, etc.) in lieu of rental for any overnight warranty repair up to five days.

Note: All Courtesy Transportation arrangements will be administered by your Chevrolet dealer service management. Claim amounts should reflect all actual costs.

- Chevrolet Courtesy Transportation is not part of the Bumper to Bumper New Vehicle Limited Warranty. Chevrolet reserves the right to make any changes or discontinue Courtesy Transportation at any time without notification.
- For additional program details, contact your Chevrolet dealer.

Some state insurance regulations make it impractical to rent vehicles to people under 21 years of age. If you are under 21 and have difficulty renting a vehicle, Chevrolet will reimburse up to \$30/day for documented transportation you receive.

For warranty repairs during the Complete Vehicle Coverage period in the New Vehicle Limited Warranty, interim transportation may be available under the Courtesy Transportation Program. Please consult your dealer for details. The Roadside Assistance program is available only in the United States and Canada.

In Canada, please consult your GM dealer for information on Courtesy Transportation.

GM Participation in an Alternative Dispute Resolution Program

This program is available in all 50 states and the District of Columbia. Canadian owners refer to your Warranty and Owner Assistance Information booklet for information on the Canadian Motor Vehicle Arbitration Plan (CAMVAP). General Motors reserves the right to change eligibility limitations and/or to discontinue its participation in this program.

Both Chevrolet and your Chevrolet dealer are committed to making sure you are completely satisfied with your new vehicle. Our experience has shown that, if a situation arises where you feel your concern has not been adequately addressed, the Customer Satisfaction Procedure described earlier in this section is very successful.

There may be instances where an impartial third party can assist in arriving at a solution to a disagreement regarding vehicle repairs or interpretation of the New Vehicle Limited Warranty. To assist in resolving these disagreements, Chevrolet voluntarily participates in BBB AUTO LINE.

BBB AUTO LINE is an out-of-court program administered by the Better Business Bureau system to settle automotive disputes. This program is available free of charge to customers who currently own or lease a GM vehicle.

If you are not satisfied after following the Customer Satisfaction Procedure, you may contact the BBB using the toll-free telephone number, or write them at the following address:

BBB AUTO LINE
Council of Better Business Bureaus, Inc.
4200 Wilson Boulevard
Suite 800
Arlington, VA 22203-1804
Telephone: 1-800-955-5100

To file a claim, you will be asked to provide your name and address, your Vehicle Identification Number (VIN) and a statement of the nature of your complaint. Eligibility is limited by vehicle age and mileage, and other factors.

We prefer you utilize the Customer Satisfaction Procedure before you resort to AUTO LINE, but you may contact the BBB at any time. The BBB will attempt to resolve the complaint serving as an intermediary. If this mediation is unsuccessful, an informal hearing will be scheduled where eligible customers may present their case to an impartial third-party arbitrator.

The arbitrator will make a decision which you may accept or reject. If you accept the decision, GM will be bound by that decision. The entire dispute resolution procedure should ordinarily take about 40 days from the time you file a claim until a decision is made.

Some state laws may require you to use this program before filing a claim with a state-run arbitration program or in the courts. For further information, contact the BBB at 1-800-955-5100 or the Chevrolet Customer Assistance Center at 1-800-222-1020.

Warranty Information

Your vehicle comes with a separate warranty booklet that contains detailed warranty information.

REPORTING SAFETY DEFECTS TO THE UNITED STATES GOVERNMENT

If you believe that your vehicle has a defect which could cause a crash or could cause injury or death, you should immediately inform the National Highway Traffic Safety Administration (NHTSA), in addition to notifying General Motors.

If NHTSA receives similar complaints, it may open an investigation, and if it finds that a safety defect exists in a group of vehicles, it may order a recall and remedy campaign. However, NHTSA cannot become involved in individual problems between you, your dealer or General Motors.

To contact NHTSA, you may either call the Auto Safety Hotline toll-free at 1-800-424-9393 (or 366-0123 in the Washington, D.C. area) or write to:

NHTSA, U.S. Department of Transportation
Washington, D.C. 20590

You can also obtain other information about motor vehicle safety from the Hotline.

REPORTING SAFETY DEFECTS TO THE CANADIAN GOVERNMENT

If you live in Canada, and you believe that your vehicle has a safety defect, you should immediately notify Transport Canada, in addition to notifying General Motors of Canada Limited. You may write to:

Transport Canada
Box 8880
Ottawa, Ontario K1G 3J2

REPORTING SAFETY DEFECTS TO GENERAL MOTORS

In addition to notifying NHTSA (or Transport Canada) in a situation like this, we certainly hope you'll notify us. Please call us at 1-800-222-1020 or write:

Chevrolet Motor Division
Chevrolet Customer Assistance Center
P.O. Box 7047
Troy, MI 48007-7047

In Canada, please call us at 1-800-263-3777 (English) or 1-800-263-7854 (French). Or, write:

General Motors of Canada Limited
Customer Communication Centre, 163-005
1908 Colonel Sam Drive
Oshawa, Ontario L1H 8P7

Ordering Service and Owner Publications in Canada

Service manuals, owner's manuals and other service literature are available for purchase for all current and past model General Motors vehicles.

The toll-free telephone number for ordering information in Canada is 1-800-668-5539.

1998 CHEVROLET SERVICE PUBLICATIONS ORDERING INFORMATION

The following publications covering the operation and servicing of your vehicle can be purchased by filling out the Service Publication Order Form in this book and mailing it in with your check, money order, or credit card information to Helm, Incorporated (address below.)

CURRENT PUBLICATIONS FOR 1998 CHEVROLET

SERVICE MANUALS

Service Manuals have the diagnosis and repair information on engines, transmission, axle, suspension, brakes, electrical, steering, body, etc.

RETAIL SELL PRICE: \$90.00

TRANSMISSION, TRANSAXLE, TRANSFER CASE UNIT REPAIR MANUAL

This manual provides information on unit repair service procedures, adjustments and specifications for the 1998 GM transmissions, transaxles and transfer cases.

RETAIL SELL PRICE: \$40.00

SERVICE BULLETINS

Service Bulletins give technical service information needed to knowledgeably service General Motors cars and trucks. Each bulletin contains instructions to assist in the diagnosis and service of your vehicle.

OWNER'S INFORMATION

Owner publications are written directly for Owners and intended to provide basic operational information about the vehicle. The owner's manual will include the Maintenance Schedule for all models.

In-Portfolio: Includes a Portfolio, Owner's Manual and Warranty Booklet.

RETAIL SELL PRICE: \$15.00

Without Portfolio: Owner's Manual only.

RETAIL SELL PRICE: \$10.00

CURRENT & PAST MODEL ORDER FORMS

Service Publications are available for current and past model GM vehicles. To request an order form, please specify year and model name of the vehicle.

PLEASE COMPLETE THE ORDER FORM SHOWN ON THE FOLLOWING PAGE AND MAIL TO:

Helm, Incorporated • P.O. Box 07130 • Detroit, MI 48207

OR ORDER TOLL FREE: 1-800-782-4356

Monday-Friday 8:00 AM – 6:00 PM Eastern Time

For Credit Card Orders Only (VISA–MasterCard–Discover)

ORDER TOLL FREE*(NOTE: For Credit Card Holders Only)***1-800-782-4356**

Monday-Friday 8:00 AM - 6:00 PM EST

FAX Orders Only 1-313-865-5927

Orders will be mailed within 10 days of receipt. Please allow adequate time for postal service. If further information is needed, write to the address shown below or call 1-800-782-4356. Material cannot be returned for credit without packing slip with return information within 30 days of delivery. On returns, a re-stocking fee may be applied against the original order.

1 9 9 8 G M	PUBLICATION FORM NUMBER	ITEM DESCRIPTION	VEHICLE MODEL		QTY.	PRICE EACH*	TOTAL PRICE
			NAME	YEAR			
		Service Manual		1998		\$90.00	
		Car & Light Truck Transmission Unit Repair		1998		\$40.00	
		Owner's Manual In Portfolio		1998		\$15.00	
		Owner's Manual Without Portfolio		1998		\$10.00	

S
H
I
P
T
O

NOTE: Dealers and Companies please provide dealer or company name, and also the name of the person to whose attention the shipment should be sent.

Mail completed order form to:

HELM, INCORPORATED • P.O. Box 07130 • Detroit, MI 48207

For purchases outside U.S.A. please write to the above address for quotation.

(CUSTOMER'S NAME) (ATTENTION)_____
(STREET ADDRESS—NO P.O. BOX NUMBERS)_____
(CITY) (STATE) (ZIP CODE)_____
DAYTIME TELEPHONE NO.()
AREA CODEP
A
Y
M
E
N
T
 Check or Money
Order payable to
Helm, Inc. (USA funds
only — do not send cash.)

 MasterCard

 VISA

 Discover

 Account Number:

 Expiration Date mo/yr: Check here if your billing address is different from your shipping address shown.

CUSTOMER SIGNATURE**TOTAL MATERIAL**Michigan Purchasers
add 6% sales taxU.S. Order Processing **\$5.00**Canadian Postage
(See Note Below)**GRAND TOTAL**

 **NOTES**



Section 9 Index

- A**
Accessory Outlet 2-59
Accessory Power Plug 6-63
Adding Equipment to the Outside of Your Vehicle 6-3
Air Bag 1-18
 How Does it Restrain 1-23
 How it Works 1-20
 Location 1-20, 1-21
 Servicing 1-24
 What Makes it Inflate 1-22
 What Will You See After it Inflates 1-23
 When Should it Inflate 1-22
Air Bag Readiness Light 1-20, 2-78
Air Bag System 1-18
Air Cleaner 6-16
Air Conditioning 3-3, 3-7, 3-10
Alignment and Balance, Tire 6-48
Aluminum Wheels, Cleaning 6-58
Antenna
 Integrated 3-30
 Power Mast 3-29
Antifreeze 6-22
Anti-Lock
 Brakes 4-7
 Brake System Warning Light 2-78, 4-7
Anti-Lock Brake System Warning Light 2-80
Anti-Theft Radio 3-25
Appearance Care 6-52
Appearance Care Materials 6-61
Arbitration Program 8-9
Ashtray 2-58
Audio Equipment, Adding 3-27
Audio Systems 3-12
Automatic
 Electronic Dual Climate Control System 3-4
 Overdrive 2-28
 Transmission Check 7-12
 Transmission Fluid 6-18
 Transmission, Operation 2-26
 Transmission, Park Mechanism Check 7-14
 Transmission, Shifting 2-26
 Transmission, Starting Your Engine 2-22
Axle, Limited-Slip Rear 2-39
Axle, Rear 6-21
B
Back-up Lamp Bulb Replacement 6-37
Battery 6-32
 Jump Starting 5-3
 Replacement, Remote Function
 Actuation (RFA) System 2-12
 Warnings 5-3, 5-5
BBB Auto Line 8-9
Belt, Engine Accessory 6-72
Better Business Bureau Mediation 8-9
Blizzard 4-26
Brake
 Adjustment 6-31
 Fluid 6-29

Brake (Continued)			
Master Cylinder	6-29	Types	1-27
Parking	2-32	Where to Put	1-27
Pedal Travel	6-31	Cigarette Lighter	2-58
Replacing System Parts	6-32	Circuit Breakers and Fuses	6-64
System Warning Light	2-79	Cleaner, Air	6-16
Transmission Shift Interlock	2-36	Cleaning	
Wear	6-31	Aluminum Wheels	6-58
Brakes, Anti-Lock	4-7	Coated Moldings	6-53
Brake-Transmission Shift Interlock Check	7-13	Convenience Net	6-54
Braking	4-6	Exterior Lamps/Lenses	6-56
Braking in Emergencies	4-9	Fabric	6-53
Break-In, New Vehicle	2-20	Glass	6-54
BTSI	2-36	Inside of Your Vehicle	6-52
BTSI Check	7-13	Instrument Panel	6-54
Bulb Replacement	6-33, 6-69	Leather	6-53
		Outside of Your Vehicle	6-56
		Removable Roof Panel	6-55
		Security Shade	6-54
		Soft-Touch Paint Surfaces	6-54
		Stains	6-53
		Tires	6-58
		Vinyl	6-53
		Weatherstrips	6-55
		Wheels	6-58
		Windshield and Wiper Blades	6-55
Canadian Roadside Assistance	8-7	Climate Control, Automatic Electronic Dual	3-4
Capacities and Specifications	6-70	Clock, Setting the	3-12
Carbon Monoxide	2-15, 2-37, 4-28	Clutch, Hydraulic	6-20
Cassette Deck Service	7-11	Comfort Controls	3-1
Cassette Tape Player	3-12	Comfort Controls, Manual	3-2
Care of Your	3-28	Compact Disc	
Center Console	2-55	Adapter Kit	3-17
Certification Label	4-29	Care	3-29
Chains, Tire	6-51	Changer, Trunk Mounted	3-21
Check Gages Light	2-85		
Checking Your Restraint Systems	1-37		
Chemical Paint Spotting	6-60		
Child Restraints	1-27		
Add-on	1-27		
Securing in the Passenger Seat Position	1-28		
Top Strap	1-31		

Player	3-17	Door	
Care	3-29	Locks	2-4
Competitive Driving	2-24	Downshifting	2-31
Console, Center	2-55	Driver Information Center (DIC)	2-87
Control of a Vehicle	4-5	Warnings and Messages	2-97
Convenience Net	2-57	Controls and Displays	2-88
Convenience Net, Cleaning	6-54	Driver Information Center (DIC) Messages:	
Convertible Top	2-68	ABS active	2-98
Convex Outside Mirror	2-54	Charge System Fault	2-99
Coolant	5-13, 5-16, 6-22	Coolant Over Temp	2-101
Surge Tank	5-18	Flat Tire - (lf, lr, rf, rr)	2-104
Surge Tank Pressure Cap	6-26	High Oil Temperature Reduce Engine rpm	2-102
Coolant Heater, Engine	2-24	High Tire Pressure - (lf, lr, rf, rr)	2-105
Cooling System	5-16	High Trans Temp	2-102
Courtesy Lamps	2-52	Low Coolant	2-101
In Canada	8-8	Low Oil Level	2-99
In the U.S.	8-8	Low Oil Pressure	2-98
Cruise Control	2-47	Low Tire Pressure - (lf, lr, rf, rr)	2-103
Customer Assistance for Text Telephone Users	8-4	Maximum Speed 80 mph (129 km/h)	2-101
Customer Assistance Information	8-1	Reduced Engine Power	2-99
Customer Satisfaction Procedure	8-2	Service ABS	2-98
D amage, Finish	6-59	Service Column Lock	2-98
Daytime Running Lamps	2-50	Service Ride Control	2-101
Dead Battery	5-3	Service Tire Monitor (MON) System (SYS)	2-106
Defects, Reporting Safety	8-10	Service Traction System	2-100
In Canada	8-11	Service Vehicle Soon	2-99
To General Motors	8-11	Shocks Inoperative	2-101
Defensive Driving	4-2	Traction System - OFF	2-100
Defogger, Rear Window	3-11	Traction System - ON	2-100
Defogging	3-3, 3-7, 3-11	Traction System (SYS) Active	2-100
Defrosting	3-3, 3-11	Driver Position	1-11
Dimensions, Vehicle	6-71	Driving	4-1
Dolby B Noise Reduction	3-16	City	4-19
		Defensive	4-2

Driving (Continued)

Drunken	4-2
Freeway	4-20
In a Blizzard	4-26
In Foreign Countries	6-4
In the Rain	4-17
Night	4-15
On Curves	4-10
On Hill and Mountain Roads	4-22
On Snow and Ice	4-25
Through Deep Water	4-18
Wet Roads	4-17
Winter	4-24
Drunken Driving	4-2

E lectrical Equipment, Adding	2-23, 3-27, 6-62
Electrical System	6-62
ELECTRONIC Dual Climate Control System	3-4
EMT	6-41
Engine	6-10
Accessory Belt	6-72
Coolant	5-13, 5-16, 6-22
Coolant Heater	2-24
Coolant Level Check	7-11
Coolant Temperature Gage	2-81, 5-13
Exhaust	2-15, 2-37, 4-28
Fuse Block	6-67
Identification	6-62
Oil	6-12
Oil, Adding	6-12
Oil, Additives	6-15
Oil, Checking	6-12
Oil Level Check	7-11
Oil, Life Monitor	6-15

Oil, Used	6-16
Oil, When to Change	6-15
Overheating	5-13
Running While Parked	2-38
Specifications	6-70
Starting Your	2-22
Oil, Pressure Gage	2-84
Overheated Engine Protection Operating Mode	5-13
English/Metric Button	2-77
Ethanol	6-4
Exhaust, Engine	2-15, 2-37, 4-28
Express-Down Window	2-41
Extended Mobility Tires	6-41

F abric Cleaning	6-53
Fabric Protection	6-53
Fan Control Buttons	3-2, 3-6
Feature, Theft-Deterrent	2-17
Fiberglass Springs	6-59
Fifth Gear, Manual Transmission	2-29
Filling a Portable Fuel Container	6-8
Filling Your Tank	6-5
Filter, Air Cleaner	6-17
Finish Care	6-56
Finish Damage	6-59
Finish Damage	6-59
First Gear, Automatic Transmission	2-28
First Gear, Manual Transmission	2-29
Flashers, Hazard Warning	5-2
Flat Tire, What to Do	5-22
Floor Mats	2-59
Fluid Capacities	6-71
Fob Training	2-97
Fog Lamps	2-51

Foreign Countries, Fuel	6-4	Heritage Pages	iii
Fourth Gear, Manual Transmission	2-29	High-Beam Lamps	2-45
French Language Manual	ii	Highway Hypnosis	4-22
Front Sidemarkers Lamp Bulb Replacement	6-35	Hill and Mountain Roads	4-22
Front Towing	5-10	Hood	
Front Turn Signal Lamp Bulb Replacement	6-35	Checking Things Under	6-8
Fuel	6-3	Release	6-9
Canada	6-4, 6-5	Horn	2-41
Gage	2-86	Hydraulic Clutch	6-20
In Foreign Countries	6-4	Hydroplaning	4-18
Fuel, Filling Your Tank	6-5	I gnition Switch	2-20
Fuses and Circuit Breakers	6-64	Inadvertent Load Control	2-53
G ages		Inflation, Tire	6-44
Engine Coolant Temperature	2-81	Inside Day/Night Rearview Mirror	2-53
Engine Oil Pressure	2-84	Inspections	7-15
Fuel	2-86	Brake System	7-15
Voltmeter	2-79	Exhaust System	7-15
GAWR	4-29, 4-30	Radiator and Heater Hose	7-15
Gear Positions	2-26	Steering	7-15
Gross Axle Weight Rating	4-29, 4-30	Suspension	7-15
Gross Vehicle Weight Rating	4-29, 4-30	Tire	7-15
Guide en Français	ii	Wheel	7-15
GVWR	4-29, 4-30	Instrument Panel	2-74
H alogen Bulbs	6-33	Brightness Control	2-52
Hazard Warning Flashers	5-2	Cleaning	6-54
Headlamp Doors	2-44	Cluster	2-76
Headlamp/Highbeams Bulb Replacement	6-33	Fuse Block	6-64
Headlamps	2-43	Instrument Panel Cupholder	2-54
High/Low Beam Changer	2-45	Interior Lamps	2-52
Wiring	6-64	J ump Starting	5-3
Hearing Impaired, Customer Assistance	8-4		
Heating	3-10		

K ey Lock Cylinders Service	7-12
Keys	2-2
Labels	4-29
Certification	4-29
Service Parts Identification	6-62
Tire-Loading Information	4-29
Vehicle Identification Number	6-62
Lamps	2-50
Cleaning Exterior Lamps/Lenses	6-56
Courtesy	2-52
Exterior	2-50
Interior	2-52
On Reminder	2-44
Lap Belt Cinch Feature	1-12
Latches, Seatback	1-5
Leaving Your Vehicle	2-5
Leaving Your Vehicle with the Engine Running	2-35
Lighter	2-58
Lights	
Air Bag Readiness	1-20, 2-78
Anti-Lock Brake System Warning	2-80
Anti-Lock Brake Warning	2-78, 4-7
Brake System Warning	2-78
Check Engine	2-84
Check Gages	2-85
Safety Belt Reminder	1-6, 2-78
Security	2-85
Loading Your Vehicle	4-29
Locks	2-4
Cylinders	7-12
Door	2-4
Ignition Automatic Transmission Lock Check	7-14
Key Lock Cylinders Service	7-12

Power Door	2-5
Using the Wheel Lock Key	6-50
Lubricants and Fluids	7-16
Lubrication Service, Body	7-12
M agnesium Wheel Finish	6-59
Maintenance Record	7-18
Maintenance Schedule	7-1
Periodic Maintenance Inspections	7-15
Recommended Fluids and Lubricants	7-16
Scheduled Maintenance Services	7-4
Your Vehicle and the Environment	7-2
Maintenance, Underbody	6-59
Malfunction Indicator Lamp	2-82
Manual	
Comfort Control System	3-2
Front Seat	1-2
Transmission Check	7-12
Transmission Fluid	6-19
Transmission, Shifting	2-29
Transmission, Starting Your Engine	2-22
Memory	2-5
Methanol	6-4
Mirrors	2-53
Convex Outside	2-54
Inside Day/Night Rearview	2-53
Power Remote Control	2-54
Visor Vanity	2-58
MMT	6-4
Mountain Roads	4-22
Multifunction Lever	2-42

N utral	
Automatic Transmission	2-27
Manual Transmission	2-29
Neutral, Manual Transmission	2-29
New Vehicle Break-In	2-20
Night Vision	4-15
O ff-Road Recovery	4-12
Oil, Engine	6-12
One to Four Light	2-30
Outlet, Accessory	2-59
Overdrive, Automatic Transmission	2-28
Overheated Engine Protection Operating Mode	5-13
Overheating Engine	5-13
Owner Checks and Services	7-11
Owner Publications, Ordering	8-12
In Canada	8-11
P aint Spotting, Chemical	6-60
P ark	
Automatic Transmission	2-26
Shifting Into	2-34
Shifting Out of	2-36
P arking	
At Night	2-17
Brake	2-32
Lots	2-17
Over Things That Burn	2-37
Your Vehicle, Manual Transmission	2-36
Parking Brake Mechanism Check	7-14
Passenger Position	1-18
Passing	4-12
Pass-Key [®]	2-18
Periodic Maintenance Inspections	7-15
Portable Fuel Container, Filling a	6-8
P ower	
Door Locks	2-5
Remote Control Mirrors	2-54
Seat	1-2
Steering	4-10
Steering Fluid	6-26
Windows	2-40
Plug	6-63
Power Seat	1-2
Pregnancy, Use of Safety Belts	1-17
Problems on the Road	5-1
Publications, Service and Owner	8-12
In Canada	8-11
R acing or Other Competitive Driving	2-24
Radio Reception	3-27
Radios	3-12
Rain, Driving In	4-17
Reading Lamps	2-53
R ear	
Axle	6-21
Axle Service	7-15
Storage	2-56
Towing	5-11
Turn Signal and Taillamp Bulb Replacement	6-35
Window Defogger	3-11
Rearview Mirror, Inside Day/Night	2-53
Reclining Seatbacks	1-3
Recommended Fluids and Lubricants	7-16

Remote Function Actuation System		How to Wear Properly	1-11
Matching Transmitter(s) to Your Vehicle	2-11	Incorrect Usage	1-13, 1-31, 1-32
Operation	2-8	Lap Belt Cinch Feature	1-12
Resynchronizing Your Transmitter	2-11	Lap-Shoulder	1-11
Remote Hatch/Trunk Lid Release	2-14	Larger Children	1-34
Replacement Bulbs	6-69	Passenger Position	1-18
Replacement Parts	6-70	Questions and Answers	1-10
Replacement, Wheel	6-48	Reminder Light	1-6, 2-78
Reporting Safety Defects	8-10	Replacing After a Crash	1-38
In Canada	8-11	Smaller Children and Babies	1-25
To General Motors	8-11	Use During Pregnancy	1-17
Resetting the Oil Life Monitor	6-15	Why They Work	1-7
Restraints		Safety Defects, Reporting	8-10
Checking	1-33	In Canada	8-11
Child	1-27	To General Motors	8-11
Replacing Parts After a Crash	1-34	Safety Warnings and Symbols	viii
System Check	7-12	Scheduled Maintenance Services	7-4
Retained Accessory Power (RAP)	2-22	Seatback	
Reverse, Automatic Transmission	2-27	Latches	1-5
Reverse, Manual Transmission	2-29	Reclining	1-3
Ride Control	2-39	Seats	1-2
Roadside Assistance	8-5	Manual Front	1-2
Roadside Assistance, Canadian	8-7	Power	1-2
Rocking Your Vehicle	5-23	Securing a Child Restraint	1-32
Roof Panel	2-60	Sport	1-3
Rotation, Tire	6-45	Seats and Restraint Systems	1-1
S afety Belts	1-6	Seats and Seat Controls	1-2
Adults	1-11	Second Gear, Automatic Transmission	2-28
Care	6-54	Second Gear, Manual Transmission	2-29
Children	1-25	Security Light	2-85
Driver Position	1-11	Security Shade	2-55
Extender	1-37	Security Shade, Cleaning	6-54
		Selective Real Time Damping	2-39

Service	
Bulletins, Ordering	8-12
Manuals, Ordering	8-12
Parts Identification Label	6-62
Publications, Ordering	8-12
Work, Doing Your Own	6-2
Service and Appearance Care	6-1
Service and Owner Publications	8-12
In Canada	8-11
Servicing Your Air Bag-Equipped Vehicle	1-24
Shift Speeds	2-30
Shifting	2-26
Into Park	2-34
Out of Park	2-36
Signaling Turns	2-42
Sixth Gear, Manual Transmission	2-29
Skidding	4-14
Sound Equipment, Adding	3-27
Specifications and Capacities	6-70
Specifications, Engine	6-70
Speech Impaired, Customer Assistance	8-4
Speedometer	2-77
Sport Seat	1-3
Springs, Fiberglass	6-59
Stains, Cleaning	6-53
Starter Switch Check	7-13
Starting Your Engine	2-22
Steam	5-14, 5-15
Steering	4-10
In Emergencies	4-11
Power	4-10
Tips	4-10
Wheel, Tilt	2-41
Storage Compartments	2-54
Storage, Vehicle	6-32
Stuck: In Sand, Mud, Ice or Snow	5-22
Sun Visors	2-58
Surge Tank, Coolant	5-18
Symbols, Vehicle	x
System Controls, Comfort Control System	3-2, 3-4
T achometer	2-77
Tape Player Care	3-28
Temperature Controls	3-2, 3-4
Theft	2-16
Theft-Deterrent Radio	3-25
Thermostat	6-26
Third Gear, Automatic Transmission	2-28
Third Gear, Manual Transmission	2-29
Tilt Steering Wheel	2-41
Time, Setting the	3-12
Tire Chains	6-51
Tire-Loading Information Label	4-29
Tires	6-40
Alignment and Balance	6-48
Buying New	6-45
Cleaning	6-58
Extended Mobility	6-41
If One Goes Flat	5-22
Inflation	6-44
Inflation Check	7-11
Inspection and Rotation	6-45
Loading	4-29
Pressure	6-44
Temperature	6-48
Traction	6-47
Treadwear	6-47

Tires (Continued)	
Uniform Quality Grading	6-47
Wear Indicators	6-45
Wheel Replacement	6-48
When It's Time for New	6-45
Top Strap	1-31
Torque Lock	2-35
Torque, Wheel Nut	6-71
Towing a Trailer	4-30
Towing Your Vehicle	5-8
Traction Control System	4-8
Traction Control System (TCS) Light	2-81
Trailer Towing	4-30
Transmission Fluid	
Automatic	6-18
Manual	6-19
Transmission, Ignition Lock Check	7-14
Transmitters, Remote Function Actuation System	2-6
Transportation, Courtesy	8-8
TTY Users	8-4
Turn Signal and Lane Change Indicator	2-42
Turn Signal/Multifunction Lever	2-42

U nderbody Flushing Service	7-14
Universal Theft-Deterrent System	2-17

V ehicle	
Adding Equipment to the Outside of Your	6-3
Control	4-5
Damage Warnings	ix
Dimensions	6-71

Identification Number	6-62
Loading	4-29
Storage	6-32
Ventilation System	3-11
Visor Vanity Mirrors	2-58
Visors, Sun	2-58
Voltmeter	2-79

W arning Devices	5-3
Warning Lights, Gages and Messages	2-77
Warranty Information	8-10
Washer Fluid, Windshield	6-27
Washing Your Vehicle	6-56
Weatherstrips	6-55
Wheel	
Alignment	6-48
Nut Torque	6-71
Replacement	6-48
Using the Wheel Lock Key	6-50
Windows	2-40
Express-Down	2-41
Power	2-40
Windshield Washer	2-46
Fluid	6-27
Fluid Level Check	7-11
Windshield Wipers	2-45
Blade Replacement	6-37
Fuses	6-64
Winter Driving	4-24
Wiper Blade Check	7-12
Wiring, Headlamp	6-64
Wrecker Towing	5-8

 **NOTES**



NOTES

 **NOTES**

 **NOTES**

REPLACEMENT BULBS

Application

Number

Headlamps

High

9005

Low

9006

Front Parking and Turn Signal

3157 NAK

Rear Stop/Tail and Turn Signal

3057

CAPACITIES AND SPECIFICATIONS

Engine Specifications

Type

5.7L V8

Engine Torque

350 @ 4400 rpm

VIN Engine Code

G

Firing Order

1-8-7-2-6-5-4-3

Horsepower

345 @ 5600 rpm

Thermostat Starts to Open

187°F (86°C)

CAPACITIES AND SPECIFICATIONS (CONTINUED)

Capacities

Transmission

Manual (Overhaul) 4.1 qts. (3.8 L)

Automatic (Drain and Refill) 5 qts. (4.7 L)

Automatic (Overhaul) 10.8 qts. (10.2L)

Crankcase (Engine Oil with Filter Change)

6.5 qts. (6.1 L)

Engine Cooling System

Manual Trans 12.9 qts. (12.2 L)

Automatic Trans 12.6 qts. (11.9 L)

Vehicle Dimensions

Wheel Base 104.5 in. (265.4 cm)

Length 179.7 in. (456.4 cm)

Height 47.7 in. (121.1 cm)

Front Tread 62.1 in. (157.7 cm)

Rear Tread 62 in. (157.4 cm)

Torque

Wheel Nut Torque 100 lb-ft (140 N·m)

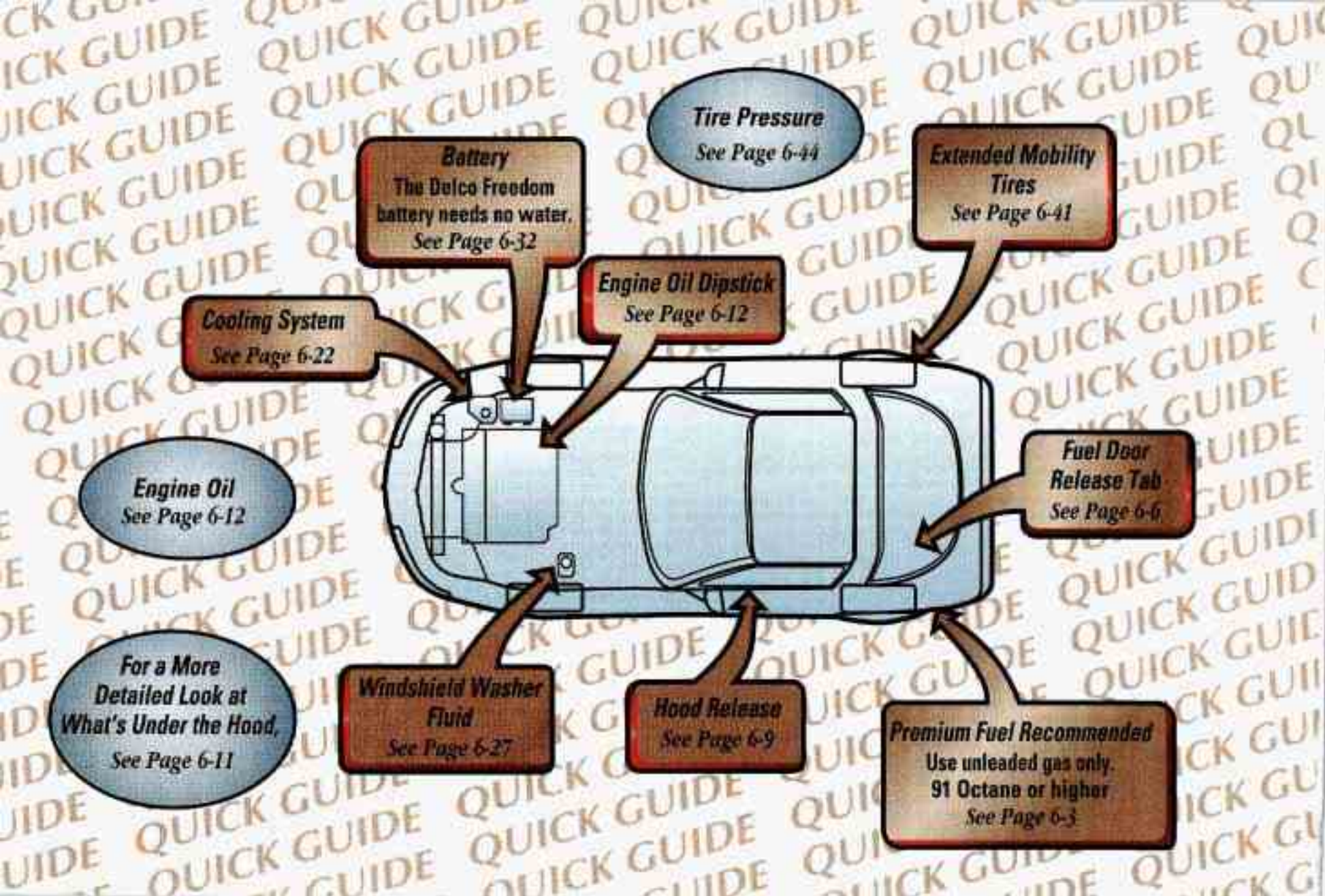

Tire Pressure

See Page 6-44

Extended Mobility Tires

See Page 6-41

Engine Oil Dipstick

See Page 6-12

Fuel Door Release Tab

See Page 6-6

Windshield Washer Fluid

See Page 6-27

Hood Release

See Page 6-9

Premium Fuel Recommended

Use unleaded gas only.

91 Octane or higher

See Page 6-3

Battery

The Delco Freedom battery needs no water.

See Page 6-32

Cooling System

See Page 6-22

Engine Oil

See Page 6-12

For a More Detailed Look at What's Under the Hood, See Page 6-11

