

CORVETTE

1993 Owner's Manual

REPRODUCTION

Table of Contents

Introduction	<i>How to Use this Manual</i>	9
Part 1	<i>Seats & Safety Belts</i>	13
2	<i>Features & Controls</i>	41
3	<i>Comfort Controls & Audio Systems</i>	135
4	<i>Your Driving and the Road</i>	163
5	<i>Problems on the Road</i>	203
6	<i>Service & Appearance Care</i>	239
7	<i>Maintenance Schedule</i>	321
8	<i>Customer Assistance Information</i> <small>includes "Reporting Safety Defects" on page 346</small>	341
9	<i>Index</i>	357
	<i>Service Station Information</i>	Last Page



Important Notes About this Manual

Please keep this manual in your Corvette, so it will be there if you ever need it when you're on the road. If you sell the vehicle, please leave this manual in it so the new owner can use it.

This manual includes the latest information at the time it was printed. We reserve the right to make changes in the product after that time without further notice.

Note to Canadian Owners

For vehicles first sold in Canada, substitute the name "General Motors of Canada Limited" for Chevrolet Motor Division whenever it appears in this manual.

For Canadian Owners Who Prefer a French Language Manual:

Aux propriétaires canadiens:

Vous pouvez vous procurer un exemplaire de ce guide en français chez votre concessionnaire ou au DGN Marketing Services Ltd., 1500 Bonhill Rd., Mississauga, Ontario L5T 1C7.

Published by

**Chevrolet Motor Division
General Motors Corporation**

The word **Chevrolet** and the Chevrolet emblem, **Corvette** and the Corvette emblem are registered trademarks of General Motors Corporation.

The word **Delco** is a registered trademark of General Motors Corporation.

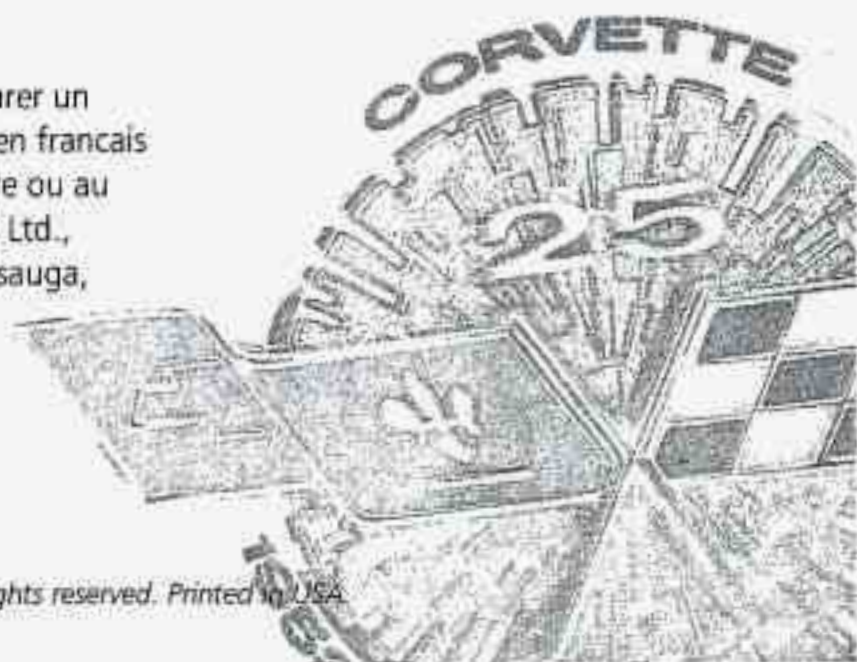

CORVETTE: FORTY YEARS OF STYLE AND SPEED

In the early '50s, it was only a designer's dream. Today, on its 40th anniversary, the Corvette stands alone as America's dream car—a testament to its unmistakable charisma and the excitement it inspires. For 40 years, unique styling, powerful performance and an undeniable panache have made Corvette one of the most celebrated sports cars in the world.

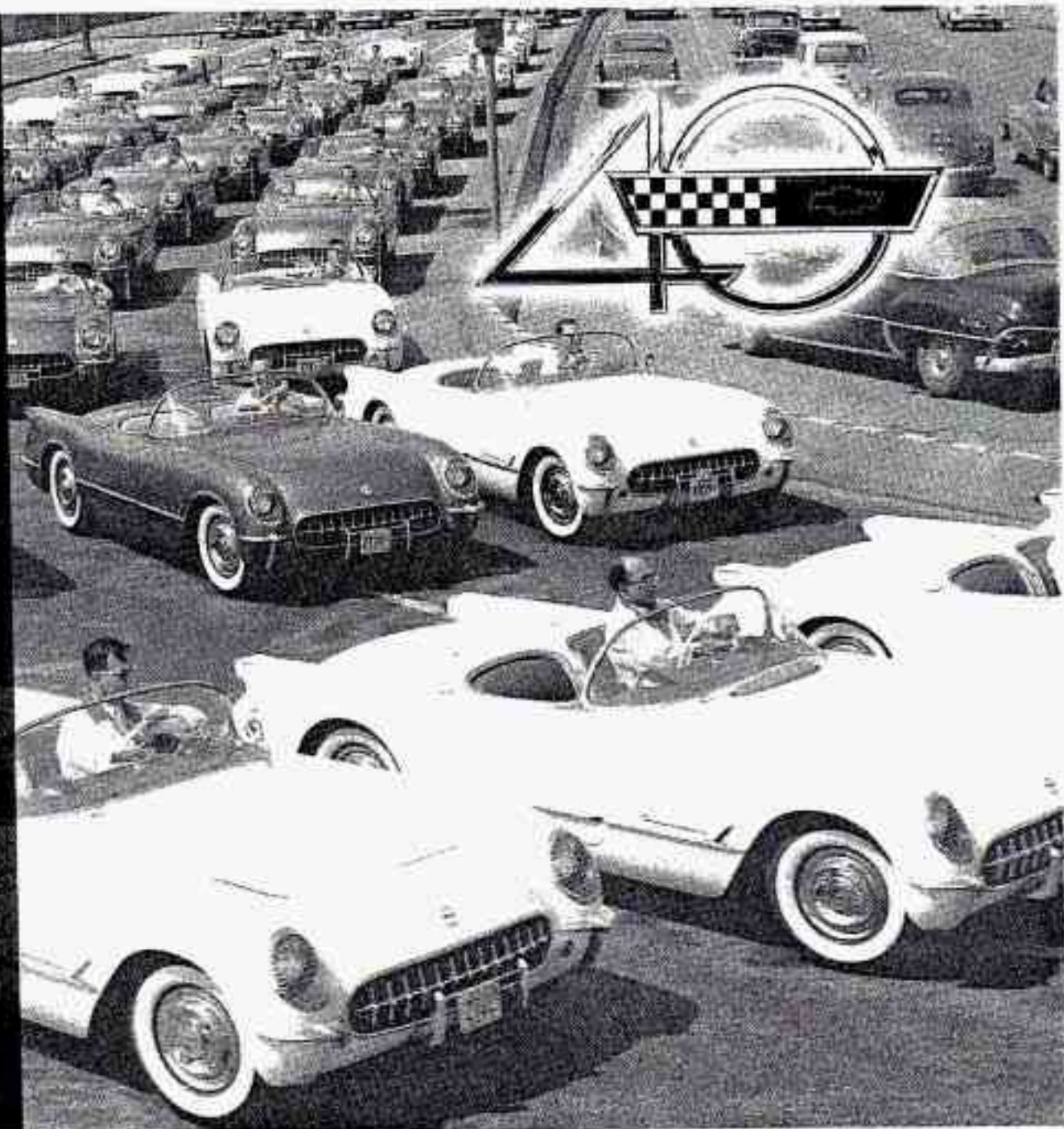

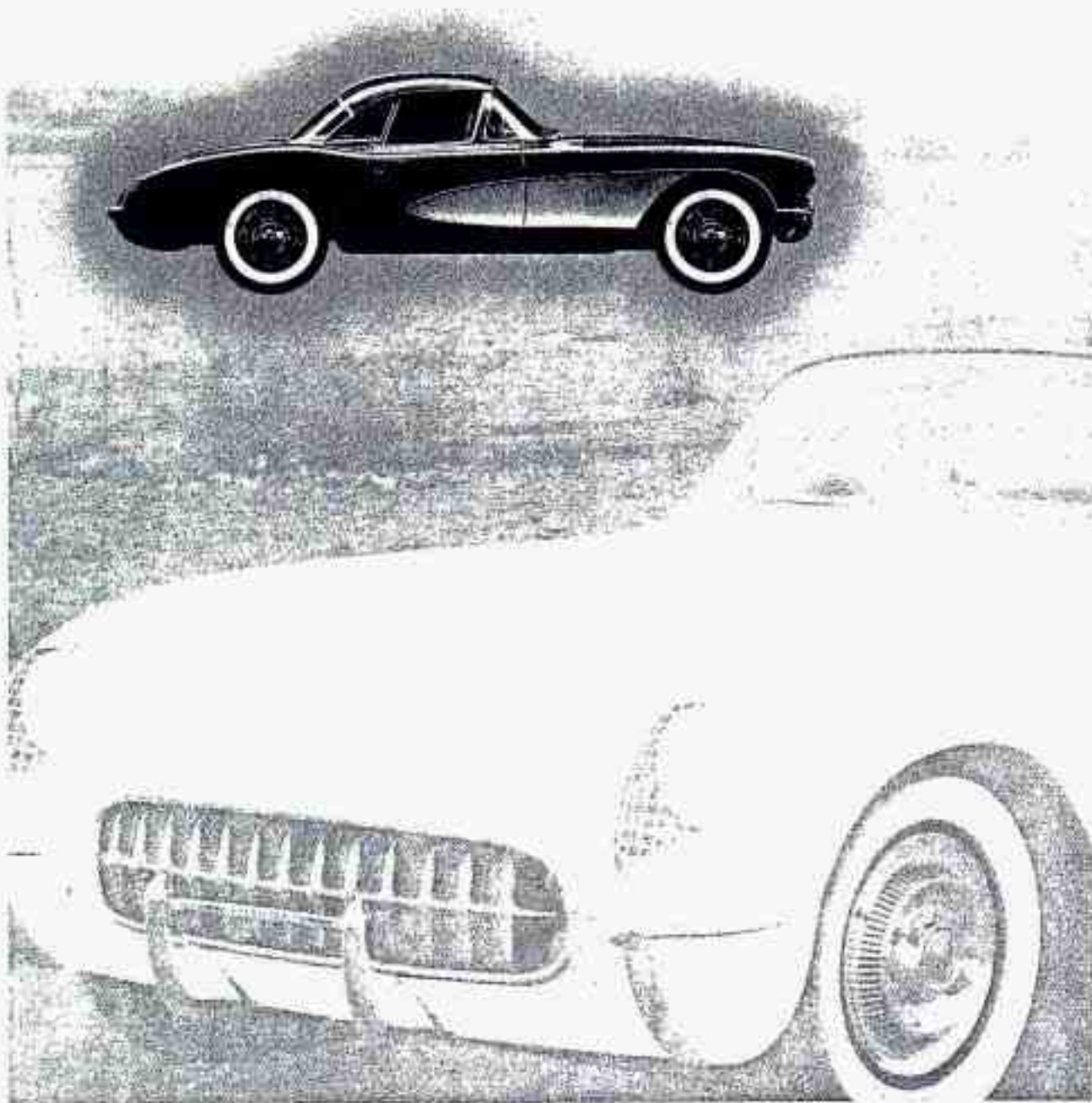

In 1953, Chevrolet produced 300 new lightweight fiberglass roadsters. A handful went to project engineers, General Motors managers, and a select group of movie stars and celebrities. With a two-speed Powerglide automatic transmission, Blue Flame six-cylinder engine, and gleaming Polo White exterior, Corvette began its drive into the heart of America.

Designers freshened up the 'Vette in 1956 by adding a removable hardtop and the famous Corvette "coves." The sculptured body enhanced its sporty look, and a standard 210-horsepower Chevy V8 engine solidified Corvette's reputation as a production race car.

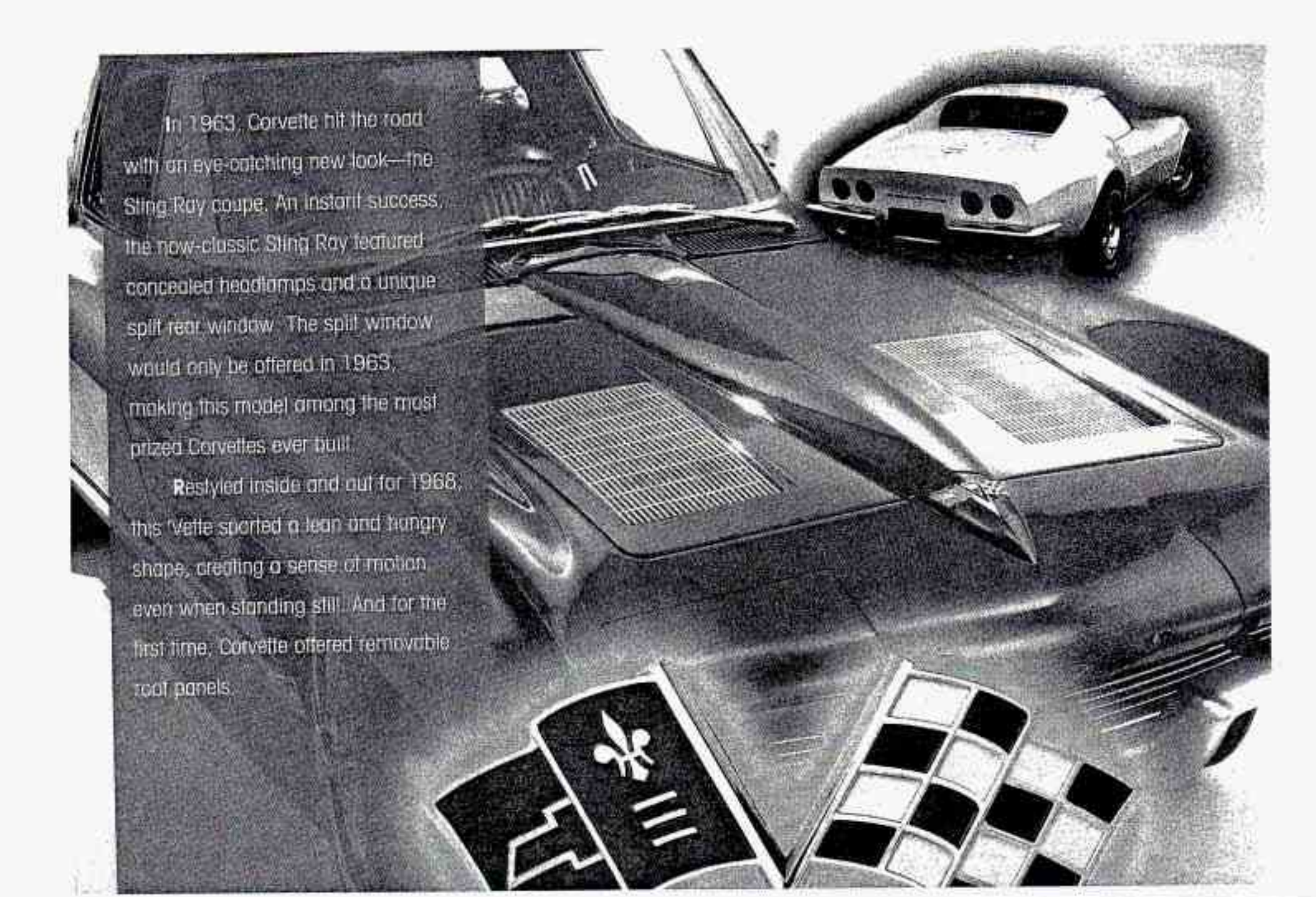

In 1963, Corvette hit the road with an eye-catching new look—the Sting Ray coupe. An instant success, the now-classic Sting Ray featured concealed headlamps and a unique split rear window. The split window would only be offered in 1963, making this model among the most prized Corvettes ever built.

Restyled inside and out for 1968, this 'vette started a lean and hungry shape, creating a sense of motion even when standing still. And for the first time, Corvette offered removable roof panels.

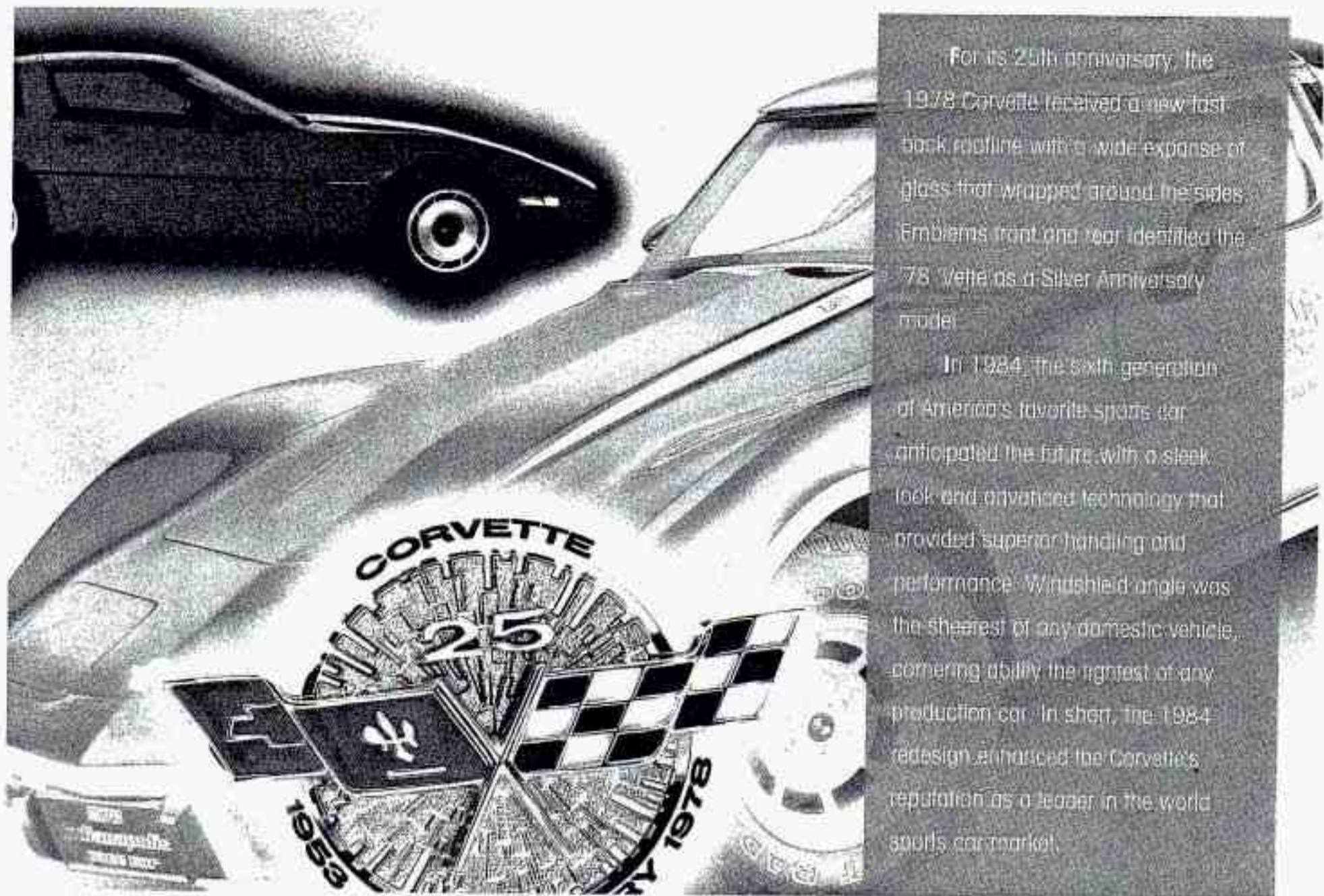

For its 25th anniversary, the 1978 Corvette received a new fast-back roofline with a wide expanse of glass that wrapped around the sides. Emblems front and rear identified the '78 Vette as a Silver Anniversary model.

In 1984, the sixth generation of America's favorite sports car anticipated the future with a sleek look and advanced technology that provided superior handling and performance. Windshield angle was the steepest of any domestic vehicle, cornering ability the tightest of any production car. In short, the 1984 redesign enhanced the Corvette's reputation as a leader in the world sports car market.

With 40 years of experience and technology under its belt, Corvette only gets better. From the 32-valve, 16 fuel injector, twin double-overhead cam V8 engine in the 1993 ZR-1 Special Performance Coupe to state-of-the-art refinements standard on all Corvettes—including acceleration slip regulation and passive keyless entry—the 40th anniversary edition Corvette is a premier driving machine.

Forty years ago, it began as an experiment in automotive design and technology. Today, the Corvette is a legend, with a passionate following among automotive enthusiasts. Simply put, it is one of the world's truly elite sports cars.

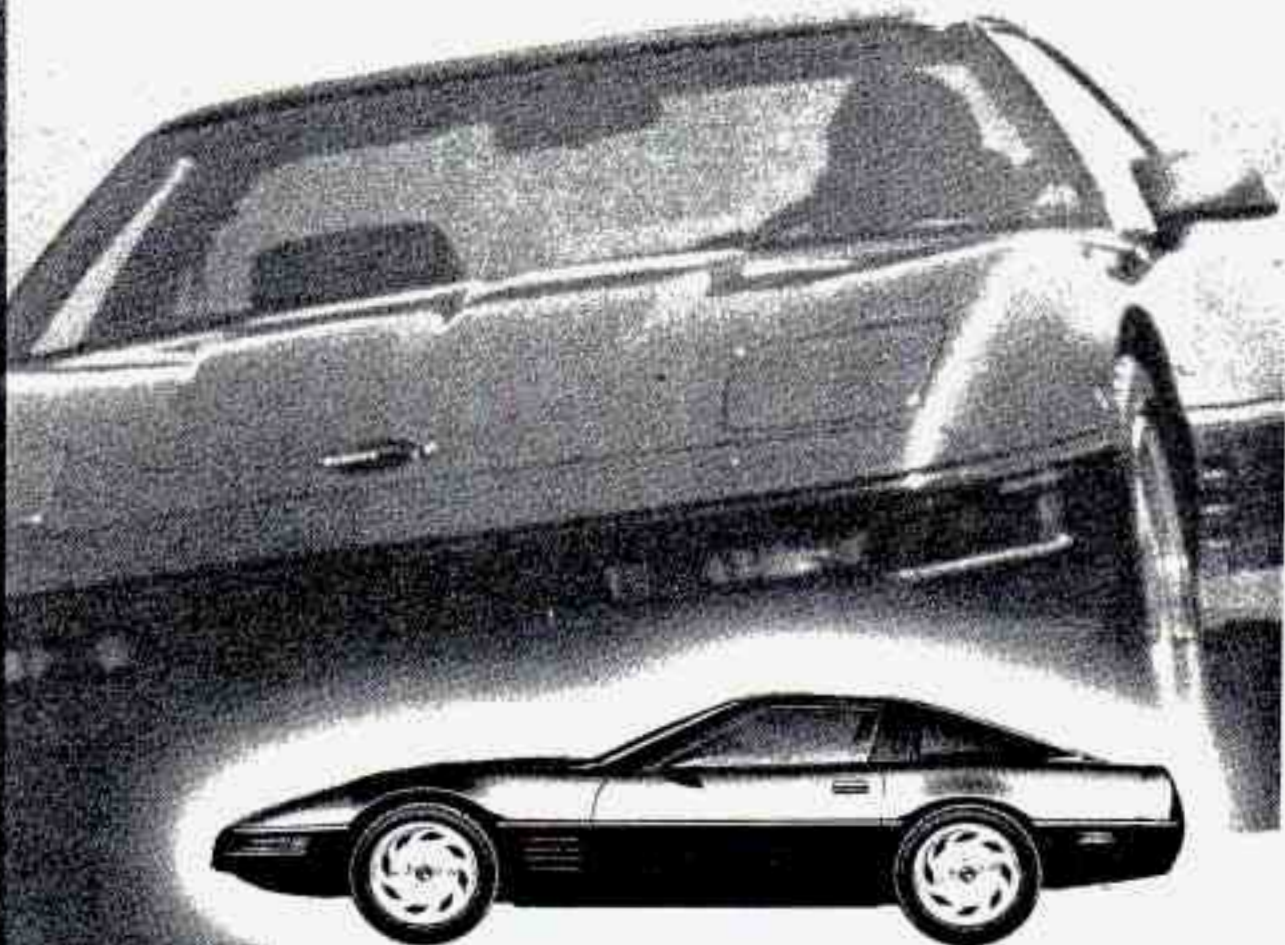

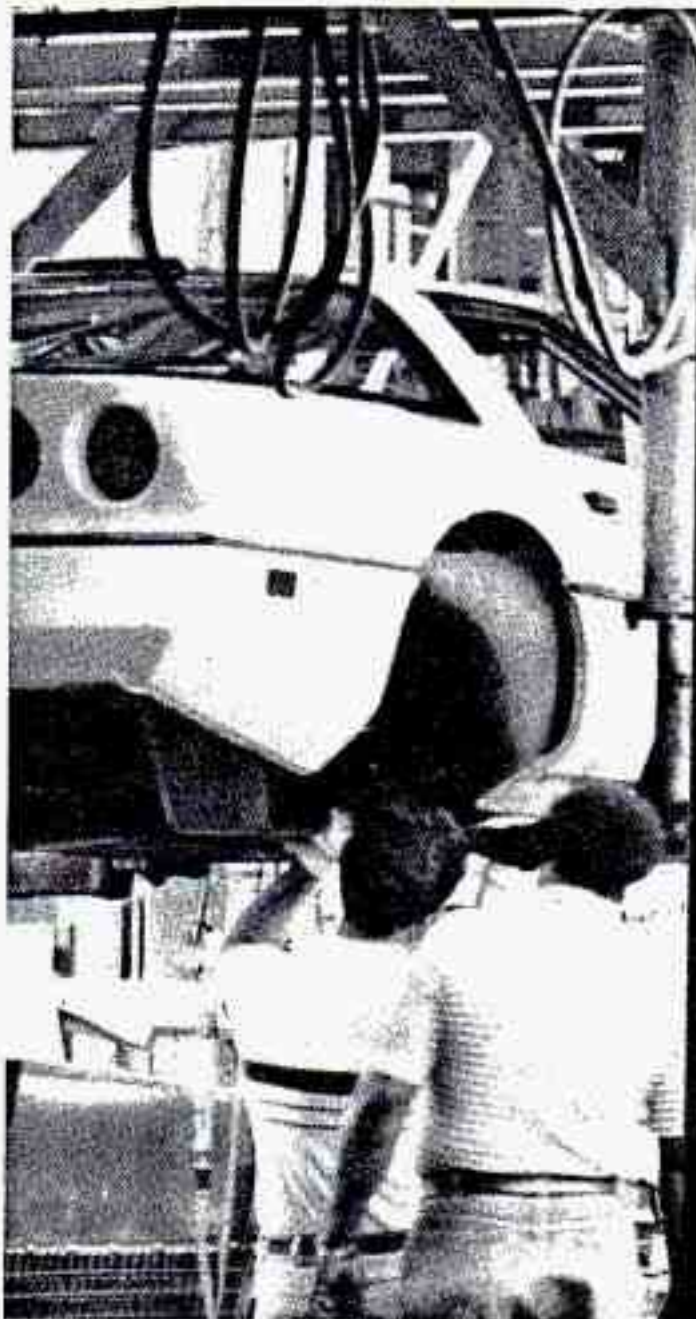

CORVETTE ASSEMBLY PLANT

The Corvette Assembly Plant in Bowling Green, Kentucky is one of the most sophisticated and computerized automobile assembly facilities in the world. To build your 1993 Corvette, over 1,200 employees teamed up with the 70 high-tech robots that assist in a variety of processes, from welding to painting.

The Bowling Green facility, which consistently ranks as one of General Motors' highest quality-producing plants, is Corvette's third home since 1953. Since beginning production in June of 1981, it has become one of Kentucky's most popular tourist attractions.

Corvette Assembly Plant tours are conducted Monday through Friday. Reservations are required for groups of ten or more. For more information, call **(502) 745-8228**.

Corvette Action Center

If you have any questions about your Corvette, you can call the Corvette Action Center at **1-800-457-VETT** between the hours of 6:00 a.m. and 2:30 p.m. (Central Time), Monday through Friday.

How to Use this Manual



Using Your 1993 Corvette Owner's Manual

Many people read their owner's manual from beginning to end when they first receive their new vehicle. This will help you learn about the features and controls for your vehicle. In this manual, you'll find that pictures and words work together to explain things quickly.

There are nine parts with color-tabbed pages in this manual. Each part begins with a brief list of contents, so you can usually tell at a glance if that part contains the information you want.

You can bend the manual slightly to reveal the color tabs that help you find a part.

Part 1: Seats & Safety Belts

This part tells you how to use your seats and safety belts properly.

Part 2: Features & Controls

This part explains how to start and operate your Corvette.

Part 3: Comfort Controls & Audio Systems

This part tells you how to adjust the ventilation and comfort controls, and how to operate your audio system.

Part 4: Your Driving and the Road

Here you'll find helpful information and tips about the road and how to drive under different conditions.

Part 5: Problems on the Road

This part tells you what to do if you have a problem while driving, such as a flat tire or engine overheating.

Part 6: Service & Appearance Care

Here the manual tells you how to keep your Corvette running properly and looking good.

Part 7: Maintenance Schedule

This part tells you when to perform vehicle maintenance and what fluids and lubricants to use.

Part 8: Customer Assistance Information

This part tells you how to contact Chevrolet for assistance and how to get service publications. It also gives you information on *Reporting Safety Defects*.

Part 9: Index

Here's an alphabetical listing of almost every subject in this manual. You can use it to quickly find something you want to read.

Service Station Information

This is a quick reference of service information. You can find it on the last page of this manual.

How to Use this Manual

Safety Warnings and Symbols

You will find a number of safety cautions in this book. We use yellow and the word CAUTION to tell you about things that could hurt you if you were to ignore the warning.

CAUTION



These mean there is something that could hurt you or other people.

In the yellow caution area, we tell you what the hazard is. Then we tell you what to do to help avoid or reduce the hazard. Please read these cautions. If you don't, you or others could be hurt.

You will also find a red circle with a slash through it in this book. This safety symbol means:

Don't

Don't do this

Don't let this happen



Vehicle Damage Warnings

Also, in this book you will find these blue notices:

NOTICE

These mean there is something that could damage your vehicle.

In the blue notice area, we tell you about something that can damage your vehicle. Many times, this damage would not be covered by your warranty, and it could be costly. But the notice will tell you what to do to help avoid the damage.

When you read other manuals, you might see CAUTION and NOTICE warnings in different colors or in different words. In this manual, we've used the familiar words and colors that Chevrolet has used for years.

You'll also see warning labels on your vehicle. They use the same colors, and the words CAUTION or NOTICE.

Vehicle Symbols

These are some of the symbols you will find on your vehicle. For example, these symbols are used on an original battery:

Caution Possible Injury



Protect Eyes by Shielding



*Caustic Battery Acid
Could Cause Burns*



Avoid Sparks or Flames



*Spark or Flame Could
Explode Battery*



These symbols are important for you and your passengers whenever your vehicle is driven:

Fasten Safety Belts



Door Lock/Unlock



These symbols have to do with your lights:

Master Lighting Switch



Turn Signal Direction



Hazard Warning Flashers



Headlight High Beam



Parking Lights

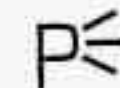

Fog Lamps

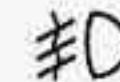

How to Use this Manual

These symbols are on some of your controls:

Windshield Wipers



Windshield Washer



Windshield Defroster



Rear Window Defogger



Ventilating Fan



Power Window



These symbols are used on warning and indicator lights:

Engine Coolant Temperature



Battery Charging System



Fuel



Engine Oil Pressure



Brake



Engine Oil Temperature



Here are some other symbols you may see:

Fuse



Hatch Release



Lighter



Horn



Speaker



Hood Release



Acceleration Slip Regulation





Here you'll find information about the seats in your Corvette, your Supplemental Inflatable Restraint system ("air bag") and how to use your safety belts properly. You can also learn about some things you should not do with safety belts.

Part I Seats & Safety Belts

Seats and Seat Controls	14
Safety Belts	17
How to Wear Safety Belts Properly	22
Driver Position	23
Supplemental Inflatable Restraint System (Air Bag)	26
Safety Belt Use During Pregnancy	31
Passenger Position	31
Children	32
Smaller Children and Babies	32
Child Restraints	33
Larger Children	36
Safety Belt Extender	37
Replacing Safety Belts After a Crash	38

Seats & Safety Belts

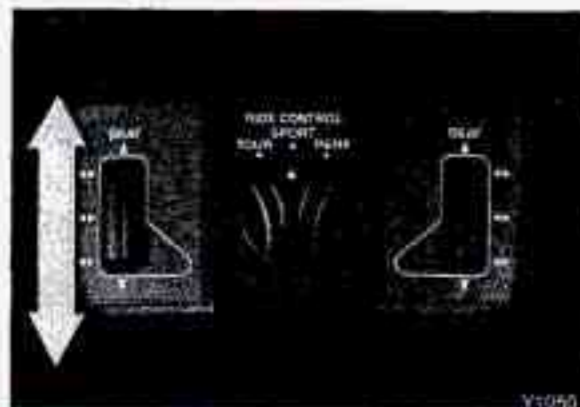

■ *Seats and Seat Controls*

This section tells you about the seats and how to adjust them.

Manual Front Seat

CAUTION

 You can lose control of the vehicle if you try to adjust a manual driver's seat while the vehicle is moving. The sudden movement could startle and confuse you, or make you push a pedal when you don't want to. Adjust the driver's seat only when the vehicle is not moving.

Move the control lever under the front of the seat to unlock it. Slide the seat to where you want it. Then release the lever and try to move the seat with your body, to make sure it is locked into place.

Power Seat (OPTION)

To adjust the power seat:

Full Control: Move the seat forward or rearward by pushing the control to the front or back.



Front (A): Raise the front of the seat by pushing the front of the switch toward the center of the vehicle. Lower the front of the seat by pushing the front of the switch in the opposite direction.

Center (B): Raise the entire seat higher by pushing the control toward the center of the vehicle. Lower the seat by pushing the control in the opposite direction.

Rear (C): Raise the rear of the seat by pushing the rear of the switch toward the center of the vehicle. Lower the rear of the seat by pushing the rear of the switch in the opposite direction.



Sport Seat (OPTION)

The Sport Seat Control allows you to change the contour of the driver and passenger seats. It works independently of the power seat control. Adjust your seat for the proper position first, then adjust the contour.

Lumbar Support Adjustment:

Move the switch down to inflate the area behind the small of the back. Use the round buttons to deflate the individual lumbar cushions. The front button deflates the bottom cushion, the center button deflates the center cushion, and the rear button deflates the top cushion.



Side Bolster Support Adjustment:

This switch is located on the corner of the front edge of both the driver's and passenger's seat. Press the outboard edge of the switch to open the bolsters. Press the inboard edge to close the bolsters.

Seats & Safety Belts

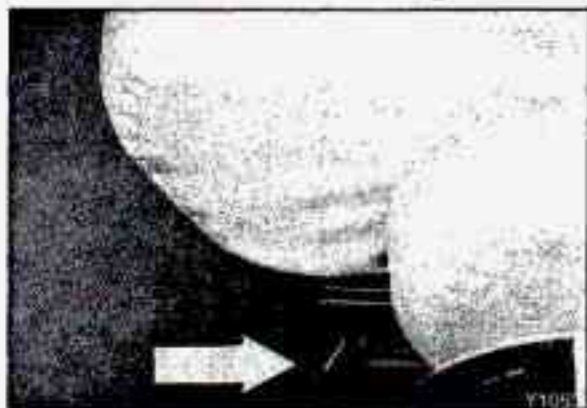

Manual Reclining Seatback

To adjust the seatback:

Slide the lever back to release the seatback, then tilt the seatback forward or backward, as desired. Release the lever to lock the seatback in place.

Don't have a seatback reclined, however, if your vehicle is moving.

CAUTION



Sitting in a reclined position when your vehicle is in motion can be dangerous. Even if you buckle up, your safety belts can't do their job when you're reclined like this.

The shoulder belt can't do its job because it won't be against your body. Instead, it will be in front of you. In a crash you could go into it, receiving neck or other injuries.

The lap belt can't do its job either. In a crash the belt could go up over your abdomen. The belt forces would be there, not at your pelvic bones. This could cause serious internal injuries.

For proper protection when the vehicle is in motion, have the seatback upright. Then sit well back in the seat and wear your safety belt properly.



Seatback Latches

Both seats fold forward to provide you access to the rear area. To fold a seatback forward, lift this latch and fold the seatback forward. The seatback will lock in the forward position.

To return the seatback to the upright position, just pull up on the latch and then push the seatback rearward. After you return the seatback to its original position, check to make sure the seatback is locked.

CAUTION



If the seatback isn't locked, it could move forward in a sudden stop or crash. That could cause injury to the person sitting there. Always press rearward on the seatback to be sure it is locked.

■ ***Safety Belts: They're For Everyone***

This part of the manual tells you how to use safety belts properly. It also tells you some things you should not do with safety belts.

And it explains the Supplemental Inflatable Restraint, or "air bag" system.

Seats & Safety Belts



■ *Safety Belts: They're For Everyone (Cont.)*

CAUTION

 Don't let anyone ride where they can't wear a safety belt properly. If you are in a crash and you're not wearing a safety belt, your injuries can be **much** worse. You can hit things inside the vehicle or be ejected from it. You can be seriously injured or killed. In the same crash, you might not be if you are buckled up. Always fasten your safety belt, and check that your passenger's belt is fastened properly too.

This figure lights up when you turn the key to **Run** or **Start** when your safety belt isn't buckled, and you'll hear a chime, too. It's the reminder to buckle up.

In many states and Canadian provinces, the law says to wear safety belts. Here's why: **They work.**

You never know if you'll be in a crash. If you do have a crash, you don't know if it will be a bad one.

A few crashes are very mild. In them, you won't get hurt even if you're not buckled up. And some crashes can be so serious, like being hit by a train, that even buckled up a person wouldn't survive. But most crashes are in between. In many of them, people who buckle up can survive and sometimes walk away. Without belts they could be badly hurt or killed.

After 25 years of safety belts in vehicles, the facts are clear. In most crashes buckling up does matter...a lot!

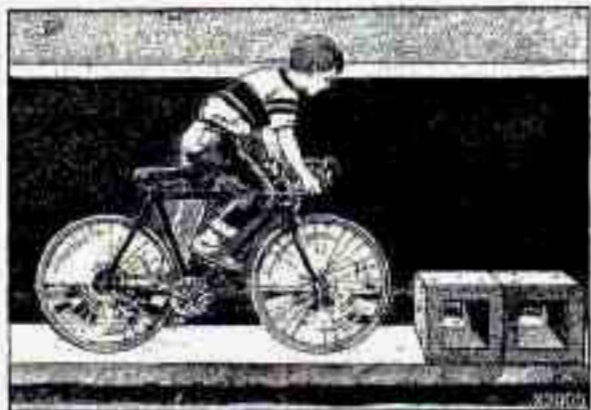

Why Safety Belts Work

When you ride in or on anything, you go as fast as it goes.

- 1. For example, if the bike is going 10 mph (16 km/h), so is the child.**

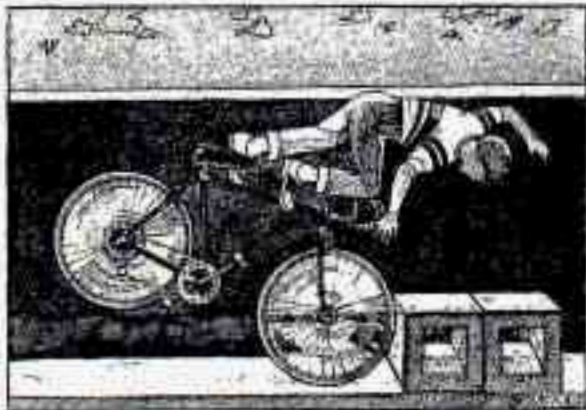

- 2. When the bike hits the block, it stops. But the child keeps going!**

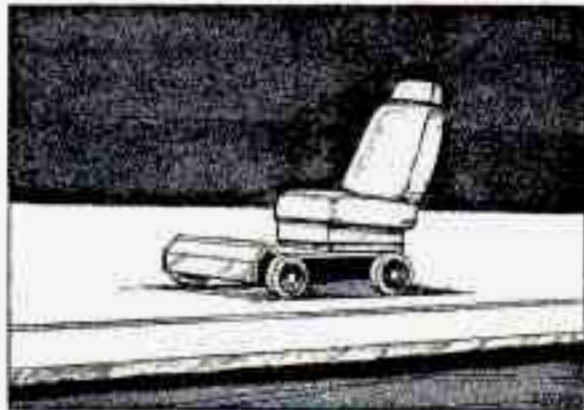

- 3. Take the simplest "car." Suppose it's just a seat on wheels.**

Seats & Safety Belts

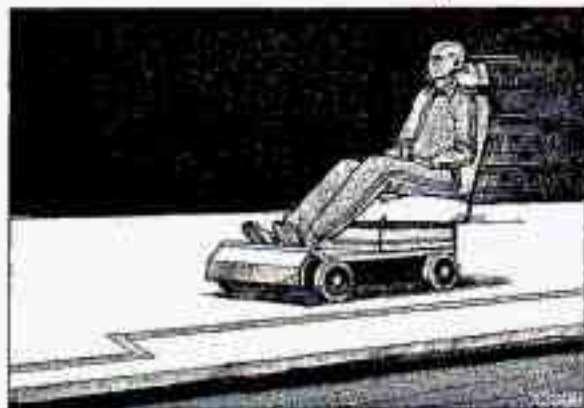

Why Safety Belts Work (CONT.)

4. Put someone on it.

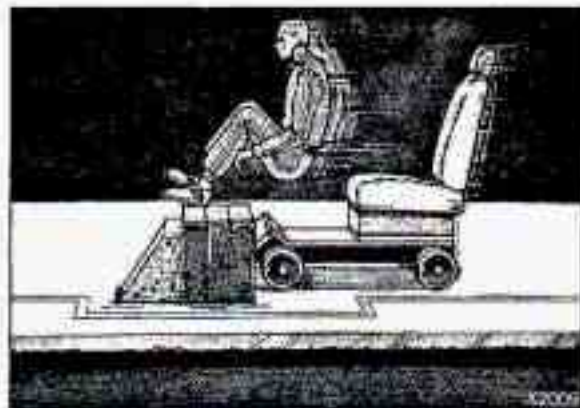

5. Get it up to speed. Then stop the "car." The rider doesn't stop.



6. The person keeps going until stopped by something. In a real vehicle, it could be the windshield. . .



7. or the instrument panel. . .



8. or the safety belts!

With safety belts, you slow down as the vehicle does. You get more time to stop. You stop over more distance, and your strongest bones take the forces. That's why safety belts make such good sense.

Here Are Questions Many People Ask About Safety Belts—and the Answers

Q: Won't I be trapped in the vehicle after an accident if I'm wearing a safety belt?

A: You **could** be—whether you're wearing a safety belt or not. But you can easily unbuckle a safety belt, even if you're upside down. And your chance of being conscious during and after an accident, so you **can** unbuckle and get out, is **much** greater if you are belted.

Q: Why don't they just put in air bags so people won't have to wear safety belts?

A: "Air bags," or Supplemental Inflatable Restraint systems, are in some vehicles today and will be in more of them in the future. But they are supplemental systems only—so they work **with** safety belts, not instead of them. Every "air bag" system ever offered for sale has required the use of safety belts. Even if you're in a vehicle that has "air bags," you still have to buckle up to get the most protection. That's true not only in frontal collisions, but especially in side and other collisions.

Q: If I'm a good driver, and I never drive far from home, why should I wear safety belts?

A: You may be an excellent driver, but if you're in an accident—even one that isn't your fault—you and your passenger can be hurt. Being a good driver doesn't protect you from things beyond your control, such as bad drivers.

Most accidents occur within 25 miles (40 km) of home. And the greatest number of serious injuries and deaths occur at speeds of less than 40 mph (65 km/h).

Safety belts are for everyone.

Seats & Safety Belts

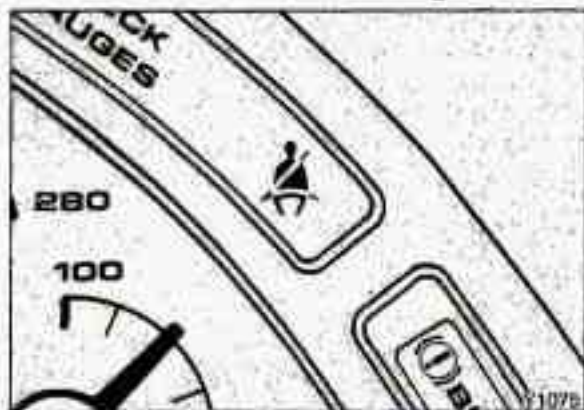

Safety Belt Reminder Light

When the key is turned to **Run** or **Start**, a light will come on for about eight seconds to remind people to fasten their safety belts. Unless the driver's safety belt is buckled, a chime will also sound.

■ *How to Wear Safety Belts Properly—Adults*

This section is only for people of adult size.

CAUTION



There are special things to know about safety belts and children. And there are different rules for babies and smaller children. If a child will be riding in your Corvette, see the *Index* under *Children and Safety Belts*. Follow those rules for everyone's protection.

First, you'll want to know which restraint systems your vehicle has. We'll start with the driver position.

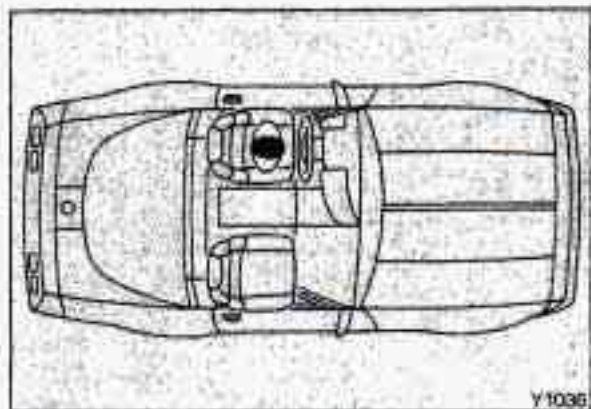

Driver Position

This section describes the driver's restraint system.



Lap-Shoulder Belt

The driver has a lap-shoulder belt. Here's how to wear it properly.

1. Close and lock the door.
2. Adjust the seat (to see how, see the *Index* under *Seat Controls*) so you can sit up straight.



3. Pick up the latch plate and pull the belt across you. Don't let it get twisted.
4. Push the latch plate into the buckle until it clicks.

If the belt isn't long enough, see the *Index* under *Safety Belt Extender*.

Make sure the release button on the buckle faces upward or outward so you would be able to unbuckle it quickly if you ever had to.

Seats & Safety Belts

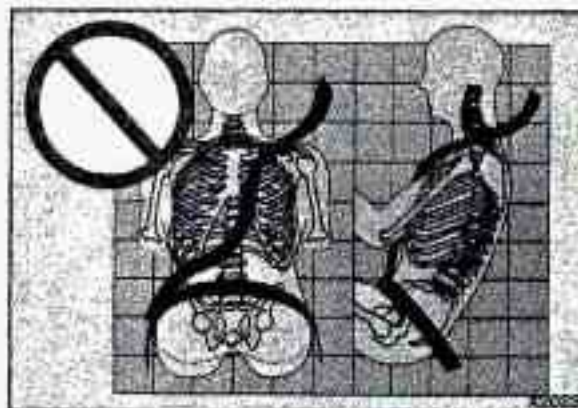
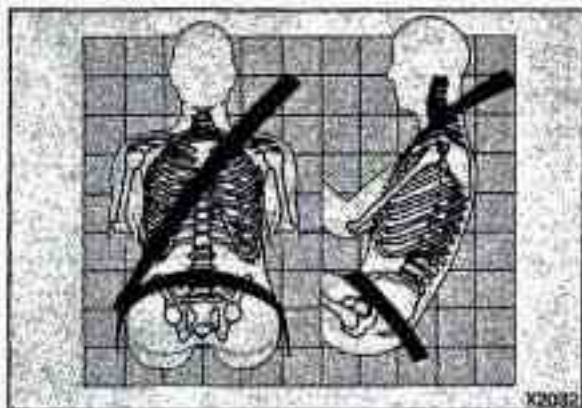

Lap-Shoulder Belt (CONT.)

The lap part of the belt should be worn low and snug on the hips, just touching the thighs. In a crash, this applies force to the strong pelvic bones. And you'd be less likely to slide under the lap belt. If you slid under it, the belt would apply force at your abdomen. This could cause serious or even fatal injuries. The shoulder belt should go over the shoulder and across the chest. These parts of the body are best able to take belt restraining forces.

The safety belt locks if there's a sudden stop or crash.

If you do not want the lap belt to move freely, push the "cinch" button. To loosen the belt, unbuckle it, let it retract, and buckle up again.

Q: What's wrong with this?

A: The shoulder belt is too loose. It won't give nearly as much protection this way.

CAUTION



You can be seriously hurt if your shoulder belt is too loose. In a crash you would move forward too much, which could significantly increase injury. The shoulder belt should fit against your body.

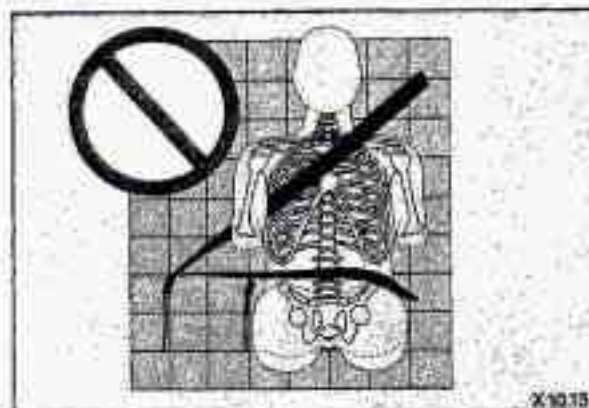

Q: What's wrong with this?

A: The belt is buckled in the wrong place.

CAUTION

 You can be seriously injured if your belt is buckled in the wrong place like this. In a crash, the belt would go up over your abdomen. The belt forces would be there, not at the pelvic bones. This could cause serious internal injuries. Always buckle your belt into the buckle nearest you.

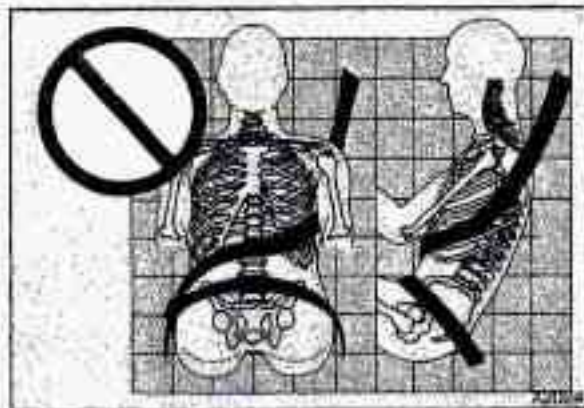

Q: What's wrong with this?

A: The shoulder belt is worn under the arm. It should be worn over the shoulder at all times.

CAUTION

 You can be seriously injured if you wear the shoulder belt under your arm. In a crash, your body would move too far forward, which would increase the chance of head and neck injury. Also, the belt would apply too much force to the ribs, which aren't as strong as shoulder bones. You could also severely injure internal organs like your liver or spleen.

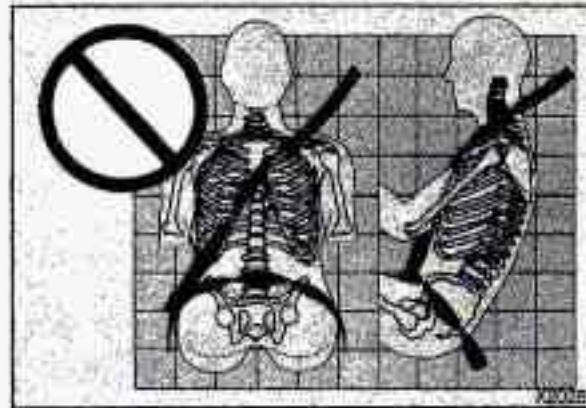

Q: What's wrong with this?

A: The belt is twisted across the body.

CAUTION

 You can be seriously injured by a twisted belt. In a crash, you wouldn't have the full width of the belt to spread impact forces. If a belt is twisted, make it straight so it can work properly, or ask your dealer to fix it.

Seats & Safety Belts



Lap-Shoulder Belt (CONT.)

To unfasten the belt, just push the button on the buckle. The belt should go back out of the way.

Before you close the door, be sure the belt is out of the way. If you slam the door on it, you can damage both the belt and your vehicle.

■ **Supplemental Inflatable Restraint System (Air Bag)**

This section explains the driver's Supplemental Inflatable Restraint (SIR) system, commonly referred to as an air bag.

Here are the Most Important Things to Know:

CAUTION

 Even with an air bag, if you're not wearing a safety belt and you're in a crash, your injuries may be much worse. Air bags are not designed to inflate in rollovers or in rear, side or low-speed frontal crashes. You need to wear your safety belt to reduce the chance of hitting things inside the vehicle or being ejected from it. Always wear your safety belt, even with an air bag.



CAUTION

 Air bags inflate with great force, faster than the blink of an eye. If you're too close to an inflating air bag, it could seriously injure you. Safety belts help keep you in position for an air bag inflation in a crash. Always wear your safety belt, even with an air bag, and sit as far back as you can while still maintaining control of your vehicle.

Air Bag System Light

There is an air bag readiness light on the Driver Information Center, which shows **INFL REST** (Inflatable Restraint). The system checks itself and the light tells you if there is a problem.

You will see this light flash for a few seconds when you turn your ignition to **Run** or **Start**. Then the light should go out, which means the system is ready.

CAUTION

 If the air bag readiness light doesn't come on when you start your vehicle, or stays on, or comes on when you are driving, your air bag system may not work properly. Have your vehicle serviced right away.

Seats & Safety Belts



How the Air Bag System Works

Q: Where is the air bag?

A: The driver's air bag is in the middle of the steering wheel.

Q: When is an air bag expected to inflate?

A: The air bag is designed to inflate in moderate to severe frontal or near-frontal crashes. The air bag will only inflate if the velocity of the impact is above the designed threshold level. When impacting straight into a wall that does not move or deform, the threshold level for most GM vehicles is between 9 and 14 mph (14 and 23 km/h). However, this velocity threshold depends on the vehicle design and may be several miles-per-hour faster or slower. In addition,

this threshold velocity will be considerably higher if the vehicle strikes an object such as a parked car which will move and deform on impact. The air bag is also not designed to inflate in rollovers, side impacts, or rear impacts where the inflation would provide no occupant protection benefit.

In any particular crash, the determination of whether the air bag should have inflated cannot be based solely on the level of damage on the vehicle(s). Inflation is determined by the angle of the impact and the vehicle's deceleration, of which vehicle damage is only one indication. Repair cost is not a good indicator of whether an air bag should have deployed.

Q: What makes an air bag inflate?

A: In a frontal impact of sufficient severity, sensors strategically located on the vehicle detect that the vehicle is suddenly stopping as a result of a crash. These sensors complete an electrical circuit, triggering a chemical reaction of the sodium azide sealed in the inflator. The reaction produces nitrogen gas, which inflates the cloth bag. The inflator, cloth bag, and related hardware are all part of the air bag inflator module packed inside the steering wheel.

Q: How does an air bag restrain?

A: In moderate to severe frontal or near-frontal collisions, even belted occupants can contact the steering wheel. The air bag supplements the protection provided by safety belts. Air bags distribute the force of the impact more evenly over the occupant's upper body, stopping the occupant more gradually. But air bags would not provide protection in many types of collisions, including rollovers and rear and side impacts, primarily because an occupant's motion is not toward the air bag. Air bags should never be regarded as anything more than a supplement to safety belt protection in moderate to severe frontal and near-frontal collisions.

Q: What will you see after an air bag inflation?

A: After the air bag has inflated, it will then quickly deflate. This occurs so quickly that some people may not even realize that the air bag inflated. The air bag will **not** impede the driver's vision or ability to steer the vehicle, nor will it hinder the occupants from exiting the vehicle. There will be small amounts of smoke coming from vents in the deflated air bag. Some components of the air bag module in the steering wheel hub may be hot for a short time, but the portion of the bag that comes into contact with you will not be hot to the touch. The nitrogen gas used to inflate the air bag will have

vented into the passenger compartment, and the bag will be deflated within seconds after the collision. Nitrogen makes up about 80% of the air we breathe and is not hazardous. As the nitrogen vents from the bag, small particles are also vented into the passenger compartment.

Seats & Safety Belts

How the Air Bag System Works (CONT.)

CAUTION



- Don't attach anything to the steering wheel pad. It might injure the driver if the air bag inflates.
- The air bag is designed to inflate only once. After it inflates, you'll need some new parts for your air bag system. If you don't get them, the air bag system won't be there to help protect you in another crash. A new system will include the air bag module and possibly other parts. The service manual has information about the need to replace other parts.
- Let only qualified technicians work on your air bag system. Improper service can mean that your air bag system won't work properly. See your dealer for service.

Servicing Your Corvette with the Air Bag System

Please tell or remind anyone who works on your Corvette that it has the air bag system. There are parts of the air bag system in several places around your vehicle. You don't want the system to inflate while someone is working on your vehicle. The air bag system does not need regular maintenance. Your Chevrolet dealer and the 1993 Corvette Service Manual have information about the air bag system, including repair or disposal.

CAUTION



For up to two minutes after the ignition key is turned off and the battery disconnected, an air bag can still inflate during improper service. You can be injured if you are close to an air bag when it inflates. Be sure to follow the proper service procedures.

When electrical work is done under the hood or inside your vehicle, the ignition should be in **Lock**, if possible.

Avoid yellow wires, wires wrapped with yellow tape, or yellow connectors. They are probably part of the air bag system.

But if the ignition has to be on for electrical work, or if the steering column is to be disassembled, the air bag system must be disconnected.

To do this:

- Turn off the ignition.
- Remove the SIR (air bag) fuse (see the *Index* under *Fuses & Circuit Breakers*).
- Disconnect the yellow connector at the base of the steering column.

When the work is complete, if the air bag system was disconnected, be sure to reattach everything and replace the fuse before turning the ignition on. When you turn the ignition key on, be sure you see the inflatable restraint light on the Driver Information Center. If you don't see this light flash and then go out as usual, have your air bag system repaired.



Safety Belt Use During Pregnancy

Safety belts work for everyone, including pregnant women. Like all occupants, they are more likely to be seriously injured if they don't wear safety belts.

A pregnant woman should wear a lap-shoulder belt, and the lap portion should be worn as low as possible throughout the pregnancy.

The best way to protect the fetus is to protect the mother. When a safety belt is worn properly, it's more likely that the fetus won't be hurt in a crash. For pregnant women, as for anyone, the key to making safety belts effective is wearing them properly.

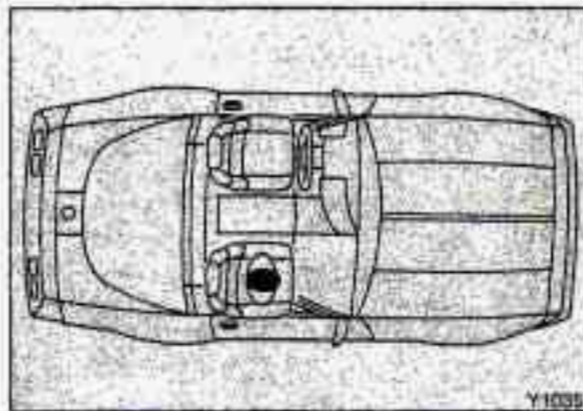

Passenger Position

The passenger's safety belt works the same way as the driver's safety belt.

See the *Index* under *Driver Position*.

Seats & Safety Belts



Smaller Children and Babies

■ Children

Everyone in a vehicle needs protection! That includes infants and all children smaller than adult size. In fact, the law in every state and Canadian province says children up to some age must be restrained while in a vehicle.

CAUTION



Smaller children and babies should always be restrained in a child or infant restraint. The instructions for the restraint will say whether it is the right type and size for your child. A very young child's hip bones are so small that a regular belt might not stay low on the hips, as it should. Instead, the belt will likely be over the child's abdomen. In a crash the belt would apply force right on the child's abdomen, which could cause serious or fatal injuries. So, be sure that any child small enough for one is always properly restrained in a child or infant restraint.

CAUTION



Never hold a baby in your arms while riding in a vehicle. A baby doesn't weigh much—until a crash. During a crash a baby will become so heavy you can't hold it. For example, in a crash at only 25 mph (40 km/h), a 12-pound (5.5 kg) baby will suddenly become a 240-pound (110 kg) force on your arms. The baby would be almost impossible to hold.

(Continued)



CAUTION



(Continued)

Secure the baby in an infant restraint.

Child Restraints

Be sure to follow the instructions for the restraint. You may find these instructions on the restraint itself or in a booklet, or both. These restraints use the belt system in your vehicle, but the child also has to be secured within the restraint to help reduce the chance of personal injury. The instructions that come with the infant or child restraint will show you how to do that.

The child restraint must be secured properly in the passenger seat.

CAUTION



An unsecured child restraint can move around in a collision or sudden stop and injure people in the vehicle. Be sure to properly secure any child restraint in your vehicle—even when no child is in it.

Seats & Safety Belts



Top Strap

If your child restraint has a top strap, it should be anchored.

If you have a convertible, don't use a restraint like that in your vehicle because the top strap anchor cannot be installed properly. You shouldn't use this type of restraint without anchoring the top strap.

If your vehicle is not a convertible and you need to have an anchor installed, you can ask your Chevrolet dealer to put one in for you. If you want to install an anchor yourself, your dealer can tell you how to do it.

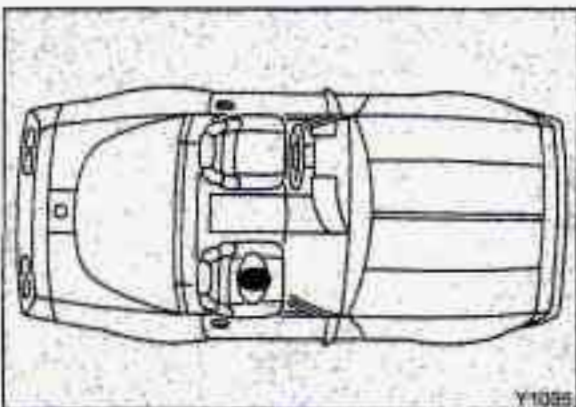

Securing a Child Restraint in the Passenger Seat

You'll be using the lap-shoulder belt. See the earlier section about the top strap if the child restraint has one.

1. Put the restraint on the seat. Follow the instructions for the child restraint.
2. Secure the child in the child restraint as the instructions say.
3. Pull out the vehicle's safety belt and run the lap part through or around the restraint. The child restraint instructions will show you how.
See if the shoulder belt would go in front of the child's face or neck. If so, put it behind the child restraint.



4. Buckle the belt. Make sure the release button faces upward or outward, so you'll be able to unbuckle it quickly if you ever need to.



5. Push the "cinch" button. See the *Index* under *Lap-Shoulder Belt*, where we describe the cinch feature.
6. To tighten the belt, feed the lap belt back into the retractor while you push down on the child restraint.



7. Push and pull the child restraint in different directions to be sure it is secure.

To remove the child restraint, just unbuckle the vehicle's safety belt and let it go back all the way. The safety belt will move freely again and be ready to work for an adult or larger child passenger.

Seats & Safety Belts



Larger Children

Children who have outgrown child restraints should wear the vehicle's safety belts.

- Children who aren't buckled up can be thrown out in a crash.
- Children who aren't buckled up can strike other people who are.

CAUTION



Never do this.

Here two children are wearing the same belt. The belt can't properly spread the impact forces. In a crash, the two children can be crushed together and seriously injured. A belt must be used by only one person at a time.

Q: What if a child is wearing a lap-shoulder belt, but the child is so small that the shoulder belt is very close to the child's face or neck?

A: Move the child toward the center of the vehicle, but be sure that the shoulder belt still is on the child's shoulder, so that in a crash the child's upper body would have the restraint that belts provide.



CAUTION



Never do this.

Here a child is sitting in a seat that has a lap-shoulder belt, but the shoulder part is behind the child. If the child wears the belt in this way, in a crash the child might slide under the belt. The belt's force would then be applied right on the child's abdomen. That could cause serious or fatal injuries.

The lap portion of the belt should be worn low and snug on the hips, just touching the child's thighs. This applies belt force to the child's pelvic bones in a crash.

Safety Belt Extender

If the vehicle's safety belt will fasten around you, you should use it. But if a safety belt isn't long enough to fasten, your dealer will order you an extender. It's free. When you go in to order it, take the heaviest coat you will wear, so the extender will be long enough for you. The extender will be just for you, and just for the seat in your vehicle that you choose. Don't let someone else use it, and use it only for the seat it is made to fit. To wear it, just attach it to the regular safety belt.

Checking Your Restraint Systems

Now and then, make sure all your belts, buckles, latch plates, retractors, anchorages and reminder systems are working properly. Look for any loose parts or damage. If you see anything that might keep a restraint system from doing its job, have it repaired.

Seats & Safety Belts

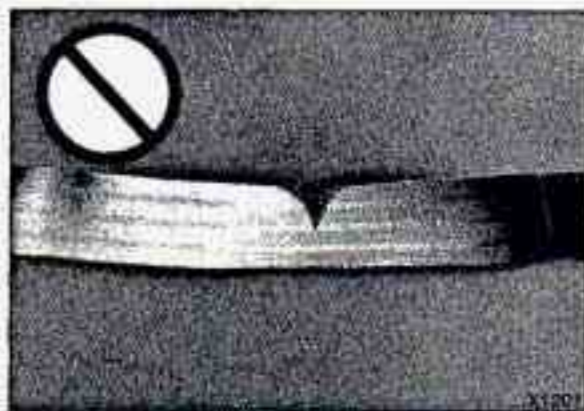

Replacing Safety Belts After a Crash

If you've had a crash, do you need new belts?

After a very minor collision, nothing may be necessary. But if the belts were stretched, as they would be if worn during a more severe crash, then you need new belts.

If belts are cut or damaged, replace them. Collision damage also may mean you will have to have safety belt parts, like the retractor, replaced or anchorage locations repaired—even if the belt wasn't being used at the time of the collision.

Q: What's wrong with this?

A: The belt is torn.

CAUTION



Torn or frayed belts may not protect you in a crash. They can rip apart under impact forces. If a belt is torn or frayed, get a new one right away.

Notes



[Faint, illegible text or markings within the main body of the page, possibly bleed-through from the reverse side.]

Notes



Here you can learn about the many standard and optional features on your Corvette, and information on starting, shifting and braking. Also explained are the instrument panel and the warning systems that tell you if everything is working properly—and what to do if you have a problem.

Part 2 Features & Controls

Keys	42
Locks	43
Passive Keyless Entry System	44
PASS-Key™	55
Glove Box	59
Ignition	60
Starting Your Engine	61
Engine Block Heater	66
Shifting the Transmission	67
Parking Brake	77
Windows	81
Turn Signal/Headlight Beam Lever	82
Windshield Wipers/Washer	83
Cruise Control	84
Headlights	89
Interior Lights	91
Mirrors	92
Sun Visors	93
Storage Compartments	95
Ashtray and Lighter	96
Instrument Panel	98
Warning Lights, Gages and Indicators	102
Trip Monitor	110
Driver Information Center	112
Removable Roof Panel	120
Convertible Top	124
Convertible Hardtop	128

Features & Controls

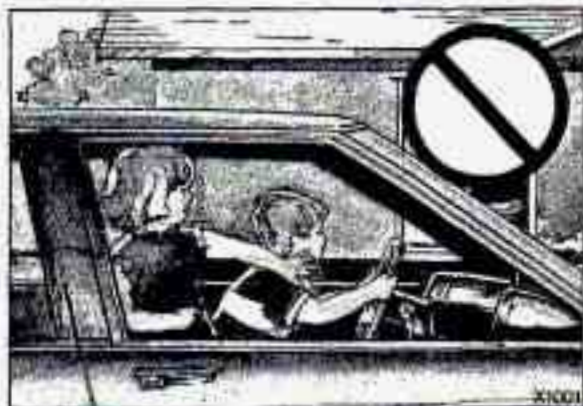

Keys

CAUTION



Leaving young children in a vehicle with the ignition key is dangerous for many reasons. A child or others could be badly injured or even killed. They could operate power windows or other controls or even make the vehicle move. Don't leave the keys in a vehicle with young children.



The ignition keys are for the ignition only.

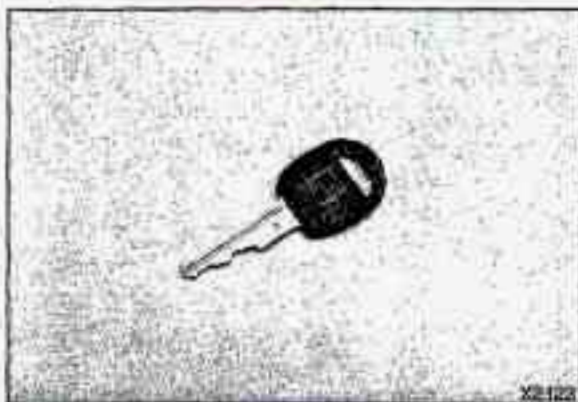

The door keys are for the doors and all other locks, except the engine power switch (if you have a ZR-1) which uses a third key.

When a new Corvette is delivered, the dealer removes the plugs from the keys, and gives them to the first owner. However, the ignition key may not have a plug.

Each plug has a code on it that tells your dealer or a qualified locksmith how to make extra keys. Keep the plugs in a safe place. If you lose your keys, you'll be able to have new ones made easily using these plugs. If your ignition keys don't have plugs, go to your Chevrolet dealer for the correct key code if you need a new ignition key.

NOTICE

Your Corvette has a number of new features that can help prevent theft. But you can have a lot of trouble getting into your vehicle if you ever lock your keys inside. You may even have to damage your vehicle to get in. So be sure you have extra keys.

Door Locks

CAUTION



Unlocked doors can be dangerous.

Passengers—especially children—can easily open the doors and fall out. When a door is locked, the inside handle won't open it.

Outsiders can easily enter through an unlocked door when you slow or stop your vehicle.

This may not be so obvious: You increase the chance of being thrown out of the vehicle in a crash if the doors aren't locked. Wear safety belts properly, lock your doors, and you will be far better off whenever you drive your vehicle.

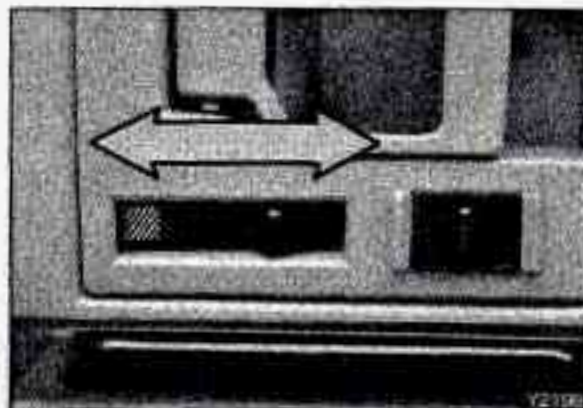
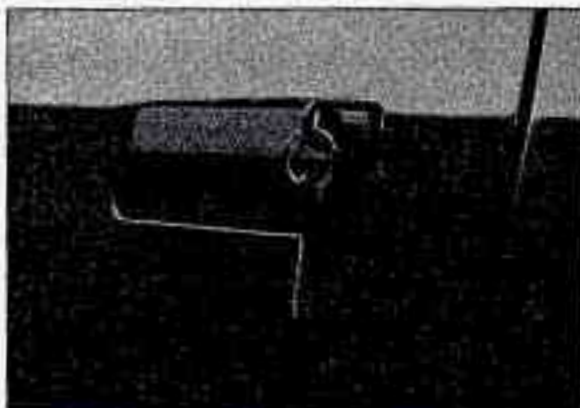

There are several ways to lock and unlock your vehicle.

From the Outside:

Use your door key or the Passive Keyless Entry transmitter.

If your theft deterrent system is armed, unlock the doors only with the key or Passive Keyless Entry system. This will avoid setting off the alarm.

To lock the doors with the Passive Keyless Entry system, take the transmitter out of range—after five seconds, the doors will lock and the horn will sound once. To unlock the doors, move the transmitter back into vehicle range. See the *Index* under *Passive Keyless Entry System*.

From the Inside:

To lock the door, slide the lock control on the door rearward.

To unlock the door, slide the lock control on the door forward.

Features & Controls

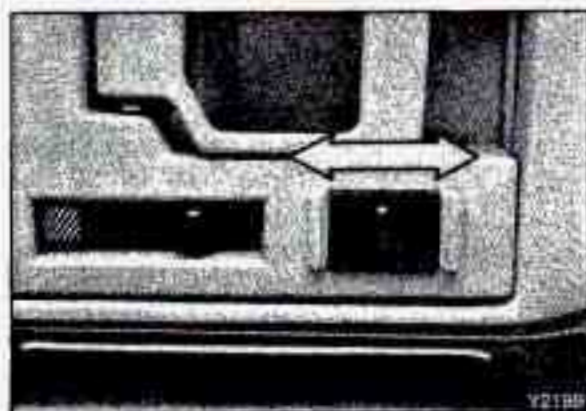

Power Door Locks

With power door locks, you can lock or unlock both doors of your vehicle from the driver or passenger door lock switch. Slide the power door lock switch rearward to lock the doors. Slide the switch forward to unlock the doors.

Leaving Your Vehicle

If you are leaving the vehicle, open your door and set the locks from inside. Then get out and close the door.

Your vehicle has a theft deterrent system. See the *Index* under *Universal Theft Deterrent*.

■ Passive Keyless Entry System

Your Passive Keyless Entry system operates on a radio frequency subject to Federal Communications Commission (FCC) Rules.

This device complies with Part 15 of the FCC Rules. Operation is subject to the following two conditions: (1) This device may not cause harmful interference, and (2) This device must accept any interference received, including interference that may cause undesired operation.

Should interference to this system occur, try this:

- Check to see if the passive feature is enabled.
- Check the distance. You may be too far from your vehicle. This product has a maximum range.
- Check the location. Other vehicles or objects may be blocking the signal.
- Check to determine if battery replacement is necessary. See the instructions on battery replacement later in this section.
- See your Chevrolet dealer or a qualified technician for service.

Changes or modifications to this system by other than an authorized service facility could void authorization to use this equipment.



Passive Keyless Entry Description

The Passive Keyless Entry system, or PKE, on your Corvette is a new approach to remote keyless entry. Unlike other systems, PKE requires no specific action from the operator to unlock or lock the doors. When the passive feature is enabled, simply approach the vehicle with the PKE transmitter—the system automatically disarms your vehicle's theft deterrent system and unlocks either the driver's door or both doors (depending on which unlock mode it is in). Move back out of range, and PKE locks all the doors and arms the theft deterrent system.

The Passive Keyless Entry system also has other useful features. The passenger door can be unlocked by pressing the **DOOR** button on the transmitter. On the coupe, the hatch can be opened by pressing the **HATCH** button on the transmitter. In addition to these features, there is a special function that prevents the keys from being locked in the vehicle while they are in the ignition.

Your Corvette comes equipped from the factory with one transmitter. Additional transmitters, if desired, may be purchased through your dealer. Each transmitter is coded for security, and must be programmed to your vehicle before it is used. See *Programming Transmitters* later in this section.

Features & Controls

Transmitter Range

The Passive Keyless Entry system senses the transmitter when it is within a certain range of the vehicle. When the transmitter is within this range, the door(s) will unlock automatically (if the passive feature is enabled), the theft deterrent system will be disarmed, and the courtesy lights will be turned on (if it is dark enough outside).

Transmitter ranges, as shown in the coupe and convertible illustrations, are as follows:

Range A: 5-7 feet (1½-2 m)

Range B: 3-5 feet (1-1½ m)

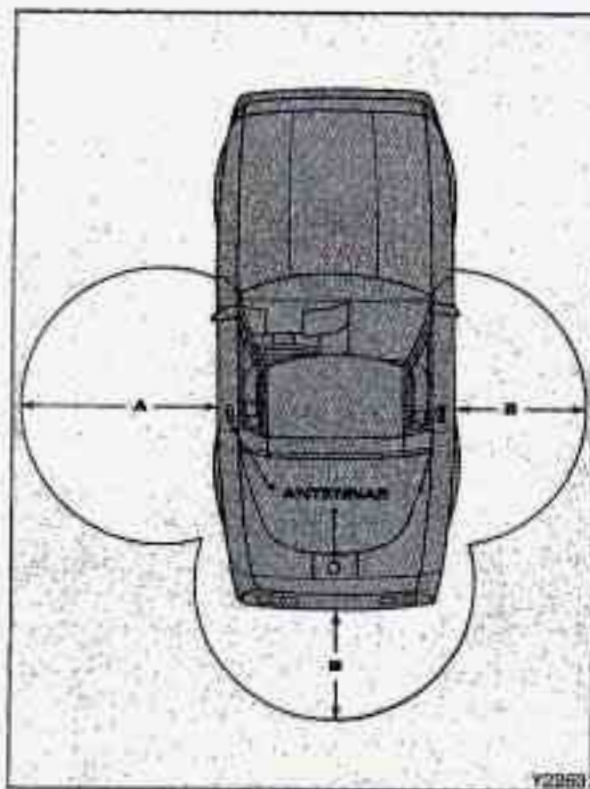

Transmitter Range (Coupe)

The signal of the transmitter is picked up by two antennas. On the coupe, one antenna is located in the driver's door and one is located in the rear of the luggage area. These antennas do not require any routine maintenance.

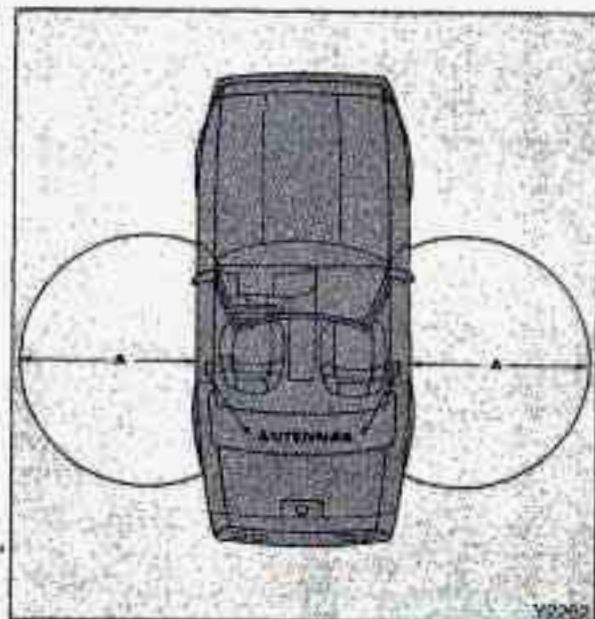

Transmitter Range (Convertible)

On the convertible, one antenna is located in the driver's door and one is located in the passenger's door. These antennas do not require any routine maintenance.



Transmitter Range Suggestions:

- The range of the Passive Keyless Entry system is very dependent on how the transmitter is held. For optimum range and performance, hold the transmitter vertically when approaching the vehicle.
- If the range gradually decreases over time even though the transmitter is held vertically, change the battery in the transmitter.
- The range will decrease if more than one transmitter is in range at the same time. Avoid taking more than one transmitter into vehicle range at the same time.

- Do not put the transmitter into a metal container, which will prevent the signal from getting to the vehicle.

When you move the transmitter into vehicle range, the theft deterrent system automatically disengages and the driver's door automatically unlocks.

When you move the transmitter out of vehicle range with the doors closed and the key out of the ignition, the system will automatically:

- Lock both doors after a five-second delay.
- Immediately arm the theft deterrent system.
- Sound the horn once to signal that the doors are locked.
- Turn off the interior lights.

The theft deterrent system will still operate using the power door lock. See the *Index* under *Universal Theft Deterrent*.

You may also unlock the passenger door by pressing the **DOOR** button on the transmitter, and the hatch by pressing the **HATCH** button, but only when the ignition is off.

Features & Controls

Passive Keyless Entry Settings

With Passive Keyless Entry, you can use the system to operate both doors, or only the driver's door. You can also choose to disable the system, if there are times when you would prefer not to use Passive Keyless Entry.

To Switch Door Settings:

To switch the setting from automatically locking and unlocking the driver's door to automatically locking and unlocking both doors:

1. Insert the ignition key, but leave the ignition off.
2. With the transmitter in range, hold the **DOOR** button for more than two seconds. The system will then cycle the door locks.
3. To switch back, repeat steps 1 and 2.

Turning the Passive Keyless Entry System Off:

1. Take the keys out of the ignition.
2. Hold the **DOOR** button on the transmitter for longer than two seconds.
3. The system will signal the shut-off by cycling the locks from lock to unlock. To make sure the PKE system is off, turn the ignition on and look for the **PASSIVE KEYLESS ENTRY** light on the Driver Information Center. If the PKE system is on, the light will come on for two seconds. If the system is off, the light will not come on.

When the system is off or the transmitter is left at home, none of the Passive Keyless Entry features work. But you will still be able to work the manual and power locks, and arm the theft deterrent system. See the Index under *Door Locks*, *Power Door Locks* and *Universal Theft Deterrent*.

If you are working around your Corvette and are keeping your keys with you, you might want to turn the Passive Keyless Entry system off to prevent the transmitter from activating the locks. You also might want to turn the system off if you have a passenger remaining in the vehicle. If the passenger leaves the vehicle with the alarm armed, he or she might set it off.

Enabling the Passive Keyless Entry System:

To turn the Passive Keyless Entry system on again, simply follow steps 1 through 3 under *Turning the Passive Keyless Entry System Off*.

There are two ways to make sure that the passive feature is on. Either turn the ignition on and check to see that the **PASSIVE KEYLESS ENTRY** light on the Driver Information Center comes on for two seconds, or shut the doors and walk away from the vehicle with the keys and transmitter. If the PKE system is on, the doors will lock.

Passive Keyless Entry Safety Features

This system makes it difficult for you to lock your keys in the vehicle. If the keys are left in the ignition and you lock the doors, the system will automatically unlock the doors as soon as they close.

Also, this system will not lock the door after the transmitter has moved out of range until the key is removed from the ignition and the driver's door has been opened. When using this system, you should become aware of the horn alert once the doors lock automatically. If you have left your keys in the ignition, the horn will not sound. Be sure to lock the doors once you have removed the key from the ignition.

Features & Controls

Passive Keyless Entry Safety Features (CONT.)

If you have your keys and the horn does not sound, check to see if the passive feature is enabled. If the system is enabled and the horn still won't sound, see your dealer for assistance.

The transmitter shuts down after 21 seconds without movement to maximize battery life. If you've locked your keys in the vehicle, but didn't leave them in the ignition, wait 25 seconds, then rock the vehicle. A motion detector inside the transmitter will send a signal to "wake up" the vehicle, which will then unlock the doors.

It is still possible to lock your keys in the vehicle if the transmitter's battery is low, or if it is in a location where a signal can't be received. For your convenience, always take your keys with you.

Matching Transmitter(s) to Your Vehicle

Your Corvette comes equipped from the factory with one Passive Keyless Entry system transmitter. Additional transmitters may be purchased through your dealer. Each key chain transmitter is coded to prevent another transmitter from unlocking your vehicle. If a transmitter is lost or stolen, a replacement can be purchased through your dealer. Remember to bring the remaining transmitter(s) with you when you go to your dealer. When the dealer matches the replacement transmitter to your vehicle, the remaining transmitter(s) must also be matched. Once the new transmitter is coded, the lost transmitter will not unlock your vehicle.

Programming Transmitters

The Passive Keyless Entry system allows up to three transmitters to be matched to your Corvette. Each transmitter has its own code. To operate with your particular vehicle, the code needs to be programmed into the system.

To Engage the Programming Mode:

1. Move all transmitters out of range.
2. Turn the ignition key on.
3. Push the **TRIP ODO** button on the Driver Information Center twice.
4. Within five seconds, press and hold the **FUEL INFO** button on the Driver Information Center until the **PASSIVE KEYLESS ENTRY** light comes on and stays on.
5. Turn the ignition key to the **Off** position, but leave the key in the ignition.

The **PASSIVE KEYLESS ENTRY** light should flash once per second signaling that the system is ready to program the first transmitter. The number of times the light flashes corresponds to the number of the transmitter you're programming (once per second for the first transmitter, twice per second for the second transmitter, and three times per second for the third transmitter).

Programming a Transmitter:

1. Bring a transmitter into range.
2. The **PASSIVE KEYLESS ENTRY** light will come on and stay on, signaling that the code has been stored.
3. Move the transmitter out of range. The system light will flash again and the system is ready for the next transmitter.
4. You can turn off the programming mode by removing the key from the ignition or by turning the ignition on. Turning off the programming mode before you program any transmitters will not cancel any transmitter codes already programmed into the system. Bringing more than one transmitter into range at a time will make it difficult for the system to search for individual codes.

The programming mode will shut off after two minutes if:

- you have not programmed any transmitters,
- you have taken the key out of the ignition, or
- after three transmitters have been programmed.

If a transmitter is lost or stolen, a replacement can be purchased through your dealer.

If fewer than three transmitters are programmed, only those transmitters will work with your vehicle.

When the first transmitter is programmed, all previous transmitter codes will be erased. So when programming a new transmitter, all other transmitters must be reprogrammed.

Features & Controls

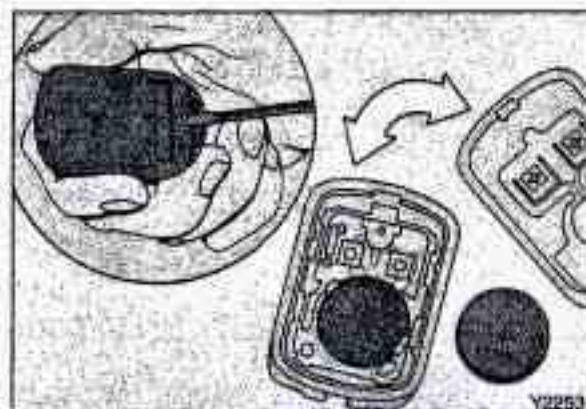

Battery Replacement

Under normal use, the batteries in your key chain transmitter should last about eighteen months.

You can tell the batteries are weak if the transmitter won't work at the normal range in any location. If you have to get close to your vehicle before the transmitter works, it's probably time to change the batteries.

To Replace Your Battery:

1. Gently pry the back of the transmitter off.
2. Gently push back the battery retainer and remove the battery (DL2450 or equivalent).
3. Replace the battery by placing the negative side down first.
4. Replace the transmitter cover and squeeze the two halves together.
5. Check the transmitter operation.

Theft

Vehicle theft is big business, especially in some cities. Although your Corvette has a number of theft deterrent features, we know that nothing we put on it can make it impossible to steal. However, there are ways you can help.

Key in the Ignition: If you walk away from your vehicle with the keys inside, it's an easy target for joy riders or professional thieves—so don't do it. When you park your Corvette and open the driver's door, you'll hear a chime reminding you to remove your key from the ignition and take it with you. Always do this. Your steering wheel will be locked, and so will your ignition. If you have an automatic transmission, taking your key out also locks your transmission. And remember to lock the doors.

Parking at Night: Park in a lighted spot, close all windows and lock your vehicle. Remember to keep your valuables out of sight. Put them in a storage area, or take them with you.

Parking Lots: If you park in a lot where someone will be watching your vehicle, it's best to lock it up and take your keys. But what if you have to leave your ignition key? What if you have to leave something valuable in your vehicle?

- Put your valuables in a storage area, like the rear area, glove box or center console.
- Lock the rear storage area, glove box and center console.
- Pull the security shade over rear area.
- Lock all the doors except the driver's.
- Then take the door key with you.

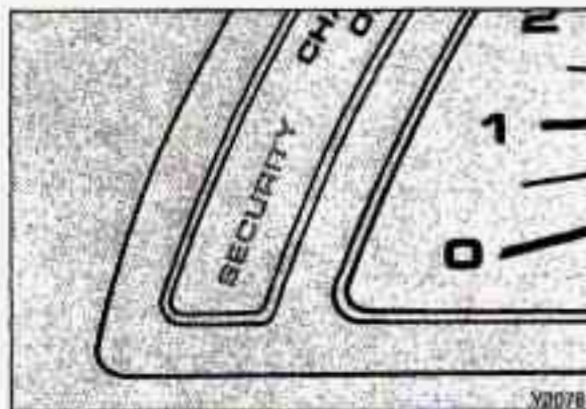

Universal Theft Deterrent

Your Corvette has a theft deterrent alarm system. With this system, the **SECURITY** light will flash as you open the door (if your ignition is off).

This light reminds you to arm the theft deterrent system.

Here's How to Do It:

1. Open the door.
2. Lock the door with the power door lock switch or Passive Keyless Entry system. The **SECURITY** light should come on and stay on.
3. Close all doors. The **SECURITY** light should go off.

If a door or the hatch is opened without the key or Passive Keyless Entry system, the alarm will go off.

Your vehicle's horn will sound for three minutes, then will go off to save battery power. And, your vehicle will not start.

Remember, the theft deterrent system won't arm if you lock the doors with a key or manual door lock. It arms only if you use a power door lock switch or Passive Keyless Entry system.

Features & Controls

Universal Theft Deterrent (CONT.)

Here's How to Avoid Setting Off the Alarm by Accident:

- If you don't want to arm the theft deterrent system, the vehicle should be locked **after** the doors are closed.
- If your passenger stays in the vehicle when you leave with the keys, have the **passenger** lock the vehicle **after** the doors are closed. Also, if your passenger stays in the vehicle, you can turn the Passive Keyless Entry system off by holding the **DOOR** button on the transmitter for two seconds when the key is out of the ignition. The Passive Keyless Entry system will be disabled and won't automatically lock the doors and arm the theft deterrent system.
- Always unlock a door with a key, or use the Passive Keyless Entry system. Unlocking a door any other way will set off the alarm.

If you set off the alarm by accident, unlock any door with your key, or insert the ignition key in the ignition. You can also turn off the alarm by using the Passive Keyless Entry system.

The alarm won't stop if you try to unlock a door any other way.

How to Test the Alarm:

Follow these steps to test your alarm system:

1. Make sure that the rear hatch is latched.
2. Leave a window down.
3. Arm the system as explained previously.
4. Close the doors and wait five seconds.
5. Reach in through the window, unlock the door from inside the vehicle, and open the door. The alarm should sound.
6. Shut off the alarm by using the door key to unlock either door from the outside of the vehicle, or insert the key in the ignition.



If the alarm does not sound when it should, check to see if the horn works. The horn fuse may be blown. To replace the fuse, see the *Index* under *Fuses & Circuit Breakers*.

To reduce the possibility of theft, always arm the theft deterrent system when leaving your vehicle.

PASS-Key™

Your vehicle is equipped with the PASS-Key™ (Personalized Automotive Security System) theft deterrent system. PASS-Key™ is a passive theft deterrent system. This means you don't have to do anything different to arm or disarm the system. It works when you insert or remove the key from the ignition. PASS-Key™ uses a resistor pellet in the ignition key that matches a decoder in your vehicle.

When the PASS-Key™ system senses that someone is using the wrong key, it shuts down the vehicle's starter and fuel systems. For about three minutes, the starter won't work and fuel won't go to the engine. If someone tries to start your vehicle again or uses another key during this time, the shutdown period will start over again. This discourages someone from randomly trying different keys with different resistor pellets in an attempt to make a match.

Features & Controls

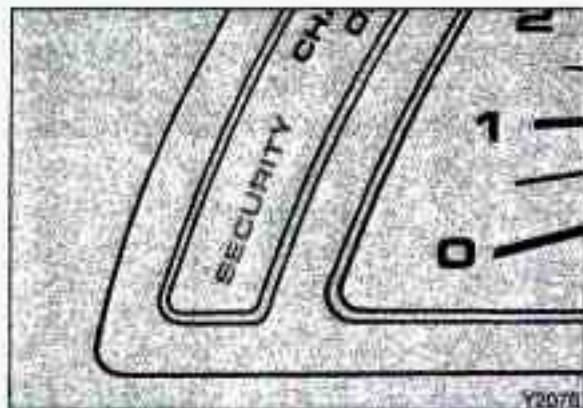

PASS-Key™ (CONT.)

The ignition key must be clean and dry before it's inserted in the ignition or the engine may not start. If the **SECURITY** light comes on, the key may be dirty or wet.

If this happens and the starter won't work, turn the ignition off. Clean and dry the key, wait three minutes and try again. If the starter still won't work, wait three minutes and try the other ignition key. At this time, you may also want to check the fuses (see the *Index* under *Fuses & Circuit Breakers*). If the starter won't work with the other key, your vehicle needs service. If your vehicle does start, the first ignition key may be faulty. See your Chevrolet dealer or a locksmith who can service the PASS-Key.™

However, if you accidentally use a key that has a damaged or missing resistor pellet, you will see no **SECURITY** light. You don't have to wait three minutes before trying the proper key.

If the resistor pellet is damaged or missing, the starter won't work. Use the other ignition key, and see your Chevrolet dealer or a locksmith who can service the PASS-Key™ to have a new key made.

If the **SECURITY** light comes on while driving, have your vehicle serviced as soon as possible.

If you lose or damage a PASS-Key™ ignition key, see your Chevrolet dealer or a locksmith who can service PASS-Key.™



Engine Power Key (LT5 ENGINE ONLY)

This key is used in the engine power switch. See the *Index* under *Engine Power Switch*.

DAB (Delayed Accessory Bus)

With this feature the power windows will continue to work and the radio will continue to play up to 15 minutes after the ignition key is turned to the **Off** position and removed. DAB will shut off when you open the driver's or passenger's door.

Illuminated Entry System

A photo cell will activate your courtesy lights in low light levels, when you unlock your doors with the door key or with the Passive Keyless Entry transmitter.

The courtesy lights inside your vehicle will go on. These lights will go off after about 30 seconds, or when you start your engine.

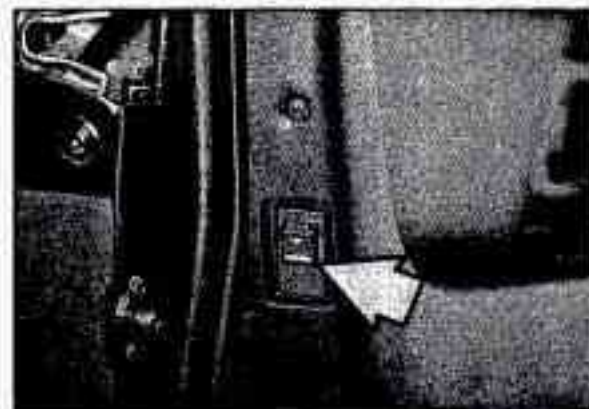

Remote Hatch Release (COUPE)

Push down on the hatch release button located on the rear of the driver's door to release the hatch. This button will work with the door open and with the transmission (automatic or manual) in any gear.

In addition, you can release the hatch with the Passive Keyless Entry transmitter when the transmission is in **P** (Park) or **N** (Neutral), and the ignition is off.

Features & Controls

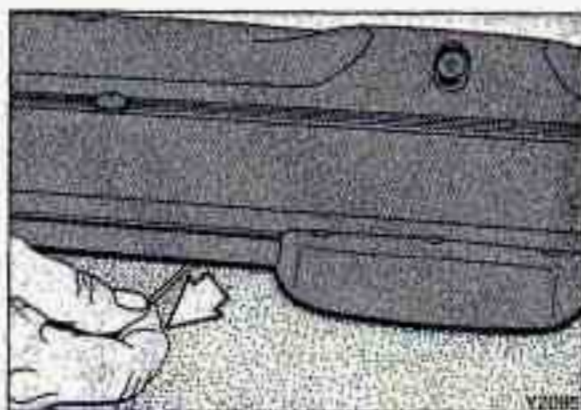

Remote Hatch Release (CONT.)

NOTICE

When closing your rear hatch glass on your coupe, take special care to always close from directly above the striker assembly. Excessive off-center closures could result in weatherstrip damage.

Pressing the button located in the center storage console also releases the hatch or convertible compartment cover.

For the console release button to work, if you have an automatic transmission, it must be in **P** (Park) or **N** (Neutral).

For a manual transmission you must set the parking brake.

To open the hatch if there is a power loss such as a "dead" battery, use the manual release cable, located between the carpet and security shade near the center of the vehicle. To open the hatch, pull the cable forward.

CAUTION



It can be dangerous to drive with the hatch open. Carbon monoxide (CO) gas can come into your vehicle. You can't see or smell CO. It can cause unconsciousness and even death.

If you must drive with the hatch open:

- Make sure all other windows are shut.
- Turn the fan on your heating or cooling system to its highest speed with the setting on bi-level or vent. That will force outside air into your vehicle. See the *Index* under *Climate Controls*.
- If you have air vents on the instrument panel, open them all the way.



Glove Box

Use the door key to lock and unlock the glove box. To open, pinch the handle, then lift up.

New Vehicle "Break-In"

NOTICE

Your modern Corvette doesn't need an elaborate "break-in." But it will perform better in the long run if you follow these guidelines:

- Keep your speed at 55 mph (88 km/h) or less for the first 500 miles (804 km).
- Don't drive at any one speed—fast or slow—for the first 500 miles (804 km).
- Don't make full-throttle starts.
- Avoid making hard stops for the first 200 miles (322 km) or so. During this time your new brake linings aren't yet broken in. Hard stops with new linings can mean premature wear and earlier replacement. Follow this "breaking-in" guideline every time you get new brake linings.

Features & Controls

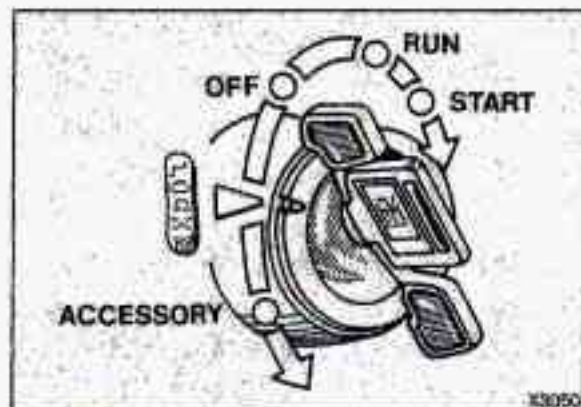

Ignition Switch

With the ignition key in the ignition switch, you can turn the switch to five positions:

Accessory: An “on” position in which you can operate your electrical power accessories. Press in the ignition switch as you turn the top of it toward you.

Lock: The only position in which you can remove the key. This locks your steering wheel, ignition and automatic shift lever.

Off: Unlocks the steering wheel, ignition, and automatic shift lever. Use this position if your vehicle must be pushed or towed, but never try to push-start your vehicle. A warning chime will sound if you open the driver’s door

when the ignition is off and the key is in the ignition.

Run: An “on” position to which the switch returns after you start your engine and release the switch. The switch stays in the **Run** position when the engine is running. But even when the engine is not running, you can use **Run** to operate your electrical power accessories, and to display some instrument panel warning lights.

Start: Starts the engine. When the engine starts, release the key. The ignition switch will return to **Run** for normal driving.

Note that even if the engine is not running, the positions **Accessory** and **Run** are “on” positions that allow you to operate your electrical accessories, such as the radio.

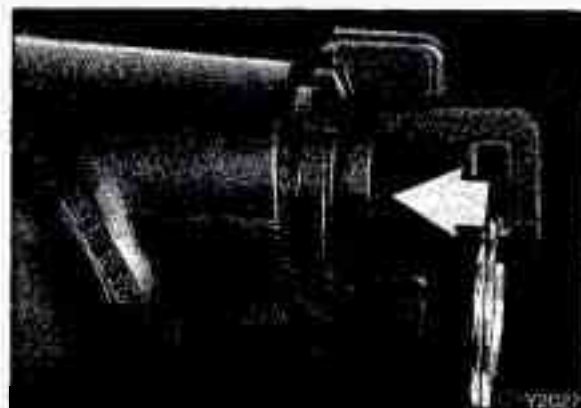

Key Release Button (MANUAL TRANSMISSION)

With a manual transmission, the ignition key cannot be removed from the ignition unless the key release button is used.

To Remove the Key:

Turn the key to the **Lock** position while pressing the key release button down at the same time. Keeping your thumb on the button, pull the key straight out.

CAUTION



On manual transmission vehicles, turning the key to **Lock** will lock the steering column and result in a loss of ability to steer the vehicle. This could cause a collision. If you need to turn the engine off while the vehicle is moving, turn the key only to **Off**. Don't press the key release button while the vehicle is moving.

NOTICE

If your key seems stuck in **Lock** and you can't turn it, be sure it is all the way in. If it is, then turn the steering wheel left and right while you turn the key hard. But turn the key only with your hand. Using a tool to force it could break the key or the ignition switch. If none of this works, then your vehicle needs service.

■ Starting Your Engine

Engines start differently. The 8th digit of your Vehicle Identification Number (VIN) shows the code letter or number for your engine. You will find the VIN at the top left of your instrument panel. (See the *Index* under *Vehicle Identification Number*.) Follow the proper steps to start your engine.

Features & Controls

To Start Your LT1 Engine (CODE P)

Automatic Transmission

Move your shift lever to **P** (Park) or **N** (Neutral). Your engine won't start in any other position—that's a safety feature. To restart when you're already moving, use **N** (Neutral) only.

NOTICE

Don't try to shift to **P** (Park) if your Corvette is moving. If you do, you could damage the transmission. Shift to **P** (Park) only when your vehicle is stopped.

Manual Transmission

Shift your gear selector to **N** (Neutral) and hold the clutch pedal to the floor while starting the engine. Your vehicle won't start if the clutch pedal is not all the way down—that's a safety feature.

1. Don't push the accelerator pedal before starting your engine. In some other vehicles you might need to do this, but because of your vehicle's computer systems, you don't.
2. Turn the ignition key to **Start**. When the engine starts, let go of the key. The idle speed will go down as your engine gets warm.
3. If it doesn't start within ten seconds, push the accelerator pedal all the way to the floor, while you hold the ignition key in **Start**. When the engine starts, let go of the key and let up on the accelerator pedal. Wait about 15 seconds between each try to help avoid draining your battery.

NOTICE

Holding your key in **Start** for longer than 15 seconds at a time will cause your battery to be drained much sooner. And the excessive heat can damage your starter motor.

When starting your engine in very cold weather (below 0° F or -18° C), do this:

1. With your foot off the accelerator pedal, turn the ignition key to **Start** and hold it there. When the engine starts, let go of the key. Use the accelerator pedal to maintain engine speed, if you have to, until your engine has run for a while.

2. If your engine still won't start (or starts but then stops), it could be flooded with too much gasoline. Try pushing your accelerator pedal all the way to the floor and holding it there as you hold the key in **Start** for about three seconds. If the vehicle starts briefly but then stops again, do the same thing, but this time keep the pedal down for five or six seconds. This clears the extra gasoline from the engine.

NOTICE

Your engine is designed to work with the electronics in your vehicle. If you add electrical parts or accessories, you could change the way the fuel injection system operates. Before adding electrical equipment, check with your dealer. If you don't, your engine might not perform properly.

If you ever have to have your Corvette towed, see the part of this manual that tells how to do it without damaging your vehicle. See the *Index* under *Towing Your Corvette*.

Features & Controls

To Start Your LT5 Engine (CODE J)

Shift your gear selector to **N** (Neutral) and hold the clutch pedal to the floor while starting the engine. Your vehicle won't start if the clutch pedal is not all the way down—that's a safety feature.

1. Don't push the accelerator pedal before starting your engine. In some other vehicles you might need to do this, but because of your vehicle's computer systems, you don't.
2. Turn the ignition key to **Start**. When the engine starts, let go of the key. The idle speed will go down as your engine gets warm.

3. If it doesn't start within three seconds, push the accelerator pedal about one-third of the way down, while you hold the ignition key in **Start**. When the engine starts, let go of the key and let up on the accelerator pedal. Wait about 15 seconds between each try to help avoid draining your battery.

NOTICE

Holding your key in **Start** for longer than 15 seconds at a time will cause your battery to be drained much sooner. And the excessive heat can damage your starter motor.

When starting your engine in very cold weather (below 0°F or -18°C), do this:

1. With your foot off the accelerator pedal, turn the ignition key to **Start** and hold it there. After two seconds, push the accelerator pedal down just a little. When the engine starts, let go of the key. Use the accelerator pedal to maintain engine speed, if you have to, until your engine has run for a while.

2. If your engine still won't start (or starts but then stops), it could be flooded with too much gasoline. Try pushing your accelerator pedal all the way to the floor and holding it there as you hold the key in **Start** for about three seconds. If the vehicle starts briefly but then stops again, do the same thing, but this time keep the pedal down for five or six seconds. This clears the extra gasoline from the engine.

NOTICE

Your engine is designed to work with the electronics in your vehicle. If you add electrical parts or accessories, you could change the way the fuel injection system operates. Before adding electrical equipment, check with your dealer. If you don't, your engine might not perform properly.

If you ever have to have your Corvette towed, see the part of this manual that tells how to do it without damaging your vehicle. See the *Index* under *Towing Your Corvette*.

Driving Through Deep Standing Water

NOTICE

If you drive too quickly through deep puddles or standing water, water can come in through your engine's air intake and badly damage your engine. If you can't avoid deep puddles or standing water, drive through them very slowly.

Features & Controls



Engine Block Heater *(LT1 ENGINE, CANADA ONLY)*

In very cold weather, 0°F (-18°C) or colder, the engine block heater can help. You'll get easier starting and better fuel economy during engine warm-up.

To Use the Engine Block Heater:

1. Turn off the engine.
2. Open the hood and unwrap the electrical cord.
3. Plug it into a normal, grounded 110-volt outlet.

CAUTION



Plugging the cord into an ungrounded outlet could cause an electrical shock. Also, the wrong kind of extension cord could overheat and cause a fire. You could be seriously injured. Plug the cord into a properly grounded three-prong 110-volt outlet. If the cord won't reach, use a heavy-duty three-prong extension cord rated for at least 15 amps.

NOTICE

After you've used the block heater, be sure to store the cord as it was before, to keep it away from moving engine parts. If you don't, it could be damaged.

How long should you keep the block heater plugged in? The answer depends on the weather, the kind of oil you have, and some other things. Instead of trying to list everything here, we ask that you contact a Chevrolet dealer in the area where you'll be parking your vehicle. The dealer can give you the best advice for that particular area.



■ *Shifting the Automatic Transmission*

Your automatic transmission has a shift lever located on the console between the seats.

There are several different positions for your shift lever.

Park	P
Reverse	R
Neutral	N
Overdrive	D
Drive	D
Second	2
First	1

Park

P (Park): This locks your rear wheels. It's the best position to use when you start your engine because your vehicle can't move easily.

CAUTION



It is dangerous to get out of your vehicle if the shift lever is not fully in **P (Park)** with the parking brake firmly set. Your vehicle can roll.

Don't leave your vehicle when the engine is running unless you have to. If you have left the engine running, the vehicle can move suddenly. You or others could be injured. To be sure your vehicle won't move, when you're on fairly level ground, always set your parking brake and move the shift lever to **P (Park)**.

See the *Index* under *Shifting Into P (Park)*. If you are parking on a hill, also see the *Index* under *Parking on Hills*.

Features & Controls



Reverse

R (Reverse): Use this gear to back up.

NOTICE

Shifting to **R (Reverse)** while your vehicle is moving forward could damage your transmission. Shift to **R (Reverse)** only after your vehicle has stopped.

To rock your vehicle back and forth to get out of snow, ice or sand without damaging your transmission, see the *Index* under *If You're Stuck: In Sand, Mud, Ice or Snow*.



Neutral

N (Neutral): In this position, your engine doesn't connect with the wheels. To restart when you're already moving, use **N (Neutral)** only. Also, use **N (Neutral)** when your vehicle is being towed.

CAUTION



Shifting out of **P (Park)** or **N (Neutral)** while your engine is "racing" (running at high speed) is dangerous. Unless your foot is firmly on the brake pedal, your vehicle could move very rapidly. You could lose control and hit people or objects. Don't shift out of **P (Park)** or **N (Neutral)** while your engine is racing.



NOTICE

Damage to your transmission caused by shifting out of **P** (Park) or **N** (Neutral) with the engine racing isn't covered by your warranty.

Forward Gears

D (Automatic Overdrive): This position is for normal driving. If you need more power for passing, and you're:

- Going less than about 35 mph (56 km/h), push your accelerator pedal about halfway down.
- Going about 35 mph (56 km/h) or more, push the accelerator all the way down.

You'll shift down to the next gear and have more power.

D (Third Gear): This is like **D**, but you never go into Overdrive.

Here are some times you might choose **D** instead of **D**:

- When driving on hilly, winding roads.
- When going down a steep hill.

2 (Second Gear): This position gives you more power but lower fuel economy. You can use **2** on hills. It can help control your speed as you go down steep mountain roads, but then you would also want to use your brakes off and on.

1 (First Gear): This position gives you even more power (but lower fuel economy) than **2**. You can use it on very steep hills, or in deep snow or mud. If the selector lever is put in **1**, the transmission won't shift into first gear until the vehicle is going slowly enough.

Features & Controls

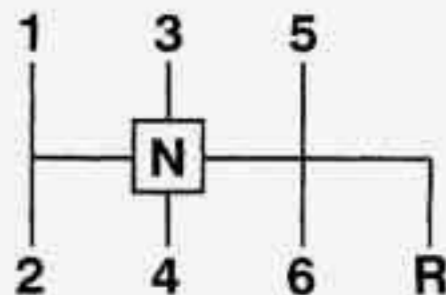

Forward Gears (CONT.)

NOTICE

If your rear wheels can't rotate, don't try to drive. This might happen if you were stuck in very deep sand or mud or were up against a solid object. You could damage your transmission.

Also, if you stop when going uphill, don't hold your vehicle there with only the accelerator pedal. This could overheat and damage the transmission. Use your brakes or shift into **P** (Park) to hold your vehicle in position on a hill.

■ Shifting the 6-Speed Manual Transmission

There are eight different positions:

- N** Neutral
- 1** First Gear
- 2** Second Gear
- 3** Third Gear
- 4** Fourth Gear
- 5** Fifth Gear
- 6** Sixth Gear
- R** Reverse

This is your shift pattern. Here's how to operate your transmission.

1 (First Gear): Press the clutch pedal and shift into **1**. Then, slowly let up on the clutch pedal as you press the accelerator pedal.

You can shift into **1** when you're going less than 40 mph (64 km/h). If you've come to a complete stop and it's hard to shift into **1**, put the shift lever in **N** (Neutral) and let up on the clutch. Press the clutch pedal back down. Then shift into **1**.

2 (Second Gear): Press the clutch pedal as you let up on the accelerator pedal and shift into **2**. Then, slowly let up on the clutch pedal as you press the accelerator pedal.

3, 4, 5 and 6 (Third, Fourth, Fifth and Sixth Gears): Shift into **3, 4, 5** and **6** the same way you do for **2**. Slowly let up on the clutch pedal as you press the accelerator pedal.

To Stop

Let up on the accelerator pedal and press the brake pedal. Just before the vehicle stops, press the clutch pedal and the brake pedal, and shift to **N (Neutral)**.

N (Neutral): Use this position when you start or idle your engine.

R (Reverse): To back up, press down the clutch pedal and shift into **R (Reverse)**. Let up on the clutch pedal slowly while pressing the accelerator pedal.

If you shift from Overdrive into **R (Reverse)**, the shift lever must be first placed in the **N (Neutral)** position centered between **2** and **3** prior to shifting into **R (Reverse)**.

Your 6-speed manual transmission has a feature that allows you to safely shift into **R (Reverse)** while the vehicle is rolling (at less than 5 mph). You will be "locked-out" if you try to shift into **R (Reverse)** while your vehicle is moving faster than 5 mph.

If you have turned your ignition off and wish to park your car in **R (Reverse)**, you will have to move the shift lever quickly to the right, "crashing" through the high load spring and then into gear.

Features & Controls

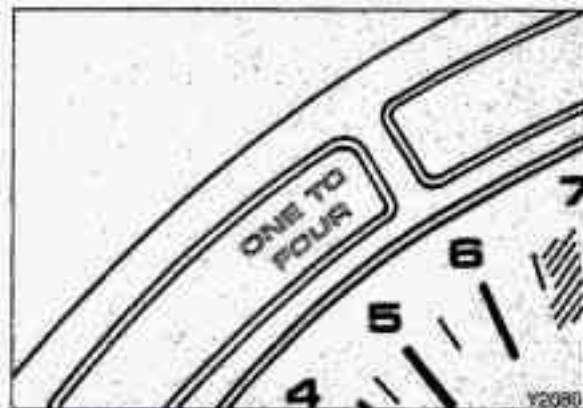

Shift Speeds

(MANUAL TRANSMISSION)

This chart shows when to shift to the next higher gear for best fuel economy.

If your speed drops below 20 mph (32 km/h), or if the engine is not running smoothly, you should downshift to the next lower gear. You may have to downshift two or more gears to keep the engine running smoothly or for good performance.

Acceleration Shift Speeds:

1st to 2nd.....	15 mph (24 km/h)
2nd to 3rd.....	25 mph (40 km/h)
3rd to 4th.....	40 mph (64 km/h)
4th to 5th.....	45 mph (72 km/h)
5th to 6th.....	50 mph (80 km/h)

NOTICE

When you are shifting gears, don't move the gear shift lever around needlessly. This can damage parts of the transmission and may require costly repairs. Just shift directly to the next appropriate gear.

Shift Light

(MANUAL TRANSMISSION)

This light will display **ONE TO FOUR**. When this light comes on, you can only shift from **1** to **4** instead of **1** to **2**. This helps you to get the best possible fuel economy.

This light will come on under these conditions:

- The engine coolant temperature is greater than 120°F (50°C),
- You are going 12-19 mph (20-29 km/h), and
- You are at 35% throttle or less.

When this light is on, the gear shift lever will let you shift from **1** to **4** only. Once you are in **4** you can press the clutch again and shift into another gear.

Follow the shift speeds in this chart when the **ONE TO FOUR** light is on.

Computer Aided Manual Transmission Shift Speeds:

1st to 4th	15 mph (24 km/h)
4th to 5th	25 mph (40 km/h)*
5th to 6th	40 mph (64 km/h)**

Each time you come to a stop, your vehicle's Engine Control Module (ECM) determines when to activate the **ONE TO FOUR** upshift system. Use **2** only when you accelerate very quickly from a stop. You can then follow the full gear shift pattern.

* 30 mph (48 km/h) when accelerating to highway speeds

** 45 mph (72 km/h) when accelerating to highway speeds

Shifting Down to Lower Gears

NOTICE

Be careful when you downshift. If you don't shift correctly, you can damage your transmission and maybe even lose control.

When you downshift, don't skip more than one gear. For example, you can shift from **6** to **5** or from **6** to **4**. But don't shift from **6** to **3**.

Be careful not to drive faster than the speeds shown for each gear.

Maximum Speed Limits When Downshifting:

1st	40 mph (64 km/h)
2nd	60 mph (97 km/h)
3rd	80 mph (129 km/h)
4th	105 mph (169 km/h)

CAUTION



If you skip more than one gear when you downshift, you could lose control of your vehicle. And you could injure yourself and others. Don't shift from **6** to **3**, **5** to **2**, or **4** to **1**.

Features & Controls

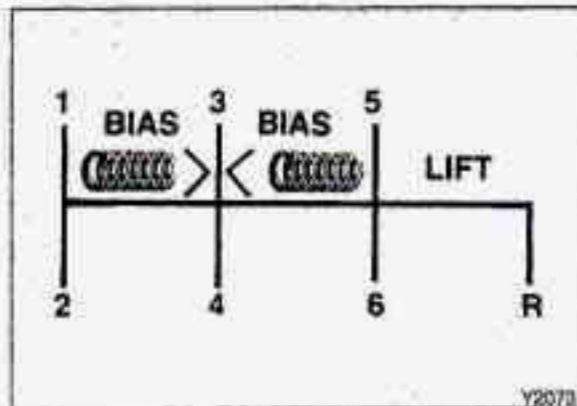

Shifting Down to Lower Gears (CONT.)

NOTICE

If you skip more than one gear when you downshift, or if you race the engine when you downshift, you can damage the clutch or transmission.

The six-speed transmission has springs that center the shift lever near 3 and 4. These springs help you know which gear you are in when you are shifting. Be careful when shifting from 1 to 2 or downshifting from 6 to 5. The springs will try to pull the gear shift lever towards 3 and 4. Make sure you move the lever into 2 or 5. If you let the lever move in the direction of the pulling, you may end up shifting from 1 to 4 or from 6 to 3.

Engine Power Switch (LT5 ENGINE)

The LT5 or ZR-1 engine has two sets of intake runners and fuel injectors—primary and secondary. The primary set may be run independently from the secondary system, providing **NORMAL** engine power, or both primary and secondary systems may be used to provide **FULL** engine power. This feature allows **FULL** power performance only at the driver's discretion. In the **NORMAL** setting, engine and exhaust noise are less evident.



Insert the Engine Power Key into the slot and turn clockwise to **FULL**. An indicator light will come on when **FULL** power performance is operating. To return to **NORMAL** power, turn key counterclockwise. The indicator light should stop glowing. The key returns to the center position when released. The key can be removed when the engine is in **FULL** or **NORMAL** power and only from the center position.

The **FULL** power setting provides additional power for highway touring and off-road sports use as well as reserve power for passing. Both primary and secondary fuel intake runners and injectors can operate when the **FULL** setting is chosen.

When the ignition is shut off, the engine reverts to **NORMAL** power.

Your ZR-1 is capable of operating at **FULL** power when the indicator light is on and under the following conditions:

- The engine coolant and oil temperatures are greater than 68°F (20°C) but less than 302°F (150°C), and
- The system voltage is greater than 10 volts, and
- There is no **SERVICE ENGINE SOON** light indicated on the Driver Information Center.

Switching from the **NORMAL** to the **FULL** setting and from the **FULL** to the **NORMAL** setting may be done at engine speeds up to 4,000 rpm.

ZR-1 Toll-Free Number:

If you have any questions or concerns about your ZR-1 Special Performance Coupe, call the following toll-free telephone number for assistance: 1-800-222-1020 (U.S. only).

Features & Controls



Off-Road Track Use

See your Warranty Booklet before using your Corvette for off-road track use.

NOTICE

If you use your Corvette for off-road track use, your engine may use more oil than it would with normal use. Low oil levels can damage the engine. Be sure to check the oil level often during off-road track use. It may be necessary to add additional oil. See the *Index* under *Engine Oil*.

Selective Ride Control (OPTION)

This knob, located on the center console, has three settings: **TOUR**, **SPORT**, and **PERF** (Performance). Turn it to select the ride control of your choice. You can select a setting at any time. Based on your speed, the Selective Ride Control system automatically adjusts within each setting to provide the best ride and handling. Select a new setting whenever driving conditions change.

The **SERVICE RIDE CONTROL** light monitors the Selective Ride Control system. See the *Index* under *Service Ride Control Light* for more information.

Limited-Slip Rear Axle

Your Corvette's limited-slip rear axle can give you additional traction on snow, mud, ice, sand or gravel. It works like a standard axle most of the time, but when one of the rear wheels has no traction and the other does, the limited-slip feature will allow the wheel with traction to move the vehicle.



Parking Brake

To Set the Parking Brake:

Hold the brake pedal down. Pull the parking brake lever up, then move it back down. This sets your parking brake—even though the lever is down. If the ignition is on, the brake system warning light will come on.



To Release the Parking Brake:

Hold the brake pedal down. Pull the parking brake lever up until you can push in the release button. Hold the release button in as you move the brake lever all the way down.

NOTICE

Driving with the parking brake on can cause your rear brakes to overheat. You may have to replace them, and you could also damage other parts of your vehicle.

If You are on a Hill:

See the *Index* under *Parking on Hills*. That section shows how to turn your front wheels.

Features & Controls

Shifting Into P (Park) (AUTOMATIC TRANSMISSION)

CAUTION

 It can be dangerous to get out of your vehicle if the shift lever is not fully in **P** (Park) with the parking brake firmly set. Your vehicle can roll.

If you have left the engine running, the vehicle can move suddenly. You or others could be injured. To be sure your vehicle won't move, when you're on fairly level ground, use the steps that follow. If you are parking on a hill, also see the *Index* under *Parking on Hills*.

1. Hold the brake pedal down with your right foot and set the parking brake.



2. Move the shift lever into the **P** (Park) position by holding in the button on the lever and pushing the lever all the way toward the front of the vehicle.
3. Move the ignition key to **Lock**.
4. Remove the key and take it with you. If you can walk away from your vehicle with the ignition key in your hand, your vehicle is in **P** (Park).

Leaving Your Vehicle With the Engine Running (AUTOMATIC TRANSMISSION)

CAUTION

 It is dangerous to leave your vehicle with the engine running. Your vehicle could move suddenly if the shift lever is not fully in **P** (Park) with the parking brake firmly set. And, if you leave the vehicle with the engine running, it could overheat and even catch fire. You or others could be injured. Don't leave your vehicle with the engine running unless you have to.

If you have to leave your vehicle with the engine running, be sure your vehicle is in **P** (Park) and your parking brake is firmly set before you leave it. After you've moved the shift lever into the **P** (Park) position, hold the regular brake pedal down. Then, see if you can move the shift lever away from **P** (Park) without first pushing the button.

If you can, it means that the shift lever wasn't fully locked into **P** (Park).

Parking Your Vehicle (MANUAL TRANSMISSION)

Before you get out of your vehicle, put your manual transmission in **R** (Reverse) and firmly apply the parking brake.

If you are parking on a hill, see the *Index* under *Parking on Hills*.



Parking Over Things That Burn

CAUTION



Things that can burn could touch hot exhaust parts under your vehicle and ignite. Don't park over papers, leaves, dry grass or other things that can burn.

Engine Exhaust

CAUTION



Engine exhaust can kill. It contains the gas carbon monoxide (CO), which you can't see or smell. It can cause unconsciousness and death.

You might have exhaust coming in if:

- Your exhaust system sounds strange or different.
- Your vehicle gets rusty underneath.
- Your vehicle was damaged in a collision.
- Your vehicle was damaged when driving over high points on the road or over road debris.
- Repairs weren't done correctly.
- Your vehicle or exhaust system had been modified improperly.

If you **ever** suspect exhaust is coming into your vehicle:

- Drive it only with all the windows down to blow out any CO; and
- Have it fixed **immediately**.

Features & Controls

Running Your Engine While You're Parked

(AUTOMATIC TRANSMISSION)

It's better not to park with the engine running. But if you ever have to, here are some things to know.

CAUTION



Idling the engine with the air system control **OFF** could allow dangerous exhaust into your vehicle (see the earlier **CAUTION** under *Engine Exhaust*).

Also, idling in a closed-in place can let deadly carbon monoxide (CO) into your vehicle even if the fan switch is at the highest setting. One place this can happen is a garage. Exhaust—with CO—can come in easily. **Never** park in a garage with the engine running.

Another closed-in place can be a blizzard. (See the *Index* under *Blizzard*.)

It can be dangerous to get out of your vehicle if the shift lever is not fully in **P** (Park) with the parking brake firmly set. Your vehicle can roll. Don't leave your vehicle when the engine is running unless you have to. If you've left the engine running, the vehicle can move suddenly. You or others could be injured. To be sure your vehicle won't move, even when you're on fairly level ground, always set your parking brake and move the shift lever to **P** (Park).

If you are parking on a hill, also see the *Index* under *Parking on Hills*.

Rough Idling

If you notice rough idling or surging of the engine, especially after long periods of idling or during slow city driving, the oxygen sensors may be clogged. If this happens, place the automatic transmission in **P** (Park) or manual transmission in **N** (Neutral), firmly apply the parking brake, and accelerate to 2000 rpm for two minutes. This will clear the oxygen sensors.

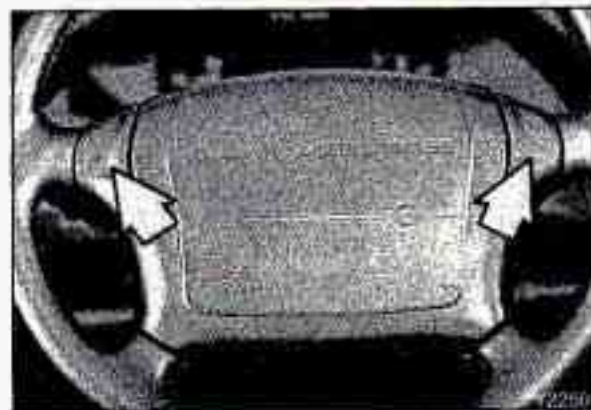

Horn

You can sound the horn by pressing either horn symbol on your steering wheel.

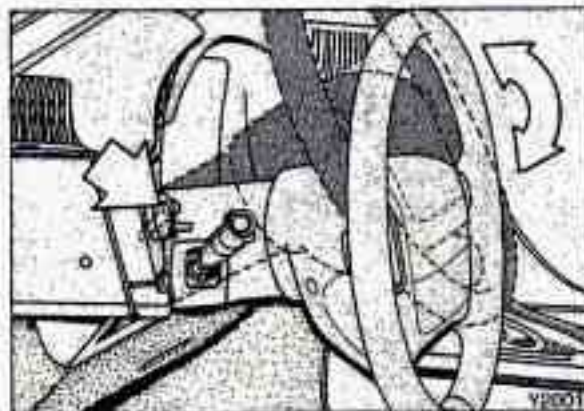

Tilt Steering Wheel

A tilt steering wheel allows you to adjust the steering wheel before you drive. You can also raise it to the highest level to give your legs more room when you exit and enter the vehicle.

To tilt the wheel, hold the steering wheel and pull the lever. Move the steering wheel to a comfortable level, then release the lever to lock the wheel in place.



Power Windows

With power windows, switches on the driver's armrest control each of the windows when the ignition is on. In addition, the passenger door has a control switch for its own window. Push each switch up or forward to raise the power window; push it down or rearward to lower the window.

The power windows will remain operative for fifteen minutes after the ignition key is turned to the **Off** position. Once either door is opened the windows will not operate. See the *Index* under *DAB (Delayed Accessory Bus)*.

Features & Controls



■ Turn Signal/Headlight Beam Lever

The lever on the left side of the steering column includes your:

- Turn Signal and Lane Change Indicator
- Headlight High-Low Beam Changer
- Windshield Wipers
- Windshield Washer
- Cruise Control

The High-Low Beam feature is discussed under *Headlights*. See the *Index* under *Headlights*.

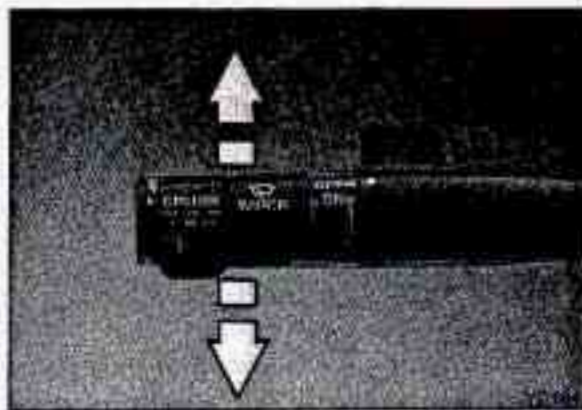

Turn Signal and Lane Change Indicator

The turn signal has two upward (for Right) and two downward (for Left) positions. These positions allow you to signal a turn or a lane change.

To signal a turn, move the lever all the way up or down. When the turn is finished, the lever will return automatically.

A green arrow on the instrument panel will flash in the direction of the turn or lane change.

To signal a lane change, just raise or lower the lever until the green arrow starts to flash. Hold it there until you complete your lane change. The lever will return by itself when you release it.



As you signal a turn or a lane change, if the arrows don't flash but just stay on, a signal bulb may be burned out and other drivers won't see your turn signal.

If a bulb is burned out, replace it to help avoid an accident. If the green arrows don't go on at all when you signal a turn, check the fuse (see the *Index* under *Fuses & Circuit Breakers*) and for burned-out bulbs.

A warning chime will remind you if you have left your turn signal on for more than 1 mile (1.6 km) of driving.



Windshield Wipers

You control the windshield wipers by turning the band marked **WIPER**.

For a single wiping cycle, turn the band to **MIST**. Hold it there until the wipers start, then let go. The wipers will stop after one cycle. If you want more cycles, hold the band on **MIST** longer.

You can set the wiper speed for a long or short delay between wipes. This can be very useful in light rain or snow.

Turn the band to choose the delay time. The closer to **LO**, the shorter the delay.

For steady wiping at low speed, turn the band away from you to the **LO** position. For high speed wiping, turn the band further, to **HI**. To stop the wipers, move the band to **OFF**.

CAUTION



Damaged wiper blades may prevent you from seeing well enough to drive safely. To avoid damage, be sure to clear ice and snow from the wiper blades before using them. If they're frozen to the windshield, carefully loosen or thaw them. If your blades do become damaged, get new blades or blade inserts.

Heavy snow or ice can overload your wipers. A circuit breaker will stop them until the motor cools. Clear away snow or ice to prevent an overload.

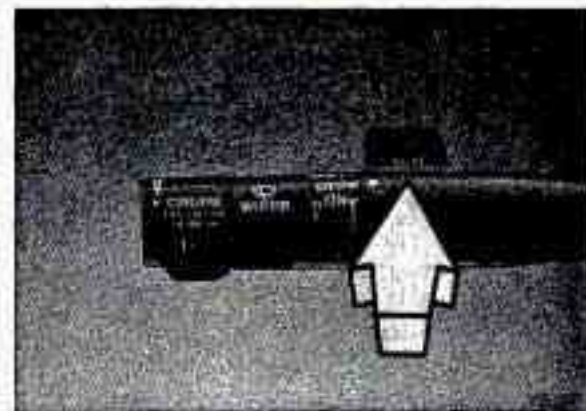

Windshield Washer

At the top of the turn signal/headlight beam lever there's a paddle with the word **PUSH** on it. To spray washer fluid on the windshield, just push the paddle for less than a second. The wipers will clear the window and stop.

If you hold the paddle in for more than one second, the washer will continue to spray until you release the paddle.

Features & Controls

Windshield Washer (CONT.)

CAUTION



- Driving without washer fluid can be dangerous. A bad mud splash can block your vision. You could hit another vehicle or go off the road. Check your washer fluid level often.
- In freezing weather, don't use your washer until the windshield is warmed. Otherwise the washer fluid can form ice on the windshield, blocking your vision.

NOTICE

- When using concentrated washer fluid, follow the manufacturer's instructions for adding water.
- Don't mix water with ready-to-use washer fluid. Water can cause the solution to freeze and damage your washer fluid tank and other parts of the washer system. Also, water doesn't clean as well as washer fluid.
- Fill your washer fluid tank only $\frac{3}{4}$ full when it's very cold. This allows for expansion, which could damage the tank if it is completely full.
- Don't use radiator antifreeze in your windshield washer. It can damage your washer system and paint.



■ Cruise Control

With cruise control, you can maintain a speed of about 25 mph (40 km/h) or more without keeping your foot on the accelerator. This can really help on long trips.

Cruise control does not work at speeds below about 25 mph (40 km/h).

When you apply your brakes or the clutch pedal, or when ASR is active, the cruise control shuts off. See the *Index* under *Acceleration Slip Regulation (ASR) System*.

CAUTION



- Cruise control can be dangerous where you can't drive safely at a steady speed. So, don't use your cruise control on winding roads or in heavy traffic.
- Cruise control can be dangerous on slippery roads. On such roads, fast changes in tire traction can cause needless wheel spinning, and you could lose control. Don't use cruise control on slippery roads.

To Set Cruise Control

1. Move the cruise control switch to **ON**.

CAUTION



If you leave your cruise control switch **ON** when you're not using cruise, you might hit a button and go into cruise when you don't want to. You could be startled and even lose control. Keep the cruise control switch **OFF** until you want to use it.



2. Get up to the speed you want.
3. Push in the **SET** button at the end of the lever and release it.
4. Take your foot off the accelerator pedal.

Features & Controls

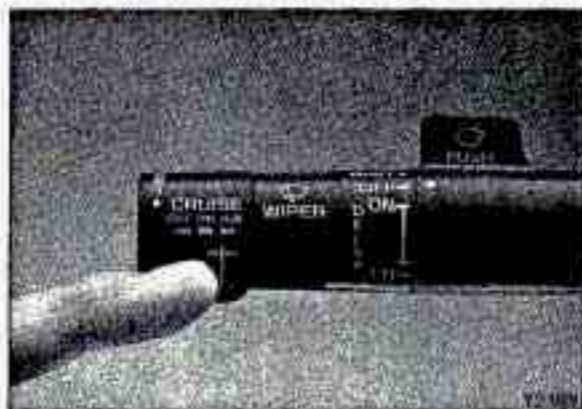

To Resume a Set Speed

Suppose you set your cruise control at a desired speed and then you apply the brake or clutch pedal. This, of course, shuts off the cruise control. But you don't need to reset it. Once you're going about 25 mph (40 km/h) or more, you can move the cruise control switch from **ON** to **R/A** (which stands for Resume/Accelerate) for about half a second.

You'll go right back up to your chosen speed and stay there.

CAUTION



If you hold the switch at **R/A** longer than half a second, the vehicle will keep going faster until you release the switch or apply the brake or clutch pedal. You could be startled and even lose control. So unless you want to go faster, don't hold the switch at **R/A**.

To Increase Speed While Using Cruise Control

There are two ways to go to a higher speed. Here's the first:

1. Use the accelerator pedal to get to the higher speed.
2. Push the **SET** button at the end of the lever, then release the button and the accelerator pedal.

You'll now cruise at the higher speed.

Here's the second way to go to a higher speed:

- Move the cruise switch from **ON** to **R/A**. Hold it there until you get up to the speed you want, and then release the switch.
- To increase your speed in very small amounts, move the switch to **R/A** for less than half a second and then release it. Each time you do this, your vehicle will go 1 mph (1.6 km/h) faster.

To Reduce Speed While Using Cruise Control

There are two ways to reduce your speed while using cruise control:

- Push in the button at the end of the lever until you reach the lower speed you want, then release it.
- To slow down in very small amounts, push the button for less than half a second. Each time you do this, you'll go 1 mph (1.6 km/h) slower.

Passing Another Vehicle While Using Cruise Control

Use the accelerator pedal to increase your speed. When you take your foot off the pedal, your vehicle will slow down to the cruise control speed you set earlier.

Features & Controls

Using Cruise Control on Hills

How well your cruise control will work on hills depends upon your speed, load, and the steepness of the hills. When going up steep hills, you may have to step on the accelerator pedal to maintain your speed. When going downhill, you may have to brake or shift to a lower gear to keep your speed down. Of course, applying the brake or clutch pedal takes you out of cruise control. Many drivers find this to be too much trouble and don't use cruise control on steep hills.

To Get Out of Cruise Control

There are several ways to turn off the cruise control:

- Step lightly on the brake pedal or push the clutch pedal, if you have a manual transmission; OR
- Move the cruise switch to **OFF**; OR
- When the ASR system is activated, it will turn off the cruise control. For information about the ASR system, see the *Index* under *Acceleration Slip Regulation (ASR) System*.

To Erase Cruise Speed Memory

When you turn off the cruise control or the ignition, your cruise control set speed memory is erased.



Acceleration Slip Regulation (ASR) System

Push this button to turn off the ASR system. When the ASR system is off, the **ASR OFF** light will illuminate on the Driver Information Center. Push it again to turn the system back on. When the ASR system is active, **ASR ACTIVE** will illuminate on the Driver Information Center. The ASR system comes on automatically each time you start your Corvette. See the *Index* under *Acceleration Slip Regulation (ASR) System*.



Headlights

Rotate the headlight knob to **P** to turn on:

- Parking Lights
- Side Marker Lights
- Taillights

To read your odometer and fuel level with the ignition off, turn on your parking lights.

To Turn the Lights Off: Rotate the headlight knob to **OFF**.



Rotate the headlight knob to **H** to turn on:

- Headlights
- Parking Lights
- Side Marker Lights
- Taillights

To Turn the Lights Off: Rotate the headlight knob to **OFF**.

Your digital display will dim sharply at dusk to remind you to turn on your headlights.

If you turn the ignition off and open the door when the lights are on, a warning chime will alert you to turn off the lights.

Features & Controls

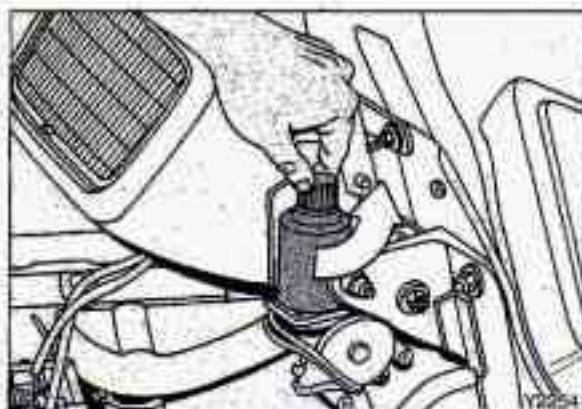

Operation of Lights

Although your vehicle's lighting system (headlamps, parking lamps, fog lamps, side marker lamps and taillamps) meets all applicable federal lighting requirements, certain states and provinces may apply their own lighting regulations that may require special attention before you operate these lamps. For example, some jurisdictions may require that you operate your lower beam lamps with fog lamps at all times, or that headlamps be turned on whenever you must use your windshield wipers. In addition, most jurisdictions prohibit driving solely with parking lamps, especially at dawn or dusk. It is recommended that you check with your own state or provincial highway authority for applicable lighting regulations.

Concealed Headlights

The headlights of your vehicle are concealed behind protective doors. The doors open when the headlights are turned on.

Do not force the doors open or closed. To open them manually, turn the manual knob on the inside of each headlight assembly counterclockwise until the doors are open.

Daytime Running Lights (CANADA ONLY)

The Canadian Federal Government has decided that Daytime Running Lights (DRL) are a useful feature, in that DRL can make your vehicle more visible to pedestrians and other drivers during daylight hours. DRL are required on new vehicles sold in Canada.

Your DRL work with a light sensor on top of the instrument panel. Don't cover it up.

Both front turn signal lights will come on in daylight when:

- The ignition is on
- The headlight switch is off, and
- The parking brake is released.

At dusk, the exterior lights will come on automatically and both front turn signal lights will go out. At dawn, the exterior lights will go out and both front turn signal lights will come on (if the headlight switch is off).

Of course, you may still turn on the headlights any time you need to.

To idle your vehicle with the DRL off, set the parking brake while the ignition is in the **Off** or **Lock** position. Then start the vehicle. The DRL will stay off until you release the parking brake.



Headlight High-Low Beam Changer

To change the headlights from low beam to high or high to low, pull the turn signal lever all the way toward you. Then release it.

When the high beams are on, a blue light on the instrument panel also will be on.



Instrument Panel Intensity Control

During daylight, the brightness of your instrument cluster lights will be maintained automatically. But when your headlights or parking lights are on, you can brighten or dim your instrument cluster lights by sliding the **DIMMER** control up or down. Slide the control all the way up to turn on the interior courtesy lights, reading and map lights, and cargo area lights. Slide the control down to dim the instrument cluster lights and displays.

To avoid draining your vehicle's battery, be sure to turn off all lights when leaving your vehicle.

Features & Controls



Fog Lights

Use your fog lights for better vision in foggy or misty conditions.

The fog light button is located under the headlight knob.

To turn the fog lights on, push the button. Press the button again to turn them off. An indicator light will glow above the button when the fog lights are on.

When using fog lights, the parking lights and/or low beam headlights must be on.

Fog lights will go off whenever the high beam headlights come on. When you turn the high beams off, the fog lights will come on again.

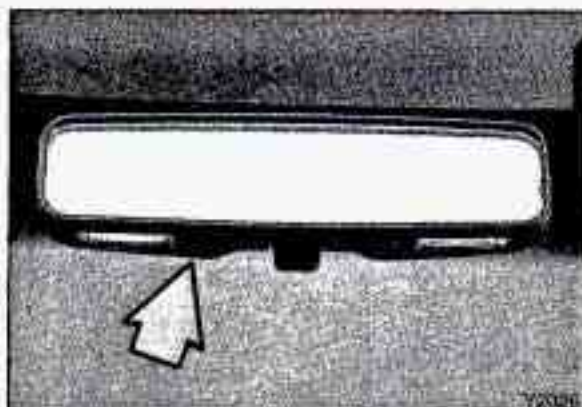

Reading Lights/Map Lights

These lights and the interior courtesy lights will come on when you open a door (unless it is bright outside). They will stay on for about 30 seconds and will turn off when you turn on the ignition.

To turn on the reading lights when the doors are closed and the ignition is on, press the switch back. Press it forward to turn the lights off.

To avoid draining your vehicle's battery, be sure to turn off all lights when leaving your vehicle.

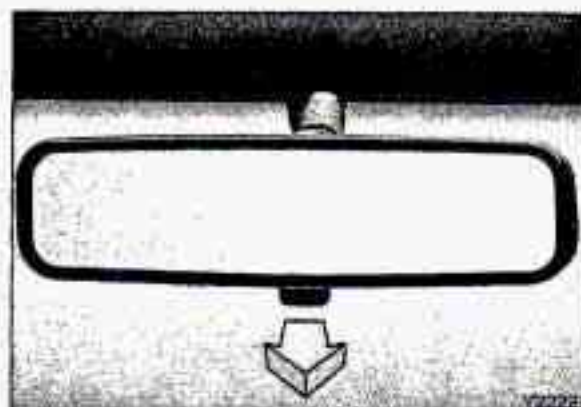

Inside Manual Day/Night Rearview Mirror

To reduce glare from lights behind you, move the lever toward you to the night position.



Convex Outside Mirror

Your right side mirror is convex. A convex mirror's surface is curved so you can see more from the driver's seat.

CAUTION

 If you aren't used to a convex mirror, you can hit another vehicle. A convex mirror can make things (like other vehicles) look farther away than they really are. If you cut too sharply into the right lane, you could hit a vehicle on your right. Check your inside mirror or glance over your shoulder before changing lanes.

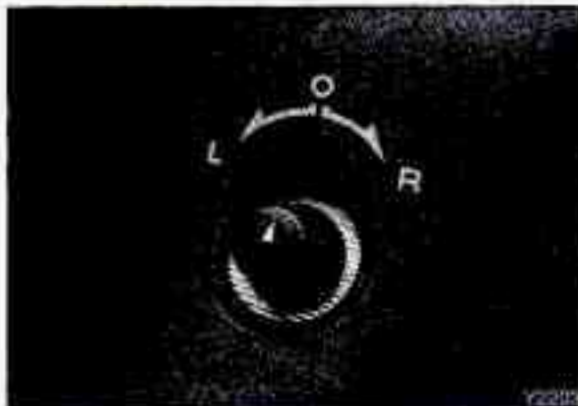

Power Remote Control Mirrors

The control on the driver's door armrest controls both outside rearview mirrors. Turn the knob to the left to select the driver's side rearview mirror, or to the right to select the passenger's side rearview mirror. To adjust each mirror so that you can just see the side of your vehicle when you are sitting in a comfortable driving position, move the knob left or right, up or down.

Turn the knob back to the center when your adjustments are complete.

When you operate the rear window defogger (coupe and hardtop convertible) or the power mirror defogger (convertible without hardtop), a defogger also warms both outside rearview mirrors.

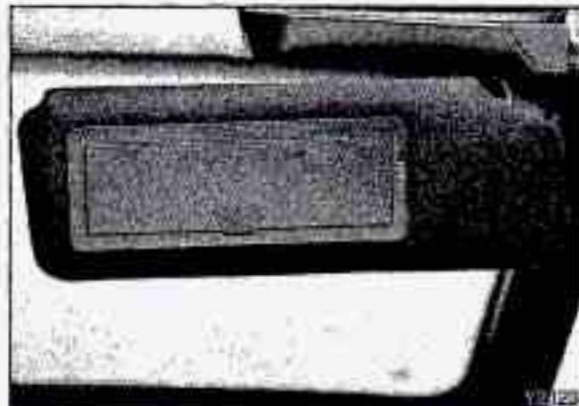

Sun Visors

To block out glare, you can swing down the visors.

Features & Controls

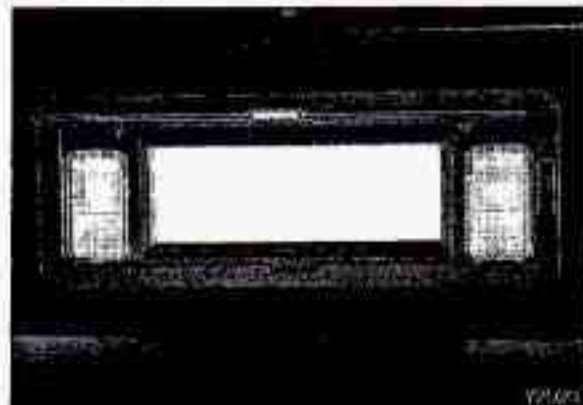

Visor Vanity Mirrors

Open the cover to expose the vanity mirror. When the ignition is on, move the switch on the side of the mirror to turn the lights on and off.

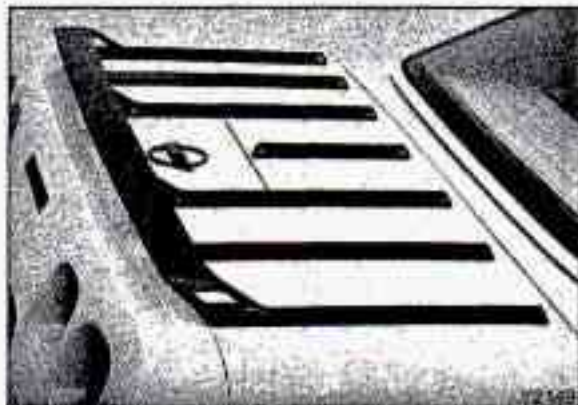

Luggage Carrier *(OPTION—CONVERTIBLE ONLY)*

If you have the optional luggage carrier, you can load things on the deck of your vehicle.

The luggage carrier has slats attached to the deck, a rear rail, and tiedowns.

NOTICE

Loading cargo that weighs more than 50 pounds (23 kg) on the luggage carrier may damage your vehicle. When you carry large things, never let them hang over the rear or the sides of your vehicle. Load your cargo so that it rests on the slats and does not scratch or damage the vehicle.

Put the cargo against the rear rail and fasten it securely to the luggage carrier.

Don't exceed the maximum vehicle capacity when loading your Corvette. For more information on vehicle capacity and loading, see the *Index* under *Loading Your Vehicle*.

To prevent damage or loss of cargo as you're driving, check now and then to make sure the luggage carrier and cargo are still securely fastened.



Center Storage Console

To open it, push the button on the front edge to the rear and lift the front edge.

Your wheel lock key, roof panel or hardtop wrench and special wheel nut socket are stored here.

You can use the door key to lock and unlock the center console. Remove the key immediately after use to prevent damage when the driver is seated.



Rear Storage Compartment

There is a special compartment in the floor behind the passenger seat for use in storing tools or valuables. To open it, push the button and lift the lid. You can use the door key to lock this compartment.

The top tray may be removed for more storage space.

Features & Controls

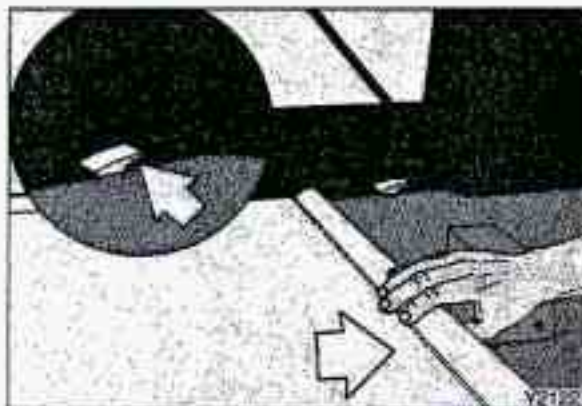

Rear Storage Compartment (CONT.)

NOTICE

Your Corvette's radio receiver box is located in the rear storage compartment. To help avoid damage to the receiver box, do not toss or place objects or destructive material in this storage area against the receiver box.

Also, to reduce the potential for radio receiver interference, do not connect or place any other electronic modules to or near the power source in this compartment.

Security Shade (COUPE ONLY)

To conceal items in the rear storage area, pull the shade forward and hook it into the notches in the rail behind the seats. To release the shade, pull it forward slightly and ease it back.

Ashtray/Cup Holder/Lighter

To clean the ashtray, open the door fully and lift out the ashtray by pulling on the snuffer.

To use the lighter, just push it in all the way and let go. When it's ready, it will pop back by itself.

NOTICE

Don't hold a cigarette lighter in with your hand while it is heating. If you do, it won't be able to back away from the electrical connection when it's ready. That can make it overheat, damaging the lighter and the heating element.

The ashtray can be removed and the space used as a second cup holder. Be sure to place the ashtray only in the rear opening.

NOTICE

Don't put papers and other things that burn into your ashtrays. If you do, cigarettes or other smoking materials could set them on fire, causing damage.

NOTICE

Loose objects (such as paper clips) can lodge behind and beneath the ashtray lid and prevent movement of the lid. Avoid putting small loose objects near the ashtray.

Features & Controls

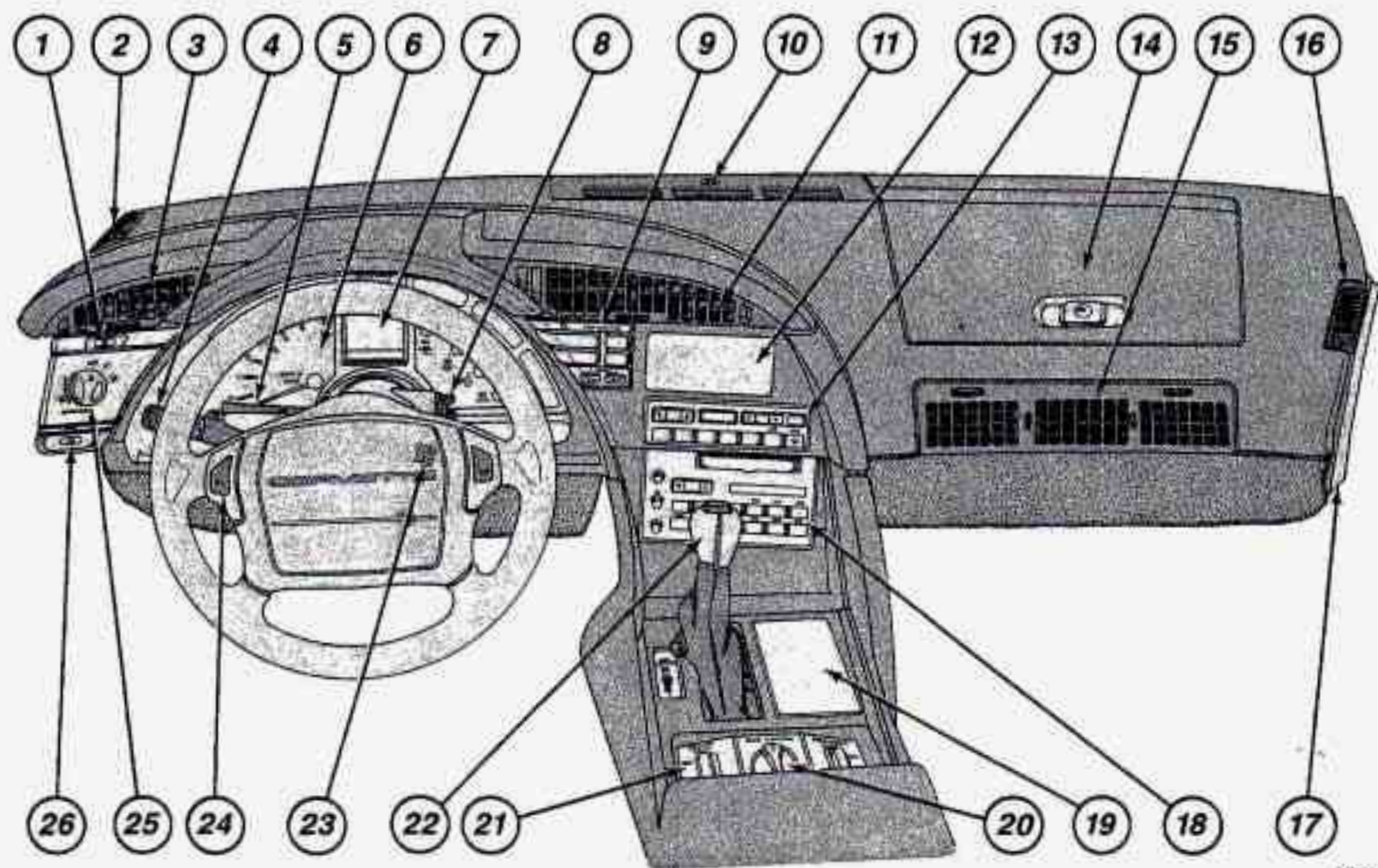

The Instrument Panel— Your Information System

Your instrument panel is designed to let you know at a glance how your vehicle is running. You'll know how fast you're going, how much fuel you're using, and many other things you'll need to drive safely and economically.

The main components of your instrument panel are:

1. Acceleration Slip Regulation Switch (ASR)
2. Side Window Defogging Vents
3. Side Vents
4. Turn Signal/Headlight Beam Lever
5. Tilt Steering Wheel Lever
6. Instrument Cluster
7. Fuel Gage
8. Ignition Switch
9. Trip Monitor Controls
10. Solar Sensor
11. Center Vents
12. Driver Information Center
13. Climate Controls and Rear Window Defogger
14. Glove Box
15. Side Vents
16. Side Window Defogging Vents
17. Fuse Panel
18. Audio System
19. Ashtray/Lighter/Cup Holder
20. Selective Ride Control (Option)
21. Power Seat Controls (Option)
22. Gear Shift Lever
23. Hazard Warning Flashers Switch
24. Horn
25. Light Controls
26. Fog Lights Switch

Features & Controls

LT1 Cluster



■ Instrument Panel Clusters

Your Corvette is equipped with one of these instrument panel clusters, which include indicator warning lights and gages that are explained on the following pages. Be sure to read about those that apply to the instrument panel cluster for your vehicle.

Tamper-Resistant Odometer

Your Corvette has a tamper-resistant odometer. It will read **ODO ERR** if someone has tampered with it.

Speedometer

Press the **ENG MET** (English/Metric) button on the Trip Monitor to switch the display between miles per hour (mph) and kilometers per hour (km/h).

LT5 Cluster

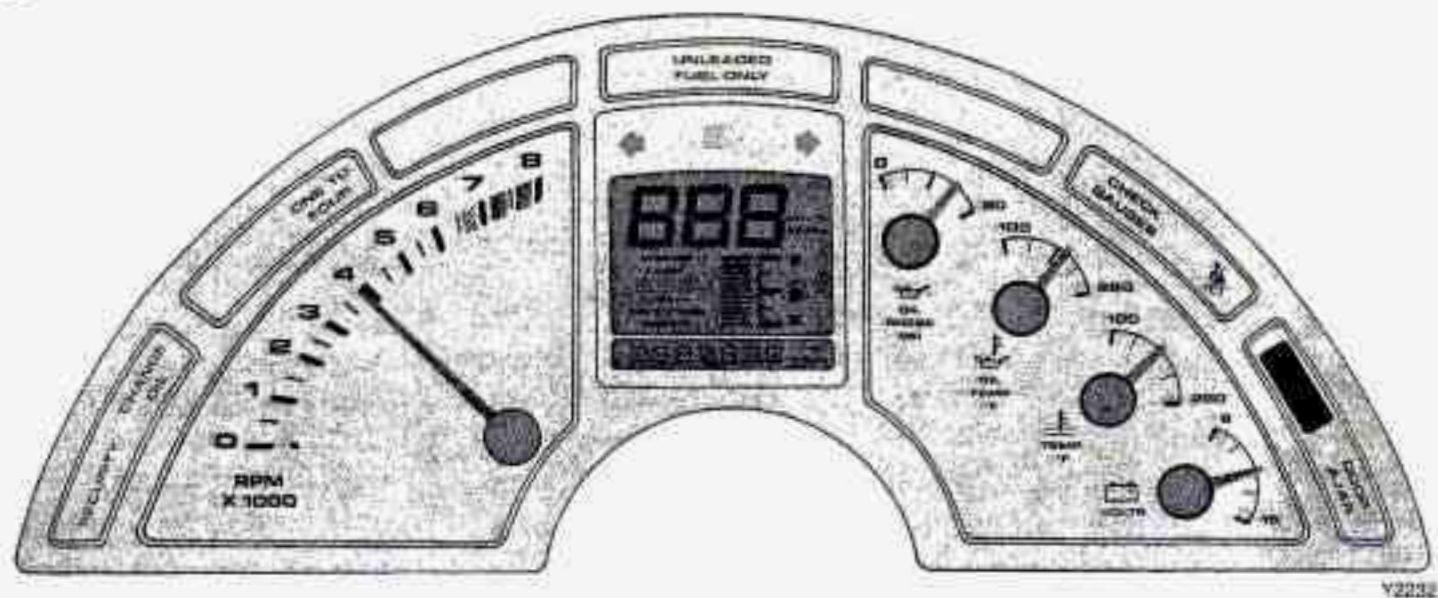

Tachometer

The tachometer displays the engine speed in revolutions per minute (rpm).

For the LT5 engine, the fuel will shut off at 7200 rpm.

For the LT1 engine, the fuel will shut off at 5850 rpm.

NOTICE

Do not operate the engine with the tachometer in the shaded area, or engine damage may occur.

Features & Controls

■ *Warning Lights, Gages and Indicators*

This section describes the warning lights and gages that are on your vehicle. The pictures will help you locate them.

Warning lights and gages can signal that something is wrong before it becomes serious enough to cause an expensive repair or replacement. Paying attention to your warning lights and gages could also save you or others from injury.

Warning lights go on when there may be or is a problem with one of your vehicle's functions. As you will see in the details on the next few pages, some warning lights come on briefly when you turn the ignition key just to let you know they're working. If you are familiar with this section, you should not be alarmed when this happens.

Gages can indicate when there may be or is a problem with one of your vehicle's functions. Often gages and warning lights work together to let you know when there's a problem with your vehicle.

When one of the warning lights comes on and stays on when you are driving, or when one of the gages shows there may be a problem, check the section that tells you what to do about it. Please follow the manual's advice. Waiting to do repairs can be costly—and even dangerous. So please get to know your warning lights and gages. They're a big help.

Your vehicle also has a Driver Information Center that works along with the warning lights and gages. See the *Index* under *Driver Information Center*.

Gage Markings

The analog gages provide a quick visual reference to the actual measurements of these gages. However, they are non-linear, which means that the middle hash marks on the analog gages do not represent median measurements for these gages.

For accurate gage measurements refer to the **GAUGES** button on the Trip Monitor (see the *Index* under *Trip Monitor*).



Fuel Gage

Your fuel gage bars light up when the ignition is on, or if the ignition is off, when you turn on your parking lights, to show you about how much fuel you have left.

When the normal display is down to the last two bars, the message **RESERVE** will appear on the left of the gage.

Here are three things that some owners ask about. None of these show a problem with your fuel gage:

- At the gas station, the gas pump shuts off before the gage reads **F** (Full).
- It takes a little more or less fuel to fill up than the gage indicated. For example, the gage may have indicated the tank was half full, but it actually took a little more or less than half the tank's capacity to fill the tank.
- The gage moves a little when you turn a corner or speed up.

For your fuel tank capacity, see *Service Station Information* on the last page of this manual.

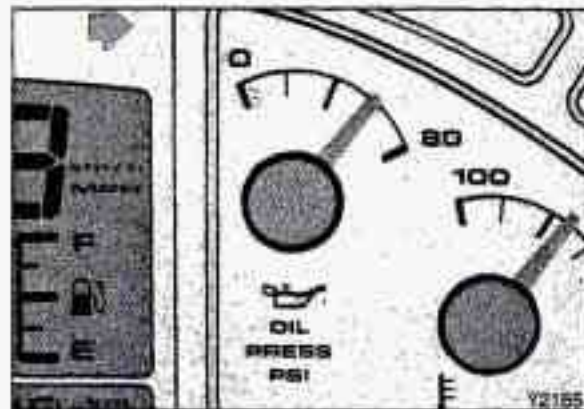

Engine Oil Pressure Gage

Your oil pressure gage shows the oil pressure in psi (pounds per square inch) or kPa (kilopascals) when the engine is running. Oil pressure may vary with engine speed, outside temperature and oil viscosity. In fact, while the engine is warming up, the oil pressure will be higher than at the normal operating temperature. Readings above the shaded area indicate the normal operating range.

If the gage reads in the shaded area when you're idling and stays there, oil isn't running through your engine properly.

Features & Controls

Engine Oil Pressure Gage (CONT.)

Driving your vehicle with low oil pressure can cause extensive engine damage.

CAUTION



Don't keep driving if the oil pressure is low. If you do, your engine can become so hot that it catches fire. You or others could be burned. Check your oil as soon as possible and have your vehicle serviced.

NOTICE

Damage to your engine from neglected oil problems can be costly and is not covered by your warranty.

Engine Oil Temperature Gage

This gage shows your oil temperature in degrees Fahrenheit.

It's normal for the oil temperature to vary, depending on the type of driving you do and the weather conditions. If you drive for a long time, such as on a trip, the gage will show a higher reading than if you had driven for only a short time. And if it's hot outside, the reading will be higher than if it were cold outside.

If your oil temperature approaches the shaded area and stays there for some time, your oil temperature is too high. Check the engine oil level and bring your vehicle in for service. You should also check the engine coolant temperature. If your engine is too hot, see the *Index* under *Engine Cooling System*.

For accurate gage measurements refer to the **GAUGES** button on the Trip Monitor (see the *Index* under *Trip Monitor*).

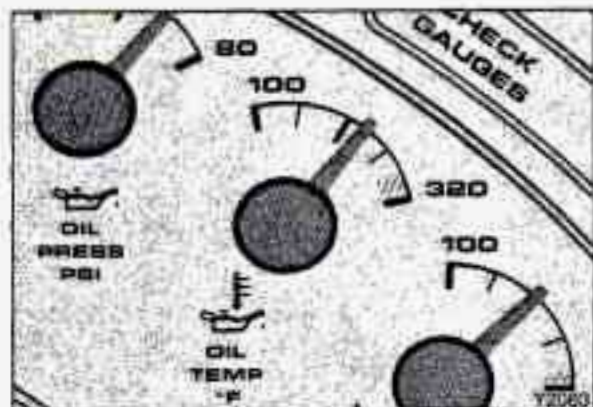

LT1 Engine: Engine Oil Temperature Gage

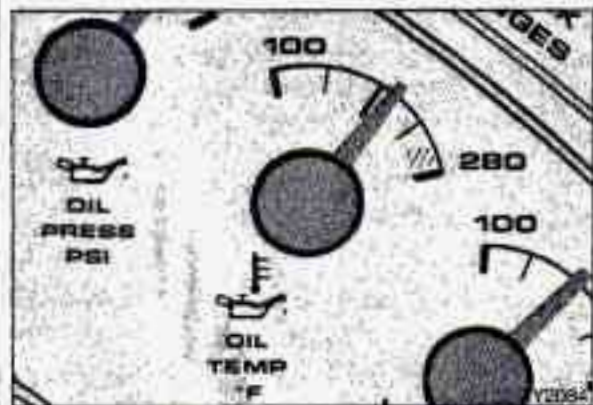

LT5 Engine: Engine Oil Temperature Gage

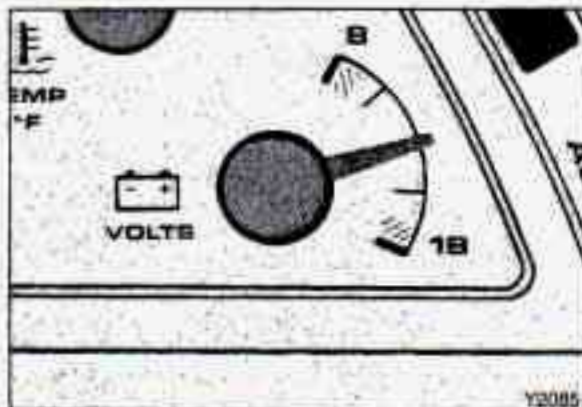

Voltmeter

Your charging system gage will show the rate of charge when the engine is running. (When the engine is not running, the display measures the voltage output of your battery.)

The reading will change as the rate of charge changes (with engine speed, etc.), but readings between the shaded areas indicate the normal operating range. Readings in either shaded area indicate a possible problem with your charging system. The **CHECK GAUGES** light will come on during both high and low battery voltages. See your dealer to have your system serviced immediately.

For accurate gage measurements refer to the **GAUGES** button on the Trip Monitor (see the *Index* under *Trip Monitor*).

Features & Controls

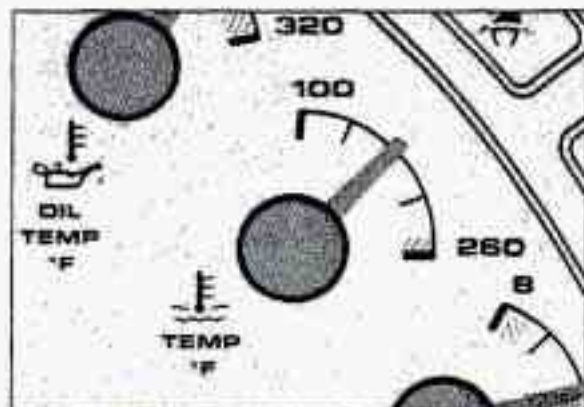

Engine Coolant Temperature Gage

This gage shows the engine coolant temperature.

If the gage pointer moves into the shaded area, your engine is too hot! It means that your engine coolant has overheated. If you have been operating your vehicle under normal driving conditions, you should pull off the road, stop your vehicle and turn off the engine as soon as possible.



HOT COOLANT CAN BURN YOU BADLY!

In *Problems on the Road*, the manual shows what to do. See the *Index* under *Engine Overheating*.

For accurate gage measurements refer to the **GAUGES** button on the Trip Monitor (see *Trip Monitor* later in this section).

If the **LOW COOLANT** light, located on the Driver Information Center, comes on, your system is low on coolant and your engine may overheat.

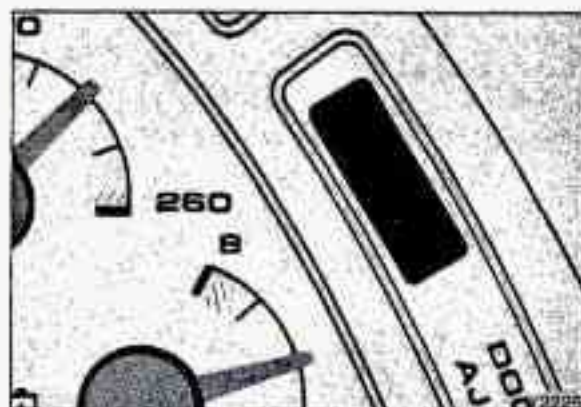

Brake System Warning Light

Your Corvette's hydraulic brake system is divided into two parts. If one part isn't working, the other part can still work and stop you. For good braking, though, you need both parts working well.

If the warning light goes on, there could be a brake problem. Have your brake system inspected right away.

This light should come on as you start the vehicle. If it doesn't come on then, have it fixed so it will be ready to warn you if there's a problem.

This light will also come on when you set your parking brake, and will stay on if your parking brake doesn't release fully. If it stays on after your parking brake is fully released, it means you have a brake problem.

If the light comes on while driving, pull off the road and stop carefully. You may notice that the pedal is harder to push. Or, the pedal may go closer to the floor. It may take longer to stop. If the light is still on, have the vehicle towed for service. (See the *Index* under *Towing Your Corvette*.)

When your anti-lock system is working, the **ABS ACTIVE** light will come on. This means that slippery road conditions may exist. Adjust your driving accordingly. See the *Index* under *ABS Active Light*.

If the brake light, **SERVICE ASR** light and **SERVICE ABS** light come on at the same time, you may have low brake fluid. See the *Index* under *Brake Master Cylinder*.

CAUTION

 Your brake system may not be working properly if the brake warning light is on. Driving with the brake warning light on can lead to an accident. If the light is still on after you've pulled off the road and stopped carefully, have the vehicle towed for service.

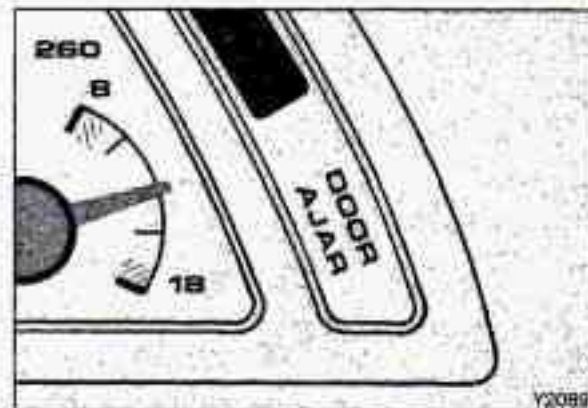

Door Ajar Light

This light tells you that one of the doors isn't fully closed. Have your Corvette serviced if this light comes on and stays on when your doors are closed.

DOOR AJAR Reminder

If a door is not fully closed when the ignition key is in the **Run** position, the information center in the instrument cluster will display **DOOR AJAR**.

If the key is in the **Lock** position and the driver's door is ajar, a chime will sound also. Your vehicle has a theft deterrent system. See the *Index* under *Universal Theft Deterrent*.

Features & Controls

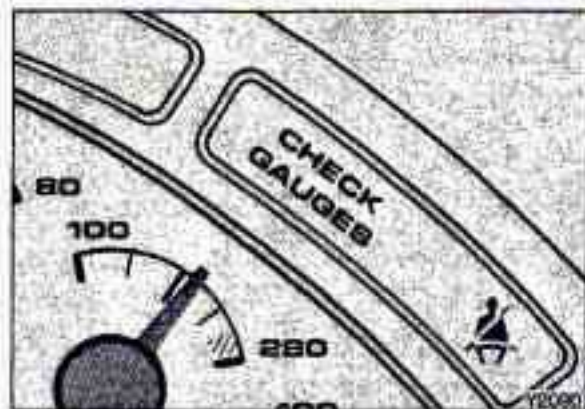

Check Gauges Light

This light will come on briefly when you are starting the engine. If the light comes on and stays on while you are driving, check your various gauges to see if they are in the warning zones.

If this light comes on and stays on with the engine running, this indicates one of the following conditions:

- high oil temperature
- high coolant temperature
- high battery voltage
- low battery voltage
- low oil pressure
- or low fuel level (zero bars showing).

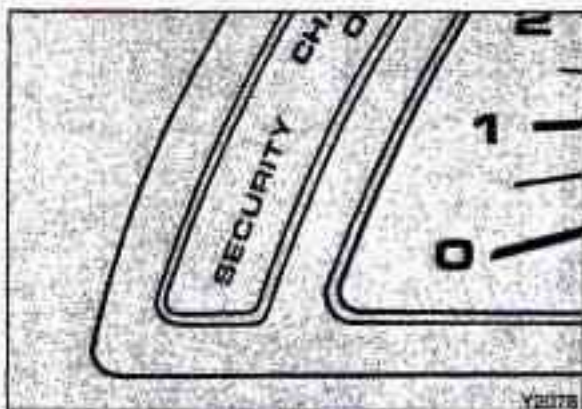

Security Light

The **SECURITY** light reminds you to arm your theft deterrent system by flashing when the ignition is in **Lock** and the doors are opened. It keeps flashing until you arm the theft deterrent system by locking the doors using the power door lock button or the Passive Keyless Entry system.

Once the system is armed, the light stops flashing and remains lit. When the last door is shut, the light will stay on for two seconds and then go out. It will also remain lit if the hatch is left open but the theft deterrent system is still armed.

If you close the doors and the hatch without arming the system, the **SECURITY** light goes out immediately. When you re-enter the vehicle, the light will flash until you close the door or the hatch, or turn the ignition on. See the *Index* under *PASS-Key™* and *Universal Theft Deterrent*.

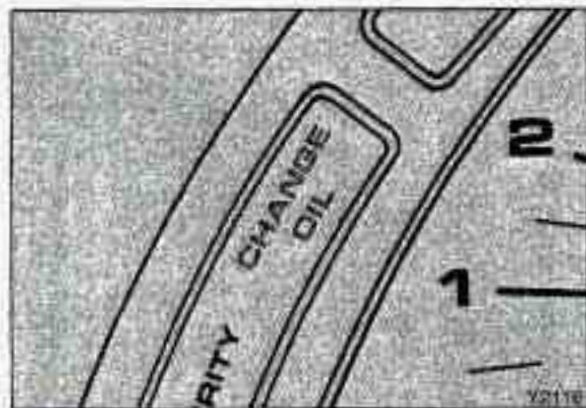

Engine Oil Life Monitor

The Engine Oil Life Monitor uses engine oil temperature and engine revolutions to determine when the oil is nearly worn out.

There is a **CHANGE OIL** light on the left side of the instrument cluster. It comes on for a few seconds as a bulb check when you start your vehicle. It comes on and stays on when it is time to change your oil.

The **CHANGE OIL** light is only a reminder. You should change your oil at the intervals recommended in your Maintenance Schedule even if the **CHANGE OIL** light hasn't come on.

NOTICE

When your oil is changed, be sure that the Engine Oil Life Monitor is reset before you drive your vehicle. Reset it whether the **CHANGE OIL** light came on or not. The Engine Oil Life Monitor will not work correctly unless it is reset when the oil is changed.

Resetting the Engine Oil Life Monitor:

1. Turn the key to the **Run** position, but don't start the engine.
2. Press the **ENG MET** button on the Trip Monitor. Within five seconds, press the **ENG MET** button again.
3. Within five seconds of step 2, press and hold the **GAUGES** button on the Trip Monitor. The **CHANGE OIL** light will flash.
4. Hold the **GAUGES** button until the **CHANGE OIL** light stops flashing and goes out. This should take about ten seconds. When the light goes out, the Engine Oil Life Monitor is reset. If it doesn't reset, turn the ignition to **Off** and repeat the procedure.

Features & Controls



■ Trip Monitor

The Trip Monitor allows control of the display in the center of your instrument panel and provides useful travel information on:

- Fuel Economy
- Fuel Range
- Distance Traveled
- Gages

Control Buttons

There are six control buttons on the Trip Monitor. The buttons and the information they display are:

FUEL INFO: Each time this button is pressed the:

- instantaneous fuel economy
- average fuel economy
- or fuel range

will be displayed. Pressing the button a fourth time will blank the display.

The **FUEL INFO** button displays instantaneous fuel economy and average fuel economy calculated for your specific driving conditions. Press **FUEL INFO** to display instantaneous fuel economy, such as:

28 INST. MPG or
8.4 INST. L/100 KM

Press **FUEL INFO** again to display average fuel economy, such as:

25.2 AVERAGE MPG or
9.3 AVERAGE L/100 KM

Press again to return to fuel range information.

Fuel range is the remaining distance you can drive without refueling. It's based on fuel economy and the fuel remaining in the tank, such as:

RANGE 235 or
RANGE 378

FUEL RESET: This button resets the system in order to accurately compute your fuel economy and range. Press **FUEL** after refueling.

TRIP ODO: Press this button to change the odometer reading to a trip odometer reading. Press again to return the display to the odometer reading. The trip odometer can be useful to measure the actual distance you travel on a trip. To set it to zero, see **TRIP RESET** below. The odometer will illuminate with the ignition off and the parking lights on.

TRIP RESET: With **TRIP ODO** selected for display, press and hold the **TRIP** button for two seconds to change the trip odometer reading to zero.

ENG MET: This button changes the display from customary United States measures (English) to Canadian measures (metric).



Oil Temperature Display

GAUGES: Each time this button is pressed the:

- oil temperature
 - coolant temperature
 - or battery voltage
- will be digitally displayed.

The display will change to:

HI OIL
HI COOL
HI VOLT
or LO VOLT,

if conditions in the corresponding gages read higher or lower than normal.

If the oil and coolant temperatures are below 32°F (0°C), the trip monitor will display **LO** when the actual gage temperature is displayed.

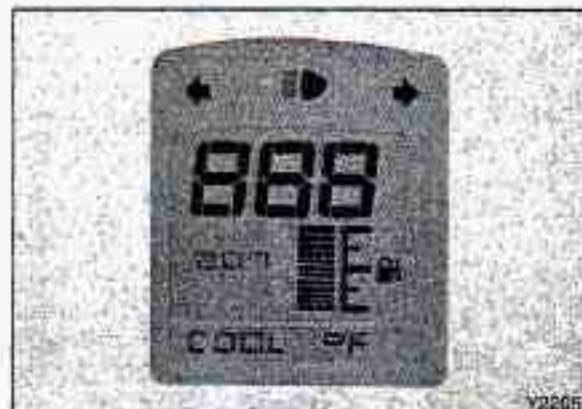

Coolant Temperature Display



Battery Voltage Display

Features & Controls

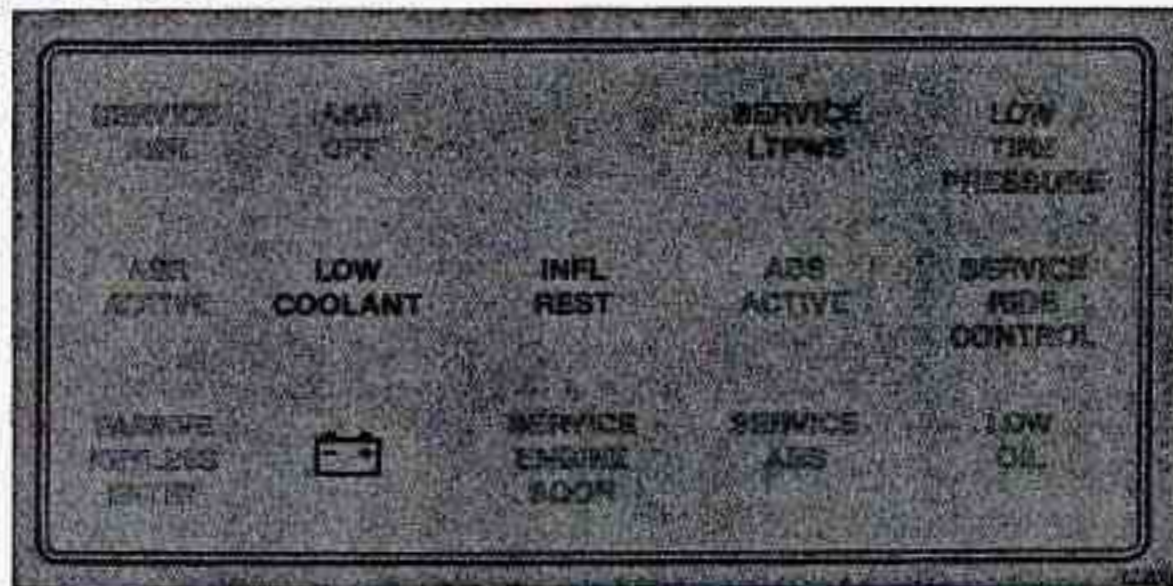

Low Coolant Warning Light

If this light comes on, your system is low on coolant and the engine may overheat. See the *Index* under *Engine Coolant* and have your vehicle serviced as soon as you can.

■ Driver Information Center

The Driver Information Center (DIC) gives you important safety and maintenance facts. It will display warning lights for the following:

- **LOW COOLANT**
- **LOW TIRE PRESSURE** [Option]
- **SERVICE LTPWS** (Low Tire Pressure Warning System) [Option]
- **INFL REST** (Inflatable Restraint)
-  (Charging System)
- **SERVICE ABS** (Anti-Lock Brake System)
- **SERVICE ENGINE SOON**
- **SERVICE RIDE CONTROL** [Option]
- **LOW OIL**
- **ABS ACTIVE**
- **SERVICE ASR** (Acceleration Slip Regulation)
- **ASR ACTIVE**
- **ASR OFF**
- **PASSIVE KEYLESS ENTRY**



Low Tire Pressure Warning Light (OPTION)

The LTPWS has a sensor on each road wheel that transmits to a receiver on the instrument panel. The system operates on a radio frequency subject to Federal Communications Commission (FCC) Rules.

This device complies with Part 15 of the FCC Rules. Operation is subject to the following two conditions: (1) This device may not cause harmful interference, and (2) This device must accept any interference received, including interference that may cause undesired operation.

Changes or modifications to this system by other than an authorized service

facility could void authorization to use this equipment.

The Low Tire Pressure Warning System (LTPWS) monitors the air pressure in each road tire (except the spare tire) **while the car is being driven**. The LTPWS will not warn the driver if a tire is already flat before the vehicle is started. This light comes on whenever a tire pressure goes below 25 psi (175 kPa) in any road tire while your Corvette is being driven. You must drive the car faster than 25 mph (40 km/h) and for more than 2 miles (4 km) for the system to work properly. The Low Tire Pressure Warning Light also warns you if any of the system's components are not working properly. The **LOW TIRE PRESSURE** light will remain on until the ignition is turned off. This will also reset the system.

When the **LOW TIRE PRESSURE** light comes on, check the tire pressure in all four road tires as soon as you can, using the tire pressure gage provided in the center console. Adjust the tire pressure as needed to those shown on the Tire-Loading Information label located on the driver's door. The **LOW TIRE PRESSURE** light may come on if your vehicle is close to another vehicle that has a Low Tire Pressure Warning System and has a tire with low pressure.

The LTPWS sensor is directly opposite the valve stem on the tire. Take extreme care when servicing or having your tires serviced. The sensors may not work properly if damaged.

If you need to take the tire off the wheel, do it at a 90° angle from the valve stem. Removing the tire from the wheel at any

Features & Controls

Low Tire Pressure Warning Light (CONT.)

point more than 90° from the valve stem may damage the LTPWS sensors.

If this light stays on after the tire pressure is properly adjusted, see your dealer.

NOTICE

Driving with a flat tire may damage the tire, the wheel, or the tire pressure sensor installed inside the tire on the wheel rim.

The use of tire sealants may damage the tire pressure sensor.

When you install a spare tire on your Corvette, the **LOW TIRE PRESSURE** light could come on and the **SERVICE LTPWS** light will come on.



Service LTPWS Light (OPTION)

The **SERVICE LTPWS** light comes on whenever a Low Tire Pressure Warning System component is not working properly. It may also come on during low speed (less than 25 mph, 40 km/h) or stop-and-go driving, even though tire pressure is above 25 psi (175 kPa) in each tire. This light turns off when the electronic receiver gets a coded signal from each sensor.

Check the system by turning the ignition off, then on again. If the system is working, the light should come on and then go out. See your dealer if the light remains on or doesn't come on at all.

If your vehicle is operated for three consecutive half-hour time periods without being moved, the **SERVICE**

LTPWS light will come on. Each time the vehicle is started thereafter, the light will come on and stay on until the vehicle is moved. When the vehicle is moved, the **SERVICE LTPWS** light will go out. **This is a normal condition**, and does not indicate anything wrong with the system. (If you would like to permanently clear the **SERVICE LTPWS** light from your Driver Information Center, see your dealer for assistance.)

The **SERVICE LTPWS** light will also come on if the vehicle is operated for three consecutive half-hour periods when **all four** tires have been replaced with snow tires or aftermarket tires, or if **all four** LTPWS sensors are damaged or missing. The **SERVICE LTPWS** light will stay on until the system receives a sensor signal. If the light comes on and stays on even when the vehicle is driven, this may indicate a problem. See your dealer for assistance.

To prevent damage to the sensor, follow the instructions for mounting and dismounting tires in the 1993 Corvette Service Manual.

LTPWS can warn you of a low tire situation or a system problem, but it does not substitute for normal tire maintenance. See the *Index* under *Tires*.



Inflatable Restraint Light

The **INFL REST** (Inflatable Restraint) light is part of the Supplemental Inflatable Restraint system on your vehicle. This light will flash seven to nine times when you turn the ignition key to **Run**. If this light comes on when you are driving, fails to glow when you turn the key to **Run**, or stays on after turning the key to **Run**, there may be a problem with the system.

ASR System Warning and Indicator Lights

The following three lights on your Driver Information Center tell you about your ASR (Acceleration Slip Regulation).

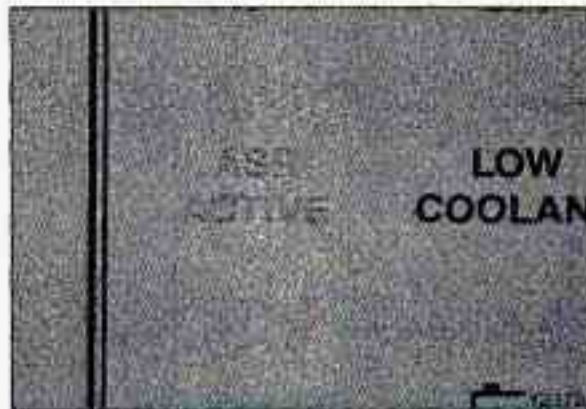

ASR Active Light

This indicator on the Driver Information Center will come on when you turn the ignition on and remain on for a few seconds during a system check. It also indicates when the ASR system has been activated. See the *Index* under *Acceleration Slip Regulation (ASR) System*.

Features & Controls

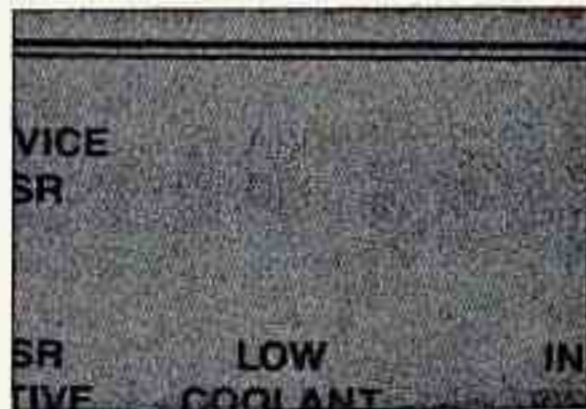

ASR Off Light

This indicator will come on when you turn the ignition on and remain on for a few seconds during a system check. It also comes on and stays on when the ASR button is pressed to turn the system off. See the *Index* under *Acceleration Slip Regulation (ASR) System*.

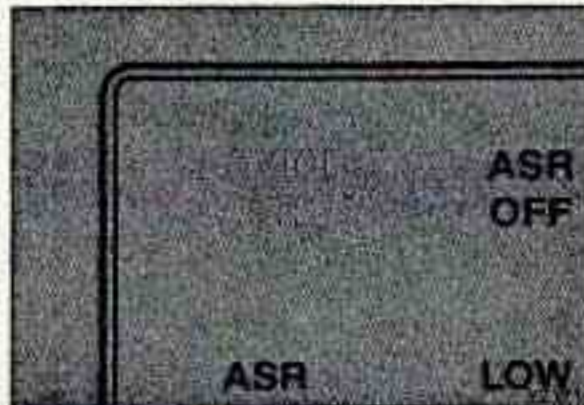

Service ASR Light

This indicator will come on when you turn the ignition on and remain on for a few seconds during a system check. If it stays on, this may indicate a problem with the ASR system. See your dealer for service.

CAUTION



If you let your tires spin at high speed when the **ASR OFF** light is on, or when the **SERVICE ASR** light is on, your tires can explode and you or others could be injured. And, spinning your tires with either of these lights on can cause the automatic transmission to overheat or can cause other problems. That could cause an engine fire or other damage. When you're stuck, spin the wheels as little as possible. If your vehicle is stuck, don't spin the wheels above 35 mph (56 km/h) as shown on the speedometer.

NOTICE

Spinning your wheels with the **ASR OFF** light on, or with the **SERVICE ASR** light on, can destroy parts of your vehicle as well as the tires. If you spin your wheels too fast while shifting your transmission back and forth, you can destroy your transmission. When you're stuck, spin the wheels as little as possible.



ABS Active Light

This light comes on when the anti-lock brake system is engaged to prevent wheel lock when braking. You may hear or feel the anti-lock system running through a diagnostic test. This light will also come on as a test for about two seconds when the engine is started.

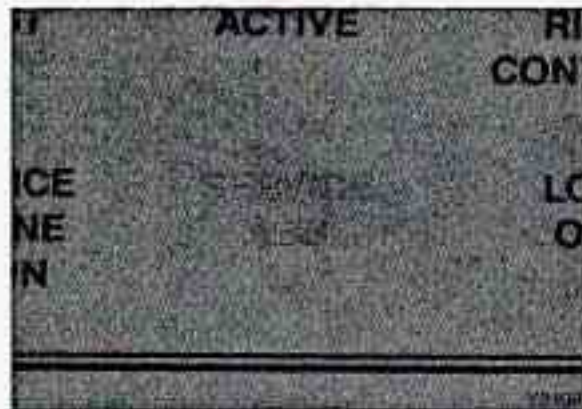

Service ABS Light

This light will come on as a test for about two seconds when the engine is started.

If it stays on, or comes on while you are driving, carefully stop your vehicle as soon as you can and turn the ignition off. Then start the engine to restart the system. If the **SERVICE ABS** light stays on, or it comes on again while you are driving, the anti-lock system needs service. Unless the **BRAKE** warning light is also on, you will still have brakes, but not ABS.

See the *Index* under *How the Anti-Lock System Works*.

Features & Controls

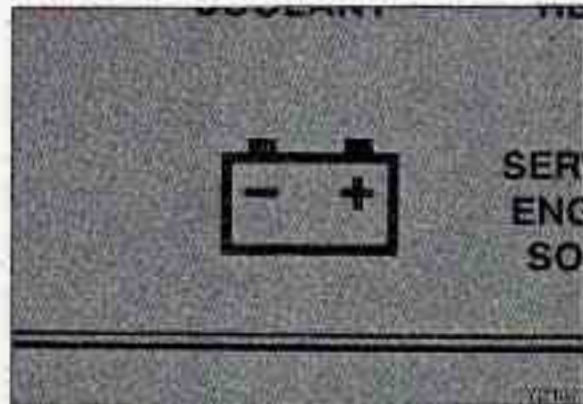

Charging System Light

The charging system light will come on when you turn on the ignition, but the engine is not running, as a check to show you it is working. Then it should go out. If it stays on when the engine is running, or comes on while you are driving, you may have a problem with the electrical charging system. It could indicate that you have a loose or broken drive belt or another electrical problem. Have it checked right away. Driving while this light is on could drain your battery.

If you must drive a short distance with the light on, be certain to turn off all your accessories, such as the radio and air conditioner.



Low Oil Light

This light will come on for a few seconds when you start your vehicle and will stay on if your oil is $\frac{1}{2}$ to $1\frac{1}{2}$ quarts low (with the vehicle nearly level). See the *Index* under *Engine Oil*.

For the LT5 Engine Only: If this light comes on, and you need to verify the oil level, let your vehicle sit for approximately two hours with the engine off before checking the oil. See the *Index* under *Checking Engine Oil Level* for the proper procedure.

You should check your oil level regularly. This light is an added reminder.

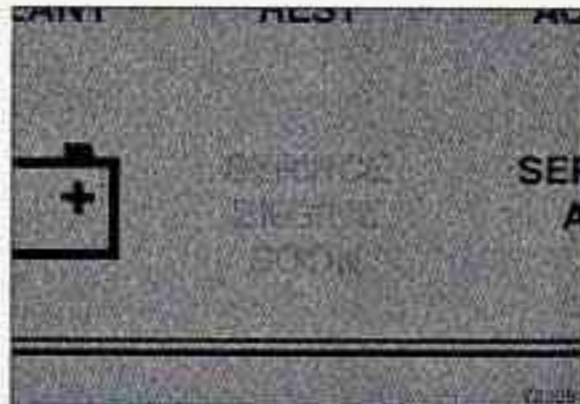

Malfunction Indicator Lamp (Service Engine Soon Light)

*A computer monitors operation of your fuel, ignition and emission control systems. This light should come on when the ignition is on, but the engine is not running, as a check to show you it is working. If it does not come on at all, have it fixed right away. If it stays on, or it comes on while you are driving, the computer is indicating that you have a problem. You should take your vehicle in for service soon.

NOTICE

If you keep driving your vehicle with this light on, after a while the emission controls won't work as well, your fuel economy won't be as good, and your engine may not run as smoothly. This could lead to costly repairs not covered by your warranty.

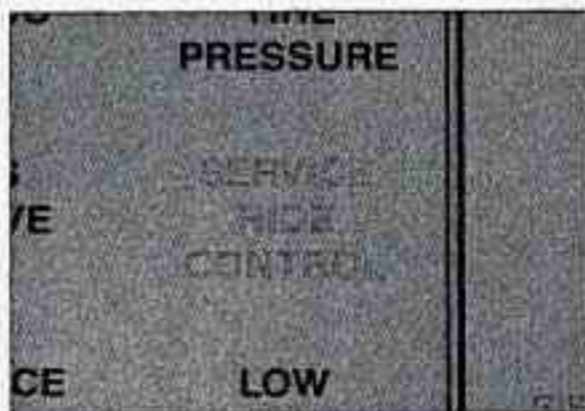

Service Ride Control Light (OPTION)

This light monitors the Selective Ride Control system. When you start the vehicle, this light should come on for a few seconds to let you know it's working. If it doesn't come on, see your dealer.

If the light stays on when you move the vehicle or comes on while you're driving, there is a problem with the system. You can still drive your Corvette, but have your dealer check the Selective Ride Control system as soon as you can.

The Selective Ride Control system is designed to sense vehicle speed in the first minute after the vehicle is started. If the vehicle has not been moved in the first minute, the Selective Ride Control system will interpret this as a vehicle speed fault. After three consecutive vehicle speed faults, the **SERVICE RIDE CONTROL** light will turn on. Once the vehicle is moved, the **SERVICE RIDE CONTROL** light will go out.

Features & Controls

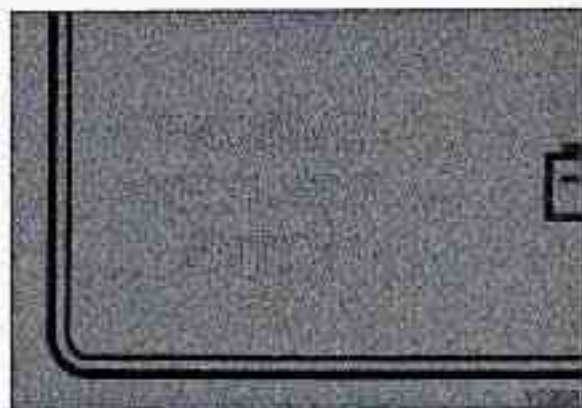

Passive Keyless Entry Light

If the Passive Keyless Entry system is on, this light comes on for two seconds when you put the key in the ignition and turn it to the **Run** position. If the Passive Keyless Entry system is off, the light will not come on. This light also comes on and flashes when you are programming one or more transmitters. See the *Index* under *Passive Keyless Entry System*.

System Problems

The Central Control Module (CCM) controls several electronic systems on your Corvette. **SYS** will flash three times every 15 seconds on the display near the fuel gage if there is a problem with one of the CCM-controlled systems. Have your vehicle checked by a Chevrolet dealer if **SYS** keeps appearing.

If the **SECURITY** light flashes at the same time **SYS** flashes on the instrument panel, a problem has been detected in your theft deterrent system. If this occurs, have your vehicle serviced.

Roof Panel (COUPE)

Removing the Roof Panel:

1. Be sure your vehicle is on a level place.
2. Set the parking brake.
3. Shift your automatic transmission into **P** (Park). Or, if you have the manual transmission, shift it into **R** (Reverse).
4. Lower the side windows all the way down.
5. Turn your ignition key to the **Lock** position.
6. Move both sun visors to the side to uncover the front bolt access holes.



7. Remove the ratchet wrench from the center console storage compartment.

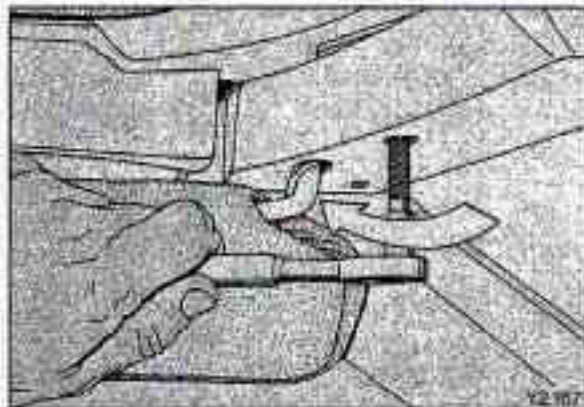

8. Use the wrench to **loosen** the two front attaching bolts. Don't remove them. They'll stay in place when they're loose.
9. The two rear attaching bolts are on the roof, one above each seat. Use the wrench to loosen these two bolts until the roof panel is free. The rear bolts are designed to stay securely in the roof panel. This prevents rattling when the roof panel is stored.
10. To store your roof panel, open the rear hatch lid. Look for the two storage brackets in the rear area, one below each courtesy light.

CAUTION



If the roof panel is not stored properly in the rear area, it could be thrown about the vehicle in a crash or sudden maneuver and injure people in the vehicle.

Whenever you store the roof panel in the vehicle, always be sure that it is stored securely in the rear area using the storage brackets and latch pin.

11. Use assistance when removing the roof panel until you are sure you can do it alone. Stand on either side of the vehicle. First, lift the front of the roof panel up. Then move it forward as you lift it off the vehicle.

Features & Controls

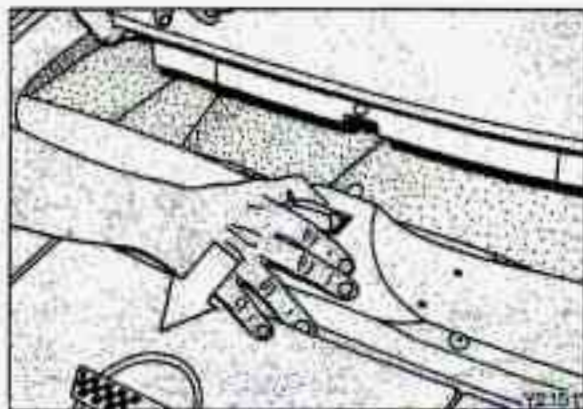
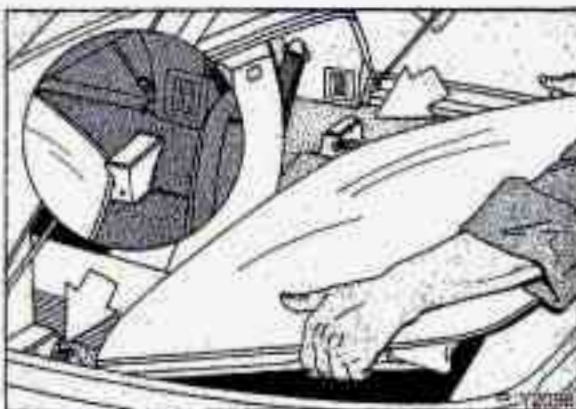

Roof Panel (CONT.)

Storing the Roof Panel:

1. Store the roof panel with its top up and rear pointing forward.

2. Slide the rear corners of the roof panel into the storage brackets and push forward.

NOTICE

Don't lift the front edge of the roof panel higher than 8 inches (20 cm) when the corners of the roof panel are in the storage brackets. If you do, you could damage the rear corners of the roof panel.

3. Lower the front of the roof panel, centering it over the latch pin.
4. Pull the latch release toward you and press down on the roof panel until the latch engages.
5. Push the latch release forward.
6. Gently lift up on the roof panel to be sure it is locked in place.

Reinstalling the Roof Panel:

1. Follow steps 1-7 in *Removing the Roof Panel*, earlier in this section, to prepare your vehicle.
2. Open the rear hatch and remove the roof panel from its stored position by reversing the procedure in *Storing the Roof Panel*, earlier in this section.

NOTICE

Don't lift the front edge of the roof panel higher than 8 inches (20 cm) when the corners of the roof panel are in the storage brackets. If you do, you could damage the rear corners of the roof panel.

3. Lower the roof panel onto the top of the vehicle, rear edge first, placing the rear guide pins of the roof panel into their locating holes.
4. Lower the front of the roof panel and position the front guide pins.
5. Use the wrench to partially tighten the two rear attaching bolts.

NOTICE

If you tighten bolts that are improperly started, the threads can become stripped. Be sure all bolts are properly started before you tighten them.

6. Use the wrench to loosely start the front two attaching bolts, making sure the bolts are properly threaded into the roof panel. If the front bolts seem hard to start, tighten the rear bolts some more. Also, holding down the panel on the outside will help you start the bolts.

7. Fully tighten the rear bolts, then the front bolts. If the bolts aren't tight enough, the roof panel may make a popping noise while you drive. If this happens, tighten the bolts securely.

CAUTION



An improperly attached roof panel may fall into or fly off the vehicle. You or others could be injured. After installing the roof panel, always check that it is firmly attached by pushing up on the underside of the panel near the bolts. Check now and then to be sure the roof panel is firmly in place.

Features & Controls

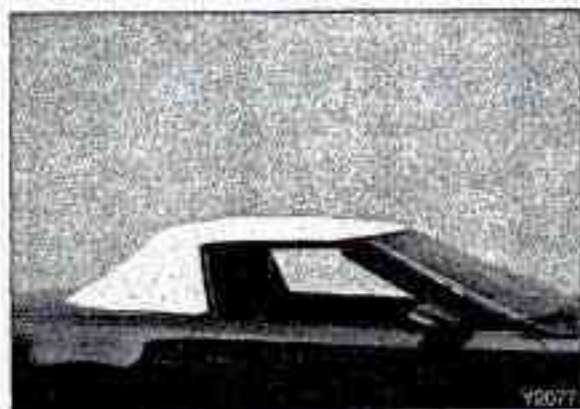

Convertible Top (OPTION)

The following sequences explain the proper operation of your convertible top. Follow these instructions and be sure to take proper care of your convertible top. See the *Index* under *Cleaning Your Convertible Top*.

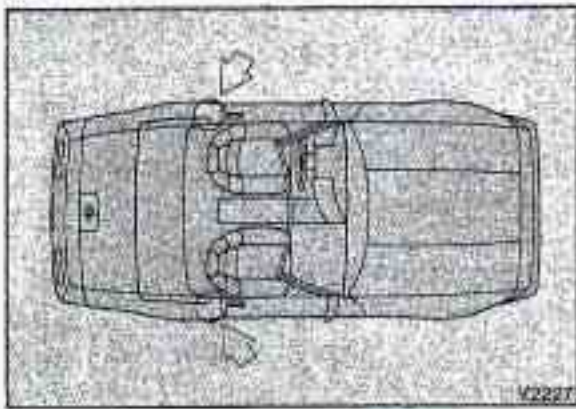

If your Corvette suffers a power loss, such as a "dead battery," you can still open the storage compartment by using the manual release handles located behind the safety belt anchors on each side of your vehicle.

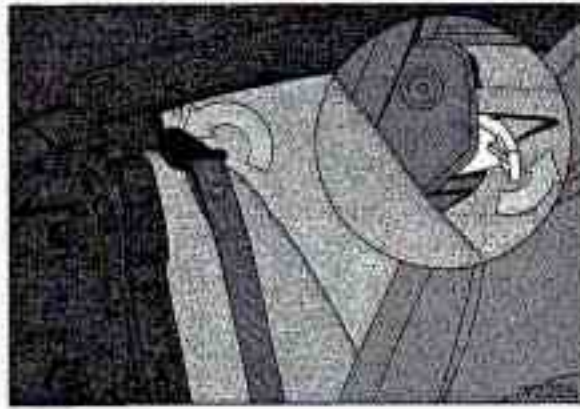

Locating the release handles may be difficult. Reach up and behind the safety belt anchors; you will find a release handle near the sidewall and behind the safety belt anchor on each side of your vehicle. Move the handle toward the rear of the vehicle and upward, as shown in the illustration above.

To Lower Your Convertible Top:

NOTICE

Don't leave your convertible out with the top down for any long periods of time. The sun and the rain can, over time, damage your seat material and other things inside your vehicle.

1. Park on a level surface, set the parking brake firmly, shift an automatic transmission into **P** (Park) and shut off the engine. Shift a manual transmission into **R** (Reverse). Then lower both windows and sun visors.

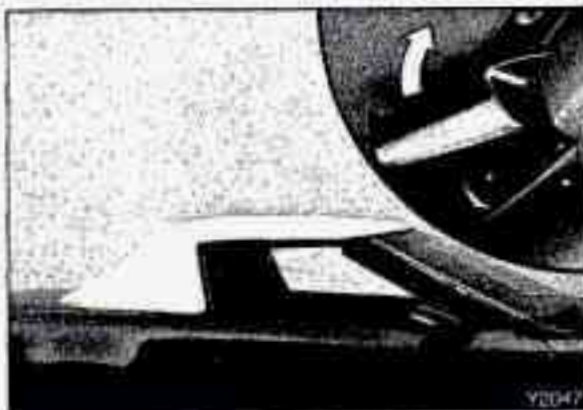

NOTICE

Before lowering the convertible top into the storage area, be sure there are no objects in the way of the folded, stored top.

2. Unlock the front of the convertible top by turning the latch handles outward and then lift the top off the windshield slightly. Then unfasten the Velcro[®] strips at the rear of each window opening.



3. Tilt the driver's seatback forward. The convertible top release handle is located behind the driver's seat and beneath the deck lid. Pull the release handle forward to unlock the rear of the convertible top, then lift and hold the rear of the convertible top.

Features & Controls



Convertible Top (CONT.)

4. Press either the storage compartment lid button located behind the driver's seat or the button in the center console. Then raise the lid.

NOTICE

Do not leave the convertible top on the closed lid when lowering the top. This may result in paint damage.

5. Lower the rear of the top back to its original position. Then lift the front edge of the top up and back with a slow, smooth motion. When folding the top into the storage compartment, make sure the fabric is folded between bows.

NOTICE

Do not lift the rear of the convertible top when lowering the top into the storage compartment or damage to the top may occur.



6. After the top is completely folded into the compartment, turn the latch handles toward the center of the vehicle. Close the storage compartment lid by pushing the front edge down on each side. Lift the lid and make sure it's latched.

NOTICE

When closing the deck lid, make sure the latch handles are turned back toward the center of the vehicle. If they aren't, you may damage the paint on the deck lid inner panel.



To Raise Your Convertible Top:

1. Park on a level surface and set the parking brake firmly. If you have an automatic transmission, shift into **P** (Park) and shut off the engine. If you have a manual transmission, shut off the engine and shift into **R** (Reverse). Then lower both windows and sun visors.
2. Unlock the storage compartment by pressing either the storage compartment lid button located behind the driver's seat or the button in the center console. Now raise the lid.
3. Turn the latch handles outward. Pull the top up and forward until it lines up with the windshield.

4. Latch the top by turning the handles toward the center of the vehicle. If needed, push down on the outside corners.

5. Lift the rear of the top and close the compartment lid firmly.

Features & Controls



Convertible Top (CONT.)

6. Lower the rear of the top so the latch pins align with the holes in the lid. To secure the rear of the top, push down firmly on both corners.
7. Fasten the Velcro® strips for the headliner at the rear of each window opening. Then fasten the Velcro® buttons at the lower front corner of the top.

NOTICE

Certain automatic vehicle washes may cause damage to the following areas of your vehicle:

- Aluminum wheels—the clear protective coating can be scratched or worn through by abrasive-type tire cleaning brushes.
- Convertible top and rear window—the plastic rear window can be scratched or the top fabric damaged by top cleaning brushes.
- Undercarriage—the vehicle undercarriage can be damaged if there is insufficient clearance for the vehicle wash operating mechanism.

For care and cleaning of your convertible top, see the *Index* under *Cleaning Your Convertible Top*.

Convertible Hardtop (OPTION)

The convertible hardtop has been designed for extended use in both warm and cold weather. The installation and removal of this top requires two people and takes approximately 30 minutes. For hardtop removal, you will need the Torx® wrench and flat ratchet wrench stored in the center console.

To Remove Your Convertible Hardtop:

1. Make sure you park on a level surface and set the parking brake firmly. Shift the transmission (automatic or manual) to **N** (Neutral) and lower both windows. Then turn off the ignition.

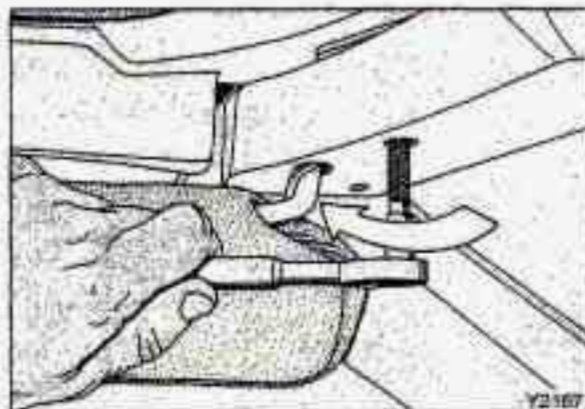

2. Lower the sun visors and loosen the front bolts with the Torx® wrench.

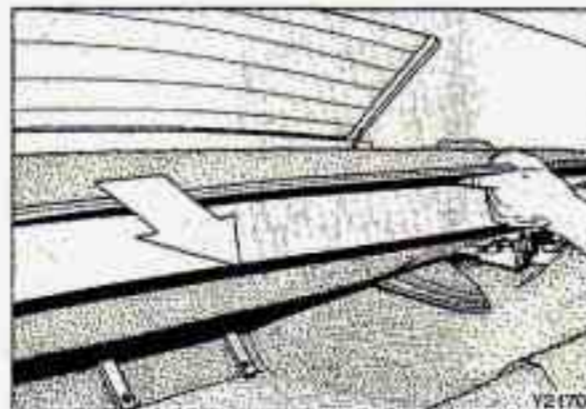

3. Move both seatbacks forward and remove the rear shelf trim panel.

Features & Controls

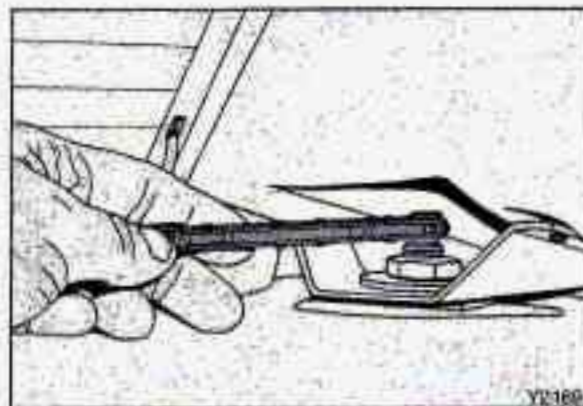

Convertible Hardtop (CONT.)

4. Loosen the rear corner bracket bolts with the ratchet wrench.

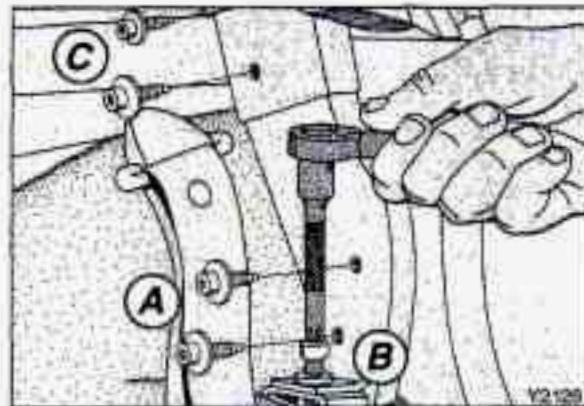

5. Using the Torx® wrench, remove the two lower bolts (A) from the lock pillar bracket on each side. Remove the bolt (B) from the bottom flange of each lock pillar bracket. Then remove the two upper bolts (C) from the receiver bracket on each side.

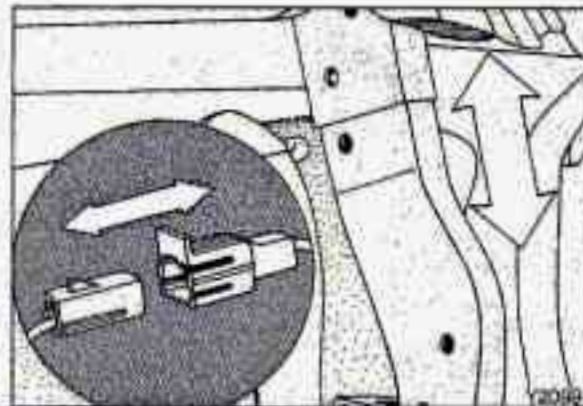

6. Slide both lock pillar brackets down and forward from the receiver brackets. The hardtop may have to be lifted slightly to remove the brackets.
7. Disconnect both wire connectors located behind the lock pillar brackets. These are the rear window defogger wires.

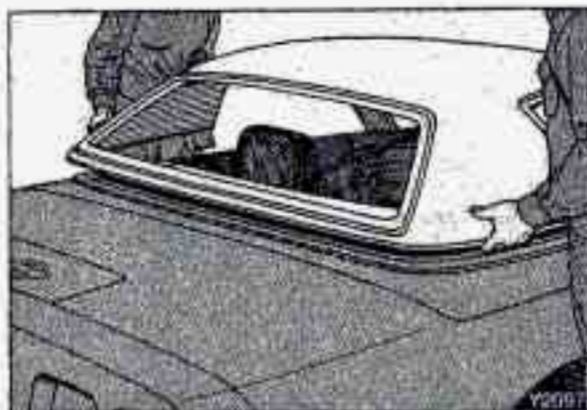

8. With one person on each side, gently lift the hardtop approximately 8 inches (20 cm) straight up. Remove over the rear of the vehicle.

NOTICE

To help avoid damaging the hardtop when not in use:

- Store the hardtop in its normal position, resting on its mounting brackets.
- Store hardware and trim panel with the hardtop.

To Install Your Convertible Hardtop:

1. Park on a level surface, set the parking brake firmly, shift an automatic transmission into **P** (Park), and shut off the engine. Shift a manual transmission into **R** (Reverse). Then lower both windows. Turn off the radio to lower the power antenna and then turn off the ignition. Lower the convertible top into the normal storage position. See the *Index* under *Lowering Your Convertible Top*.

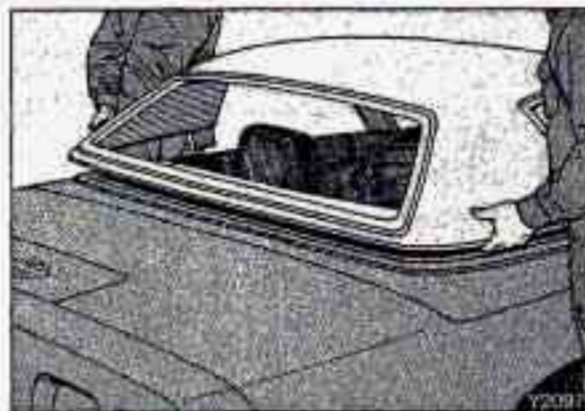

2. With one person on each side, carefully position the hardtop over the vehicle. Lower the hardtop slowly, aligning the rear bolt spacers onto the bezels, and front conical nuts into the tapered receivers. Realign the hardtop, if necessary.

NOTICE

To help avoid damage, don't force the rear of the hardtop down. The hardtop may rest slightly above the storage compartment lid until the release lever is pulled. See step 4 in this procedure.

Features & Controls

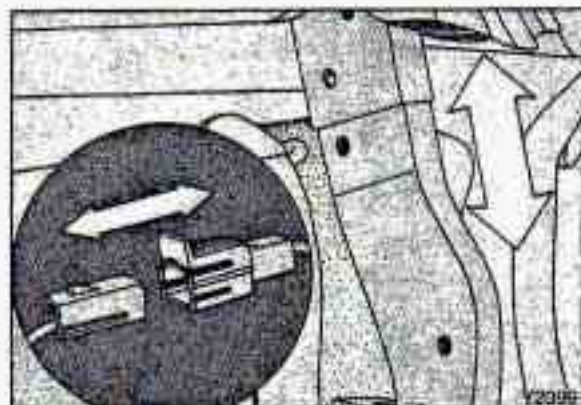

Convertible Hardtop (CONT.)

3. Move both seats forward. Then slide the lock pillar bracket into the receiver bracket until the scribed line is even with the lower edge of the receiver bracket. Make sure the black wire connectors are inside the vehicle and connected.

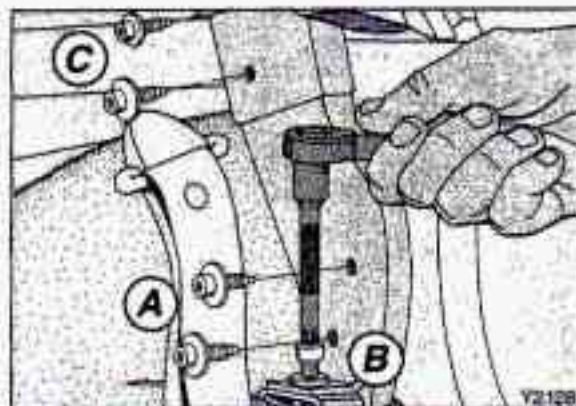

Insert the two upper Torx® bolts (C) into both receiver brackets. The hardtop may have to be lifted slightly to install the lock pillar bracket.

CAUTION



To help avoid personal injury, tighten all hardtop fasteners before driving the vehicle.

4. If the hardtop hasn't lowered into place, pull the release lever behind the driver's seat under the storage compartment lid.

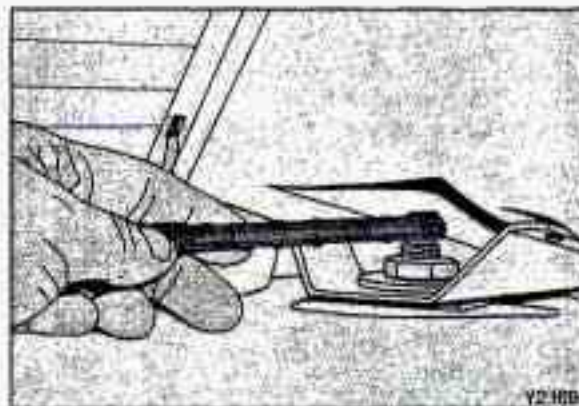

5. Secure, but **don't fully tighten**, the rear corner bracket bolts using the flat ratchet wrench.

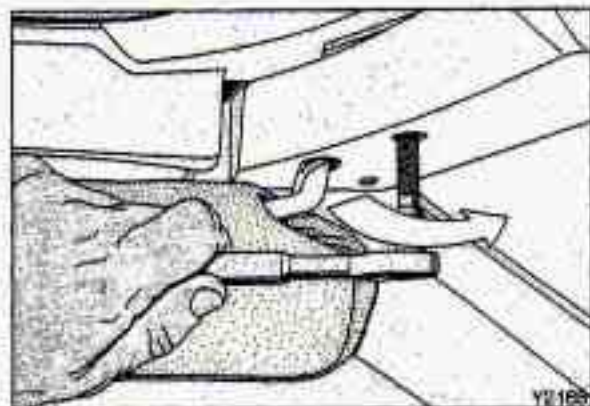

6. Tighten the front bolts by inserting the Torx® wrench through the access holes above the sun visors.

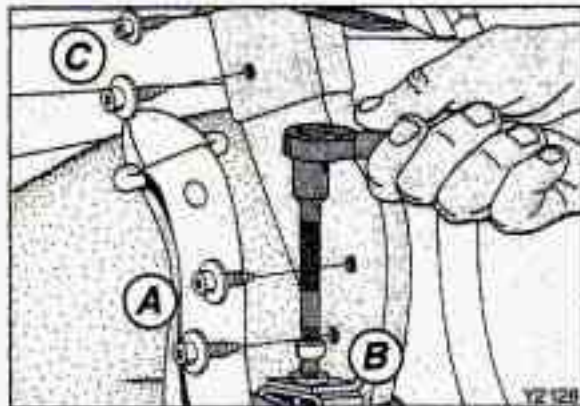

7. Insert the lower Torx® bolt (B) into the bottom flange of the lock pillar brackets and tighten. Install and tighten the remaining Torx® bolts (A) into the lock pillar brackets.

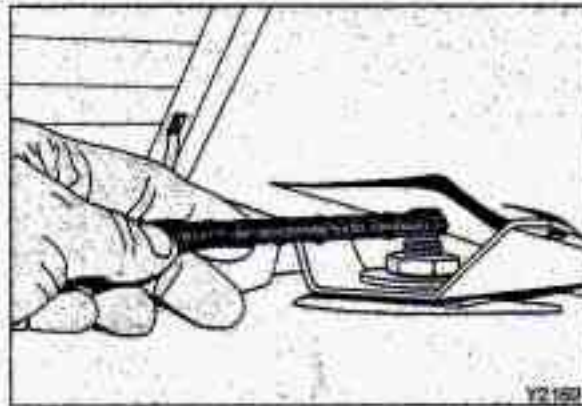

8. Using the flat ratchet wrench, tighten the rear corner bracket bolts. Do not over-tighten these bolts. Then slide the rear shelf panel over the rear shelf deck.

CAUTION



If the hardtop isn't secure, it can't give as much protection in a crash. A loose hardtop could fly off the vehicle in an accident or sudden maneuver. You or others could be injured. Don't drive your vehicle until all the hardtop fasteners are tight.

Notes



In this part you'll find out how to operate the comfort control systems and audio systems offered with your Corvette. Be sure to read about the particular system supplied with your vehicle.

Part 3

Comfort Controls & Audio Systems

Climate Control.....	136
Automatic Electronic Climate Control	140
Setting the Clock	148
AM/FM Stereo with Cassette Player	149
AM/FM Stereo with Cassette Player (Delco-Bose® Music System)	152
AM/FM Stereo with Cassette/CD Player (Delco-Bose® Music System)	155
Understanding Radio Reception	159
Care of Your Cassette Tape Player	160
Care of Your Compact Discs	160
Power Antenna Mast Care	161

Comfort Controls & Audio Systems



■ *Climate Control*

The air conditioner and heater work best if you keep your windows closed while using them. Your vehicle also has the flow-through ventilation system described later in this section.

OFF: Press this button to turn the system off. Press any function button to turn the system on.

Temperature Control Lever: This lever regulates the temperature of the air coming through the system.

Fan: The two fan buttons allow you to select the force of air you want.

Press  to lower the fan speed, or  to raise it.

Air Conditioning

On very hot days, open the windows long enough to let hot inside air escape. Your system has three air conditioning settings:

 **(Maximum A/C):** Use for maximum cooling or quick cool-down on very hot days. This setting will not operate when outside temperatures are below 40°F (5°C).

 **(Normal A/C):** Use for normal cooling on hot days. This setting brings in outside air, cools it, and directs it through the instrument panel outlets.

 **(Bi-Level):** This setting brings in outside air, cools it, and directs it in two ways—through the instrument panel outlets, as well as through the heater ducts.

For each air conditioning setting, adjust the temperature control lever and fan speed as desired.

Heating and Ventilation

In these settings, the air conditioner compressor doesn't run. Outside air enters the vehicle as indicated. For each setting, adjust the temperature control lever and fan speed as desired.

 (**Vent**): In this setting, outside air flows through the instrument panel outlets.

 (**Heat**): In this setting, most air flows through heater ducts near the floor. Some air will also flow through the defroster vents.

If your vehicle has an engine block heater and you use it during cold weather, 0°F (-18°C) or lower, your heating system will more quickly provide heat because the engine coolant is already warmed. See the *Index* under *Engine Block Heater*.

Defogging and Defrosting

Your vehicle has two settings for clearing your windows. The air conditioner compressor will run in both of these settings to remove moisture from the air when the temperature is above freezing. For each setting, adjust the temperature control lever and fan speed as desired.

 (**Defrost**): This setting directs 90% of the air through the windshield defroster vents and the side window vents, and 10% through the floor heater ducts.

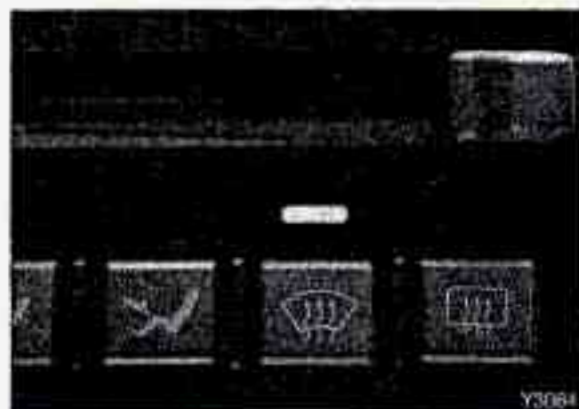



To defrost the windshield, slide the temperature control lever to the far right, press the  button, and adjust the fan to the highest speed. For rapid defrosting, 90% of the air will be directed to the windshield and side window vents.

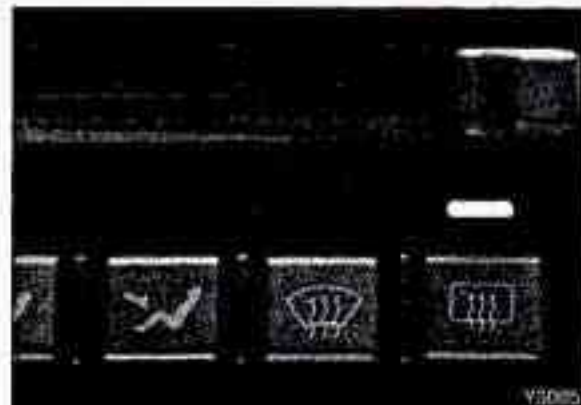
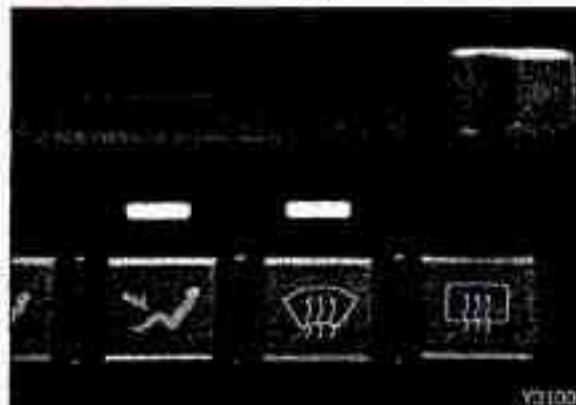

Comfort Controls & Audio Systems



Defogging and Defrosting (CONT.)

 Pressing these two buttons at the same time allows most air to flow to the floor heater ducts, with some going to the windshield and side window vents located in the windshield pillars. Use this setting to warm passengers while keeping the windshield clear.



To quickly defog the side windows, slide the temperature control lever to the far right, press the  button, and adjust the fan to the highest speed. Aim the side vents toward the side windows. For increased air flow from the side vents, close the center vents.

Pressing both the  and  buttons at the same time will direct air through both the defroster and heater outlets.

Rear Window Defogger

(COUPE AND HARDTOP CONVERTIBLE)

The rear window defogger uses a warming grid to remove fog from the rear window. It also warms the power mirrors.

 **(Rear Window Defogger):** Press this button to turn the defogger on. The defogger will return to **OFF** automatically after about 10 minutes of use. You can also turn the defogger off by turning off the ignition or by pressing the  button again.

The rear window defogger operates only when the engine is running.

Do not attach a temporary vehicle license across the defogger grid on the rear window.

NOTICE

Don't use a razor blade or other sharp item on the inside of the rear window. If you do, you could cut or damage the warming grid, and the repairs wouldn't be covered by your warranty.

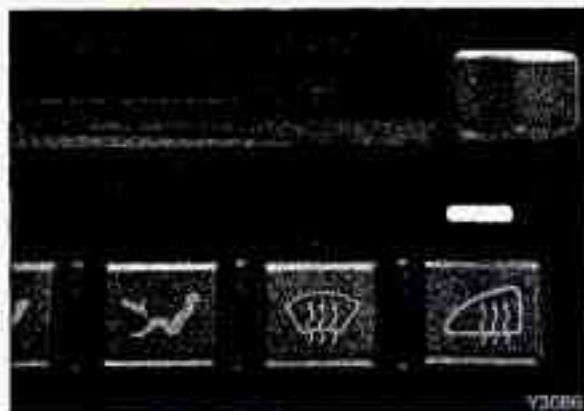

Power Mirror Defogger (CONVERTIBLE WITHOUT HARDTOP)

 **(Power Mirror Defogger):** Press this button to warm and defog the power mirrors.

The power mirror defogger will turn off automatically after about 10 minutes of use. You can also turn the defogger off by turning off the ignition or by pressing the  button again.

The power mirror defogger operates only when the engine is running.

Specially Treated Windshield (ZR-1)

Your ZR-1 windshield is specially treated to reduce the amount of solar heat entering your vehicle. This makes it easier for your air conditioning system to keep you comfortable.

The specially treated windshield will decrease the effective distance of some add-on electronic devices, such as garage door openers. If you use such a device, aim it through the opening at the bottom center of the windshield.

Comfort Controls & Audio Systems



■ *Automatic Electronic Climate Control (OPTION)*

With this system, you can control the ventilation, heating and air conditioning in your vehicle, or you can use the automatic setting. Your vehicle also has the flow-through ventilation system described later in this section.

The digital screen displays the outside temperature, the inside temperature setting, and the fan speed. If the inside temperature is changed, or if the system is changed from **OFF** to any mode, the inside temperature setting will be displayed for several seconds before the outside temperature is again displayed.

The air conditioner compressor operates in all air conditioning positions, and in

 (Defrost) when the outside temperature is above freezing. When the air conditioner is on, you may sometimes notice slight changes in your vehicle's engine speed and power. This is normal, because the Automatic Electronic Climate Control system is designed to cycle the compressor on and off to keep the desired cooling and to help your vehicle's fuel economy.

TEMP SET: This control sets the interior temperature you want. Press ▼ to lower the inside temperature setting; press ▲ to raise the setting. The temperature you set will be displayed on the digital screen.

Once you set the temperature you want, the system will try to maintain this

temperature, whether you are using the heating or the cooling controls.

However, if you set the temperature for 60°F (16°C) or 90°F (32°C), the fan will stay on  unless you select a different speed.

Your Automatic Electronic Climate Control system has three sensors. The sun load sensor on top of the dashboard detects increased interior temperature caused by sunlight. To keep you comfortable, it reduces the interior temperature by as much as 5°F (3°C) below the setting on the digital screen.

The outside air temperature sensor, located on the right side of the upper radiator support in the grille opening, reads the outside temperature. This is what you usually see on the display.

The outside temperature sensor reading is filtered (to minimize false readings) as follows:

If the outside temperature decreases, the displayed temperature will update immediately.

If the outside temperature increases (such as when stopped in traffic), the displayed temperature will not update until one of the following conditions is met:

- Vehicle speed is above 25 mph (40 km/h) for at least 3 minutes, or
- Vehicle speed is above 45 mph (72 km/h) for 1½ minutes.

Updates will occur continuously as long as the vehicle speed remains above 25 mph (40 km/h).

If the ignition is turned off for more than three hours, the current outside air temperature when the vehicle is restarted will be stored in the system immediately.

The third sensor is the in-vehicle temperature sensor, located in the center air outlet on the passenger side.

If you block or cover either interior sensor, the sensor will give your system a false reading.

AUTO (Automatic): This system automatically adjusts to the temperature range you select. It stays at this temperature with the least possible noise level and it will select the best mode (Heater, Air Conditioning or Bi-Level) and fan speed to keep you comfortable. The fan blower will vary its speed automatically unless you override it with the ▼ or ▲ button.



1. Set the temperature you want with the **TEMP SET** switch.
2. Press **AUTO**. An indicator light will glow above this button.
3. Press  (Vent) to allow outside air to flow into the vehicle.

Comfort Controls & Audio Systems

■ *Automatic Electronic Climate Control (Cont.)*

Use These Settings to Set Your Fan Speed:

▼ **(Low Fan):** This setting overrides the automatic fan speed. To decrease fan speed, press the ▼ button and hold until you see the fan speed you want.

AUTO  **(Automatic Fan):** When you use this setting, the controller chooses the fan speed based on the input signals. In the **AUTO**  mode during hot weather (after the vehicle has not been running for a period of time) the fan speed will be low when the vehicle is initially started. This

initial low fan speed is used to purge the vehicle of hot interior air. In the **AUTO**  mode during cold weather, the fan speed will be delayed in the heat mode until the engine coolant reaches an adequate temperature to provide heat.

▲ **(High Fan):** This setting overrides the automatic fan speed. To increase fan speed, press the ▲ button and hold until you see the fan speed you want. There is no fan blower delay.

Fan speeds will range from **1** (lowest setting) to **10** (highest setting). When any fan speed is selected, it will appear on the digital screen briefly and the outside temperature will also appear.

Air Conditioning System

If a light above a button flashes when you turn on the ignition, it may indicate an electrical problem with your air conditioning system. The flashing will continue for one minute, then go out. It means you should have your system checked and serviced if needed.

It may also mean the refrigerant level is too low in your air conditioner system. The light will still flash after refrigerant is added. This means your system will not cool the air until it is reset.

To Reset Your System:

1. Turn your ignition key to **Off** or **Lock**.
2. Pull the Courtesy Lights Fuse and Radio Fuse out of the main fuse panel for one minute.
3. Put the fuses back in and start your vehicle. Your system should be working. If you still have a problem, see your dealer.

For fuse location, see the *Index* under *Fuses & Circuit Breakers* and *Fuse Panel*.

Directional Controls

When the following buttons are pressed, an indicator light will glow above the button and the fan speed will go to:

AUTO  unless you select a different speed. When the system is changed from **OFF** to any mode, the inside temperature setting is displayed for several seconds before the outside temperature is again displayed.

 (**Maximum A/C**): Use for maximum cooling or quick cool-down on very hot days. This setting will not operate when outside temperatures are below 40°F (5°C).

 (**Bi-Level**): This setting lets air into the vehicle only through the heater and air conditioner outlets and brings the temperature to the range you choose. It controls the fan blower speed by using the input signals. Bi-Level also defogs the side windows. You can override the fan blower speed by using the **▼** and **▲** buttons.

 (**Vent**): In this setting, the compressor will not run. The system will adjust to the temperature you choose, but it cannot cool the vehicle to a temperature colder than the outside air temperature. This setting

Comfort Controls & Audio Systems

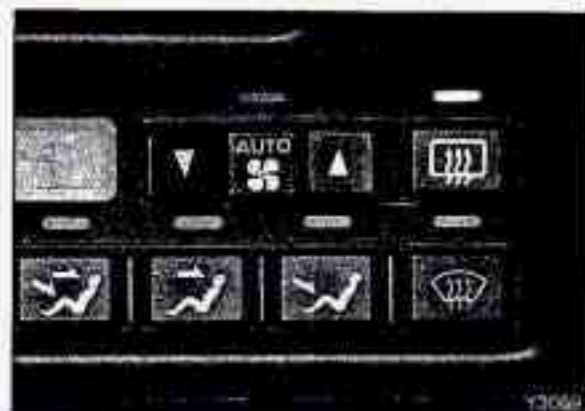

Directional Controls (CONT.)

also controls the fan speed automatically, unless the fan is overridden by the ▼ or ▲ button.

W (Heater): In this setting, all air coming into the vehicle is forced to the floor. The fan blower motor will vary in speed unless you press the ▼ or ▲ button. The in-car temperature will adjust to the setting you choose. The air conditioning compressor will not run in the manual heater mode.

If your vehicle has an engine block heater and you use it during cold weather, 0°F (-18°C) or lower, your heating system will more quickly provide heat because the engine coolant is already warmed. See the *Index* under *Engine Block Heater*.

W (Defrost): With this setting, most of the air is forced through the windshield defroster vents. The compressor runs by using all the input signals. The fan blower also goes to a fixed high speed with no delay. After start-up you can override the **High** fan blower speed by pushing ▼ or **AUTO**.

DEFOG: Press the W and W buttons at the same time to operate the defog mode. This directs warmed air through the windshield defroster vents, and through the heater ducts.

OFF: Press to turn off the system.

Rear Window Defogger

(COUPE AND HARDTOP CONVERTIBLE)

W (Rear Window Defogger): Press this button to warm the defogger grid on the rear window and warm the power mirrors. The indicator light will glow while the rear window defogger is operating. If you have a convertible, you will have the W (Power Mirror Defogger) button on your climate control system. This button is for heated mirrors only. The rear window defogger will turn off automatically after about 10 minutes of use. You can also turn the defogger off by turning off the ignition or by pressing the W button again.

The rear window defogger and power window defogger only operate when the engine is running.

Do not attach a temporary vehicle license across the defogger grid on the rear window.

NOTICE

Don't use a razor blade or other sharp item on the inside of the rear window. If you do, you could cut or damage the warming grid, and the repairs wouldn't be covered by your warranty.

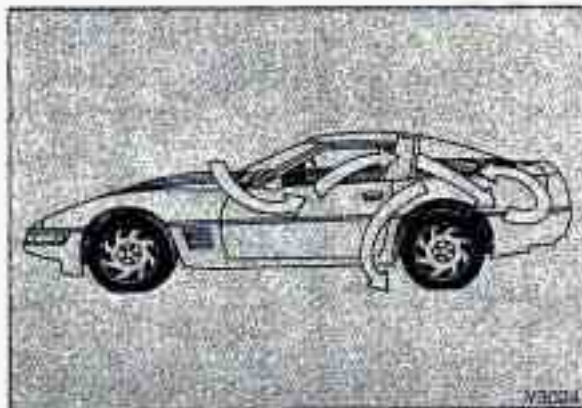

Flow-Through Ventilation System

Your Corvette's flow-through ventilation system supplies outside air into the vehicle when it is moving. Outside air will also enter the vehicle when the heater or the air conditioning fan is running.

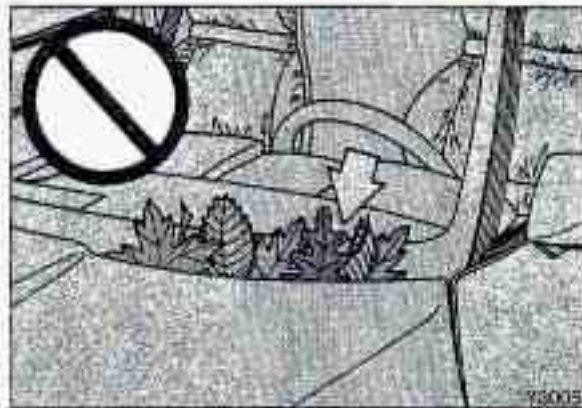

Ventilation Tips

- Keep the hood and front air inlet free of ice, snow, or any other obstruction (such as leaves). The heater and defroster will work far better, reducing the chance of fogging the inside of your windows.
- When you enter a vehicle in cold weather, turn the blower fan to the highest speed for a few moments before driving off. This helps clear the intake ducts of snow and moisture, and reduces the chance of fogging the inside of your windows.
- Keep the air path under the front seats clear of objects. This helps air to circulate throughout your vehicle. See the *Index* under *Engine Exhaust*.

Comfort Controls & Audio Systems

■ *Audio Systems*

The following pages describe the audio systems available for your Corvette, and how to get the best performance from them. Please read about the system in your vehicle.

CAUTION



Hearing damage from loud noise is almost undetectable until it is too late. Your hearing can adapt to higher volumes of sound. Sound that seems normal can be loud and harmful to your hearing. Take precautions by adjusting the volume control on your radio to a safe sound level before your hearing adapts to it.

To help avoid hearing loss or damage:

1. Adjust the volume control to the lowest setting.
2. Increase volume slowly until you hear comfortably and clearly.

NOTICE

Before you add any sound equipment to your vehicle—like a tape player, CB radio, mobile telephone or two-way radio—be sure you can add what you want. If you can, it's very important to do it properly. Added sound equipment may interfere with the operation of your vehicle's engine, Delco® radio or other systems, and even damage them. And, your vehicle's systems may interfere with the operation of sound equipment that has been added improperly.

So, before adding sound equipment, check with your dealer and be sure to check federal rules covering mobile radio and telephone units.

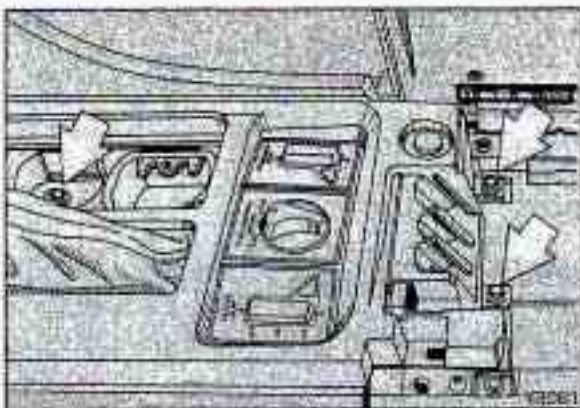

Accessory Wiring Plug

This plug is located under the trim panel in front of the center console compartment. This accessory plug can be used to plug in electrical equipment such as cellular telephones, CB radios, etc. Follow the proper installation instructions that are included with any electrical equipment you install.

To Access the Accessory Wiring Plug:

1. Open the center console and carefully pull the console carpet away from the coin holder to uncover the 7 mm hex-head screws located on either side.
2. Remove the two hex-head screws using a hex-head ratchet.
3. Open the cup holder/ashtray, pull out the rubber insert from the front cup holder, and remove the hex-head screw from the middle of the forward cup holder. Then carefully pull the trim panel up.
4. Disconnect plug by pulling forward on the plastic locking tab. Then pull the free end of the plug forward into center console.
5. After the installation, secure the trim panel.

Comfort Controls & Audio Systems

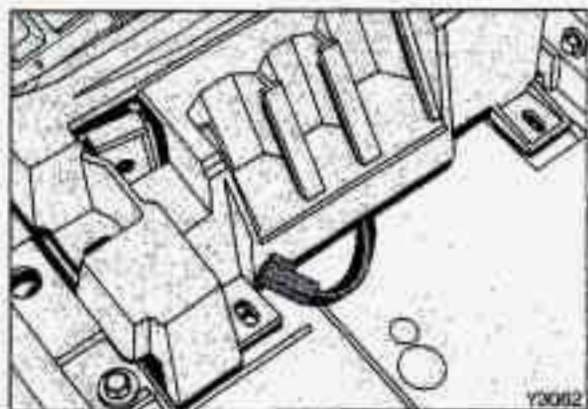

Accessory Wiring Plug (CONT.)

This Wiring Plug has Three Separate Wires:

- The orange wire connects to the battery.
- The pink wire connects to the ignition (power is only available in the **Run** position).
- The black wire connects to the ground.

NOTICE

When using the accessory wiring plug:

- Don't splice wires directly into the accessory plug wire. If done incorrectly, splicing might cause damage to your electrical system.
- The maximum load of any electrical equipment should not exceed 15 amps.
- Be sure to turn off any electrical equipment when not in use. Leaving electrical equipment on for extended periods can drain your battery.
- Do not use this plug if the electrical equipment you're using requires frequent connecting and disconnecting. This may cause excessive wear on the accessory plug and damage your electrical system.

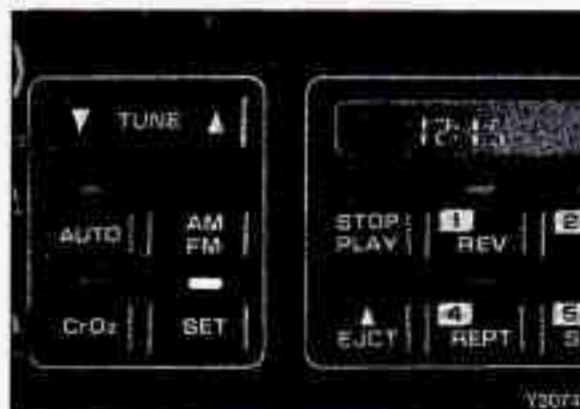

Setting the Clock

Setting the clock is easy.

1. With the radio on or off and the ignition on, press **SET**. The **SET** indicator light will glow for five seconds.
2. You must begin to set the clock to the correct hour and minute during those five seconds. Set the clock by pressing the **TUNE** button. **TUNE** ▼ will set the hour. **TUNE** ▲ sets the minute.

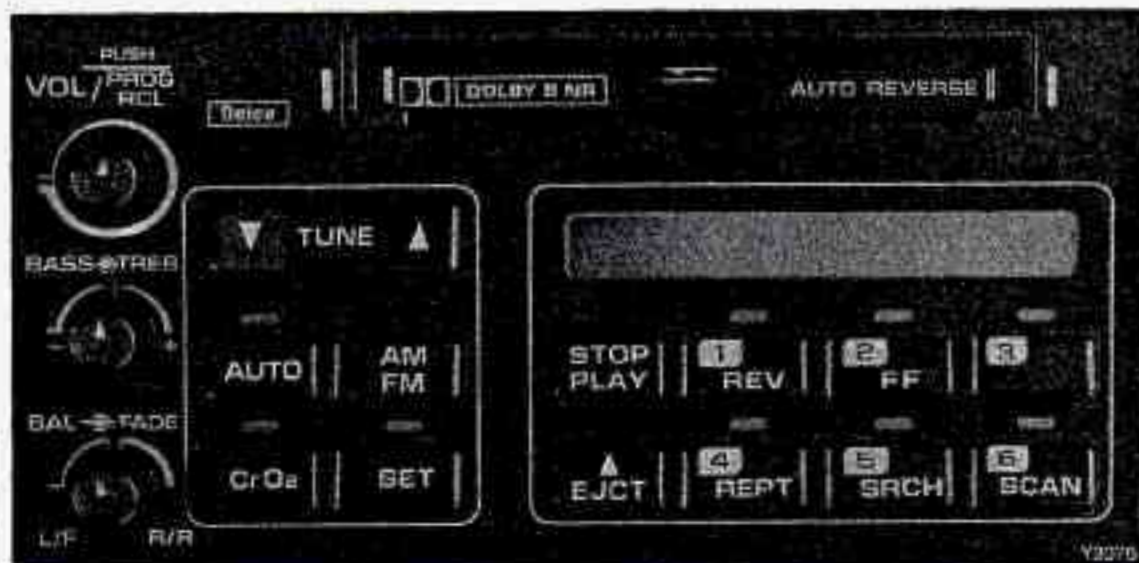

AM/FM Stereo with Cassette Player

VOL/PROG/RCL: Turns the unit on and off when the ignition is on. Adjusts volume up or down.

BAL/FADE: Turn the inside control knob to adjust the sound from the left to the right speakers.

Turn the control ring to adjust the sound from the front to the rear speakers.

Radio Controls:

The digital display indicates information on time or radio station frequency, the AM or FM radio band, whether the station is in stereo, and other radio functions.

AM/FM: Press this button to select either the AM or FM radio band. The band you select will be displayed on the digital screen. The frequency of the station will be displayed, and if the station is in stereo, the **ST** indicator will also be displayed.

RCL (Recall): Press to change between the clock or the radio station frequency displayed on the digital screen.

AUTO: Press this button, then press **TUNE** to tune to the next station on the AM or FM band.

An indicator light above a preset station button will glow when the seek mode stops at that station.

Comfort Controls & Audio Systems

AM/FM Stereo with Cassette Player (CONT.)

TUNE: Press this control to tune in stations higher or lower on the AM or FM radio band. For rapid tuning, press and hold one side of **TUNE**, then press the other side. The display will revert to time if the tuning activity has ceased for approximately five seconds.



BASS/TREB (Treble): The inside knob adjusts the bass level up or down. The outside ring adjusts the treble level up or down.

To Preset Radio Stations:

The six numbered pushbuttons can be used to preset up to twelve radio stations (six AM and six FM stations).

1. Tune in the desired station.
2. Press **SET**. The **SET** indicator light will glow.
3. While the **SET** indicator light glows, press one of the six pushbuttons. Whenever you press this button again, the preset station will be tuned in.
4. Repeat steps 1-3 for each of six AM and six FM stations.

To Play a Cassette Tape:

This audio system has automatic  Dolby B NR[®] to reduce background noise on Dolby encoded tapes. Dolby[®] Noise Reduction is manufactured under license from Dolby Laboratories Licensing Corporation. Dolby[®] and the  symbol are trademarks of Dolby Laboratories Licensing Corporation.

Turn the **VOL** knob to turn the radio on. Then push a cassette into the cassette entry door (the tape side goes in first). Do not use tapes that are longer than 45 minutes on each side. The display will indicate **CA IN** when a cassette tape is in the player.



FF (Fast Forward): Press to advance the tape rapidly; press again to play. (The radio plays while the tape is fast forwarding.) The indicator light will glow when this button is pressed.

REV (Reverse): Press to reverse the tape rapidly; press again to play. (The radio plays while the tape is rewinding.) The indicator light will glow when this button is pressed.

CrO₂: Press this button when playing high bias chrome or metal tapes. An indicator light will glow when this button is pressed. When playing standard tapes, press again.

PROG (Program): Press to change the side of the tape being played. Arrows in the display will indicate the side currently playing. The tape player automatically begins playing the other side of the cassette when it reaches the end of a tape.

SRCH (Search): Press to search for the next selection on the tape. There must be at least a three-second gap between selections on the tape for this function to work. An indicator light will glow when this button is pressed.

SCAN: Press to listen to the beginning eight seconds of each track or passage. To stop scanning, press **SCAN** again; the indicator light will go out and the tape will continue to play.

REPT (Repeat): Press to return to the beginning of the current selection after 10 seconds or more of play. After 10 seconds or less of play, the player will return to the beginning of the previous selection.

EJECT (Eject): Press to have the cassette tape ejected (the radio will then play). This button will also work when the radio or ignition are turned off.

STOP/PLAY: Press this to listen to the radio without ejecting the cassette.

Comfort Controls & Audio Systems



AM/FM Stereo with Cassette Player (Delco-Bose® Music System)

VOL/PROG/RCL: Turns the unit on and off when the ignition is on. Adjusts volume up or down.

FADE: Adjusts the front/rear speaker balance. There is no control to adjust for left/right speaker balance because none is required.

Radio Controls:

The digital display indicates information on time or radio station frequency, the AM or FM radio band, whether the station is in stereo, and other radio functions.

AM/FM: Press this button to select either the AM or FM radio band. The band you select will be displayed on the digital screen. The frequency of the station will also be displayed, and if the station is in stereo, the **ST** indicator will also be displayed.

Your radio has an AMAX-certified receiver. It can produce quality AM stereo sound and receive C-Quam® stereo broadcasts. AMAX reduces noise without reducing the high frequencies you need for the best sound. You don't have to do anything to your Delco/GM radio because AMAX is automatic.

RCL (Recall): Press to change between the clock or the radio station frequency displayed on the digital screen.

AUTO: Press this button, then press **TUNE** to tune to the next station on the AM or FM band.

An indicator light above a preset station button will glow when the seek mode stops at that station.

TUNE: Press this control to tune in stations higher or lower on the AM or FM radio band. For rapid tuning, press and hold one side of **TUNE**, then press the other side. The display will revert to time if the tuning activity has ceased for approximately five seconds.



BASS/TREB (Treble): The inside knob adjusts the bass level up or down. The outside ring adjusts the treble level up or down.

To Preset Radio Stations:

The six numbered pushbuttons can be used to preset up to twelve radio stations (six AM and six FM stations).

1. Tune in the desired station.
2. Press **SET**. The **SET** indicator light will glow.
3. While the **SET** indicator light glows, press one of the six pushbuttons. Whenever you press this button again, the preset station will be tuned in.
4. Repeat steps 1-3 for each of six AM and six FM stations.

To Play a Cassette Tape:

This audio system has automatic  Dolby B NR[®] to reduce background noise on Dolby encoded tapes. Dolby[®] Noise Reduction is manufactured under license from Dolby Laboratories Licensing Corporation. Dolby[®] and the  symbol are trademarks of Dolby Laboratories Licensing Corporation.

Turn the **VOL** knob to turn the radio on. Then push a cassette into the cassette entry door (the tape side goes in first). Do not use tapes that are longer than 45 minutes on each side.

The display will indicate **CA IN** when a cassette tape is in the player.

Comfort Controls & Audio Systems



AM/FM Stereo with Cassette Player (Delco-Bose® Music System) (CONT.)

FF (Fast Forward): Press to advance the tape rapidly; press again to play. (The radio plays while the tape is fast forwarding.) The indicator light will glow when this button is pressed.

REV (Reverse): Press to reverse the tape rapidly; press again to play. (The radio plays while the tape is rewinding.) The indicator light will glow when this button is pressed.

CrO₂: Press this button when playing high bias chrome or metal tapes. An indicator light will glow when this button is pressed. When playing standard tapes, press again.

PROG (Program): Press to change the side of the tape being played. Arrows in the display will indicate the side currently playing. The tape player automatically begins playing the other side of the cassette when it reaches the end of a tape.

SRCH (Search): Press to search for the next selection on the tape. There must be at least a three-second gap between selections on the tape for this function to work. An indicator light will glow when this button is pressed.

SCAN: Press to listen to the beginning eight seconds of each track or passage. To stop scanning, press **SCAN** again; the indicator light will go out and the tape will continue to play.

REPT (Repeat): Press to return to the beginning of the current selection after 10 seconds or more of play. After 10 seconds or less of play, the player will return to the beginning of the previous selection.

EJCT (Eject): Press to have the cassette tape ejected (the radio will then play). This button will also work when the radio or ignition are turned off.

STOP/PLAY: Press this to listen to the radio without ejecting the cassette.



AM/FM Stereo with Cassette/CD Player (Delco-Bose® Music System)

SCV/VOL: The inside knob turns the unit on and off when the ignition is on and adjusts volume up or down.

SCV (Speed-Compensated Volume): This three-position control ring will automatically compensate for the increase in road noise levels at higher speeds. At normal driving speed, set the volume control as desired. Switching to **L** (Low) or **H** (High) causes the volume to increase as your speed increases.

The high position will give you a higher maximum volume than the low position. The high position will also increase the volume faster. Use the low position when driving with the roof panel on, or the convertible top up and the windows closed. The high position is best when driving with the roof panel off, or the convertible top down and the windows open. **SCV** will be indicated on the display when on. This feature can be turned off by turning the control ring to the **OFF** position.

FADE: Adjusts the front/rear speaker balance. There is no control to adjust for left/right speaker balance because none is required.

Comfort Controls & Audio Systems

AM/FM Stereo with Cassette/CD Player (Delco-Bose® Music System) (CONT.)

Radio Controls:

The digital display indicates information on time or radio station frequency, the AM or FM radio band, whether the station is in stereo, and other radio functions.

AM/FM: Press this button to select either the AM or FM radio band. The band you select will be displayed on the digital screen. The frequency of the station will also be displayed, and if the station is in stereo, **ST** will also be displayed.

Your radio has an AMAX-certified receiver. It can produce quality AM stereo sound and receive C-Quam® stereo broadcasts. AMAX reduces noise without reducing the high frequencies you need for the best sound. You don't have to do anything to your Delco/GM radio because AMAX is automatic.

RCL (Recall): Press to change between the clock or the radio station frequency displayed on the digital screen.

AUTO: Press this button, then press **TUNE** to tune to the next station on the AM or FM band.

An indicator light above a preset station button will glow when the seek mode stops at that station.

TUNE: Press this control to tune in stations higher or lower on the AM or FM radio band. For rapid tuning, press and hold one side of **TUNE**, then press the other side.

BASS/TREB (Treble): The inside knob adjusts the bass level up or down. The outside ring adjusts the treble level up or down.

CA/CD: The display will indicate **CA IN** when a cassette is loaded into

the unit, or **CD IN** when a CD is loaded into the unit. Cassette play is also indicated in the display by an arrow. CD play is also indicated by the track number that is displayed when **RCL** is pressed. An indicator light will glow when the button is pressed. Press to alternate between cassette and CD if both are loaded in the unit.

To Preset Radio Stations:

The six numbered pushbuttons can be used to preset up to twelve radio stations (six AM and six FM stations).

1. Tune in the desired station.
2. Press **SET**. The **SET** indicator light will glow.
3. While the **SET** indicator light glows, press one of the six pushbuttons. Whenever you press this button again, the preset station will be tuned in.
4. Repeat steps 1-3 for each of six AM and six FM stations.

To Play a Cassette Tape:

This audio system has automatic  Dolby B NR[®] to reduce background noise on Dolby encoded tapes. Dolby[®] Noise Reduction is manufactured under license from Dolby Laboratories Licensing Corporation. Dolby[®] and the  symbol are trademarks of Dolby Laboratories Licensing Corporation.

Turn the **VOL** knob to turn the radio on. Then push a cassette into the cassette entry door (the tape side goes in first). Do not use tapes that are longer than 45 minutes on each side.

FF (Fast Forward): Press to advance the tape rapidly; press again to play. (The radio plays while the tape is fast forwarding.) The indicator light will glow when this button is pressed.

REV (Reverse): Press to reverse the tape rapidly; press again to play. (The radio plays while the tape is rewinding.) The indicator light will glow when this button is pressed.

CrO₂: Press this button when playing high bias chrome or metal tapes. An indicator light will glow when this button is pressed. When playing standard tapes, press again.

PROG (Program): Press to change the side of the tape being played. Arrows in the display will indicate the side currently playing. The tape player automatically begins playing the other side of the cassette when it reaches the end of a tape.

SCAN: Press this to sample the beginning of each track or passage. An indicator light will come on when the button is pressed. Press again to stop scanning.

SRCH (Search): Press to search for the next selection on the tape. There must be at least a three-second gap between selections on the tape for this function to work. An indicator light will glow when this button is pressed.

REPT (Repeat): Press to return to the beginning of the current selection after 10 seconds or more of play. After 10 seconds or less of play, the player will return to the beginning of the previous selection.

EJCT (Eject): Press to have the cassette tape ejected (the radio will then play). This button will also work when the radio or ignition are turned off.

STOP/PLAY: Press this to listen to the radio without ejecting the cassette.

Comfort Controls & Audio Systems



AM/FM Stereo with Cassette/CD Player (Delco-Bose® Music System) (CONT.)

To Play a Compact Disc:

If you have the optional compact disc player, don't use mini-discs that are called singles. They will eject, and they won't play. Use only full-size compact discs.

1. Rotate the **SCV/VOL** (Volume) knob on your radio to turn on the CD player.
2. Insert a disc part way into the slot, with the label side up. The player will pull it in. In a few seconds, the disc should start on the first track.

If the disc comes back out and **ERR** appears on the display:

- The disc may be upside down.
- The disc may be dirty, scratched or wet.
- There may be too much moisture in the air (wait about one hour and try again).
- The temperature is too hot or cold.
- The road you're driving on may be too rough.

To display the track being played or the elapsed time of the track playing, push **RCL** (Recall). Push again to display the time of day.

FF (Fast Forward): Hold this button down to rapidly advance through the tracks or passages. The CD will play at normal speed when the button is released. The display will show the increasing elapsed time.

REV (Reverse): Hold this button down to rapidly reverse through tracks or passages. The CD will play at normal speed when the button is released. The display will show the decreasing elapsed time.

SRCH (Search): Press to search for the next selection on the disc. When this button is pressed more than once or held, the CD will continue to advance through the disc. An indicator light will glow when this button is pressed.

RCL (Recall): Press once to see which track is playing. Press again to see how long your track has been playing (**EL TIME**—elapsed time). Press again to display the time.

COMP (Compression): Pressing this button makes soft and loud passages more equal in volume. An indicator light will come on when the button is pressed. Press again to resume normal play.

SCAN: Press this to sample the beginning of each track or passage. An indicator light will come on when the button is pressed. Press again to stop scanning.

REPT (Repeat): Press to return to the beginning of a selection after 10 seconds or more of play. After 10 seconds or less of play, the player will return to the beginning of the previous selection.

When Finished with the Compact Disc Player:

If you rotate the **SCV/VOL** knob to **OFF** or turn off the ignition, the disc will stay in the player and start again when you turn on the ignition or power switch. The disc will begin playing at the point where it had been stopped.

STOP/PLAY: Press to stop the disc player; the radio will play. Press again to play the disc (the player will start playing the disc where it was stopped earlier).

EJCT (Eject): Press to eject the disc; the radio will play. This button will also work when the radio or ignition is off. The disc will be automatically pulled back into the CD player if it is not removed from the CD opening after 30 seconds, when the ignition is off or the **SCV/VOL** knob is rotated to **OFF**.

Understanding Radio Reception FM Stereo

FM stereo will give you the best sound, but FM signals will reach only about 10 to 40 miles (16 to 65 km). Tall buildings or hills can interfere with FM signals, causing the sound to come and go.

AM

The range for most AM stations is greater than for FM, especially at night. The longer range, however, can cause stations to interfere with each other. AM can also pick up noise from things like storms and power lines. To lower this noise, try reducing the treble level.

Comfort Controls & Audio Systems



Care of Your Cassette Tape Player

A tape player that is not cleaned regularly can cause reduced sound quality, ruined cassettes, or a damaged mechanism. Cassette tapes should be stored in their cases away from contaminants, direct sunlight, and extreme heat. If they aren't, they may not operate properly or cause failure of the tape player.

Your tape player should be cleaned regularly each month or after every 15 hours of use. If you notice a reduction in sound quality, try a known good cassette to see if the tape or the tape player is at fault. If this other cassette has no improvement in sound quality, clean the tape player.

Clean your tape player with a wiping-action, non-abrasive cleaning cassette, and follow the directions provided with it.

Cassettes are subject to wear and the sound quality may degrade over time. Always make sure that the cassette tape is in good condition before you have your tape player serviced.



Care of Your Compact Discs

Handle discs carefully. Store them in their original cases or other protective cases and away from direct sunlight and dust. If the surface of a disc is soiled, dampen a clean, soft cloth in a mild, neutral detergent solution and clean it, wiping from the center to the edge.

Be sure never to touch the signal surface when handling discs. Pick up discs by grasping the outer edges or the edge of the hole and the outer edge.



Power Antenna Mast Care

Your power antenna will look its best and work well if it's cleaned from time to time.

To Clean the Antenna Mast:

1. Turn on the ignition and radio to raise the antenna to full mast extension.
2. Dampen a clean cloth with mineral spirits or equivalent solvent.
3. Wipe the cloth over the mast sections, removing any dirt.
4. Wipe dry with clean cloth before retracting.
5. Make the antenna go up and down by turning the radio or ignition on and off.
6. Then repeat if necessary.

NOTICE

Don't lubricate the power antenna. Lubrication could damage it.

NOTICE

Before entering an automatic vehicle wash, turn off your radio to make the power antenna go down. This will prevent the mast from possibly getting damaged. If the antenna does not go down when you turn the radio off, it may be damaged or need to be cleaned. In either case, lower the antenna by hand by carefully pressing the antenna down.

If the mast portion of your antenna is damaged, you can replace it. See your dealer for a replacement kit and follow the instructions in the kit.

The mast portion of the antenna can be replaced without removing the antenna assembly from the vehicle.

Notes



Here you'll find information about driving on different kinds of roads and in varying weather conditions. We've also included many other useful tips on driving.

Part 4 Your Driving and the Road

Road Signs	164
Defensive Driving	168
Drunken Driving	169
Control of a Vehicle	171
Braking	172
Anti-Lock Brakes (ABS)	173
ASR (Acceleration Slip Regulation) System	175
Steering Tips	179
Steering in Emergencies	180
Passing	181
Driving at Night	184
Driving in the Rain	186
Driving in Fog, Mist and Haze	189
City Driving	190
Freeway Driving	191
Driving a Long Distance	193
Hill and Mountain Roads	195
Parking on Hills	196
Winter Driving	198

Your Driving and the Road



STOP DO NOT ENTER WRONG WAY



RR ADVANCE CROSSING NARROW BRIDGE NO PASSING ZONE

■ Road Signs

The road signs you see everywhere are coded by color, shape and symbols. It's a good idea to know these codes so that you can quickly grasp the basic meaning or intent of the sign even before you have a chance to read it.

Color of Road Signs

Red means **Stop**. It may also indicate that some movement is not allowed. Examples are **Do Not Enter** and **Wrong Way**.



Green is used to guide the driver. Green signs may indicate upcoming freeway exits or show the direction you should turn to reach a particular place.

Yellow indicates a general warning. Slow down and be careful when you see a yellow sign. It may signal a railroad crossing ahead, a no passing zone, or some other potentially dangerous situation. Likewise, a yellow solid line painted on the road means **Don't Cross**.



HOSPITAL INFORMATION

Blue signs with white letters show motorists' services.

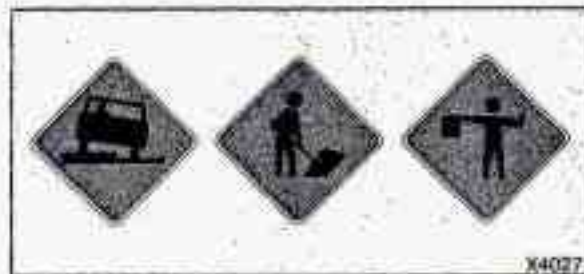

LOW
SHOULDER

WORKERS
AHEAD

FLAGGER
AHEAD

Orange indicates road construction or maintenance. You'll want to slow down when you see an orange sign, as part of the road may be closed off or torn up. And there may be workers and maintenance vehicles around, too.

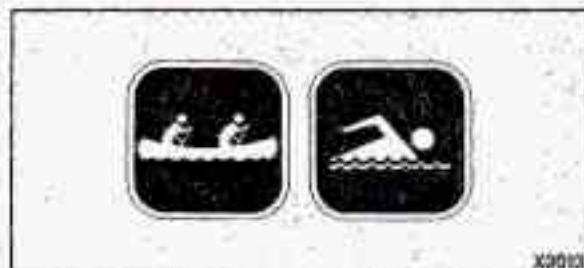

CANOEING

SWIMMING

Brown signs point out recreation areas or points of historic or cultural interest.



Shape of Road Signs

The shape of the sign will tell you something, too.

An **octagonal** (eight-sided) sign means **Stop**. It is always red with white letters.



A **triangle**, pointed downward, indicates **Yield**. It assigns the right of way to traffic on certain approaches to an intersection.

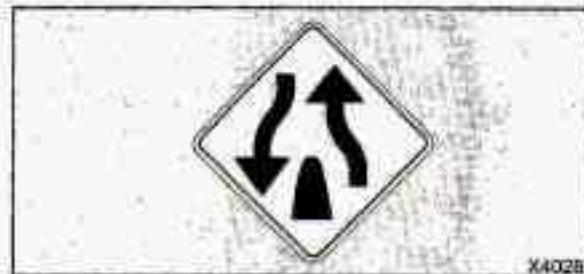

A **diamond**-shaped sign is a warning of something ahead—for example, a curve, steep hill, soft shoulder, or a narrow bridge.



A **triangular** sign also is used on two-lane roads to indicate a **No Passing Zone**. This sign will be on the left side of the roadway.

Your Driving and the Road

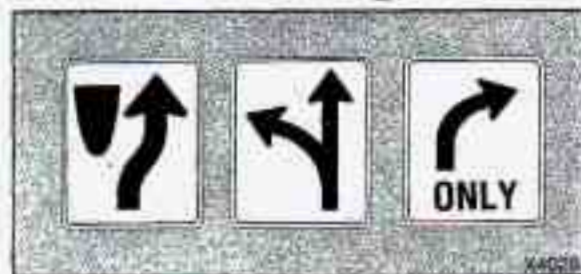

KEEP
RIGHT

LEFT OR
THROUGH

RIGHT TURN
ONLY

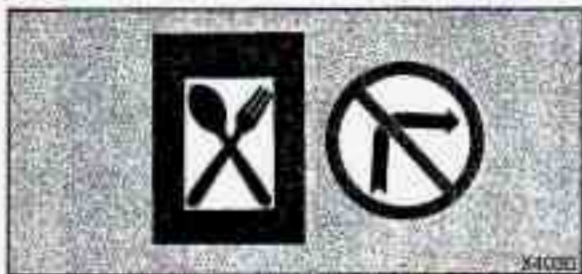

Shape of Road Signs (CONT.)

Rectangular (square or oblong) signs show speed limits, parking regulations, give directions, and such information as distances to cities.

Symbols on Road Signs

There are many international road signs in use today.

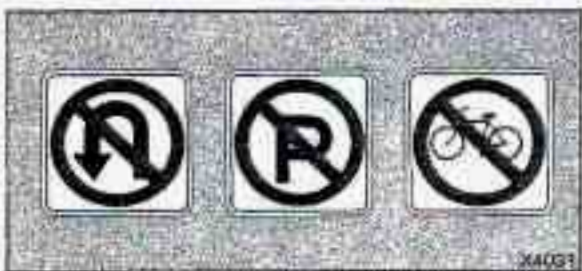

NO U
TURN

NO
PARKING

NO
BICYCLES

The basic message of many of these signs is in pictures or graphic symbols. A picture within a circle with a diagonal line across it shows what **not** to do.

Traffic Lights

We're all familiar with traffic lights or stop lights. Often green arrows are being used in the lights for improved traffic control. On some multilane roads, green arrows light up, indicating that traffic in one or more lanes can move or make a turn. Green arrows don't mean "go no matter what." You'll still need to proceed with caution, yielding the right of way to pedestrians and sometimes to other vehicles.

Some traffic lights also use red arrows to signify that you must stop before turning on red.

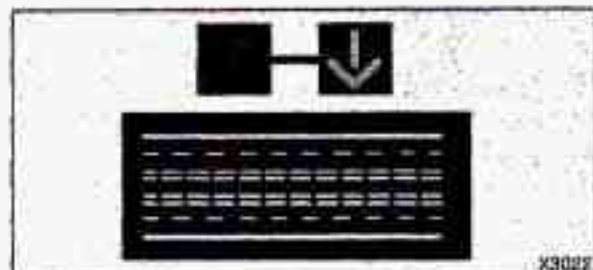

REVERSIBLE LANE ON MULTILANE ROADWAY

Many city roads and expressways, and even bridges, use reversible-lane traffic control during rush hours. A red X light above a lane means no driving in that lane at that time. A green arrow means you may drive in that lane. Look for the signs posted to warn drivers what hours and days these systems are in effect.

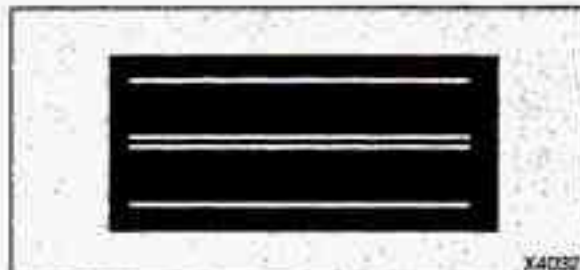

NO PASSING ZONE

Pavement Markings

Pavement markings add to traffic signs and signals. They give information to drivers without taking attention from the roadway. A solid yellow line on your side of the road or lane means **Don't Cross**.

Your Own Signals

Drivers signal to others, too. It's not only more polite, it's safer to let other drivers know what you are doing. And in some places the law requires driver signals.

Turn and Lane Change Signals:

Always signal when you plan to turn or change lanes.

If necessary, you can use hand signals out the window: Left arm straight out for a left turn, down for slow or about-to-stop, and up for a right turn.

Slowing Down: If time allows, tap the brake pedal once or twice in advance of slowing or stopping. This warns the driver behind you.

Disabled: Your four-way flashers signal that your vehicle is disabled or is a hazard. See the *Index* under *Hazard Warning Flashers*.

Traffic Officer

The traffic police officer is also a source of important information. The officer's signals govern, no matter what the traffic lights or other signs say.

The next section discusses some of the road conditions you may encounter.

Your Driving and the Road

Defensive Driving

The best advice anyone can give about driving is: Drive defensively.

Please start with a very important safety device in your Corvette: Buckle up. (See the *Index* under *Safety Belts*.)

Defensive driving really means "be ready for anything." On city streets, rural roads, or freeways, it means "always expect the unexpected."

Assume that pedestrians or other drivers are going to be careless and make mistakes. Anticipate what they might do. Be ready for their mistakes.

Expect children to dash out from behind parked cars, often followed by other children. Expect occupants in parked cars to open doors into traffic. Watch for movement in parked cars—someone may be about to open a door.

Expect other drivers to run stop signs when you are on a through street. Be ready to brake if necessary as you go through intersections. You may not have to use the brake, but if you do, you will be ready.

If you're driving through a shopping center parking lot where there are well-marked lanes, directional arrows, and designated parking areas, expect some drivers to ignore all these markings and dash straight toward one part of the lot. Pedestrians can be careless. Watch for them. In general, you must give way to pedestrians even if you know you have the right of way.

Rear-end collisions are about the most preventable of accidents. Yet they are common. Allow enough following distance. It's the best defensive driving

maneuver, in both city and rural driving. You never know when the vehicle in front of you is going to brake or turn suddenly.

Here's a final bit of information about defensive driving. The most dangerous time for driving in the U.S. is very early on Sunday morning. In fact, GM Research studies show that the most and the least dangerous times for driving, every week, fall on the same day. That day is Sunday. The most dangerous time is Sunday from 3 a.m. to 4 a.m. The safest time is Sunday from 10 a.m. to 11 a.m. Driving the same distance on a Sunday at 3 a.m. isn't just a little more dangerous than it is at 10 a.m. It's about 134 times more dangerous!

That leads to the next section.

Drunken Driving

Death and injury associated with drinking and driving is a national tragedy. It's the number one contributor to the highway death toll, claiming thousands of victims every year. Alcohol takes away three things that anyone needs to drive a vehicle:

- Judgment
- Muscular Coordination
- Vision

Police records show that half of all motor vehicle-related deaths involve alcohol—a driver, a passenger or someone else, such as a pedestrian, had been drinking. In most cases, these deaths are the result of someone who was drinking and driving. Over 25,000 motor vehicle-related deaths occur each year because of alcohol, and thousands of people are injured.

Just how much alcohol is too much if a person plans to drive? Ideally, no one should drink alcohol and then drive. But if one does, then what's "too much"? It can be a lot less than many might think. Although it depends on each person and situation, here is some general information on the problem.

The Blood Alcohol Content (BAC) of someone who is drinking depends upon four things:

- How much alcohol is in the drink.
- The drinker's body weight.
- The amount of food that is consumed before and during drinking.
- The length of time it has taken the drinker to consume the alcohol.



According to the American Medical Association, a 180-pound (82 kg) person who drinks three 12-ounce (355 ml) bottles of beer in an hour will end up with a BAC of about 0.06 percent. The person would reach the same BAC by drinking three 4-ounce (120 ml) glasses of wine or three mixed drinks if each had 1½ ounces (45 ml) of a liquor like whiskey, gin or vodka.

It's the amount of alcohol that counts. For example, if the same person drank three double martinis (3 ounces or 90 ml of liquor each) within an hour, the person's BAC would be close to 0.12 percent. A person who consumes food just before or during drinking will have a slightly lower BAC level.

Your Driving and the Road

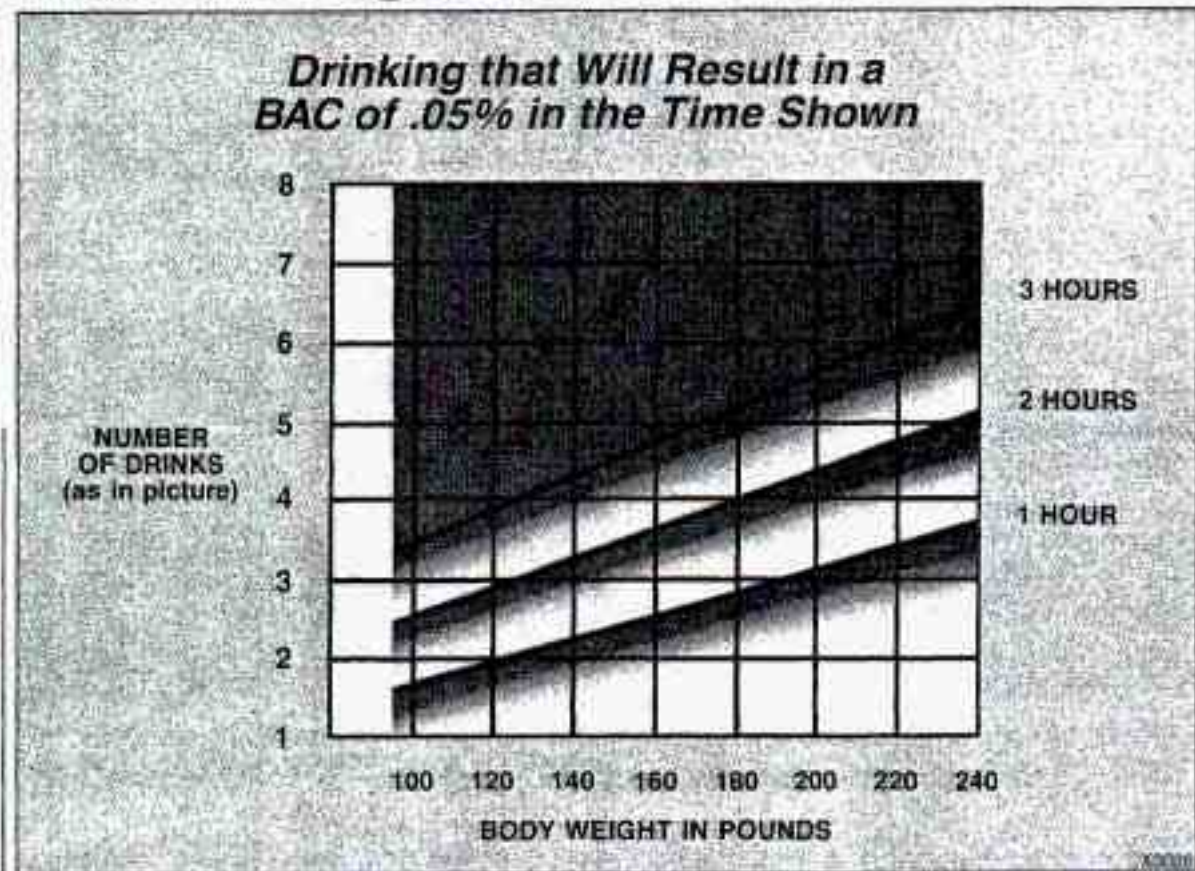

shows that the driving skills of many people are impaired at a BAC approaching 0.05 percent, and that the effects are worse at night. All drivers are impaired at BAC levels above 0.05 percent. Statistics show that the chance of being in an accident increases sharply for drivers who have a BAC of 0.05 percent or above. A driver with a BAC level of 0.06 percent (three beers in one hour for a 180-pound or 82 kg person) has doubled his or her chance of having an accident. At a BAC level of 0.10 percent, the chance of that driver having an accident is six times greater; at a level of 0.15 percent, the chances are twenty-five times greater! And, the body takes about an hour to rid itself of the alcohol in one drink. No amount of coffee or number of cold showers will speed that up.

Drunken Driving (CONT.)

The law in most U.S. states sets the legal limit at a BAC of 0.10 percent. In Canada the limit is 0.08 percent, and in some other countries it's lower than that. The BAC will be over 0.10 percent after three to six drinks (in one hour).

Of course, as we've seen, it depends on how much alcohol is in the drinks, and how quickly the person drinks them.

But it's very important to keep in mind that the ability to drive is affected well below a BAC of 0.10 percent. Research

"I'll be careful" isn't the right answer. What if there's an emergency, a need to take sudden action, as when a child darts into the street? A person with a higher BAC might not be able to react quickly enough to avoid the collision.

There's something else about drinking and driving that many people don't know. Medical research shows that alcohol in a person's system can make crash injuries worse. That's especially true for brain, spinal cord and heart injuries. That means that if anyone who has been drinking—driver or passenger—is in a crash, the chance of being killed or permanently disabled is higher than if that person had not been drinking. And we've already seen that the chance

of a crash itself is higher for drinking drivers.

CAUTION



Drinking and then driving is very dangerous. Your reflexes, perceptions, and judgment will be affected by even a small amount of alcohol. You could have a serious—or even fatal—accident if you drive after drinking. Please don't drink and drive or ride with a driver who has been drinking. Ride home in a cab; or if you're with a group, designate a driver who will not drink.

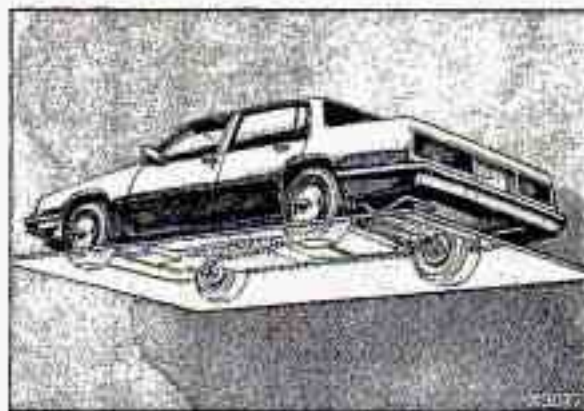

■ *Control of a Vehicle*

You have three systems that make your vehicle go where you want it to go. They are the brakes, the steering and the accelerator. All three systems have to do their work at the places where the tires meet the road.

Sometimes, as when you're driving on snow or ice, it's easy to ask more of those control systems than the tires and road can provide. That means you can lose control of your vehicle.

Your Driving and the Road

Braking

Braking action involves **perception time** and **reaction time**.

First, you have to decide to push on the brake pedal. That's **perception time**. Then you have to bring up your foot and do it. That's **reaction time**.

Average **reaction time** is about $\frac{3}{4}$ of a second. But that's only an average. It might be less with one driver and as long as two or three seconds or more with another. Age, physical condition, alertness, coordination, and eyesight all play a part. So do alcohol, drugs and frustration. But even in $\frac{3}{4}$ of a second, a vehicle moving at 60 mph (100 km/h) travels 66 feet (20 m). That could be a lot of distance in an emergency, so keeping enough space between your vehicle and others is important.

And, of course, actual stopping distances vary greatly with the surface of the road (whether it's pavement or gravel); the condition of the road (wet, dry, icy); tire tread; and the condition of your brakes.

Most drivers treat their brakes with care. Some, however, overwork the braking system with poor driving habits.

- Avoid needless heavy braking. Some people drive in spurts—heavy acceleration followed by heavy braking—rather than keeping pace with traffic. This is a mistake. Your brakes may not have time to cool between hard stops. Your brakes will wear out much faster if you do a lot of heavy braking.



- Don't "ride" the brakes by letting your left foot rest lightly on the brake pedal while driving.

CAUTION



"Riding" your brakes can cause them to overheat to the point that they won't work well. You might not be able to stop your vehicle in time to avoid an accident. If you "ride" your brakes, they will get so hot they will require a lot of pedal force to slow you down. Avoid "riding" the brakes.

NOTICE

"Riding" the brakes wears them out much faster. You would need costly brake replacement much sooner than normal, and it also reduces fuel economy.

If you keep pace with the traffic and allow realistic following distances, you will eliminate a lot of unnecessary braking. That means better braking and longer brake life.

- If your engine ever stops while you're driving, brake normally but don't pump your brakes. If you do, the pedal may get harder to push down. If your engine stops, you will still have some power brake assist. But you will use it when you brake. Once the power assist is used up, it may take longer to stop and the brake pedal will be harder to push.



Anti-Lock Brakes (ABS)

Your Corvette has an advanced electronic braking system that will help prevent skidding.

This light on the instrument panel will go on when you start your vehicle.

See the *Index* under *Anti-Lock Brake System Light*.

Your Driving and the Road



Anti-Lock Brakes (CONT.)

Here's how anti-lock works. Let's say the road is wet. You're driving safely. Suddenly an animal jumps out in front of you.

You slam on the brakes. Here's what happens with ABS.

A computer senses that wheels are slowing down. The computer separately works the brakes at each front wheel and at the rear wheels.

The anti-lock system can change the brake pressure faster than any driver could. The computer is programmed to make the most of available tire and road conditions.



You can steer around the obstacle while braking hard.

As you brake, your computer keeps receiving updates on wheel speed and controls braking pressure accordingly.

CAUTION



Anti-lock doesn't change the time you need to get your foot up to the brake pedal. If you get too close to the vehicle in front of you, you won't have time to apply your brakes if that vehicle suddenly slows or stops. Always leave enough room up ahead to stop, even though you have anti-lock brakes.

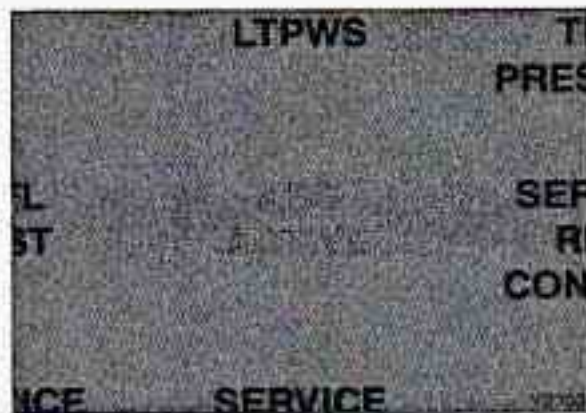

To Use Anti-Lock:

Don't pump the brakes. Just hold the brake pedal down and let anti-lock work for you. You may feel the brake pedal vibrate, or you may notice some noise, but this is normal.

When the ABS is active, the **ABS ACTIVE** light comes on to indicate low traction conditions. Adjust your driving accordingly.

When you start your vehicle and begin to drive away, you may hear a momentary motor or clicking noise and you may even notice that your brake pedal moves a little while this is going on. This is the ABS testing itself. You may also hear and feel this during a hard stop.

Corvette ASR (Acceleration Slip Regulation) System

Your vehicle has an ASR system that limits wheel spin. This is especially useful in slippery road conditions. The ASR system works at all speeds. It limits wheel spin by reducing engine torque by closing the throttle and managing spark and applying the rear brakes. You may feel the system working, or you may notice some noise, but this is normal.

Your Driving and the Road

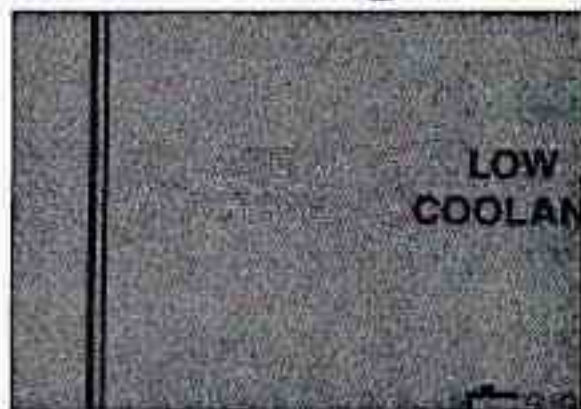

Corvette ASR System (CONT.)

The ASR system comes on when the ignition is turned on and operates at all speeds. When your ASR system is operating, the **ASR ACTIVE** indicator on the Driver Information Center (DIC) will come on. It indicates the system has detected excess wheel slip, like the conditions found on slippery roads. Also, when ASR is active, the cruise control will be automatically turned off.

The **SERVICE ASR** warning light lets you know when there is a problem with your ASR system. When this light is on, you have no automatic wheel spin protection. Adjust your driving accordingly. See the *Index* under *Service ASR Light*.

Turning the ASR System Off

To limit wheel spin, especially in slippery road conditions, you should always leave your ASR system on. But you can turn the ASR system off if you ever need to. **ASR OFF** means the controller is passive, but still monitoring wheel speed information.



To turn the system off, press the button located above the headlight switch. The **ASR OFF** light will come on and stay on. If you are driving and push the **ASR OFF** button, the ASR system will not be turned off until the rear wheels stabilize with the front wheels. Any time the ASR system is off, it can be switched on again. The **ASR OFF** light should go off. The ASR system automatically comes on whenever you start your vehicle.

NOTE: When ASR is active the cruise control will go off.

Disc Brake Wear Indicators

Your Corvette has four-wheel disc brakes. Disc brake pads have built-in wear indicators that make a high-pitched warning sound when the brake pads are worn and new pads are needed. The sound may come and go or be heard all the time your vehicle is moving (except when you are pushing on the brake pedal firmly).

CAUTION



The brake wear warning sound means that sooner or later your brakes won't work well. That could lead to an accident. When you hear the brake wear warning sound, have your vehicle serviced.

NOTICE

Continuing to drive with worn-out brake pads could result in costly brake repair.

Some driving conditions or climates may cause a brake squeal when the brakes are first applied or lightly applied. This does not mean something is wrong with your brakes.

Brake linings should always be replaced as complete axle sets.

Your Driving and the Road

Brake Pedal Travel

See your dealer if the brake pedal does not return to normal height, or if there is a rapid increase in pedal travel. This could be a sign of brake trouble.

Brake Adjustment

As you make brake stops, your disc brakes automatically adjust for wear.

Braking In Emergencies

Use your anti-lock braking system when you need to. With anti-lock, you can steer and brake at the same time. In many emergencies, steering can help you more than even the very best braking.

Power Steering

If you lose power steering assist because the engine stops or the system fails to function, you can steer but it will take much more effort.

Steering Tips—Driving on Curves

It's important to take curves at a reasonable speed.

A lot of the "driver lost control" accidents mentioned on the news happen on curves. Here's why:

Experienced driver or beginner, each of us is subject to the same laws of physics when driving on curves. The traction of the tires against the road surface makes it possible for the vehicle to change its path when you turn the front wheels. If there's no traction, inertia will keep the vehicle going in the same direction. If you've ever tried to steer a vehicle on wet ice, you'll understand this.

The traction you can get in a curve depends on the condition of your tires and the road surface, the angle at which the curve is banked, and your speed. While you're in a curve, speed is the one factor you can control.

Suppose you're steering through a sharp curve. Then you suddenly accelerate. If excess wheel spin is detected, ASR will reduce engine torque to the wheels. If your ASR system is off, those two control systems—steering and acceleration—can overwhelm those places where the tires meet the road and make you lose control.

What should you do if this ever happens? Let up on the accelerator pedal, steer the vehicle the way you want it to go, and slow down.

Your Driving and the Road

Steering Tips—Driving on Curves **(CONT.)**

Speed limit signs near curves warn that you should adjust your speed. Of course, the posted speeds are based on good weather and road conditions. Under less favorable conditions you'll want to go slower.

If you need to reduce your speed as you approach a curve, do it before you enter the curve, while your front wheels are straight ahead.

Try to adjust your speed so you can "drive" through the curve. Maintain a reasonable, steady speed. Wait to accelerate until you are out of the curve, and then accelerate gently into the straightaway.

When you drive into a curve at night, it's harder to see the road ahead of you because it bends away from the straight beams of your lights. This is one good reason to drive slower.



Steering in Emergencies

There are times when steering can be more effective than braking. For example, you come over a hill and find a truck stopped in your lane, or a car suddenly pulls out from nowhere, or a child darts out from between parked cars and stops right in front of you. You can avoid these problems by braking—if you can stop in time. But sometimes you can't; there isn't room. That's the time for evasive action—steering around the problem.

Your Corvette can perform very well in emergencies like these. First apply your brakes. It is better to remove as much speed as you can from a possible collision. Then steer around the

problem, to the left or right depending on the space available.

An emergency like this requires close attention and a quick decision. If you are holding the steering wheel at the recommended 9 and 3 o'clock positions, you can turn it a full 180 degrees very quickly without removing either hand. But you have to act fast, steer quickly, and just as quickly straighten the wheel once you have avoided the object. You must then be prepared to steer back to your original lane and then brake to a controlled stop.

Depending on your speed, this can be rather violent for an unprepared driver. This is one of the reasons driving experts recommend that you use your safety belts and keep both hands on the steering wheel.

The fact that such emergency situations are always possible is a good reason to practice defensive driving at all times.



Off-Road Recovery

You may find sometime that your right wheels have dropped off the edge of a road onto the shoulder while you're driving.

If the level of the shoulder is only slightly below the pavement, recovery should be fairly easy. Ease off the accelerator and then, if there is nothing in the way, steer so that your vehicle straddles the edge of the pavement. You can turn the steering wheel up to $\frac{1}{4}$ turn until the right front tire contacts the pavement edge. Then turn your steering wheel to go straight down the roadway.

If the shoulder appears to be about four inches (100 mm) or more below the pavement, this difference can cause

problems. If there is not enough room to pull entirely onto the shoulder and stop, then follow the same procedures. But if the right front tire scrubs against the side of the pavement, do **not** steer more sharply. With too much steering angle, the vehicle may jump back onto the road with so much steering input that it crosses over into the oncoming traffic before you can bring it back under control. Instead, ease off again on the accelerator and steering input, straddle the pavement once more, then try again.

Passing

The driver of a vehicle about to pass another on a two-lane highway waits for just the right moment, accelerates, moves around the vehicle ahead, then goes back into the right lane again. A simple maneuver?

Not necessarily! Passing another vehicle on a two-lane highway is a potentially dangerous move, since the passing vehicle occupies the same lane as oncoming traffic for several seconds. A miscalculation, an error in judgment, or a brief surrender to frustration or anger can suddenly put the passing driver face to face with the worst of all traffic accidents—the head-on collision.

So here are some tips for passing:

- "Drive ahead." Look down the road, to the sides, and to crossroads for situations that might affect your passing patterns. If you have any doubt whatsoever about making a successful pass, wait for a better time.

Your Driving and the Road

Passing (CONT.)

- Watch for traffic signs, pavement markings, and lines. If you can see a sign up ahead that might indicate a turn or an intersection, delay your pass. A broken center line usually indicates it's all right to pass (providing the road ahead is clear). Never cross a solid line on your side of the lane or a double solid line, even if the road seems empty of approaching traffic.
- If you suspect that the driver of the vehicle you want to pass isn't aware of your presence, tap the horn a couple of times before passing.
- Do not get too close to the vehicle you want to pass while you're awaiting an opportunity. For one thing, following too closely reduces your area of vision, especially if you're following a larger vehicle. Also, you won't have adequate space if the vehicle ahead suddenly slows or stops. Keep back a reasonable distance.
- When it looks like a chance to pass is coming up, start to accelerate but stay in the right lane and don't get too close. Time your move so you will be increasing speed as the time comes to move into the other lane. If the way is clear to pass, you will have a "running start" that more than makes up for the distance you would lose by dropping back. And if something happens to cause you to cancel your pass, you need only slow down and drop back again and wait for another opportunity.
- If other vehicles are lined up to pass a slow vehicle, wait your turn. But take care that someone isn't trying to pass you as you pull out to pass the slow vehicle. Remember to glance over your shoulder and check the blind spot.
- Check your mirrors, glance over your shoulder, and start your left lane change signal before moving out of the right lane to pass. When you are far enough ahead of the passed vehicle to see its front in your inside mirror, activate your right lane change signal and move back into the right lane. (Remember that your right outside mirror is convex. The vehicle you just passed may seem to be farther away from you than it really is.)
- Try not to pass more than one vehicle at a time on two-lane roads. Reconsider before passing the next vehicle.
- Don't overtake a slowly moving vehicle too rapidly. Even though the brake lights are not flashing, it may be slowing down or starting to turn.
- If you're being passed, make it easy for the following driver to get ahead of you. Perhaps you can ease a little to the right.

Loss of Control

Let's review what driving experts say about what happens when the three control systems (brakes, steering and acceleration) don't have enough friction where the tires meet the road to do what the driver has asked.

In any emergency, don't give up. Keep trying to steer and constantly seek an escape route or area of less danger.

Skidding

In a skid, a driver can lose control of the vehicle. Defensive drivers avoid most skids by taking reasonable care suited to existing conditions, and by not "overdriving" those conditions. But skids are always possible.

The three types of skids correspond to your Corvette's three control systems. In the braking skid your wheels aren't rolling. In the steering or cornering skid, too much speed or steering in a curve causes tires to slip and lose cornering force. And in the acceleration skid too much throttle causes the driving wheels to spin.

A cornering skid is best handled by easing your foot off the accelerator pedal. If your ASR traction control system is off, an acceleration skid is best handled in the same way. If your vehicle starts to slide (as when you turn

a corner on a wet, snow- or ice-covered road), ease your foot off the accelerator pedal as soon as you feel the vehicle start to slide. Quickly steer the way you want the vehicle to go. If you start steering quickly enough, your vehicle will straighten out. As it does, straighten the front wheels.

Of course, traction is reduced when water, snow, ice, gravel, or other material is on the road. For safety, you'll want to slow down and adjust your driving to these conditions. It is important to slow down on slippery surfaces because stopping distance will be longer and vehicle control more limited.

While driving on a surface with reduced traction, try your best to avoid sudden steering, acceleration, or braking

Your Driving and the Road



Skidding (CONT.)

(including engine braking by shifting to a lower gear). Any sudden change could cause the tires to slide. You may not realize the surface is slippery until your vehicle is skidding. Learn to recognize warning clues—such as enough water, ice or packed snow on the road to make a “mirrored surface”—and slow down when you have any doubt.

Remember: Any anti-lock braking system (ABS) helps avoid only the braking skid. Steer the way you want the vehicle to go.

Driving at Night

Night driving is more dangerous than day driving. One reason is that some drivers are likely to be impaired—by alcohol or drugs, with night vision problems, or by fatigue.

Here are some tips on night driving.

- Drive defensively. Remember, this is the most dangerous time.
- Don't drink and drive. (See the *Index* under *Drunken Driving* for more on this problem.)
- Adjust your inside rearview mirror to reduce the glare from headlights behind you.

- Since you can't see as well, you may need to slow down and keep more space between you and other vehicles. It's hard to tell how fast the vehicle ahead is going just by looking at its taillights.
- Slow down, especially on higher speed roads. Your headlights can light up only so much road ahead.
- In remote areas, watch for animals.
- If you're tired, pull off the road in a safe place and rest.

Night Vision

No one can see as well at night as in the daytime. But as we get older these differences increase. A 50-year-old driver may require at least twice as much light to see the same thing at night as a 20-year-old.

What you do in the daytime can also affect your night vision. For example, if you spend the day in bright sunshine you are wise to wear sunglasses. Your eyes will have less trouble adjusting to night.

But if you're driving, don't wear sunglasses at night. They may cut down on glare from headlights, but they also make a lot of things invisible that should remain visible—such as parked cars, obstacles, pedestrians, or even trains blocking railway crossings. You may want to put on your sunglasses after you have pulled into a brightly lighted service or refreshment area.

Eyes shielded from that glare may adjust more quickly to darkness back on the road. But be sure to remove your sunglasses before you leave the service area.

You can be temporarily blinded by approaching lights. It can take a second or two, or even several seconds, for your eyes to readjust to the dark. When you are faced with severe glare (as from a driver who doesn't lower the high beams, or a vehicle with misaimed headlights), slow down a little. Avoid staring directly into the approaching lights. If there is a line of opposing traffic, make occasional glances over the line of headlights to make certain that one of the vehicles isn't starting to move into your lane. Once you are past the bright lights, give your eyes time to readjust before resuming speed.

High Beams

If the vehicle approaching you has its high beams on, signal by flicking yours to high and then back to low beam. This is the usual signal to lower the headlight beams. If the other driver still doesn't lower the beams, resist the temptation to put your high beams on. This only makes two half-blinded drivers.

On a freeway, use your high beams only in remote areas where you won't impair approaching drivers. In some places, like cities, using high beams is illegal.

When you follow another vehicle on a freeway or highway, use low beams. True, most vehicles now have day-night mirrors that enable the driver to reduce glare. But outside mirrors are not of this type and high beams from behind can bother the driver ahead.

Your Driving and the Road

A Few More Night Driving Suggestions

Keep your windshield and all the glass on your vehicle clean—inside and out. Glare at night is made much worse by dirt on the glass. Even the inside of the glass can build up a film caused by dust. Tobacco smoke also makes inside glass surfaces very filmy and can be a vision hazard if it's left there.

Dirty glass makes lights dazzle and flash more than clean glass would, making the pupils of your eyes contract repeatedly. You might even want to keep a cloth and some glass cleaner in your vehicle if you need to clean your glass frequently.

Remember that your headlights light up far less of a roadway when you are in a turn or curve.

Keep your eyes moving; that way, it's easier to pick out dimly lighted objects.

Just as your headlights should be checked regularly for proper aim, so should your eyes be examined regularly. Some drivers suffer from night blindness—the inability to see in dim light—and aren't even aware of it.



Driving in the Rain

Rain and wet roads can mean driving trouble. On a wet road you can't stop, accelerate or turn as well because your tire-to-road traction isn't as good as on dry roads. And, if your tires don't have much tread left, you'll get even less traction.

It's always wise to go slower and be cautious if rain starts to fall while you are driving. The surface may get wet suddenly when your reflexes are tuned for driving on dry pavement.

The heavier the rain, the harder it is to see. Even if your windshield wiper blades are in good shape, a heavy rain can make it harder to see road signs and traffic signals, pavement markings, the edge of the road, and even people

walking. Road spray can often be worse for vision than rain, especially if it comes from a dirty road.

So it is wise to keep your wiping equipment in good shape and keep your windshield washer tank filled. Replace your windshield wiper inserts when they show signs of streaking or missing areas on the windshield, or when strips of rubber start to separate from the inserts.



Driving too fast through large water puddles or even going through some vehicle washes can cause problems, too. The water may affect your brakes. Try to avoid puddles. But if you can't, try to slow down before you hit them.

CAUTION



Wet brakes can cause accidents. They won't work well in a quick stop and may cause pulling to one side. You could lose control of the vehicle.

After driving through a large puddle of water or a vehicle wash, apply your brake pedal lightly until your brakes work normally.

Your Driving and the Road

Hydroplaning

Hydroplaning is dangerous. So much water can build up under your tires that they can actually ride on the water. This can happen if the road is wet enough and you're going fast enough. When your vehicle is hydroplaning, it has little or no contact with the road.

You might not be aware of hydroplaning. You could drive along for some time without realizing your tires aren't in constant contact with the road. You could find out the hard way: when you have to slow, turn, move out to pass—or if you get hit by a gust of wind. You could suddenly find yourself out of control.

Hydroplaning doesn't happen often. But it can if your tires haven't much tread or if the pressure in one or more is low. It can happen if a lot of water is standing on the road. If you can see reflections from trees, telephone poles, or other vehicles, and raindrops "dimple" the water's surface, there could be hydroplaning.

Hydroplaning usually happens at higher speeds. There just isn't a hard and fast rule about hydroplaning. The best advice is to slow down when it is raining, and be careful.

Some Other Rainy Weather Tips

- Turn on your headlights—not just your parking lights—to help make you more visible to others.
- Look for hard-to-see vehicles coming from behind. You may want to use your headlights even in daytime if it's raining hard.
- Besides slowing down, allow some extra following distance. And be especially careful when you pass another vehicle. Allow yourself more clear room ahead, and be prepared to have your view restricted by road spray. If the road spray is so heavy you are actually blinded, drop back. Don't pass until conditions improve. Going more slowly is better than having an accident.
- Use your defogger if it helps.
- Have good tires with proper tread depth. (See the *Index* under *Tires*.)



Driving in Fog, Mist and Haze

Fog can occur with high humidity or heavy frost. It can be so mild that you can see through it for several hundred feet (meters). Or it might be so thick that you can see only a few feet (meters) ahead. It may come suddenly to an otherwise clear road. And it can be a major hazard.

When you drive into a fog patch, your visibility will be reduced quickly. The biggest dangers are striking the vehicle ahead or being struck by the one behind. Try to "read" the fog density down the road. If the vehicle ahead starts to become less clear or, at night, if the taillights are harder to see, the fog is probably thickening. Slow down to give traffic behind you a chance to slow down.

Everybody then has a better chance to avoid hitting the vehicle ahead.

A patch of dense fog may extend only for a few feet (meters) or for miles (kilometers); you can't really tell while you're in it. You can only treat the situation with extreme care.

One common fog condition—sometimes called mist or ground fog—can happen in weather that seems perfect, especially at night or in the early morning in valley and low, marshy areas. You can be suddenly enveloped in thick, wet haze that may even coat your windshield. You can often spot these fog patches or mist layers with your headlights. But sometimes they can be waiting for you as you come over a hill or dip into a shallow valley. Start your windshield wipers and washer to help clear accumulated road dirt. Slow down carefully.

Tips on Driving in Fog

If you get caught in fog, turn your headlights on low beam, even in daytime. You'll see—and be seen—better. Use your fog lights.

Don't use your high beams. The light will bounce off the water droplets that make up fog and reflect back at you.

Use your defogger. In high humidity, even a light buildup of moisture on the inside of the glass will cut down on your already limited visibility. Run your windshield wipers and washer occasionally. Moisture can build up on the outside glass, and what seems to be fog may actually be moisture on the outside of your windshield.

Treat dense fog as an emergency. Try to find a place to pull off the road. Of course you want to respect another's property, but you might need to put

Your Driving and the Road



Tips on Driving in Fog (CONT.)

something between you and moving vehicles—space, trees, telephone poles, a private driveway, anything that removes you from other traffic.

If visibility is near zero and you must stop but are unsure whether you are away from the road, turn your lights on, start your hazard warning flashers, and sound your horn at intervals or when you hear approaching traffic.

Pass other vehicles in fog only if you can see far enough ahead to pass safely. Even then, be prepared to delay your pass if you suspect the fog is worse up ahead. If other vehicles try to pass you, make it easy for them.

City Driving

One of the biggest problems with city streets is the amount of traffic on them. You'll want to watch out for what the other drivers are doing and pay attention to traffic signals.

Here are ways to increase your safety in city driving:

- Know the best way to get to where you are going. Try not to drive around trying to pick out a familiar street or landmark. Get a city map and plan your trip into an unknown part of the city just as you would for a cross-country trip.
 - Try to use the freeways that rim and crisscross most large cities. You'll save time and energy. (See the next section, *Freeway Driving*.)
- Treat a green light as a warning signal. A traffic light is there because the corner is busy enough to need it. When a light turns green, and just before you start to move, check both ways for vehicles that have not cleared the intersection or may be running the red light.
 - Obey all posted speed limits. But remember that they are for ideal road, weather and visibility conditions. You may need to drive below the posted limit in bad weather or when visibility is especially poor.
 - Pull to the right (with care) and stop clear of intersections when you see or hear emergency vehicles.

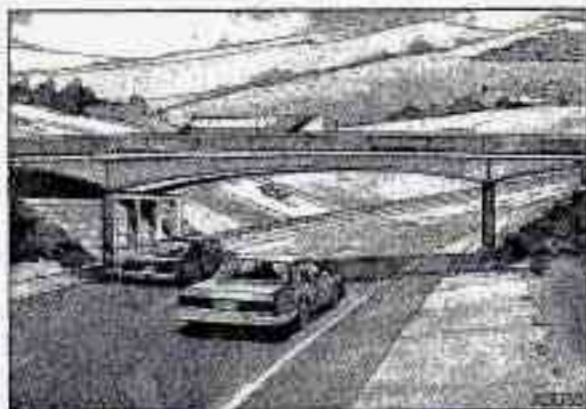

Freeway Driving

Mile for mile, freeways (also called thruways, parkways, expressways, turnpikes, or superhighways) are the safest of all roads. But they have their own special rules.

The most important advice on freeway driving is: **Keep up with traffic and keep to the right.** Drive at the same speed most of the other drivers are driving. Too-fast or too-slow driving breaks a smooth traffic flow. Treat the left lane on a freeway as a passing lane.

Entering the Freeway

At the entrance there is usually a ramp that leads to the freeway. If you have a clear view of the freeway as you drive along the entrance ramp, you should begin to check traffic. Try to determine where you expect to blend with the flow. If traffic is light, you may have no problem. But if it is heavy, find a gap as you move along the entering lane and time your approach. Try to merge into the gap at close to the prevailing speed. Switch on your turn signal, check your rearview mirrors as you move along, and glance over your shoulder as often as necessary. Try to blend smoothly with the traffic flow.

Driving on the Freeway

Once you are on the freeway, adjust your speed to the posted limit or to the prevailing rate if it's slower. Stay in the right lane unless you want to pass. If you are on a two-lane freeway, treat the right lane as the slow lane and the left lane as the passing lane.

If you are on a three-lane freeway, treat the right lane as the slower-speed through lane, the middle lane as the higher-speed through lane, and the left lane as the passing lane.

Before changing lanes, check your rearview mirrors. Then use your turn signal. Just before you leave the lane, glance quickly over your shoulder to make sure there isn't another vehicle in your "blind" spot.

Your Driving and the Road

Driving on the Freeway (CONT.)

If you are moving from an outside to a center lane on a freeway having more than two lanes, make sure another vehicle isn't about to move into the same spot. Look at the vehicles two lanes over and watch for telltale signs: turn signals flashing, an increase in speed, or moving toward the edge of the lane. Be prepared to delay your move.

Once you are moving on the freeway, make certain you allow a reasonable following distance. Expect to move slightly slower at night.

Leaving the Freeway

When you want to leave the freeway, move to the proper lane well in advance. Dashing across lanes at the last minute is dangerous. If you miss your exit do not, under any circumstances, stop and back up. Drive on to the next exit.

At each exit point is a deceleration lane. Ideally it should be long enough for you to enter it at freeway speed (after signaling, of course) and then do your braking before moving onto the exit ramp. Unfortunately, not all deceleration lanes are long enough—some are too short for all the braking. Decide when to start braking. If you must brake on the through lane, and if

there is traffic close behind you, you can allow a little extra time and flash your brake lights (in addition to your turn signal) as extra warning that you are about to slow down and exit.

The exit ramp can be curved, sometimes quite sharply. The exit speed is usually posted. Reduce your speed according to your speedometer, not to your sense of motion. After driving for any distance at higher speeds, you may tend to think you are going slower than you actually are. For example, 40 mph (65 km/h) might seem like only 20 mph (32 km/h). Obviously, this could lead to serious trouble on a ramp designed for 20 mph (32 km/h)!

Driving a Long Distance

Although most long trips today are made on freeways, there are still many made on regular highways.

Long-distance driving on freeways and regular highways is the same in some ways. The trip has to be planned and the vehicle prepared, you drive at higher-than-city speeds, and there are longer turns behind the wheel. You'll enjoy your trip more if you and your vehicle are in good shape. Here are some tips for a successful long trip.

Before Leaving on a Long Trip

Make sure you're ready. Try to be well rested. If you must start when you're not fresh—such as after a day's work—don't plan to make too many miles that first part of the journey. Wear comfortable clothing and shoes you can easily drive in.

Is your vehicle ready for a long trip? If you keep it serviced and maintained, it's ready to go. If it needs service, have it done before starting out. Of course, you'll find experienced and able service experts in Chevrolet dealerships all across North America. They'll be ready and willing to help if you need it.

Here are some things you can check before a trip:

- **Windshield Washer Fluid:** Is the reservoir full? Are all windows clean inside and outside?
- **Wiper Blades:** Are they in good shape?
- **Fuel, Engine Oil, Other Fluids:** Have you checked all levels?
- **Lights:** Are they all working? Are the lenses clean?
- **Tires:** They are vitally important to a safe, trouble-free trip. Is the tread good enough for long-distance driving? Are the tires all inflated to the recommended pressure?
- **Weather Forecasts:** What's the weather outlook along your route? Should you delay your trip a short time to avoid a major storm system?
- **Maps:** Do you have up-to-date maps?

Your Driving and the Road

On the Road

Unless you are the only driver, it is good to share the driving task with others. Limit turns behind the wheel to about 100 miles (160 km) or two hours at a sitting. Then, either change drivers or stop for some refreshment like coffee, tea or soft drinks and some limbering up. But do stop and move around. Eat lightly along the way. Heavier meals tend to make some people sleepy.

On two-lane highways or undivided multilane highways that do not have controlled access, you'll want to watch for some situations not usually found on freeways. Examples are: stop signs and signals, shopping centers with direct access to the highway, no passing zones and school zones, vehicles turning left and right off the road, pedestrians, cyclists, parked vehicles, and even animals.

Highway Hypnosis

Is there actually such a condition as "highway hypnosis"? Or is it just plain falling asleep at the wheel? Call it highway hypnosis, lack of awareness, or whatever.

There is something about an easy stretch of road with the same scenery, along with the hum of the tires on the road, the drone of the engine, and the rush of the wind against the vehicle that can make you sleepy. Don't let it happen to you! If it does, your vehicle can leave the road in **less than a second**, and you could crash and be injured.

What can you do about highway hypnosis? First, be aware that it can happen.

Then here are some tips:

- Make sure your vehicle is well ventilated, with a comfortably cool interior.

- Keep your eyes moving. Scan the road ahead and to the sides. Check your rearview mirrors frequently and your instruments from time to time. This can help you avoid a fixed stare.
- Wear good sunglasses in bright light. Glare can cause drowsiness. But don't wear sunglasses at night. They will drastically reduce your overall vision at the very time you need all the seeing power you have.
- If you get sleepy, pull off the road into a rest, service, or parking area and take a nap, get some exercise, or both. For safety, treat drowsiness on the highway as an emergency.

As in any driving situation, keep pace with traffic and allow adequate following distances.



Hill and Mountain Roads

Driving on steep hills or mountains is different from driving in flat or rolling terrain. If you drive regularly in steep country, or if you're planning to visit there, here are some tips that can make your trips safer and more enjoyable.

- Keep your vehicle in good shape. Check all fluid levels and also the brakes, tires, cooling system and transmission. These parts can work hard on mountain roads.
- Know how to go down hills. The most important thing to know is this: Let your engine do some of the slowing down. Don't make your brakes do it all. Shift to a lower gear when you go down a steep or long hill. That way, you will slow down without excessive use of your brakes.

CAUTION



If you don't shift down, your brakes could get so hot that they wouldn't work well. You would then have poor braking or even none going down a hill. You could crash. Shift down to let your engine assist your brakes on a steep downhill slope.

CAUTION



Coasting downhill in N (Neutral) or with the ignition off is dangerous. Your brakes will have to do all the work of slowing down. They could get so hot that they wouldn't work well. You could crash. Always have your engine running and your vehicle in gear when you go downhill.

- Know how to go uphill. You may want to shift down to a lower gear. The lower gears help cool your engine and transmission, and you can climb the hill better.
- Stay in your own lane when driving on two-lane roads in hills or mountains. Don't swing wide or cut across the center of the road. Drive at speeds that let you stay in your own lane. That way, you won't be surprised by a vehicle coming toward you in the same lane.
- It takes longer to pass another vehicle when you're going uphill. You'll want to leave extra room to pass. If a vehicle is passing you and doesn't have enough room, slow down to make it easier for the other vehicle to get by.

Your Driving and the Road



Hill and Mountain Roads (CONT.)

- As you go over the top of a hill, be alert. There could be something in your lane, like a stalled car or an accident.
- You may see highway signs on mountains that warn of special problems. Examples are long grades, passing or no passing zones, a falling rocks area, or winding roads. Be alert to these and take appropriate action.
- Winter driving can present special problems. See the *Index* under *Winter Driving*.

Parking on Hills

Hills and mountains mean spectacular scenery. But please be careful where you stop if you decide to look at the view or take pictures. Look for pull-offs or parking areas provided for scenic viewing.

Another part of this manual tells how to use your parking brake (see the *Index* under *Parking Brake*). But on a mountain or steep hill, you can do one more thing. You can turn your front wheels to keep your vehicle from rolling downhill or out into traffic.

Here's how:

Parking Downhill

Turn your wheels to the right.

You don't have to jam your tires against the curb, if there is a curb. A gentle contact is all you need.

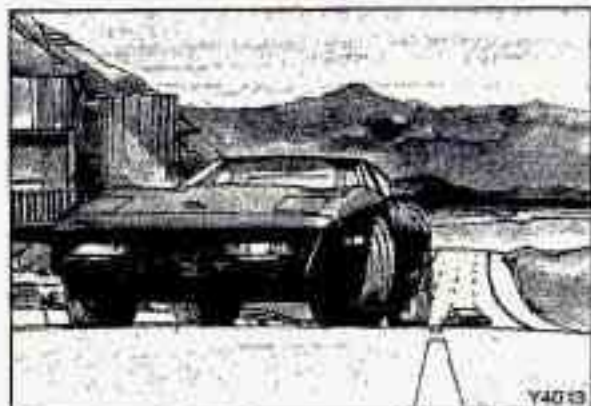

Parking Uphill

If there is a curb, turn your wheels to the left if the curb is at the right side of your vehicle.

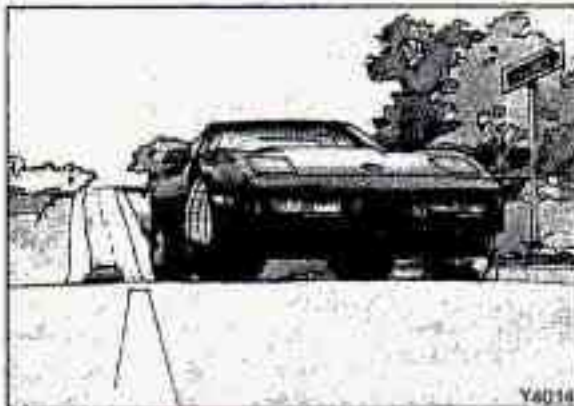

If you're going uphill on a one-way street and you're parking on the left side, your wheels should point to the right.



If there is no curb when you're parking uphill, turn the wheels to the right.
If there is no curb when you're parking uphill on the left side of a one-way street, your wheels should be turned to the left.

Your Driving and the Road



Torque Lock

(AUTOMATIC TRANSMISSION)

If you are parking on a hill and you don't shift your transmission into **P** (Park) properly, the weight of the vehicle may put too much force on the parking pawl in the transmission. You may find it difficult to pull the shift lever out of **P** (Park). This is called "torque lock." To prevent torque lock, always be sure to shift into **P** (Park) properly before you leave the driver's seat. To find out how, see the *Index* under *Shifting Into P (Park)*.

When you are ready to drive, move the shift lever out of **P** (Park) **before** you release the parking brake.

If torque lock does occur, you may need to have another vehicle push yours a little uphill to take some of the pressure from the transmission, so you can pull the shift lever out of **P** (Park).

Winter Driving

Here are some tips for winter driving:

- Have your Corvette in good shape for winter. Be sure your engine coolant mix is correct.
- Snow tires can help in loose snow, but they may give you less traction on ice than regular tires. If you do not expect to be driving in deep snow, but may have to travel over ice, you may not want to switch to snow tires at all.

- You may want to put winter emergency supplies in your vehicle.

Include an ice scraper, a small brush or broom, a supply of windshield washer fluid, a rag, some winter outer clothing, a small shovel, a flashlight, a red cloth, and a couple of reflective warning triangles. And, if you will be driving under severe conditions, include a small bag of sand, a piece of old carpet or a couple of burlap bags to help provide traction. Be sure you properly secure these items in your vehicle.



Driving on Snow or Ice

Most of the time, those places where your tires meet the road probably have good traction.

However, if there is snow or ice between your tires and the road, you can have a very slippery situation. You'll have a lot less traction or "grip" and will need to be very careful.

What's the worst time for this? "Wet ice." Very cold snow or ice can be slick and hard to drive on. But wet ice can be even more trouble because it may offer the least traction of all. You can get wet ice when it's about freezing (32°F, 0°C) and freezing rain begins to fall. Try to avoid driving on wet ice until salt and sand crews can get there.

Whatever the condition—smooth ice, packed, blowing or loose snow—drive with caution. Also, keep your ASR system on when driving on ice and snow. Accelerate gently. Try not to break the fragile traction. If you accelerate too fast, the drive wheels will spin and polish the surface under the tires even more.

Your ASR system improves your ability to accelerate when driving on a slippery road. Even though your vehicle has the ASR system, you'll want to slow down and adjust your driving to the road conditions. See the *Index* under *Acceleration Slip Regulation (ASR) System*.

Your anti-lock brakes improve your ability to make a hard stop on a slippery road. Even though you have the anti-lock braking system, you'll want to begin stopping sooner than you would on dry pavement. See the *Index* under *Anti-Lock Brake System (ABS)*.

- Allow greater following distance on any slippery road.
- Watch for slippery spots. The road might be fine until you hit a spot that's covered with ice. On an otherwise clear road, ice patches may appear in shaded areas where the sun can't reach: around clumps of trees, behind buildings, or under bridges. Sometimes the surface of a curve or an overpass may remain icy when the surrounding roads are clear. If you see a patch of ice ahead of you, brake before you are on it. Try not to brake while you're actually on the ice, and avoid sudden steering maneuvers.

Your Driving and the Road



If You're Caught in a Blizzard

If you are stopped by heavy snow, you could be in a serious situation. You should probably stay with your vehicle unless you know for sure that you are near help and you can hike through the snow. Here are some things to do to summon help and keep yourself and your passengers safe:

- Turn on your hazard flashers.
- Tie a red cloth to your vehicle to alert police that you've been stopped by the snow.

- Put on extra clothing or wrap a blanket around you. If you have no blankets or extra clothing, make body insulators from newspapers, burlap bags, rags, floor mats—anything you can wrap around yourself or tuck under your clothing to keep warm.
- You can run the engine to keep warm, but be careful.



CAUTION



Snow can trap exhaust gases under your vehicle. This can cause deadly CO (carbon monoxide) gas to get inside. CO could overcome you and kill you. You can't see it or smell it, so you might not know it was in your vehicle. Clear away snow from around the base of your vehicle, especially any that is blocking your exhaust pipe. And check around again from time to time to be sure snow doesn't collect there.

Open a window just a little on the side of the vehicle that's away from the wind. This will help keep CO out.

Run your engine only as long as you must. This saves fuel. When you run the engine, make it go a little faster than just idle. That is, push the accelerator slightly. This uses less fuel for the heat that you get and it keeps the battery charged. You will need a well-charged battery to restart the vehicle, and possibly for signaling later on with your headlights. Let the heater run for a while.

Then, shut the engine off and close the window almost all the way to preserve the heat. Start the engine again and repeat this only when you feel really uncomfortable from the cold. But do it as little as possible. Preserve the fuel as long as you can. To help keep warm, you can get out of the vehicle and do some fairly vigorous exercises every half-hour or so until help comes.

If You're Stuck in Deep Snow

You should turn your ASR system off if you're stuck in deep snow. See the *Index* under *Acceleration Slip Regulation (ASR) System*. This manual explains how to get the vehicle out of deep snow without damaging it. See the *Index* under *Rocking Your Vehicle*.

Towing a Trailer

Your Corvette is neither designed nor intended to tow a trailer.



Notes



Part 5 Problems on the Road

Here you'll find what to do about some problems that can occur on the road.

Hazard Warning Flashers	204
Jump Starting	205
Towing Your Corvette	208
Engine Overheating	213
If a Tire Goes Flat	224
Changing a Flat Tire	225
Compact Spare Tire	236
If You're Stuck: In Sand, Mud, Ice or Snow	237

Problems on the Road



Hazard Warning Flashers

Your hazard warning flashers let you warn others. They also let police know you have a problem. Your front and rear turn signal lights will flash on and off.



Press the button in to make your front and rear turn signal lights flash on and off.

Your hazard warning flashers work no matter what position your key is in, and even if the key isn't in.



To turn off the flashers, pull out on the collar.

When the hazard warning flashers are on, your turn signals won't work.

Other Warning Devices

If you carry reflective triangles, you can set one up at the side of the road about 300 feet (100 m) behind your vehicle.

Jump Starting

If your battery has run down, you may want to use another vehicle and some jumper cables to start your Corvette. But please follow the steps here to do it safely.

CAUTION



Batteries can hurt you. They can be dangerous because:

- They contain **acid** that can burn you.
- They contain **gas** that can explode or ignite.
- They contain enough **electricity** to burn you.

If you don't follow these steps exactly, some or all of these things can hurt you.

NOTICE

Ignoring these steps could result in costly damage to your vehicle that wouldn't be covered by your warranty.

Trying to start your Corvette by pushing or pulling it could damage your vehicle, even if you have a manual transmission. And if you have an automatic transmission, it won't start that way.

To Jump Start Your Corvette:

1. Check the other vehicle. It must have a 12-volt battery with a negative ground system.

NOTICE

If the other system isn't a 12-volt system with a negative ground, both vehicles can be damaged.

2. Get the vehicles close enough so the jumper cables can reach, but be sure the vehicles aren't touching each other. If they are, it could cause a ground connection you don't want. You wouldn't be able to start your Corvette, and the bad grounding could damage the electrical systems.

Problems on the Road

Jump Starting (CONT.)

CAUTION



You could be injured if the vehicles roll. Set the parking brake firmly on each vehicle. Put an automatic transmission in **P** (Park) or a manual transmission in **N** (Neutral).

3. Turn off the ignition on both vehicles. Turn off all lights that aren't needed, and radios. This will avoid sparks and help save both batteries. And it could save your radio!

NOTICE

If you leave your radio on, it could be badly damaged. The repairs wouldn't be covered by your warranty.

4. Open the hoods and locate the batteries.

CAUTION



An electric fan can start up even when the engine is not running and can injure you. Keep hands, clothing and tools away from any underhood electric fan.

Find the positive (+) and negative (-) terminals on each battery.

CAUTION



Using a match near a battery can cause battery gas to explode. People have been hurt doing this, and some have been blinded. Use a flashlight if you need more light.

Be sure the battery has enough water. You don't need to add water to the Delco Freedom[®] battery installed in every new GM vehicle. But if a battery has filler caps, be sure the right amount of fluid is there. If it is low, add water to take care of that first. If you don't, explosive gas could be present.

Battery fluid contains acid that can burn you. Don't get it on you. If you accidentally get it in your eyes or on your skin, flush the place with water and get medical help immediately.

5. Check that the jumper cables don't have loose or missing insulation. If they do, you could get a shock. The vehicles could be damaged, too.

Before you connect the cables, here are some things you should know. Positive (+) will go to positive (+) and negative (-) will go to negative (-) or a metal engine part. Don't connect (+) to (-) or you'll get a short that would damage the battery and maybe other parts, too.

CAUTION



Fans or other moving engine parts can injure you badly.

Keep your hands away from moving parts once the engines are running.

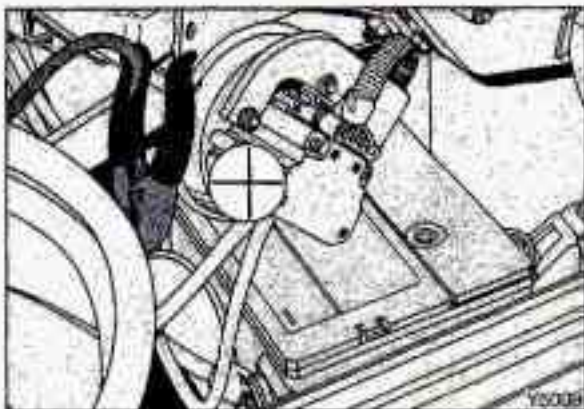

6. Connect the red positive (+) cable to the positive (+) terminal of the vehicle with the dead battery. Use a remote positive (+) terminal if the vehicle has one.

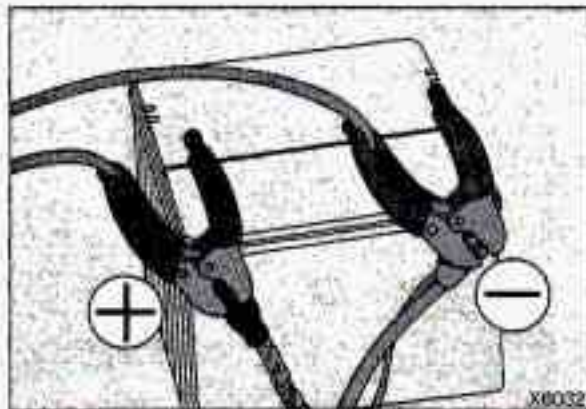

7. Don't let the other end touch metal. Connect it to the positive (+) terminal of the good battery. Use a remote positive (+) terminal if the vehicle has one.

8. Now connect the black negative (-) cable to the good battery's negative (-) terminal.

Don't let the other end touch anything until the next step. The other end of the negative cable **doesn't** go to the dead battery. It goes to a heavy unpainted metal part on the engine of the vehicle with the dead battery.

Problems on the Road

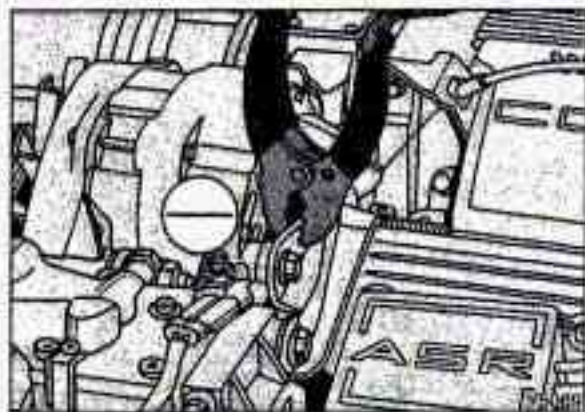

Jump Starting (CONT.)

9. Attach the cable at least 18 inches (45 cm) away from the dead battery, but not near engine parts that move. The electrical connection is just as good there, but the chance of sparks getting back to the battery is much less.
10. Now start the vehicle with the good battery and run the engine for a while.
11. Try to start the vehicle with the dead battery.
If it won't start after a few tries, it probably needs service.

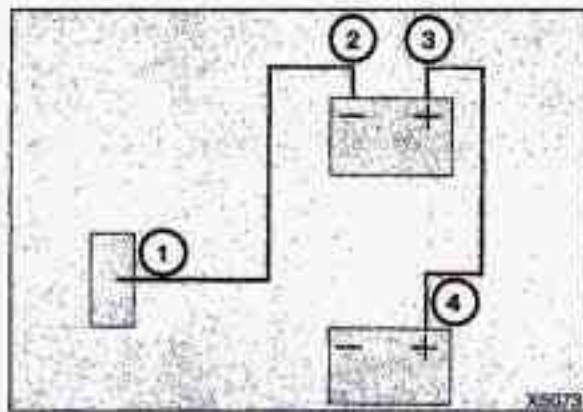

12. Remove the cables in reverse order (as shown in this diagram) to prevent electrical shorting. Take care that they don't touch each other or any other metal.

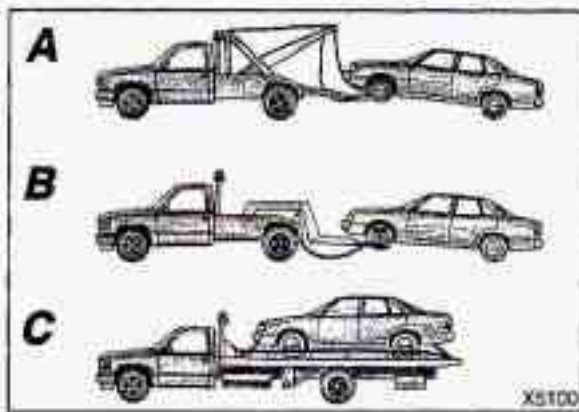

Towing Your Corvette

Try to have a GM dealer or a professional towing service tow your Corvette. The usual towing equipment is:

- (A) Sling-type tow truck
- (B) Wheel-lift tow truck
- (C) Car carrier

If your vehicle has been changed or modified since it was factory-new by adding aftermarket items like fog lamps, aero skirting, or special tires and wheels, these instructions and illustrations may not be correct. Before you do anything, turn on the hazard warning flashers.

When you call, tell the towing service:

- That your vehicle cannot be towed from the rear with sling-type equipment.
- That your vehicle has rear-wheel drive.
- The make, model, and year of your vehicle.

- Whether you can still move the shift lever.
- If there was an accident, what was damaged.

When the towing service arrives, let the tow operator know that this manual contains detailed towing instructions and illustrations.

The operator may want to see them.

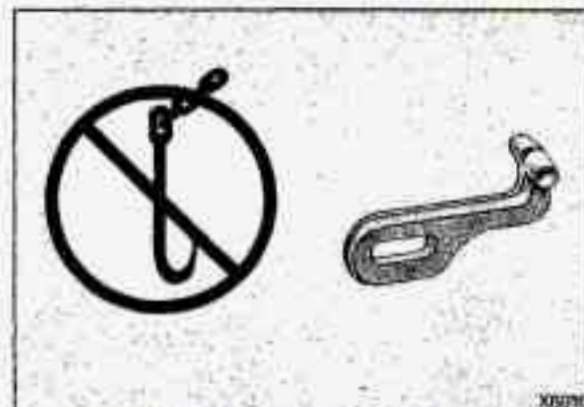

CAUTION



To help avoid injury to you or others:

- Never let passengers ride in a vehicle that is being towed.
- Never tow faster than safe or posted speeds.
- Never tow with damaged parts not fully secured.
- Never get under your vehicle after it has been lifted by the tow truck.
- Always use separate safety chains on each side when towing a vehicle.
- Never use "J" hooks. Use T-hooks instead.

Problems on the Road

Towing Your Corvette (CONT.)

When your vehicle is being towed, have the ignition key off. The steering wheel should be clamped in a straight-ahead position, with a clamping device designed for towing service. Do not use the vehicle's steering column lock for this. The transmission should be in **N** (Neutral), and the parking brake released.

Don't have your vehicle towed on the rear wheels, unless you must. If the vehicle must be towed on the rear wheels, don't go more than 35 mph

(56 km/h) or farther than 50 miles (80 km) or your transmission will be damaged. Go slow over rough ground, and position one wheel at a time (angled 45°) if you have to go over curbs and rises. Wheels at the lifted end should be at least 4 inches (10 cm) above the ground. If these limits must be exceeded, then the rear wheels have to be supported on a dolly.

CAUTION



A vehicle can fall from a car carrier if it isn't properly secured. This can cause a collision, serious personal injury and vehicle damage. The vehicle should be tightly secured with chains or steel cables before it is transported.

Don't use substitutes (ropes, leather straps, canvas webbing, etc.) that can be cut by sharp edges underneath the towed vehicle.

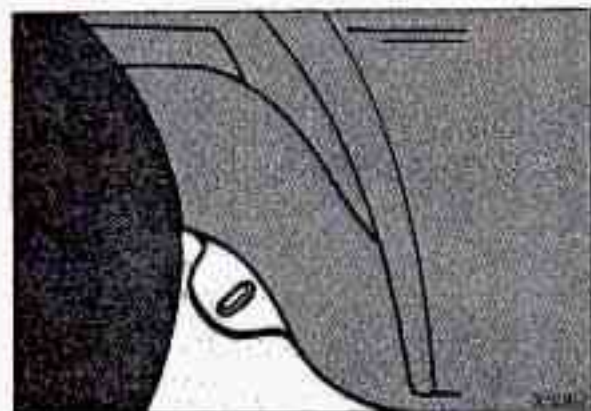

Towing from the Front— Vehicle Hook-Up

Before hooking up to a tow truck, be sure to read all the information on *Towing Your Corvette* earlier in this section.

1. Attach T-hook chains on both sides in the slotted holes behind and just inboard of the front wheels.

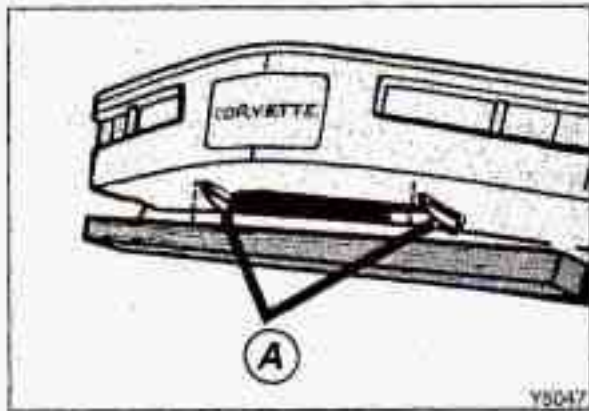

2. Position a 4x4 wooden beam across the sling chains contacting under the fascia just forward of the curb protect brackets (A).

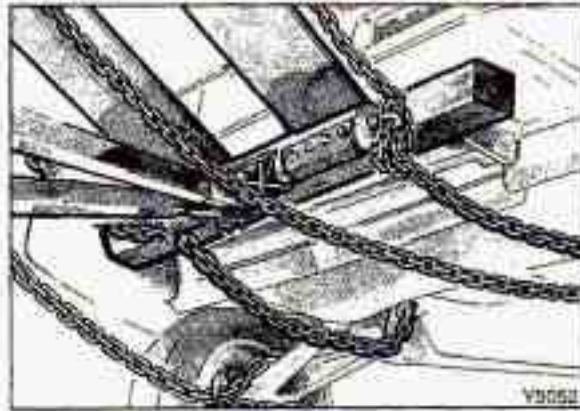

3. Position the sling crossbar against the front of the 4x4 beam.

Problems on the Road

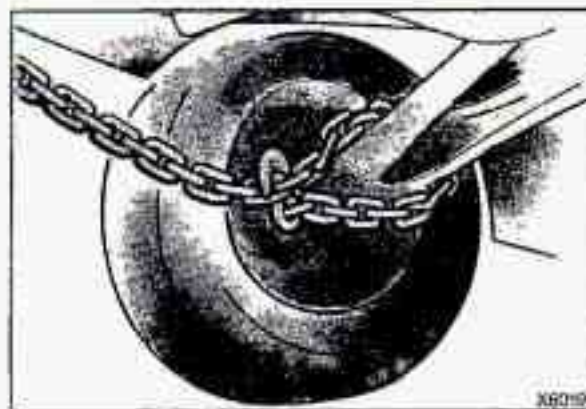

Towing from the Front— Vehicle Hook-Up (CONT.)

4. Attach a separate safety chain around the outboard end of each lower control arm.

Towing from the Rear— Vehicle Hook-Up

Before hooking up to a tow truck, be sure to read all the information on *Towing Your Corvette* earlier in this section. Also be sure to use the proper hook-up for your particular vehicle.

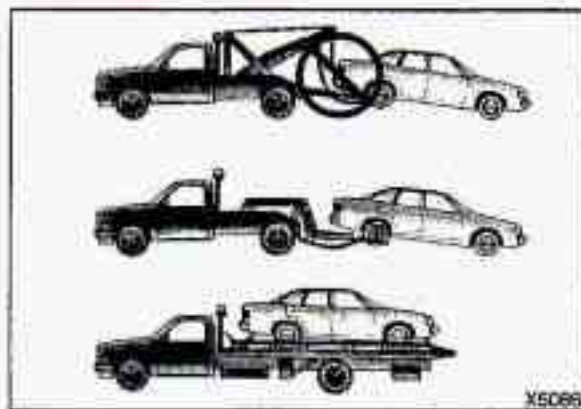

NOTICE

Do not tow with sling-type equipment or rear bumper valance will be damaged. Use wheel-lift or car carrier equipment (additional ramping may be required for car carrier equipment). Use safety chains and wheel straps.

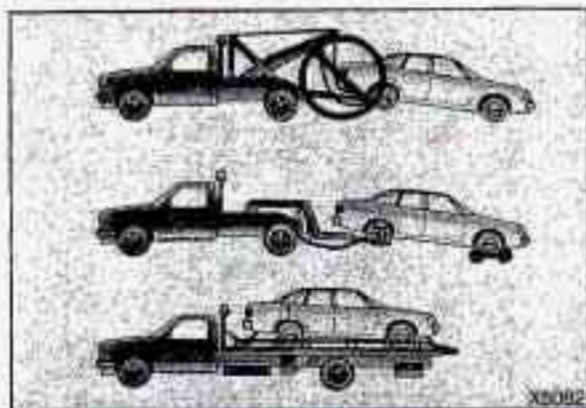

NOTICE

When using wheel-lift equipment, towing over rough surfaces can damage a vehicle. To help avoid this, install a towing dolly beneath the wheels that would otherwise be on the ground during the tow. This will increase clearance between the wheel-lift equipment and the underbody of the towed vehicle.

■ Engine Overheating

You will find an engine coolant temperature gage on the instrument cluster and a low coolant warning light on the Driver Information Center.



If Steam is Coming from Your Engine:

CAUTION



Steam from an overheated engine can burn you badly, even if you just open the hood. Stay away from the engine if you see or hear steam coming from it. Just turn it off and get everyone away from the vehicle until it cools down. Wait until there is no sign of steam or coolant before opening the hood.

If you keep driving when your engine is overheated, the liquids in it can catch fire. You or others could be badly burned. Stop your engine if it overheats, and get out of the vehicle until the engine is cool.

Problems on the Road

■ *Engine Overheating (Cont.)*

NOTICE

If your engine catches fire because you keep driving with no coolant, your vehicle can be badly damaged. The costly repairs would not be covered by your warranty.

If No Steam is Coming from Your Engine:

If you get the overheat warning but see or hear no steam, the problem may not be too serious. Sometimes the engine can get a little too hot when you:

- Climb a long hill on a hot day.
- Stop after high speed driving.
- Idle for long periods in traffic.

If you get the overheat warning with no sign of steam, try this for a minute or so:

1. Turn off your air conditioner.
2. Turn on your heater to full hot at the highest fan speed and open the window as necessary.
3. Try to keep your engine under load (in a drive gear where the engine runs slower).

If you no longer have the overheat warning, you can drive. Just to be safe, drive slower for about ten minutes. If the warning doesn't come back on, you can drive normally.

If the warning continues, pull over, stop, and park your vehicle right away.

If there's still no sign of steam, you can idle the engine for two or three minutes while you're parked, to see if the warning stops. But then, if you still have the warning, **TURN OFF THE ENGINE AND GET EVERYONE OUT OF THE VEHICLE** until it cools down.

You may decide not to lift the hood but to get service help right away.

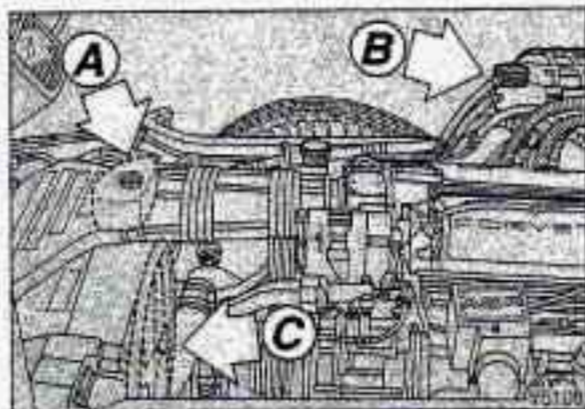

Cooling System

When you decide it's safe to lift the hood, here's what you'll see:

- (A) Coolant recovery tank
- (B) Coolant high fill reservoir with pressure cap
- (C) Electric engine fans

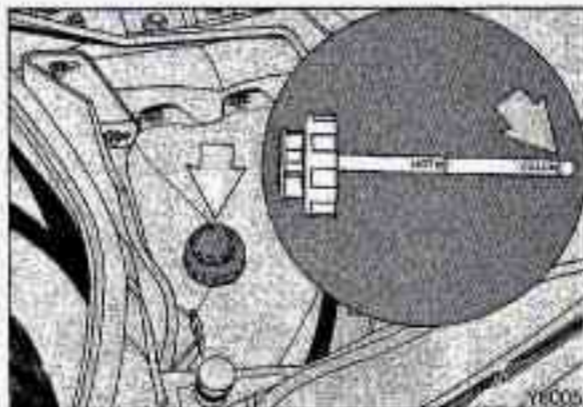

CAUTION



The electric fans under the hood can start up even when the engine is not running and can injure you. Keep hands, clothing and tools away from any underhood electric fan.

If the coolant inside the coolant recovery tank is boiling, don't do anything else until it cools down.

When it is cool, remove the coolant recovery tank cap and look at the dipstick. The coolant level should be at or above **COLD**.

If it isn't, you may have a leak in the radiator hoses, heater hoses, radiator, water pump, vapor vent pipes or hoses or coolant pump.

Problems on the Road

■ *Engine Overheating (Cont.)*

CAUTION



Heater and radiator hoses, and other engine parts, can be very hot. Don't touch them. If you do, you can be burned.

Don't run the engine if there is a leak. If you run the engine, it could lose all coolant. That could cause an engine fire, and you could be burned. Get any leak fixed before you drive the vehicle.

NOTICE

Engine damage from running your engine without coolant isn't covered by your warranty.

If there seems to be no leak, check to see if the electric engine fans are running. If the engine is overheating, both fans should be running. If they aren't, your vehicle needs service.

How to Add Coolant to the Coolant Recovery Tank

If you haven't found a problem yet, but the coolant level isn't at or above **COLD**, add a 50/50 mixture of **clean water** (preferably distilled) and a proper antifreeze at the coolant recovery tank. (See the *Index* under *Coolant* for more information about the proper coolant mix.)

CAUTION



Adding only plain water to your cooling system can be dangerous. Plain water, or some other liquid like alcohol, can boil before the proper coolant mix will. Your vehicle's coolant warning system is set for the proper coolant mix. With plain water or the wrong mix, your engine could get too hot but you wouldn't get the overheat warning. Your engine could catch fire and you or others could be burned. Use a 50/50 mix of **clean water** and a proper antifreeze.

NOTICE

In cold weather, water can freeze and crack the engine, radiator, heater core and other parts. Use the recommended coolant.

CAUTION



You can be burned if you spill coolant on hot engine parts. Coolant contains ethylene glycol and it will burn if the engine parts are hot enough. Don't spill coolant on a hot engine.

When the coolant in the coolant recovery tank is at or above **COLD**, start your vehicle.

If the overheat warning continues, there's one more thing you can try. You can add the proper coolant mix directly to the coolant high fill reservoir, but be sure the cooling system is cool before you do it.

Problems on the Road



How to Add Coolant to the Coolant Recovery Tank (CONT.)

CAUTION

 Steam and scalding liquids from a hot cooling system can blow out and burn you badly. They are under pressure, and if you turn the coolant high fill reservoir pressure cap—even a little—they can come out at high speed. Never turn the cap when the cooling system, including the coolant high fill reservoir pressure cap, is hot. Wait for the cooling system and coolant high fill reservoir pressure cap to cool if you ever have to turn the pressure cap.

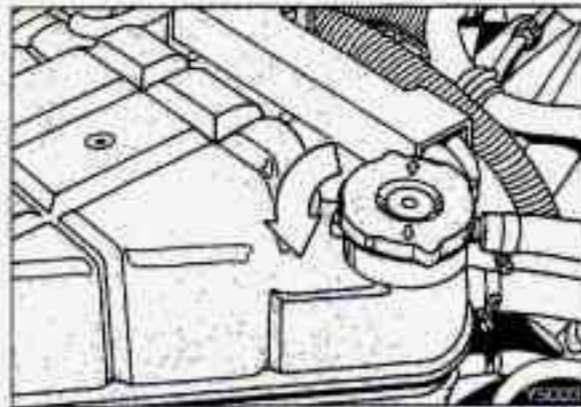

How to Add Coolant to the Coolant High Fill Reservoir—LT1 Only

NOTICE

The LT1 Engine has a specific coolant high fill reservoir fill procedure. Failure to follow this procedure could cause your engine to overheat and be severely damaged.

1. You can remove the coolant high fill reservoir pressure cap when the cooling system, including the coolant high fill reservoir pressure cap and upper radiator hose, is no longer hot. Turn the cap slowly to the left until it first stops. (Don't press down while turning the pressure cap.)

If you hear a hiss, wait for that to stop. A hiss means there is still some pressure left.

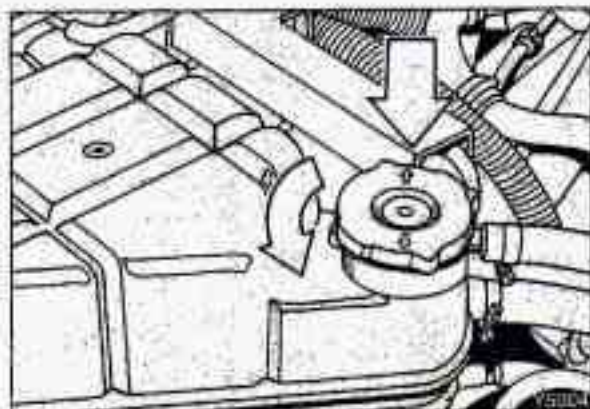

2. Then keep turning the pressure cap, but now push down as you turn it. Remove the pressure cap.

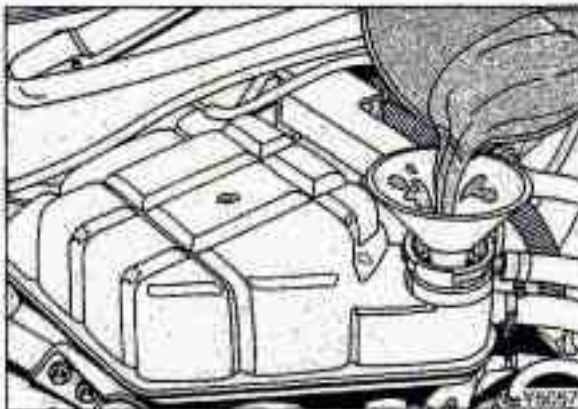

3. Fill the coolant high fill reservoir with the proper mix, up to the base of the filler neck.

CAUTION



You can be burned if you spill coolant on hot engine parts. Coolant contains ethylene glycol and it will burn if the engine parts are hot enough. Don't spill coolant on a hot engine.

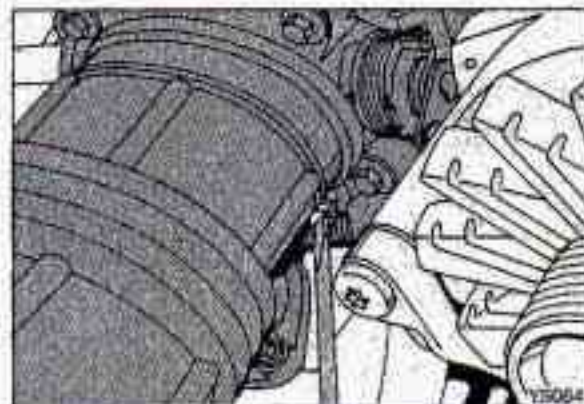
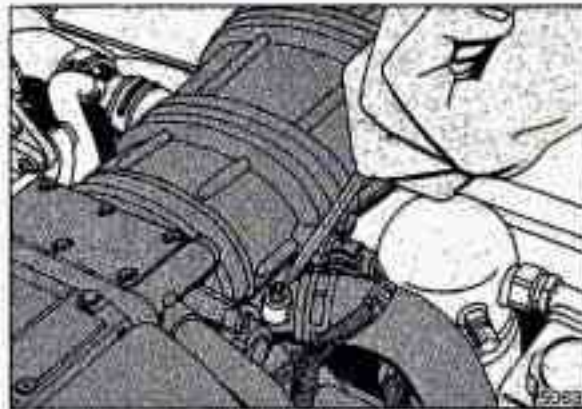

4. After the engine cools, open the air bleed valves on the throttle body and water pump inlet.

Problems on the Road



How to Add Coolant to the Coolant High Fill Reservoir—LT1 Only (CONT.)

5. Begin to fill the coolant high fill reservoir with the proper mix.

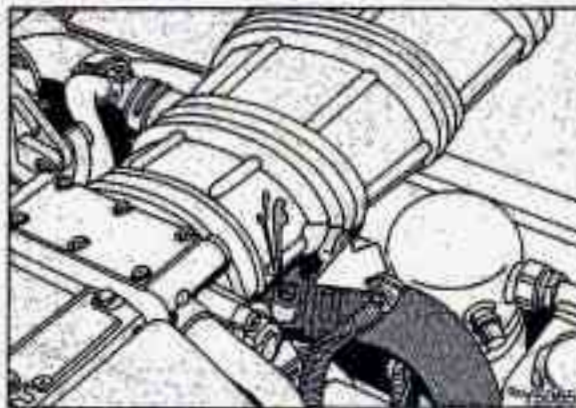

6. Add coolant to the coolant high fill reservoir until you see a steady stream of coolant coming from the bleed valves. Then close the bleed valves.

7. Continue to fill the coolant high fill reservoir up to the base of the filler neck.



8. Rinse or wipe the spilled coolant from the engine and compartment.

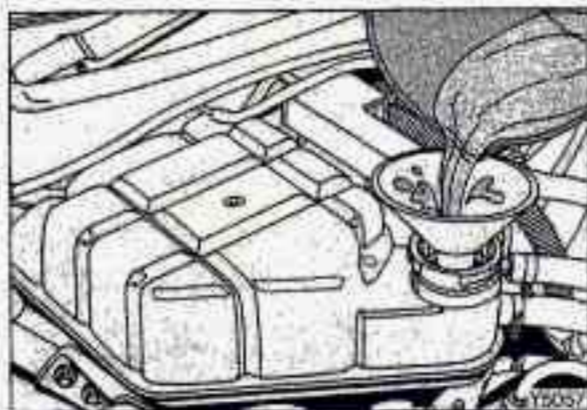

9. Start the engine and allow it to run in idle for approximately four minutes. By this time, the coolant level inside the coolant high fill reservoir will be lower. Add more of the proper mix through the filler neck until the level reaches the base of the filler neck.

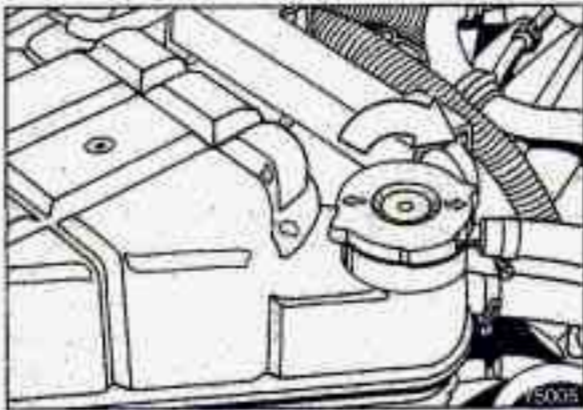

10. Shut the engine off and replace the pressure cap. Be sure the arrows on the cap line up as shown above.

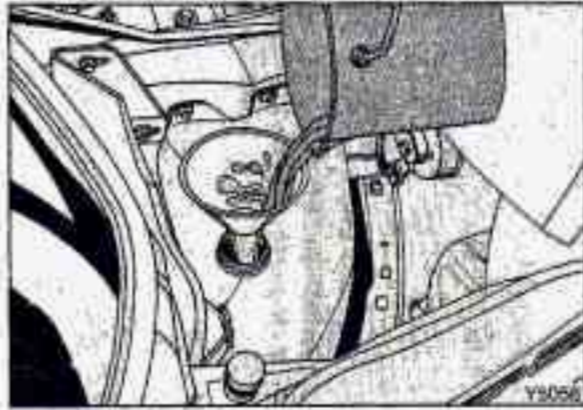

11. Then fill the coolant recovery tank to the **HOT** mark on the dipstick. Be sure to put the cap back on the coolant recovery tank.

For a complete drain, flush and refill, see your Chevrolet dealer or a Chevrolet Corvette Service Manual. To purchase a service manual, see the *Index* under *Service Publications*.

Problems on the Road

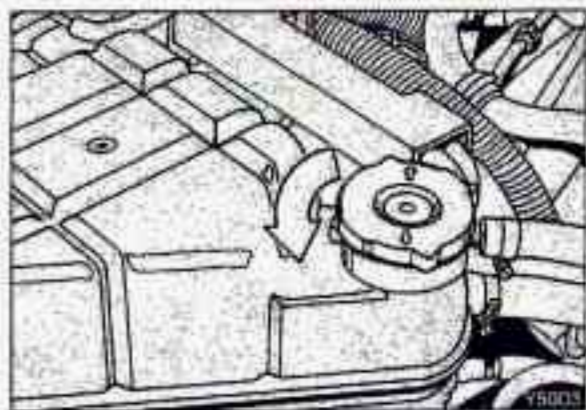

How to Add Coolant to the Coolant High Fill Reservoir—LT5 Only

1. You can remove the coolant high fill reservoir pressure cap when the cooling system, including the coolant high fill reservoir pressure cap and upper radiator hose, is no longer hot. Turn the pressure cap slowly to the left until it first stops. (Don't press down while turning the pressure cap.)

If you hear a hiss, wait for that to stop. A hiss means there is still some pressure left.

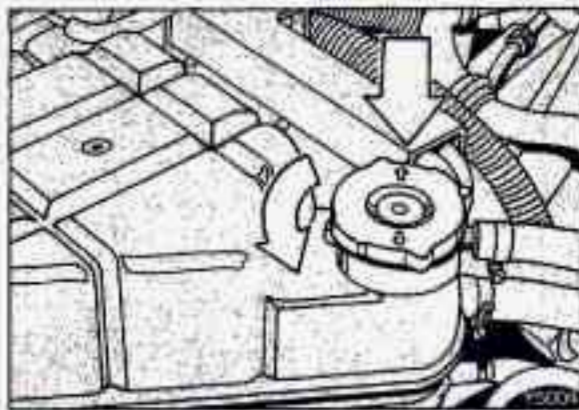

2. Then keep turning the pressure cap, but now push down as you turn it. Remove the pressure cap.

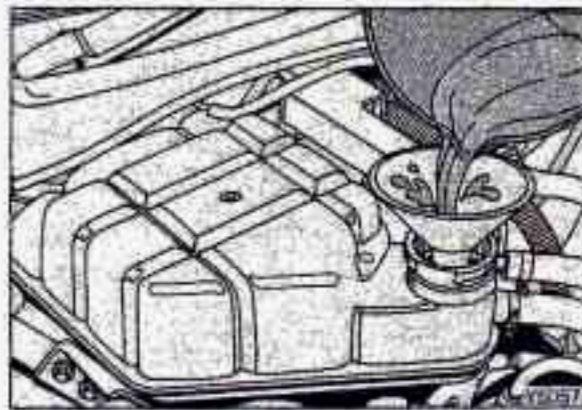

3. Fill the coolant high fill reservoir with the proper mix, up to the base of the filler neck.

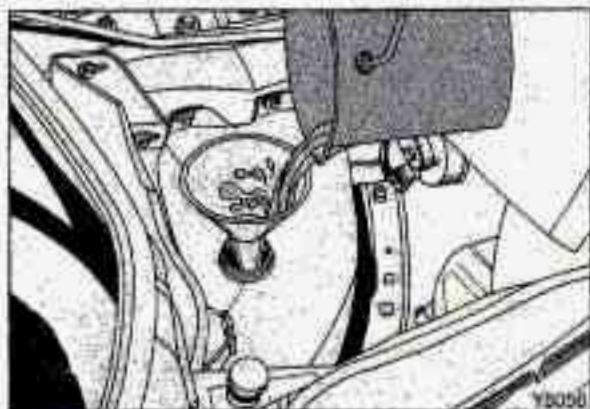

4. Then fill the coolant recovery tank to the **HOT** mark on the dipstick.

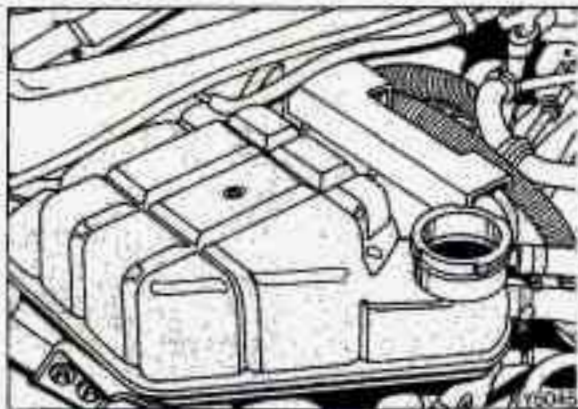

5. Put the cap back on the coolant recovery tank, but leave the coolant high fill reservoir pressure cap off.



6. Start the engine and let it run until you can feel the upper radiator hose getting hot. Watch out for the engine fans.

7. By this time the coolant level inside the coolant high fill reservoir filler neck may be lower. If the level is lower, add more of the proper mix through the filler neck until the level reaches the base of the filler neck.

Problems on the Road

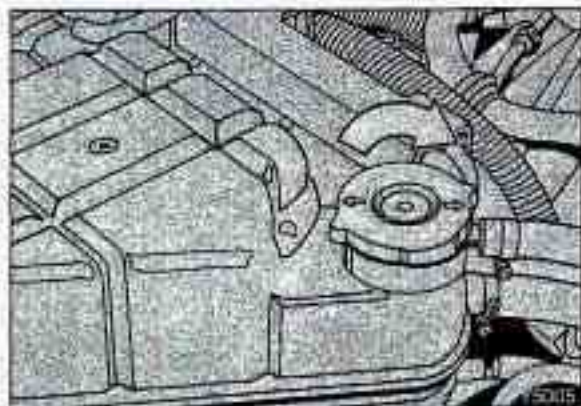

How to Add Coolant to the Coolant High Fill Reservoir—LT5 Only (CONT.)

8. Then replace the pressure cap. Be sure the arrows on the pressure cap line up as shown above.

If a Tire Goes Flat

It's unusual for a tire to "blow out" while you're driving, especially if you maintain your tires properly. If air goes out of a tire, it's much more likely to leak out slowly. But if you should ever have a "blowout," here are a few tips about what to expect and what to do:

If a front tire fails, the flat tire will create a drag that pulls the vehicle toward that side. Take your foot off the accelerator pedal and grip the steering wheel firmly. Steer to maintain lane position, then gently brake to a stop well out of the traffic lane.

A rear blowout, particularly on a curve, acts much like a skid and may require the same correction you'd use in a skid.

In any rear blowout, remove your foot from the accelerator pedal. Get the vehicle under control by steering the way you want the vehicle to go. It may be very bumpy and noisy, but you can still steer. Gently brake to a stop, well off the road if possible.

If your tire goes flat, the next section shows how to use your jacking equipment to change a flat tire safely.



Changing a Flat Tire

If a tire goes flat, avoid further tire and wheel damage by driving slowly to a level place. Turn on your hazard warning flashers.

CAUTION



Changing a tire can cause an injury. The vehicle can slip off the jack and roll over you or other people. You and they could be badly injured. Find a level place to change your tire. To help prevent the vehicle from moving:

1. Set the parking brake firmly.
2. Put the shift lever in **P** (Park).
3. Shift a manual transmission to **1** or **R** (Reverse).
4. Turn off the engine.

To be even more certain the vehicle won't move, you can put chocks at the front and rear of the tire farthest away from the one being changed. That would be the tire on the other side of the vehicle, at the opposite end.

Problems on the Road

Changing a Flat Tire (CONT.)

The following steps will tell you how to use the jack and change a tire.

The equipment you'll need is behind the driver's seat and in the spare tire carrier at the rear of the vehicle.

Special Wheel Nut Socket

If you have your wheels removed by your dealership, tire repair shop or any garage, make sure you give the service technician the special wheel nut socket and wheel lock key located in your center storage console. The socket can be used in conjunction with any air tool, torque wrench, or other mechanical device used to remove tires and wheels.

NOTICE

Your wheels could be damaged if this special socket is not used to remove your Corvette's wheels.

Always use the special wheel nut socket when using the wheel wrench provided with your vehicle. See the *Index* under *Center Storage Console*.

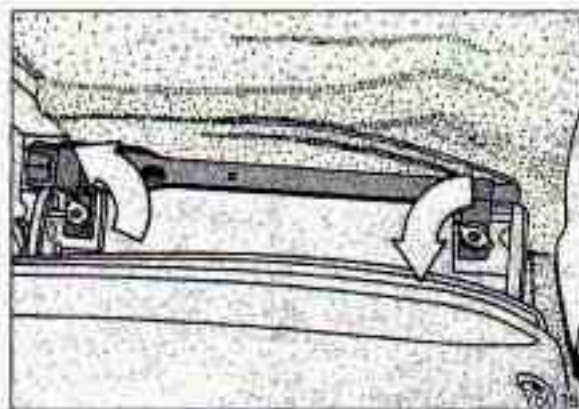

1. Move the driver's seat forward. The wheel wrench is on the floor behind the seat. The wheel lock key is stored in the center storage console.

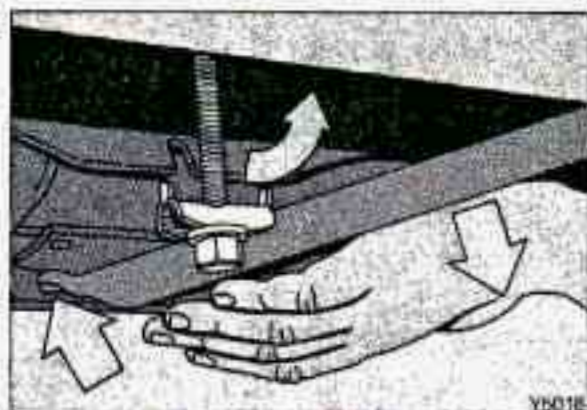
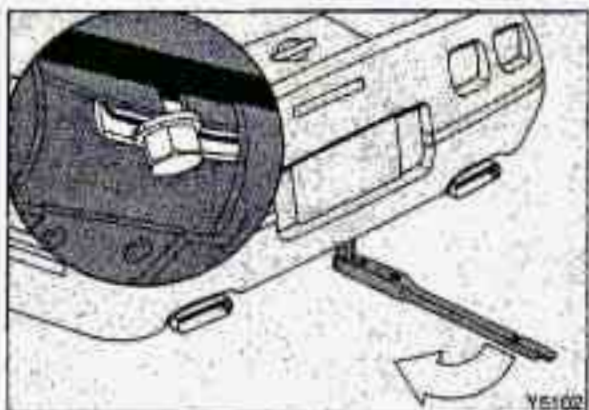

2. The spare tire and jack are located on the tire carrier tray under the rear end of your vehicle.

3. To lower the tire carrier tray, use the socket end of the wheel wrench to turn the latch bolt clockwise.

4. Now put the hooked end of the wheel wrench into the tray slot and lift up the tire carrier tray. Pull the latch bolt toward you to free the front of the tire carrier tray.

After the latch bolt is free, lower the tire carrier tray using the wheel wrench.

If you can't free the latch bolt, loosen it some more. Then repeat the procedure. Don't loosen the latch bolt too much. If you loosen it all the way, the carrier tray could fall down.

Problems on the Road



Changing a Flat Tire (CONT.)

5. Pull the spare tire out. The jack is inside the bag, held to the spare tire with a spring.
6. Remove the jack by pulling up on the end of the spring.
7. Your Corvette has gray plastic wheel nut caps. Remove them using the socket end of the wheel wrench. Store the plastic wheel nut caps somewhere until you have the flat tire repaired or replaced.

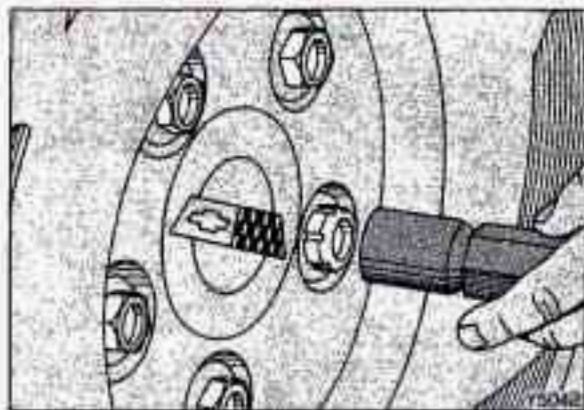

8. A special wheel lock key (removal tool) and instructions are provided with your vehicle. Attach the wheel lock key to the socket of the wheel wrench. Remove the locking wheel nut by turning counterclockwise.

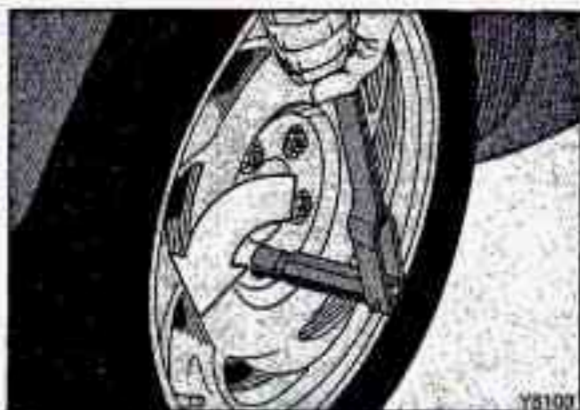

9. Using the wheel wrench and the special wheel nut socket, loosen the remaining wheel nuts by turning them counterclockwise. Don't remove them yet.

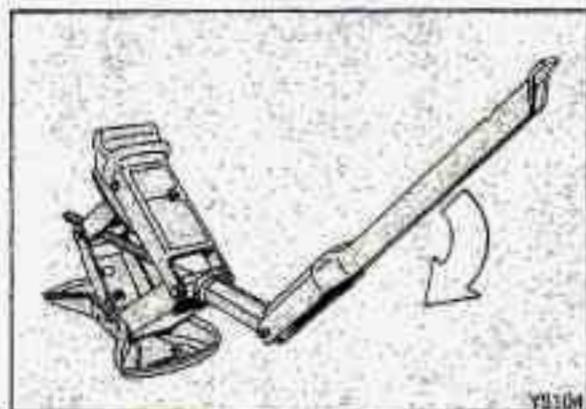

10. Rotate the wheel wrench clockwise to raise the jack head a few inches.

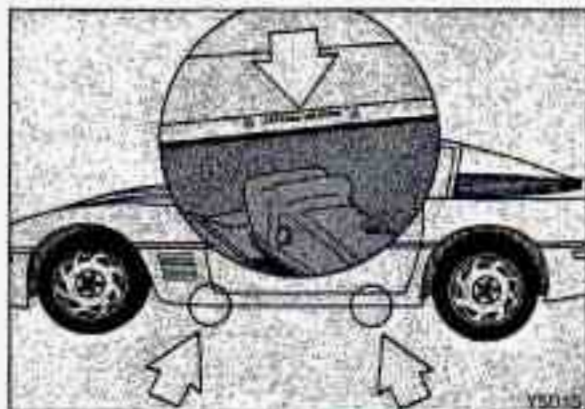

11. Near each wheel, there are triangles in the vehicle's rocker panel. Position the jack and raise the jack head until it fits firmly between the triangles in the vehicle's frame nearest the flat tire. Put the compact spare tire near you.

If you have the ZR-1 Special Performance Coupe, the locator triangles may be difficult to see. They are on the underside of the molding. The jack head fits onto the metal flange, slightly inboard from the locator triangles.

CAUTION



Getting under a vehicle when it is jacked up is dangerous. If the vehicle slips off the jack, you could be badly injured or killed. Never get under a vehicle when it is supported only by a jack.

Problems on the Road

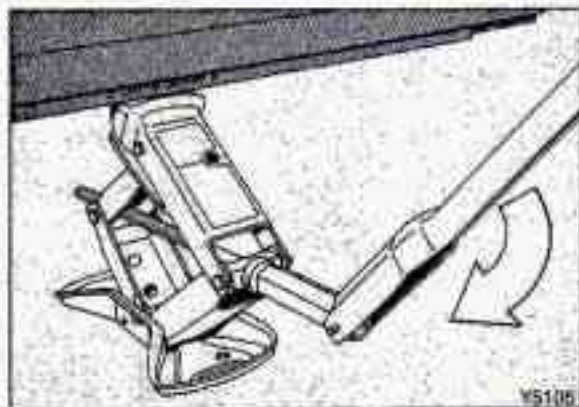

Changing a Flat Tire (CONT.)

12. Raise the vehicle by rotating the wheel wrench clockwise. Raise the vehicle far enough off the ground so there is enough room for the spare tire to fit.
13. Remove all the remaining wheel nuts and take off the flat tire.

NOTICE

Raising your vehicle with the jack improperly positioned will damage the vehicle or may allow the vehicle to fall off the jack. Be sure to fit the jack lift head into the proper location before raising your vehicle.

14. Remove any rust or dirt from the wheel bolts, mounting surfaces or spare wheel.

CAUTION



Rust or dirt on the wheel, or on the parts to which it is fastened, can make the wheel nuts become loose after a time. The wheel could come off and cause an accident. When you change a wheel, remove any rust or dirt from the places where the wheel attaches to the vehicle. In an emergency, you can use a cloth or a paper towel to do this; but be sure to use a scraper or wire brush later, if you need to, to get all the rust or dirt off.

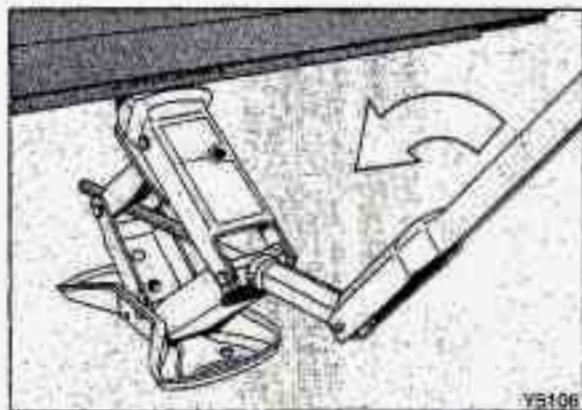
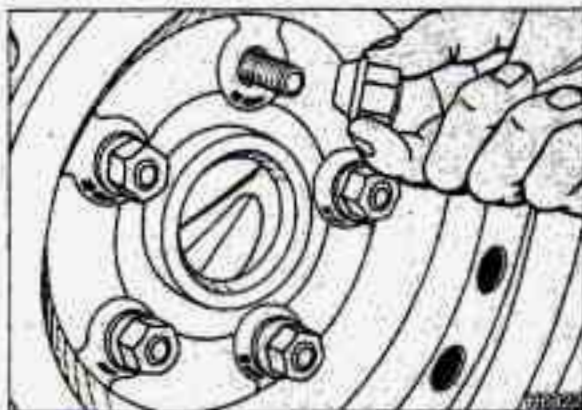

CAUTION



Never use oil or grease on studs or nuts. If you do, the nuts might come loose. Your wheel could fall off, causing a serious accident.

15. Place the spare on the wheel mounting surface.
16. Replace the wheel nuts, including the locking wheel nut, with the rounded end of the nuts toward the wheel. Tighten each nut by hand until the wheel is held against the hub.

17. Lower the vehicle by rotating the wheel wrench counterclockwise. Lower the jack completely.

Problems on the Road

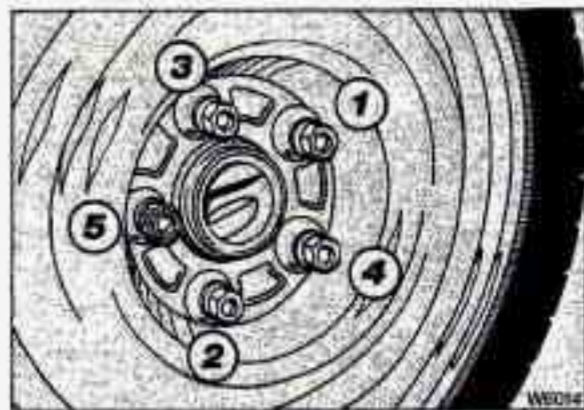

Changing a Flat Tire (CONT.)

18. Tighten the wheel nuts firmly in a criss-cross sequence as shown.

CAUTION

 Incorrect wheel nuts or improperly tightened wheel nuts can cause the wheel to become loose and even come off. This could lead to an accident. Be sure to use the correct wheel nuts. If you have to replace them, be sure to get the right kind.

Stop somewhere as soon as you can and have the nuts tightened with a torque wrench to 100 pound-feet (140 N•m).

When the spare tire is in use, either the **LOW TIRE PRESSURE** or the **SERVICE LTPWS** light on your Driver Information Center will come on. The light should go off when your original tire is replaced.

After you have the flat tire repaired or replaced, install the gray plastic wheel nut caps on the wheel nuts and tighten each cap to 22 pound-inches (2.5 N•m).

CAUTION

 An improperly stored jack could be thrown about the vehicle during a collision or sudden maneuver. This could injure people.



Put the jack and retaining spring in the jack storage bag. Remove the plastic tray from the rear storage compartment behind the passenger's seat and place the jack storage bag in the carpeted well. Replace the plastic tray and close the storage compartment.

NOTICE

Your Corvette's radio receiver box is located in the rear storage compartment. To help avoid damage to the receiver box, carefully place the jack storage bag in the storage compartment. Do not toss or place it against the radio receiver box.

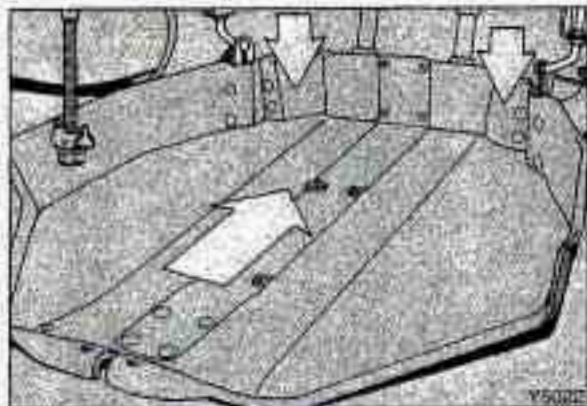

Storing a Flat Tire **(EXCEPT ZR-1 REAR TIRES)**

To store a flat tire, first you have to adjust the spare tire carrier tray because a road tire is larger than the compact spare.

1. Push the tire carrier tray toward the front of the vehicle. It will drop down to the lower position.

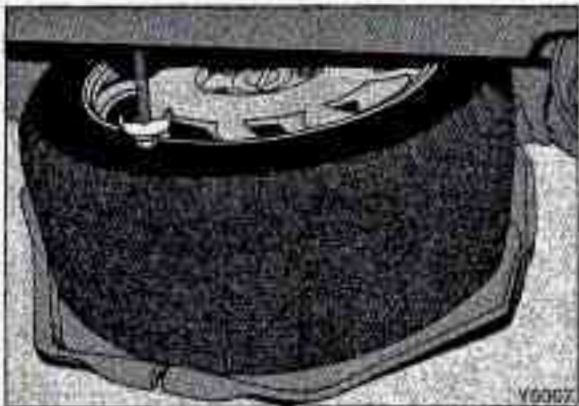

2. Put the flat road tire on the tire carrier tray.
3. Lift the latch bolt and tilt it toward the front of the vehicle. Then drop it down to the lower position.

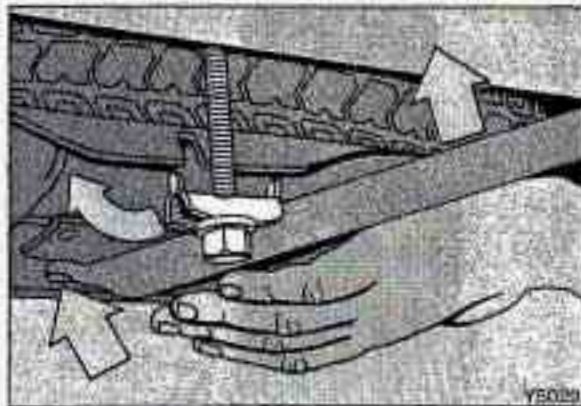

4. Put the hooked end of the wheel wrench into the slot on the tray. Hold the wrench at a slight angle, so you can see the notch for the latch bolt. Lift up on the wheel wrench like this to raise the tire carrier tray.
5. Use the socket end of the wheel wrench to turn the latch bolt counterclockwise. Turn the latch bolt until it is snug.
Be sure to return the wheel wrench and the wheel lock key to their proper storage areas.

Problems on the Road



Storing a Flat Tire (ZR-1 REAR TIRES)

If you have the ZR-1, you cannot store a flat rear tire on the tire carrier tray. You have to store and restrain the flat rear tire in the luggage area of your vehicle.

CAUTION



Storing an unsecured jack, a tire or other equipment in the passenger compartment of the vehicle could cause injury. In a sudden stop or collision, loose equipment could strike someone. Store all these in the proper place.

1. Put the jack and retaining spring in the jack storage bag. Remove the plastic tray from the rear storage compartment behind the passenger's seat and place the jack storage bag in the carpeted well. Replace the plastic tray and close the storage compartment.

NOTICE

Your Corvette's radio receiver box is located in the rear storage compartment. To help avoid damage to the receiver box, carefully place the jack storage bag in the storage compartment. Do not toss or place it against the radio receiver box.

2. Then, put the flat rear tire in the tire storage bag provided. This will help keep the interior of your vehicle from getting dirty.

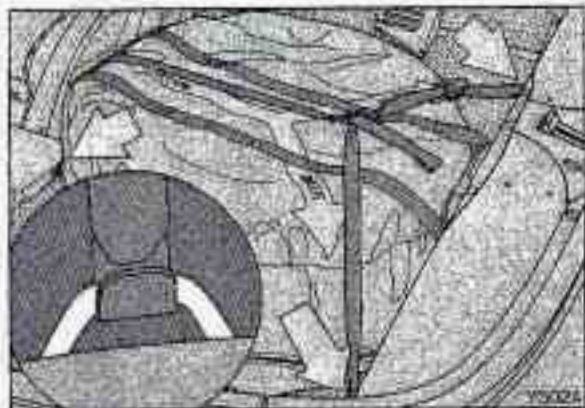

3. Place the tire flat on the floor of the rear cargo area.
4. Use the luggage straps to hold the storage bag in place. Loosen the straps at the two adjusters.
5. Attach each end of the longer strap to the rear cargo area hooks.
6. Attach the remaining strap to the hook behind the console.

When you have a flat road tire stored in the luggage area of your vehicle, you cannot also store a removable roof panel in the luggage area. It will not fit into the latches properly.

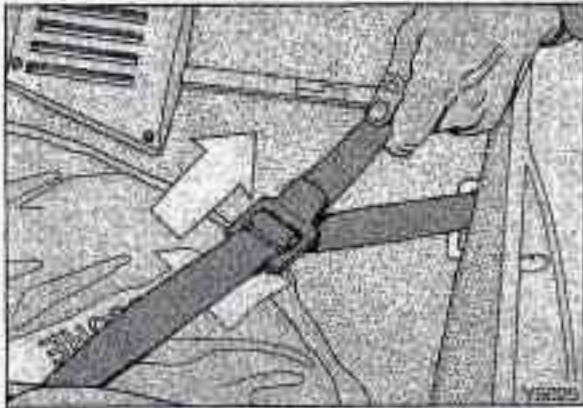

7. Tighten the straps by pulling on the loose ends.

Be sure to return the wheel wrench and the wheel lock key to their proper storage areas.

CAUTION



Do not place anything on top of the flat road tire when it is stored in the luggage area. If you stop quickly, these things could fly forward into the passenger area and hurt someone. Secure any loose articles in the rear area.

Wheel Lock Key

Your Corvette wheel lock key has a unique registration number. The registration number is printed on a card included in your locknut package. Also on this card is lost key replacement information. This number is NOT recorded by GM or your dealer, so be sure not to lose this card. You will need this information if you ever lose your wheel lock key.

Problems on the Road

Compact Spare Tire

Although the compact spare was fully inflated when your vehicle was new, it can lose air after a time. Check the inflation pressure regularly. It should be 60 psi (420 kPa). The compact spare is made to go up to 3,000 miles (5 000 km), so you can finish your trip and have your full-size tire repaired or replaced where you want. Of course, it's best to replace your spare with a full-size tire as soon as you can. Your spare will last longer and be in good shape in case you need it again.

NOTICE

Don't take your compact spare through an automatic vehicle wash with guide rails. The compact spare can get caught on the rails. That can damage the tire and wheel, and maybe other parts of your vehicle.

Don't use your compact spare on some other vehicle.

And don't mix your compact spare or wheel with other wheels or tires. They won't fit. Keep your spare and its wheel together.

NOTICE

Tire chains won't fit your compact spare. Using them will damage your vehicle and destroy the chains too. Don't use tire chains on your compact spare.

CAUTION



Storing an unsecured jack, a tire or other equipment in the passenger compartment of the vehicle could cause injury. In a sudden stop or collision, loose equipment could strike someone. Store all these in the proper place.

If You're Stuck: In Sand, Mud, Ice or Snow

What you **don't** want to do when your vehicle is stuck is to spin your wheels. The method known as "rocking" can help you get out when you're stuck, but you must use caution.

CAUTION



If you let your tires spin at high speed when the **ASR OFF** warning light is on, or when the **SERVICE ASR** warning light is on, your tires can explode and you or others could be injured. And, spinning your tires with either of these lights on can cause the automatic transmission or other parts of the vehicle to overheat. That could cause an engine compartment fire or other damage. When you're stuck, spin the wheels as little as possible. Don't spin the wheels above 35 mph (56 km/h) as shown on the speedometer.

NOTICE

Spinning your wheels with the **ASR OFF** light on, or with the **SERVICE ASR** warning light on, can destroy parts of your vehicle as well as the tires. If you spin the wheels too fast while shifting your transmission back and forth, you can destroy your transmission.

Rocking Your Vehicle to Get It Out:

First, turn your steering wheel left and right. That will clear the area around your front wheels. You should turn your ASR system off. Then, shift back and forth between **R** (Reverse) and a forward gear—or if you have a manual transmission, between **1** or **2** and **R** (Reverse)—spinning the wheels as little as possible. Release the accelerator pedal while you shift, and press lightly on the accelerator pedal when the transmission is in gear. If that doesn't get you out after a few tries, you may need to be towed out. If you do need to be towed out, see the *Index* under *Towing Your Corvette* and *Acceleration Slip Regulation (ASR) System*.

Notes



Here you will find information about the care of your Corvette. This part begins with service and fuel information, and then it shows how to check important fluid and lubricant levels. There is also technical information about your vehicle, and a section devoted to its appearance care.

Part **6**

Service & Appearance Care

Service	240
Fuel	241
Hood Release	245
Engine Oil	249
Air Cleaner	254
Transmission Fluid	256
Engine Coolant	262
Power Steering Fluid	269
Windshield Washer Fluid	269
Brakes	270
Battery	272
Bulb Replacement	273
Windshield Wiper Blade Rotation and Replacement	279
Loading Your Vehicle	280
Tires	281
Appearance Care	289
Vehicle Identification Number (VIN)	303
Add-On Electrical Equipment	304
Fuses & Circuit Breakers	305
Capacities and Specifications	311
Normal Maintenance Replacement Parts	312
Replacement Bulbs	314
Fluids & Lubricants	317

Service & Appearance Care

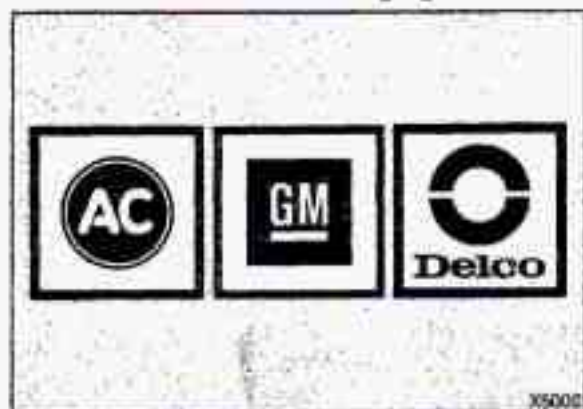

Service

Your Chevrolet dealer knows your vehicle best and wants you to be happy with it. We hope you'll go to your dealer for all your service needs. You'll get genuine GM parts and GM-trained and supported service people.

We hope you'll want to keep your GM vehicle all GM. Genuine GM parts have one of these marks.

Doing Your Own Service Work

If you want to do some of your own service work, you'll want to get the proper Corvette Service Manual. It tells you much more about how to service your Corvette than this manual can. To order the proper service manual, see the *Index* under *Service Publications*.

You should keep a record with all parts receipts and list the mileage and the date of any service work you perform. See the *Index* under *Maintenance Record*.

CAUTION



You can be injured if you try to do service work on a vehicle without knowing enough about it.

- Be sure you have sufficient knowledge, experience, and the proper replacement parts and tools before you attempt any vehicle maintenance task.
- Be sure to use the proper nuts, bolts, and other fasteners. "English" and "metric" fasteners can be easily confused. If you use the wrong fasteners, parts can later break or fall off. You could be hurt.



NOTICE

If you try to do your own service work without knowing enough about it, your vehicle could be damaged.

Fuel

Use premium unleaded gasoline rated at 91 octane or higher. You may use middle grade or regular unleaded gasolines, but your vehicle may not accelerate as well. The gasoline you use should meet specifications ASTM D4814 in the U.S. and CGSB 3.5-92 in Canada. These fuels should have the proper additives, so you should not have to add anything to the fuel.

In the U.S. and Canada, it's easy to be sure you get the right kind of gasoline (unleaded). You'll see "UNLEADED" right on the pump. And only unleaded nozzles will fit into your vehicle's filler neck.

Be sure the posted octane for premium is at least 91 (at least 89 for middle grade and 87 for regular). If the octane is less than 87, you may get a heavy knocking noise when you drive. If it's bad enough, it can damage your engine.

If you're using fuel rated at 91 octane or higher and you still hear heavy knocking, your engine needs service. But don't worry if you hear a little pinging noise when you're accelerating or driving up a hill. That's normal and you don't have to buy a higher octane fuel to get rid of pinging. It's the heavy, constant knock that means you have a problem.

Fuel Capacity: 20 U.S. Gallons (75.7 L). Use unleaded fuel only.

Service & Appearance Care

Fuel (CONT.)

What about gasoline with blending materials that contain oxygen, such as MTBE or alcohol?

- **MTBE** is "methyl tertiary-butyl ether." Fuel that is no more than 15% **MTBE** is fine for your vehicle.
- **Ethanol** is ethyl or grain alcohol. Properly-blended fuel that is no more than 10% **ethanol** is fine for your vehicle.
- **Methanol** is methyl or wood alcohol.

NOTICE

Fuel that is more than 5% **methanol** is bad for your vehicle. Don't use it. It can corrode metal parts in your fuel system and also damage plastic and rubber parts. That damage wouldn't be covered under your warranty. And even at 5% or less, there must be "cosolvents" and corrosion preventers in this fuel to help avoid these problems.

Gasolines for Cleaner Air

Your use of gasoline with detergent additives will help prevent deposits from forming in your engine and fuel system. That helps keep your engine in tune and your emission control system working properly. It's good for your vehicle, and you'll be doing your part for cleaner air.

Many gasolines are now blended with materials called oxygenates. General Motors recommends that you use gasolines with these blending materials, such as MTBE and ethanol. By doing so, you can help clean the air, especially in those parts of the country that have high carbon monoxide levels.

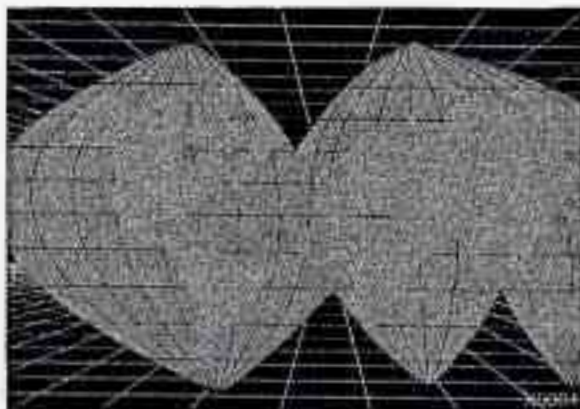

In addition, some gasoline suppliers are now producing reformulated gasolines. These gasolines are specially designed to reduce vehicle emissions. General Motors recommends that you use reformulated gasoline. By doing so, you can help clean the air, especially in those parts of the country that have high ozone levels.

You should ask your service station operators if their gasolines contain detergents and oxygenates, and if they have been reformulated to reduce vehicle emissions.

Fuels in Foreign Countries

If you plan on driving in another country outside the U.S. or Canada, unleaded fuel may be hard to find.

Do not use leaded gasoline. If you use even one tankful, your emission controls won't work well or at all. With continuous use, spark plugs can get fouled, the exhaust system can corrode, and your engine oil can deteriorate quickly. Your vehicle's oxygen sensor will be damaged. All of that means costly repairs that wouldn't be covered by your warranty.

To check on fuel availability, ask an auto club, or contact a major oil company that does business in the country where you'll be driving.

You can also write us at the following address for advice. Just tell us where you're going and give your Vehicle Identification Number (VIN).

General Motors of Canada Ltd.
International Export Sales
P.O. Box 828
Oshawa, Ontario L1H 7N1, Canada

Service & Appearance Care



Filling Your Tank

To remove the fuel filler cap, turn it slowly to the left (counterclockwise).

CAUTION

 Gasoline vapor is highly flammable. It burns violently, and that can cause very bad injuries. Don't smoke if you're near gasoline or refueling your vehicle. Keep sparks, flames, and smoking materials away from gasoline.

CAUTION

 If you get gasoline on you and then something ignites it, you could be badly burned. Gasoline can spray out on you if you open the fuel filler cap too quickly. This spray can happen if your tank is nearly full, and is more likely in hot weather. Open the fuel filler cap slowly and wait for any "hiss" noise to stop. Then unscrew the cap all the way.

While refueling, place the cap in the depression to the left of the fuel tank opening.

NOTICE

Keep the drain hole in the fuel filler door area free of debris. Water and other debris might drain into the gas tank and damage the engine.

When you put the cap back on, turn it to the right (clockwise) until you hear a clicking noise.

NOTICE

If you need a new cap, be sure to get the right type. Your dealer can get one for you. If you get the wrong type, it may not fit or have proper venting, and your fuel tank and emissions system might be damaged.

■ *Checking Things Under the Hood*

The following sections tell you how to check fluids, lubricants and important parts underhood.



Hood Release

To open the hood, first pull the hood release handle inside the vehicle.

Then lift the rear edge of the hood at the windshield area.

Service & Appearance Care

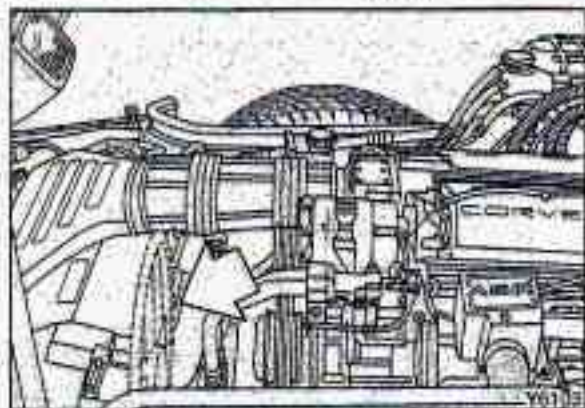

Hood Release (CONT.)

CAUTION



Electric fans under the hood can start up and injure you even when the engine is not running. Keep hands, clothing and tools away from any underhood electric fan.

CAUTION



Things that burn can get on hot engine parts and start a fire. These include liquids like gasoline, oil, coolant, brake fluid, windshield washer and other fluids, and plastic or rubber. You or others could be burned. Be careful not to drop or spill things that will burn onto a hot engine.



Before closing the hood, be sure all the filler caps are on. Then release the hood safety strut by moving the strut to the centered position and lowering the hood.

Lower the hood until it is approximately 12 inches (30 cm) above the engine compartment, then release it. This should securely latch the hood.

If the hood is still not fully closed and latched, repeat the closing procedure by holding the hood a little higher before you release it.

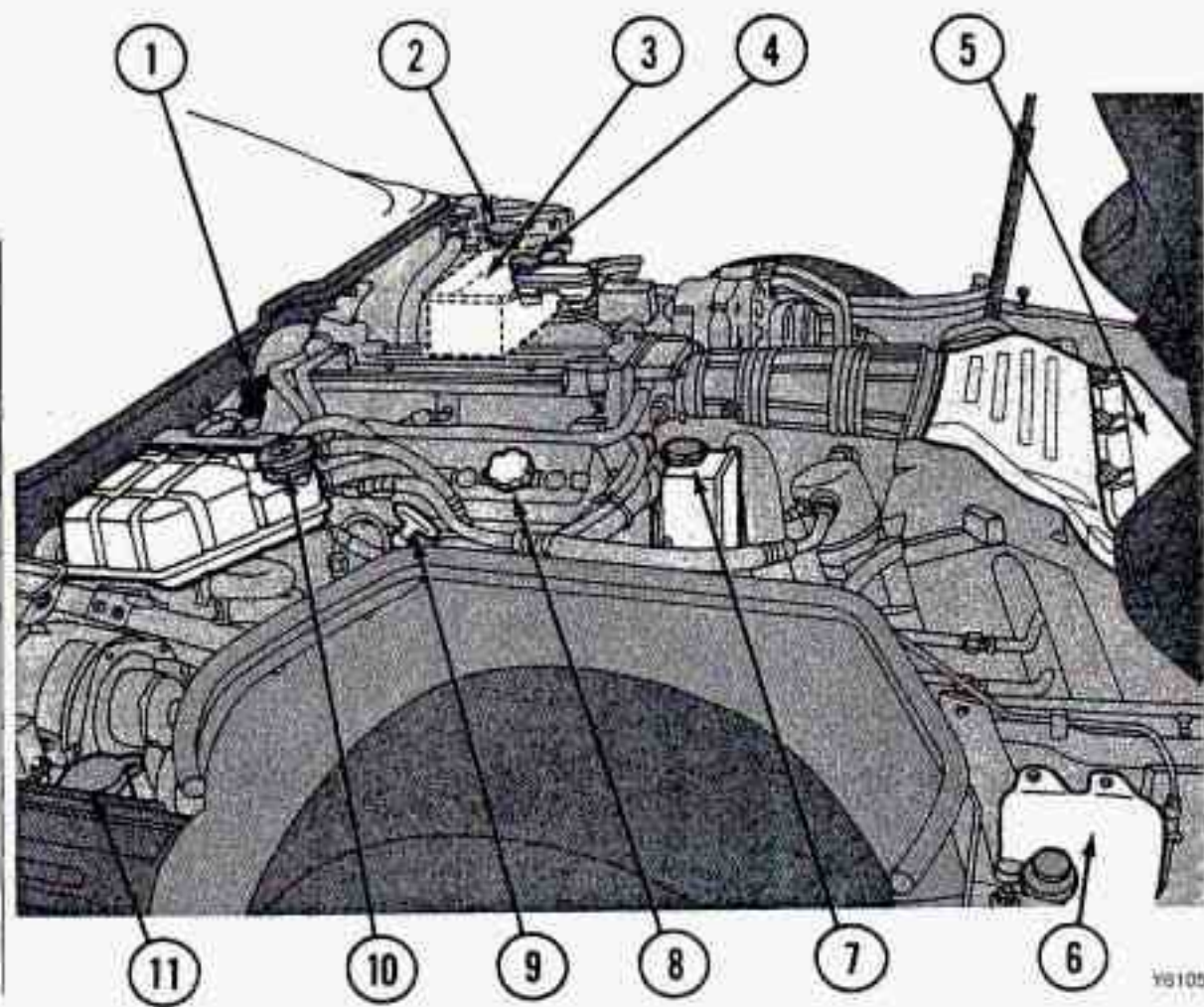

LT1 Engine (CODE P)

1. Automatic Transmission Fluid Dipstick (if equipped)
2. Hydraulic Clutch Fluid Reservoir (if equipped)
3. Battery
4. Brake Fluid Reservoir
5. Air Cleaner
6. Coolant Recovery Tank
7. Power Steering Fluid Reservoir
8. Engine Oil Fill Cap
9. Engine Oil Dipstick
10. Coolant High Fill Reservoir
11. Windshield Washer Fluid Reservoir

Y0105

Service & Appearance Care

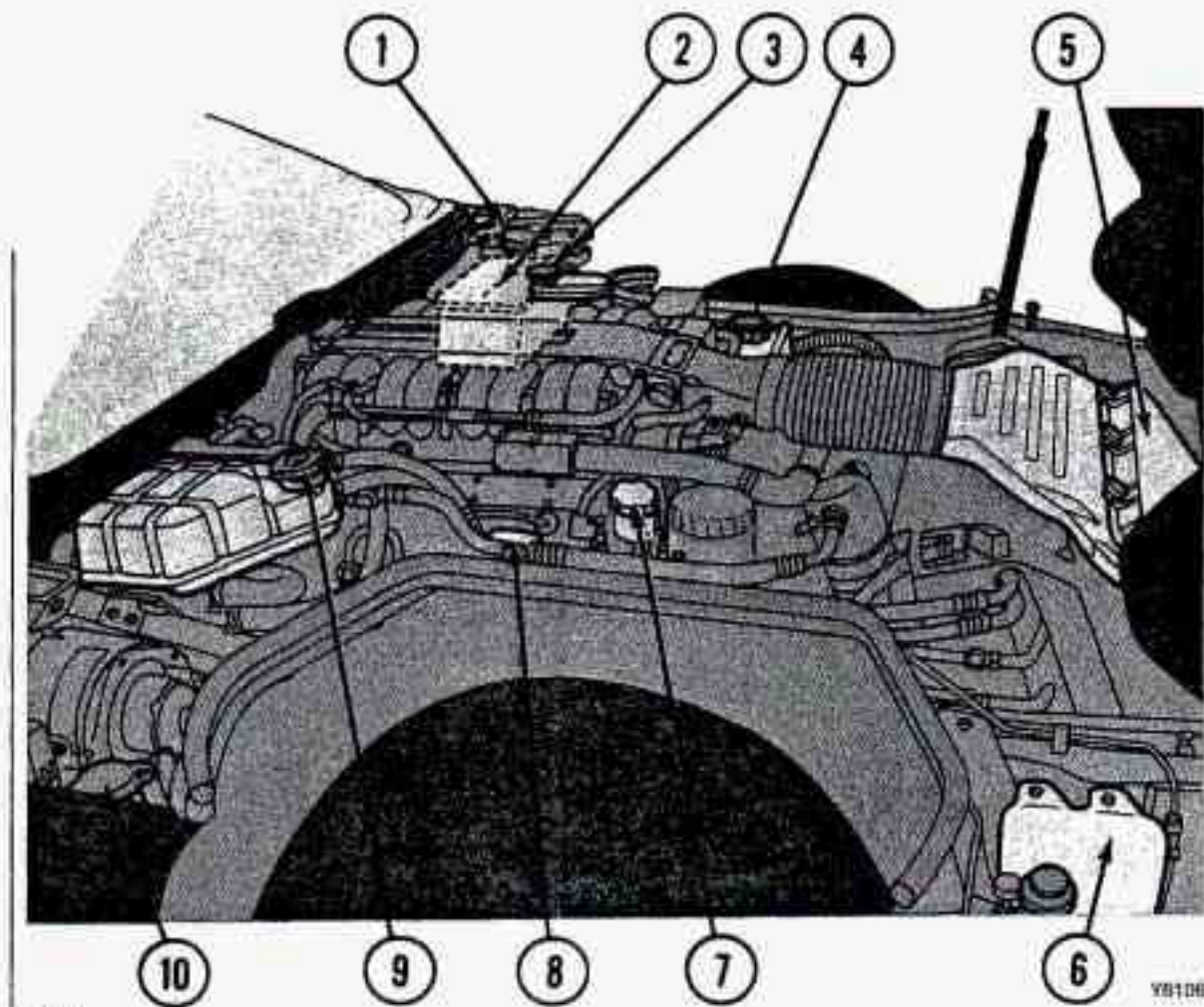

LT5 Engine (CODE J)

1. Hydraulic Clutch Fluid Reservoir
2. Battery
3. Brake Fluid Reservoir
4. Power Steering Fluid Reservoir
5. Air Cleaner
6. Coolant Recovery Tank
7. Engine Oil Fill Cap
8. Engine Oil Dipstick
9. Coolant High Fill Reservoir
10. Windshield Washer Fluid Reservoir



Underhood Lights

Leaving your hood open and your underhood lights on can drain your battery. If you need to keep the hood open for an extended period of time, remove the Underhood Lights Fuse. This 10-amp fuse is located under the hood on the left-hand marker light assembly. See the *Index* under *Fuses & Circuit Breakers*.

Engine Oil

It's a good idea to check your engine oil level every time you get fuel. In order to get an accurate reading, the vehicle must be on level ground.

If you have the LT1 engine, the best time to check your engine oil is when the engine is warm. If the engine is running, the engine oil won't drain back into the pan. Turn off the engine and give the oil a few minutes to drain back into the oil pan. If you don't, the oil dipstick might not show the actual level.

If you have a ZR-1, the best time to check your engine oil is when the engine is cold. If you run the engine, the engine oil won't drain back into the pan fast enough. Give the oil two hours to drain back into the oil pan. If you don't, the oil dipstick might not show the actual level.

Service & Appearance Care

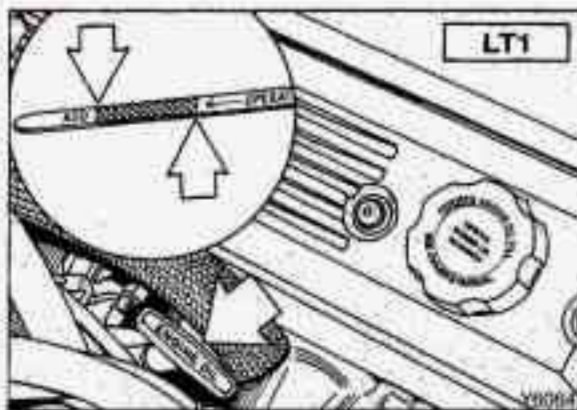

LT1 Engine: Checking Engine Oil

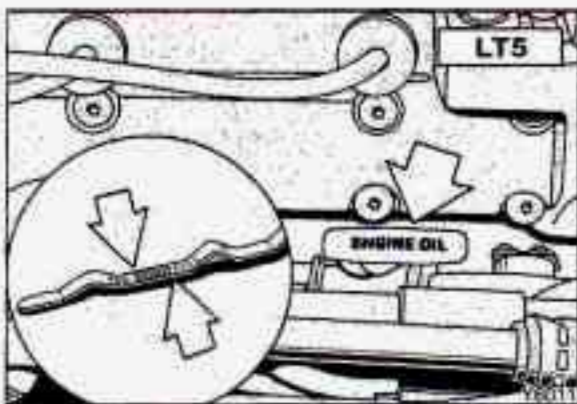

LT5 Engine: Checking Engine Oil

Engine Oil (CONT.)

To Check Engine Oil:

Pull out the dipstick and clean it with a paper towel or a cloth, then push it back in all the way. Remove it again, keeping the tip lower.

When to Add Oil:

If the oil is at or below the **ADD** line, you'll need to add some oil. But you must use the right kind. This section explains what kind of oil to use. For crankcase capacity, see the *Index* under *Capacities and Specifications*.

NOTICE

Don't add too much oil. If your engine has so much oil that the oil level gets above the cross-hatched area that shows the proper operating range, your engine could be damaged.

Just fill it enough to put the level somewhere in the proper operating range. Push the dipstick all the way back in when you're through.

Your vehicle has a **LOW OIL** light on the Driver Information Center that comes on and stays on if your oil is $\frac{1}{2}$ to $1\frac{1}{2}$ quarts low (see the *Index* under *Low Oil Light*). Do not wait until this light comes on to check your oil level. This light is an added reminder only—you should check your oil level regularly.

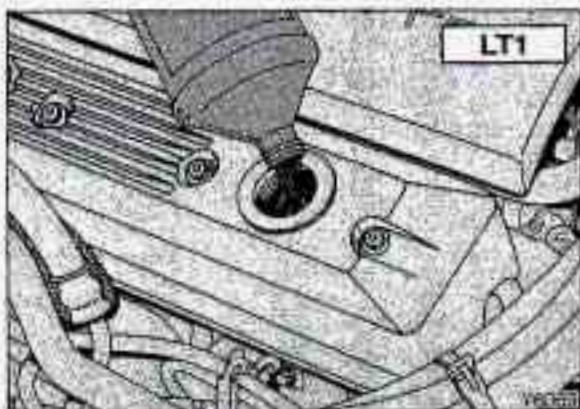

LT1 Engine: Adding Engine Oil

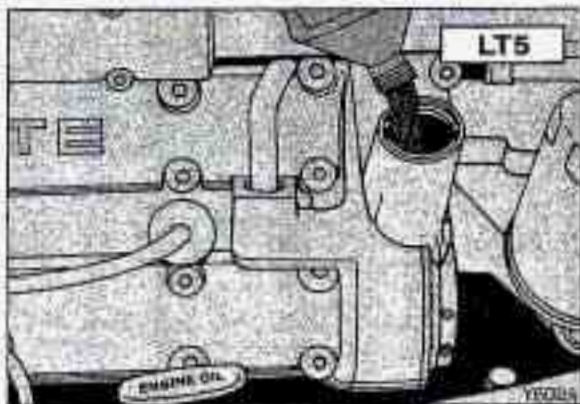

LT5 Engine: Adding Engine Oil

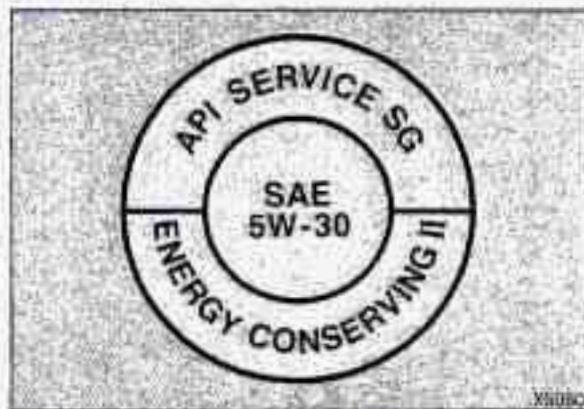

What Kind of Oil To Use

Look for Three Things:

- **GM4718M**

Your Corvette engine requires a special oil meeting GM Standard GM4718M. Oils meeting this Standard may be identified as synthetic, and should also be identified as API Service SG. However, not all Synthetic API Service SG oils will meet this GM Standard. You should look for and use only an oil that meets GM Standard GM4718M.

Service & Appearance Care

What Kind of Oil To Use (CONT.)

NOTICE

If you use oils that don't have the GM4718M Standard designation, you can cause engine damage not covered by your warranty.

- **SAE 5W-30**

As shown in the viscosity chart, SAE 5W-30 is best for your vehicle. However, you can use SAE 10W-30 if it's going to be 0°F (-18°C) or above. These numbers on an oil container show its viscosity, or thickness.

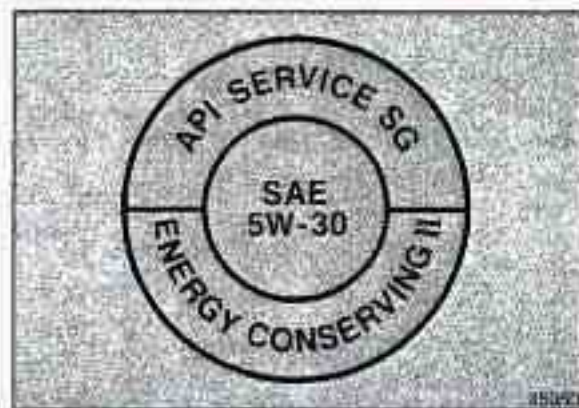
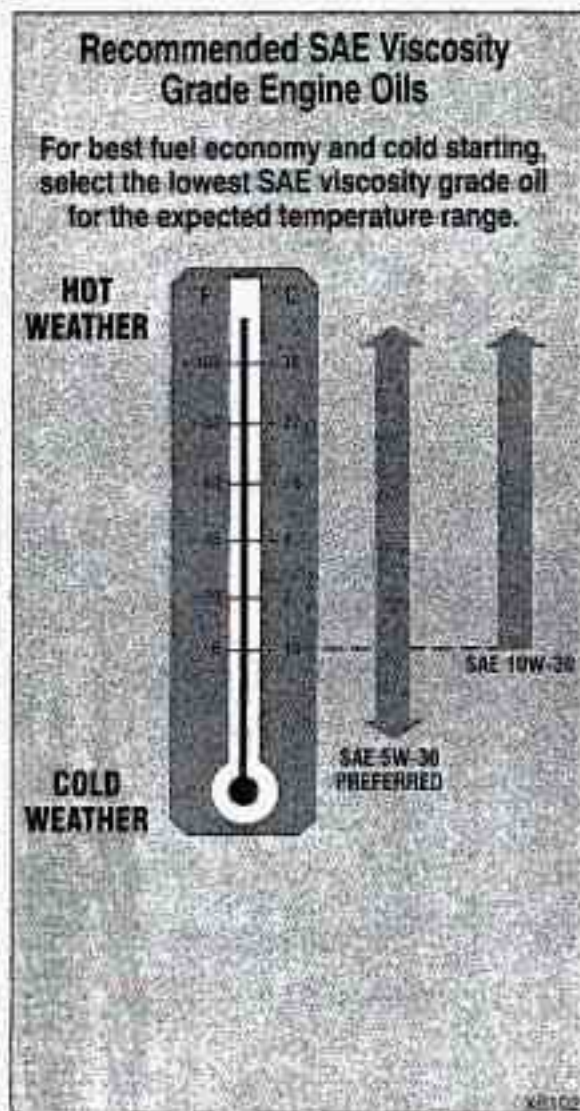

- **Energy Conserving II**

Oils with these words on the container will help you save fuel.

This doughnut-shaped logo (symbol) is used on most oil containers to help you select the correct oil.

You should look for this on the oil container, and use **only** those oils that display the logo.

Your Corvette engine is filled at the factory with a Mobil 1[®] synthetic oil, which meets all requirements for your vehicle.

Substitute Oil (LT1 Engine Only)

When adding oil to maintain engine oil level, if an oil meeting GM Standard GM4718M is not available, you can use oil designated either SAE 5W-30 API Service SG at all temperatures, or SAE 10W-30 API Service SG at temperatures above 0°F (-18°C). This oil should not be used for an oil change.

Substitute Oil (LT5 Engine Only)

When adding oil to maintain engine oil level, if an oil meeting GM Standard GM4718M is not available, you can use oil designated SAE 10W-30 API Service SG at all temperatures. This oil should not be used for an oil change.

Engine Oil Additives

Don't add anything to your oil. Your Chevrolet dealer is ready to advise if you think something should be added.

When to Change Engine Oil

See if any one of these is true for you:

- Most trips are less than 4 miles (6 km).
- It's below freezing outside and most trips are less than 10 miles (16 km).
- The engine is at low speed most of the time (as in stop-and-go traffic).
- Most trips are through dusty places.

If any one of these is true for your vehicle, you need to change your **oil and filter** every 3,000 miles (5,000 km) or 3 months—whichever comes first. (See the *Index* under *Engine Oil Life Monitor*.)

If none of them is true, change the oil every 7,500 miles (12,500 km) or 12 months—whichever comes first. Change the filter at the first oil change and at every other oil change after that. (See the *Index* under *Engine Oil Life Monitor*.)

Service & Appearance Care

Engine Block Heater

(LT1 ENGINE, CANADA ONLY)

An engine block heater can be a big help if you have to park outside in very cold weather, 0°F (-18°C) or colder. If your vehicle has an engine block heater, see the *Index* under *Engine Block Heater*.

What to Do with Used Oil

CAUTION



Used engine oil contains things that have caused skin cancer in laboratory animals. Don't let used oil stay on your skin for very long. Clean your skin and nails with soap and water, or a good hand cleaner. Wash or properly throw away clothing or rags containing used engine oil.

Used oil can be a real threat to the environment. If you change your own oil, be sure to drain all free-flowing oil from the filter before disposal. Don't ever dispose of oil by pouring it on the ground, into sewers, or into streams or bodies of water. Instead, recycle it by taking it to a place that collects used oil. If you have a problem properly disposing of your used oil, ask your dealer, a service station or a local recycling center for help.

Air Cleaner

Refer to the Maintenance Schedule to determine when to replace the air filter. See the *Index* under *Scheduled Maintenance Services*.

CAUTION



Operating the engine with the air cleaner off can cause you or others to be burned. The air cleaner not only cleans the air, it stops flame if the engine backfires. If it isn't there, and the engine backfires, you could be burned. Don't drive with it off, and be careful working on the engine with the air cleaner off.

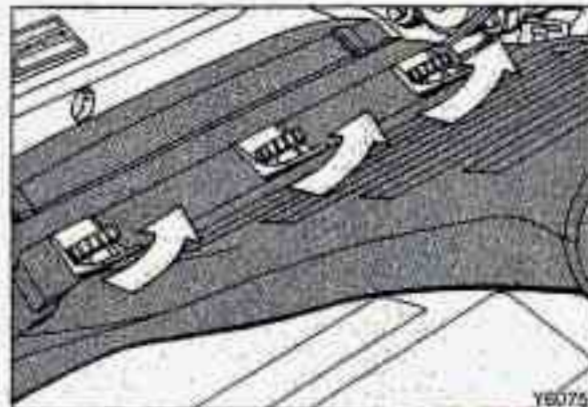

NOTICE

If the air cleaner is off, a backfire can cause a damaging engine fire. And, dirt can easily get into your engine, which will damage it. Always have the air cleaner in place when you're driving.

1. Unscrew the three knobs.
2. Pull the manifold forward and up.

3. Pull off the cover and remove the filter.
4. Reverse steps 1-3 to reassemble. Make sure the short knob is returned to the center position when you are finished.

Service & Appearance Care

Throttle Cable Adjusters

Your 1993 Corvette is equipped with special throttle cable adjusters. If you need to adjust the throttle on your engine, please see a qualified Chevrolet dealer or refer to the 1993 Corvette Service Manual.

Automatic Transmission Fluid

When to Check and Change:

A good time to check your automatic transmission fluid level is when the engine oil is changed. Refer to the Maintenance Schedule to determine when to change your fluid. See the *Index* under *Scheduled Maintenance Services*.

How to Check:

Because this operation can be a little difficult, you may choose to have this done at a Chevrolet dealership Service Department.

If you do it yourself, be sure to follow all the instructions here, or you could get a false reading on the dipstick.

NOTICE

Too much or too little fluid can damage your transmission. Too much can mean that some of the fluid could come out and fall on hot engine parts, starting a fire. Be sure to get an accurate reading if you check your transmission fluid.

Wait at least 30 minutes before checking the transmission fluid level if you have been driving:

- When outside temperatures are above 90°F (32°C).
- At high speed for quite a while.
- In heavy traffic—especially in hot weather.

To get the right reading, the fluid should be at normal operating temperature, which is 180°F to 200°F (82°C to 93°C).

To Check Transmission Fluid Hot:

Get the vehicle warmed up by driving about 15 miles (24 km) when outside temperatures are above 50°F (10°C). If it's colder than 50°F (10°C), drive the vehicle in **D** (third gear) until the engine temperature gage moves and then remains steady for ten minutes. Then follow the procedures under *To Check the Fluid Hot or Cold*.

Service & Appearance Care

Automatic Transmission Fluid **(CONT.)**

To Check Transmission Fluid Cold:

A cold check is made after the vehicle has been sitting for eight hours or more with the engine off and is used only as a reference. Let the engine run at idle for five minutes if outside temperatures are 50°F (10°C) or more. If it's colder than 50°F (10°C), you may have to idle the engine longer. A hot check must follow when fluid is added during a cold check.

To Check the Fluid Hot or Cold:

- Park your vehicle on a level place.
- Place the shift lever in **P** (Park) with the parking brake applied.
- With your foot on the brake pedal, move the shift lever through each gear range, pausing for about three seconds in each range. Then, position the shift lever in **P** (Park).
- Let the engine run at idle for three minutes or more.

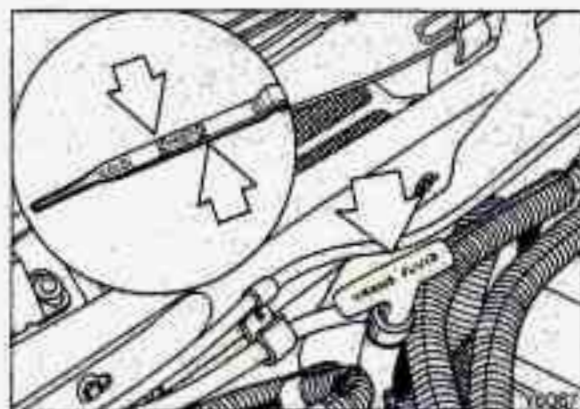

Then, Without Shutting Off the Engine, Follow These Steps:

1. Pull out the dipstick and wipe it with a clean rag or paper towel.
2. Push it back in all the way, wait three seconds and then pull it back out again.
3. Check both sides of the dipstick, and read the lower level. The fluid level must be in the **COLD** area for a cold check or in the **HOT** or cross-hatched area for a hot check.
4. If the fluid level is where it should be, push the dipstick back in all the way.

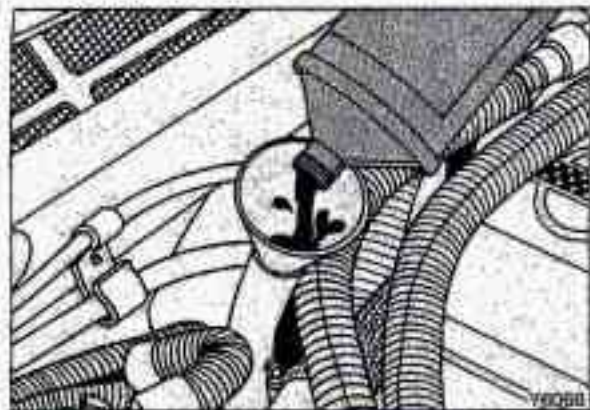

How to Add Fluid:

Refer to the Maintenance Schedule to determine what kind of transmission fluid to use. See the *Index* under *Fluids & Lubricants*.

If the fluid level is low, add only enough of the proper fluid to bring the level up to the **COLD** area for a cold check or the **HOT** area for a hot check. It doesn't take much fluid, generally less than a pint. Don't overfill. We recommend you use only fluid labeled

DEXRON®-IIE, because fluids with that label are made especially for your automatic transmission. Damage caused by fluid other than DEXRON®-IIE is not covered by your new vehicle warranty.

After adding fluid, recheck the fluid level as described under *How to Check*. When the correct fluid level is obtained, push the dipstick back in all the way.

Manual Transmission Fluid

When to Check:

A good time to have it checked is when the engine oil is changed. However, the fluid in your manual transmission doesn't require changing.

How to Check:

Because this operation can be a little difficult, you may choose to have this done at a Chevrolet dealership Service Department.

If you do it yourself, be sure to follow all the instructions here, or you could get a false reading.

NOTICE

Too much or too little fluid can damage your transmission. Too much can mean that some of the fluid could come out and fall on hot engine parts, starting a fire. Be sure to get an accurate reading if you check your transmission fluid.

Service & Appearance Care

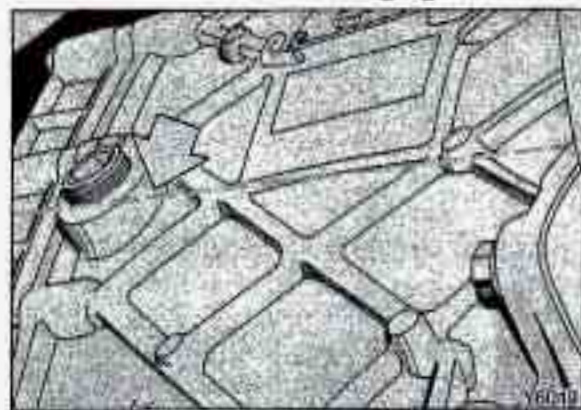

Manual Transmission Fluid (CONT.)

Check the fluid level only when your engine is off, the vehicle is parked on a level place and the transmission is cool enough for you to rest your fingers on the transmission case.

Then, Follow These Steps:

1. Remove the filler plug.
2. Check that the lubricant level is up to the bottom of the filler plug hole.
3. If the fluid level is good, install the plug and be sure it is fully seated. If the fluid level is low, add more fluid as described in the next step.

How to Add Fluid:

When you need to add fluid, put in enough to bring the level up to the bottom of the filler plug hole in the transmission case. Refer to the Maintenance Schedule to determine what kind of fluid to use. See the *Index* under *Fluids & Lubricants*.

Hydraulic Clutch (MANUAL TRANSMISSION)

The clutch linkage in your vehicle is self-adjusting.

When to Check and What to Use:

Refer to the Maintenance Schedule to determine how often you should check the fluid level in your clutch master cylinder reservoir and what to add. See the *Index* under *Owner Checks & Services* and *Fluids & Lubricants*.

How to Check and Add Fluid:

The clutch master cylinder is under the Engine Control Module (ECM) in the left rear area of the engine compartment.

To check the fluid, look at the area between the ECM and the battery.



To add fluid, the ECM unit must be moved.

Loosen the two nuts on the ECM unit. With the LT1 engine, there is one nut on the outboard side of the ECM unit and one nut on the inboard side. With the LT5 engine, both nuts are on the inboard side of the ECM unit.

Move the unit to either side. Do not disconnect any wires.



Fluid should be added if the fluid level is at or below the **ADD** mark on the reservoir. There are additional instructions on the reservoir cap.

When returning the ECM to its proper position, make sure the bolts are aligned with the slots in the bracket. Then gently push down on the unit. When replacing the unit, be careful not to overtighten the nuts.

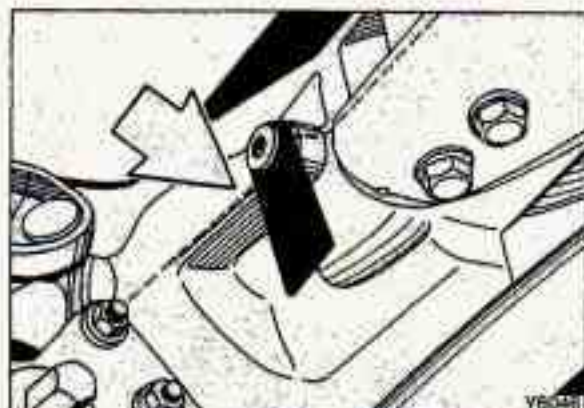

Rear Axle

When to Check Lubricant:

Refer to the Maintenance Schedule to determine how often to check the lubricant. See the *Index* under *Periodic Maintenance Inspections*.

How to Check Lubricant:

If the level is below the bottom of the filler plug hole, you'll need to add some lubricant. Add enough lubricant to raise the level to the bottom of the filler plug hole.

Service & Appearance Care

Rear Axle (CONT.)

What to Use:

To add lubricant when the level is low, use Axle Lubricant (GM Part No. 12345977) or SAE 80W-90 GL-5 gear lubricant. To completely refill after draining, add four ounces (118 ml) of Limited-Slip Differential Lubricant Additive (GM Part No. 1052358). Then fill to the bottom of the filler plug hole with Axle Lubricant (GM Part No. 12345977) or SAE 80W-90 GL-5 gear lubricant.

Engine Coolant

The following explains your cooling system and how to add coolant when it is low. If you have a problem with engine overheating, see the *Index* under *Engine Overheating*.

The proper coolant for your Corvette will:

- Give freezing protection down to -34°F (-37°C).
- Give boiling protection up to 262°F (128°C).
- Protect against rust and corrosion.
- Help keep the proper engine temperature.
- Let the warning lights work as they should.

What to Use:

Use a mixture of one-half **clean water** (preferably distilled) and one-half antifreeze that meets "GM Specification 1825-M," which won't damage aluminum parts. You can also use a recycled coolant conforming to GM Specification 1825-M with a complete coolant flush and refill. If you have the LT1 engine, use GM Engine Coolant Supplement (sealer) with **any** complete coolant change. If you use these, you don't need to add anything else.

CAUTION



Adding only plain water to your cooling system can be dangerous. Plain water, or some other liquid like alcohol, can boil before the proper coolant mix will. Your vehicle's coolant warning system is set for the proper coolant mix. With plain water or the wrong mix, your engine could get too hot but you wouldn't get the overheat warning. Your engine could catch fire and you or others could be burned. Use a 50/50 mix of **clean water** and a proper antifreeze.

NOTICE

If you use an improper coolant mix, your engine could overheat and be badly damaged. The repair cost wouldn't be covered by your warranty. Too much water in the mix can freeze and crack the engine, radiator, heater core and other parts.

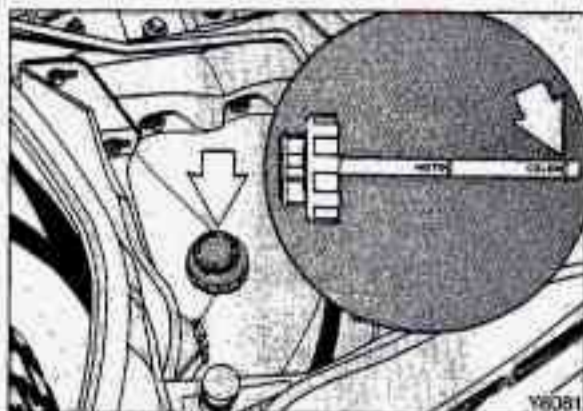

Adding Coolant—LT1 Engine To Check Coolant:

When your engine is cold, check the dipstick on the cap of the coolant recovery tank. The coolant level should be at **COLD**, or a little higher. When your engine is warm, the level on the dipstick should be up to **HOT**, or a little higher. If your engine is overheating, see the *Index* under *Engine Overheating*.

Your Corvette also has a coolant high fill reservoir located at the right rear of the engine compartment.

Service & Appearance Care

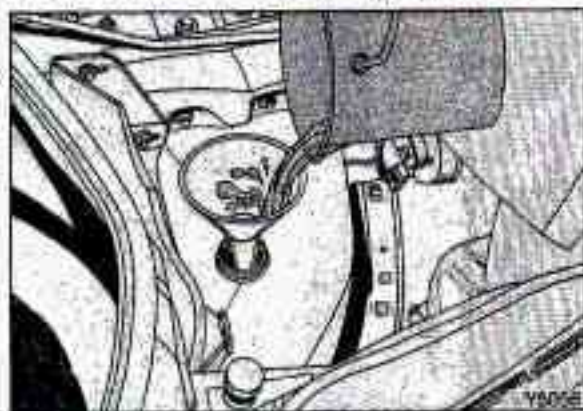

Adding Coolant—LT1 Engine (CONT.)

To Add Coolant to the Coolant Recovery Tank:

For more information on adding coolant to the LT1 engine, see the *Index* under *Engine Overheating*.

If you need more coolant, add the proper mix **at the coolant recovery tank**, but only when your engine is cool. If the tank is very low or empty, also add coolant to the coolant high fill reservoir. See the following procedure and refer to the *Index* under *Engine Overheating*.

To Add Coolant to the High Fill Reservoir:

CAUTION



Turning the coolant high fill reservoir pressure cap when the engine and cooling system are hot can allow steam and scalding liquids to blow out and burn you badly. Never turn the pressure cap—even a little—when the engine and cooling system are hot.

NOTICE

The LT1 (Code P) engine has a specific coolant high fill reservoir fill procedure. Failure to follow this procedure could cause your engine to overheat and be severely damaged.

1. When the engine is cool, remove the pressure cap.

- **Without pressing down on the pressure cap**, turn it slowly to the left until it reaches a "stop."
- If you hear a hiss, it means there is still some pressure. Wait for the hiss to stop. Then press down on the pressure cap and continue turning it to the left. Remove the pressure cap.

CAUTION



You can be burned if you spill coolant on hot engine parts. Coolant contains ethylene glycol, and it will burn if the engine parts are hot enough. Don't spill coolant on a hot engine.

2. After the engine cools, open the air bleed valves on the throttle body and water pump inlet.
3. Fill with the proper mix. Add coolant until you see a steady stream of coolant coming from the bleed valves.
4. Then close the bleed valves.
5. Continue to fill the coolant high fill reservoir up to the base of the filler neck.
6. Rinse or wipe the spilled coolant from the engine and compartment.
7. Start the engine and allow it to run in idle for approximately four minutes. By this time, the coolant level inside

Service & Appearance Care

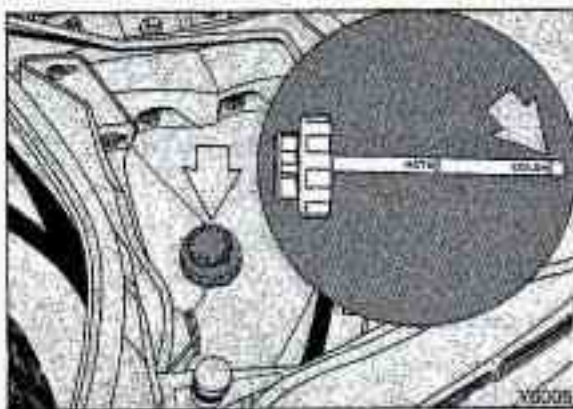

Adding Coolant—LT1 Engine (CONT.)

the coolant high fill reservoir will be lower. Add more of the proper mix through the filler neck until the level reaches the base of the filler neck.

8. Replace the pressure cap. When it's tight, the arrows on the cap should line up with the overflow tube on the reservoir filler neck. Shut the engine off.
9. Then fill the coolant recovery tank to the proper level.

For complete drain, flush and refill, contact your Chevrolet dealer or the procedure may be found in a Chevrolet Corvette Service Manual. To purchase a Service Manual, see the *Index* under *Service Publications*.

Adding Coolant—LT5 Engine

To Check Coolant:

When your engine is cold, check the dipstick on the cap of the coolant recovery tank. The coolant level should be at **COLD** or a little higher. When your engine is warm, the level on the dipstick should be up to **HOT**, or a little higher. If your engine is overheating, see the *Index* under *Engine Overheating*.

Your Corvette also has a coolant high fill reservoir located at the right rear of the engine compartment.

To Add Coolant:

For more information on adding coolant to the LT5 engine, see the *Index* under *Engine Overheating*.

If you need more coolant, add the proper mix **at the coolant recovery tank**, but only when your engine is cool. If the tank is very low or empty, also add coolant to the coolant high fill reservoir.

Add coolant to the base of the filler neck, if needed.

CAUTION



Turning the coolant high fill reservoir pressure cap when the engine and cooling system are hot can allow steam and scalding liquids to blow out and burn you badly. Never turn the pressure cap—even a little—when the engine and cooling system are hot.

1. When the engine is cool, remove the pressure cap.

- **Without pressing down on the pressure cap**, turn it slowly to the left until it reaches a "stop."
- If you hear a hiss, it means there is still some pressure. Wait for the hiss to stop. Then press down on the pressure cap and continue turning it to the left. Remove the pressure cap.

CAUTION



You can be burned if you spill coolant on hot engine parts. Coolant contains ethylene glycol, and it will burn if the engine parts are hot enough. Don't spill coolant on a hot engine.

Service & Appearance Care

Adding Coolant—LT5 Engine (CONT.)

2. Add the coolant mix to the coolant high fill reservoir until the level reaches the base of the reservoir filler neck.
3. With the pressure cap still removed, run the engine until the upper radiator hose is hot. With the engine at idle, add coolant mix again, if needed, to bring the level back up to the reservoir filler neck base.
4. Put on the pressure cap. When it's tight, the arrows on the cap should line up with the overflow tube on the reservoir filler neck.

Coolant High Fill Reservoir Pressure Cap

NOTICE

Your cap is a 15 psi (105 kPa) pressure-type cap and must be tightly installed to prevent coolant loss and possible engine damage from overheating. Be sure the arrows on the cap line up with the overflow tube on the coolant high fill reservoir filler neck.

When you replace your coolant high fill reservoir pressure cap, an AC® cap is recommended.

Thermostat

Engine coolant temperature is controlled by a thermostat in the engine coolant system. The thermostat stops the flow of coolant through the radiator until the coolant reaches a preset temperature.

When you replace your thermostat, an AC® thermostat is recommended.

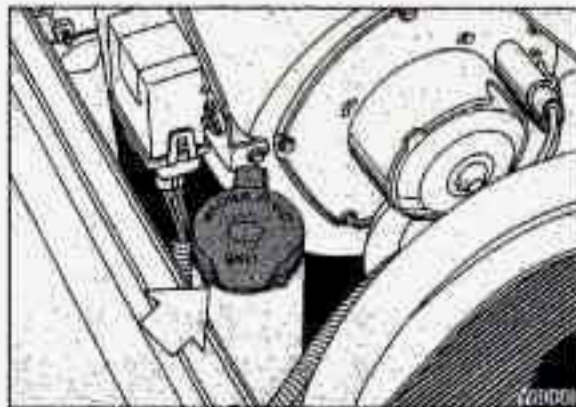
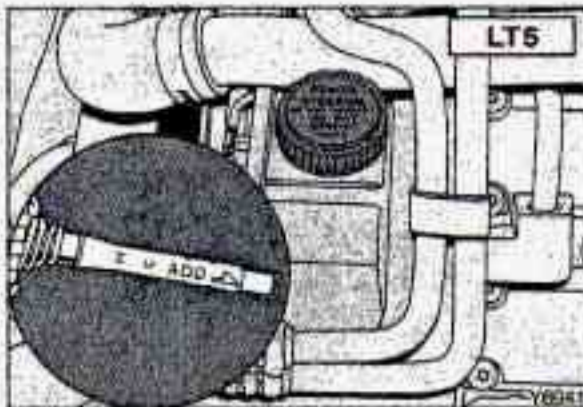
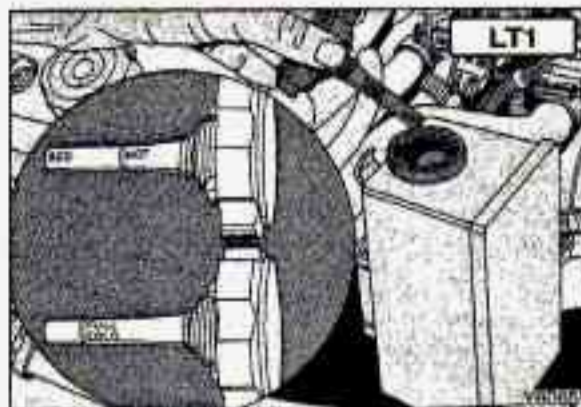

Power Steering Fluid

How To Check Power Steering Fluid:

Unscrew the cap and wipe the dipstick with a clean rag. Replace the cap and completely tighten it. Then remove the cap again and look at the fluid level on the dipstick.

- When the engine compartment is hot, the level should be at the **HOT** or **H** mark.
- When the engine compartment is cool, the level should be at the **FULL COLD** or **C** mark.

What to Add:

Refer to the Maintenance Schedule to determine what kind of fluid to use. See the *Index* under *Fluids & Lubricants*.

NOTICE

When adding power steering fluid or making a complete fluid change, always use the proper fluid. Failure to use the proper fluid can cause leaks and damage hoses and seals.

Windshield Washer Fluid

To Add:

Open the cap labeled **WASHER FLUID ONLY**. Add washer fluid until the bottle is full.

Service & Appearance Care

Windshield Washer Fluid (CONT.)

NOTICE

- When using concentrated washer fluid, follow the manufacturer's instructions for adding water.
- Don't mix water with ready-to-use washer fluid. Water can cause the solution to freeze and damage your washer fluid tank and other parts of the washer system. Also, water doesn't clean as well as washer fluid.
- Fill your washer fluid tank only $\frac{3}{4}$ full when it's very cold. This allows for expansion, which could damage the tank if it is completely full.
- Don't use radiator antifreeze in your windshield washer. It can damage your washer system and paint.

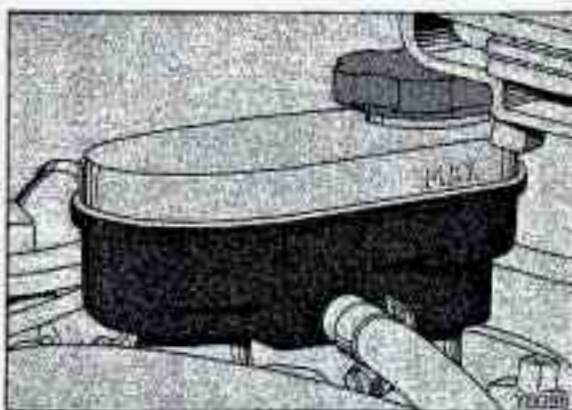

Brake Master Cylinder

Your brake master cylinder is filled with DOT-3 brake fluid.

There are only two reasons why the brake fluid level in your master cylinder might go down. The first is that the brake fluid goes down to an acceptable level during normal brake lining wear. When new linings are put in, the fluid level goes back up.

The other reason is that fluid is leaking out of the brake system. If it is, you should have your brake system fixed, since a leak means that sooner or later your brakes won't work well, or won't work at all.

So, it isn't a good idea to "top off" your brake fluid. Adding brake fluid won't correct a leak. If you add fluid when your linings are worn, then you'll have too much fluid when you get new brake linings. You should add (or remove) brake fluid, as necessary, only when work is done on the brake hydraulic system.

CAUTION



If you have too much brake fluid, it can spill on the engine. The fluid will burn if the engine is hot enough. You or others could be burned, and your vehicle could be damaged. Add brake fluid only when work is done on the brake hydraulic system.

When your brake fluid falls to a low level, your brake warning light, **SERVICE ABS** light and **SERVICE ASR** light will come on. The anti-lock brake and acceleration slip regulation systems are disabled when your brake fluid falls to a low level. See the *Index* under *Brake System Warning Light*.

To Add Brake Fluid:

Lift the cap and pour in fluid to the **MAX** mark on the master cylinder. Do not overfill.

What to Add:

When you do need brake fluid, use only DOT-3 brake fluid—such as Delco Supreme 11® (GM Part No. 1052535). Use new brake fluid from a sealed container only.

NOTICE

- DOT-5 silicone brake fluid can damage your vehicle. Don't use it.
- Don't let someone put in the wrong kind of fluid. For example, just a few drops of mineral-based oil, such as engine oil, in your brake system can damage brake system parts so badly that they'll have to be replaced.
- Brake fluid can damage paint, so be careful not to spill brake fluid on your vehicle.

Replacing Brake System Parts

The braking system on a modern vehicle is complex. Its many parts have to be of top quality and work well together if the vehicle is to have really good braking. Vehicles we design and test have top-quality GM brake parts in them, as your Corvette does when it is new. When you replace parts of your braking system—for example, when your brake linings wear down and you have to have new ones put in—be sure you get new genuine GM replacement parts. If you don't, your brakes may no longer work properly. For example, if someone puts in brake linings that are wrong for your vehicle, the balance between your front and rear brakes can change, for the worse. The braking performance you've come to expect can change in many other ways if someone puts in the wrong replacement brake parts.

Service & Appearance Care

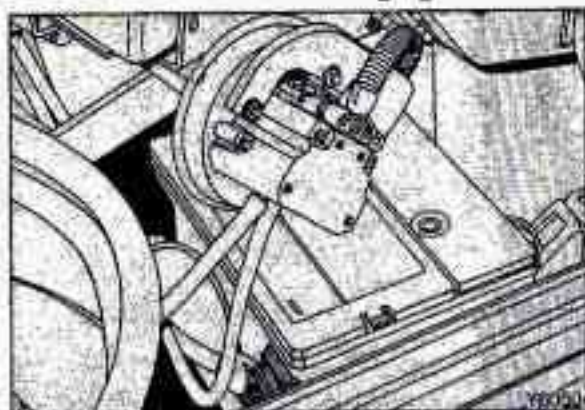

Battery

Every new Corvette has a Delco Freedom® battery. You never have to add water to one of these. When it's time for a new battery, we recommend a Delco Freedom® battery. Get one that has the catalog number shown on the original battery's label.

Jump Starting

For jump starting instructions, see the *Index* under *Jump Starting*.

Vehicle Storage

If you're not going to drive your vehicle for 25 days or more, take off the black, negative (-) cable from the battery. This will help keep your battery from running down.

CAUTION



Batteries have acid that can burn you and gas that can explode. You can be badly hurt if you aren't careful. See the *Index* under *Jump Starting* for tips on working around a battery without getting hurt.

Contact your dealer to learn how to prepare your vehicle for longer storage periods.

Halogen Bulbs

CAUTION



Halogen bulbs have pressurized gas inside and can burst if you drop or scratch the bulb. You or others could be injured. Take special care when handling and disposing of halogen bulbs.

Headlight Bulb Replacement

To change your Corvette's headlights, you'll need a Phillips screwdriver and a #15 Torx® driver.

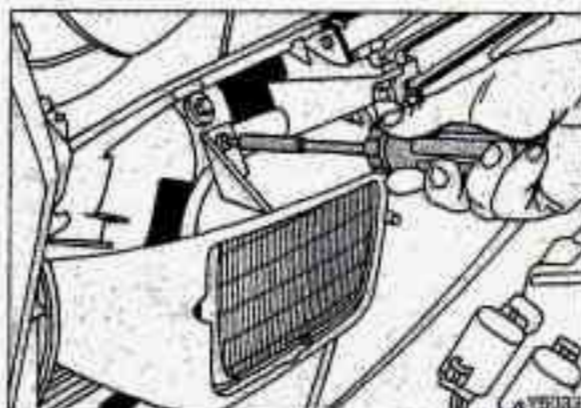
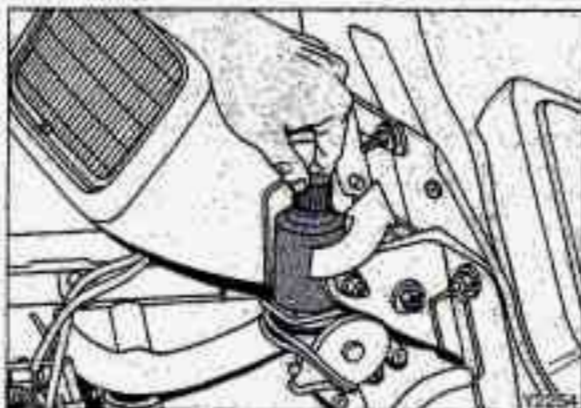

1. Release the hood latch and raise the hood to the open position.
2. The headlights need to be halfway open. Turn the switch to the headlights **ON** position, then quickly back to the parking lights **ON** position. You may have to do this a few times until you get the headlights in the halfway-open position. Or you can open the headlights manually. See the *Index* under *Concealed Headlights*.
3. From the engine compartment side, remove the two Torx® screws on each side of the front of the headlight.

Service & Appearance Care

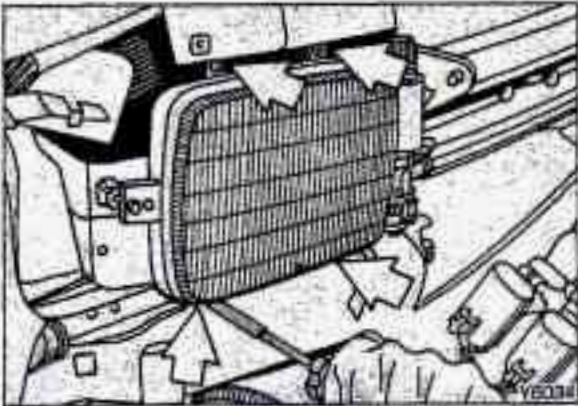
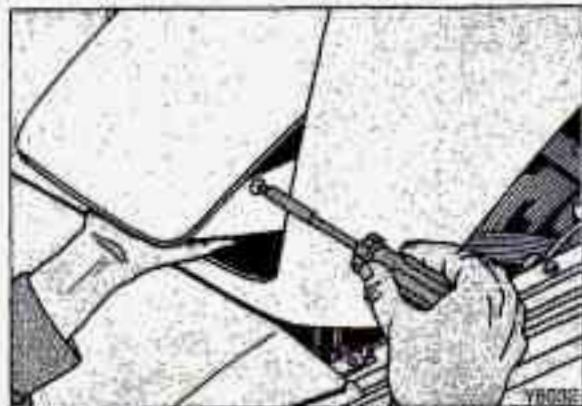

Headlight Bulb Replacement (CONT.)

4. Then remove the two Phillips screws from both sides of the cover, but before you remove the last screw, put your hand under the headlight cover to hold it.
5. Then reach around the hood and pull the cover straight out. Be careful not to scratch the paint.

6. From the engine compartment side, remove the four Phillips screws from the retainer. These screws are near each corner of the headlight. Don't disturb the large-head adjusting screws or your headlight will be improperly aimed.
Hold the headlight when all the screws are removed. Then remove the retainer.

7. Remove the headlight and unplug the electrical connector.
8. Plug in the new headlight and replace the headlight retainer and screws.
9. Replace the headlight cover.
10. Turn off the parking lights.

Headlight Aiming

Improperly aimed headlights can be dangerous. Periodic headlight checks for proper aiming and adjustment are strongly recommended. Your Chevrolet dealer is well equipped to provide such service.

Fog Light Bulb Replacement

The fog lights can be reached from under the front bumper.

CAUTION



Halogen bulbs have pressurized gas inside and can burst if you drop or scratch the bulb. You or others could be injured. Take special care when handling and disposing of halogen bulbs.

1. Remove the hex-head screw using a 7 mm hex-head socket.
2. Open the door. Then reach up into the fog light assembly for the bulb.

3. Rotate the bulb base counter-clockwise $\frac{1}{8}$ turn. Then pull the bulb base out.
4. Carefully disconnect the bulb base from the wiring harness.
5. Insert the new bulb and then reconnect the wiring harness. Close and secure the door.

If your fog lights become improperly aimed, have your Chevrolet dealer aim them for you.

Service & Appearance Care

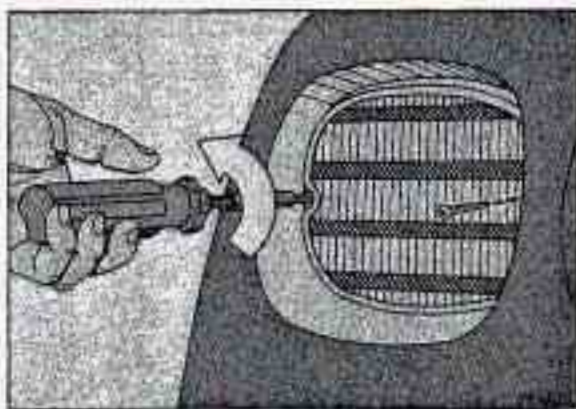

Front Turn Signal Light Replacement

To replace a front turn signal bulb on your Corvette, follow these steps:

1. Release the hood latch and raise the hood to the open position.
2. From the engine compartment side, remove the front turn signal light by rotating the bulb socket counter-clockwise $\frac{1}{4}$ turn and pulling it out.
3. Replace the light.
4. To reinstall the bulb socket, match the three locking tabs on the socket with the three notches on the housing.
5. Push the bulb socket into the housing and rotate it clockwise.

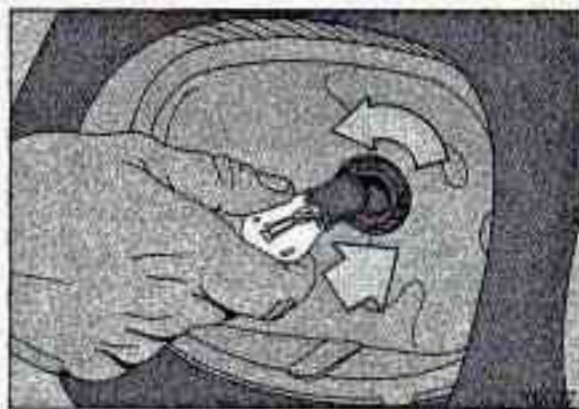

Rear Turn Signal and Taillight Replacement

To replace a rear turn signal and taillight on your Corvette, follow these steps:

1. Use a #15 Torx® driver to remove the screws from the lens.
2. Pull the lens out.
3. Push the bulb in and turn counter-clockwise. Remove the bulb from the socket.
4. Replace the bulb by pushing the new bulb in and turning it clockwise.
5. Replace the lens. To prevent water from getting inside the lens, make sure the lens seal is properly positioned. Tighten the screws.

Back-up Light Replacement

You can service the back-up lights by removing the license plate and reaching through the opening. To replace a back-up light on your Corvette, follow these steps:

1. Push the tab on the bulb socket in and turn it counterclockwise. Remove the bulb from the socket.
2. Push the new bulb in and turn it clockwise.
3. Reinstall the bulb socket. Be sure the tab on the socket latches.
4. Reinstall the license plate.

Side Marker Light Replacement

You can service the front side marker lights from inside the engine compartment. Service the rear side marker lights from underneath the vehicle. To replace a side marker light on your Corvette, follow these steps:

1. To remove the bulb socket, rotate the bulb socket counterclockwise $\frac{1}{4}$ turn and pull it out.
2. Replace the bulb.
3. To reinstall the bulb socket, push it into the housing and turn it clockwise.

Front Cornering Light Replacement

To replace a cornering light on your Corvette, follow these steps:

1. Release the hood latch and raise the hood.
2. From the engine compartment side, press the tab on the bulb socket and rotate the socket counterclockwise $\frac{1}{4}$ turn.
3. Pull the bulb socket out and replace the bulb.
4. To reinstall the bulb socket, match the three locking tabs on the socket with the three notches on the housing.
5. Press the tab on the bulb socket and push the bulb socket into the housing.
6. Rotate the bulb socket clockwise.

Service & Appearance Care

Rear Cargo Compartment Light Replacement (COUPE)

To replace a rear cargo compartment light in your Corvette coupe, follow these steps:

1. Remove the cargo light cover by carefully prying it off with a screwdriver.
2. Replace the bulb.
3. Position the cover over the opening and press into place.

Rear Cargo Compartment Light Replacement (CONVERTIBLE)

To replace a rear cargo compartment light in your Corvette convertible, follow these steps:

1. Remove the cargo light assembly by carefully prying it out with a screwdriver.
2. Replace the bulb.
3. Position the light assembly over the opening and press it into place.

Center High-Mounted Stop Light Replacement (EXCEPT ZR-1)

You can service this light by removing the license plate and reaching through the opening. To replace the center high-mounted stop light on your Corvette, follow these steps:

1. Rotate the bulb socket counter-clockwise $\frac{1}{4}$ turn and pull out.
2. Replace the bulb.
3. To reinstall the bulb socket, push it into the housing and turn it clockwise.
4. Reinstall the license plate.

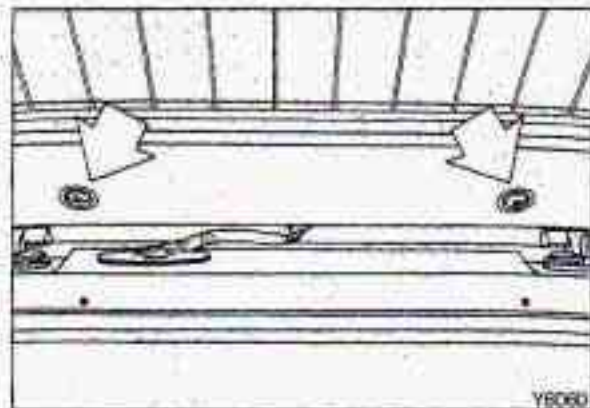

Center High-Mounted Stop Light Replacement (ZR-1)

1. Open the hatch and remove the two Torx®-head screws on the underside of the hatch near the roofline.
2. Carefully pull the stop light assembly away from the roof.

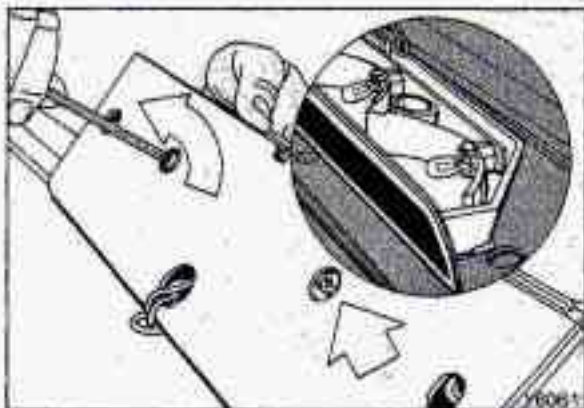

3. Then remove the two Phillips head screws on the underside of the assembly.
4. Remove the rubber backing and then carefully pry the lens from the assembly.
5. To remove the bulb, gently rock the bulb back and forth in its socket while pulling up.
6. Replace the bulb. To reassemble the stop light, reverse steps 1-3.

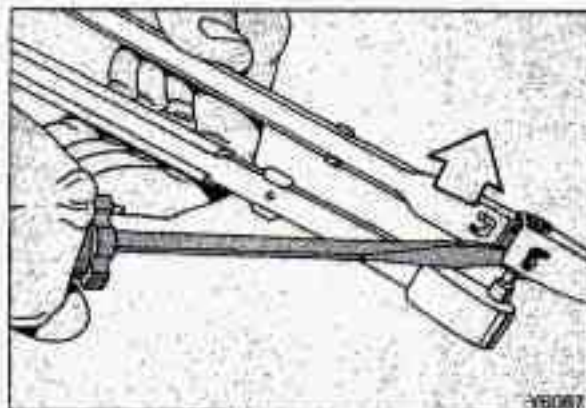

Windshield Wiper Blade Rotation and Replacement

It's a good idea to rotate the wiper blade assembly 180° every six months. This changes the wear pattern and increases the life of the wiper blade insert. To rotate or replace your windshield wipers:

1. Pull the wiper arm away from the windshield.
2. Disconnect the wiper blade assembly by pressing down with a screwdriver tip on the exposed portion of the spring. Pull the wiper blade off while holding the spring down in the released position.
3. Rotate the wiper blade assembly 180° and push it securely onto the wiper arm.

Service & Appearance Care



Loading Your Vehicle

Two labels on your vehicle show how much weight it may properly carry. The Tire-Loading Information label found on the rear edge of the driver's door tells you the proper size, speed rating and recommended inflation pressures for the tires on your vehicle. It also gives you important information about the number of people that can be in your vehicle and the total weight that you can carry. This weight is called the Vehicle Capacity Weight and includes the weight of all occupants, cargo, and all nonfactory-installed options.

The other label is the Certification label, also on the rear edge of the driver's door. It tells you the gross weight capacity of your vehicle, called the GVWR (Gross Vehicle Weight Rating). The GVWR includes the weight of the vehicle, all occupants, fuel and cargo. Never exceed the GVWR for your vehicle, or the Gross Axle Weight Rating (GAWR) for either the front or rear axle.

And, if you do have a heavy load, you should spread it out. Don't carry more than 100 lbs. (45 kg) in the rear area of your Corvette.

CAUTION



Do not load your vehicle any heavier than the GVWR or the maximum front and rear GAWRs. If you do, parts on your vehicle can break, or it can change the way your vehicle handles. These could cause you to lose control. Also, overloading can shorten the life of your vehicle.

NOTICE

Your warranty does not cover parts or components that fail because of overloading.

If you put things inside your vehicle—like suitcases, tools, packages, or anything else—they will go as fast as the vehicle goes. If you have to stop or turn quickly, or if there is a crash, they'll keep going.

CAUTION



Things you put inside your vehicle can strike and injure people in a sudden stop or turn, or in a crash.

- Put things in the rear area of your vehicle.
- Try to spread the weight evenly.
- Never stack heavier things, like suitcases, inside the vehicle so that some of them are above the tops of the seats.
- When you carry something inside the vehicle, secure it whenever you can.
- Don't leave a seat folded down unless you need to.

■ *Tires*

We don't make tires. Your new vehicle comes with high quality tires made by a leading tire manufacturer. These tires are warranted by the tire manufacturers and their warranties are delivered with every new Corvette. If your spare tire is a different brand than your road tires, you will have a tire warranty folder from each of these manufacturers.

Service & Appearance Care

■ Tires (Cont.)

CAUTION



Poorly maintained and improperly used tires are dangerous.

- Overloading your tires can cause overheating as a result of too much friction. You could have an air-out and a serious accident. See the *Index* under *Loading Your Vehicle*.
- Underinflated tires pose the same danger as overloaded tires. The resulting accident could cause serious injury. Check all tires frequently to maintain the recommended pressure. Tire pressure should be checked when your tires are cold.
- Overinflated tires are more likely to be cut, punctured, or broken by sudden impact, such as when you hit a pothole. Keep tires at the recommended pressure.
- Worn, old tires can cause accidents. If your tread is badly worn, or if your tires have been damaged, replace them.

Inflation—Tire Pressure

The Tire-Loading Information label which is on the rear edge of the driver's door shows the correct inflation pressures for your tires, when they're cold. "Cold" means your vehicle has been sitting for at least three hours or driven no more than a mile.

If you have to check tires when they're not cold, add 4 psi (28 kPa) to the numbers on the sticker.

NOTICE

Don't let anyone tell you that underinflation or overinflation is all right. It's not. If your tires don't have enough air (underinflation), you can get:

- Too much flexing
- Too much heat
- Tire overloading
- Bad wear
- Bad handling
- Bad fuel economy.

If your tires have too much air (overinflation), you can get:

- Unusual wear
- Bad handling
- Rough ride
- Needless damage from road hazards.

When to Check:

Check your tires once a month or more. Don't forget your compact spare tire. It should be at 60 psi (420 kPa).

How to Check:

Use the tire pressure gage provided in your center storage console to check tire pressure. Simply looking at the tires will not tell you the pressure, especially if you have radial tires—which may look properly inflated even if they're underinflated.

If your tires have valve caps, be sure to put them back on. They help prevent leaks by keeping out dirt and moisture.

Tire Rotation

The tires on your Corvette are directional, asymmetrical, and are different sizes front to rear. Due to this, your tires should not be rotated. Each tire and wheel should be used only in the position it is in.

Service & Appearance Care

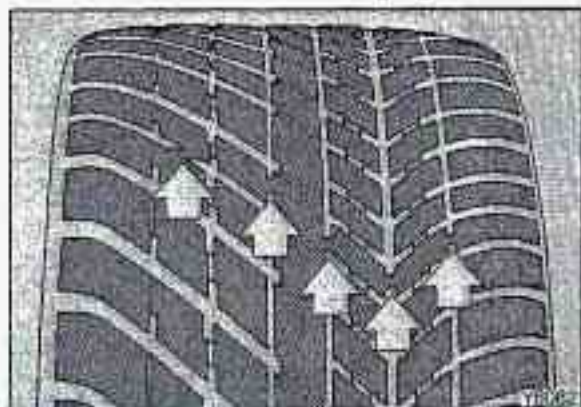

When It's Time for New Tires

One way to tell when it's time for new tires is to check the treadwear indicators, which will appear when your tires have only $\frac{2}{32}$ inch (1.6 mm) or less of tread remaining.

You need a new tire if:

- You can see the indicators at three places around the tire.
- You can see cord or fabric showing through the tire's rubber.
- The tread or sidewall is cracked, cut or snagged deep enough to show cord or fabric.
- The tire has a bump, bulge or split.
- The tire has a puncture, cut or other damage that can't be repaired well because of the size or location of the damage.

Buying New Tires

To find out what kind and size of tires you need, look at the Tire-Loading Information label. The tires installed on your vehicle when it was new had a Tire Performance Criteria Specification (TPC Spec) number on each tire's sidewall. When you get new tires, get ones with that same TPC Spec number. That way, your vehicle will continue to have tires that are designed to give proper endurance, handling, speed rating, traction, ride and other things during normal service on your vehicle.

If your tires have an all-season tread design, the TPC Spec number will be followed by an "MS" (for mud and snow).

If you ever replace your tires with those not having a TPC Spec number, make sure they are the same size, load range, speed rating and construction type (bias, bias-belted or radial) as your original tires.

CAUTION



Mixing tires could cause you to lose control while driving. If you mix tires of different sizes or types (radial and bias-belted tires), the vehicle may not handle properly, and you could have a crash. Be sure to use the same size and type tires on all four wheels.

It's all right to drive with your compact spare, though. It was developed for limited use on your vehicle.

■ *Uniform Tire Quality Grading*

The following information relates to the system developed by the United States National Highway Traffic Safety Administration which grades tires by treadwear, traction and temperature performance. (This applies only to vehicles sold in the United States.)

Treadwear

The treadwear grade is a comparative rating based on the wear rate of the tire when tested under controlled conditions on a specified government test course. For example, a tire graded 150 would wear one and a half (1½) times as well on the government course as a tire graded 100. The relative performance of tires depends upon the actual conditions of their use, however, and may depart significantly from the norm due to variations in driving habits, service practices and differences in road characteristics and climate.

Service & Appearance Care

Traction—A, B, C

The traction grades, from highest to lowest are: A, B, and C. They represent the tire's ability to stop on wet pavement as measured under controlled conditions on specified government test surfaces of asphalt and concrete. A tire marked C may have poor traction performance.

Warning: The traction grade assigned to this tire is based on braking (straight-ahead) traction tests and does not include cornering (turning) traction.

Temperature—A, B, C

The temperature grades are A (the highest), B, and C, representing the tire's resistance to the generation of heat and its ability to dissipate heat when tested under controlled conditions on a specified indoor laboratory test wheel. Sustained high temperature can cause the material of the tire to degenerate and reduce tire life, and excessive temperature can lead to sudden tire failure. The grade C corresponds to a level of performance which all passenger car tires must meet under the Federal Motor Vehicle Safety Standard No. 109. Grades B and A represent higher levels of performance on the laboratory test wheel than the minimum required by law.

Warning: The temperature grade for this tire is established for a tire that is properly inflated and not overloaded. Excessive speed, underinflation, or excessive loading, either separately or in combination, can cause heat buildup and possible tire failure.

Those grades are molded on the sidewalls of passenger car tires.

While the tires available as standard or optional equipment on General Motors vehicles may vary with respect to these grades, all such tires meet General Motors performance standards and have been approved for use on General Motors vehicles. All passenger type (P Metric) tires must conform to federal safety requirements in addition to these grades.

Wheel Alignment and Tire Balance

The wheels on your vehicle were aligned and balanced carefully at the factory to give you the longest tire life and best overall performance.

In most cases, you will not need to have your wheels aligned again. However, if you notice unusual tire wear or your vehicle pulling one way or the other, the alignment may need to be reset. If you notice your vehicle vibrating when driving on a smooth road, your wheels may need to be rebalanced.

Wheel Replacement

Replace any wheel that is bent, cracked or badly rusted. If wheel nuts keep coming loose, the wheel, wheel bolts, and wheel nuts should be replaced. If the wheel leaks air out, replace it (except some aluminum wheels, which can sometimes be repaired). See your Chevrolet dealer if any of these conditions exist. Your dealer will know the kind of wheel you need.

Each new wheel should have the same load carrying capacity, diameter, width, offset, and be mounted the same way as the one it replaces.

If you need to replace any of your wheels, wheel bolts, or wheel nuts, replace them only with new GM original equipment parts. This way, you will be sure to have the right wheel, wheel bolts, and wheel nuts for your Corvette.

CAUTION



Using the wrong replacement wheels, wheel bolts, or wheel nuts on your vehicle can be dangerous. It could affect the braking and handling of your vehicle, make your tires lose air and make you lose control. You could have a collision in which you or others could be injured. Always use the correct wheel, wheel bolts, and wheel nuts for replacement.

Service & Appearance Care

Wheel Replacement (CONT.)

NOTICE

The wrong wheel can also cause problems with bearing life, brake cooling, speedometer/odometer calibration, headlight aim, bumper height, vehicle ground clearance, and tire clearance to the body and chassis.

Used Replacement Wheels

CAUTION



Putting a used wheel on your vehicle is dangerous. You can't know how it's been used or how many miles it's been driven. It could fail suddenly and cause an accident. If you have to replace a wheel, use a **new** GM original equipment wheel.

Tire Chains

NOTICE

Don't use tire chains; they can damage your Corvette.



■ Appearance Care

CAUTION



Cleaning products can be hazardous. Some are toxic. Others can burst into flame if you strike a match or get them on a hot part of the vehicle. Some are dangerous if you breathe their fumes in a closed space. When you use anything in a container to clean your Corvette, be sure to follow the instructions. And always open your doors or windows when you're cleaning the inside.

Never use these to clean your vehicle:

- Gasoline
- Benzene
- Naphtha
- Carbon Tetrachloride
- Acetone
- Paint Thinner
- Turpentine
- Lacquer Thinner
- Nail Polish Remover

They can all be hazardous—some more than others—and they can all damage your vehicle, too.

NOTICE

Don't use any of these unless this manual says you can. In many uses, they will damage your vehicle:

- Laundry Soap
- Bleach
- Reducing Agents

Service & Appearance Care

Cleaning the Inside of Your Corvette

Use a vacuum cleaner often to get rid of dust and loose dirt. Wipe vinyl with a clean, damp cloth.

Your Chevrolet dealer has two GM cleaners—a solvent-type spot lifter and a foam-type powdered cleaner. They will clean normal spots and stains very well.

Here are some cleaning tips:

- Always read the instructions on the cleaner label.
- Clean up stains as soon as you can—before they set.

- Use a clean cloth or sponge, and change to a clean area often. A soft brush may be used if stains are stubborn.
- Use solvent-type cleaners in a well-ventilated area only. If you use them, don't saturate the stained area.
- If a ring forms after spot cleaning, clean the entire area immediately or it will set.

Using Foam-Type Cleaner on Fabric

- Vacuum and brush the area to remove any loose dirt.
- Always clean a whole trim panel or section. Mask surrounding trim along stitch or welt lines.
- Mix Multi-Purpose Powdered Cleaner following the directions on the container label.
- Use suds only and apply with a clean sponge.
- Don't saturate the material.
- Don't rub it roughly.
- As soon as you've cleaned the section, use a sponge to remove the suds.

- Rinse the section with a clean, wet sponge.
- Wipe off what's left with a slightly damp paper towel or cloth.
- Then dry it immediately with an air hose, a hair dryer or a heat lamp.

NOTICE

Be careful with a hair dryer or heat lamp. You could scorch the fabric.

- Wipe with a clean cloth.

Using Solvent-Type Cleaner on Fabric

First, see if you have to use solvent-type cleaner at all. Some spots and stains will clean off better with just water and mild soap.

If you need to use it, then:

- Gently scrape excess soil from the trim material with a clean, dull knife or scraper. Use very little cleaner, light pressure and clean cloths (preferably cheesecloth). Cleaning should start at the outside of the stain, "feathering" toward the center. Keep changing to a clean section of the cloth.
- When you clean a stain from fabric, immediately dry the area with an air hose, hair dryer, or heat lamp to help prevent a cleaning ring. (See previous NOTICE.)

Fabric Protection

Your Corvette has upholstery that has been treated with Scotchgard™ Fabric Protector, a 3M product. Scotchgard™ protects fabrics by repelling oil and water, which are the carriers of most stains. Even with this protection, you still need to clean your upholstery often to keep it looking new.

Further information on cleaning is available by calling 1-800-433-3296 (in Minnesota, 1-800-642-6167).

Service & Appearance Care

Special Cleaning Problems

Greasy or Oily Stains: Like grease, oil, butter, margarine, shoe polish, coffee with cream, chewing gum, cosmetic creams, vegetable oils, wax crayon, tar and asphalt.

- Carefully scrape off excess stain.
- Then follow the solvent-type instructions earlier in this section.
- Shoe polish, wax crayon, tar and asphalt will stain if left on a vehicle seat fabric. They should be removed as soon as possible. Be careful, because the cleaner will dissolve them and may cause them to bleed.

Non-Greasy Stains: Like catsup, coffee (black), egg, fruit, fruit juice, milk, soft drinks, wine, vomit, urine and blood.

- Carefully scrape off excess stain, then sponge the soiled area with cool water.
- If a stain remains, follow the foam-type instructions earlier in this section.
- If an odor lingers after cleaning vomit or urine, treat the area with a water/baking soda solution: 1 teaspoon (5 ml) of baking soda to 1 cup (250 ml) of lukewarm water.
- Finally, if needed, clean lightly with solvent-type cleaner.

Combination Stains: Like candy, ice cream, mayonnaise, chili sauce and unknown stains.

- Carefully scrape off excess stain, then clean with cool water and allow to dry.
- If a stain remains, clean it with solvent-type cleaner.

Cleaning the Carpeting In Your Corvette

Your vehicle has a color-fast solution dyed carpet. To clean this type of carpet:

Dry Stain: Carefully scrape off excess stain. Then use a small hand brush to gently remove the rest of the crusted material.

Wet Stain: Carefully blot the stain with an absorbent cloth, paper towel or sponge.

If the stain persists, treat the area with a solution of four parts water to one part household bleach (5.25% solution) and let stand for approximately one hour. Then rinse thoroughly with a detergent/water solution. Follow this with three additional rinsings of water only, thoroughly blotting the area after each application.

NOTICE

Don't use a bleach or a bleach application on any interior trim except the carpeting. When cleaning the carpeting, limit the use of a bleach or bleach application on the carpeting. This will help minimize deterioration to the carpet fibers and backing. When using a bleach or bleach application, rinse and blot the affected area repeatedly with plain water to remove any excess detergent or bleach residue.

Cleaning Vinyl or Leather

Just use warm water and a clean cloth.

- Rub with a clean, damp cloth to remove dirt. You may have to do it more than once.
- Things like tar, asphalt and shoe polish will stain if you don't get them off quickly. Use a clean cloth and solvent-type vinyl/leather cleaner.

Cleaning "Soft Touch" Surfaces

There are many "Soft Touch" paint surfaces in your Corvette. Use only mild soap and water to clean these surfaces. For protection, use ArmorAll® or an equivalent product.



Service & Appearance Care

Cleaning the Top of the Instrument Panel

Use only mild soap and water to clean the top surfaces of the instrument panel. Sprays containing silicones or waxes may cause annoying reflections in the windshield and even make it difficult to see through the windshield under certain conditions.

Cleaning Speaker Covers

Vacuum around a Delco-Bose® speaker cover gently, so that the speaker won't be damaged. If something gets on one of them, follow the steps earlier under *Using Solvent-Type Cleaner on Fabric*. Use as little solvent as you can.

Cleaning "Dulso"-Coated Molding

- Your Corvette's inside rear window (hatch area) molding is "Dulso" coated.
- For lightly soiled molding, wipe with a sponge or a soft lint-free cloth that has been dampened with water.
 - For heavily soiled molding, use warm soapy water.
 - You can recondition molding showing marks or scratches by briskly wiping the area with GM Fabric Cleaner (solvent type). Don't use too much cleaner. If a ring forms, immediately repeat the cleaning procedure over a slightly larger area, "feathering" toward the center of the ring. If the ring still remains, wipe the entire molding.

Care of Safety Belts

Keep belts clean and dry.

CAUTION



Do not bleach or dye safety belts. If you do, it may severely weaken them. In a crash they might not be able to provide adequate protection. Clean safety belts only with mild soap and lukewarm water.

Glass

Glass should be cleaned often. GM Glass Cleaner (GM Part No. 1050427) or a liquid household glass cleaner will remove normal tobacco smoke and dust films.

Don't use abrasive cleaners on glass, because they may cause scratches. Avoid placing decals on the inside rear window, since they may have to be scraped off later.

If abrasive cleaners are used on the inside of the rear window, an electric defogger element may be damaged. Any temporary license should not be attached across the defogger grid.

Cleaning the Outside of the Windshield and Wiper Blades

If the windshield is not clear after using the windshield washer, or if the wiper blade chatters when running, wax or other material may be on the blade or windshield.

Clean the outside of the windshield with GM Windshield Cleaner, Bon-Ami Powder® (GM Part No. 1050011). The windshield is clean if beads do not form when you rinse it with water.

Clean the blade by wiping vigorously with a cloth soaked in full strength windshield washer solvent. Then rinse the blade with water.

Wiper blades should be checked on a regular basis and replaced when worn.

Service & Appearance Care

Cleaning the Outside of Your Corvette

The paint finish on your vehicle provides beauty, depth of color, gloss retention and durability.

Washing Your Vehicle

The best way to preserve your vehicle's finish is to keep it clean by washing it often with lukewarm or cold water.

Don't wash your vehicle in the direct rays of the sun. Don't use strong soaps or chemical detergents. Use liquid hand, dish or car washing (non-detergent) soaps. Don't use cleaning agents that contain acid or abrasives. All cleaning agents should be flushed promptly and not allowed to dry on the surface, or they could stain. Dry the finish with a soft, clean chamois or a 100% cotton towel to avoid surface scratches and water spotting.

High pressure vehicle washes may cause water to enter your vehicle.

Automatic Vehicle Washes

NOTICE

Some automatic vehicle washes may damage your Corvette:

- Abrasive-type tire cleaning brushes can damage the aluminum wheels.
- Top cleaning brushes can scratch the plastic rear window and damage the top of convertibles.
- Conveyor systems may not have enough clearance under your vehicle and can damage your Corvette's undercarriage.
- Conveyor systems may not have enough clearance for your ZR-1's extra wide rear tires and can damage your Corvette.

Check with the owner or operator before using an automatic vehicle wash.

Cleaning Your Removable Roof Panel

If your Corvette is equipped with the transparent removable roof panel option, the panel is made of acrylic plastic with a special hard coat to help resist abrasion. Special care is necessary when cleaning, removing and/or storing the roof panel.

- Flush off dust and dirt with water, then dry the panel.
- Clean the panel with GM Glass Cleaner. Leave the cleaner on the panel for one minute, then wipe the panel with a soft, lint-free cloth.
- **Don't use abrasive cleaning materials.**

Cleaning Your Convertible Top

Hand washing your Corvette's convertible top is highly recommended and the most preferred method of cleaning. Although most automatic vehicle washes will not harm the top's fabric, vehicle washes with water jets and hanging cloths are preferred to those using heavy barrel brushes.

Carefully vacuuming the convertible top before washing will help remove excess dust and other foreign particles.

Wash the vehicle in partial shade rather than direct sunlight. Use a sponge to wet the entire vehicle with a lukewarm mild soap solution. Using a chamois or cloth will leave lint on the top and using a brush may abrade the threads in the top's material. Wash the top uniformly to avoid spots or rings. Let the soap solution remain on fabric for two to five minutes.

NOTICE

Do not use detergents, harsh cleaners, solvents, or bleaching agents. They can damage the fabric.

Rinse the entire vehicle with water to remove all soap from fabric and to prevent streaking on painted surfaces. Acrylic fabric absorbs water but will dry quickly. Let the top dry in direct sunlight.

Several cleanings may be necessary. The application of water repellent, wax finishes, dressings or preservatives often cause stains that are difficult to remove.

A program of keeping the top clean by regular washings will enhance its life and make successive cleanings easier.

Service & Appearance Care

Cleaning Your Convertible Top (CONT.)

NOTICE

Be sure to dry off the top before you lower it. A damp top can become wrinkled. Trapped water can cause stains, mildew, or damage to the inside of your vehicle.

Care of Your Convertible's Rear Window

Your convertible top has a plastic rear window. It will bend, and that means it can be stored easily when you want to put the top down. However, like all such windows, it can show scratches. Special care is necessary when cleaning the rear window.

NOTICE

Don't use paper towels on the plastic rear window. They can scratch the plastic. Always use clean cotton cloths to wipe the window.

Don't use harsh cleaners or solvents like alcohol when you clean the plastic rear window. They can damage the plastic **and also** the painted surfaces on the vehicle.

Don't clean the plastic rear window without first pre-cleaning it. And don't use a brush or a dry cloth to pre-clean it. You could scratch the plastic. Always flush off any dust and dirt with water before cleaning.

- Flush off any dust and dirt on the window with water.
- Clean a small area of the window at a time using water only. With a clean cotton cloth, wipe the window using an up-and-down or side-to-side motion. Keep changing to a clean section of the cloth.

In the winter, when you need to get frost, snow or ice from the plastic window, you can use warm water if you have to, but never use a scraper or de-icer.

NOTICE

Don't use a scraper or de-icer on the plastic rear window. It can damage the plastic, and the scraper is very likely to leave scratch marks.

If you put things on your plastic rear window—things like stickers, labels, decals, or masking tape—they can be really hard to take off the plastic, and you can easily scratch it while you're trying to get them off.



Service & Appearance Care

Hardtop Care

Your optional hardtop has the same durable finish as the painted surfaces of your Corvette. Your hardtop may be cleaned, polished and waxed. If your hardtop is stored for an extended period, keep it covered in a dry place. Also, avoid the build-up of dust and dirt before storage or installation. Apply silicone grease or ArmorAll® to all hardtop weatherstrips.

Finish Care

Occasional waxing or mild polishing of your Corvette may be necessary to remove residue from the paint finish. You can get GM approved cleaning products from your dealer. (See the *Index* under *Appearance Care*.)

Your Corvette has a "basecoat/clearcoat" paint finish. The clearcoat gives more depth and gloss to the colored basecoat.

NOTICE

Machine compounding or aggressive polishing on a basecoat/clearcoat paint finish may dull the finish or leave swirl marks.

Cleaning the Engine

NOTICE

Do not use a cleaner with a strong alkaline base. It will discolor aluminum.

Aluminum Wheels

Your aluminum wheels have a protective coating similar to the painted surface of your Corvette. Don't use strong soaps, chemicals, chrome polish, or other abrasive cleaners on them because you could damage this coating. After rinsing thoroughly, a wax may be applied.

NOTICE

Don't use an automatic vehicle wash that has hard silicon carbide cleaning brushes. These brushes can take off the protective coating.

Weatherstrips

These are places where glass or metal meets rubber. Silicone grease there will make them last longer, seal better, and not squeak. Apply silicone grease with a clean cloth at least every six months.

NOTICE

Do not use petroleum based products such as petroleum jelly to dress your weatherstrips. Petroleum products will degrade weatherstrip coatings and eventually cause severe delamination.

Service & Appearance Care

Foreign Material

Calcium chloride and other salts, ice melting agents, road oil and tar, tree sap, bird droppings, chemicals from industrial chimneys, and other foreign matter can damage your vehicle's finish if they remain on painted surfaces. Use cleaners that are marked safe for painted surfaces for these stains.

Finish Damage

Any stone chips, fractures or deep scratches in the finish should be repaired right away.

Minor chips and scratches can be repaired with touch-up materials available from your dealer or other service outlets. Larger areas of finish damage can be corrected in your dealer's body and paint shop.

Underbody Maintenance

Chemicals used for ice and snow removal and dust control can collect on the underbody. If these are not removed, accelerated corrosion (rust) can occur on the underbody parts such as fuel lines, frame, floor pan, and exhaust system even though they have corrosion protection.

At least every spring, flush these materials from the underbody with plain water. Clean any areas where mud and other debris can collect. Dirt packed in closed areas of the frame should be loosened before being flushed. Your dealer or an underbody vehicle washing system can do this for you.

Fiberglass Springs

NOTICE

Don't use corrosive or acidic cleaning agents, engine degreasers, aluminum cleaning agents or other harsh solvents to clean fiberglass springs; they'll damage the springs.

Chemical Paint Spotting

Some weather and atmospheric conditions can create a chemical fallout. Airborne pollutants can fall upon and attack painted surfaces on your vehicle. This damage can take two forms: blotchy, ringlet-shaped discolorations, and small irregular dark spots etched into the paint surface.

Although no defect in the paint job causes this, Chevrolet will repair, at no charge to the owner, the surfaces of new vehicles damaged by this fallout condition within 12 months or 12,000 miles (20 000 km) of purchase, whichever comes first.

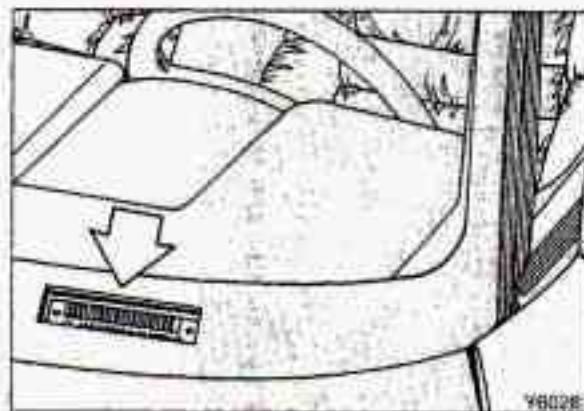

Vehicle Identification Number (VIN)

This is the legal identifier for your Corvette. It appears on a plate in the front corner of the instrument panel, on the driver's side. You can see it if you look through the windshield from outside your vehicle. The VIN also appears on the Vehicle Certification and Service Parts labels and the certificates of title and registration.

Service & Appearance Care

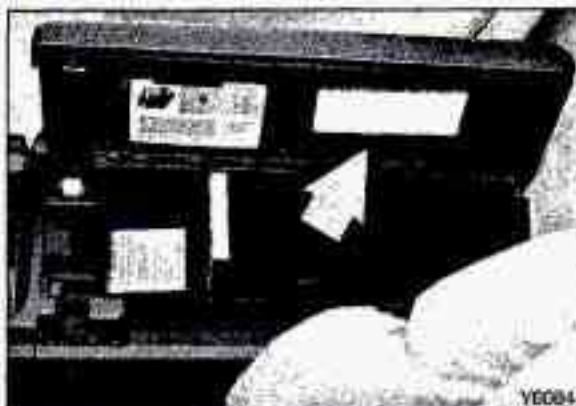

Engine Identification

The eighth character in your VIN is the engine code for your GM engine. This code will help you identify your engine, specifications, and replacement parts in this section.

Service Parts Identification Label

You'll find this label on the underside of the center storage console lid. It's very helpful if you ever need to order parts. On this label is:

- Your VIN.
- Its model designation.
- Paint information.
- A list of all production options and special equipment.

Be sure that this label is not removed from the vehicle.

Add-On Electrical Equipment

NOTICE

Don't add anything electrical to your Corvette unless you check with your dealer first. Some electrical equipment can damage your vehicle and the damage wouldn't be covered by your warranty. Some of it can just keep other things from working as they should. See the *Index* under *Accessory Wiring Plug*.



Fuses & Circuit Breakers

The wiring circuits in your vehicle are protected from short circuits by a combination of maxi-fuses, mini-fuses, and circuit breakers.

A fuse puller is clipped inside the fuse panel door. Place the wide end of the fuse puller over the plastic end of the fuse. Squeeze the ends over the fuse and pull it out.

The main fuse panel for your Corvette is located on the right side of the instrument panel. To access these mini-fuses, pull off the fuse panel door.



In addition, your Corvette has two maxi-fuse blocks in the engine compartment. One maxi-fuse block is integrated to the Forward Lamp harness located on the wheel house near the battery. The second maxi-fuse block is integrated to the ECM-Engine harness located at the rear of the battery.

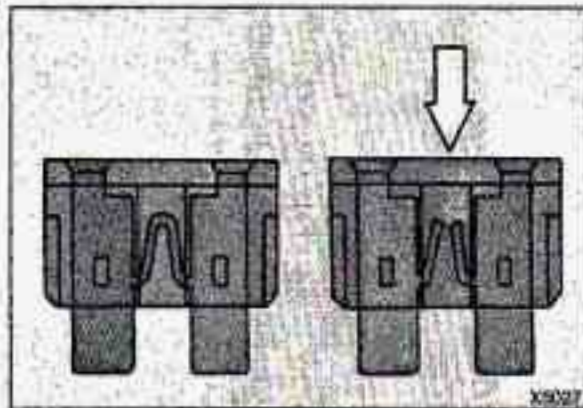

Look at the silver-colored band inside the fuse. If the band is broken or melted, replace the fuse. Be sure you replace a bad fuse with a new one of the correct size.

Service & Appearance Care

Fuse Usage

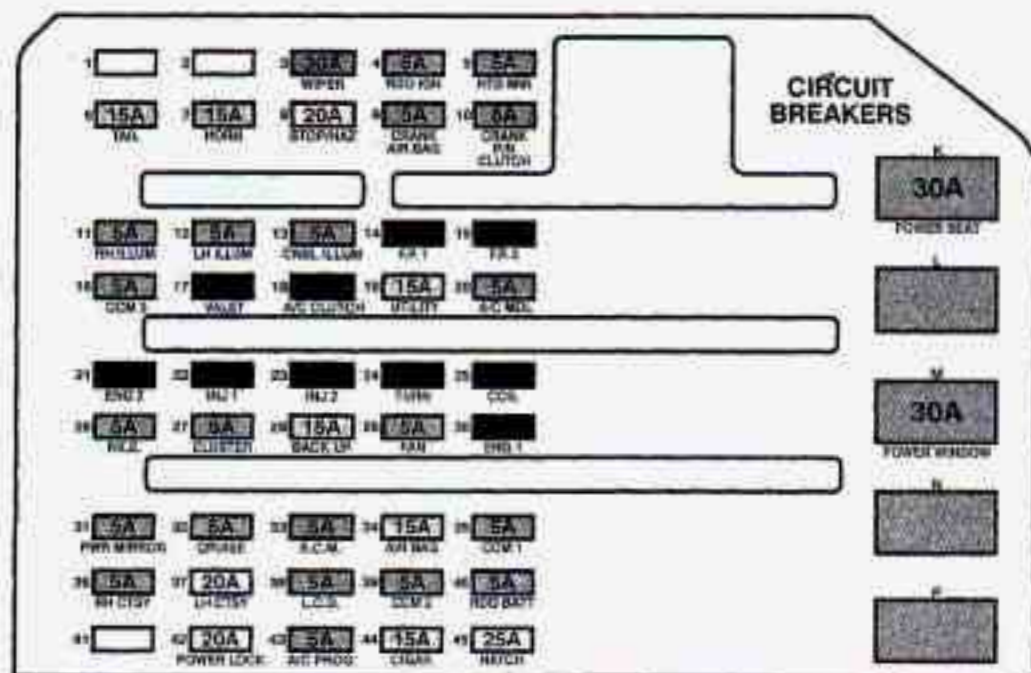

VE106

Position	Rating (AMP.)	Circuitry
1		Blank
2		Blank
3	30	Windshield Wiper/Washer Switch Assembly
4	5	Radio Receiver Box (Ignition)
5	5	Heated Mirrors
6	15	Taillamp, Daytime Running Lights Module
7	15	Horn Relay
8	20	Hazard Flashers; Brake Switch
9	5	Crank—Supplemental Inflatable Restraint System (Air Bag)
10	5	Crank—Park/Neutral Switch (Automatic); Clutch (Manual)
11	5	RH Illumination
12	5	LH Illumination
13	5	Console Illumination
14	10	Fuel Pump 1
15	10	Fuel Pump 2
16	5	Central Control Module; Daytime Running Lamps Module
17	10	Valet Mode; Alternator; Vacuum Pump (LT5); Oxygen Sensors (LT5)
18	10	A/C Compressor Clutch; Heater and A/C Control Head; Heater and A/C Programmer
19	15	Utility Plug
20	5	A/C Programmer
21	10	Fuel Pump Relay Coil #2 (LT5); Selective Ride Control Module; ABS Module; Transmission Clutch Control Switch (Automatic); Air Pump Relay; Diverter Valve
22	10	Injectors #1, 3, 5, 7 (LT1); Primary Injectors #1–8 (LT5); Ignition Coil Module (LT5)
23	10	Injectors #2, 4, 6, 8 (LT1); Secondary Injector Relays #1, 2 (LT5)
24	10	Turn Signal Flashers
25	10	Coil Module (LT1)
26	5	Passive Keyless Entry Module

Service & Appearance Care

Fuse Usage (CONT.)

Position	Rating (AMP.)	Circuitry
27	5	Instrument Cluster; Driver Information Center; Supplemental Inflatable Restraint (Air Bag) D.E.R.M.; Acceleration Slip Regulation Switch
28	15	Back-Up Lamps Switch; Gear Solenoid; Transmission Position Switch
29	5	Primary Cooling Fan Relay Coil; Secondary Cooling Fan Relay Coil
30	10	Secondary Butterfly Relay (LT5); Direct Ignition Module; Camshaft Sensor; Traction Buffer; Canister Purge Solenoid; Exhaust Gas Recirculation Control (LT1); Gear Relay (Manual)
31	5	Power Mirror Adjuster Control; Lighted Rearview Mirror; Visor Vanity Mirrors
32	5	Cruise Control Engage Switch; Daytime Running Lamps Module; Low Tire Pressure Warning Module
33	5	Engine Control Module
34	15	Supplemental Inflatable Restraint System
35	5	Central Control Module
36	5	Dome Lamp Relay; Footwell Courtesy Lamps; Door Courtesy Lamps; Glove Compartment Lamps; Lighted Rearview Mirror
37	20	Bose Amplifier Relay; Power Antenna Relay; Cargo Compartment Lamps
38	5	LCD Tone Generator
39	5	Central Control Module 2
40	5	Radio Receiver Box (Battery); Radio Control Head; Passive Keyless Entry Module
41		Blank
42	20	Power Door Lock Switches
43	5	A/C Programmer
44	15	Cigar Lighter
45	25	Hatch or Deck Lid Release Relay

Circuit Breakers:

K	30	Power Seats
L		Blank
M	30	Power Windows
N		Blank
P		Blank

Maxi-Fuse Blocks



**Forward Lamp
Maxi-Fuse Block**



**ECM-Engine
Maxi-Fuse Block**

* To access the underhood engine lights fuse, see the *Index* under *Underhood Engine Lights and Fuse*.

**Position Rating Circuitry
(AMP.)**

Forward Lamp Maxi-Fuse Block

Position	Rating (AMP.)	Circuitry
1	20	Interior Lighting
2	30	Primary Cooling Fan
3	30	LH Headlamp Motor
4	30	RH Headlamp Motor
5	40	Secondary Cooling Fan
6	60	Exterior Lighting
7	60	Power Accessory (Power Lock, Hatch, Cigar, Power Seats, A/C Programmer)
8	20	Air Pump

ECM-Engine Maxi-Fuse Block

Position	Rating (AMP.)	Circuitry
1	20	Engine Control Module
2	20	Fuel Pump
3	20	Anti-Lock Brakes, Acceleration Slip Regulation System
4	30	A/C Blower
5	40	Rear Defogger
6	60	Ignition
7	60	Ignition
8	40	Brake Hydraulics
*	10	Underhood Engine Lights

Service & Appearance Care

Electronic Heating and Air Conditioning

The blower motor for the optional (C68) Automatic Electronic Climate Control System is protected by a 5-amp underhood fuse. See your dealer for service.

Headlight Wiring

The headlight wiring is protected by a circuit breaker in the light switch. An electrical overload will cause the lights to go on and off, or in some cases to remain off. If this happens, have your headlight system checked right away.

Windshield Wipers

The windshield wiper motor is protected by a circuit breaker and a fuse. If the motor overheats due to heavy snow, etc., the wiper will stop until the motor cools. If the overload is caused by some electrical problem, have it fixed.

Power Windows and Other Power Options

Circuit breakers in the fuse panel protect the power windows and other power accessories. When the current load is too heavy, the circuit breaker opens and closes, protecting the circuit until the problem is fixed.

Capacities and Specifications

Fuel Tank	20.0 Gal.	75.7 L
Cooling System (LT1)	17.8 quarts	16.9 L
Cooling System (LT5)	14.7 quarts	13.9 L
Refrigerant, Air Conditioning	See refrigerant charge label under hood.	
<i>Not all air conditioning refrigerants are the same. If the air conditioning system in your vehicle needs refrigerant, be sure the proper refrigerant is used. If you're not sure, ask your Chevrolet dealer.</i>		
Crankcase (LT1)		
Without Filter Change*	4.0 quarts	3.8 L
With Filter Change*	4.5 quarts	4.3 L
Crankcase (LT5)		
Without Filter Change*	7.6 quarts	7.2 L
With Filter Change*	8.6 quarts	8.1 L
Automatic Transmission		
Drain and Refill*	10.0 pints	4.7 L
Overhaul*	21.6 pints	10.2 L
Manual Transmission		
Overhaul.....	4.4 pints	2.1 L
Wheel Nut Torque	100 pound-feet	(140 N•m)
Wheel Nut Cap Torque	22 pound-inches	(2.5 N•m)

* Recheck fluid level after refill as outlined in Part 6 of this manual. Brake System—fill at master cylinder to $\frac{1}{8}$ inch (6.4 mm) from top using fluid meeting SAE J1703A (DOT-3) Specifications.

Service & Appearance Care

Normal Maintenance Replacement Parts

PCV Valve (LT1)	AC Type CV895C
PCV Valves (LT5)	AC Type CV746CB AC Type CV913C
Air Cleaner Filter	AC Type A1097C
Engine Oil Filter (LT1)	AC Type PF51
Engine Oil Filter (LT5)	AC Type PF970C (black)
Spark Plug (LT1)	AC Type 41-906* (0.050" Gap)
Spark Plug (LT5)	AC Type 41-907* (0.050" Gap)
Serpentine Belt (LT1)	GM Part No. 10186198
Serpentine Belt (LT5)	GM Part No. 10067477
Battery (LT1)	Delco 75B-72
Battery (LT5)	Delco 75Z-72
Torx® Wrench	10172511
Flat Ratchet Wrench (Convertible Hardtop Only)	10137741
Coolant High Fill Reservoir Pressure Cap	AC Type RC36

* To remove spark plugs from engine with aluminum heads, allow the engine to cool. The heat of the engine, in combination with a plug that has run for many hours, may cause a plug to seize.

Engine Specifications

VIN Engine Code P, RPO LT1

Type	V8
Fuel Delivery	Multi-Port Fuel Injection
Valve Arrangement	OHV
Piston Displacement	5.7 Liters (350 CID)
Bore	4.0" (101.6 mm)
Stroke	3.48" (88.39 mm)
Compression Ratio	10.5:1
Firing Order	1-8-4-3-6-5-7-2
Thermostat Temp. Spec.	180°F (82°C)
Coolant High Fill Reservoir Pressure Cap	15 psi (103.4 kPa)

VIN Engine Code J, RPO LT5

Type	V8
Fuel Delivery	Multi-Port Fuel Injection
Valve Arrangement	DOHC, 4 Valves/Cylinder
Piston Displacement	5.7 Liters (350 CID)
Bore	3.90" (99 mm)
Stroke	3.66" (93 mm)
Compression Ratio	11.0:1
Firing Order	1-8-4-3-6-5-7-2
Thermostat Temp. Spec.	180°F (82°C)
Coolant High Fill Reservoir Pressure Cap	15 psi (103.4 kPa)

Service & Appearance Care

Replacement Bulbs

Exterior Lights	Bulb Number
Front Cornering	1156
Fog Light	896 (GM Part No. 9442467)
Front Headlight	HP6054
Front Parking Light/Turn Signal	2057NA
Front Side Marker	24
Rear Back-up	1156
Rear Cornering	1156
License	24
License (ZR-1)	24
Rear Side Marker	24
Rear Tail/Stop/Turn Signal	2057
CHMSL (ZR-1)	891
CHMSL (Coupe and Convertible)	1156

Interior Lights	Bulb Number
Glove Box.....	194
Air Conditioning/Heat Control.....	37
Auto Transmission Indicator.....	194NA
Console Compartment.....	564
Courtesy Light-Cargo.....	906
Flood-Door.....	73
Courtesy-Door.....	212-2
Courtesy-Floor.....	562
Courtesy-Rear (Convertible).....	562
Instrument Cluster.....	PC 161*
Driver Information Center.....	PC 74*
Radio.....	*
Underhood.....	211-2
Mirror-Reading Lights.....	168
Mirror-Console Flood.....	74
Visor Vanity Mirrors.....	74

* Not Owner Serviceable

Service & Appearance Care

Dimensions

Standard Exterior

Wheelbase.....	96.2 in.	(244.4 cm)
Length.....	178.5 in.	(453.5 cm)
Width.....	70.7 in.	(179.6 cm)
Height.....	46.3 in.	(117.7 cm)
Height (Convertible).....	47.3 in.	(120.2 cm)

ZR-1 Exterior

Wheelbase.....	96.2 in.	(244.4 cm)
Length.....	178.5 in.	(453.5 cm)
Width.....	73.1 in.	(185.6 cm)
Height.....	46.3 in.	(117.7 cm)

Interior

Head Room.....	36.5 in.	(92.7 cm)
Shoulder Room.....	53.9 in.	(136.8 cm)
Hip Room.....	50.8 in.	(129.0 cm)
Leg Room.....	42.0 in.	(106.8 cm)

Fluids & Lubricants

ITEM	APPLICATION	GM PART NUMBER	SIZE
Antifreeze Coolant..... (Ethylene Glycol Base)	Year-round antifreeze for..... coolant mixtures	1052753	1 gal. (3.785 L)
GM Engine Coolant Supplement..... (LT1 Only)	Cooling System.....	3634621	6 pellets
Chassis Lubricant..... (Grease Gun Insert)	General chassis lube, etc.....	1052497	14 oz. (397 g)
Delco Supreme 11® Brake Fluid	Brake System.....	1052535	16 oz. (0.473 L)
DEXRON®-III Automatic Transmission Fluid	Automatic Transmission.....	12345880 12345881	16 oz. (0.473 L) 32 oz. (0.946 L)
Corvette Manual Transmission Fluid SAE 5W-30.....	Manual Transmission	1052931	32 oz. (0.946 L)
GM Hydraulic Fluid	Clutch Master Cylinder.....	12345347	16 oz. (0.473 L)
Engine Oil.....	Engine.....	See the <i>Index</i> under <i>Engine Oil</i> .	

Service & Appearance Care

Fluids & Lubricants (CONT.)

ITEM	APPLICATION	GM PART NUMBER	SIZE
Limited-Slip Rear Axle Lubricant Additive	Rear Axle	1052358	4 oz. (0.118 L)
Special Gear Lubricant.....	Rear Axle	12345977	23 oz. (0.680 L)
Engine Oil	Hood, hatch and door hinges		
Windshield Washer Solvent	Windshield washer fluid.....	1051515	32 oz. (0.946 L)
Synthetic Power Steering Fluid	Power Steering System	12345867	32 oz. (0.946 L)
		12345866	16 oz. (0.473 L)
Silicone Grease	Weatherstrips.....	12345579	1 oz. (0.028 kg)
Spray-A-Squeak Silicone Lubricant	General purpose silicone lubricant,.....	1052276 (aerosol)	4.5 oz. (127 g)
	weatherstrips	1052277	12 oz. (0.354 L)

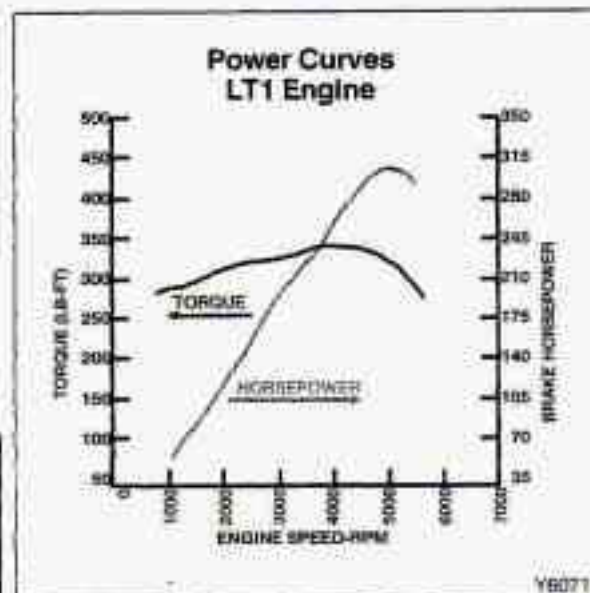

LT1 Engine

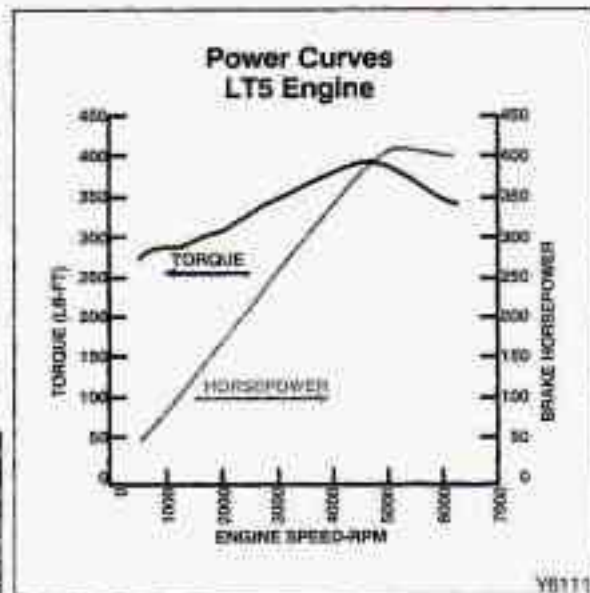

LT5 Engine

Notes

IMPORTANT
KEEP ENGINE OIL
AT THE PROPER
LEVEL AND CHANGE AS
RECOMMENDED

This part covers the maintenance required for your Corvette. Your vehicle needs these services to retain its safety, dependability and emission control performance.



**Protection
Plan**

Have you purchased the GM
Protection Plan?

The Plan supplements your new
vehicle warranties. See your
Chevrolet dealer for details.

Part 7 Maintenance Schedule

Section

Introduction

A Word About Maintenance	322
Your Vehicle and the Environment.....	322
How This Part is Organized.....	323
A. Scheduled Maintenance Services	
Using Your Maintenance Schedules.....	324
Selecting the Right Schedule.....	324
Schedule I	326
Schedule II	328
Explanation of Scheduled Maintenance Services	330
B. Owner Checks & Services	
At Each Fuel Fill.....	333
At Least Once a Month.....	333
At Least Once A Year.....	334
C. Periodic Maintenance Inspections.....	336
D. Recommended Fluids & Lubricants	337
E. Maintenance Record.....	340

Maintenance Schedule

Introduction

A Word About Maintenance

We at General Motors want to help you keep your vehicle in good working condition. But we don't know exactly how you'll drive it. You may drive very short distances only a few times a week. Or you may drive long distances all the time in very hot, dusty weather. You may use your vehicle in making deliveries. Or you may drive it to work, to do errands or in many other ways.

Because of all the different ways people use their GM vehicles, maintenance needs vary. You may even need more frequent checks and replacements than you will find in the schedules in this part. So please read this part and note how you drive. If you have any questions on how to keep your vehicle in good condition, see your Chevrolet dealer, the place many GM owners choose to have their maintenance work done. Your dealer can be relied upon to use proper parts and practices.

Your Vehicle and the Environment

Proper vehicle maintenance not only helps to keep your vehicle in good working condition, but also helps the environment. All recommended maintenance procedures are important. Improper vehicle maintenance or the removal of important components can significantly affect the quality of the air we breathe. Improper fluid levels or even the wrong tire inflation can increase the level of emissions from your vehicle. To help protect our environment, and to help keep your vehicle in good condition, please maintain your vehicle properly.

How This Part is Organized

The remainder of this part is divided into five sections:

Section A: Scheduled Maintenance Services shows what to have done and how often. Some of these services can be complex, so unless you are technically qualified and have the necessary equipment, you should let your dealer's service department or another qualified service center do these jobs.

CAUTION



Performing maintenance work on a vehicle can be dangerous. In trying to do some jobs, you can be seriously injured. Do your own maintenance work only if you have the required know-how and the proper tools and equipment for the job. If you have any doubt, have a qualified technician do the work.

If you are skilled enough to do some work on your vehicle, you will probably want to get the service information GM publishes. You will find a list of publications and how to get them in this manual. See the *Index* under *Service Publications*.

Section B: Owner Checks & Services tells you what should be checked whenever you stop for fuel. It also explains what you can easily do to help keep your vehicle in good condition.

Section C: Periodic Maintenance Inspections explains important inspections that your Chevrolet dealer's service department or another qualified service center should perform.

Section D: Recommended Fluids & Lubricants lists some products GM recommends to help keep your vehicle properly maintained. These products, or their equivalents, should be used whether you do the work yourself or have it done.

Section E: Maintenance Record provides a place for you to record the maintenance performed on your vehicle. Whenever any maintenance is performed, be sure to write it down in this section. This will help you determine when your next maintenance should be done. In addition, it is a good idea to keep your maintenance receipts. They may be needed to qualify your vehicle for warranty repairs.

Maintenance Schedule

Section A: Scheduled Maintenance Services

Using Your Maintenance Schedules

This section tells you the maintenance services you should have done and when you should schedule them. Your Chevrolet dealer knows your vehicle best and wants you to be happy with it. If you go to your dealer for your service needs, you'll know that GM-trained and supported service people will perform the work using genuine GM parts.

These schedules are for vehicles that:

- carry passengers and cargo within recommended limits. You will find these limits on your vehicle's Tire-Loading Information label. See the *Index* under *Loading Your Vehicle*.
- are driven on reasonable road surfaces within legal driving limits.
- use the recommended unleaded fuel. See the *Index* under *Fuel*.

Selecting the Right Schedule

First you'll need to decide which of the two schedules is right for your vehicle. Here's how to decide which schedule to follow:

Schedule I

Is any one of these true for your vehicle?

- Most trips are less than 4 miles (6 km).
- Most trips are less than 10 miles (16 km) when outside temperatures are below freezing.
- The engine is at low speed most of the time (as in stop-and-go traffic).
- You operate your vehicle in dusty areas.

If any one (or more) of these is true for your driving, follow Schedule I.

Schedule II

Follow Schedule II **only** if none of the above conditions is true.



Maintenance Schedule

Section A: Scheduled Maintenance Services (Cont.)

Schedule I

Follow Schedule I if your vehicle is **MAINLY** driven under one or more of the following conditions:

- When most trips are less than 4 miles (6 km).
- When most trips are less than 10 miles (16 km) and outside temperatures remain below freezing.
- When most trips include extended idling and/or frequent low-speed operation, as in stop-and-go traffic.
- When operating in dusty areas.

Schedule I should also be followed if the vehicle is used for delivery service, police, taxi or other commercial applications.

* An Emission Control Service.

☆ The U.S. Environmental Protection Agency has determined that the failure to perform this maintenance item will not nullify the emission warranty or limit recall liability prior to the completion of vehicle useful life. General Motors, however, urges that all recommended maintenance services be performed at the indicated intervals and the maintenance be recorded in Section E: Maintenance Record.

ITEM NO.	TO BE SERVICED <i>See Explanation of Scheduled Maintenance Services following Schedules I and II.</i>	WHEN TO PERFORM <i>Miles (kilometers) or Months (whichever occurs first).</i>
1	Engine Oil Change & Oil Filter Change*	Every 3,000 Miles (5,000 km) or 3 Months.
2	Chassis Lubrication	Every other oil change.
3	Engine Accessory Drive Belt Inspection	Every 30,000 Miles (50,000 km) or 24 Months.
4	Cooling System Service*	Every 30,000 Miles (50,000 km) or 24 Months.
5	Transmission Service	<i>See Explanation of Scheduled Maintenance Services following Schedules I and II.</i>
6	Spark Plug Replacement*	Every 100,000 Miles (167,000 km).
7	Spark Plug Wire Inspection*☆	Every 30,000 Miles (50,000 km).
8	Air Cleaner Filter Replacement*	Every 30,000 Miles (50,000 km).
9	Fuel Tank, Cap and Lines Inspection*☆	Every 30,000 Miles (50,000 km).

The services shown in this schedule up to 48,000 miles (80 000 km) are to be performed after 48,000 miles at the same intervals.

MILES (000)

3	6	9	12	15	18	21	24	27	30	33	36	39	42	45	48
---	---	---	----	----	----	----	----	----	----	----	----	----	----	----	----

KILOMETERS (000)

5	10	15	20	25	30	35	40	45	50	55	60	65	70	75	80
---	----	----	----	----	----	----	----	----	----	----	----	----	----	----	----

•	•	•	•	•	•	•	•	•	•	•	•	•	•	•	•
	•		•		•		•		•		•		•		•
									•						
									•						
									•						
									•						
									•						

Maintenance Schedule

Section A: Scheduled Maintenance Services (Cont.)

Schedule II

Follow Schedule II ONLY if none of the driving conditions specified in Schedule I apply.

ITEM NO.	TO BE SERVICED <i>See Explanation of Scheduled Maintenance Services following Schedules I and II.</i>	WHEN TO PERFORM <i>Miles (kilometers) or Months (whichever occurs first).</i>
1	Engine Oil Change*	Every 7,500 Miles (12,500 km) or 12 Months.
	Oil Filter Change*	At first and then every other oil change.
2	Chassis Lubrication	* Every 7,500 Miles (12,500 km) or 12 Months.
3	Engine Accessory Drive Belt Inspection	Every 30,000 Miles (50,000 km) or 24 Months.
4	Cooling System Service*	Every 30,000 Miles (50,000 km) or 24 Months.
5	Transmission Service	<i>See Explanation of Scheduled Maintenance Services following Schedules I and II.</i>
6	Spark Plug Replacement*	Every 80,000 Miles (167,000 km).
7	Spark Plug Wire Inspection* ^o	Every 30,000 Miles (50,000 km).
8	Air Cleaner Filter Replacement*	Every 30,000 Miles (50,000 km).
9	Fuel Tank, Cap and Lines Inspection* ^o	Every 30,000 Miles (50,000 km).

* An Emission Control Service.

^o The U.S. Environmental Protection Agency has determined that the failure to perform this maintenance item will not nullify the emission warranty or limit recall liability prior to the completion of vehicle useful life. General Motors, however, urges that all recommended maintenance services be performed at the indicated intervals and the maintenance be recorded in Section E: Maintenance Record.

The services shown in this schedule up to 45,000 miles (75 000 km) are to be performed after 45,000 miles at the same intervals.

MILES (000)

7.5	15	22.5	30	37.5	45
-----	----	------	----	------	----

KILOMETERS (000)

12.5	25	37.5	50	62.5	75
------	----	------	----	------	----

•	•	•	•	•	•
•		•		•	
•	•	•	•	•	•
			•		
			•		
			•		
			•		
			•		

Maintenance Schedule

Section A: Scheduled Maintenance Services (Cont.)

Explanation of Scheduled Maintenance Services

Below are explanations of the services listed in Schedule I and Schedule II.

ITEM

NO. SERVICE

- 1 Engine Oil and Filter Change***—Use only API Service SG Energy Conserving II oils of the proper viscosity. To determine the preferred viscosity for your vehicle's engine, see the *Index* under *Engine Oil*. The engine requires a special oil meeting GM Standard GM4718M. Oils meeting this Standard may be identified as synthetic, and should also be identified as API Service SG. However, not all Synthetic API Service SG oils will meet this GM Standard. You should look for and use only an oil that meets GM Standard GM4718M.

Your vehicle has an Engine Oil Life Monitor. This monitor will show you when to change the oil. See the *Index* under *Engine Oil Life Monitor*.

The proper fluids and lubricants to use are listed in Section D. Make sure whoever services your vehicle uses these. All parts should be replaced and all necessary repairs done before you or anyone else drives the vehicle.

ITEM

NO. SERVICE

- 2 Chassis Lubrication**—Lubricate the transmission shift linkage, parking brake cable guides, underbody contact points and linkage. Lubricate the front suspension.
- 3 Engine Accessory Drive Belt Inspection**—Inspect the belt for cracks, fraying, wear and proper tension. Replace as needed.

NOTE: To determine your engine's displacement and code, see the Index under Engine Identification.

* An Emission Control Service.

⊛ The U.S. Environmental Protection Agency has determined that the failure to perform this maintenance item will not nullify the emission warranty or limit recall liability prior to the completion of vehicle useful life. General Motors, however, urges that all recommended maintenance services be performed at the indicated intervals and the maintenance be recorded in Section E: Maintenance Record.

**ITEM
NO.**

SERVICE

- 4 Cooling System Service***—Drain, flush and refill the system with new or approved recycled coolant conforming to GM Specification 1825M. Keep coolant at the proper mixture as specified. See the *Index* under *Coolant*. This provides proper freeze protection, corrosion inhibitor level and engine operating temperature.

Inspect hoses and replace if they are cracked, swollen or deteriorated. Tighten screw-type hose clamps. Clean the outside of the radiator and air conditioning condenser. Wash the pressure cap and neck.

To help ensure proper operation, we recommend a pressure test of both the cooling system and the pressure cap.

- 5 Transmission Service**—For a manual transmission, the fluid doesn't require changing.

**ITEM
NO.**

SERVICE

For an automatic transmission, change both the fluid and filter every 15,000 miles (25 000 km) if the vehicle is mainly driven under one or more of these conditions:

- In heavy city traffic where the outside temperature regularly reaches 90°F (32°C) or higher.
- In hilly or mountainous terrain.
- Uses such as found in taxi, police car or delivery service.

If you do not use your vehicle under any of these conditions, change both the fluid and filter every 100,000 miles (160 000 km).

- 6 Spark Plug Replacement***—Replace spark plugs with the proper type. See the *Index* under *Replacement Parts*.
- 7 Spark Plug Wire Inspection*☆**—Inspect for burns, cracks or other damage. Check the boot fit at the coils and at the spark plugs. Replace wires as needed.

Maintenance Schedule

Section A: Scheduled Maintenance Services (Cont.)

ITEM NO.	SERVICE
----------	---------

- | | |
|---|--|
| 8 | Air Cleaner Filter Replacement* —Replace every 30,000 miles (50,000 km) or more often under dusty conditions. Ask your dealer for the proper replacement intervals for your driving conditions. |
|---|--|

ITEM NO.	SERVICE
----------	---------

- | | |
|---|--|
| 9 | Fuel Tank, Cap and Lines Inspection*☆ —Inspect the fuel tank, cap and lines (including fuel rails and injection assembly) for damage or leaks. Inspect fuel cap gasket for an even filler neck imprint or any damage. Replace parts as needed. Periodic replacement of the fuel filter is not required. |
|---|--|

* An Emission Control Service.

☆ The U.S. Environmental Protection Agency has determined that the failure to perform this maintenance item will not nullify the emission warranty or limit recall liability prior to the completion of vehicle useful life. General Motors, however, urges that all recommended maintenance services be performed at the indicated intervals and the maintenance be recorded in Section E: Maintenance Record.

Section B: Owner Checks & Services

Listed below are owner checks and services which should be performed at the intervals specified to help ensure the safety, dependability and emission control performance of your vehicle.

Be sure any necessary repairs are completed at once. Whenever any fluids or lubricants are added to your vehicle, make sure they are the proper ones, as shown in Section D.

At Each Fuel Fill (It is important for you or a service station attendant to perform these underhood checks at each fuel fill.)

CHECK OR SERVICE	WHAT TO DO
Engine Oil Level	Check the engine oil level and add the proper oil if necessary. If you have a ZR-1 you should check your engine oil when the engine is cold. See the <i>Index</i> under <i>Engine Oil</i> for further details.
Engine Coolant Level	Check the engine coolant level in the coolant recovery tank and add the proper coolant mix if necessary. See the <i>Index</i> under <i>Coolant</i> for further details.
Windshield Washer Fluid Level	Check the windshield washer fluid level in the windshield washer tank and add the proper fluid if necessary. See the <i>Index</i> under <i>Windshield Washer Fluid</i> for further details.

At Least Once a Month

CHECK OR SERVICE	WHAT TO DO
Tire Inflation	Check tire inflation. Make sure they are inflated to the pressures specified on the Tire-Loading Information label located on the rear edge of the driver's door. See the <i>Index</i> under <i>Tires</i> for further details.

Maintenance Schedule

Section B: Owner Checks & Services (Cont.)

At Least Once a Year

CHECK OR SERVICE	WHAT TO DO
Key Lock Cylinders	Lubricate the key lock cylinders with the lubricant specified in Section D.
Body Lubrication	Lubricate all body door hinges. Also lubricate all hinges and latches, including those for the hood, rear compartment, glove box door, console door and any folding seat hardware. Section D tells you what to use.
Starter Switch	CAUTION
	 When you are doing this check, the vehicle could move suddenly. If it does, you or others could be injured. Follow the steps below.
	<ol style="list-style-type: none">1. Before you start, be sure you have enough room around the vehicle.2. Firmly apply both the parking brake (see the <i>Index</i> under <i>Parking Brake</i> if necessary) and the regular brake. NOTE: Do not use the accelerator pedal, and be ready to turn off the engine immediately if it starts.3. On automatic transmission vehicles, try to start the engine in each gear. The starter should work only in P (Park) or N (Neutral). If the starter works in any other position, your vehicle needs service. On manual transmission vehicles, put the shift lever in N (Neutral), push the clutch down halfway, and try to start the engine. The starter should work only when the clutch is pushed down all the way to the floor. If the starter works when the clutch isn't pushed all the way down, your vehicle needs service.

CHECK OR SERVICE	WHAT TO DO
Steering Column Lock	<p>While parked, and with the parking brake set, try to turn the key to Lock in each shift lever position.</p> <ul style="list-style-type: none"> • With an automatic transmission, the key should turn to Lock only when the shift lever is in P (Park). • With a manual transmission, the key should turn to Lock only when the shift lever is in R (Reverse). <p>On vehicles with a key release button, try to turn the key to Lock without pressing the button. The key should turn to Lock only with the key button depressed. On all vehicles, the key should come out only in Lock.</p>
Parking Brake and Automatic Transmission P (Park) Mechanism Check	<p>CAUTION</p> <p> When you are doing this check, your vehicle could begin to move. You or others could be injured and property could be damaged. Make sure there is room in front of your vehicle in case it begins to roll. Be ready to apply the regular brake at once should the vehicle begin to move.</p> <p>Park on a fairly steep hill, with the vehicle facing downhill. Keeping your foot on the regular brake, set the parking brake.</p> <ul style="list-style-type: none"> • To check the parking brake: With the engine running and transmission in N (Neutral), slowly remove foot pressure from the regular brake pedal. Do this until the vehicle is held by the parking brake only. • To check the P (Park) mechanism's holding ability: Shift to P (Park). Then release all brakes.
Underbody Flushing	<p>At least every spring, use distilled water to flush any corrosive materials from the underbody. Take care to clean thoroughly any areas where mud and other debris can collect.</p>

Maintenance Schedule

Section C: Periodic Maintenance Inspections

Listed below are inspections and services which should be performed at least twice a year (for instance, each spring and fall). You should let your GM dealer's service department or other qualified service center do these jobs. Make sure any necessary repairs are completed at once.

INSPECTION OR SERVICE	WHAT SHOULD BE DONE
Steering and Suspension Inspection	Inspect the front and rear suspension and steering system for damaged, loose or missing parts, signs of wear, or lack of lubrication. Inspect the power steering lines and hoses for proper hookup, binding, leaks, cracks, chafing, etc.
Tire and Wheel Inspection	Inspect the tires for uneven wear or damage. If there is irregular or premature wear, check the wheel alignment. Inspect for damaged wheels.
Exhaust System Inspection	Inspect the complete exhaust system. Inspect the body near the exhaust system. Look for broken, damaged, missing or out-of-position parts as well as open seams, holes, loose connections, or other conditions which could cause a heat buildup in the floor pan or could let exhaust fumes into the vehicle. See the <i>Index</i> under <i>Engine Exhaust</i> .
Rear Axle Service	Check the gear lubricant level in the rear axle and add if needed. See the <i>Index</i> under <i>Rear Axle</i> . A fluid loss in this system may indicate a problem. Check the system and repair it if needed.
Brake System Inspection	Inspect the complete system. Inspect brake lines and hoses for proper hookup, binding, leaks, cracks, chafing, etc. Inspect disc brake pads for wear and rotors for surface condition. Inspect other brake parts, including calipers, parking brake, etc. Check parking brake adjustment. You may need to have your brakes inspected more often if your driving habits or conditions result in frequent braking. NOTE: A low brake fluid level can indicate worn disc brake pads which may need to be serviced. Also, if the brake system warning light stays on or comes on, something may be wrong with the brake system. See the <i>Index</i> under <i>Brake System Warning Light</i> . If your anti-lock brake system warning light stays on, comes on or flashes, something may be wrong with the anti-lock brake system. See the <i>Index</i> under <i>Anti-Lock Brake System Warning Light</i> .

Section D: Recommended Fluids & Lubricants

NOTE: Fluids and lubricants identified by name, part number or specification may be obtained from your GM dealer.

USAGE	FLUID/LUBRICANT
Engine Oil	API Service SG Energy Conserving II oils of the proper viscosity. To determine the preferred viscosity for your vehicle's engine, see the <i>Index</i> under <i>Engine Oil</i> . The engine requires a special oil meeting GM Standard GM4718M. Oils meeting this Standard may be identified as synthetic, and should also be identified as API Service SG. However, not all Synthetic API Service SG oils will meet this GM Standard. You should look for and use only an oil that meets GM Standard GM4718M.
Engine Coolant	A 50/50 mixture of water (preferably distilled) and good quality ethylene glycol base antifreeze (GM Part No. 1052753 or equivalent) conforming to GM Specification 1825M, or an approved recycled coolant conforming to GM Specification 1825M.
Hydraulic Brake System	Delco Supreme II [®] Brake Fluid (GM Part No. 1052535) or equivalent DOT-3 brake fluid.
Hydraulic Clutch System	Hydraulic Clutch Fluid (GM Part No. 12345347) or equivalent.
Parking Brake Guides	Chassis lubricant meeting requirements of NLGI Grade 2, Category LB or GC-LB (or GM Part No. 1052497).
Power Steering System	GM Synthetic Power Steering Fluid (GM Part No. 12345866 or 12345867) or equivalent.
Manual Transmission	Manual Transmission Fluid SAE 5W-30 (GM Part No. 1052931) or equivalent.
Automatic Transmission	DEXRON [®] -III Automatic Transmission Fluid (GM Part No. 12345881).

Maintenance Schedule

Section D: Recommended Fluids & Lubricants (Cont.)

USAGE	FLUID/LUBRICANT
Key Lock Cylinders	Lubricate with Multi-Purpose Lubricant (GM Part No. 12345120), synthetic SAE 5W-30 engine oil or silicone lubricant (GM Part No. 1052276 or 1052277).
Manual Transmission Shift Linkage	Chassis lubricant meeting requirements of NLGI Grade 2, category LB or GC-LB (or GM Part No. 1052497).
Automatic Transmission Shift Linkage	Engine oil.
Clutch Linkage Pivot Points	Engine oil.
Floor Shift Linkage	Engine oil.
Chassis Lubrication	Chassis lubricant meeting requirements of NLGI Grade 2, Category LB or GC-LB (or GM Part No. 1052497).
Rear Axle (Limited-Slip Differential)	Axle Lubricant (GM Part No. 12345977) or SAE 80W-90 GL-5 Gear Lubricant, and Limited-Slip Differential Lubricant Additive (GM Part No. 1052358) or equivalent where required. See the <i>Index</i> under <i>Rear Axle</i> .
Windshield Washer Solvent	GM Optikleen [®] Washer Solvent (GM Part No. 1051515) or equivalent.

USAGE	FLUID/LUBRICANT
Hood Latch Assembly a. Pivots and Spring Anchor b. Release Pawl	a. Engine oil. b. Chassis lubricant meeting requirements of NLGI Grade 2, Category LB or GC-LB (or GM Part No. 1052497).
Hood and Door Hinges, Fuel Door Hinge, Rear Compartment Lid Hinges, Concealed Headlight Hinges, Hatch Hinges, Folding Front Seats	Engine oil or Lubriplate Lubricant (GM Part No. 1050109).
Weatherstrips	Dielectric Silicone Grease (GM Part No. 12345579) or equivalent.

See the *Index* under *Replacement Parts* for recommended replacement filters, valves and spark plugs.

Maintenance Schedule

Section E: Maintenance Record

After the scheduled services are performed, record the date, odometer reading and who performed the service in the columns indicated. When completing the Maintenance Performed column, insert the numbers from the Schedule I

or Schedule II maintenance charts which correspond to the maintenance performed. Also, you should retain all maintenance receipts. Your Corvette owner's portfolio is a convenient place to store them.

<i>DATE</i>	<i>ODOMETER READING</i>	<i>SERVICED BY</i>	<i>MAINTENANCE PERFORMED</i>



Part 8 Customer Assistance Information

Here you will find out how to contact Chevrolet if you need assistance. This part also tells you how to obtain service publications and how to report any safety defects.

Customer Satisfaction Procedure	342
Corvette Action Center	343
Customer Assistance for the Hearing or Speech Impaired	343
BBB Mediation/Arbitration Program	344
Reporting Safety Defects	346
Chevrolet Roadside Assistance Program	347
Service Publications	348

Customer Assistance Information



Customer Satisfaction Procedure

Your satisfaction and goodwill are important to your dealer and Chevrolet. Normally, any concern with the sales transaction or the operation of your vehicle will be resolved by your dealer's Sales or Service Departments. Sometimes, however, despite the best intentions of all concerned, misunderstandings can occur. If your concern has not been resolved to your satisfaction, the following steps should be taken:

STEP ONE: Discuss your concern with a member of dealership management. Complaints can often be quickly resolved at that level. If the matter has already been reviewed with the Sales, Service or Parts Manager, contact the owner of the dealership or the General Manager.

STEP TWO: If after contacting a member of Dealership Management, it appears your concern cannot be resolved by the dealership without further help, contact the Chevrolet Customer Assistance Center by calling 1-800-222-1020.

In Canada, contact GM of Canada Customer Assistance Center in Oshawa by calling 1-800-263-3777 (English) or 1-800-263-7854 (French).

In Mexico, call (525) 254-3777. In Puerto Rico or U.S. Virgin Islands, call 1-809-763-1315. In all other overseas locations, contact GM International Export Sales in Canada by calling 1-416-644-4112.

For prompt assistance, please have the following information available to give the Customer Assistance Representative:

- Your name, address, telephone number
- Vehicle Identification Number (This is available from the vehicle registration or title, or the plate attached to the left top of the instrument panel and visible through the windshield.)
- Dealership name and location
- Vehicle delivery date and present mileage
- Nature of concern

We encourage you to call the toll-free number listed previously in order to give your inquiry prompt attention. However, if you wish to write Chevrolet, write to:

United States

Chevrolet Motor Division
Chevrolet Customer Assistance Center
P.O. Box 7047
Troy, MI 48007-7047

Canada

General Motors of Canada Limited
Customer Assistance Center
1908 Colonel Sam Drive
Oshawa, Ontario L1H 8P7

A listing of all Chevrolet Branch Offices and offices outside the U.S. which can assist you can also be found in the warranty booklet.

When contacting Chevrolet, please remember that your concern will likely be resolved in the dealership, using the dealership's facilities, equipment and personnel. That is why we suggest you follow Step One first if you have a concern.

Corvette Action Center

If you have any questions, comments or problems regarding your Corvette, or Corvette in general, you can call the **Corvette Action Center** at **1-800-457-VETT**. The **Corvette Action Center** is open between the hours of 6:00 a.m. to 2:30 p.m. CST, Monday through Friday.

Customer Assistance For the Hearing or Speech Impaired (TDD)

To assist owners who have hearing difficulties, Chevrolet has installed special TDD (Telecommunication Devices for the Deaf) equipment at its Customer Assistance Center. Any hearing or speech impaired customer who has access to a TDD or a conventional teletypewriter (TTY) can communicate with Chevrolet by dialing: 1-800-TDD-CHEV. (TDD users in Canada can dial 1-800-263-3830.)

Customer Assistance Information

GM Participation In Better Business Bureau Mediation/Arbitration Program*

Our experience has shown that the Customer Satisfaction Procedure described earlier in this part has been very successful in achieving customer satisfaction. However, if you have not been substantially satisfied, Chevrolet wants you to be aware of GM's voluntary participation in a no-charge mediation/arbitration program called BBB AUTO LINE. This program is administered by the Council of Better Business Bureaus through local Better Business Bureaus. The program can resolve individual disputes involving vehicle repairs and the interpretation of your New Vehicle Limited Warranty.

We prefer that you not resort to BBB AUTO LINE until after a final decision is made under the Customer Satisfaction Procedure. However, you may file a claim at any time by contacting your local Better Business Bureau (BBB) at the following toll-free number: 1-800-955-5100. For further information about filing a claim, you may also write to:

BBB AUTO LINE
Council of Better Business Bureaus
4200 Wilson Boulevard
Suite 800
Arlington, VA 22203

In order to file a claim, you will have to provide your name and address, the vehicle identification number (VIN) of your vehicle, and a statement of the nature of your complaint. BBB staff may try to help resolve your dispute through mediation. If mediation is not successful, or if you do not wish to participate in mediation, eligible customers may present their case to an impartial third-party arbitrator at an informal hearing. The arbitrator will render a decision in your case, which you may accept or reject. If you accept a valid arbitrator decision, GM will be bound by that decision. The entire dispute settlement process should ordinarily take about 40 days from the time you file your complaint to the time

a decision is rendered (or 47 days if you did not first contact your dealer or Chevrolet).

We encourage you to use this program before or instead of resorting to the courts. We believe it offers advantages over courts in most jurisdictions because it is fast, free of charge, and informal (lawyers are not usually present, although you may retain one at your expense if you choose). Arbitrators make decisions based on the principles of fairness and equity, and are not required to duplicate the functions of courts by strictly applying state or federal law. If you wish to go to court, however, we do not require that you

first file a claim with BBB AUTO LINE** unless state law provides otherwise. Whatever your preference may be, remember that if you are unhappy with the results of BBB AUTO LINE, you can still go to court because an arbitrator's decision is binding on GM but not on you, unless you accept it.

Eligibility is limited by vehicle age/mileage and other factors. For further information concerning the program, call the BBB at 1-800-955-5100. You may also call the Chevrolet Customer Assistance Center at 1-800-222-1020.

**This program may not be available in all states, depending on state law. Canadian owners refer to your warranty booklet. General Motors reserves the right to change eligibility limitations and/or to discontinue its participation in this program.*

***Some states may require that you file a claim with BBB AUTO LINE before resorting to state-operated procedures (including court).*

Customer Assistance Information

Reporting Safety Defects to the United States Government

If you believe that your vehicle has a defect which could cause a crash or could cause injury or death, you should immediately inform the National Highway Traffic Safety Administration (NHTSA), in addition to notifying General Motors.

If NHTSA receives similar complaints, it may open an investigation, and if it finds that a safety defect exists in a group of vehicles, it may order a recall and remedy campaign. However, NHTSA cannot become involved in individual problems between you, your dealer, or General Motors.

To contact NHTSA, you may either call the Auto Safety Hotline toll-free at 1-800-424-9393 (or 366-0123 in the Washington, D.C. area) or write to:

NHTSA
U.S. Department of Transportation
Washington, D.C. 20590

You can also obtain other information about motor vehicle safety from the Hotline.

Reporting Safety Defects to the Canadian Government

If you live in Canada, and you believe that your vehicle has a safety defect, you should immediately notify Transport Canada, in addition to notifying General Motors of Canada Limited. You may write to:

Transport Canada
Box 8880
Ottawa, Ontario K1G 3J2

Reporting Safety Defects to General Motors

In addition to notifying NHTSA (or Transport Canada) in a situation like this, we certainly hope you'll notify us. Please call us at 1-800-222-1020, or write:

Chevrolet Motor Division
Chevrolet Customer Assistance Center
P.O. Box 7047
Troy, Michigan 48007-7047

In Canada, please call us at 1-800-263-3777 (English) or 1-800-263-7854 (French). Or, write:

General Motors of Canada Limited
Customer Assistance Center
1908 Colonel Sam Drive
Oshawa, Ontario L1H 8P7



■ *Chevrolet Roadside Assistance Program*

To enhance Chevrolet's strong commitment to customer satisfaction, Chevrolet is excited to announce the establishment of the Chevrolet/Geo Roadside Assistance Center. As the owner of a 1995 Corvette, membership in Roadside Assistance is free.

24-Hour Roadside Assistance Number

Roadside Assistance is available 24 hours a day, 365 days a year, by calling 1-800-CHEV ZR1 (1-800-243-8971). This toll-free number will provide you over-the-phone roadside assistance with minor mechanical problems.* If your problem cannot be resolved over the phone, our advisors have access to a nationwide network of dealer recommended service providers. The following services are available:

- Towing
- Locksmith
- Tire repair
- Glass replacement
- Rental car or taxi
- Additional services as necessary

* In Canada, call 1-800-268-6800 for details on Roadside Assistance.

The Roadside Assistance Center uses companies that will provide you with quality and priority service. When roadside services are required, our advisors will explain any payment obligations that may be incurred for utilizing outside services.

For prompt assistance when calling, please have the following available to give to the advisor:

- Vehicle Identification Number
- License plate number
- Vehicle color
- Vehicle location
- Telephone number where you can be reached
- Vehicle mileage
- Description of problem

Please refer to the Roadside Assistance brochure inside your owner's portfolio for full program details.

Customer Assistance Information

■ *Service Publications*

Information on how to obtain Product Service Publications and Indexes as described below is applicable only in the fifty U.S. states (and the District of Columbia) and only for cars and light trucks with GVWR less than 10,000 pounds (4 536 kg).

In Canada, information pertaining to Product Service Bulletins and Indexes can be obtained by writing to:

General Motors of Canada Limited
Service Publications Department
1908 Colonel Sam Drive
Oshawa, Ontario L1H 8P7

Chevrolet regularly sends its dealers useful service bulletins about Chevrolet products. Chevrolet monitors product performance in the field. We then prepare bulletins for servicing our products better. Now, you can get these bulletins too.

Bulletins cover various subjects. Some pertain to the proper use and care of your vehicle. Some describe costly repairs. Others describe inexpensive repairs which, if done on time with the latest parts, may avoid future costly repairs. Some bulletins tell a technician how to repair a new or unexpected condition. Others describe a quicker way to fix your vehicle. They can help a technician service your vehicle better.

Most bulletins apply to conditions affecting a small number of cars or trucks. Your Chevrolet dealer or a qualified technician may have to determine if a specific bulletin applies to your vehicle.

Individual PSP's

If you don't want to buy all the PSP's issued by Chevrolet for all car or truck models in the model year, you can buy individual PSP's, such as those which may pertain to a particular model. To do this, you will first need to see our index of PSP's. It provides a variety of information. Here's what you'll find in the index and how you can get one:

What You'll Find in the Index

- A list of all PSP's published by Chevrolet in a model year (1989 or later). PSP's covering all models of Chevrolet cars or light trucks (less than 10,000 lbs. GVWR) are listed in the same index.
- Ordering information so you can buy the specific PSP's you may want.
- Price information for the PSP's you may want to buy.

How You Can Get an Index

Indexes are published periodically. Most of the PSP's which could potentially apply to the most recent Chevrolet models will be listed in the most recent publication for that model year. This means you may want to wait until the end of the model year before ordering an index, if you are interested in buying PSP's pertaining to a current model year car or truck.

Some PSP's pertaining to a particular model year vehicle may be published in later years, and these would be listed in the later year's index. When you order an index for a model year that is not over yet, we'll send you the most recently published issue. Check the order form for indexes for earlier model years.

Customer Assistance Information

How You Can Get an Index (CONT.)

Cut out the order form, fill it out, and mail it in. We will then see to it that an index is mailed to you. There is no charge for indexes for the 1989-1993 model years.

Toll-Free Telephone Number

If you want an additional order form for an index, just call toll-free and we'll be happy to send you one. Automated recording equipment will take your name and mailing address. The number to call is 1-800-551-4123.

A Very Important Reminder

These PSP's are meant for technicians. They are not meant for the "do-it-yourselfer." Technicians have the equipment, tools, safety instructions, and know-how to do a job quickly and safely.

Chevrolet reserves the right to change these procedures without notice.

Chevrolet Service Publications

You can get these by using the following order form.

Chevrolet Division service manuals are intended for use by professional, qualified technicians. Attempting repairs or service without the appropriate training, tools, and equipment could cause injury to you or others and damage to your vehicle that may cause it not to operate properly.

1993 CHEVROLET SERVICE PUBLICATIONS ORDERING INFORMATION

The following publications covering the operation and servicing of your vehicle can be purchased by filling out the Service Publications Order Form in this book and mailing it with your check, money order or credit card information to Helm, Incorporated (address listed below).

CURRENT PUBLICATIONS FOR 1993 CHEVROLET CORVETTE

PRODUCT SERVICE PUBLICATIONS

Product Service Publications (PSP's), are bulletins, letters and articles published for trained dealer service personnel. See Service Publications listed previously in this section.

A cumulative index is published quarterly during the current model year. The indexes list all PSP's published by Chevrolet in the model year.

PSP Index

Year	Form Number	Price
1993	PSP1-93	Free
1992	PSP1-92	Free
1991	PSP1-91	Free
1990	PSP1-90	Free

NOTE: Form Numbers for individual Product Service Publications may be found in the PSP Index. Prices are \$4.00 for the first PSP and \$2.00 for each additional PSP on the same order.

PSP Bound Bulletin Book (Complete Year Bulletins)

Year	Description	Form Number	Price
1991	All PSP's	PSP-91-4	40.00
1990	All PSP's	PSP-90-4	40.00

For subscription information call Helm, Incorporated.

CURRENT & PAST MODEL ORDER FORMS

Service Publications are available for current and past model Chevrolet vehicles. To request an order form, please specify year and model name of vehicle.

SERVICE MANUALS

Service Manuals have the diagnosis, repair and overhaul information on engines, transmission, axle, suspension, brakes, electrical, steering, body, etc.

Model	Form Number	Price
1993 Chevrolet Corvette	ST-364-93	\$43.00

*Please specify special body or engine types on order form. Write information in the Form Number column. For example: Turbo, Convertible.

OWNER'S INFORMATION

Owner publications are written directly for owners and intended to provide basic operational information about the vehicle.

1993 Chevrolet Corvette Owner's Manual

In Portfolio: Includes Portfolio, Owner's Manual and Warranty Booklet.

1993	Chevrolet Corvette In-Portfolio	10161892	\$60.00
------	---------------------------------------	----------	---------

(Not including ZR1)

1993	Chevrolet Corvette ZR1 In-Portfolio ..	10161894	\$70.00
------	--	----------	---------

Without Portfolio: Includes Owner's Manual.

1993	Chevrolet Corvette Without Portfolio ..	10193598	\$20.00
------	---	----------	---------

Address all inquiries to: HELM, INCORPORATED
P.O. Box 07130
Detroit, MI 48207

Credit Card Orders ONLY: 1-800-782-4356

For information and inquiries call: (313) 883-1430

CHEVROLET SERVICE PUBLICATIONS ORDER FORM

NOTE: Please complete form below (Print or Type) and MAIL TO:

HELM

Post Office Box 07130, Detroit, Michigan 48207

<p style="text-align: center;">ORDER TOLL FREE (NOTE: For Credit Card Holder Orders Only) 1-800-782-4356 (Monday-Friday 8:30 A.M.-6:00 P.M. EST)</p>	<p>•Minimum Credit Card Order \$10.00</p> <p>If further information is needed, write Helm or call (313) 883-1430.</p> <p>ORDER INFORMATION NOT AVAILABLE THROUGH THE TOLL FREE NUMBER.</p>
---	---

PUBLICATION FORM NUMBER **	ITEM DESCRIPTION	VEHICLE MODEL		QTY.	PRICE EACH *	TOTAL PRICE
		NAME	YEAR			
ST-364-93	Service Manual	Chevrolet Corvette	1993		\$43.00	
10161892	Owner's Manual In-Portfolio	Chevrolet Corvette	1993		\$60.00	
10161894	Owner's Manual In-Portfolio	Chevrolet Corvette ZR1	1993		\$70.00	
10193598	Owner's Manual Without-Portfolio	Chevrolet Corvette	1993		\$20.00	

S
T
I
P
T
O

NOTE: Dealers and Companies please provide dealer or company name, and also the name of the person to whose attention the shipment should be sent. For purchases outside U.S.A. please write to the above address for quotation.

(CUSTOMER NAME) _____ (ATTENTION) _____

(STREET ADDRESS—NO P.O. BOX NUMBERS) _____ (APT. NO.) _____

(CITY) _____ (STATE) _____ (ZIP CODE) _____

DAYTIME TELEPHONE NO. _____ AREA CODE () _____

P
A
Y
M
E
N
T

Check or Money
Order payable to Helm, Inc. (USA funds only — do not send cash.)

MasterCard

VISA

Account Number:

Expiration Date mo/yr:

Check here if your billing address is different from your shipping address shown.

(CUSTOMER SIGNATURE)

TOTAL MATERIAL	
Michigan Purchasers add 4% sales tax	
Handling Charge	\$3.50
Canadian Postage/Handling (U.S. Funds)	\$6.50
GRAND TOTAL	

** Prices are subject to change without notice and without incurring obligation. Orders for individual Product Service Publications cannot be filled without the appropriate bulletin numbers. These numbers may be found in the PSP Index. Your first Product Service Publication costs \$4.00; each additional PSP costs \$2.00.

NOTE: All listed prices are quoted in U.S. funds. Canadian residents are to make checks payable in U.S. funds and are to include \$6.50 for additional postage and handling. Requests for manuals printed in French should be directed to Canadian General Motors dealerships. Please allow adequate time for postal service.

Index

- A**
ABS Active Light 117
ABS Service Light 117
ABS Light 117
Acceleration Slip Regulation
(ASR) System 89, 175
Accessory Wiring Plug 147
Action Center, Corvette 343
Adding
Brake Fluid 271
Electrical Equipment 65, 146, 304
Engine Coolant 216, 262, 311, 317
Engine Oil 250, 311
Hydraulic Clutch Fluid 260, 317
Power Steering Fluid 269, 318
Rear Axle Fluid 262, 318
Sound Equipment 146
Transmission Fluids 259, 260, 317
Windshield Washer
Fluid 84, 269, 317
Air Bag (see *Supplemental Inflatable
Restraint*)
Air Cleaner Filter 254, 312
Air Conditioner 136, 142
Alcohol, Driving Under the Influence
of 169
Alcohol in Gasoline 242
Aluminum Wheels
Cleaning 296, 301
Removing 228
Antenna, Power 161
Antifreeze 216, 262, 263, 311, 317
Anti-Lock Brake
System (ABS) 117, 173
Anti-Lock Brake System Light 117
Appearance Care 289
Ashtray and Lighters 96
ASR Active Light 115
ASR Off Light 116
ASR System 89, 175
Audio Systems 146
AM/FM Stereo with
Cassette Player 149
AM/FM Stereo with
Cassette Player (Delco-Bose®
Music System) 152
AM/FM Stereo with Cassette/CD
Player (Delco-Bose®
Music System) 155
Care of Audio Systems 160
Radio Reception, For the Best 159
Setting the Clock 148
Automatic Electronic Climate
Control 140
Automatic Transmission
Adding Fluid 259
Checking Fluid 256
Shifting 67, 78
Axle, Rear Limited-Slip 76
B
Battery 205, 272
Jump Starting 205
Warnings 205, 206, 272
Battery Warning Gage 105
Battery Warning Light 118
Blizzard 200
Block Heater, Engine 66
"Blowout," Tire 224
Brake
Adjustment 178
Fluid 270, 317
Master Cylinder 270
Parking 77
Pedal Travel 178
Warning Light 106
Wear Indicators 177

Index

- | | | | | | |
|---|-----------------|--------------------------------|---------------|--------------------------------|----------|
| Brake System Warning Light | 106 | Cassette Tape Player | | Cleaner, Air | 254 |
| Anti-Lock Brake System | 173 | (see <i>Audio Systems</i>) | | Cleaning | |
| Brakes, Anti-Lock | 173 | Center Storage Console..... | 95 | Aluminum Wheels | 296, 301 |
| Active Light..... | 117 | Central Control Module | 120 | Carpet | 292 |
| Service Light | 117 | Chains, Tire | 236, 288 | Cassette Player | 160 |
| Braking | 172 | Changing a Flat Tire | 225 | Compact Discs | 160 |
| Braking Emergencies | 178 | Charging System Light..... | 118 | Convertible | |
| Braking Technique | 172 | Check Gauges Light | 108 | Rear Window | 125, 298 |
| "Break-In," New Vehicle..... | 59 | Checking | | Top..... | 297 |
| Buckling Up (see <i>Safety Belts</i>) | | Brake Fluid | 270 | "Dulso"-Coated Molding..... | 294 |
| Bulb Replacement | | Engine Coolant | 262 | Engine..... | 301 |
| Back-up Light | 277 | Engine Oil Level | 249, 250 | Fabric..... | 290 |
| Center High-Mounted | | Power Steering Fluid..... | 269 | Fiberglass Springs..... | 303 |
| Stop Light..... | 278, 279 | Rear Axle Fluid | 261 | Finish..... | 300 |
| Cornering Lights | 277 | Safety Belt Systems | 37 | Foreign Material..... | 302 |
| Headlight..... | 273 | Transmission Fluids | 257, 258, 259 | Glass | 295 |
| Fog Light | 275 | Checking Things | | Hardtop | 300 |
| Rear Cargo Light | 278 | Under the Hood | 245 | Inside of Your Corvette | 290 |
| Side Marker Lights | 277 | Chemical Paint Spotting..... | 303 | Instrument Panel | 294 |
| Taillight | 276 | Child Restraints | 33 | Leather or Vinyl | 293 |
| Turn Signals, Front and Rear | 276 | Children and Safety Belts..... | 32, 36 | Outside of Your Corvette | 296 |
| Bulbs, Replacement..... | 314 | Cigarette Lighter..... | 96 | Power Antenna | 161 |
| C apacities and Specifications | 311 | Cinch Feature | 24 | Removable Roof Panels | 297 |
| Carbon Monoxide in | | Circuit Breakers & Fuses..... | 305 | Safety Belts | 295 |
| Exhaust | 59, 79, 80, 200 | City Driving | 190 | "Soft Touch" Surfaces..... | 293 |
| | | | | Special Problems | 292 |

Underbody Maintenance	302
Warnings	289, 297
Weatherstrips	301
Windshield and Wiper Blades	295
Cleaning Your Convertible Top	297
Climate Control	136
Air Conditioner	136, 142
Automatic Electronic Climate Control	140
Heater	137, 144
Ventilation	137, 145
Clock, Setting the	148
Clusters, Instrument Panel	100
Compact Disc Player (see <i>Audio Systems</i>)	
Compact Spare Tire	236
Concealed Headlights	90
Control of a Vehicle	171
Convertible Hardtop	128
Convertible Top	124
Convex Outside Mirror	93
Coolant	216, 262, 263, 311, 317
Checking & Adding ..	216, 218, 222, 262, 263, 266
High Fill Reservoir Pressure Cap	268

Low Coolant Light	112
Proper Mixture to Use	217, 262
Safety Warnings ..	106, 217, 263, 264, 267
Temperature Gage	106
Corvette Action Center	343
Cruise Control	84
Cup Holder	96
Curves, Driving on	179
Customer Assistance Information ..	341

D AB (Delayed Accessory Bus)	57
Daytime Running Lights	90
Dead Battery: What to Do	205
Defensive Driving	168
Defogger, Power Mirror	139
Defogger, Rear Window	138, 144
Defrosting Window	137
Dimensions	316
Directional Controls, Electronic Climate	143
Door Ajar Light	107
Door Locks	43
Downshifting	69, 73
Driver Information Center	112

Driver Position	23
Driver's Side SIR ("Air Bag")	26
Driving	163
At Night	184
City	190
Controlling a Skid	183
Defensively	168
Drunken	169
Freeway	191
Hill and Mountain	195
In a Foreign Country	243
In Fog, Mist and Haze	189
In the Rain	186
Long Distance	193
Loss of Control	183
On Curves	179
Passing	87, 181
Through Deep Standing Water	65
Winter Driving	198
Drunken Driving	169

E lectric Outside Mirror Control	93
Electrical Equipment, Adding	65, 146, 304
Electronic Heating and Air Conditioning	310

Index

- | | | | | | |
|-------------------------------|-------------------------|-------------------------------|--------------------|---------------------------------|---------------|
| Emergencies, Braking..... | 178 | Engine Power Curves..... | 319 | Filling the Fuel Tank..... | 244 |
| Emergencies on the Road..... | 203 | Engine Power Key..... | 56 | Filter | |
| Emergencies, Steering in..... | 180 | Engine Power Switch..... | 74 | Air Cleaner..... | 254, 312 |
| Emergency Starting..... | 205 | Engine Specifications..... | 313 | Oil..... | 253, 312 |
| Emergency Towing..... | 208 | Engine, Starting | | Finish Damage..... | 302 |
| Engine Block Heater..... | 66 | Automatic Transmission..... | 63 | Flashers, Hazard | |
| Engine | | Manual Transmission..... | 65 | Warning..... | 204 |
| Coolant..... | 216, 262, 263, 311, 317 | Ethanol in Gasoline..... | 242 | Flat Tire..... | 224 |
| Engine Coolant Temperature | | Exhaust | | Storing a Flat—Except ZR-1..... | 233 |
| Gage..... | 106 | Dangerous Gas in..... | 59, 79, 80, 200 | Storing a Flat—ZR-1..... | 234 |
| Engine Cooling System..... | 262 | Parking with the Engine | | Flooded Engine..... | 62, 64 |
| Engine Exhaust..... | 79, 80, 200 | Running..... | 67, 78, 80 | Flow-Through Ventilation | |
| Engine Identification..... | 304 | Expectant Mothers, Use of | | System..... | 145 |
| Engine Oil..... | 249 | Safety Belts..... | 31 | Fluid | |
| Additives..... | 253 | Expressway Driving..... | 191 | Brake..... | 270, 317 |
| Capacity..... | 311 | Extender, Safety Belt..... | 37 | Capacities..... | 311 |
| Checking & Adding..... | 249, 250 | Exterior Appearance | | Hydraulic Clutch..... | 260 |
| Disposing of Used Oil..... | 254 | (see <i>Appearance Care</i>) | | Power Steering..... | 269 |
| Energy Conserving..... | 252 | F abric Cleaning | | Rear Axle..... | 261, 318 |
| Low Oil Light..... | 118 | (see <i>Appearance Care</i>) | | Transmission..... | 256, 311, 317 |
| Pressure Gage..... | 103 | Fabric Protection..... | 291 | Windshield Washer..... | 84, 269, 318 |
| Substitute..... | 253 | Fan Warnings..... | 206, 207, 215, 246 | Fluids & Lubricants..... | 317 |
| Temperature Gage..... | 104 | Fiberglass Springs..... | 303 | Fog, Driving in..... | 189 |
| When to Change..... | 253 | | | Fog Light Bulb Replacement... | 275, 314 |
| Engine Oil Life Monitor..... | 109 | | | Fog Lights..... | 92 |
| Engine Overheating..... | 213 | | | Freeway Driving..... | 191 |

French Language Manual.....	2	Gasoline.....	241	Hills, Parking on.....	196
Fuel.....	241	Gasoline Tank, Filling Your.....	244	Hood Release.....	245
Alcohol in Fuel.....	242	Gear Positions		Safety Warning.....	246
Capacity.....	241	(see <i>Shifting the Transmission</i>)		Warning, Overheated Engine.....	213
Exhaust Warnings.....	59, 79, 80, 200	Gearshift Lever		Horn.....	81
Filling Your Tank.....	244	(see <i>Shifting the Transmission</i>)		Hot Engine, Safety	
Fuels with Alcohol.....	242	Glove Box.....	59	Warnings.....	213, 216, 246, 267, 271
Gage.....	103	H alogen Bulbs.....	272	How the Anti-Lock System Works....	174
In Foreign Countries.....	243	Hatch Release, Remote.....	57	How to Use This Manual.....	9
Low, Warning.....	103	Hazard Warning Flashers.....	204	Hydraulic Clutch Fluid.....	260
Requirements.....	241	Headlight & Taillight, Removing		Hydroplaning.....	188
Fuse Panel.....	306	and Replacing.....	273, 276	I dentification Number, Vehicle.....	303
Fuses & Circuit Breakers.....	305	Headlights.....	89	Idling Your Engine.....	67, 78
Maxi-Fuse Blocks.....	309	Concealed.....	90	If You're Stuck: In Sand, Mud,	
G age Markings.....	102	High-Low Beam Changer.....	91	Ice or Snow.....	201, 257
Gages		Instrument Panel Intensity		Ignition	
Check.....	108	Control.....	91	Key.....	42
Coolant Temperature.....	106	Replacement Bulb.....	314	Positions.....	60
Fuel.....	103	Wiring.....	310	Illuminated Entry System.....	57
Oil Pressure.....	103	Heater (see <i>Comfort Controls</i>)		Indicator Lights (see <i>Warning Lights</i>)	
Oil Temperature.....	104	Heater, Engine Block.....	66	Infant Restraint (see <i>Child Restraints</i>)	
Tachometer.....	101	High Beams.....	91, 185	Inflatable Restraint.....	26
Voltmeter.....	105	"Highway Hypnosis".....	194	Inflatable Restraint Light.....	27, 115
Gas Station Information.....	368	Hill and Mountain Roads.....	195	Inflation, Tires.....	282

Index

Inside Rearview Mirror	92	Operation	90	M aintenance Record	340
Instrument Panel	99	Reading/Map	92	Maintenance Schedule	321
Clusters	100	Removing & Replacing Bulbs	273	Malfunction Indicator Lamp	118
Intensity Control	91	Replacement Bulbs	314	Manual Front Seat	14
Warning Lights	102	Security	108	Manual Lap-Shoulder	
J ack, Tire	226	Taillights	89	Safety Belt	23
Jump Starting	205	Turn Signal	82	Manual Reclining Seatback	16
K ey, Engine Power	56	Underhood	249	Manual Transmission	
Key Release Button	60	Warning Lights	102	Adding Fluid	260
Keyless Entry System	44, 120	Limited-Slip Rear Axle	76	Checking Fluid	259
Keys	42	Loading Your Vehicle	280	Shifting	70
L ane Change Indicator	82	Lock, Torque	198	Methanol in Gasoline	241
Lap-Shoulder Safety Belt	23	Locks	43	Mileage Indicator	
Front	23	Long Distance Driving	193	(see <i>Odometer & Speedometer</i>)	
Use by Children	32, 36	Low Battery	205	Mirrors	
Latches, Seatback	17	Low Coolant Warning Light	112	Convex Outside	93
Lighter	96	Low Fuel Warning	103	Inside Manual Day/Night	92
Lights		Low Oil Light	118	Power Remote Control	93
Daytime Running Lights	90	Low Oil Pressure Warning	104	Visor Vanity	94
Fog	92	Low Tire Pressure Light	113	Mountain Driving	195
Headlights	89, 90, 185	Low Tire Pressure			
		Warning System	113		
		Lowering Your Convertible Top	125	N ew Vehicle "Break-In" Period	59
		Lubricants & Fluids	317	Night Driving	184
		Luggage Carrier	94		

O ctane Requirements (see <i>Fuel Requirements</i>)	
Odometer & Speedometer	100
Off-Road Track Use	76
Oil Change Light	109
Oil, Engine	249
Capacity	311
Life Monitor	109
Pressure Gage	103
Quality	251
Synthetic	251
Temperature Gage	104
Thickness	252
Used Oil	254
When to Change	253
Oil Warning	103, 118
One to Four Shift Light	72
Operation of Lights	90
Outside Rearview Mirrors	93
Overdrive, Automatic	69
Overheated Engine	213
Warnings	106, 111, 213, 216, 218, 268
Overheated Engine Coolant	
Warning	106, 217, 263, 264
Owner Checks & Services	333

P ark, Shifting Into	78
Parking	
On Hills	196
Over Things That Burn	79
With the Engine Running	67, 78, 80
Parking Brake	77
Passenger Belts (see <i>Safety Belts</i>)	
Passing	87, 181
Passive Keyless Entry Light	49
Passive Keyless Entry System	44
PASS-Key™ System	55
Periodic Maintenance Inspections	336
Plug, Accessory Wiring	147
Polishing and Waxing (see <i>Appearance Care</i>)	
Power Antenna	161
Power Curves, Engine	319
Power Door Locks	44
Power Key, Engine	56
Power Mirror Defogger	139
Power Remote Control Mirrors	93
Power Seat Controls	14
Power Steering	179
Power Steering Fluid	269
Power Windows	81, 310

Pregnancy, Use of Safety Belts	
During	31
Problems on the Road	203
Publications (see <i>Service Publications</i>)	

R adiator Overheating (see <i>Overheated Engine</i>)	
Radiator Pressure Cap	268
Radio (see <i>Audio Systems</i>)	
Reading/Map Lights	92
Rear Axle	261
Rear Axle, Limited-Slip	76
Rear Storage Compartment	95
Rear Window Defogger	138, 144
Rearview Mirror	92
Reclining Seatbacks, Manual	16
Reminder Light, Safety Belt	22
Remote Hatch Release	57
Removable Roof Panel	
Installing	123
Removing	120
Storing	122
Replacement Bulbs	314
Replacement Fuses	307
Replacement Parts	312

Index

Replacement, Windshield Wiper			
Blade	279	Child Restraints	33
Replacing Bulbs	273	Child Restraints—How to	
Replacing Safety Belts	38	Install Them	34
Replacing Tires	284	Child Restraints, Where to Put	34
Replacing Wheels	287	Cinch Feature	24, 35
Reporting Safety Defects	346	Cleaning	295
Restraints, Child	33	Driver Position	23
Road Signs	164	Extender	37
Color	164	How to Wear	22, 23
Shape	165	INFL REST (Inflatable	
Symbols	166	Restraint) Light	27, 115
Traffic Lights	166	Lap-Shoulder Belt	23
Your Own Signals	167	Larger Children	36
Roads, Hill and Mountain	195	Passenger Belts	31
Roadside Assistance Numbers	347	Pregnancy, Use During	31
Rocking Your Vehicle	237	Questions & Answers	21, 24, 36
Roof Panel, Removable	120	Reminder Light	22
Rotation, Tire	283	Replacement	38
Rough Idling	80	Right Front, Adult Passenger	31
		Smaller Children and Babies	32
		Supplemental Inflatable	
		Restraint (SIR)	26
		Top Strap	34
		Torn	38
		Twisted	25
		Why You Should Wear Safety Belts	19
		Scheduled Maintenance Services	324
		Scotchgard™ Fabric Protector	291
		Seat Belts (see <i>Safety Belts</i>)	
		Seat Controls	14
		Seats	14
		Manual Front Seat	14
		Manual Reclining Seatback	16
		Power Seat	14
		Reclining Seatback	16
		Seatback Latches	17
		Sport Seat	15
		Security Light	56, 108
		Security Shade	96
		Selective Ride Control	76
		Service ASR Light	116
		Service Engine Soon Light	118
		Service Information	240
		Service LTPWS Light	114
		Service Parts Identification Label	304
		Service Publications	348
		Service Publications Order Form	351
		Service Ride Control Light	119
		Service Station Information	368
		Setting the Clock	148
		Setting the Trip Odometer	111
		Shift Light	72

Shift Speeds.....	72	Starting Your Engine		Questions & Answers.....	28
Shifting Down to Lower Gears.....	73	Automatic Transmission.....	63	Servicing Corvettes with SIR.....	30
Shifting Into P (Park).....	78	In Very Cold Weather.....	62, 64	Warnings.....	26, 27, 30
Automatic Transmission.....	78	Manual Transmission.....	65	Synthetic Oil.....	238
Manual Transmission.....	79	Starting Your Car if the Battery		System Problems.....	120
Shifting the Transmission		is "Dead" (see <i>Jump Starting</i>)			
Automatic Transmission.....	67, 78	Steering		T achometer.....	101
Manual Transmission.....	70	In Emergencies.....	180	Taillight Replacement.....	276
Signaling Turns.....	82, 167	Off-Road Recovery.....	181	Tape Player (see <i>Audio Systems</i>)	
Signs, Road.....	164	Tips.....	179	Technical Facts & Specifications	
SIR (Supplemental Inflatable		Steering Wheel, Tilt.....	81	Bulbs.....	314
Restraint).....	26	Stereo Sound Systems		Capacities and Specifications.....	311
Six-Speed Manual Transmission.....	70	(see <i>Audio Systems</i>)		Dimensions.....	316
Skidding.....	183	Storage		Electrical Equipment,	
Snowstorm, If You're		Center Console.....	95	Add-On.....	65, 146, 304
Caught in.....	200	Glove Box.....	59	Engine Specifications.....	313
Solar Sensor.....	141	Rear Storage Compartment.....	95	Fluids & Lubricants.....	317
Sound Equipment, Adding.....	146	Storing a Flat Tire		Fuses & Circuit Breakers.....	305
Sound Systems		Except ZR-1 Rear Tires.....	233	Replacement Parts.....	312
(see <i>Audio Systems</i>)		ZR-1 Rear Tires.....	234	Service Parts Identification	
Spare Tire, Compact.....	236	Storing Your Vehicle.....	272	Label.....	304
Specifications and Capacities.....	311	Stuck, If You Are.....	201, 237	Vehicle Identification Number	
Speed Control (see <i>Cruise Control</i>)		Sun Visors.....	93	(VIN).....	303
Speedometer & Odometer.....	100	Supplemental Inflatable		Temperature Warning.....	106, 111
Sport Seat.....	15	Restraint (SIR) System.....	26	Theft.....	52
Stains, Removing.....	292	Light.....	27, 115		

Index

Theft Deterrent System.....	53	Torque Lock.....	198	Windshield Wipers.....	85
Thermostat.....	268	Towing a Trailer.....	201	Turn Signal Indicator.....	82
Throttle Cable Adjusters.....	256	Towing Your Corvette.....	208	U	
Tilt Steering Wheel.....	81	Traffic Lights.....	166	Underhood Engine Lights and	
Time, Setting the.....	148	Transmission, Automatic.....	67, 78	Fuse.....	249, 309
Tires.....	281	Transmission, Manual.....	70, 79	Universal Theft Deterrent.....	53
"Blow Out".....	224	Trip Monitor.....	110	Unleaded Gasoline.....	241
Buying New.....	284	ENG MET.....	111	Upholstery Care.....	290
Chains.....	236, 288	FUEL INFO.....	110	Urban Driving.....	190
Flat, Changing.....	225	Gauge.....	111	V	
Inflation.....	282	Trip Odo.....	111	Vehicle Identification Number	
Inspection.....	284	Trip Reset.....	111	(VIN).....	303
Loading.....	280	Trip Odometer.....	111	Vehicle Loading.....	280
Low Pressure Warning Light.....	113	Turn and Lane Change Indicator.....	82	Vehicle Storage.....	272
Pressure.....	282	Turn Signal/Headlight Beam Lever.....	82	Ventilation.....	137, 143, 145
Quality Grading.....	285	Acceleration Slip Regulation		VIN.....	303
Rotation.....	283	Button.....	89	Visor Vanity Mirrors.....	94
Spare, Compact.....	236	Cruise Control.....	84	Voltmeter.....	105
Special Wheel Nut Socket.....	226	Headlight High-Low		W	
Storing a Flat.....	233, 234	Beam Changer.....	91	Warning Flashers, Hazard.....	204
Wear Indicators.....	284	Turn & Lane Change Indicator.....	82	Warning Lights	
Wheel Alignment & Tire Balance.....	287	Turn Signal Indicator.....	82	Anti-Lock Brake System.....	117
Wheel Lock Key.....	226, 235	Turn Signal Replacement		ASR System.....	115
Wheel Replacement.....	287	Front.....	276		
When to Replace Wheels.....	287	Rear.....	276		
Winter Driving.....	198	Windshield Washer.....	83		

Brake	106	Winter Driving	198
Door Ajar	107	If Your Vehicle is Stuck in	
Inflatable Restraint	27, 115	Deep Snow	201, 257
Low Coolant	112	If You're Caught in a	
Low Oil	118	Blizzard	200
Low Tire Pressure	113	Wiring Plug, Accessory	147
Service ABS	117	Wrecker Towing	208
Service Engine Soon	118		
Service LTPWS	114	Z R-1 Hotline	75
Washer, Windshield	83		
Weatherstrips	301		
Weight (GAWR)	280		
Weight (GVWR)	280		
Wheel Alignment & Tire Balance	287		
Wheel Lock Key	235		
Wheel Nuts	226		
Wheel Nut Socket, Special	226		
Wheel Nut Torque	232, 311		
Wheel Replacement	287		
Windows, Power	81, 310		
Windshield, Treated	139		
Windshield Washer	83		
Fluid	84, 269, 318		
Windshield Wiper Replacement	279		
Windshield Wipers	83, 310		
Cleaning	295		

Service Station Information

Battery
The Delco Freedom® battery needs no water. See Page 272

Automatic Transmission Fluid
See Page 256

Manual Transmission Fluid
See Page 259

Cold Tire Pressure
See Tire-Loading Information label on rear edge of driver's door. See Page 282

Fuel
Capacity 20 U.S. Gal. (75.7 L)
Use unleaded gas only, 91 octane or higher. See Page 241

Cooling System

Check coolant at the coolant recovery tank by using the dipstick. Add coolant at the coolant recovery tank. The fluid should be at or a little above the **HOT** mark on the dipstick when the engine is warm. If the engine is cool, the level should be at **COLD** on the dipstick. See Page 262

Engine Oil
See Page 249

Windshield Washer Fluid
See Page 269

Special Wheel Nut Socket
(Located in Console)
See Page 226

Spare Tire Pressure
Compact Spare: 60 psi (420 kPa)
See Page 236

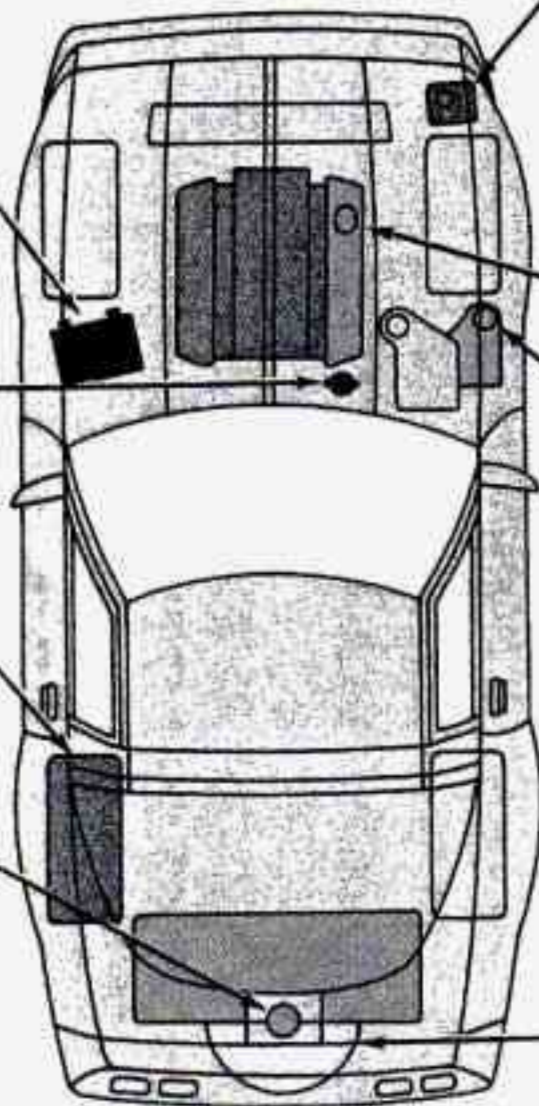



WE SUPPORT
VOLUNTARY TECHNICIAN
CERTIFICATION THROUGH

National Institute for

**AUTOMOTIVE
SERVICE
EXCELLENCE**



CHEVROLET



GM