

2015

*Cadillac*

SRX

[cadillac.com](http://cadillac.com) (U.S.)  
[cadillac.gm.ca](http://cadillac.gm.ca) (Canada)  
[cadillac.com.mx](http://cadillac.com.mx) (Mexico)



# 2015 Cadillac SRX Owner Manual

<b>In Brief</b> .....	1-1	<b>Storage</b> .....	4-1	<b>Climate Controls</b> .....	8-1
Instrument Panel .....	1-2	Storage Compartments .....	4-1	Climate Control Systems .....	8-1
Initial Drive Information .....	1-4	Additional Storage Features .....	4-3	Air Vents .....	8-7
Vehicle Features .....	1-15	Roof Rack System .....	4-11	Maintenance .....	8-8
Performance and Maintenance .....	1-19	<b>Instruments and Controls</b> .....	5-1	<b>Driving and Operating</b> .....	9-1
<b>Keys, Doors, and Windows</b> .....	2-1	Controls .....	5-2	Driving Information .....	9-2
Keys and Locks .....	2-1	Warning Lights, Gauges, and Indicators .....	5-8	Starting and Operating .....	9-14
Doors .....	2-14	Information Displays .....	5-25	Engine Exhaust .....	9-21
Vehicle Security .....	2-17	Vehicle Messages .....	5-28	Automatic Transmission .....	9-22
Exterior Mirrors .....	2-20	Vehicle Personalization .....	5-39	Drive Systems .....	9-26
Interior Mirrors .....	2-23	Universal Remote System .....	5-46	Brakes .....	9-26
Windows .....	2-23	<b>Lighting</b> .....	6-1	Ride Control Systems .....	9-30
Roof .....	2-26	Exterior Lighting .....	6-1	Cruise Control .....	9-33
<b>Seats and Restraints</b> .....	3-1	Interior Lighting .....	6-7	Driver Assistance Systems .....	9-43
Head Restraints .....	3-2	Lighting Features .....	6-8	Fuel .....	9-56
Front Seats .....	3-3	<b>Infotainment System</b> .....	7-1	Trailer Towing .....	9-60
Rear Seats .....	3-10	Introduction .....	7-1	Conversions and Add-Ons .....	9-68
Safety Belts .....	3-12			<b>Vehicle Care</b> .....	10-1
Airbag System .....	3-20			General Information .....	10-2
Child Restraints .....	3-33			Vehicle Checks .....	10-3
				Headlamp Aiming .....	10-25
				Bulb Replacement .....	10-25
				Electrical System .....	10-32
				Wheels and Tires .....	10-41

# 2015 Cadillac SRX Owner Manual

---

Jump Starting .....	10-78	<b>Customer Information</b> .....	13-1
Towing the Vehicle .....	10-82	Customer Information .....	13-1
Appearance Care .....	10-85	Reporting Safety Defects ....	13-12
<b>Service and Maintenance</b> ...	11-1	Vehicle Data Recording and Privacy .....	13-13
General Information .....	11-1	<b>OnStar</b> .....	14-1
Cadillac Premium Care Maintenance .....	11-3	OnStar Overview .....	14-1
Maintenance Schedule .....	11-3	OnStar Services .....	14-2
Special Application Services .....	11-9	OnStar Additional Information .....	14-6
Additional Maintenance and Care .....	11-9	<b>Index</b> .....	i-1
Recommended Fluids, Lubricants, and Parts .....	11-12		
Maintenance Records .....	11-14		
<b>Technical Data</b> .....	12-1		
Vehicle Identification .....	12-1		
Vehicle Data .....	12-2		



The names, logos, emblems, slogans, vehicle model names, and vehicle body designs appearing in this manual including, but not limited to, GM, the GM logo, CADILLAC, the CADILLAC Emblem, and SRX are trademarks and/or service marks of General Motors LLC, its subsidiaries, affiliates, or licensors.

For vehicles first sold in Canada, substitute the name "General Motors of Canada Limited" for Cadillac Motor Car Division wherever it appears in this manual.

This manual describes features that may or may not be on the vehicle because of optional equipment that was not purchased on the vehicle, model variants, country specifications, features/applications that may not be available in your region, or changes subsequent to the printing of this owner manual.

Refer to the purchase documentation relating to your specific vehicle to confirm the features.

Keep this manual in the vehicle for quick reference.

## Canadian Vehicle Owners

### Propriétaires Canadiens

A French language manual can be obtained from your dealer, at [www.helminc.com](http://www.helminc.com), or from:

On peut obtenir un exemplaire de ce guide en français auprès du concessionnaire ou à l'adresse suivante:

Helm, Incorporated  
 Attention: Customer Service  
 47911 Halyard Drive  
 Plymouth, MI 48170

### Using this Manual

To quickly locate information about the vehicle, use the Index in the back of the manual. It is an alphabetical list of what is in the manual and the page number where it can be found.

### Danger, Warnings, and Cautions

Warning messages found on vehicle labels and in this manual describe hazards and what to do to avoid or reduce them.

#### **Danger**

Danger indicates a hazard with a high level of risk which will result in serious injury or death.

#### **Warning**

Warning indicates a hazard that could result in injury or death.

#### **Caution**

Caution indicates a hazard that could result in property or vehicle damage.



A circle with a slash through it is a safety symbol which means “Do Not,” “Do not do this,” or “Do not let this happen.”

### Symbols

The vehicle has components and labels that use symbols instead of text. Symbols are shown along with the text describing the operation or information relating to a specific component, control, message, gauge, or indicator.

 : This symbol is shown when you need to see your owner manual for additional instructions or information.

 : This symbol is shown when you need to see a service manual for additional instructions or information.

## Vehicle Symbol Chart

Here are some additional symbols that may be found on the vehicle and what they mean. For more information on the symbol, refer to the Index.

 : Airbag Readiness Light

 : Air Conditioning

 : Antilock Brake System (ABS)

 : Audio Steering Wheel Controls or OnStar®

 : Brake System Warning Light

 : Charging System

 : Cruise Control

 : Engine Coolant Temperature

 : Exterior Lamps

 : Fog Lamps

 : Fuel Gauge

 : Fuses

 : Headlamp High/Low-Beam Changer

 : Heated Steering Wheel

 : LATCH System Child Restraints

 : Malfunction Indicator Lamp

 : Oil Pressure

 : Outside Power Foldaway Mirrors

 : Power

 : Remote Vehicle Start

 : Safety Belt Reminders

 : Tire Pressure Monitor

 : Traction Control/StabiliTrak®

 : Windshield Washer Fluid



# In Brief

## Instrument Panel

Instrument Panel ..... 1-2

## Initial Drive Information

Initial Drive Information ..... 1-4

Remote Keyless Entry (RKE)

System ..... 1-4

Remote Vehicle Start ..... 1-4

Door Locks ..... 1-5

Liftgate ..... 1-6

Windows ..... 1-6

Seat Adjustment ..... 1-7

Memory Features ..... 1-8

Heated and Ventilated

Seats ..... 1-8

Head Restraint Adjustment .... 1-9

Safety Belts ..... 1-9

Passenger Sensing

System ..... 1-10

Mirror Adjustment ..... 1-10

Steering Wheel

Adjustment ..... 1-11

Throttle and Brake Pedal

Adjustment ..... 1-11

Interior Lighting ..... 1-11

Exterior Lighting ..... 1-12

Windshield Wiper/Washer .... 1-12

Climate Controls ..... 1-14

Transmission ..... 1-15

## Vehicle Features

Infotainment System ..... 1-15

Steering Wheel Controls .... 1-15

Cruise Control ..... 1-15

Driver Information

Center (DIC) ..... 1-16

Forward Collision Alert (FCA)

System ..... 1-16

Lane Departure

Warning (LDW) ..... 1-16

Side Blind Zone

Alert (SBZA) ..... 1-17

Rear Vision

Camera (RVC) ..... 1-17

Rear Cross Traffic Alert

(RCTA) System ..... 1-17

Parking Assist ..... 1-17

Rear Automatic Braking (RAB)

System ..... 1-17

Active Emergency Braking

System ..... 1-18

Storage Compartments ..... 1-18

Power Outlets ..... 1-18

Universal Remote System ... 1-18

## Performance and Maintenance

Traction Control/Electronic

Stability Control ..... 1-19

Tire Pressure Monitor ..... 1-19

Engine Oil Life System ..... 1-20

Driving for Better Fuel

Economy ..... 1-20

Roadside Service ..... 1-21

OnStar® ..... 1-21



## Instrument Panel

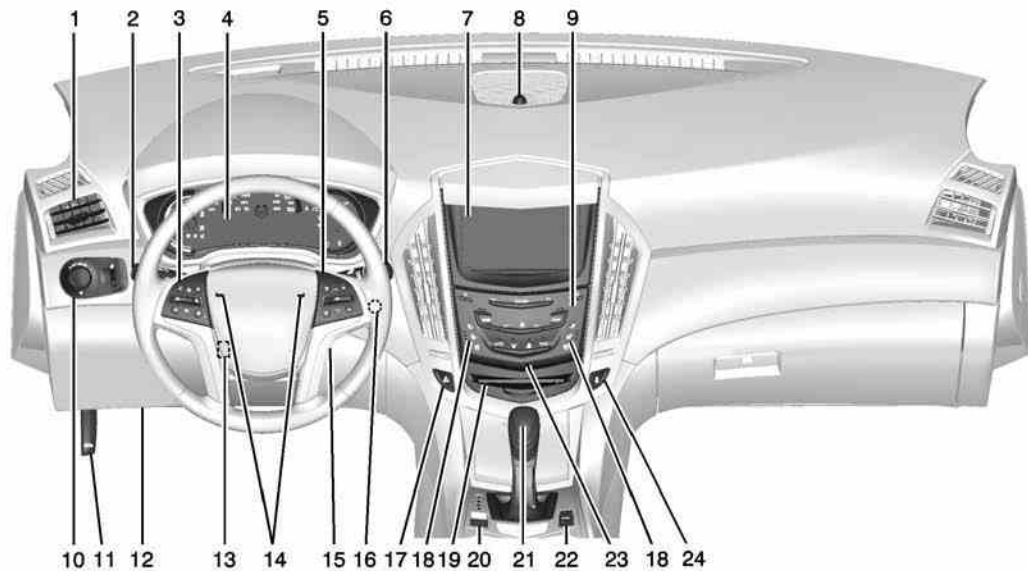

1. *Air Vents on page 8-7.*
2. *Turn Signal Lever. See Turn and Lane-Change Signals on page 6-6.*
3. *Cruise Control on page 9-33.*  
*Forward Collision Alert (FCA) System on page 9-48.*
4. *Instrument Cluster on page 5-9.*
5. *Steering Wheel Controls on page 5-2.*  
*Driver Information Center (DIC) Controls. See Driver Information Center (DIC) on page 5-25.*
6. *Windshield Wiper/Washer on page 5-3.*  
*Rear Window Wiper/Washer on page 5-4.*
7. *Infotainment on page 7-1.*
8. *Light Sensor. See Twilight Sentinel on page 6-5.*
9. *Dual Automatic Climate Control System on page 8-1.*
10. *Exterior Lamp Controls on page 6-1.*  
*Front Fog Lamps on page 6-6 (If Equipped).*  
*Instrument Panel Illumination Control on page 6-7.*
11. *Hood Release. See Hood on page 10-4.*
12. *Data Link Connector (DLC) (Out of View). See Malfunction Indicator Lamp on page 5-15.*
13. *Steering Wheel Adjustment on page 5-2.*
14. *Horn on page 5-3.*
15. *Pedal Adjust Switch (Out of View) (If Equipped). See Adjustable Throttle and Brake Pedal on page 9-14.*
16. *ENGINE START/STOP Button. See Ignition Positions on page 9-15.*
17. *Hazard Warning Flashers on page 6-6.*
18. *Heated and Ventilated Front Seats on page 3-8 (If Equipped).*
19. *CD Player. See Infotainment on page 7-1.*  
*Blu-Ray® Optical Drive (If Equipped). See Infotainment on page 7-1.*
20. *Parking Brake on page 9-27.*
21. *Shift Lever. See Automatic Transmission on page 9-22.*
22. *Lane Departure Warning Button (If Equipped). See Lane Departure Warning (LDW) on page 9-54.*  
*Parking Assist (If Equipped). See Driver Assistance Systems on page 9-43.*  
*eco Button (If Equipped). See Fuel Economy Mode on page 9-25.*
23. *Front Storage on page 4-2.*
24. *Traction Control/Electronic Stability Control on page 9-30.*

### Initial Drive Information

This section provides a brief overview about some of the important features that may or may not be on your specific vehicle.

For more detailed information, refer to each of the features which can be found later in this owner manual.

### Remote Keyless Entry (RKE) System

The RKE transmitter may be used to lock and unlock the doors from up to 60 m (197 ft) away from the vehicle.



 : Press to lock all doors.

 : Press to unlock the driver door or all doors depending on the vehicle personalization settings.

Lock and unlock feedback can be personalized.

See “Remote Lock, Unlock, Start” under *Vehicle Personalization* on page 5-39.

 : Press and release one time to initiate vehicle locator.

Press and hold  for three seconds to sound the panic alarm.

 : Press twice to open or close the liftgate. Press once to stop the liftgate from moving.

Press the key release button near the bottom of the transmitter to remove the key. The key can be used for the driver door and the glove box.

See *Keys* on page 2-1 and *Remote Keyless Entry (RKE) System Operation* on page 2-3.

### Remote Vehicle Start

If available, this feature allows the engine to be started from outside of the vehicle.

### Starting the Vehicle

1. Press and release  on the RKE transmitter.
2. Immediately press and hold  for at least four seconds or until the turn signal lamps flash.

When the vehicle starts, the parking lamps will remain on as long as the engine is running. The doors will be locked and the climate control system may come on.

The engine will continue to run for 10 minutes. After 30 seconds, repeat the steps if a 10-minute extension is desired. Remote start can be extended only once.

### Canceling a Remote Start

To cancel a remote start, do any of the following:

- Press and hold  until the parking lamps turn off.
- Turn on the hazard warning flashers.
- Turn the vehicle on and then off.

See *Remote Vehicle Start* on page 2-9.

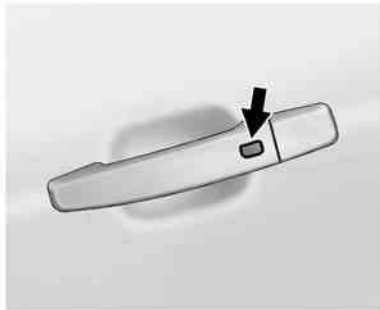

## Door Locks

### Keyless Access



When the Remote Keyless Entry (RKE) transmitter is within 1 m (3 ft) of the driver door, pressing the lock/unlock button on that door handle will lock/unlock the doors. If the lock/unlock button is pressed again within five seconds, all passenger doors will unlock. See *Remote Keyless Entry (RKE) System Operation* on page 2-3.

### Remote Keyless Entry (RKE)

To lock or unlock the doors from the outside, press  or  on the RKE transmitter. See *Remote Keyless Entry (RKE) System Operation* on page 2-3.

### Key

To lock or unlock the door, use the key in the driver door. Turn the key counterclockwise once to unlock the driver door; turning the key again will unlock the passenger doors.

### Inside the Vehicle

To unlock a door from the inside, pull once on the door handle to unlock it, and a second time to open it.

### Power Door Locks

There is a power door lock switch on the front door panels.

 : Press to lock the doors.

 : Press to unlock the doors.

See *Power Door Locks* on page 2-12.

### Liftgate

#### Manual Liftgate Operation

For vehicles without Keyless Access, unlock the vehicle before opening the liftgate.

Press the touch pad in the handle of the liftgate above the license plate and lift up to open.

Do not press the touch pad while closing the liftgate. This will cause the liftgate to be unlatched.

### Power Liftgate Operation

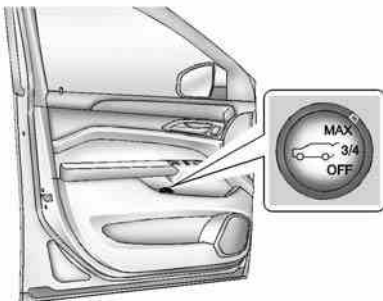

On vehicles with a power liftgate, the switch is on the driver door. The vehicle must be in P (Park) to use the power feature. The taillamps flash when the power liftgate moves.

Choose a power liftgate mode by turning the dial on the switch until the indicator lines up with the desired position. Press the center of the switch.

The three modes are:

**MAX:** The liftgate opens to the full open height.

**3/4:** The liftgate opens to a reduced height that can be set by the vehicle operator in a range of approximately three-quarters open to full open.

**OFF:** The liftgate only operates manually in this position.

See *Liftgate* on page 2-14.

### Windows

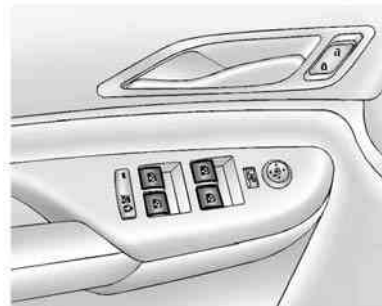

Press or pull the switch part of the way to open or close the window.

Fully press the front of the switch down and release it to express-down the window.

If equipped, the front windows have an express-up feature. Fully pull the switch up and release it.

Press  to activate the window lockout on the rear doors.

See *Power Windows on page 2-24*.

### Remote Window Operation

If equipped, remote operating windows will open all the windows from outside the vehicle by pressing and holding  on the Remote Keyless Entry (RKE) transmitter.

See *Power Windows on page 2-24*.

## Seat Adjustment

### Manual Seats



To adjust a manual seat:

1. Pull the handle at the front of the seat cushion.
2. Move the seat forward or rearward to adjust the seat position.
3. Release the handle to stop the seat from moving.

4. Try to move the seat back and forth to be sure it is locked in place.

To raise or recline the seatback, use the lever on the outboard side of the seat.

See *Seat Adjustment on page 3-3* and *Reclining Seatbacks on page 3-5*.

### Power Seats

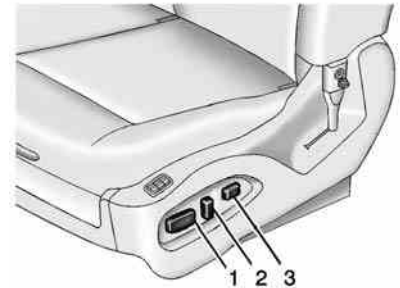

1. Seat Position Control
2. Seatback Adjustment Control
3. Lumbar Adjustment Control

## 1-8 In Brief

To adjust a power seat, if equipped:

- Move the seat forward or rearward by sliding the control (1) forward or rearward.
- Raise or lower the front part of the seat cushion by moving the front of the control (1) up or down.
- Raise or lower the entire seat by moving the rear of the control (1) up or down.

See *Power Seat Adjustment on page 3-4.*

- Raise or recline the seatback by tilting control (2) forward or rearward.

See *Reclining Seatbacks on page 3-5.*

- Increase or decrease the lumbar support by pressing and holding the front or rear of the control (3). See *Lumbar Adjustment on page 3-4.*

## Memory Features



If equipped, the “1,” “2,” and MEM buttons on the outboard side of the driver seat are used to manually save and recall the positions of the driver seat, outside mirrors, and adjustable throttle and brake pedal positions.



See *Memory Seats on page 3-6* and *Vehicle Personalization on page 5-39.*

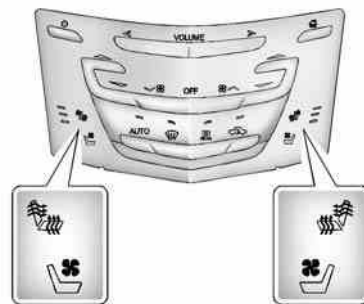

## Heated and Ventilated Seats



### Heated and Ventilated Seat Buttons Shown, Heated Seat Buttons Similar

If available, the buttons are near the climate controls on the center stack. To operate, the ignition must be in ON/RUN/START.

Press  or  to heat the driver or passenger seat.

Press  or , if available, to ventilate the driver or passenger seat. A ventilated seat has a fan that pulls or pushes air through the seat. The air is not cooled.

Press the button once for the highest setting. With each press of the button, the seat will change to the next lower setting, and then to the off setting. The indicator lights next to the buttons indicate three for the highest setting and one for the lowest. If the front heated seats are on high, the level may automatically be lowered after approximately 30 minutes.

See *Heated and Ventilated Front Seats* on page 3-8.

The heated and ventilated front seats can also be programmed to come on during a remote start. See *Vehicle Personalization* on page 5-39.

## Head Restraint Adjustment

Do not drive until the head restraints for all occupants are installed and adjusted properly.

To achieve a comfortable seating position, change the seatback recline angle as little as necessary while keeping the seat and the head restraint height in the proper position.

See *Head Restraints* on page 3-2 and *Seat Adjustment* on page 3-3.

## Safety Belts



Refer to the following sections for important information on how to use safety belts properly:

- *Safety Belts* on page 3-12.
- *How to Wear Safety Belts Properly* on page 3-13.
- *Lap-Shoulder Belt* on page 3-14.
- *Lower Anchors and Tethers for Children (LATCH System)* on page 3-40.



## Passenger Sensing System



United States



Canada and Mexico

The passenger sensing system will turn off the front outboard passenger frontal airbag under certain conditions. No other airbag is affected by the passenger sensing system.

The passenger airbag status indicator will be visible on the overhead console when the vehicle is started. See *Passenger Sensing System* on page 3-26.

## Mirror Adjustment

### Exterior

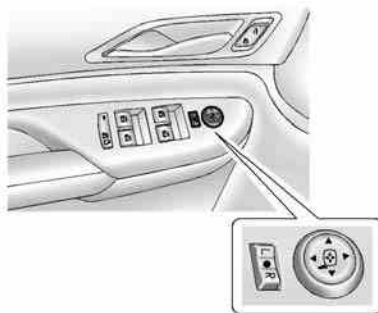

Manual Folding Mirrors Shown, Power Folding Similar

To adjust the mirror:

1. Move the selector switch to L (Left) or R (Right) to choose the driver or passenger mirror.
2. Press the arrows on the control pad to move each mirror to the desired position.
3. Return the selector switch to the center position.

See *Folding Mirrors* on page 2-21.

### Automatic Dimming Mirror

If equipped, the driver outside mirror and the inside rearview mirror automatically adjust for the glare of headlamps behind you. See *Automatic Dimming Mirror* on page 2-22 or *Automatic Dimming Rearview Mirror* on page 2-23.

## Steering Wheel Adjustment

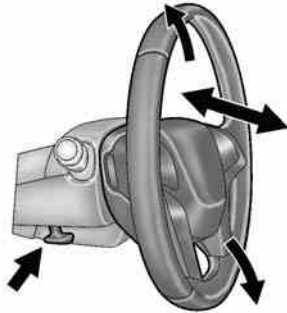

To adjust the steering wheel:

1. Pull the lever down.
2. Move the steering wheel up or down.
3. Pull or push the steering wheel closer or away from you.
4. Pull the lever up to lock the steering wheel in place.

Do not adjust the steering wheel while driving.

## Throttle and Brake Pedal Adjustment

If the vehicle has this feature, the position of the throttle and brake pedals can be adjusted.

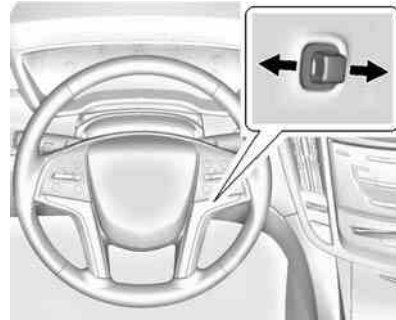

The switch used to adjust the pedals is located on the right side of the steering column, below the wiper stalk. Pull the switch toward you to move the pedals further from the floor, or push the switch away from you to move the pedals closer to the floor.

See *Adjustable Throttle and Brake Pedal* on page 9-14.

## Interior Lighting

### Dome Lamp

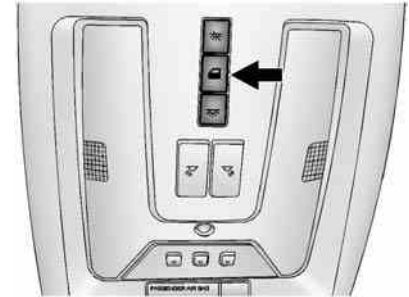

To change the dome lamp settings, press the following:

 : Turns the lamp off, even when a door is open.

 : The lamp comes on when a door is opened.



 : Turns the dome lamp on.

## 1-12 In Brief

### Reading Lamps

There are reading lamps on the overhead console and over the rear passenger doors. These lamps come on when any door is opened.

To manually turn the reading lamps on or off:

- For the overhead console reading lamps, press the  or  next to each lamp.
- For the rear passenger reading lamps, press the lamp lens.

For more information on interior lighting, see *Instrument Panel Illumination Control* on page 6-7.

### Exterior Lighting

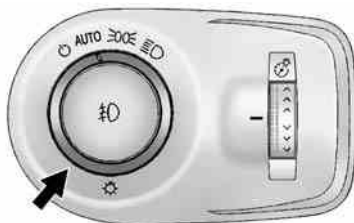



The exterior lamp control is on the instrument panel to the left of the steering column.

Turn the control to the following positions:

 : Briefly turn to this position to turn the automatic light control off or on again.

**AUTO:** Automatically turns the exterior lamps on and off, depending on outside lighting.

 : Turns on the parking lamps including all lamps, except the headlamps.

 : Turns on the headlamps together with the parking lamps and instrument panel lights. A warning chime sounds if the driver door is opened when the ignition switch is off and the headlamps are on.

 : If equipped with fog lamps, press to turn the lamps on or off.

See:

- *Exterior Lamp Controls* on page 6-1.
- *Daytime Running Lamps (DRL)* on page 6-3.

### Windshield Wiper/Washer



With the ignition in ACC/ACCESSORY or ON/RUN/START, move the windshield wiper lever to select the wiper speed.

**HI:** Use for fast wipes.

**LO:** Use for slow wipes.



**INT:** Use for intermittent wipes. To adjust wipe frequency, turn the INT band up for more frequent wipes or down for less frequent wipes. If the vehicle has Rainsense™, see *Windshield Wiper/Washer on page 5-3*.

- Turn the band up for more sensitivity to moisture.
- Turn the band down for less sensitivity to moisture.
- Move the windshield wiper lever out of the INT position to deactivate Rainsense.

**OFF:** Use to turn the wipers off.

**1X :** For a single wipe, briefly move the wiper lever down. For several wipes, hold the wiper lever down.

### Windshield Washer

Pull the windshield wiper lever toward you to spray windshield washer fluid and activate the wipers.

### Rear Window Wiper/Washer

The rear wiper controls are on the end of the windshield wiper lever.



**ON:** Press the upper portion of the button for continuous rear window wipes.

**OFF:** The rear wiper turns off when the button is returned to the middle position.

**INT:** Press the lower portion of the button to set a delay between wipes.

 : Push the windshield wiper lever forward to spray washer fluid on the rear window.

See *Windshield Wiper/Washer on page 5-3* and *Rear Window Wiper/Washer on page 5-4*.

### Climate Controls

The climate control buttons and the touch screen are used to adjust the heating, cooling, and ventilation.

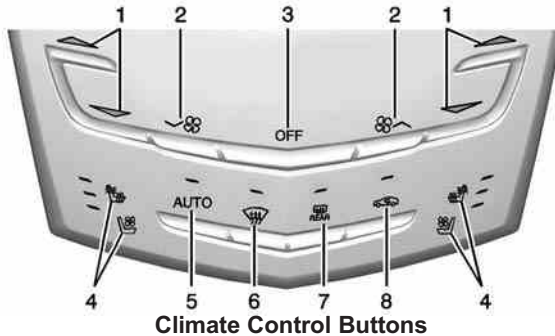

1. Driver and Passenger Temperature Controls
2. Fan Control
3. OFF (Fan)
4. Driver and Passenger Heated and Ventilated Seats
5. AUTO (Automatic Operation)
6. Defrost
7. Rear Window Defogger
8. Recirculation

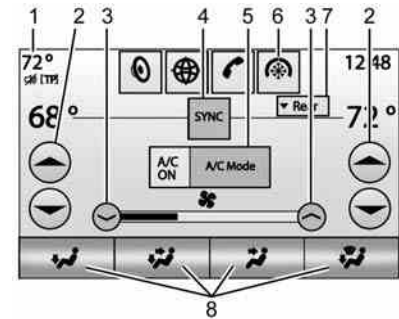

### Climate Touch Screen Controls

1. Outside Temperature Display
2. Driver and Passenger Temperature Controls
3. Fan Control
4. SYNC (Synchronized Temperature)
5. A/C Mode (Air Conditioning)
6. Climate Control Selection (Application Tray Button)
7. Rear (Rear Climate Control Touch Screen)
8. Air Delivery Mode Control

See *Dual Automatic Climate Control System* on page 8-1 and *Rear Climate Control System* on page 8-6 (if equipped).

## Transmission

### Driver Shift Control (DSC)

DSC allows you to shift an automatic transmission similar to a manual transmission. To use the DSC feature:

1. Move the shift lever to the left from D (Drive) to Sport Mode.
2. To enter M (Manual Mode), press the shift lever forward to upshift or rearward to downshift.

See *Manual Mode* on page 9-24.

## Vehicle Features

### Infotainment System

See the infotainment manual for information on the radio, audio players, phone, navigation system, and voice or speech recognition. It also includes information on settings and downloadable applications (if equipped).

### Steering Wheel Controls

The infotainment system can be operated by using the steering wheel controls. See "Steering Wheel Controls" in the infotainment manual.

## Cruise Control



 : Press to turn the system on and off. A white indicator appears in the instrument cluster when cruise is turned on.

**+RES:** If there is a set speed in memory, press the control up briefly to resume to that speed or press and hold to accelerate. If cruise control is already active, use to increase vehicle speed.

**SET-**: Press the control down briefly to set the speed and activate cruise control or to decrease vehicle speed if the cruise control is already activated.

: Press to disengage cruise control without erasing the set speed from memory.

See *Cruise Control* on page 9-33 or *Adaptive Cruise Control* on page 9-35 (if equipped).

### Driver Information Center (DIC)

The DIC display is in the instrument cluster. It shows the status of many vehicle systems.



**▲ or ▼**: Move SEL up or down to go to the previous or next selection.

**< or >**: Press to move between the interactive display zones in the cluster. Press **<** to go back to the previous menu.

**SEL**: Press to open a menu or select a menu item. Press and hold to reset values on certain screens.

See *Driver Information Center (DIC)* on page 5-25.

### Forward Collision Alert (FCA) System

If equipped, FCA may help avoid or reduce the harm caused by front-end crashes. FCA provides a green indicator, , when a vehicle is detected ahead. This indicator displays amber if you follow a vehicle much too closely. When approaching a vehicle ahead too quickly, FCA provides a flashing red alert on the windshield and rapidly beeps or pulses the driver seat.

See *Forward Collision Alert (FCA) System* on page 9-48.

### Lane Departure Warning (LDW)

If equipped, LDW may help avoid unintentional lane departures at speeds of 56 km/h (35 mph) or greater. LDW uses a camera sensor to detect the lane markings. The LDW light, , is green if a lane marking is detected. If the vehicle departs the lane, the light will

change to amber and flash. In addition, beeps will sound or the driver seat will pulse.

See *Lane Departure Warning (LDW)* on page 9-54.

## Side Blind Zone Alert (SBZA)

If equipped, SBZA will detect vehicles in the next lane over in the vehicle's side blind zone area. When this happens, the SBZA display will light up in the corresponding outside side mirror and will flash if the turn signal is on.

See *Side Blind Zone Alert (SBZA)* on page 9-52.

## Rear Vision Camera (RVC)

If equipped, RVC displays a view of the area behind the vehicle on the center stack display when the vehicle is shifted into R (Reverse) to aid with parking and low-speed backing maneuvers.

See *Assistance Systems for Parking or Backing* on page 9-44.

## Rear Cross Traffic Alert (RCTA) System

If equipped, the RCTA system uses a triangle with an arrow displayed on the RVC screen to warn of traffic behind your vehicle that may cross your vehicle's path while in R (Reverse). In addition, beeps will sound, or the driver seat will pulse.

See *Assistance Systems for Parking or Backing* on page 9-44.

## Parking Assist

If equipped, Rear Parking Assist (RPA) uses sensors on the rear bumper to assist with parking and avoiding objects while in R (Reverse). It operates at speeds less than 8 km/h (5 mph). RPA may display a warning triangle on the Rear Vision Camera screen and a graphic on the instrument cluster to provide the object distance. In

addition, multiple beeps or seat pulses may occur if very close to an object.

The vehicle may also have the Front Parking Assist system.

See *Assistance Systems for Parking or Backing* on page 9-44.

## Rear Automatic Braking (RAB) System

If the vehicle has Adaptive Cruise Control (ACC) it also has the Rear Automatic Braking (RAB) system, which is designed to help avoid or reduce the harm caused by backing crashes when the vehicle is shifted into R (Reverse). If the system detects the vehicle is backing too fast to avoid a crash with a detected object behind your vehicle in your path, it may automatically brake hard to a stop.

See *Assistance Systems for Parking or Backing* on page 9-44.



## Active Emergency Braking System

If the vehicle has Adaptive Cruise Control (ACC) it also has the Active Emergency Braking System, which includes Intelligent Brake Assist (IBA) and the Automatic Collision Preparation (ACP) System. These systems can provide a boost to braking or automatically brake the vehicle to help avoid or lessen the severity of crashes when driving in a forward gear.

See *Active Emergency Braking System* on page 9-51.

## Storage Compartments

The glove box is air conditioned and can be used to store items at a lower temperature. Move the slide control to open or close the opening to adjust the air flow. See *Glove Box* on page 4-1.

## Power Outlets

The accessory power outlets can be used to plug in electrical equipment, such as a cell phone or MP3 player.

The vehicle may have up to five accessory power outlets.

The accessory power outlets are:

- Below the climate control system inside the front storage bin.
- Inside the center floor console.
- On the rear of the center floor console. For vehicles with a rear climate control system, there will be two accessory power outlets on the rear of the center floor console.
- In the rear cargo area.

These are powered while the vehicle is in ON/RUN/START or ACC/ACCESSORY mode, or until the driver door is opened within 10 minutes of turning off the vehicle.

The power outlet located in the rear cargo area is powered at all times.

See *Power Outlets* on page 5-6.

## Universal Remote System



If available, this system provides a way to replace up to three remote control transmitters used to activate devices such as garage door openers, security systems, and home automation devices.

Read the instructions completely before attempting to program the Universal Remote system. Because of the steps involved, it may be helpful to have another person available to assist you with programming the Universal Remote system.



See *Universal Remote System* on page 5-46.









## Performance and Maintenance

### Traction Control/ Electronic Stability Control

The Traction Control System (TCS) limits wheel spin. The system turns on automatically when the vehicle is started.

The StabiliTrak system assists with directional control of the vehicle in difficult driving conditions. The system turns on automatically when the vehicle is started.

- To turn off traction control, press and release  on the center stack.  illuminates in the instrument cluster. The appropriate message is displayed in the DIC. See *Ride Control System Messages on page 5-36*.

- Press and release  again to turn traction control back on.  goes out in the instrument cluster. The appropriate message is displayed in the DIC. See *Ride Control System Messages on page 5-36*.
- To turn off both traction control and StabiliTrak, press and hold  on the center stack until  and  illuminate in the instrument cluster. The appropriate message is displayed in the DIC. See *Ride Control System Messages on page 5-36*.
- Press  again to turn on both systems.  and  go out in the instrument cluster. The appropriate message is displayed in the DIC. See *Ride Control System Messages on page 5-36*.

See *Traction Control/Electronic Stability Control on page 9-30*.

### Tire Pressure Monitor

This vehicle may have a Tire Pressure Monitor System (TPMS).



The low tire pressure warning light alerts to a significant loss in pressure of one of the vehicle's tires. If the warning light comes on, stop as soon as possible and inflate the tires to the recommended pressure shown on the Tire and Loading Information label. See *Vehicle Load Limits on page 9-9*. The warning light will remain on until the tire pressure is corrected.

The low tire pressure warning light may come on in cool weather when the vehicle is first started, and then turn off as the vehicle is driven. This may be an early indicator that the

tire pressures are getting low and the tires need to be inflated to the proper pressure.

The TPMS does not replace normal monthly tire maintenance. Maintain the correct tire pressures.

See *Tire Pressure Monitor System* on page 10-50.

### Engine Oil Life System

The engine oil life system calculates engine oil life based on vehicle use and displays the CHANGE ENGINE OIL SOON message when it is time to change the engine oil and filter. The oil life system should be reset to 100% only following an oil change.

#### Resetting the Oil Life System

1. Using the DIC controls on the right side of the steering wheel, display REMAINING OIL LIFE on the DIC. See *Driver Information Center (DIC)* on page 5-25. When remaining oil life is low, the CHANGE

ENGINE OIL SOON message will appear on the display. See *Engine Oil Messages* on page 5-31.

2. Press SEL on the DIC controls and hold SEL down for a few seconds to clear the CHANGE ENGINE OIL SOON message and reset the oil life at 100%.

Be careful not to reset the oil life display accidentally at any time other than after the oil is changed. It cannot be reset accurately until the next oil change.

The oil life system can also be reset as follows:

1. Turn the ignition on with the engine off.
2. Fully press and release the accelerator pedal three times within five seconds.

If the CHANGE ENGINE OIL SOON message is not on, the system is reset.

See *Engine Oil Life System* on page 10-9.

### Driving for Better Fuel Economy

Driving habits can affect fuel mileage. Here are some driving tips to get the best fuel economy possible.

- Avoid fast starts and accelerate smoothly.
- Brake gradually and avoid abrupt stops.
- Avoid idling the engine for long periods of time.
- When road and weather conditions are appropriate, use cruise control.
- Always follow posted speed limits or drive more slowly when conditions require.
- Keep vehicle tires properly inflated.
- Combine several trips into a single trip.

- Replace the vehicle's tires with the same TPC Spec number molded into the tire's sidewall near the size.
- Follow recommended scheduled maintenance.

## Roadside Service

U.S.: 1-800-224-1400

Canada: 1-800-882-1112

TTY Users (U.S. Only):  
1-888-889-2438

New Cadillac owners are automatically enrolled in the Roadside Service Program.

See *Roadside Service* on page 13-5.

## OnStar®

This vehicle may be equipped with a comprehensive, in-vehicle system that can connect to a live OnStar Advisor for Emergency, Security, Navigation, Connection, and Diagnostic Services. OnStar services may require a paid subscription. See *OnStar Overview* on page 14-1.



# Keys, Doors, and Windows

## Keys and Locks

- Keys ..... 2-1
- Remote Keyless Entry (RKE) System ..... 2-2
- Remote Keyless Entry (RKE) System Operation ..... 2-3
- Remote Vehicle Start ..... 2-9
- Door Locks ..... 2-11
- Power Door Locks ..... 2-12
- Delayed Locking ..... 2-12
- Automatic Door Locks ..... 2-12
- Lockout Protection ..... 2-13
- Safety Locks ..... 2-13

## Doors

- Liftgate ..... 2-14

## Vehicle Security

- Vehicle Security ..... 2-17
- Vehicle Alarm System ..... 2-17
- Immobilizer ..... 2-19
- Immobilizer Operation ..... 2-19

## Exterior Mirrors

- Convex Mirrors ..... 2-20
- Power Mirrors ..... 2-21
- Folding Mirrors ..... 2-21
- Heated Mirrors ..... 2-22
- Automatic Dimming Mirror ... 2-22
- Reverse Tilt Mirrors ..... 2-22

## Interior Mirrors

- Interior Rearview Mirrors ..... 2-23
- Manual Rearview Mirror ..... 2-23
- Automatic Dimming Rearview Mirror ..... 2-23

## Windows

- Windows ..... 2-23
- Power Windows ..... 2-24
- Sun Visors ..... 2-26

## Roof

- Sunroof ..... 2-26

# Keys and Locks

## Keys

 **Warning**

Leaving children in a vehicle with a Remote Keyless Entry (RKE) transmitter is dangerous and children or others could be seriously injured or killed. They could operate the power windows or other controls or make the vehicle move. The windows will function with the RKE transmitter in the vehicle, and children or others could be caught in the path of a closing window. Do not leave children in a vehicle with an RKE transmitter.

## 2-2 Keys, Doors, and Windows



The key, inside the Remote Keyless Entry (RKE) transmitter, is used for the driver door and glove box.



To remove the key, press the button near the bottom of the transmitter, and pull the key out. Never pull the key out without pressing the button.

If it becomes difficult to turn the key, inspect the key blade for debris.

See your dealer if a new key is needed.

Contact Roadside Service if locked out of the vehicle. See *Roadside Service* on page 13-5.

With an active OnStar subscription, an OnStar Advisor may remotely unlock the vehicle. See *OnStar Overview* on page 14-1.

### Remote Keyless Entry (RKE) System

See *Radio Frequency Statement* on page 13-12.

If there is a decrease in the RKE operating range:

- Check the distance. The transmitter may be too far from the vehicle.
- Check the location. Other vehicles or objects may be blocking the signal.
- Check the transmitter's battery. See "Battery Replacement" later in this section.
- If the transmitter is still not working correctly, see your dealer or a qualified technician for service.

## Remote Keyless Entry (RKE) System Operation

The Keyless Access system allows for vehicle entry when the transmitter is within range. See “Keyless Access Operation” following.

The RKE transmitter functions may work up to 60 m (197 ft) away from the vehicle.

Keep in mind that other conditions, such as those previously stated, can impact the performance of the transmitter.



### With Remote Start and Power Liftgate Shown, Without Similar

**🔒 (Lock):** Press to lock all doors. The turn signal indicators may flash and/or the horn may sound on the second press to indicate locking. See “Remote Lock, Unlock, Start” under *Vehicle Personalization on page 5-39*.

If the driver door is open when 🔒 is pressed, all doors lock except the driver door, if Unlocked Door Anti Lock Out is enabled through the

vehicle personalization. If the passenger door is open when 🔒 is pressed, all doors lock.

Pressing 🔒 may also arm the theft-deterrent system. See *Vehicle Alarm System on page 2-17*.

If equipped, pressing 🔒 will also lock the fuel door.

**🔓 (Unlock):** Press to unlock the driver door or all doors. See “Remote Lock, Unlock, Start” under *Vehicle Personalization on page 5-39*. When remotely unlocking the vehicle at night the fog lamps and back-up lamps will come on for about 20 seconds to light your approach to the vehicle. The turn signal indicators may flash to indicate unlocking. See “Remote Lock, Unlock, Start” under *Vehicle Personalization on page 5-39*.

Memory seat positions may be recalled when unlocking the vehicle. See “Remote Lock, Unlock, Start” under *Vehicle Personalization on page 5-39*.







## 2-4 Keys, Doors, and Windows



---

Pressing  will disarm the theft-deterrent system. See *Vehicle Alarm System on page 2-17*.

On some models, pressing and holding  will open all of the windows.

If equipped, pressing  will also unlock the fuel door.

 **(Remote Start):** For vehicles with this feature, press and release  and then immediately press and hold  for at least four seconds to start the engine from outside the vehicle using the RKE transmitter. See *Remote Vehicle Start on page 2-9*.

 **(Vehicle Locator/Panic Alarm):** Press and release one time to initiate vehicle locator. The exterior lamps flash and the horn chirps three times. Press and hold  for three seconds to sound the panic alarm. The horn sounds and

the turn signal lamps flash for 30 seconds, or until  is pressed again or the vehicle is started.

 **(Remote Liftgate Release):** Press twice to open or close the liftgate.

Press once to stop the liftgate from moving.

### Keyless Access Operation

With the Keyless Access system, you can lock and unlock the doors and access the hatch without removing the RKE transmitter from your pocket, purse, briefcase, etc. The RKE transmitter should be within 1 m (3 ft) of the door or hatch being opened.

Keyless Access can be programmed to unlock all doors on the first lock/unlock press from the driver door. See *Vehicle Personalization on page 5-39*.

### Keyless Unlocking/Locking from the Driver Door

When the doors are locked and the RKE transmitter is within 1 m (3 ft) of the driver door handle, pressing the lock/unlock button on the driver door handle will unlock the driver door. If the lock/unlock button is pressed again within five seconds, all passenger doors will unlock.



### Passenger Shown, Driver Similar

Pressing the lock/unlock button will cause all doors to lock if any of the following occur:

- It has been more than five seconds since the first lock/unlock button press.
- Two lock/unlock button presses were used to unlock all doors.
- Any vehicle door has opened and all doors are now closed.

### Keyless Unlocking/Locking from Passenger Doors

When the doors are locked and the RKE transmitter is within 1 m (3 ft) of the door handle, pressing the lock/unlock button on that door handle will unlock all doors. Pressing the lock/unlock button will cause all doors to lock if any of the following occur:

- The lock/unlock button was used to unlock all doors.
- Any vehicle door has opened and all doors are now closed.



### Passive Locking

If equipped with Keyless Access, this vehicle will lock several seconds after all doors are closed if the vehicle is off and at least one RKE transmitter has been removed or none remain in the interior.

If equipped with a locking fuel door, the fuel door will also lock at this time.

If other electronic devices interfere with the RKE transmitter signal, the vehicle may not detect the RKE transmitter inside the vehicle. If passive locking is enabled, the doors may lock with the RKE transmitter inside the vehicle. Do not leave the RKE transmitter in an unattended vehicle.

### Temporary Disable Passive Locking Feature

Temporarily disable the passive locking by pressing and holding  on the interior door switch with a door open for at least four seconds, or until three chimes are heard. Passive locking will then remain disabled until  on the interior door is pressed, or until the vehicle is turned on.

To customize the doors to automatically lock when exiting the vehicle, see “Remote Lock, Unlock, Start” under *Vehicle Personalization* on page 5-39.

## 2-6 Keys, Doors, and Windows

### Keyless Liftgate Opening

Press the touch pad on the liftgate handle to open the liftgate if the RKE transmitter is within 1 m (3 ft).

### Programming Transmitters to the Vehicle

Only RKE transmitters programmed to the vehicle will work. If a transmitter is lost or stolen, a replacement can be purchased and programmed through your dealer. The vehicle can be reprogrammed so that lost or stolen transmitters no longer work. Each vehicle can have up to eight transmitters matched to it.

### Programming with a Recognized Transmitter



A new transmitter can be programmed to the vehicle when there is one recognized transmitter.

To program, the vehicle must be off and all of the transmitters, both currently recognized and new, must be with you.

1. Place the recognized transmitter(s) in the cupholder.
2. Insert the vehicle key of the transmitter into the key lock cylinder on the driver door handle and turn the key, counterclockwise, to the unlock position five times within 10 seconds.

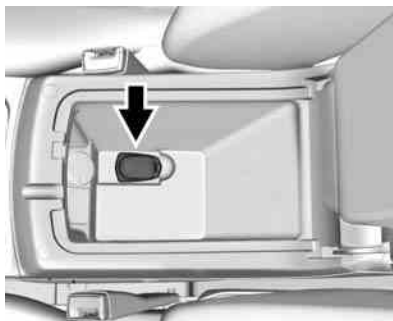
The Driver Information Center (DIC) displays READY FOR REMOTE #2, 3, 4, ETC.



3. Place the new transmitter into the transmitter pocket. The transmitter pocket is inside the center console storage area between the driver and front passenger seats. The storage area will need to be opened and the storage tray lifted up to access the transmitter pocket.
4. Press the ENGINE START/STOP button. When the transmitter is learned the DIC display will show that it is ready to program the next transmitter.
5. Remove the transmitter from the transmitter pocket and press the transmitter  or  button.  
To program additional transmitters, repeat Steps 3–5.  
When all additional transmitters are programmed, press and hold the ENGINE START/STOP button for 12 seconds to exit programming mode.

### Programming without a Recognized Transmitter

If there are no currently recognized transmitters available, follow this procedure to program up to eight transmitters. This feature is not available in Canada. This procedure will take approximately 30 minutes to complete. The vehicle must be off and all of the transmitters you wish to program must be with you.

1. Insert the vehicle key of the transmitter into the key lock cylinder on the driver door handle and turn the key, counterclockwise, to the unlock position five times within 10 seconds.

The Driver Information Center (DIC) displays REMOTE LEARN PENDING, PLEASE WAIT.

2. Wait for 10 minutes until the DIC displays PRESS ENGINE START BUTTON TO LEARN and then press the ENGINE START/STOP button.

The DIC displays will again show REMOTE LEARN PENDING, PLEASE WAIT.

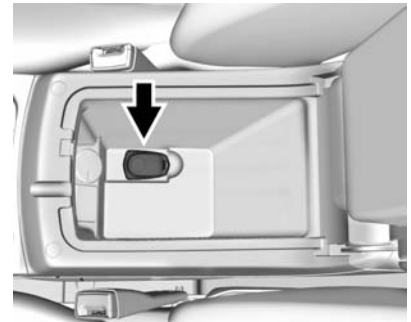

3. Repeat Step 2 two additional times. After the third time all previously known transmitters will no longer work with the vehicle. Remaining transmitters can be relearned during the next steps.

The DIC display should now show READY FOR REMOTE # 1.



4. Place the new transmitter into the transmitter pocket. The transmitter pocket is inside the center console storage area between the driver and front passenger seats. The storage area will need to be opened and the storage tray lifted up to access the transmitter pocket.
5. Press the ENGINE START/STOP button. When the transmitter is learned the DIC display will show that it is ready to program the next transmitter.

## 2-8 Keys, Doors, and Windows

- Remove the transmitter from the transmitter pocket and press the transmitter  or  button.

To program additional transmitters, repeat Steps 4–6.

When all additional transmitters are programmed, press and hold the ENGINE START/STOP button for 12 seconds to exit programming mode.

### Starting the Vehicle with a Low Transmitter Battery

When the vehicle is started, if the transmitter battery is weak, the DIC may display NO REMOTE DETECTED or NO REMOTE KEY WAS DETECTED PLACE KEY IN TRANSMITTER POCKET THEN START YOUR VEHICLE. The REPLACE BATTERY IN REMOTE KEY message may also be displayed at this time.

To start the vehicle:

- Open the center console storage area and the storage tray.

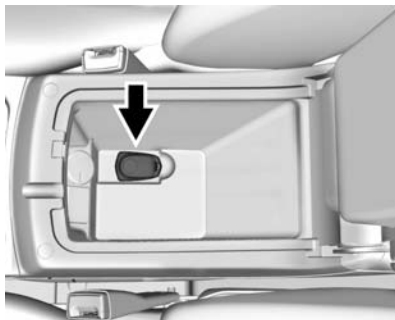

- Place the transmitter in the transmitter pocket.
- With the vehicle in P (Park) or N (Neutral), press the brake pedal and the ENGINE START/STOP button.

Replace the transmitter battery as soon as possible.

### Battery Replacement



#### Caution

When replacing the battery, do not touch any of the circuitry on the transmitter. Static from your body could damage the transmitter.

Replace the battery if the REPLACE BATTERY IN REMOTE KEY message displays in the DIC.

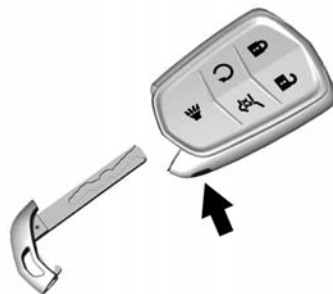

1. Press the button on the side of the transmitter near the bottom and pull the key out.



2. Separate the two halves of the transmitter using a flat tool inserted into the bottom center of the transmitter. Do not use the key slot.

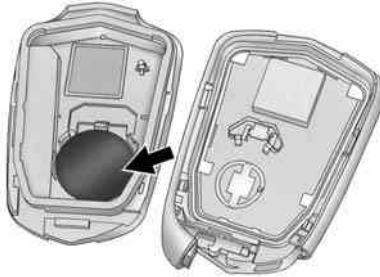

3. Remove the old battery. Do not use a metal object.
4. Insert the new battery on the back housing, positive side facing down. Replace with a CR2032 or equivalent battery.
5. Align the front and back housing then snap the transmitter together.

### Remote Vehicle Start

If available, this feature allows the engine to be started from outside of the vehicle.

**Ⓚ (Remote Vehicle Start):** This button will be on the RKE transmitter if the vehicle has remote start.

The climate control system will use the previous settings during a remote start. The rear defog may come on during remote start based on cold ambient conditions. The rear fog indicator light does not come on during remote start.

If the vehicle has heated seats, they may come on during a remote start. See *Heated and Ventilated Front Seats* on page 3-8



Laws in some local communities may restrict the use of remote starters. For example, some laws may require a person using remote start to have the vehicle in view. Check local regulations for any requirements.

Other conditions can affect the performance of the transmitter. See *Remote Keyless Entry (RKE) System* on page 2-2 for additional information.

## 2-10 Keys, Doors, and Windows

---

### Starting the Engine Using Remote Start

1. Press and release  on the RKE transmitter.
2. Immediately press and hold  for at least four seconds or until the turn signal lamps flash. The turn signal lamps flashing confirms the request to remote start the vehicle has been received.

During the remote start the doors will be locked and the parking lamps will remain on as long as the engine is running.

The engine will shut off after 10 minutes unless a time extension is done or the ignition is put in ON/RUN/START.

3. With the remote in the vehicle, press the brake pedal and select the ON/RUN/START ignition mode to drive.

### Extending Engine Run Time

The engine run time can also be extended by another 10-minutes, if during the first 10 minutes Steps 1–2 are repeated while the engine is still running. An extension can be requested, 30 seconds after starting. This provides a total of 20 minutes.

The remote start can only be extended once.

When the remote start is extended, the second 10-minute period is added on to the first 10 minutes for a total of 20 minutes.

A maximum of two remote starts, or a remote start with an extension, are allowed between ignition cycles.

The vehicle's ignition must be changed to ON/RUN/START and then back to OFF before the remote start procedure can be used again.

### Shutting the Engine Off After a Remote Start

To cancel a remote start, do any of the following:

- Press and hold  until the parking lamps turn off.
- Turn on the hazard warning flashers.
- Turn the vehicle on and then off.

### Conditions in Which Remote Start Will Not Work

The remote start will not operate if any of the following occur:

- The transmitter is in the vehicle.
- The hood is not closed.
- The hazard warning flashers are on.
- There is an emission control system malfunction.
- The engine coolant temperature is too high.
- The oil pressure is low.

- Two remote vehicle starts or a start with an extension have already been used.
- The vehicle is not in P (Park).

## Door Locks

### Warning

Unlocked doors can be dangerous.

- Passengers, especially children, can easily open the doors and fall out of a moving vehicle. The chance of being thrown out of the vehicle in a crash is increased if the doors are not locked. So, all passengers should wear safety belts properly and the doors should be locked whenever the vehicle is driven.

(Continued)

### Warning (Continued)

- Young children who get into unlocked vehicles may be unable to get out. A child can be overcome by extreme heat and can suffer permanent injuries or even death from heat stroke. Always lock the vehicle whenever leaving it.
- Outsiders can easily enter through an unlocked door when slowing or stopping the vehicle. Lock the doors to help prevent this from happening.

## Keyless Access

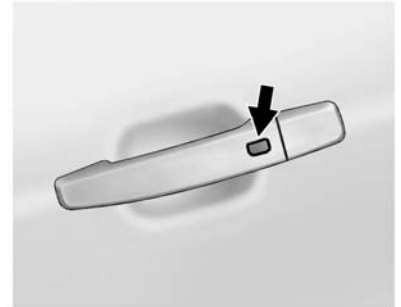

When the Remote Keyless Entry (RKE) transmitter is within 1 m (3 ft) of the driver door, pressing the lock/unlock button on that door handle will lock/unlock the doors. If the lock/unlock button is pressed again within five seconds, all passenger doors will unlock. See *Remote Keyless Entry (RKE) System Operation* on page 2-3.



## 2-12 Keys, Doors, and Windows

---

### Key

To lock or unlock the door, use the key in the driver door. Turn the key counterclockwise once to unlock the driver door; turning the key again will unlock the passenger doors.

### Inside the Vehicle

To unlock a door from the inside, pull once on the door handle to unlock it, and a second time to open it.

### Power Door Locks

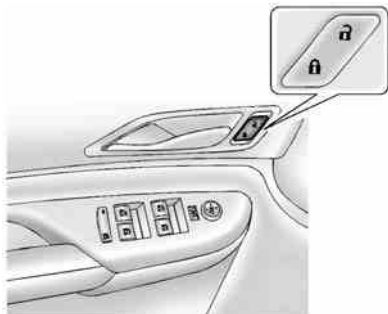

 **(Lock):** Press to lock the doors.



 **(Unlock):** Press to unlock the doors.

### Delayed Locking

This feature delays the locking of the doors until five seconds after all doors are closed.

When  is pressed on the power door lock switch while the door is open, a chime will sound three times indicating delayed locking is active.

The doors will lock automatically five seconds after all doors are closed. If a door is reopened before that time, the five-second timer will reset when all doors are closed again.

Press  on the door lock switch again or press  on the RKE transmitter to lock doors immediately.

This feature can also be programmed. See *Vehicle Personalization on page 5-39*.

### Automatic Door Locks



The doors will lock automatically when all doors are closed, the ignition is on, and the shift lever is moved out of P (Park). The doors will automatically unlock when the vehicle is stopped and the shift lever is moved into P (Park).

Use the manual or power door locks to unlock the doors if someone needs to exit, and to lock the doors again.

The power door locks can be programmed through the Driver Information Center (DIC). See *Vehicle Personalization on page 5-39*.

## Lockout Protection

Lockout protection decreases the chances that the keys may be accidentally locked in the vehicle.

When door locking is requested by pressing  on the front door panels or the RKE transmitter and the driver door is open, all doors will lock and the driver door will immediately unlock. The driver door must be closed when  is pressed for all doors to remain locked.

This feature can be programmed to provide the lockout protection feature only when the ignition mode is ACC/ACCESSORY, or ON/RUN/START. See “Power Door Locks” in *Vehicle Personalization on page 5-39*.

## Safety Locks

The rear door safety locks prevent passengers from opening the rear doors from inside the vehicle.

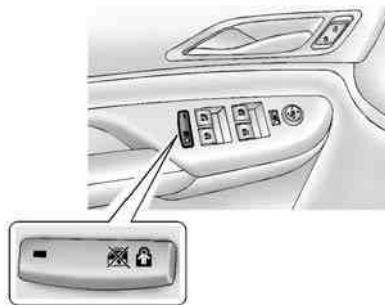

Press  to activate the safety locks. The indicator light comes on when activated.

The rear door power windows are also disabled. See *Power Windows on page 2-24*.

Press  again to deactivate the safety locks and power windows.

If a rear door handle is being pulled when the safety lock is deactivated, that door will remain locked and the indicator light may flash. Release the handle, then press the safety lock twice to deactivate the safety locks.

### Doors

### Liftgate

#### Warning

Exhaust gases can enter the vehicle if it is driven with the liftgate or trunk/hatch open, or with any objects that pass through the seal between the body and the trunk/hatch or liftgate. Engine exhaust contains carbon monoxide (CO) which cannot be seen or smelled. It can cause unconsciousness and even death.

If the vehicle must be driven with the liftgate or trunk/hatch open:

- Close all of the windows.
- Fully open the air outlets on or under the instrument panel.

(Continued)

#### Warning (Continued)

- Adjust the climate control system to a setting that brings in only outside air and set the fan speed to the highest setting. See “Climate Control Systems” in the Index.
- If the vehicle is equipped with a power liftgate, disable the power liftgate function.

See *Engine Exhaust* on page 9-21.

#### Caution

To avoid damage to the liftgate or liftgate glass, make sure the area above and behind the liftgate is clear before opening it.

### Manual Liftgate

For vehicles without Keyless Access, unlock the vehicle before opening the liftgate.

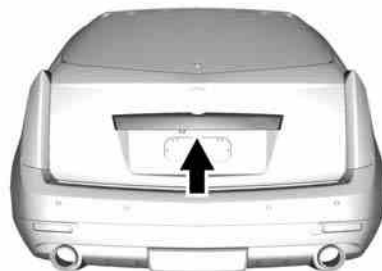

Press the touch pad in the handle of the liftgate, above the license plate, and lift up to open.

Do not press the touch pad while closing the liftgate. This will cause the liftgate to be unlatched.

Always close the liftgate before driving.

## Power Liftgate

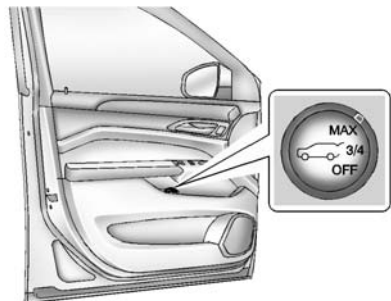

If equipped, the power liftgate switch is on the driver door. The vehicle must be in P (Park). The taillamps flash when the power liftgate moves.

### Warning

You, or others, could be injured if caught in the path of the power liftgate. Make sure there is no one in the way of the liftgate as it is opening and closing.

Choose the power liftgate mode and press the center of the switch.

The modes are:



**MAX:** Opens to maximum height.

**3/4:** Opens to a reduced height that can be set from 3/4 to fully open. Use to prevent the liftgate from opening into overhead objects such as a garage door or roof-mounted cargo. The liftgate can be opened all the way manually.

**OFF:** Opens manually only.

Manual operation of a liftgate that also has power operation requires more effort than with a standard manual liftgate.

To open or close the liftgate, select MAX or the 3/4 mode and then:

- Press  twice on the RKE transmitter.
- Press  on the center of the liftgate mode switch on the driver door, with the driver door unlocked.

- Press the touch pad on the liftgate outside handle after unlocking all doors.

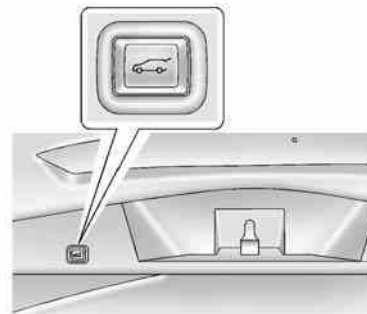

Press and release  on the liftgate next to the latch to close the liftgate.

Pressing any liftgate button, or the touch pad while the liftgate is moving, stops it. Pressing again reverses the direction. There is a minimum distance that the power liftgate must already be open for the

## 2-16 Keys, Doors, and Windows

---

system to hold it open. If movement is stopped below that minimum, the liftgate closes.

Do not force the liftgate open or closed during a power cycle.

The power liftgate may be temporarily disabled under extreme temperatures or low battery conditions. If this occurs, the liftgate can still be operated manually.

If you shift the transmission out of P (Park) while the power function is in progress, the liftgate power function will continue to completion. If you shift the transmission out of P (Park) and accelerate before the power liftgate latch is closed, the liftgate may reverse to the open position. Cargo could fall out of the vehicle. Always make sure the power liftgate is closed and latched before you drive away.

If you power open the liftgate and the liftgate support struts have lost pressure, the turn signals flash and a chime sounds. The liftgate stays

open temporarily, then slowly closes. See your dealer for service before using the liftgate.

### Obstacle Detection Features

If the liftgate encounters an obstacle during a power open or close cycle, a warning chime will sound and the liftgate will automatically reverse direction to the full closed or open position. After removing the obstruction, the power liftgate operation can be used again. If the liftgate encounters multiple obstacles on the same power cycle, the power function will deactivate. After removing the obstructions, the liftgate will resume normal power operation.

The vehicle has pinch sensors on the side edges of the liftgate. If an object is caught between the liftgate and the body and presses against one of these sensors, the liftgate will reverse direction and open fully. The liftgate will remain open until it is activated again or closed manually.

### Setting the 3/4 Mode

To change the liftgate stop position:

1. Select MAX or 3/4 mode and open the liftgate.
2. Stop the liftgate movement at the desired height by pressing any liftgate switch. Manually adjust the liftgate position if needed.
3. Press and hold  on the liftgate next to the latch until the turn signals flash and a beep sounds. This indicates the setting has been recorded.

The liftgate cannot be set below a minimum programmable height. If there is no light flash or sound, then the height adjustment may be too low.

### Manual Operation of Power Liftgate

To change the liftgate to manual operation, turn the mode switch to the OFF position.

With the power liftgate disabled and all of the doors unlocked, the liftgate can be manually opened and closed. The effort required to operate a power liftgate is greater than the effort required to operate a non-power liftgate.

To open the liftgate, press the touch pad on the handle on the outside of the liftgate, and lift the gate open. To close the liftgate, use the pull cup to lower the liftgate and close. With the power liftgate disabled, the liftgate electric latch will still power latch once contact is made with the striker. Always close the liftgate before driving.

If the RKE button is pressed while power operation is disabled, the turn signals flash and the liftgate will not move.

The liftgate has an electric latch. If the battery is disconnected or has low voltage, the liftgate will not open. The liftgate will resume operation when the battery is reconnected and charged.

## Vehicle Security

This vehicle has theft-deterrent features; however, they do not make the vehicle impossible to steal.

## Vehicle Alarm System

This vehicle has an anti-theft alarm system.

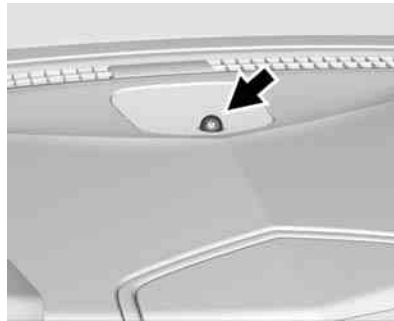

The indicator light, on the instrument panel near the windshield, indicates the status of the system.



**Off:** Alarm system is disarmed.

**On Solid:** Vehicle is secured during the delay to arm the system.

**Fast Flash:** Vehicle is unsecured. A door, the hood, or the liftgate is open.

**Slow Flash:** Alarm system is armed.

## Arming the Alarm System

1. Close the liftgate and the hood. Turn off the vehicle.
2. Lock the vehicle in one of three ways:
  - Use the RKE transmitter.
  - Use the Keyless Access system.
  - With a door open, press the inside .
3. After 30 seconds the alarm system will arm, and the indicator light will begin to slowly flash indicating the alarm system is operating. Pressing  on the RKE transmitter a second time

## 2-18 Keys, Doors, and Windows

---

will bypass the 30-second delay and immediately arm the alarm system.

The vehicle alarm system will not arm if the doors are locked with the key.

If the driver door is opened without first unlocking with the RKE transmitter, the horn will chirp and the lights will flash to indicate pre-alarm. If the vehicle is not started, or the door is not unlocked by pressing  on the RKE transmitter during the 10-second pre-alarm, the alarm will be activated.

The alarm will also be activated if a passenger door, the liftgate, or the hood is opened without first disarming the system. When the alarm is activated, the turn signals flash and the horn sounds for about 30 seconds. The alarm system will then re-arm to monitor for the next unauthorized event.

### Disarming the Alarm System

To disarm the alarm system or turn off the alarm if it has been activated:

- Press  on the RKE transmitter.
- Unlock the vehicle using the Keyless Access system.
- Start the vehicle.

To avoid setting off the alarm by accident:

- Lock the vehicle after all occupants have left the vehicle and all doors are closed.
- Always unlock a door with the RKE transmitter or use the Keyless Access system.

Unlocking the driver door with the key will not disarm the system or turn off the alarm.

### How to Detect a Tamper Condition

If  is pressed and the horn chirps and the lights flash three times, the alarm was activated while the alarm system was armed.

If the alarm system has been activated, a message will appear on the DIC. See *Security Messages on page 5-37*.

### Power Sounder, Inclination Sensor, and Intrusion Sensor

In addition to the standard theft-deterrent system features, this system also has an inclination sensor and intrusion sensor.

The power sounder provides an audible alarm which is different from the vehicle's horn. It has its own power source, and can sound an alarm when the vehicle's battery is compromised.

The inclination sensor can set off the alarm if it senses movement of the vehicle, such as a change in vehicle orientation.

The intrusion sensor monitors the vehicle interior, and can set off the alarm if it senses an unauthorized entry into the vehicle's interior. Do not allow passengers or pets to remain in the vehicle when the intrusion sensor is activated.

Before arming the theft-deterrent system and activating the intrusion sensor:

- Make sure all doors and windows are completely closed.
- Secure any loose items such as sunshades.
- Make sure there are no obstructions blocking the sensors in the front overhead console.

### Inclination, and Intrusion Sensors Disable Switch

It is recommended that the inclination and intrusion sensors be deactivated if pets are left in the vehicle or the vehicle is being transported.

With the vehicle turned off, press  in the overhead console. The indicator light will come on momentarily, indicating that the sensor has been disabled until the next time the alarm system is armed.

### Immobilizer

See *Radio Frequency Statement on page 13-12*.

### Immobilizer Operation

This vehicle has a passive theft-deterrent system.

The system does not have to be manually armed or disarmed.

The vehicle is automatically immobilized when the vehicle is turned off.

The immobilization system is disarmed when the pushbutton start is activated to enter the ACC/ACCESSORY mode or the ON/RUN/START mode and a valid transmitter is present in the vehicle.



The security light, in the instrument cluster, comes on if there is a problem with arming or disarming the theft-deterrent system.

The system has one or more RKE transmitters matched to an immobilizer control unit in your vehicle. Only a correctly matched RKE transmitter will start the



## 2-20 Keys, Doors, and Windows

vehicle. If the transmitter is ever damaged, you may not be able to start your vehicle.

When trying to start the vehicle, the security light comes on briefly when the ignition is turned on.

If the engine does not start and the security light stays on, there is a problem with the system. Turn the ignition off and try again.

If the vehicle will not change ignition modes (ACC/ACCESSORY, ON/RUN/START, OFF), and the RKE transmitter appears to be undamaged, try another transmitter. Or, you may try placing the transmitter in the transmitter pocket located in the center console. See "NO REMOTE DETECTED" under *Key and Lock Messages on page 5-32*.

If the ignition mode will not change with the other transmitter, your vehicle needs service. If the ignition does change modes, the first transmitter may be faulty. See your dealer who can service the

theft-deterrent system and have a new RKE transmitter programmed to the vehicle.

It is possible for the immobilizer system to learn new or replacement RKE transmitters. Up to eight transmitters can be programmed for the vehicle. To program additional transmitters, see "Programming Transmitters to the Vehicle" under *Remote Keyless Entry (RKE) System Operation on page 2-3*.

Do not leave the key or device that disarms or deactivates the theft-deterrent system in the vehicle.

## Exterior Mirrors

### Convex Mirrors



A convex mirror can make things, like other vehicles, look farther away than they really are. If you cut too sharply into the right lane, you could hit a vehicle on the right. Check the inside mirror or glance over your shoulder before changing lanes.

The passenger side mirror is convex shaped. A convex mirror's surface is curved so more can be seen from the driver seat.

## Power Mirrors

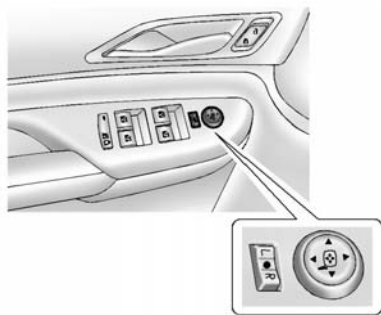

### Manual Folding Mirrors Shown, Power Folding Similar

To adjust the mirror:

1. Move the selector switch to L (Left) or R (Right) to choose the driver or passenger mirror.
2. Press the arrows on the control pad to move each mirror in the desired direction.
3. Return the selector switch to the center position.

## Side Blind Zone Alert (SBZA)

The vehicle may have side blind zone alert. See *Side Blind Zone Alert (SBZA)* on page 9-52.

## Memory Mirrors

If equipped, the vehicle may have memory mirrors. See *Memory Seats* on page 3-6.

## Folding Mirrors

### Manual Folding Mirrors

If equipped, manually fold the mirrors inward toward the vehicle to prevent damage when going through an automatic car wash. Push the mirror outward to return it to the original position.

## Power Folding Mirrors

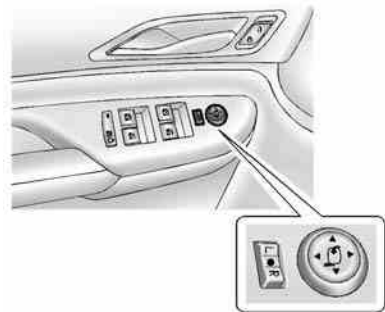

To fold the mirrors, if equipped:

1. With the selector switch in the ● position, press the down arrow on the control pad. Both mirrors will automatically fold.
2. Press the down arrow again to return the mirrors to their original position.

### Resetting the Power Folding Mirrors

Reset the power folding mirrors if:

- The mirrors are accidentally obstructed while folding.
- They are accidentally manually folded/unfolded.
- The mirrors do not stay in the unfolded position.
- The mirrors vibrate at normal driving speeds.

Fold and unfold the mirrors one time using the mirror controls to reset them to their normal position. A noise may be heard during the resetting of the power folding mirrors. This sound is normal after a manual folding operation.

### Heated Mirrors

 (Rear Window Defogger): Press to heat the mirrors.

See “Rear Window Defogger” under *Dual Automatic Climate Control System on page 8-1*.

### Automatic Dimming Mirror

If the vehicle has the automatic dimming mirror, the driver outside mirror automatically adjusts for the glare of headlamps behind you.

### Reverse Tilt Mirrors

If equipped with memory seats, the passenger and/or driver mirror tilts to a preselected position when the vehicle is in R (Reverse). This allows the curb to be seen when parallel parking.

The mirror(s) return to the original position when:

- The vehicle is shifted out of R (Reverse), or remains in R (Reverse) for about 30 seconds.
- The ignition is turned off.
- The vehicle is driven in R (Reverse) above a set speed.

To turn this feature on or off, see *Vehicle Personalization on page 5-39*.

## Interior Mirrors

### Interior Rearview Mirrors

Adjust the rearview mirror for a clear view of the area behind your vehicle.

If equipped with OnStar, there are three buttons at the bottom of the mirror. See your dealer for more information on the system and how to subscribe to OnStar. See *OnStar Overview on page 14-1*.

To avoid accidental OnStar calls, clean the mirror with the ignition off. Do not spray glass cleaner directly on the mirror. Use a soft towel dampened with water.

### Manual Rearview Mirror

Push the tab forward for daytime use and pull it rearward for nighttime use to avoid glare of the headlamps from behind.

### Automatic Dimming Rearview Mirror

If equipped, automatic dimming reduces the glare of headlamps from behind. The dimming feature comes on when the vehicle is started.

## Windows

### Warning

Never leave a child, a helpless adult, or a pet alone in a vehicle, especially with the windows closed in warm or hot weather. They can be overcome by the extreme heat and suffer permanent injuries or even death from heat stroke.



## 2-24 Keys, Doors, and Windows

The vehicle aerodynamics are designed to improve fuel economy performance. This may result in a pulsing sound when either rear window is down and the front windows are up. To reduce the sound, open either a front window or the sunroof, if equipped.

### Power Windows

#### Warning

Children could be seriously injured or killed if caught in the path of a closing window. Never leave the Remote Keyless Entry (RKE) transmitter in a vehicle with children. When there are children in the rear seat, use the window lockout switch to prevent operation of the windows. See *Keys on page 2-1*.

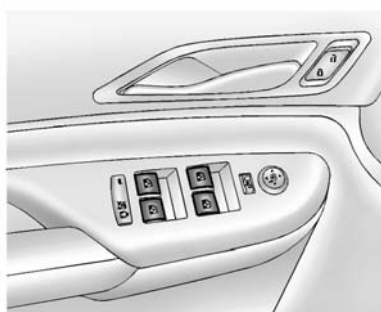

The power windows:

- Can be operated with the ignition in ACC/ACCESSORY or ON/RUN/START.
- Can be operated within 10 minutes of switching the ignition off. See *Retained Accessory Power (RAP) on page 9-19*.
- Will stop operation when any door is opened.

Press or pull the switch part of the way to open or close the window.

### Express-Down/Up Windows

Windows that have the express-down/up feature allow the windows to be lowered and raised fully without holding the window switch. Press the window switch fully and release it to activate the express-down feature. Pull the window switch fully up and release it to activate the express-up feature. The express mode can be canceled at any time by briefly pressing or pulling the switch.

### Programming the Power Windows

Programming the power windows may be necessary if the vehicle's battery has been disconnected or discharged.

If the window will not express up after power has been restored and a message is displayed in the Driver Information Center:

1. Close all doors.

- Place the ignition in ACC/ACCESSORY or ON/RUN/START.
- From any partial open position, close the window and continue to pull the switch briefly after the window has fully closed.

### Obstacle Detection Feature

The Obstacle Detection Feature is part of the express-up feature and is active:

- In the middle and upper portions of the window opening.
- During window up movements.
- In ignition OFF during all window up movements and during express-up window movements in ignition ON/RUN/START.

If there is something blocking the window during automatic closing, the window will reverse direction for a short distance. Weather conditions such as extreme cold and/or ice may cause the window to

auto-reverse. The window will return to normal operation once the object or condition is removed.

If conditions prevent the window from closing and the window continues to auto-reverse, it is possible to close the window with the ignition in ON/RUN/START by holding the window switch in the partially or fully pulled up position. Release of the switch from the partially pulled up position will cause the window to stop. Release of the switch from the fully pulled up position will activate the express-up and related obstacle detection features.

### Overload

If the windows are repeatedly operated within a short time, the window operation is disabled for a short time.



### Remote Window Operation

If equipped, the remote operating windows will open all the windows from outside the vehicle by pressing and holding  on the Remote Keyless Entry (RKE) transmitter.

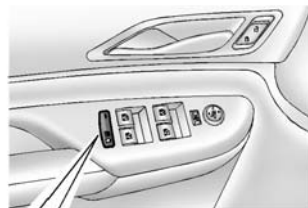
### Window Lockout





This feature prevents the rear passenger windows from operating except from the driver position.

Press   to activate the rear window lockout. The indicator light in the switch illuminates.

## 2-26 Keys, Doors, and Windows

The rear door safety locks are also enabled. See *Safety Locks on page 2-13*.

Press   again to deactivate the rear window lockout.

If an inside rear door handle is being pulled at the same time a safety lock is deactivated, only that door will remain locked and the indicator light may flash. Release the handle, then press the safety lock twice to deactivate the safety locks.

### Sun Visors

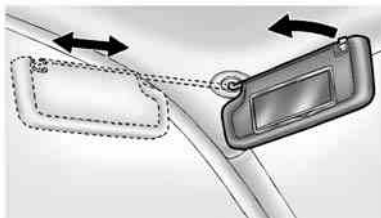

Pull the sun visor down to block glare. Detach the sun visor from the center mount to pivot to the side window or, if equipped, extend along the rod.

### Roof

#### Sunroof

On vehicles with a sunroof, the switches are on the overhead console.

The sunroof only operates when the ignition is in ON/RUN/START or ACC/ACCESSORY, or in Retained Accessory Power (RAP). See *Ignition Positions on page 9-15* and *Retained Accessory Power (RAP) on page 9-19*.

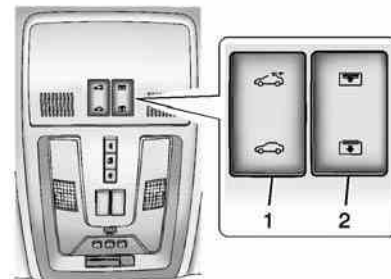

1. Sunroof Switch
2. Sunshade Switch

### Sunroof Switch

**Vent:** To vent the sunroof, press the rear of the sunroof switch (1) to the first detent and release. The sunroof will open to the vent position.

**Open/Close:** To open or close the sunroof, press the front or rear of the sunroof switch (1) to the first detent and hold to open or close the sunroof to a desired position.

**Comfort Stop:** The sunroof has a comfort stop feature that stops the sunroof from opening to the full-open position. Press the rear of the sunroof switch (1) to the second detent and release to open the sunroof to the comfort open position. Press and release the rear of the sunroof switch (1) again to fully open the sunroof. Press the front of the sunroof switch (1) to the second detent and release to express close the sunroof.

### Sunshade Switch

**Open/Close:** To open or close the sunshade, press the front or back of the sunshade switch (2) to the first detent and hold to open or close the sunshade to a desired position.

**Express Open/Express Close:** To express open or close the sunshade, press the sunshade switch (2) to the second detent and release.

Fully close the sunroof before fully closing the sunshade.

### Anti-Pinch Feature

If an object is in the path of the sunroof when it is closing, the anti-pinch feature detects the object and stops the sunroof from closing at the point of the obstruction. The sunroof then returns to the full-open position.



Dirt and debris may collect on the sunroof seal or in the track. This could cause an issue with sunroof operation or noise. It could also plug the water drainage system. Periodically open the sunroof and remove any obstacles or loose debris. Wipe the sunroof seal and roof sealing area using a clean cloth, mild soap, and water. Do not remove grease from the sunroof.





## Seats and Restraints

### Head Restraints

Head Restraints ..... 3-2

### Front Seats

Seat Adjustment ..... 3-3

Power Seat Adjustment ..... 3-4

Lumbar Adjustment ..... 3-4

Thigh Support Adjustment .... 3-5

Reclining Seatbacks ..... 3-5

Memory Seats ..... 3-6

Heated and Ventilated Front

Seats ..... 3-8

### Rear Seats

Rear Seats ..... 3-10

Heated Rear Seats ..... 3-11

Rear Seat

Pass-Through Door ..... 3-12

### Safety Belts

Safety Belts ..... 3-12

How to Wear Safety Belts

Properly ..... 3-13

Lap-Shoulder Belt ..... 3-14

Safety Belt Use During

Pregnancy ..... 3-18

Safety Belt Extender ..... 3-19

Safety System Check ..... 3-19

Safety Belt Care ..... 3-19

Replacing Safety Belt System

Parts after a Crash ..... 3-19

### Airbag System

Airbag System ..... 3-20

Where Are the Airbags? .... 3-22

When Should an Airbag

Inflate? ..... 3-23

What Makes an Airbag

Inflate? ..... 3-24

How Does an Airbag

Restrain? ..... 3-24

What Will You See after an

Airbag Inflates? ..... 3-25

Passenger Sensing

System ..... 3-26

Servicing the Airbag-Equipped

Vehicle ..... 3-31

Adding Equipment to the

Airbag-Equipped Vehicle ... 3-31

Airbag System Check ..... 3-32

Replacing Airbag System

Parts after a Crash ..... 3-32

### Child Restraints

Older Children ..... 3-33

Infants and Young

Children ..... 3-35

Child Restraint Systems .... 3-37

Where to Put the Restraint ... 3-39

Lower Anchors and Tethers

for Children (LATCH

System) ..... 3-40

Replacing LATCH System

Parts After a Crash ..... 3-48

Securing Child Restraints

(Rear Seat) ..... 3-48

Securing Child Restraints

(Front Passenger Seat) .... 3-51

## 3-2 Seats and Restraints

### Head Restraints

#### Warning

With head restraints that are not installed and adjusted properly, there is a greater chance that occupants will suffer a neck/spinal injury in a crash. Do not drive until the head restraints for all occupants are installed and adjusted properly.



Adjust the head restraint so that the top of the restraint is at the same height as the top of the occupant's head. This position reduces the chance of a neck injury in a crash.

#### Front Seats

The vehicle's front seats have adjustable head restraints in the outboard seating positions.

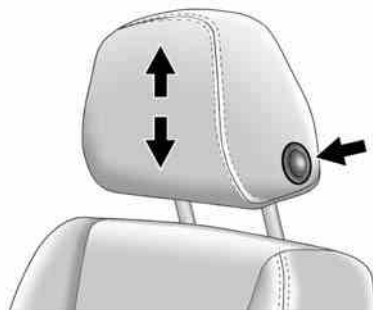

The height of the head restraint can be adjusted. To raise or lower the head restraint, press the button located on the side of the head restraint, and pull up or push the

head restraint down, and release the button. Pull and push on the head restraint after the button is released to make sure that it is locked in place.

The front seat outboard head restraints are not removable.

#### Rear Seats

The vehicle's rear seats have adjustable head restraints in the outboard seating positions.

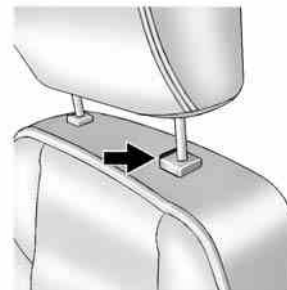

The height of the head restraint can be adjusted. Pull the head restraint up to raise it. Try to move the head restraint to make sure that it is locked in place.

To lower the head restraint, press the button, located on the top of the seatback, and push the head restraint down. Try to move the head restraint after the button is released to make sure that it is locked in place.



The vehicle's rear seat has an adjustable headrest in the center seating position that can be adjusted the same way as the outboard head restraints.

If you are installing a child restraint in the rear seat, see "Securing a Child Restraint Designed for the LATCH System" under *Lower Anchors and Tethers for Children (LATCH System)* on page 3-40.

## Front Seats

### Seat Adjustment

#### Warning

You can lose control of the vehicle if you try to adjust a driver seat while the vehicle is moving. Adjust the driver seat only when the vehicle is not moving.



## 3-4 Seats and Restraints

To adjust a manual seat:

1. Pull the handle at the front of the seat cushion.
2. Move the seat forward or rearward to adjust the seat position.
3. Release the handle to stop the seat from moving.
4. Try to move the seat back and forth to be sure it is locked in place.

### Power Seat Adjustment

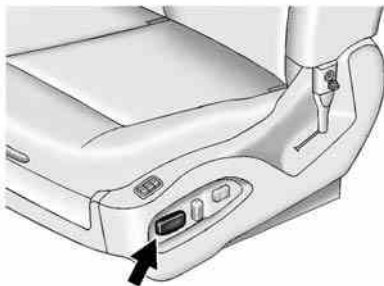

To adjust a power seat, if equipped:

- Move the seat forward or rearward by sliding the control forward or rearward.
- Raise or lower the front part of the seat cushion by moving the front of the control up or down.
- Raise or lower the entire seat by moving the rear of the control up or down.

To adjust the seatback, see *Reclining Seatbacks* on page 3-5.

To adjust the lumbar support, see *Lumbar Adjustment* on page 3-4.

Some vehicles are equipped with a feature that activates a vibration in the driver seat to help the driver avoid crashes. See *Driver Assistance Systems* on page 9-43.

## Lumbar Adjustment

### Power Lumbar



If available, press and hold the front or rear of the control to increase or decrease lumbar support. Release the control when the seatback reaches the desired level of lumbar support.

## Thigh Support Adjustment

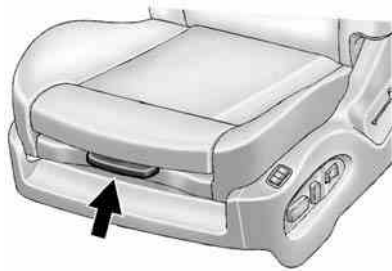

If available, adjust the manual leg extension by pulling up on the lever, and then pulling or pushing on the support to lengthen or shorten it. Release the lever to lock it in place.

## Reclining Seatbacks

### ⚠ Warning

Sitting in a reclined position when the vehicle is in motion can be dangerous. Even when buckled up, the safety belts cannot do their job.

The shoulder belt will not be against your body. Instead, it will be in front of you. In a crash, you could go into it, receiving neck or other injuries.

The lap belt could go up over your abdomen. The belt forces would be there, not at your pelvic bones. This could cause serious internal injuries.

For proper protection when the vehicle is in motion, have the seatback upright. Then sit well back in the seat and wear the safety belt properly.



Do not have a seatback reclined if the vehicle is moving.

## Manual Reclining Seatbacks

### ⚠ Warning

If either seatback is not locked, it could move forward in a sudden stop or crash. That could cause injury to the person sitting there. Always push and pull on the seatbacks to be sure they are locked.

## 3-6 Seats and Restraints

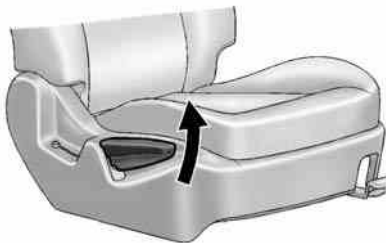

To recline a manual seatback:

1. Lift the lever.
2. Move the seatback to the desired position, and then release the lever to lock the seatback in place.
3. Push and pull on the seatback to make sure it is locked.

To return the seatback to the upright position:

1. Lift the lever fully without applying pressure to the seatback, and the seatback will return to the upright position.

2. Push and pull on the seatback to make sure it is locked.

### Power Reclining Seatbacks



To adjust a power seatback, if available:

- Tilt the top of the control rearward to recline.
- Tilt the top of the control forward to raise.

### Memory Seats

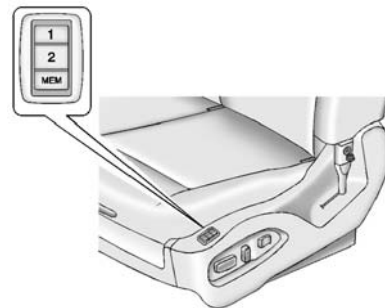

If equipped, the “1,” “2,” and MEM buttons on the outboard side of the driver seat are used to manually save and recall the positions of the driver seat, outside mirrors, and adjustable throttle and brake pedal positions (if equipped).

### Storing Memory Positions

To save positions to the "1" and "2" buttons:

1. Adjust the driver seat, seatback recliner, both outside mirrors, and adjustable pedals (if equipped) to the desired driving positions.
2. Press and hold MEM (Memory). A beep will sound.
3. Press "1" until two beeps sound.
4. Repeat Steps 1 and 2 for a second driver using "2."

### Manually Recalling Memory Positions

If the vehicle is OFF or not in P (Park), press and hold "1" or "2" to manually recall the previously stored memory positions. Releasing "1" or "2" before the stored positions are reached stops the recall.

If the vehicle is ON and in P (Park), press and release "1" or "2" to manually recall the previously stored memory positions. Placing

the ignition in OFF before the stored positions are reached stops the recall.

### Automatically Recalling Memory Positions (Auto Memory Recall)

The Auto (Automatic) Memory Recall feature automatically recalls the current driver's previously stored "1" or "2" position when entering the vehicle.

Depending upon the Auto Memory Recall feature enabled in the vehicle personalization menu, memory "1" or "2" positions are recalled in the following ways:

To activate the recall when On - Driver Door Open is selected in the vehicle personalization menu:

- On vehicles with RKE, press  on the RKE transmitter and open the door.
- On vehicles with Keyless Access, press the lock/unlock button on the outside driver door

handle and open the driver door. The RKE transmitter must be present for the recall to activate.

- If the driver door is already open, press  on the RKE transmitter to activate the recall.

To activate the recall when On - At Ignition On is selected in the vehicle personalization menu:

- Place the ignition in ON/RUN/ START.

See *Vehicle Personalization on page 5-39*.

To stop recall movement, press one of the memory, power mirror, or power seat controls; or press the adjustable pedal switch (if equipped). If On - At Ignition On is selected in the vehicle personalization menu, placing the ignition in OFF also stops the recall.



## 3-8 Seats and Restraints

### Easy Exit Recall

If programmed on in the vehicle personalization menu, this feature moves the seat approximately 7 cm (3 in) rearward automatically allowing the driver more room to exit the vehicle.

Easy Exit recall activates when one of the following occurs:

- The vehicle is turned off and the driver door is opened within a short time.
- The vehicle is turned off with the driver door open.

See *Vehicle Personalization on page 5-39*.

To stop recall movement, press one of the memory, power mirror, power seat controls, or the adjustable pedal switch (if equipped).

### Obstructions

If something has blocked the driver seat and adjustable pedals (if equipped) while recalling a memory position, the recall may stop. Remove the obstruction. Then do one of the following:

- If manually recalling the position, press and hold the appropriate manual control for the memory item that is not recalling for two seconds. Try recalling again by pressing the appropriate memory button.
- If automatically recalling the position, press and hold the appropriate manual control for the memory item that is not recalling for two seconds. Try recalling again by opening the driver door and pressing  on the RKE transmitter.
- If recalling the exit position, press and hold the power seat control rearward for two seconds. Then try recalling the exit position again.

If the memory position is still not recalling, see your dealer for service.

## Heated and Ventilated Front Seats



### Warning

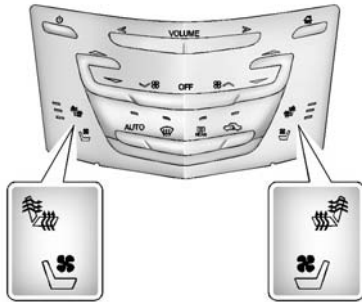

If you cannot feel temperature change or pain to the skin, the seat heater may cause burns. To reduce the risk of burns, people with such a condition should use care when using the seat heater, especially for long periods of time. Do not place anything on the seat that insulates against heat, such as a blanket, cushion, cover, or similar item. This may cause the seat heater to overheat. An overheated seat heater may cause a burn or may damage the seat.



### Heated and Ventilated Seat Buttons Shown, Heated Seat Buttons Similar

If available, the buttons are near the climate controls on the center stack. To operate, the ignition must be in ON/RUN/START.

Press  or  to heat the driver or passenger seat.

Press  or , if available, to ventilate the driver or passenger seat. A ventilated seat has a fan that pulls or pushes air through the seat. The air is not cooled.

When this feature is off, the symbols on the buttons are white. When a heated seat is turned on, the symbol turns red. When a ventilated seat (if available) is turned on, the symbol turns blue.

Press the button once for the highest setting. With each press of the button, the seat will change to the next lower setting, and then to the off setting. The indicator lights next to the buttons indicate three for the highest setting and one for the lowest. If the front heated seats are on high, the level may automatically be lowered after approximately 30 minutes.

The passenger seat may take longer to heat up.

### Remote Start Heated and Ventilated Seats

During a remote start, the heated or ventilated seats can be turned on automatically. When it is cold outside, the heated seats turn on, and when it is hot outside the ventilated seats turn on. This feature is canceled when the ignition is turned on. Press the button to use the heated or ventilated seats after the vehicle is started.

The heated or ventilated seat indicator lights on the button do not turn on during a remote start.

The temperature performance of an unoccupied seat may be reduced. This is normal.

The heated or ventilated seats will not turn on during a remote start unless they are enabled in the vehicle personalization menu. See *Remote Vehicle Start on page 2-9* and *Vehicle Personalization on page 5-39*.

### Rear Seats

#### Split Folding Seatbacks

With this feature, either side of the rear seatback can be folded down for more cargo space.

#### Folding the Seatbacks

##### **Caution**

Folding a rear seat with the safety belts still fastened may cause damage to the seat or the safety belts. Always unbuckle the safety belts and return them to their normal stowed position before folding a rear seat.

To fold the seatback:

1. Unbuckle the rear safety belts and move the front seatbacks to the upright position. See *Reclining Seatbacks* on page 3-5.

2. Make sure that there is nothing under, in front of, or on the seat.

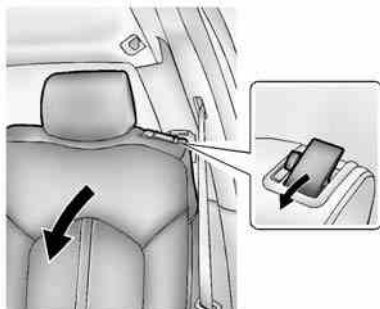

3. Lift the lever on the top of the seatback. A tab near the seatback lever raises when the seatback is unlocked.
4. Fold the seatback forward. A tab near the seatback lever retracts when the seatback is locked in place.

Keep the seatback in the upright, locked position when not in use.

#### Raising the Seatbacks

##### **Warning**

If either seatback is not locked, it could move forward in a sudden stop or crash. That could cause injury to the person sitting there. Always push and pull on the seatbacks to be sure they are locked.

##### **Warning**

A safety belt that is improperly routed, not properly attached, or twisted will not provide the protection needed in a crash. The person wearing the belt could be seriously injured. After raising the rear seatback, always check to be sure that the safety belts are properly routed and attached, and are not twisted.

To raise the seatback:

1. Lift the lever on top of the seatback. Raise the seatback and release the lever. A tab near the seatback lever raises when the seatback is unlocked.
2. Push the seatback rearward until it locks in the upright position. A tab near the seatback lever retracts when the seatback is locked in place.
3. Make sure the rear safety belts are not twisted or caught between the seat cushion and the seatback.

### Reclining the Seatbacks

To recline the seatback:

1. Lift and hold the lever on top of the seatback. A tab near the seatback lever raises when the seatback is unlocked.

2. Tilt the seatback rearward, and then release the lever when the seatback is in the desired position. A tab near the seatback lever retracts when the seatback is locked in place.



### Heated Rear Seats

#### Warning

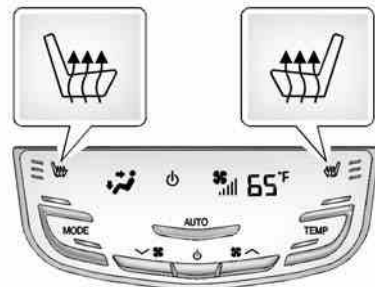
If you cannot feel temperature change or pain to the skin, the seat heater may cause burns. See the Warning under *Heated and Ventilated Front Seats* on page 3-8.



If available, the buttons are on the rear climate control panel on the rear of the center console.

With the ignition in ON/RUN/START, press  or  to heat the left or right outboard seat cushion and seatback. An indicator on the climate control display appears when this feature is on.

Press the button once for the highest setting. With each press of the button, the heated seat changes to the next lower setting, and then

## 3-12 Seats and Restraints

the off setting. Three lights indicate the highest setting, and one light indicates the lowest.

### Rear Seat Pass-Through Door

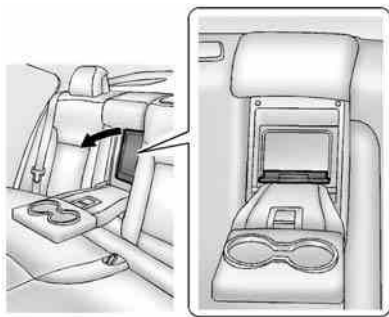

There is a rear seat pass-through door in the center of the rear seatback. Fold down the center armrest and push down on the latch to open the door.

## Safety Belts

This section of the manual describes how to use safety belts properly. It also describes some things not to do with safety belts.

### Warning

Do not let anyone ride where a safety belt cannot be worn properly. In a crash, if you or your passenger(s) are not wearing safety belts, injuries can be much worse than if you are wearing safety belts. You can be seriously injured or killed by hitting things inside the vehicle harder or by being ejected from the vehicle. In addition, anyone who is not buckled up can strike other passengers in the vehicle.

It is extremely dangerous to ride in a cargo area, inside or outside of a vehicle. In a collision, passengers riding in these areas

(Continued)

### Warning (Continued)

are more likely to be seriously injured or killed. Do not allow passengers to ride in any area of the vehicle that is not equipped with seats and safety belts.

Always wear a safety belt, and check that all passenger(s) are restrained properly too.

This vehicle has indicators as a reminder to buckle the safety belts. See *Safety Belt Reminders on page 5-12*.

## Why Safety Belts Work



When riding in a vehicle, you travel as fast as the vehicle does. If the vehicle stops suddenly, you keep going until something stops you. It could be the windshield, the instrument panel, or the safety belts!

When you wear a safety belt, you and the vehicle slow down together. There is more time to stop because you stop over a longer distance and, when worn properly, your strongest bones take the forces from the

safety belts. That is why wearing safety belts makes such good sense.

## Questions and Answers About Safety Belts

**Q: Will I be trapped in the vehicle after a crash if I am wearing a safety belt?**

**A:** You *could* be — whether you are wearing a safety belt or not. Your chance of being conscious during and after a crash, so you *can* unbuckle and get out, is *much* greater if you are belted.

**Q: If my vehicle has airbags, why should I have to wear safety belts?**

**A:** Airbags are supplemental systems only; so they work *with* safety belts — not instead of them. Whether or not an airbag is provided, all occupants still have to buckle up to get the most protection.

Also, in nearly all states and in all Canadian provinces, the law requires wearing safety belts.

## How to Wear Safety Belts Properly

This section is only for people of adult size.

There are special things to know about safety belts and children. And there are different rules for smaller children and infants. If a child will be riding in the vehicle, see *Older Children on page 3-33* or *Infants and Young Children on page 3-35*. Follow those rules for everyone's protection.

It is very important for all occupants to buckle up. Statistics show that unbelted people are hurt more often in crashes than those who are wearing safety belts.

There are important things to know about wearing a safety belt properly.

## 3-14 Seats and Restraints

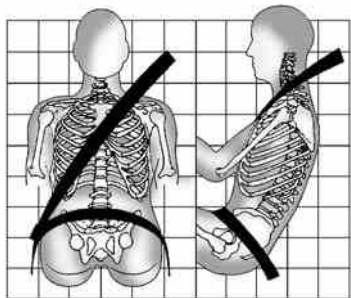

- Sit up straight and always keep your feet on the floor in front of you.
- Always use the correct buckle for your seating position.
- Wear the lap part of the belt low and snug on the hips, just touching the thighs. In a crash, this applies force to the strong pelvic bones and you would be less likely to slide under the lap belt. If you slid under it, the belt would apply force on your abdomen. This could cause serious or even fatal injuries.

- Wear the shoulder belt over the shoulder and across the chest. These parts of the body are best able to take belt restraining forces. The shoulder belt locks if there is a sudden stop or crash.

### Warning

You can be seriously injured, or even killed, by not wearing your safety belt properly.

- Never allow the lap or shoulder belt to become loose or twisted.
- Never wear the shoulder belt under both arms or behind your back.
- Never route the lap or shoulder belt over an armrest.

## Lap-Shoulder Belt

All seating positions in the vehicle have a lap-shoulder belt.

The following instructions explain how to wear a lap-shoulder belt properly.

1. Adjust the seat, if the seat is adjustable, so you can sit up straight. To see how, see “Seats” in the Index.
2. Pick up the latch plate and pull the belt across you. Do not let it get twisted.

The lap-shoulder belt may lock if you pull the belt across you very quickly. If this happens, let the belt go back slightly to unlock it. Then pull the belt across you more slowly.

If the shoulder portion of a passenger belt is pulled out all the way, the child restraint locking feature may be engaged. If this happens, let the belt go back all the way and start again.



If the webbing locks in the latch plate before it reaches the buckle, tilt the latch plate flat to unlock.



3. Push the latch plate into the buckle until it clicks.  
Pull up on the latch plate to make sure it is secure. If the belt is not long enough, see *Safety Belt Extender* on page 3-19.

Position the release button on the buckle so that the safety belt could be quickly unbuckled if necessary.

4. If equipped with a shoulder belt height adjuster, move it to the height that is right for you. See "Shoulder Belt Height Adjuster" later in this section for instructions on use and important safety information.



5. To make the lap part tight, pull up on the shoulder belt.



## 3-16 Seats and Restraints

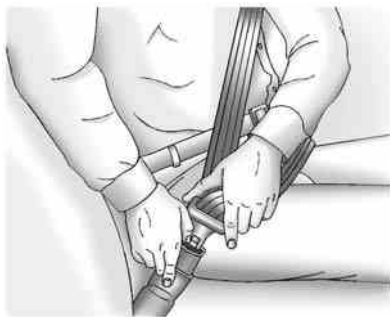

To unlatch the belt, just push the button on the buckle.

Before a door is closed, be sure the safety belt is out of the way. If a door is slammed against a safety belt, damage can occur to both the safety belt and the vehicle.

### Shoulder Belt Height Adjuster

The vehicle has a shoulder belt height adjuster for the driver and front outboard passenger seating positions.

Adjust the height so that the shoulder portion of the belt is on the shoulder and not falling off of it. The belt should be close to, but not contacting, the neck. Improper shoulder belt height adjustment could reduce the effectiveness of the safety belt in a crash. See *How to Wear Safety Belts Properly* on page 3-13.



Move the height adjuster up to the desired position by pushing up on the height adjuster.

After the height adjuster is set to the desired position, try to move it down without pressing the release button to make sure it has locked into position. Press the release button to lower the height adjuster.

### Safety Belt Pretensioners

This vehicle has safety belt pretensioners for front outboard occupants. Although the safety belt pretensioners cannot be seen, they are part of the safety belt assembly. They can help tighten the safety belts during the early stages of a moderate to severe frontal, near frontal, or rear crash if the threshold conditions for pretensioner activation are met. Safety belt pretensioners can also help tighten the safety belts in a side crash or a rollover event.

Pretensioners work only once. If the pretensioners activate in a crash, they will need to be replaced, and the vehicle's safety belt system will probably need other new parts. See *Replacing Safety Belt System Parts after a Crash* on page 3-19.

### Rear Safety Belt Comfort Guides

Rear safety belt comfort guides may provide added safety belt comfort for older children who have outgrown booster seats and for some adults. When installed on a shoulder belt, the comfort guide positions the shoulder belt away from the neck and head.

This vehicle has rear safety belt comfort guides in the rear outboard seating positions.

To install:

1. Remove the guide from its storage pocket on the side of the seat.

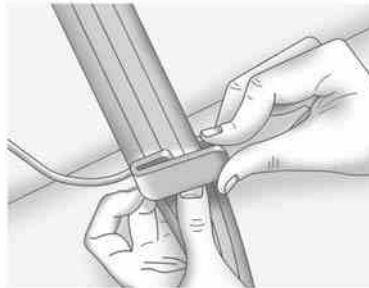

2. Place the guide over the belt, and insert the two edges of the belt into the slots of the guide.

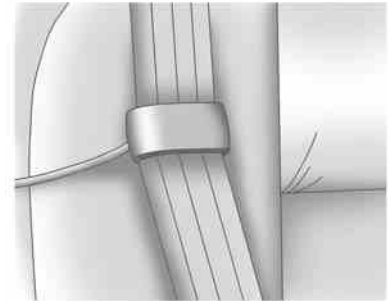

3. Be sure that the belt is not twisted and it lies flat. The elastic cord must be behind the belt with the plastic guide on the front.

## 3-18 Seats and Restraints

### Warning

A safety belt that is not properly worn may not provide the protection needed in a crash. The person wearing the belt could be seriously injured. The shoulder belt should go over the shoulder and across the chest. These parts of the body are best able to take belt restraining forces.



4. Buckle, position, and release the safety belt as described previously in this section. Make sure the shoulder portion of the belt is on the shoulder and not falling off of it. The belt should be close to, but not contacting, the neck.

To remove and store the comfort guide, squeeze the belt edges together so that the safety belt can be removed from the guide. Slide the guide back into its storage pocket on the side of the seatback.

### Safety Belt Use During Pregnancy

Safety belts work for everyone, including pregnant women. Like all occupants, they are more likely to be seriously injured if they do not wear safety belts.



A pregnant woman should wear a lap-shoulder belt, and the lap portion should be worn as low as possible, below the rounding, throughout the pregnancy.

The best way to protect the fetus is to protect the mother. When a safety belt is worn properly, it is more likely that the fetus will not be hurt in a crash. For pregnant women, as for anyone, the key to making safety belts effective is wearing them properly.

## Safety Belt Extender

If the vehicle's safety belt will fasten around you, you should use it.

But if a safety belt is not long enough, your dealer will order you an extender. When you go in to order it, take the heaviest coat you will wear, so the extender will be long enough for you. To help avoid personal injury, do not let someone else use it, and use it only for the seat it is made to fit. The extender has been designed for adults. Never use it for securing child seats. To wear it, attach it to the regular safety belt. See the instruction sheet that comes with the extender.

## Safety System Check

Now and then, check that the safety belt reminder light, safety belts, buckles, latch plates, retractors, and anchorages are all working properly. Look for any other loose or damaged safety belt system parts that might keep a safety belt system from doing its job. See your dealer

to have it repaired. Torn or frayed safety belts may not protect you in a crash. They can rip apart under impact forces. If a belt is torn or frayed, get a new one right away.

Make sure the safety belt reminder light is working. See *Safety Belt Reminders on page 5-12*.

Keep safety belts clean and dry. See *Safety Belt Care on page 3-19*.

## Safety Belt Care

Keep belts clean and dry.

### Warning

Do not bleach or dye safety belts. It may severely weaken them. In a crash, they might not be able to provide adequate protection. Clean safety belts only with mild soap and lukewarm water.

## Replacing Safety Belt System Parts after a Crash

### Warning

A crash can damage the safety belt system in the vehicle. A damaged safety belt system may not properly protect the person using it, resulting in serious injury or even death in a crash. To help make sure the safety belt systems are working properly after a crash, have them inspected and any necessary replacements made as soon as possible.

After a minor crash, replacement of safety belts may not be necessary. But the safety belt assemblies that were used during any crash may have been stressed or damaged.

See your dealer to have the safety belt assemblies inspected or replaced.

New parts and repairs may be necessary even if the safety belt system was not being used at the time of the crash.

Have the safety belt pretensioners checked if the vehicle has been in a crash, or if the airbag readiness light stays on after you start the vehicle or while you are driving. See *Airbag Readiness Light* on page 5-13.

### Airbag System

The vehicle has the following airbags:

- A frontal airbag for the driver.
- A frontal airbag for the front outboard passenger.
- A seat-mounted side impact airbag for the driver.
- A seat-mounted side impact airbag for the front outboard passenger.
- A roof-rail airbag for the driver and for the second row passenger seated directly behind the driver.
- A roof-rail airbag for the front outboard passenger and the second row passenger seated directly behind the front outboard passenger.

All vehicle airbags have the word AIRBAG on the trim or on an attached label near the deployment opening.

For frontal airbags, the word AIRBAG is on the center of the steering wheel for the driver and on the instrument panel for the front outboard passenger.

For seat-mounted side impact airbags, the word AIRBAG is on the side of the seatback closest to the door.

For roof-rail airbags, the word AIRBAG is on the ceiling or trim.

Airbags are designed to supplement the protection provided by safety belts. Even though today's airbags are also designed to help reduce the risk of injury from the force of an inflating bag, all airbags must inflate very quickly to do their job.

Here are the most important things to know about the airbag system:

**⚠ Warning**

You can be severely injured or killed in a crash if you are not wearing your safety belt, even with airbags. Airbags are designed to work with safety belts, not replace them. Also, airbags are not designed to inflate in every crash. In some crashes safety belts are the only restraint. See *When Should an Airbag Inflate?* on page 3-23.

Wearing your safety belt during a crash helps reduce the chance of hitting things inside the vehicle or being ejected from it. Airbags are “supplemental restraints” to the safety belts. Everyone in the vehicle should wear a safety belt properly, whether or not there is an airbag for that person.

**⚠ Warning**

Because airbags inflate with great force and faster than the blink of an eye, anyone who is up against, or very close to any airbag when it inflates can be seriously injured or killed. Do not sit unnecessarily close to any airbag, as you would be if sitting on the edge of the seat or leaning forward. Safety belts help keep you in position before and during a crash. Always wear a safety belt, even with airbags. The driver should sit as far back as possible while still maintaining control of the vehicle.

Occupants should not lean on or sleep against the door or side windows in seating positions with seat-mounted side impact airbags and/or roof-rail airbags.

**⚠ Warning**

Children who are up against, or very close to, any airbag when it inflates can be seriously injured or killed. Always secure children properly in the vehicle. To read how, see *Older Children on page 3-33* or *Infants and Young Children on page 3-35*.



There is an airbag readiness light on the instrument cluster, which shows the airbag symbol.

The system checks the airbag electrical system for malfunctions. The light tells you if there is an electrical problem. See *Airbag Readiness Light* on page 5-13 for more information.

### Where Are the Airbags?



The driver frontal airbag is in the center of the steering wheel.



The front outboard passenger frontal airbag is in the passenger side instrument panel.



**Driver Side Shown, Passenger Side Similar**

The driver and front outboard passenger seat-mounted side impact airbags are in the side of the seatbacks closest to the door.



### Driver Side Shown, Passenger Side Similar

The roof-rail airbags for the driver, right front passenger, and second row outboard passengers are in the ceiling above the side windows.

#### **Warning**

If something is between an occupant and an airbag, the airbag might not inflate properly or it might force the object into that person causing severe injury

(Continued)

#### **Warning (Continued)**

or even death. The path of an inflating airbag must be kept clear. Do not put anything between an occupant and an airbag, and do not attach or put anything on the steering wheel hub or on or near any other airbag covering.

Do not use seat accessories that block the inflation path of a seat-mounted side impact airbag.

Never secure anything to the roof of a vehicle with roof-rail airbags by routing a rope or tie-down through any door or window opening. If you do, the path of an inflating roof-rail airbag will be blocked.

## When Should an Airbag Inflate?

This vehicle is equipped with airbags. See *Airbag System on page 3-20*. Airbags are designed to inflate if the impact exceeds the specific airbag system's deployment threshold. Deployment thresholds are used to predict how severe a crash is likely to be in time for the airbags to inflate and help restrain the occupants. The vehicle has electronic sensors that help the airbag system determine the severity of the impact. Deployment thresholds can vary with specific vehicle design.

Frontal airbags are designed to inflate in moderate to severe frontal or near frontal crashes to help reduce the potential for severe injuries, mainly to the driver's or front outboard passenger's head and chest.

Whether the frontal airbags will or should inflate is not based primarily on how fast the vehicle is traveling.



## 3-24 Seats and Restraints

---

It depends on what is hit, the direction of the impact, and how quickly the vehicle slows down.

Frontal airbags may inflate at different crash speeds depending on whether the vehicle hits an object straight on or at an angle, and whether the object is fixed or moving, rigid or deformable, narrow or wide.

Frontal airbags are not intended to inflate during vehicle rollovers, in rear impacts, or in many side impacts.

In addition, the vehicle has advanced technology frontal airbags. Advanced technology frontal airbags adjust the restraint according to crash severity.

Seat-mounted side impact airbags are designed to inflate in moderate to severe side crashes depending on the location of the impact. Seat-mounted side impact airbags are not designed to inflate in frontal impacts, near frontal impacts, rollovers, or rear impacts.

A seat-mounted side impact airbag is designed to inflate on the side of the vehicle that is struck.

Roof-rail airbags are designed to inflate in moderate to severe side crashes depending on the location of the impact. In addition, these roof-rail airbags are designed to inflate during a rollover or in a severe frontal impact. Roof-rail airbags are not designed to inflate in rear impacts. Both roof-rail airbags will inflate when either side of the vehicle is struck, if the sensing system predicts that the vehicle is about to roll over on its side, or in a severe frontal impact.

In any particular crash, no one can say whether an airbag should have inflated simply because of the vehicle damage or repair costs.

### **What Makes an Airbag Inflate?**

In a deployment event, the sensing system sends an electrical signal triggering a release of gas from the

inflator. Gas from the inflator fills the airbag causing the bag to break out of the cover. The inflator, the airbag, and related hardware are all part of the airbag module.

For airbag locations, see *Where Are the Airbags?* on page 3-22.

### **How Does an Airbag Restrain?**

In moderate to severe frontal or near frontal collisions, even belted occupants can contact the steering wheel or the instrument panel. In moderate to severe side collisions, even belted occupants can contact the inside of the vehicle.

Airbags supplement the protection provided by safety belts by distributing the force of the impact more evenly over the occupant's body.

Rollover capable roof-rail airbags are designed to help contain the head and chest of occupants in the outboard seating positions in the

first and second rows. The rollover capable roof-rail airbags are designed to help reduce the risk of full or partial ejection in rollover events, although no system can prevent all such ejections.

But airbags would not help in many types of collisions, primarily because the occupant's motion is not toward those airbags. See *When Should an Airbag Inflate?* on page 3-23.

Airbags should never be regarded as anything more than a supplement to safety belts.

### What Will You See after an Airbag Inflates?

After the frontal airbags and seat-mounted side impact airbags inflate, they quickly deflate, so quickly that some people may not even realize an airbag inflated. Roof-rail airbags may still be at least partially inflated for some time after they inflate. Some components of the airbag module may be hot for

several minutes. For location of the airbags, see *Where Are the Airbags?* on page 3-22.

The parts of the airbag that come into contact with you may be warm, but not too hot to touch. There may be some smoke and dust coming from the vents in the deflated airbags. Airbag inflation does not prevent the driver from seeing out of the windshield or being able to steer the vehicle, nor does it prevent people from leaving the vehicle.

#### Warning

When an airbag inflates, there may be dust in the air. This dust could cause breathing problems for people with a history of asthma or other breathing trouble. To avoid this, everyone in the vehicle should get out as soon as it is safe to do so. If you have breathing problems but cannot get out of the vehicle after an

(Continued)

#### Warning (Continued)

airbag inflates, then get fresh air by opening a window or a door. If you experience breathing problems following an airbag deployment, you should seek medical attention.

The vehicle has a feature that may automatically unlock the doors, turn on the interior lamps and hazard warning flashers, and shut off the fuel system after the airbags inflate. The feature may also activate, without airbag inflation, after an event that exceeds a predetermined threshold. You can lock the doors, and turn off the interior lamps, and turn off the hazard warning flashers by using the controls for those features.

### Warning

A crash severe enough to inflate the airbags may have also damaged important functions in the vehicle, such as the fuel system, brake and steering systems, etc. Even if the vehicle appears to be drivable after a moderate crash, there may be concealed damage that could make it difficult to safely operate the vehicle.

Use caution if you should attempt to restart the engine after a crash has occurred.

In many crashes severe enough to inflate the airbag, windshields are broken by vehicle deformation. Additional windshield breakage may also occur from the front outboard passenger airbag.

- Airbags are designed to inflate only once. After an airbag inflates, you will need some new

parts for the airbag system. If you do not get them, the airbag system will not be there to help protect you in another crash. A new system will include airbag modules and possibly other parts. The service manual for the vehicle covers the need to replace other parts.

- The vehicle has a crash sensing and diagnostic module which records information after a crash. See *Vehicle Data Recording and Privacy on page 13-13* and *Event Data Recorders on page 13-14*.
- Let only qualified technicians work on the airbag systems. Improper service can mean that an airbag system will not work properly. See your dealer for service.

## Passenger Sensing System

The vehicle has a passenger sensing system for the front outboard passenger position. The passenger airbag status indicator will light on the overhead console when the vehicle is started.



### United States



### Canada and Mexico

The words ON and OFF, or the symbol for on and off, are visible during the system check. When the system check is complete, either the

word ON or OFF, or the symbol for on or off, will be visible. See *Passenger Airbag Status Indicator on page 5-14*.

The passenger sensing system turns off the front outboard passenger frontal airbag under certain conditions. No other airbag is affected by the passenger sensing system.

The passenger sensing system works with sensors that are part of the front outboard passenger seat. The sensors are designed to detect the presence of a properly-seated occupant and determine if the front outboard passenger frontal airbag should be allowed to inflate or not.

According to accident statistics, children are safer when properly secured in a rear seat in the correct child restraint for their weight and size.

Whenever possible, children aged 12 and under should be secured in a rear seating position.

Never put a rear-facing child seat in the front. This is because the risk to the rear-facing child is so great, if the airbag deploys.

 **Warning**

A child in a rear-facing child restraint can be seriously injured or killed if the passenger frontal airbag inflates. This is because the back of the rear-facing child restraint would be very close to the inflating airbag. A child in a forward-facing child restraint can be seriously injured or killed if the passenger frontal airbag inflates and the passenger seat is in a forward position.

Even if the passenger sensing system has turned off the passenger frontal airbag, no system is fail-safe. No one can guarantee that an airbag will not

(Continued)

**Warning (Continued)**

inflate under some unusual circumstance, even though the airbag is off.

Secure rear-facing child restraints in a rear seat, even if the airbag is off. If you secure a forward-facing child restraint in the front outboard passenger seat, always move the seat as far back as it will go. It is better to secure the child restraint in a rear seat.

The passenger sensing system is designed to turn off the front outboard passenger airbag if:

- The front outboard passenger seat is unoccupied.
- The system determines that an infant is present in a child restraint.

## 3-28 Seats and Restraints

- A front outboard passenger takes his/her weight off of the seat for a period of time.
- There is a critical problem with the airbag system or the passenger sensing system.

When the passenger sensing system has turned off the front outboard passenger frontal airbag, the off indicator will light and stay lit as a reminder that the airbag is off. See *Passenger Airbag Status Indicator* on page 5-14.

The passenger sensing system is designed to turn on the front outboard passenger frontal airbag anytime the system senses that a person of adult size is sitting properly in the front outboard passenger seat.

When the passenger sensing system has allowed the airbag to be enabled, the on indicator will light and stay lit as a reminder that the airbag is active.

For some children, including children in child restraints, and for very small adults, the passenger sensing system may or may not turn off the front outboard passenger frontal airbag, depending upon the person's seating posture and body build. Everyone in the vehicle who has outgrown child restraints should wear a safety belt properly — whether or not there is an airbag for that person.

### Warning

If the airbag readiness light ever comes on and stays on, it means that something may be wrong with the airbag system. To help avoid injury to yourself or others, have the vehicle serviced right away. See *Airbag Readiness Light* on page 5-13 for more information, including important safety information.

### If the On Indicator Is Lit for a Child Restraint

The passenger sensing system is designed to turn off the front outboard passenger frontal airbag if the system determines that an infant is present in a child restraint. If a child restraint has been installed and the on indicator is lit:

1. Turn the vehicle off.
2. Remove the child restraint from the vehicle.
3. Remove any additional items from the seat such as blankets, cushions, seat covers, seat heaters, or seat massagers.
4. Reinstall the child restraint following the directions provided by the child restraint manufacturer and refer to *Securing Child Restraints (Rear Seat)* on page 3-48 or *Securing Child Restraints (Front Passenger Seat)* on page 3-51.

5. If, after reinstalling the child restraint and restarting the vehicle, the on indicator is still lit, turn the vehicle off. Then slightly recline the vehicle seatback and adjust the seat cushion, if adjustable, to make sure that the vehicle seatback is not pushing the child restraint into the seat cushion.

Also make sure the child restraint is not trapped under the vehicle head restraint. If this happens, adjust the head restraint. See *Head Restraints on page 3-2*.

6. Restart the vehicle.

The passenger sensing system may or may not turn off the airbags for a child in a child restraint depending upon the child's size. It is better to secure a child restraint in a rear seat.

### If the Off Indicator Is Lit for an Adult-Sized Occupant



If a person of adult size is sitting in the front outboard passenger seat, but the off indicator is lit, it could be because that person is not sitting properly in the seat. Use the following steps to allow the system to detect that person and enable the front outboard passenger frontal airbag:

1. Turn the vehicle off.

2. Remove any additional material from the seat, such as blankets, cushions, seat covers, seat heaters, or seat massagers. Also remove laptops or other electronic devices.
3. Place the seatback in the fully upright position.
4. Have the person sit upright in the seat, centered on the seat cushion, with legs comfortably extended.
5. Restart the vehicle and have the person remain in this position for two to three minutes after the on indicator is lit.

#### **Warning**

If the front outboard passenger airbag is turned off for an adult-sized occupant, the airbag will not be able to inflate and help protect that person in a crash, resulting in an increased risk of

(Continued)

### Warning (Continued)

serious injury or even death. An adult-sized occupant should not ride in the front outboard passenger seat, if the passenger airbag off indicator is lit.

### Additional Factors Affecting System Operation

Safety belts help keep the passenger in position on the seat during vehicle maneuvers and braking, which helps the passenger sensing system maintain the passenger airbag status. See “Safety Belts” and “Child Restraints” in the Index for additional information about the importance of proper restraint use.

A thick layer of additional material, such as a blanket or cushion, or aftermarket equipment such as seat covers, seat heaters, and seat massagers can affect how well the passenger sensing system

operates. We recommend that you not use seat covers or other aftermarket equipment except when approved by GM for your specific vehicle. See *Adding Equipment to the Airbag-Equipped Vehicle on page 3-31* for more information about modifications that can affect how the system operates.

A wet seat can affect the performance of the passenger sensing system. Here's how:

- The passenger sensing system may turn off the passenger airbag when liquid is soaked into the seat. If this happens, the off indicator will be lit, and the airbag readiness light will also be lit.
- Liquid pooled on the seat that has not soaked in may make it more likely that the passenger sensing system will turn on the passenger airbag while a child restraint or child occupant is on

the seat. If the passenger airbag is turned on, the on indicator will be lit.

If the front passenger seat gets wet, dry it immediately. If the airbag readiness light is lit, do not install a child restraint or allow anyone to occupy the seat. See *Airbag Readiness Light on page 5-13* for important safety information.

The on indicator may be lit if an object, such as a briefcase, handbag, grocery bag, laptop, or other electronic device, is put on an unoccupied seat. If this is not desired, remove the object from the seat.

### Warning

Stowing of articles under the passenger seat or between the passenger seat cushion and seatback may interfere with the proper operation of the passenger sensing system.

## Servicing the Airbag-Equipped Vehicle

Airbags affect how the vehicle should be serviced. There are parts of the airbag system in several places around the vehicle. Your dealer and the service manual have information about servicing the vehicle and the airbag system. To purchase a service manual, see *Service Publications Ordering Information* on page 13-10.

### Warning

For up to 10 seconds after the vehicle is turned off and the battery is disconnected, an airbag can still inflate during improper service. You can be injured if you are close to an airbag when it inflates. Avoid yellow connectors. They are probably part of the airbag system. Be sure to follow

(Continued)

### Warning (Continued)

proper service procedures, and make sure the person performing work for you is qualified to do so.

## Adding Equipment to the Airbag-Equipped Vehicle

Adding accessories that change the vehicle's frame, bumper system, height, front end, or side sheet metal may keep the airbag system from working properly.

The operation of the airbag system can also be affected by changing or moving any parts of the front seats, safety belts, airbag sensing and diagnostic module, steering wheel, instrument panel, any of the airbag modules, ceiling or pillar garnish trim, overhead console, front sensors, side impact sensors, rollover sensor module, airbag wiring, or cargo restraint system and convenience net.

Your dealer and the service manual have information about the location of the airbag sensors, sensing and diagnostic module, and airbag wiring.

In addition, the vehicle has a passenger sensing system that includes sensors as part of the front outboard passenger seat. The passenger sensing system may not operate properly if the original seat trim is replaced with non-GM covers, upholstery, or trim; or with GM covers, upholstery, or trim designed for a different vehicle. Any object, such as an aftermarket seat heater or a comfort-enhancing pad or device, installed under or on top of the seat fabric, could also interfere with the operation of the passenger sensing system. This could either prevent proper deployment of the passenger airbag(s) or prevent the passenger sensing system from properly turning off the passenger airbag(s). See *Passenger Sensing System* on page 3-26.



## 3-32 Seats and Restraints

If the vehicle has rollover roof-rail airbags, see *Different Size Tires and Wheels* on page 10-58 for additional important information.

If you have to modify your vehicle because you have a disability and you have questions about whether the modifications will affect the vehicle's airbag system, or if you have questions about whether the airbag system will be affected if the vehicle is modified for any other reason, call Customer Assistance. See *Customer Assistance Offices* on page 13-3.

### Airbag System Check

The airbag system does not need regularly scheduled maintenance or replacement. Make sure the airbag readiness light is working. See *Airbag Readiness Light* on page 5-13.

#### Caution

If an airbag covering is damaged, opened, or broken, the airbag may not work properly. Do not open or break the airbag coverings. If there are any opened or broken airbag coverings, have the airbag covering and/or airbag module replaced. For the location of the airbags, see *Where Are the Airbags?* on page 3-22. See your dealer for service.

### Replacing Airbag System Parts after a Crash

#### Warning

A crash can damage the airbag systems in the vehicle.  
A damaged airbag system may not work properly and may not

(Continued)

#### Warning (Continued)

protect you and your passenger(s) in a crash, resulting in serious injury or even death. To help make sure the airbag systems are working properly after a crash, have them inspected and any necessary replacements made as soon as possible.

If an airbag inflates, you will need to replace airbag system parts. See your dealer for service.

If the airbag readiness light stays on after the vehicle is started or comes on when you are driving, the airbag system may not work properly. Have the vehicle serviced right away. See *Airbag Readiness Light* on page 5-13.

## Child Restraints

### Older Children

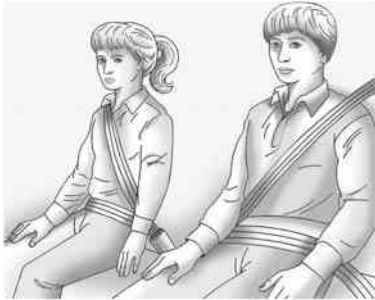

Older children who have outgrown booster seats should wear the vehicle safety belts.

The manufacturer instructions that come with the booster seat state the weight and height limitations for that booster. Use a booster seat with a lap-shoulder belt until the child passes the fit test below:

- Sit all the way back on the seat. Do the knees bend at the seat edge? If yes, continue. If no, return to the booster seat.
- Buckle the lap-shoulder belt. Does the shoulder belt rest on the shoulder? If yes, continue. If no, try using the rear safety belt comfort guide, if available. See “Rear Safety Belt Comfort Guides” under *Lap-Shoulder Belt on page 3-14*. If a comfort guide is not available, or if the shoulder belt still does not rest on the shoulder, then return to the booster seat.
- Does the lap belt fit low and snug on the hips, touching the thighs? If yes, continue. If no, return to the booster seat.

- Can proper safety belt fit be maintained for the length of the trip? If yes, continue. If no, return to the booster seat.

**Q: What is the proper way to wear safety belts?**

**A:** An older child should wear a lap-shoulder belt and get the additional restraint a shoulder belt can provide. The shoulder belt should not cross the face or neck. The lap belt should fit snugly below the hips, just touching the top of the thighs. This applies belt force to the child’s pelvic bones in a crash. It should never be worn over the abdomen, which could cause severe or even fatal internal injuries in a crash.

Also see “Rear Safety Belt Comfort Guides” under *Lap-Shoulder Belt on page 3-14*.

According to accident statistics, children are safer when properly restrained in a rear seating position.

## 3-34 Seats and Restraints

In a crash, children who are not buckled up can strike other people who are buckled up, or can be thrown out of the vehicle. Older children need to use safety belts properly.

### Warning

Never allow more than one child to wear the same safety belt. The safety belt cannot properly spread the impact forces. In a crash, they can be crushed together and seriously injured. A safety belt must be used by only one person at a time.



### Warning

Never allow a child to wear the safety belt with the shoulder belt behind their back. A child can be seriously injured by not wearing the lap-shoulder belt properly. In a crash, the child would not be restrained by the shoulder belt. The child could move too far forward increasing the chance of head and neck injury. The child might also slide under the lap

(Continued)

### Warning (Continued)

belt. The belt force would then be applied right on the abdomen. That could cause serious or fatal injuries. The shoulder belt should go over the shoulder and across the chest.



## Infants and Young Children

Everyone in a vehicle needs protection! This includes infants and all other children. Neither the distance traveled nor the age and size of the traveler changes the need, for everyone, to use safety restraints. In fact, the law in every state in the United States and in every Canadian province says children up to some age must be restrained while in a vehicle.

 **Warning**

Children can be seriously injured or strangled if a shoulder belt is wrapped around their neck. The shoulder belt can tighten but cannot be loosened if it is locked. The shoulder belt locks when it is pulled all the way out of the retractor. It unlocks when the shoulder belt is allowed to go all

(Continued)

**Warning (Continued)**

the way back into the retractor, but it cannot do this if it is wrapped around a child's neck. If the shoulder belt is locked and tightened around a child's neck, the only way to loosen the belt is to cut it.

Never leave children unattended in a vehicle and never allow children to play with the safety belts.

Every time infants and young children ride in vehicles, they should have the protection provided by appropriate child restraints. Neither the vehicle's safety belt system nor its airbag system is designed for them.

Children who are not restrained properly can strike other people, or can be thrown out of the vehicle.

 **Warning**

Never hold an infant or a child while riding in a vehicle. Due to crash forces, an infant or a child will become so heavy it is not possible to hold it during a crash. For example, in a crash at only 40 km/h (25 mph), a 5.5 kg (12 lb) infant will suddenly become a 110 kg (240 lb) force on a person's arms. An infant should be secured in an appropriate restraint.



### Warning

Children who are up against, or very close to, any airbag when it inflates can be seriously injured or killed. Never put a rear-facing child restraint in the front outboard seat. Secure a rear-facing child restraint in a rear seat. It is also better to secure a forward-facing child restraint in a rear seat. If you must secure a forward-facing child restraint in

(Continued)

### Warning (Continued)

the front outboard seat, always move the front passenger seat as far back as it will go.



### Q: What are the different types of add-on child restraints?

**A:** Add-on child restraints, which are purchased by the vehicle owner, are available in four basic types. Selection of a particular restraint should take into consideration not only the child's

weight, height, and age but also whether or not the restraint will be compatible with the motor vehicle in which it will be used.

For most basic types of child restraints, there are many different models available. When purchasing a child restraint, be sure it is designed to be used in a motor vehicle. If it is, the restraint will have a label saying that it meets federal motor vehicle safety standards.

The restraint manufacturer instructions that come with the restraint state the weight and height limitations for a particular child restraint. In addition, there are many kinds of restraints available for children with special needs.

**⚠ Warning**

To reduce the risk of neck and head injury during a crash, infants need complete support. In a crash, if an infant is in a rear-facing child restraint, the crash forces can be distributed across the strongest part of an infant's body, the back and shoulders. Infants should always be secured in rear-facing child restraints.

**⚠ Warning**

A young child's hip bones are still so small that the vehicle's regular safety belt may not remain low on the hip bones, as it should. Instead, it may settle up around the child's abdomen. In a crash, the belt would apply force on a body area that is unprotected by any bony structure. This alone could cause serious or fatal injuries. To reduce the risk of serious or fatal injuries during a crash, young children should always be secured in appropriate child restraints.

**Child Restraint Systems****Rear-Facing Infant Seat**

A rear-facing infant seat provides restraint with the seating surface against the back of the infant.

The harness system holds the infant in place and, in a crash, acts to keep the infant positioned in the restraint.



### Forward-Facing Child Seat

A forward-facing child seat provides restraint for the child's body with the harness.

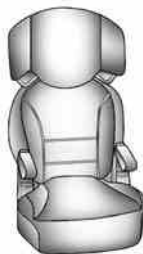
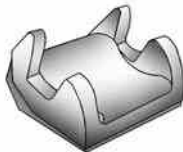

### Booster Seats

A booster seat is a child restraint designed to improve the fit of the vehicle's safety belt system. A booster seat can also help a child to see out the window.

## Securing an Add-On Child Restraint in the Vehicle

### Warning

A child can be seriously injured or killed in a crash if the child restraint is not properly secured in the vehicle. Secure the child restraint properly in the vehicle using the vehicle safety belt or LATCH system, following the instructions that came with that child restraint and the instructions in this manual.

To help reduce the chance of injury, the child restraint must be secured in the vehicle. Child restraint systems must be secured in vehicle seats by lap belts or the lap belt portion of a lap-shoulder belt, or by the LATCH system. See *Lower Anchors and Tethers for Children (LATCH System)* on page 3-40.

Children can be endangered in a crash if the child restraint is not properly secured in the vehicle.

When securing an add-on child restraint, refer to the instructions that come with the restraint which may be on the restraint itself or in a booklet, or both, and to this manual. The child restraint instructions are important, so if they are not available, obtain a replacement copy from the manufacturer.

Keep in mind that an unsecured child restraint can move around in a collision or sudden stop and injure people in the vehicle. Be sure to properly secure any child restraint in the vehicle — even when no child is in it.

In some areas of the United States and Canada, Certified Child Passenger Safety Technicians (CPSTs) are available to inspect and demonstrate how to correctly use and install child restraints. In the U.S., refer to the National Highway Traffic Safety

Administration (NHTSA) website to locate the nearest child safety seat inspection station. For CPST availability in Canada, check with Transport Canada or the Provincial Ministry of Transportation office.

### Securing the Child Within the Child Restraint

 **Warning**

A child can be seriously injured or killed in a crash if the child is not properly secured in the child restraint. Secure the child properly following the instructions that came with that child restraint.

### Where to Put the Restraint

According to accident statistics, children and infants are safer when properly restrained in a child restraint system or infant restraint system secured in a rear seating position.

Whenever possible, children aged 12 and under should be secured in a rear seating position.

Never put a rear-facing child seat in the front. This is because the risk to the rear-facing child is so great if the airbag deploys.

 **Warning**

A child in a rear-facing child restraint can be seriously injured or killed if the front passenger airbag inflates. This is because the back of the rear-facing child restraint would be very close to the inflating airbag. A child in a forward-facing child restraint can be seriously injured or killed if the front passenger airbag inflates and the passenger seat is in a forward position.

Even if the passenger sensing system has turned off the front passenger frontal airbag, no

(Continued)



### Warning (Continued)

system is fail-safe. No one can guarantee that an airbag will not deploy under some unusual circumstance, even though it is turned off.

Secure rear-facing child restraints in a rear seat, even if the airbag is off. If you secure a forward-facing child restraint in the front seat, always move the front passenger seat as far back as it will go. It is better to secure the child restraint in a rear seat.

See *Passenger Sensing System* on page 3-26 for additional information.

When securing a child restraint in a rear seating position, study the instructions that came with the child restraint to make sure it is compatible with this vehicle.

Child restraints and booster seats vary considerably in size, and some may fit in certain seating positions better than others.

Depending on where you place the child restraint and the size of the child restraint, you may not be able to access adjacent safety belt assemblies or LATCH anchors for additional passengers or child restraints. Adjacent seating positions should not be used if the child restraint prevents access to or interferes with the routing of the safety belt.

Wherever a child restraint is installed, be sure to secure the child restraint properly.

Keep in mind that an unsecured child restraint can move around in a collision or sudden stop and injure people in the vehicle. Be sure to properly secure any child restraint in the vehicle — even when no child is in it.

### Lower Anchors and Tethers for Children (LATCH System)

The LATCH system secures a child restraint during driving or in a crash. LATCH attachments on the child restraint are used to attach the child restraint to the anchors in the vehicle. The LATCH system is designed to make installation of a child restraint easier.

In order to use the LATCH system in your vehicle, you need a child restraint that has LATCH attachments. LATCH-compatible rear-facing and forward-facing child seats can be properly installed using either the LATCH anchors or the vehicle's safety belts. Do not use both the safety belts and the LATCH anchorage system to secure a rear-facing or forward-facing child seat.

Booster seats use the vehicle's safety belts to secure the child in the booster seat. If the manufacturer

recommends that the booster seat be secured with the LATCH system, this can be done as long as the booster seat can be positioned properly and there is no interference with the proper positioning of the lap-shoulder belt on the child.

Make sure to follow the instructions that came with the child restraint, and also the instructions in this manual.

When installing a child restraint with a top tether, you must also use either the lower anchors or the safety belts to properly secure the child restraint. A child restraint must never be installed using only the top tether and anchor.

The LATCH anchorage system can be used until the combined weight of the child plus the child restraint is 29.5 kg (65 lbs). Use the safety belt alone instead of the LATCH anchorage system once the combined weight is more than 29.5 kg (65 lbs).

The following explains how to attach a child restraint with these attachments in the vehicle.

Not all vehicle seating positions or child restraints have lower anchors and attachments or top tether anchors and attachments.

### Lower Anchors

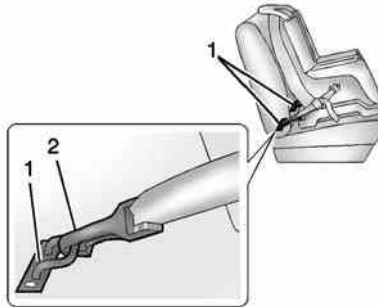

Lower anchors (1) are metal bars built into the vehicle. There are two lower anchors for each LATCH seating position that will accommodate a child restraint with lower attachments (2).

### Top Tether Anchor

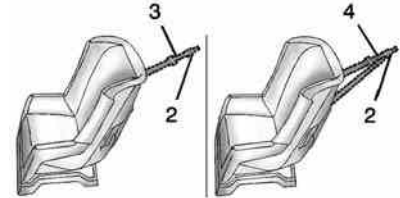

A top tether (3, 4) anchors the top of the child restraint to the vehicle. A top tether anchor is built into the vehicle. The top tether attachment (2) on the child restraint connects to the top tether anchor in the vehicle in order to reduce the forward movement and rotation of the child restraint during driving or in a crash.

## 3-42 Seats and Restraints

The child restraint may have a single tether (3) or a dual tether (4). Either will have a single attachment (2) to secure the top tether to the anchor.

Some child restraints that have a top tether are designed for use with or without the top tether being attached. Others require the top tether always to be attached. In Canada, the law requires that forward-facing child restraints have a top tether, and that the tether be attached. Be sure to read and follow the instructions for your child restraint.

### Lower Anchor and Top Tether Anchor Locations

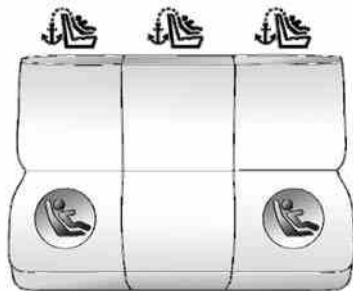

Rear Seat

 **(Top Tether Anchor):** Seating positions with top tether anchors.

 **(Lower Anchor):** Seating positions with two lower anchors.



To assist in locating the lower anchors, each seating position with lower anchors has two labels, near the crease between the seatback and the seat cushion.



To assist in locating the top tether anchors, the top tether anchor symbol is located on the cover.

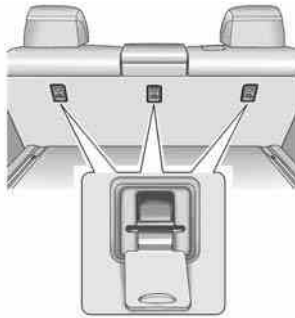

**Top Tether Anchors**

The top tether anchors for each rear seating position are located under the covers, on the back of the rear seatback. Be sure to use an anchor located on the same side of the vehicle as the seating position where the child restraint will be placed.

Do not secure a child restraint in a position without a top tether anchor if a national or local law requires that the top tether be attached, or if

the instructions that come with the child restraint say that the top tether must be attached.

According to accident statistics, children and infants are safer when properly restrained in a child restraint system or infant restraint system secured in a rear seating position. See *Where to Put the Restraint* on page 3-39 for additional information.

**Securing a Child Restraint Designed for the LATCH System**

**⚠ Warning**

If a LATCH-type child restraint is not attached to anchors or with the safety belt, the child restraint will not be able to protect the child correctly. In a crash, the child could be seriously injured or killed. Install a LATCH-type child restraint properly using the

(Continued)

**Warning (Continued)**

anchors, or use the vehicle safety belts to secure the restraint, following the instructions that came with the child restraint and the instructions in this manual.

**⚠ Warning**

To reduce the risk of serious or fatal injuries during a crash, do not attach more than one child restraint to a single anchor. Attaching more than one child restraint to a single anchor could cause the anchor or attachment to come loose or even break during a crash. A child or others could be injured.

### Warning

Children can be seriously injured or strangled if a shoulder belt is wrapped around their neck. The shoulder belt can tighten but cannot be loosened if it is locked. The shoulder belt locks when it is pulled all the way out of the retractor. It unlocks when the shoulder belt is allowed to go all the way back into the retractor, but it cannot do this if it is wrapped around a child's neck. If the shoulder belt is locked and tightened around a child's neck, the only way to loosen the belt is to cut it.

Buckle any unused safety belts behind the child restraint so children cannot reach them. Pull the shoulder belt all the way out of the retractor to set the lock, and tighten the belt behind the child restraint after the child restraint has been installed.

### Caution

Do not let the LATCH attachments rub against the vehicle's safety belts. This may damage these parts. If necessary, move buckled safety belts to avoid rubbing the LATCH attachments.

Do not fold the empty rear seat with a safety belt buckled. This could damage the safety belt or the seat. Unbuckle and return the safety belt to its stowed position, before folding the seat.

If you need to secure more than one child restraint in the rear seat, see *Where to Put the Restraint on page 3-39*.

This system is designed to make installation of child restraints easier. When using lower anchors, do not use the vehicle's safety belts. Instead use the vehicle's anchors and child restraint attachments to

secure the restraints. Some restraints also use another vehicle anchor to secure a top tether.

1. Attach and tighten the lower attachments to the lower anchors. If the child restraint does not have lower attachments or the desired seating position does not have lower anchors, secure the child restraint with the top tether and the safety belts. Refer to your child restraint manufacturer instructions and the instructions in this manual.

- 1.1. Find the lower anchors for the desired seating position.
- 1.2. Put the child restraint on the seat.

For the outboard rear seating positions, if the head restraint interferes with the proper installation of the child restraint, the head restraint may be removed. See "Head

Restraint Removal and Reinstallation” at the end of this section.

- 1.3. Attach and tighten the lower attachments on the child restraint to the lower anchors.
2. If the child restraint manufacturer recommends that the top tether be attached, attach and tighten the top tether to the top tether anchor, if equipped. Refer to the child restraint instructions and the following steps:
  - 2.1. Find the top tether anchor and open its cover to expose the anchor.

- 2.2. Route, attach, and tighten the top tether according to your child restraint instructions and the following instructions:

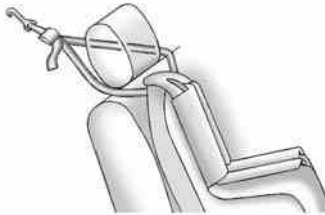

If you are using a dual tether in the rear outboard seating position with an adjustable head restraint, route the dual tether around the head restraint.

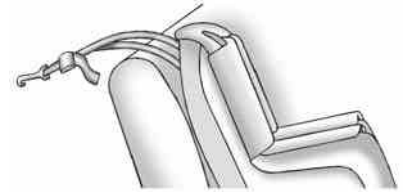

## 3-46 Seats and Restraints

---

If you are using a dual tether in the rear outboard seating position and the head restraint has been removed, route the dual tether over the seatback.

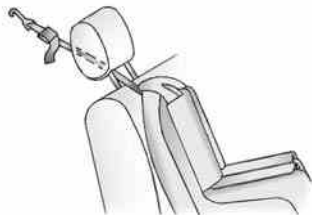

If you are using a single tether in the rear outboard seating position with an adjustable head restraint, route the single tether under the head restraint and in between the head restraint posts.

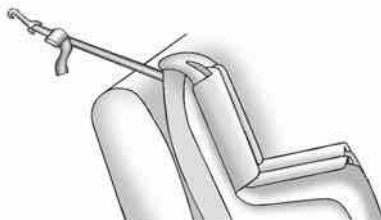

If you are using a single tether in the rear outboard seating position and the head restraint has been removed, route the single tether over the seatback.

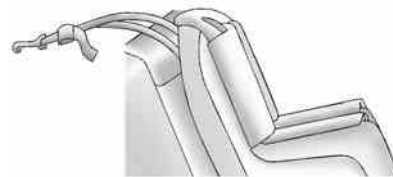

If you are using a dual tether in the rear center seating position, lower the adjustable headrest down to its stowed position and route the dual tether over the headrest.

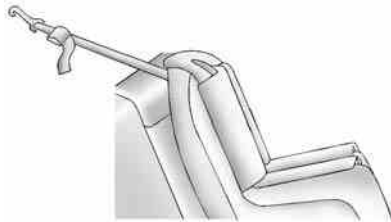

If you are using a single tether in the rear center seating position, lower the adjustable headrest down to its stowed position and route the single tether over the headrest.

3. Before placing a child in the child restraint, make sure it is securely held in place. To check, grasp the child restraint at the

LATCH path and attempt to move it side to side and back and forth. There should be no more than 2.5 cm (1 in) of movement for proper installation.

### Head Restraint Removal and Reinstallation

The rear outboard head restraints can be removed if they interfere with the proper installation of the child restraint. The headrest in the rear center seating position is not removable and should be lowered to the stowed position for child restraint installation.

To remove the head restraint:

1. Partially fold the seatback forward. See *Rear Seats on page 3-10* for additional information.

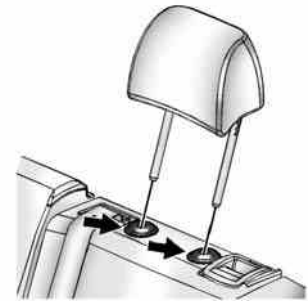

2. Press both buttons on the head restraint posts at the same time, and pull up on the head restraint.
3. Store the head restraint in the cargo area of the vehicle.
4. When the child restraint is removed, reinstall the head restraint before the seating position is used.



### Warning

With head restraints that are not installed and adjusted properly, there is a greater chance that occupants will suffer a neck/spinal injury in a crash. Do not drive until the head restraints for all occupants are installed and adjusted properly.

To reinstall the head restraint:

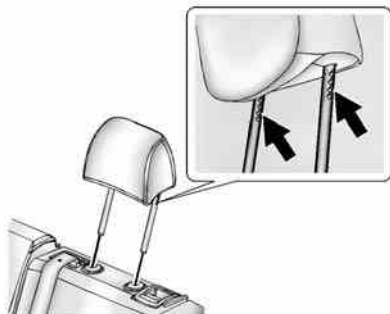

1. Insert the head restraint posts into the holes in the top of the seatback. The notches on the posts must face the driver side of the vehicle.
2. Push the head restraint down. If necessary, press the height adjustment release button to further lower the head restraint. See *Head Restraints on page 3-2*.
3. Try to move the head restraint to make sure that it is locked in place.

### Replacing LATCH System Parts After a Crash

#### Warning

A crash can damage the LATCH system in the vehicle. A damaged LATCH system may not properly secure the child restraint, resulting in serious injury or even

(Continued)

#### Warning (Continued)

death in a crash. To help make sure the LATCH system is working properly after a crash, see your dealer to have the system inspected and any necessary replacements made as soon as possible.

If the vehicle has the LATCH system and it was being used during a crash, new LATCH system parts may be needed.

New parts and repairs may be necessary even if the LATCH system was not being used at the time of the crash.

### Securing Child Restraints (Rear Seat)

When securing a child restraint in a rear seating position, study the instructions that came with the child restraint to make sure it is compatible with this vehicle.

If the child restraint has the LATCH system, see *Lower Anchors and Tethers for Children (LATCH System)* on page 3-40 for how and where to install the child restraint using LATCH. If a child restraint is secured in the vehicle using a safety belt and it uses a top tether, see *Lower Anchors and Tethers for Children (LATCH System)* on page 3-40 for top tether anchor locations.

Do not secure a child seat in a position without a top tether anchor if a national or local law requires that the top tether be anchored, or if the instructions that come with the child restraint say that the top strap must be anchored.

In Canada, the law requires that forward-facing child restraints have a top tether, and that the tether be attached.

If the child restraint or vehicle seat position does not have the LATCH system, you will be using the safety belt to secure the child restraint in

this position. Be sure to follow the instructions that came with the child restraint. Secure the child in the child restraint when and as the instructions say.

If more than one child restraint needs to be installed in the rear seat, be sure to read *Where to Put the Restraint* on page 3-39.

1. Put the child restraint on the seat.

If the head restraint interferes with the proper installation of the child restraint, the head restraint may be removed. See “Head Restraint Removal and Reinstallation” under *Lower Anchors and Tethers for Children (LATCH System)* on page 3-40.

2. Pick up the latch plate, and run the lap and shoulder portions of the vehicle’s safety belt through or around the restraint. The child restraint instructions will show you how.



3. Push the latch plate into the buckle until it clicks.

Position the release button on the buckle so that the safety belt could be quickly unbuckled if necessary.

## 3-50 Seats and Restraints



4. Pull the shoulder belt all the way out of the retractor to set the lock. When the retractor lock is set, the belt can be tightened but not pulled out of the retractor.

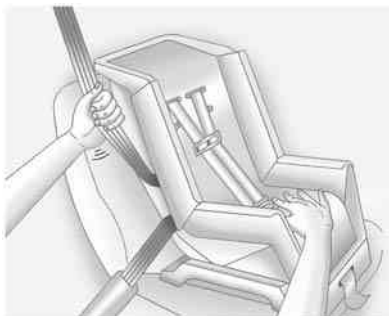

5. To tighten the belt, push down on the child restraint, pull the shoulder portion of the belt to tighten the lap portion of the belt, and feed the shoulder belt back into the retractor. When installing a forward-facing child restraint, it may be helpful to use your knee to push down on the child restraint as you tighten the belt.

Try to pull the belt out of the retractor to make sure the retractor is locked. If the retractor is not locked, repeat Steps 4 and 5.

6. If the child restraint has a top tether, follow the child restraint manufacturer's instructions regarding the use of the top tether. See *Lower Anchors and Tethers for Children (LATCH System)* on page 3-40.
7. Before placing a child in the child restraint, make sure it is securely held in place. To check, grasp the child restraint at the safety belt path and attempt to move it side to side and back and forth. When the child restraint is properly installed, there should be no more than 2.5 cm (1 in) of movement.

To remove the child restraint, unbuckle the vehicle safety belt and let it return to the stowed position. If the top tether is attached to a top tether anchor, disconnect it. If the head restraint was removed, reinstall it before the seating position is used. See "Head Restraint Removal and Reinstallation" under *Lower Anchors and Tethers for Children (LATCH*

*System*) on page 3-40 for additional information on installing the head restraint properly.

### Securing Child Restraints (Front Passenger Seat)

This vehicle has airbags. A rear seat is a safer place to secure a forward-facing child restraint. See *Where to Put the Restraint* on page 3-39.

In addition, the vehicle has a passenger sensing system which is designed to turn off the front outboard passenger frontal airbag under certain conditions. See *Passenger Sensing System* on page 3-26 and *Passenger Airbag Status Indicator* on page 5-14 for more information, including important safety information.

Never put a rear-facing child seat in the front. This is because the risk to the rear-facing child is so great, if the airbag deploys.

#### Warning

A child in a rear-facing child restraint can be seriously injured or killed if the front outboard passenger frontal airbag inflates. This is because the back of the rear-facing child restraint would be very close to the inflating airbag. A child in a forward-facing child restraint can be seriously injured or killed if the front outboard passenger frontal airbag inflates and the passenger seat is in a forward position.

Even if the passenger sensing system has turned off the front outboard passenger frontal airbag, no system is fail-safe. No one can guarantee that an airbag will not deploy under some unusual circumstance, even though it is turned off.

(Continued)

#### Warning (Continued)

Secure rear-facing child restraints in a rear seat, even if the airbag is off. If you secure a forward-facing child restraint in the front seat, always move the front passenger seat as far back as it will go. It is better to secure the child restraint in a rear seat.

See *Passenger Sensing System* on page 3-26 for additional information.

If the vehicle does not have a rear seat that will accommodate a rear-facing child restraint, a rear-facing child restraint should not be installed in the vehicle, even if the airbag is off.

If the child restraint uses a top tether, see *Lower Anchors and Tethers for Children (LATCH System)* on page 3-40 for top tether anchor locations.

## 3-52 Seats and Restraints

Do not secure a child seat in a position without a top tether anchor if a national or local law requires that the top tether be anchored, or if the instructions that come with the child restraint say that the top strap must be anchored.

In Canada, the law requires that forward-facing child restraints have a top tether, and that the tether be attached.

When using the lap-shoulder belt to secure the child restraint in this position, follow the instructions that came with the child restraint and the following instructions:

1. Move the seat as far back as it will go before securing the forward-facing child restraint.

When the passenger sensing system has turned off the front outboard passenger frontal airbag, the off indicator on the passenger airbag status indicator should light and stay lit

when you start the vehicle. See *Passenger Airbag Status Indicator* on page 5-14.

2. Put the child restraint on the seat.
3. Pick up the latch plate, and run the lap and shoulder portions of the vehicle's safety belt through or around the restraint. The child restraint instructions will show you how.



Tilt the latch plate to adjust the belt if needed.



4. Push the latch plate into the buckle until it clicks.

Position the release button on the buckle, so that the safety belt could be quickly unbuckled if necessary.



5. Pull the shoulder belt all the way out of the retractor to set the lock. When the retractor lock is set, the belt can be tightened but not pulled out of the retractor.

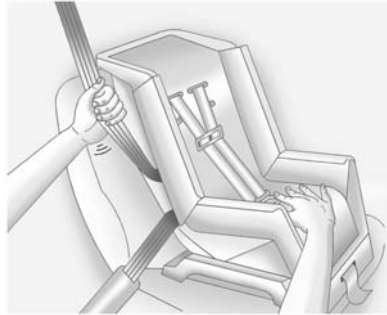

6. To tighten the belt, push down on the child restraint, pull the shoulder portion of the belt to tighten the lap portion of the belt, and feed the shoulder belt back into the retractor. When installing a forward-facing child restraint, it may be helpful to use your knee to push down on the child restraint as you tighten the belt.

Try to pull the belt out of the retractor to make sure the retractor is locked. If the retractor is not locked, repeat Steps 5 and 6.

7. Before placing a child in the child restraint, make sure it is securely held in place. To check, grasp the child restraint at the safety belt path and attempt to move it side to side and back and forth. When the child restraint is properly installed, there should be no more than 2.5 cm (1 in) of movement.

If the airbag is off, the off indicator in the passenger airbag status indicator will come on and stay on when the vehicle is started.

If a child restraint has been installed and the on indicator is lit, see "If the On Indicator is Lit for a Child Restraint" under *Passenger Sensing System* on page 3-26.

To remove the child restraint, unbuckle the vehicle safety belt and let it return to the stowed position.



## Storage

### Storage Compartments

Storage Compartments .....	4-1
Glove Box .....	4-1
Cupholders .....	4-2
Front Storage .....	4-2
Armrest Storage .....	4-2
Center Console Storage .....	4-3

### Additional Storage Features

Cargo Cover .....	4-3
Cargo Tie-Downs .....	4-5
Cargo Management System .....	4-5
Cargo Net .....	4-9
Convenience Net .....	4-11

### Roof Rack System

Roof Rack System .....	4-11
------------------------	------

## Storage Compartments

### ⚠ Warning

Do not store heavy or sharp objects in storage compartments. In a crash, these objects may cause the cover to open and could result in injury.

## Glove Box

Lift the glove box handle up to open it. Use the key to lock and unlock the glove box.

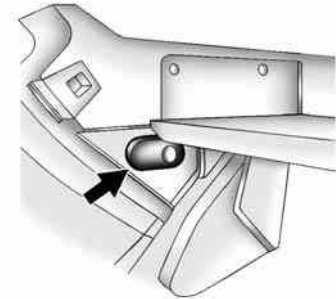

The glove box is air conditioned and can be used to store items at a lower temperature. The vehicle air conditioning must be turned on for the maximum cool air to enter the glove box. Move the slide control to allow cool air into the glove box. After opening the air flow, close the glove box door to keep the cold air from entering the vehicle.



## 4-2 Storage

### Cupholders

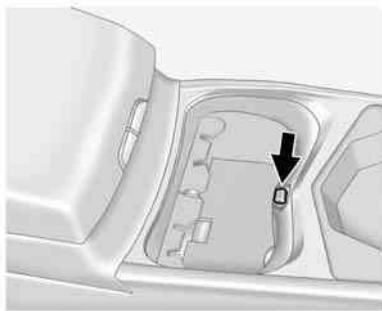

The front cupholder has a divider that can be adjusted to accommodate large or small containers.

For large containers, press the button to move aside the divider and make the cupholder deeper. For small containers, push down on the top edge of the divider to lock it back in place and make the cupholder shorter.

### Front Storage

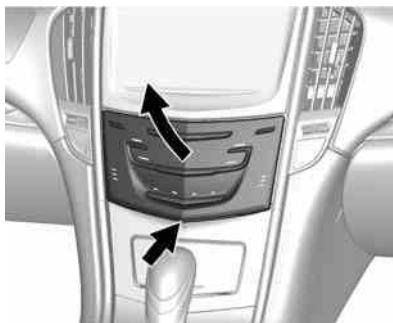

There is storage behind the climate control system. Touch the chrome bar at the bottom of the climate control system panel to open. There is a USB port inside. See “USB/SD Port” in the infotainment manual.

Keep the storage area door closed while driving.

Touch the chrome bar at the bottom of the climate control system panel again to close.



A storage area is located in front of the shift lever. Push upward on the top of the door and release; the door automatically opens.

There is an accessory power outlet inside. See *Power Outlets* on page 5-6.

### Armrest Storage

For vehicles with a rear seat armrest, pull the rear seat armrest forward to access cupholders with removable liners. For vehicles with a rear storage area, pull the lever to access.

## Center Console Storage

The center console has an armrest, upper storage tray, and lower storage area.

The armrest can be adjusted. Slide the top of the armrest to adjust to the desired position.

Press the driver side button to access the upper storage tray. Press the passenger side button to access the lower storage area.

There are two USB ports and an accessory power outlet inside the center console. There may be an SD card reader and auxiliary jack. See *Power Outlets on page 5-6* and the infotainment manual.

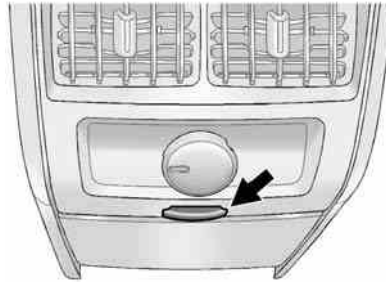

Press the button to open the storage area on the rear of the center console. If equipped with Rear Seat Entertainment (RSE), the audio/video jacks, USB port, and SD card reader may be inside. See the infotainment manual.

## Additional Storage Features

### Cargo Cover

For vehicles with the dual position cargo cover, it can be used to cover items in the cargo area of the vehicle.

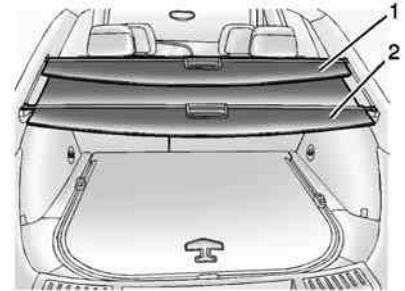

The shade can be set in two positions. It can be set in a halfway open (1) position for loading objects

## 4-4 Storage

into the rear compartment, or the lower (2) position to conceal objects in the rear compartment.

### Install the Cargo Cover

1. Hold the cartridge so that the pull-out shade faces the rear of the vehicle.

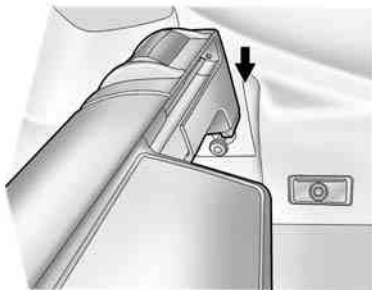

2. Align the cartridge over the pins on the trim panels of the vehicle.
3. Push down on the cartridge to snap it into place.
4. Unroll the shade toward the rear of the vehicle.

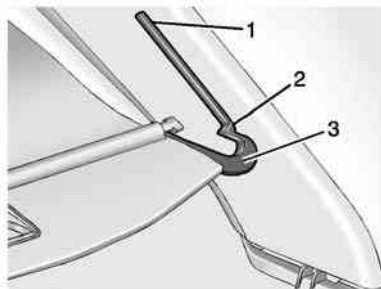

5. Insert the shade pins in the channels (3) on both sides.
6. Slide the shade to the lower (2) position, or the halfway open (1) position.

### Remove the Cargo Cover

1. Remove the cover from the channels and carefully roll it back up.

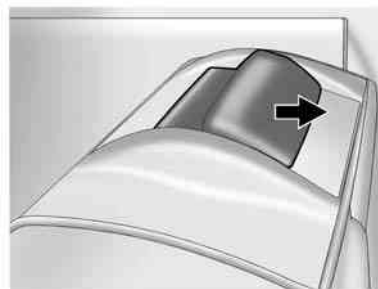

2. Slide the button on the top to release the cartridge.
3. Pull up to remove the cartridge from the pins.

### Warning

An unsecured cargo cover could strike people in a sudden stop or turn, or in a crash. Store the cargo cover securely or remove it from the vehicle.

## Cargo Tie-Downs

For vehicles equipped with cargo tie-downs, the four tie-downs are located in the rear compartment of the vehicle. Use the tie-downs to secure small loads.

## Cargo Management System

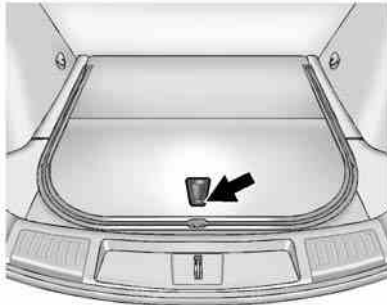

To open the cargo management system, press the rear of the handle to unlatch it and then lift the handle up.

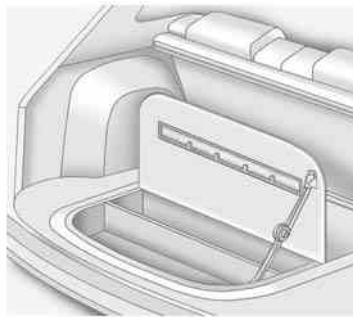

A prop rod locks to hold the cover up when opened.

Four hooks are located on the inside cover and can be used for storing items.

There may be additional storage compartments on each side of the cargo management system. Lift the panel up to open.

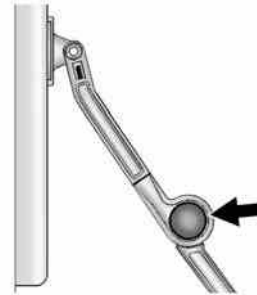

Press the red button on the prop rod to close the cover.

### Rear Storage Area

#### Warning

An improperly latched and closed cargo cover, or cargo left in the open position, could be thrown about the vehicle during a crash or sudden maneuver. Someone could be injured. Be sure to return the cover to the

(Continued)

## 4-6 Storage

### Warning (Continued)

closed position and latch before driving. If the cover is removed, always store it outside of the vehicle. When it is replaced, always be sure that it is securely reattached.

To access the rear storage areas of the cargo management system, and the tire sealant and compressor kit:

1. Remove the cargo cover, if equipped.
2. Open the cargo management system cover.

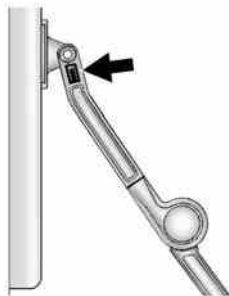

3. Release the prop rod from the inside cover by sliding the red clip down.

Unhook the prop rod from the pin on the inside cover. Store the unhooked prop rod by folding it into the cargo management compartment.

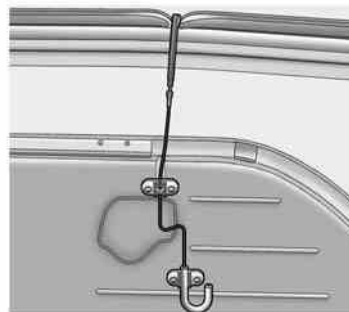

4. Store the cargo management system cover by hooking it onto the weatherstrip.

## U-Rail

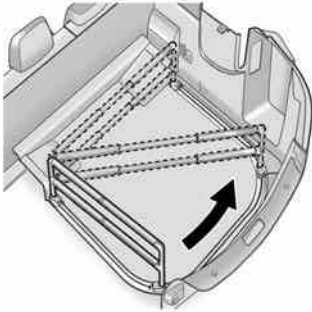

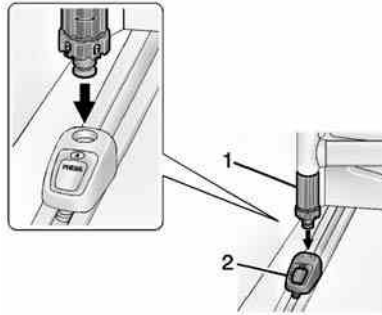

If equipped with a u-rail system, the fence can be moved to different positions on the u-rail track to secure cargo.



Press both adapter buttons to move the adapters (2) on the straight part of the u-rail.

To move the fence around the u-rail, disconnect one side:

1. Unlock by turning the latch (1) to align  with the arrow on the adapter (2).
2. Press the adapter button to move the adapters (2) to the desired position.

3. Reinstall the fence and lock both latches (1) by turning to align  with the arrow on the adapter (2).



Use the fence to secure items in place.

### Removing the Fence

Unlock by turning both latches (1) to align  with the arrow on the adapter (2). Lift and remove the fence.

## 4-8 Storage

### Installing the Fence

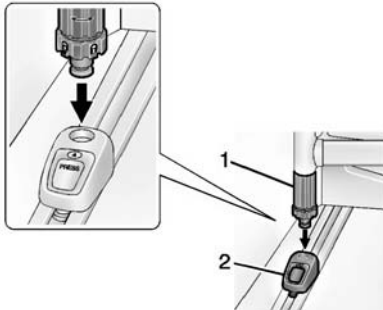

Insert the fence into the adapters and lock both latches (1) by turning to align  with the arrow on the adapter (2).

### Storing the Fence

1. Lift the cargo management system cover.
2. Release the cover from the prop rod as described in the previous steps.

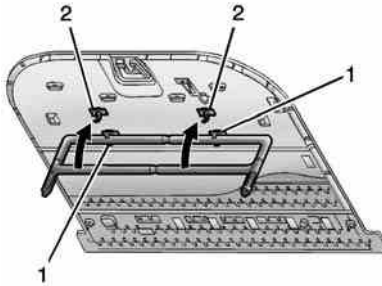

3. Insert the top of the fence into the lower two clips (1).
4. Turn the bottom of the fence up and insert it into the upper two clips (2).

### D-Ring Sliders

If equipped with a D-ring system, there are four D-ring sliders that move along rails. These can be used as tie-downs when storing cargo.

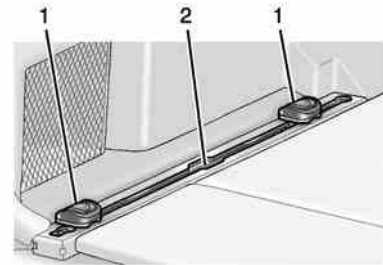

Insert the D-ring sliders (1) into the channel (2) located in the middle of the rail. Press the button to move the D-ring slider along the rail.

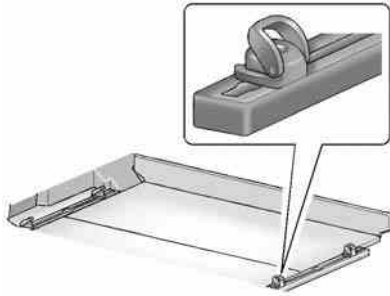

The loop of the D-ring slider must be facing inward toward the storage area and the ring must be in the up position for proper usage.

## Cargo Net

### Warning

Do not stack items higher than the upper end of the cargo net or hang anything from the net. Avoid items that have sharp edges or that apply excessive force to the

(Continued)

### Warning (Continued)

net. If items are not properly stored, damage to the net could occur and items can be thrown about the vehicle. You or others could be injured. Always store items behind the net.

If equipped, the cargo net can be used to store light loads, keeping them from falling over or being thrown into the cabin during heavy braking.

The net should not be overloaded or used to store heavy loads.

There are four openings in the headliner: two behind the front seats and two behind the rear seats.



1. Insert the top corners of the cargo net into the large openings in the headliner and secure by sliding them into the small openings.
2. The rear seatbacks should be folded down when the net is installed in the headliner opening behind the front seats.



## 4-10 Storage



3. Mount the cargo net to the rear seat tethers on the back of the folded down rear seats and pull on the straps to tighten the net.
4. When the net is installed in the headliner opening behind the rear seats, the rear seatbacks should be upright.

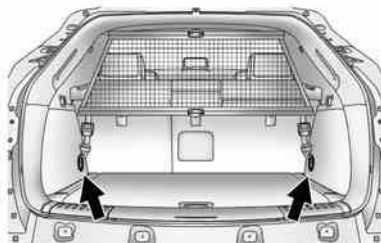

5. Mount the cargo net to the cargo tie-downs on the lower side panels.

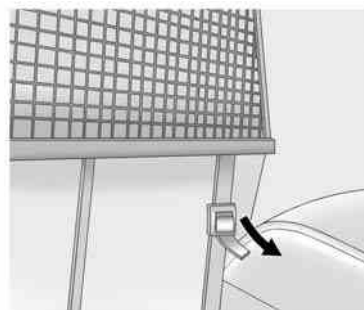

6. Pull on the straps to tighten the net.

### Cargo Net Storage

The cargo net can be removed from the vehicle and stored in the cargo management system.

1. Disconnect the net from the roof openings and the tethers.
2. Press the red button on the center of the net to fold it in half.
3. Roll up the cargo net and store it in the attached vinyl bag.

4. Open the cargo management system cover.
5. If equipped with a tire sealant and compressor kit, store the cargo net in the available space next to the kit.

## Convenience Net

This vehicle may have a convenience net located in the rear of the vehicle. Attach it to the cargo tie-downs for storing small loads.

Do not use the net to store heavy loads.

## Roof Rack System

### Warning

If something is carried on top of the vehicle that is longer or wider than the roof rack — like paneling, plywood, or a mattress — the wind can catch it while the vehicle is being driven. The item being carried could be violently torn off, and this could cause a collision and damage the vehicle. Never carry something longer or wider than the roof rack on top of the vehicle unless using a GM certified accessory carrier.

If equipped, the roof rack can be used to load items. For roof racks that do not have crossrails included, GM Certified crossrails can be purchased as an accessory. See your dealer for additional information.

### Caution

Loading cargo on the roof rack that weighs more than 100 kg (220 lb) or hangs over the rear or sides of the vehicle may damage the vehicle. Load cargo so that it rests evenly between the crossrails, making sure to fasten cargo securely.

## 4-12 Storage

---

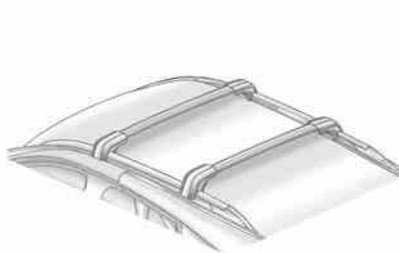

To prevent damage or loss of cargo when driving, check to make sure crossrails and cargo are securely fastened. Loading cargo on the roof rack will make the vehicle's center of gravity higher. Avoid high speeds,

sudden starts, sharp turns, sudden braking, or abrupt maneuvers; otherwise it may result in loss of control. If driving for a long distance, on rough roads, or at high speeds, occasionally stop the vehicle to make sure the cargo remains in its place. Do not exceed the maximum vehicle capacity when loading the vehicle. For more information on vehicle capacity and loading, see *Vehicle Load Limits* on page 9-9.

# Instruments and Controls

## Controls

Steering Wheel Adjustment . . .	5-2
Steering Wheel Controls . . . . .	5-2
Heated Steering Wheel . . . . .	5-2
Horn . . . . .	5-3
Windshield Wiper/Washer . . . . .	5-3
Rear Window Wiper/ Washer . . . . .	5-4
Compass . . . . .	5-5
Clock . . . . .	5-6
Power Outlets . . . . .	5-6
Cigarette Lighter . . . . .	5-7
Ashtrays . . . . .	5-7

## Warning Lights, Gauges, and Indicators

Warning Lights, Gauges, and Indicators . . . . .	5-8
Instrument Cluster . . . . .	5-9
Speedometer . . . . .	5-10
Odometer . . . . .	5-10
Trip Odometer . . . . .	5-10
Tachometer . . . . .	5-11
Fuel Gauge . . . . .	5-11

Engine Coolant Temperature Gauge . . . . .	5-12
Safety Belt Reminders . . . . .	5-12
Airbag Readiness Light . . . . .	5-13
Passenger Airbag Status Indicator . . . . .	5-14
Charging System Light . . . . .	5-15
Malfunction Indicator Lamp . . . . .	5-15
Brake System Warning Light . . . . .	5-18
Electric Parking Brake Light . . . . .	5-18
Service Electric Parking Brake Light . . . . .	5-19
Antilock Brake System (ABS) Warning Light . . . . .	5-19
Lane Departure Warning (LDW) Light . . . . .	5-20
Vehicle Ahead Indicator . . . . .	5-20
Traction Off Light . . . . .	5-20
StabiliTrak <sup>®</sup> OFF Light . . . . .	5-20
Traction Control System (TCS)/StabiliTrak <sup>®</sup> Light . . . . .	5-21
Engine Coolant Temperature Warning Light . . . . .	5-21
Tire Pressure Light . . . . .	5-22
Engine Oil Pressure Light . . . . .	5-22
Fuel Economy Light . . . . .	5-23

Low Fuel Warning Light . . . . .	5-23
Security Light . . . . .	5-23
High-Beam On Light . . . . .	5-24
Adaptive Forward Lighting (AFL) Light . . . . .	5-24
Front Fog Lamp Light . . . . .	5-24
Lamps On Reminder . . . . .	5-24
Cruise Control Light . . . . .	5-25

## Information Displays

Driver Information Center (DIC) . . . . .	5-25
--	------

## Vehicle Messages

Vehicle Messages . . . . .	5-28
Battery Voltage and Charging Messages . . . . .	5-28
Brake System Messages . . . . .	5-28
Compass Messages . . . . .	5-29
Cruise Control Messages . . . . .	5-29
Door Ajar Messages . . . . .	5-30
Engine Cooling System Messages . . . . .	5-30
Engine Oil Messages . . . . .	5-31
Engine Power Messages . . . . .	5-31
Fuel System Messages . . . . .	5-32
Key and Lock Messages . . . . .	5-32
Lamp Messages . . . . .	5-32

## 5-2 Instruments and Controls

Object Detection System Messages .....	5-33
Ride Control System Messages .....	5-36
Airbag System Messages ....	5-36
Security Messages .....	5-37
Service Vehicle Messages ...	5-37
Starting the Vehicle Messages .....	5-37
Tire Messages .....	5-37
Transmission Messages .....	5-38
Vehicle Reminder Messages .....	5-38
Vehicle Speed Messages ....	5-38
Washer Fluid Messages .....	5-38

### Vehicle Personalization

Vehicle Personalization .....	5-39
-------------------------------	------

### Universal Remote System

Universal Remote System ...	5-46
Universal Remote System Programming .....	5-46
Universal Remote System Operation .....	5-48

## Controls

### Steering Wheel Adjustment

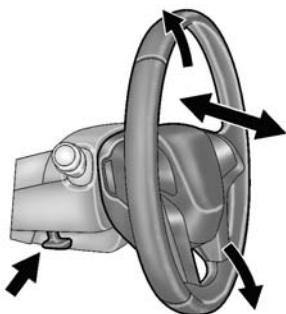

To adjust the steering wheel:

1. Pull the lever down.
2. Move the steering wheel up or down.
3. Pull or push the steering wheel closer or away from you.
4. Pull the lever up to lock the steering wheel in place.

Do not adjust the steering wheel while driving.

### Steering Wheel Controls

The infotainment system can be operated by using the steering wheel controls. See "Steering Wheel Controls" in the infotainment manual.

### Heated Steering Wheel



#### (Heated Steering Wheel):

If equipped with a heated steering wheel, press to turn on or off. An indicator next to the button is lit when the feature is turned on.

The steering wheel takes about three minutes to start heating.

## Horn

Press  on the steering wheel pad to sound the horn.

## Windshield Wiper/Washer



With the ignition in ACC/ACCESSORY or ON/RUN/START, move the windshield wiper lever to select the wiper speed.

**HI:** Use for fast wipes.

**LO:** Use for slow wipes.



**INT (Intermittent Wipes/Rainsense Wipe Sensitivity Control):** Use for intermittent wipes. To adjust wiper frequency, turn the  INT band up for more frequent wipes or down for less frequent wipes. If the vehicle has Rainsense™, see the following Rainsense information.

**OFF:** Use to turn the wipers off.

**1X (Mist):** For a single wipe, briefly move the wiper lever down. For several wipes, hold the wiper lever down.

Clear snow and ice from the wiper blades before using them. If frozen to the windshield, carefully loosen or thaw them. Damaged blades should be replaced. See *Wiper Blade Replacement* on page 10-23.

Heavy snow or ice can overload the wiper motor.

## Wipe Parking

If the ignition is changed to STOPPING THE ENGINE/OFF mode while the wipers are on LO, HI, or INT, they will immediately stop.

If the windshield wiper lever is then moved to off before the driver door is opened or within 10 minutes, the wipers will restart and move to the base of the windshield.

If the ignition is changed to STOPPING THE ENGINE/OFF while the wipers are performing wipes due to windshield washing, the wipers continue to run until they reach the base of the windshield.

## Rainsense™

If equipped, there is a sensor near the top center of the windshield that detects the amount of water on the windshield and automatically controls the frequency of the windshield wiper.

## 5-4 Instruments and Controls

Keep this area of the windshield clear of debris to allow for best system performance.



### INT (Rainsense Wipe Sensitivity

**Control):** Move the windshield wiper lever to INT. Turn the  INT band on the wiper lever to adjust the sensitivity.

- Turn the band up for more sensitivity to moisture.
- Turn the band down for less sensitivity to moisture.
- Move the windshield wiper lever out of the INT position to deactivate Rainsense.

### Wiper Arm Assembly Protection

When using an automatic car wash, move the windshield wiper lever to OFF. This disables the automatic Rainsense windshield wipers and/or manual windshield wipers.

With Rainsense, if the transmission is in N (Neutral) and the vehicle speed is very slow, the wipers will automatically stop at the base of the windshield.

The wiper operations return to normal when the transmission is no longer in N (Neutral) or the vehicle speed has increased.

### Windshield Washer

Pull the windshield wiper lever toward you to spray windshield washer fluid and activate the wipers. The wipers will continue until the lever is released or the maximum wash time is reached. When the windshield wiper lever is released, additional wipes may occur depending on how long the windshield washer had been

activated. See *Washer Fluid* on page 10-18 for information on filling the windshield washer fluid reservoir.

### Warning

In freezing weather, do not use the washer until the windshield is warmed. Otherwise the washer fluid can form ice on the windshield, blocking your vision.

### Rear Window Wiper/Washer

The rear wiper controls are on the end of the windshield wiper lever.

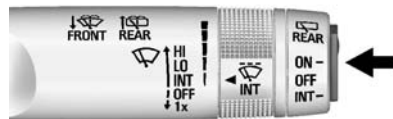

**ON:** Press the upper portion of the button for continuous rear window wipes.

**OFF:** The rear wiper turns off when the button is returned to the middle position.

**INT (Intermittent Rear Wipes):** Press the lower portion of the button to set a delay between wipes.

 **(Rear Washer):** Push the windshield wiper lever forward to spray washer fluid on the rear window. The lever automatically returns to its original position when released.

### Rear Wiper Arm Assembly Protection

When using an automatic car wash, move the rear wiper control to OFF. This disables the rear wiper.

If the transmission is in N (Neutral) and the vehicle speed is very slow, the rear wiper will automatically stop at the base of the rear window.

The wiper operations return to normal when the transmission is no longer in N (Neutral) or the vehicle speed has increased.

### Reverse Gear Wipes

If the rear wiper control is off, the rear wiper will automatically operate continuously when the shift lever is in R (Reverse), and the front windshield wiper is performing low or high speed wipes. If the rear wiper control is off, the shift lever is in R (Reverse), and the front windshield wiper is performing interval wipes, then the rear wiper automatically performs interval wipes.

This feature can be changed. See *Vehicle Personalization on page 5-39*.

The windshield washer reservoir is used for the windshield and the rear window. Check the fluid level in the reservoir if either washer is not working. See *Washer Fluid on page 10-18*.

## Compass

The vehicle may have a compass display on the Driver Information Center (DIC). The compass receives its heading and other information from the Global Positioning System (GPS) antenna, StabiliTrak<sup>®</sup>, and vehicle speed information.

The compass system is designed to operate for a certain number of miles or degrees of turn before needing a signal from the GPS satellites. When the compass display shows CAL, drive the vehicle for a short distance in an open area where it can receive a GPS signal. The compass system will automatically determine when a GPS signal is restored and provide a heading again. See *Compass Messages on page 5-29* for the messages that may be displayed for the compass.



## 5-6 Instruments and Controls

### Clock

The infotainment system controls are used to access the time and date settings through the menu system. See “Home Page” in the infotainment manual for information about how to use the menu system.

### Setting the Time

To set the time:

1. From the Home Page, press the SETTINGS screen button and press Time and Date.
2. Press Set Time and press + or – to increase or decrease hours, minutes, and AM or PM. Press 12Hr or 24Hr for 12 or 24 hour clock.
3. Press ◀ to go back to the previous menu.

If auto timing is set, the time displayed on the clock may not update immediately when driving into a new time zone.

To set the date:

1. Press the SETTINGS screen button and press Time and Date.
2. Press Set Date and press + or – to increase or decrease month, day, or year.
3. Press ◀ to go back to the previous menu.

### Power Outlets

The accessory power outlets can be used to plug in electrical equipment, such as a cell phone or MP3 player.

The vehicle may have five accessory power outlets.

The accessory power outlets are:

- Below the climate control system inside the front storage bin.
- Inside the center floor console.
- On the rear of the center floor console. For vehicles with a rear climate control system, there will

be two accessory power outlets on the rear of the center floor console.

- In the rear cargo area.

These are powered while the vehicle is in ON/RUN/START or ACC/ACCESSORY mode, or until the driver door is opened within 10 minutes of turning off the vehicle.

The power outlet located in the rear cargo area is powered at all times.

There is a small cap that must be removed to access the accessory power outlet. When not using the outlet be sure to cover it with the protective cap.

#### **Caution**

Leaving electrical equipment plugged in for an extended period of time while the vehicle is off will drain the battery. Power is always supplied to the rear cargo outlet. Always unplug electrical

(Continued)

**Caution (Continued)**

equipment when not in use and do not plug in equipment that exceeds the maximum 20 ampere rating.

Certain accessory power plugs may not be compatible with the accessory power outlet and could overload vehicle or adapter fuses. If a problem is experienced, see your dealer.

When adding electrical equipment, be sure to follow the proper installation instructions included with the equipment. See *Add-On Electrical Equipment on page 9-68*.

 **Caution**

Hanging heavy equipment from the power outlet can cause damage not covered by the vehicle warranty. The power  
(Continued)

**Caution (Continued)**

outlets are designed for accessory power plugs only, such as cell phone charge cords.

**Cigarette Lighter**

There may be a cigarette lighter under the climate control system, inside the front storage bin.

To activate the cigarette lighter, push it into the heating element and let go. The lighter pops out when it is ready to be used.

 **Caution**

Holding a cigarette lighter in while it is heating does not let the lighter back away from the heating element when it is hot. Damage from overheating can occur to the lighter or heating  
(Continued)

**Caution (Continued)**

element, or a fuse could be blown. Do not hold a cigarette lighter in while it is heating.

**Ashtrays**

There may be an ashtray under the climate control system on the center stack. Press the door to release the ashtray.

To empty the ashtray, remove it from the instrument panel by holding the edges and pulling straight out. To reinstall, push the tray back into place.

There may also be ashtrays on the center floor console behind the shift lever and in the rear doors.

 **Caution**

If papers, pins, or other flammable items are put in the ashtray, hot cigarettes or other smoking materials could ignite them and possibly damage the vehicle. Never put flammable items in the ashtray.

### **Warning Lights, Gauges, and Indicators**

Warning lights and gauges can signal that something is wrong before it becomes serious enough to cause an expensive repair or replacement. Paying attention to the warning lights and gauges could prevent injury.

Warning lights come on when there could be a problem with a vehicle function. Some warning lights come on briefly when the engine is started to indicate they are working.

Gauges can indicate when there could be a problem with a vehicle function. Often gauges and warning lights work together to indicate a problem with the vehicle.

When one of the warning lights comes on and stays on while driving, or when one of the gauges shows there may be a problem, check the section that explains what to do. Waiting to do repairs can be costly and even dangerous.

## Instrument Cluster

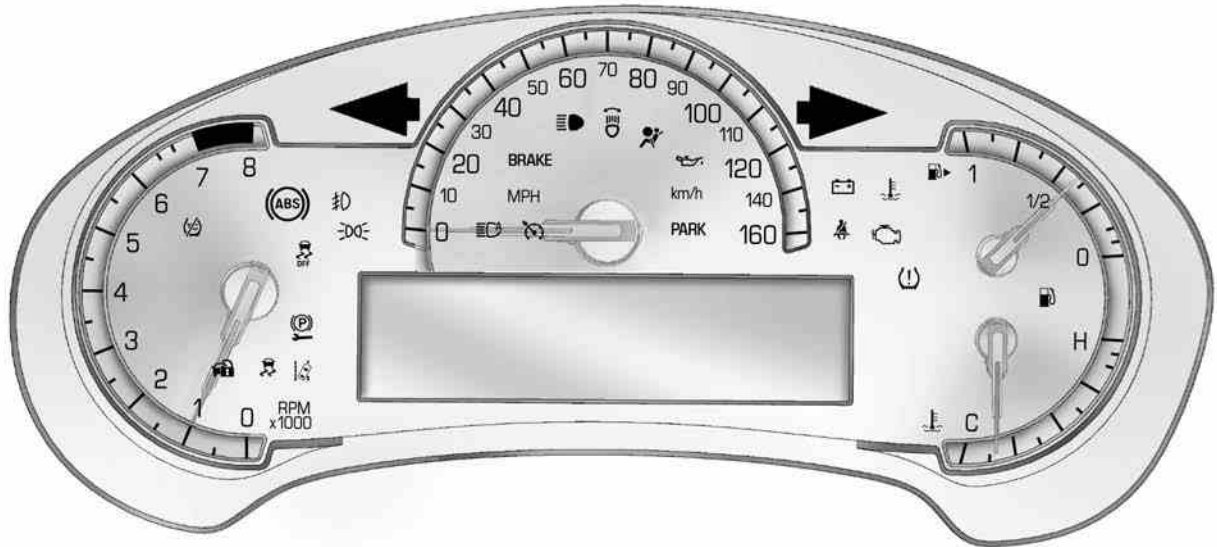

English Shown, Metric Similar

## 5-10 Instruments and Controls

---

### Cluster Application Displays

The cluster has three interactive display zones.

Use the five-way control on the right steering wheel control to move between the different display zones and scroll through the different displays.

The left and right zones display Driver Information Center (DIC) information. See *Driver Information Center (DIC)* on page 5-25.

The center zone displays application information for navigation, audio, phone, or settings. A speedometer can also be displayed in this center zone.

### Navigation

If there is no active route, a compass will be displayed. If there is an active route, press SEL to end route guidance or turn the voice prompts on or off.

### Audio

While the Audio application page is displayed, press SEL to enter the Audio menu. In the Audio menu search for music, select from favorites, or change the audio source.

### Phone

While the Phone application page is displayed, press SEL to enter the Phone menu. In the Phone menu, if there is no active phone call, view recent calls, select from favorites, or scroll through contacts. If there is an active call, mute the phone or switch to handset operation.

### Settings

Press SEL while the Settings application page is displayed to enter the Settings menu.

**Units:** Press SEL while Units is highlighted to enter the Units menu. Choose English or metric units by pressing SEL while the desired item is highlighted. A checkmark will be displayed next to the selected item.

**Info Pages:** Press SEL while Info Pages is highlighted to select the items to be displayed in the DIC information displays. See *Driver Information Center (DIC)* on page 5-25.

**Open Source Software:** Press SEL while Open Source Software is highlighted to display open source software information.

### Speedometer

The speedometer shows the vehicle's speed in either kilometers per hour (km/h) or miles per hour (mph).

### Odometer

The odometer shows how far the vehicle has been driven, in either kilometers or miles.

### Trip Odometer

The trip odometer shows how far the vehicle has been driven since the trip odometer was last reset.

The trip odometer is accessed and reset through the Driver Information Center (DIC). See *Driver Information Center (DIC)* on page 5-25.

## Tachometer

The tachometer displays the engine speed in revolutions per minute (rpm).

### Caution

If the engine is operated with the rpm's in the warning area at the high end of the tachometer, the vehicle could be damaged, and the damage would not be covered by the vehicle warranty. Do not operate the engine with the rpm's in the warning area.

## Fuel Gauge

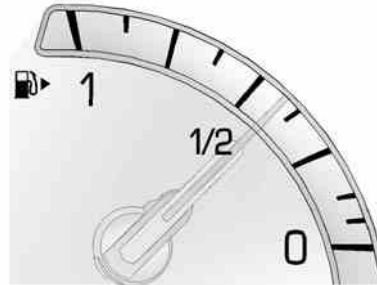

When the ignition is on, the fuel gauge indicates about how much fuel is left in the tank.

There is an arrow near the fuel gauge pointing to the side of the vehicle the fuel door is on.

When the indicator nears empty, the low fuel light comes on. There still is a little fuel left, but the vehicle should be refueled soon.

Here are four things that some owners ask about. None of these show a problem with the fuel gauge:

- At the service station, the fuel pump shuts off before the gauge reads full.
- It takes a little more or less fuel to fill up than the gauge indicated. For example, the gauge may have indicated the tank was half full, but it actually took a little more or less than half the tank's capacity to fill the tank.
- The gauge moves a little while turning a corner or speeding up.
- The gauge takes a few seconds to stabilize after the ignition is turned on, and goes back to empty when the ignition is turned off.

## Engine Coolant Temperature Gauge



Metric

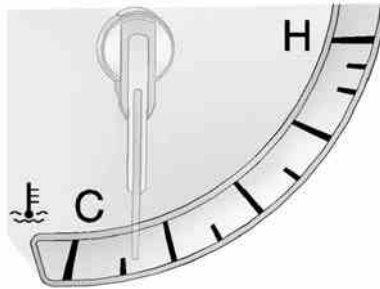

English

This gauge measures the temperature of the vehicle's engine.

While driving under normal operating conditions, if the needle moves into the shaded area, the engine is too hot. Pull off the road, stop the vehicle, and turn off the engine as soon as possible.

## Safety Belt Reminders

### Driver Safety Belt Reminder Light

There is a driver safety belt reminder light on the instrument cluster.



When the vehicle is started this light flashes and a chime comes on to remind drivers to fasten their safety belt. Then the light stays on solid until the belt is buckled. This cycle may continue several times if the driver remains or becomes unbuckled while the vehicle is moving.

If the driver safety belt is buckled, neither the light nor chime comes on.

## Passenger Safety Belt Reminder Light

There is a passenger safety belt reminder light near the passenger airbag status indicator. See *Passenger Sensing System* on page 3-26.



When the vehicle is started this light flashes and a chime may come on to remind the front passenger to fasten their safety belt. Then the light stays on solid until the belt is buckled. This cycle may continue several times if the passenger remains or becomes unbuckled while the vehicle is moving.

If the front passenger safety belt is buckled, neither the chime nor the light comes on.

The front passenger safety belt reminder light and chime may turn on if an object is put on the seat such as a briefcase, handbag, grocery bag, laptop, or other electronic device. To turn off the reminder light and/or chime, remove the object from the seat or buckle the safety belt.

## Second Row Passenger Belt Reminder Light



Second row seating positions monitored for safety belt use are represented by a colored symbol in the Driver Information Center (DIC) indicating safety belt status. When the vehicle is started, three safety belt symbols come on and stay on for several seconds in the instrument cluster to alert the driver

that passengers may need to fasten their safety belts. After the passenger safety belt is buckled, the corresponding safety belt symbol in the instrument cluster turns green. If a safety belt is not initially buckled, the instrument cluster displays a gray safety belt symbol. While the vehicle is moving, if a second row passenger that was previously buckled becomes unbuckled, the corresponding safety belt symbol will change to flashing red and a chime may sound.

## Airbag Readiness Light

This light shows if there is an electrical problem with the airbag system. The system check includes the airbag sensor(s), passenger sensing system, the pretensioners, the airbag modules, the wiring, and the crash sensing and diagnostic module. For more information on the airbag system, see *Airbag System* on page 3-20.





The airbag readiness light comes on for several seconds when the vehicle is started. If the light does not come on then, have it fixed immediately.

### **Warning**

If the airbag readiness light stays on after the vehicle is started or comes on while driving, it means the airbag system might not be working properly. The airbags in the vehicle might not inflate in a crash, or they could even inflate without a crash. To help avoid injury, have the vehicle serviced right away.

If there is a problem with the airbag system, a Driver Information Center (DIC) message may also come on. See *Airbag System Messages* on page 5-36.

### **Passenger Airbag Status Indicator**

The vehicle has a passenger sensing system. See *Passenger Sensing System* on page 3-26 for important safety information. The overhead console has a passenger airbag status indicator.



#### **United States**



#### **Canada and Mexico**

When the vehicle is started, the passenger airbag status indicator will light ON and OFF, or the symbol for on and off, for several seconds as a system check. Then, after several more seconds, the status indicator will light either ON or OFF, or either the on or off symbol to let you know the status of the front outboard passenger frontal airbag.

If the word ON or the on symbol is lit on the passenger airbag status indicator, it means that the front outboard passenger frontal airbag is allowed to inflate.

If the word OFF or the off symbol is lit on the passenger airbag status indicator, it means that the passenger sensing system has turned off the front outboard passenger frontal airbag.

If, after several seconds, both status indicator lights remain on, or if there are no lights at all, there may be a problem with the lights or the passenger sensing system. See your dealer for service.

### Warning

If the airbag readiness light ever comes on and stays on, it means that something may be wrong with the airbag system. To help avoid injury to yourself or others, have the vehicle serviced right

(Continued)

### Warning (Continued)

away. See *Airbag Readiness Light* on page 5-13 for more information, including important safety information.

## Charging System Light



The charging system light comes on briefly when the ignition is turned on, but the engine is not running, as a check to show the light is working. It should go out when the engine is started.

If the light stays on, or comes on while driving, there may be a problem with the electrical charging

system. Have it checked by your dealer. Driving while this light is on could drain the battery.

When this light comes on, or is flashing, the Driver Information Center (DIC) also displays a message.

See *Battery Voltage and Charging Messages* on page 5-28.

If a short distance must be driven with the light on, be sure to turn off all accessories, such as the radio and air conditioner.

## Malfunction Indicator Lamp

A computer system called OBD II (On-Board Diagnostics-Second Generation) monitors the operation of the vehicle to ensure emissions are at acceptable levels, helping to maintain a clean environment. The malfunction indicator lamp comes on when the vehicle is placed in ON/RUN for Key Access or Service Only Mode for Keyless Access, as a

## 5-16 Instruments and Controls

check to show it is working. If it does not, have the vehicle serviced by your dealer. See *Ignition Positions* on page 9-15 for more information.



If the malfunction indicator lamp comes on while the engine is running, this indicates that the OBD II system has detected a problem and diagnosis and service might be required.

Malfunctions often are indicated by the system before any problem is apparent. Being aware of the light can prevent more serious damage to the vehicle. This system also assists the dealer technician in correctly diagnosing any malfunction.

### **Caution**

If the vehicle is continually driven with this light on, the emission controls might not work as well, the vehicle fuel economy might not be as good, and the engine might not run as smoothly. This could lead to costly repairs that might not be covered by the vehicle warranty.

### **Caution**

Modifications made to the engine, transmission, exhaust, intake, or fuel system of the vehicle or the replacement of the original tires with other than those of the same Tire Performance Criteria (TPC) can affect the vehicle's emission controls and can cause this light to come on.

Modifications to these systems

(Continued)

### **Caution (Continued)**

could lead to costly repairs not covered by the vehicle warranty. This could also result in a failure to pass a required Emission Inspection/Maintenance test. See *Accessories and Modifications* on page 10-3.

This light comes on during a malfunction in one of two ways:

**Light Flashing:** A misfire condition has been detected. A misfire increases vehicle emissions and could damage the emission control system on the vehicle. Diagnosis and service might be required.

To prevent more serious damage to the vehicle:

- Reduce vehicle speed.
- Avoid hard accelerations.
- Avoid steep uphill grades.

If the light continues to flash, find a safe place to stop and park the vehicle. Turn the vehicle off, wait at least 10 seconds, and restart the engine. If the light is still flashing, follow the previous steps and see your dealer for service as soon as possible.

**Light On Steady:** An emission control system malfunction has been detected on the vehicle. Diagnosis and service might be required.

The following may correct an emission control system malfunction:

- Check that the fuel cap is fully installed. See *Filling the Tank on page 9-58*. The diagnostic system can determine if the fuel cap has been left off or improperly installed. A loose or missing fuel cap allows fuel to evaporate into the atmosphere. A few driving trips with the cap properly installed should turn the light off.

- Check that good quality fuel is used. Poor fuel quality causes the engine not to run as efficiently as designed and may cause stalling after start-up, stalling when the vehicle is changed into gear, misfiring, hesitation on acceleration, or stumbling on acceleration. These conditions might go away once the engine is warmed up.

If one or more of these conditions occurs, change the fuel brand used. It may require at least one full tank of the proper fuel to turn the light off.

See *Fuel on page 9-56*.

If none of the above have made the light turn off, your dealer can check the vehicle. The dealer has the proper test equipment and diagnostic tools to fix any mechanical or electrical problems that might have developed.

## Emissions Inspection and Maintenance Programs

Depending on where you live, your vehicle may be required to participate in an emission control system inspection and maintenance program. For the inspection, the emission system test equipment will likely connect to the vehicle's Data Link Connector (DLC).

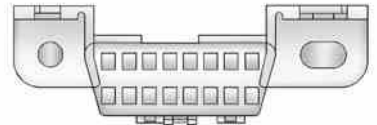

The DLC is under the instrument panel next to the steering wheel. See your dealer if assistance is needed.

The vehicle may not pass inspection if:

- The malfunction indicator lamp is on while the engine is running, or the malfunction indicator lamp

is not on while the vehicle is in ON/RUN or Service Only Mode. See your dealer for assistance in verifying proper operation of the malfunction indicator lamp.

- The OBD II (On-Board Diagnostics) system determines that critical emission control systems have not been completely diagnosed by the system. If this were to occur, the vehicle would be considered not ready for inspection. This can happen if the 12-volt battery has recently been replaced or run down.

The diagnostic system is designed to evaluate critical emission control systems during normal driving. This can take several days of driving. If this has been done and the vehicle still does not pass the inspection for lack of OBD II system readiness, your dealer can prepare the vehicle for inspection.

### Brake System Warning Light

The vehicle brake system consists of two hydraulic circuits. If one circuit is not working, the remaining circuit can still work to stop the vehicle. For normal braking performance, both circuits need to be working.

If the warning light comes on, there is a brake problem. Have the brake system inspected right away.



**Metric**

**BRAKE**

**English**

This light comes on briefly when the vehicle is turned on. If it does not come on then, have it fixed so it will be ready to warn if there is a problem.

If the light comes on and stays on, there is a base brake problem.

### **Warning**

The brake system might not be working properly if the brake system warning light is on. Driving with the brake system warning light on can lead to a crash. If the light is still on after the vehicle has been pulled off the road and carefully stopped, have the vehicle towed for service.

### Electric Parking Brake Light



**Metric**

**PARK**

**English**

This light comes on when the parking brake is applied. If the light continues flashing after the parking

brake is released, or while driving, there is a problem with the Electric Parking Brake system or another system. A message may also display in the Driver Information Center (DIC). See *Brake System Messages on page 5-28*.

If the light does not come on, or remains flashing, see your dealer.

## Service Electric Parking Brake Light



This light should come on briefly when starting the vehicle. If it does not come on, have it fixed so it will be ready to warn if there is a problem.

If this light stays on, there is a problem with the Electric Parking Brake system or another system on

the vehicle that is causing the parking brake system to work at a reduced level. The vehicle can still be driven, but should be taken to a dealer as soon as possible. See the information for the Electric Parking Brake under *Parking Brake on page 9-27*. If a message displays in the Driver Information Center (DIC), see *Brake System Messages on page 5-28*.

## Antilock Brake System (ABS) Warning Light



This light comes on briefly when the engine is started.

If the light does not come on, have it fixed so it will be ready to warn if there is a problem.

If the light comes on while driving, stop as soon as it is safely possible and turn off the vehicle. Then start the engine again to reset the system. If the ABS light stays on, or comes on again while driving, the vehicle needs service. A chime may also sound when the light comes on steady.

If the ABS light is the only light on, the vehicle has regular brakes, but the antilock brakes are not functioning.

If both the ABS and the brake system warning light are on, the vehicle's antilock brakes are not functioning and there is a problem with the regular brakes. See your dealer for service.

See *Brake System Warning Light on page 5-18* and *Brake System Messages on page 5-28*.

## Lane Departure Warning (LDW) Light



If equipped, this light comes on briefly while starting the vehicle.

If it does not come on, have the vehicle serviced.

This light is green if LDW is on and ready to operate.

This light changes to amber and flashes to indicate that the lane marking has been crossed without using a turn signal in that direction.

See *Lane Departure Warning (LDW)* on page 9-54.

## Vehicle Ahead Indicator



If equipped, this indicator will display green when a vehicle is detected ahead and amber when you are following a vehicle ahead much too closely.

See *Forward Collision Alert (FCA) System* on page 9-48.

## Traction Off Light



This light comes on briefly while starting the engine. If it does not, have the vehicle serviced by your

dealer. If the system is working normally, the indicator light then turns off.

The traction off light comes on when the Traction Control System (TCS) has been turned off by pressing and releasing the TCS/StabiliTrak button.

This light and the StabiliTrak OFF light come on when StabiliTrak is turned off.

If the TCS is off, wheel spin is not limited. Adjust driving accordingly.

See *Traction Control/Electronic Stability Control* on page 9-30.

## StabiliTrak<sup>®</sup> OFF Light



This light comes on briefly while starting the engine. If it does not, have the vehicle serviced by your dealer.

This light comes on when the StabiliTrak system is turned off. If StabiliTrak is off, the Traction Control System (TCS) is also off.

If the StabiliTrak and TCS are off, the system does not assist in controlling the vehicle. Turn on the TCS and the StabiliTrak systems and the warning light turns off.

See *Traction Control/Electronic Stability Control on page 9-30*.

## Traction Control System (TCS)/StabiliTrak<sup>®</sup> Light



This light comes on briefly when the engine is started.

If the light does not come on, have the vehicle serviced by your dealer. If the system is working normally, the indicator light turns off.

If the light is on and not flashing, the TCS and potentially the StabiliTrak system have been disabled. A DIC message may display. Check the DIC messages to determine which feature(s) is no longer functioning and whether the vehicle requires service.

If the indicator/warning light is on and flashing, the TCS and/or the StabiliTrak system is actively working.

See *Traction Control/Electronic Stability Control on page 9-30*.

## Engine Coolant Temperature Warning Light



This light comes on briefly while starting the vehicle.

If it does not, have the vehicle serviced by your dealer. If the system is working normally the indicator light goes off.

### Caution

The engine coolant temperature warning light indicates that the vehicle has overheated. Driving with this light on can damage the engine and it may not be covered

(Continued)



### Caution (Continued)

by the vehicle warranty. See *Engine Overheating on page 10-16*.

The engine coolant temperature warning light comes on when the engine has overheated.

If this happens, pull over and turn off the engine as soon as possible. See *Engine Overheating on page 10-16*.

### Tire Pressure Light



For vehicles with the Tire Pressure Monitor System (TPMS), this light comes on briefly when the engine is started. It provides information about tire pressures and the TPMS.

#### When the Light Is On Steady

This indicates that one or more of the tires are significantly underinflated.

A Driver Information Center (DIC) tire pressure message may also display. See *Tire Messages on page 5-37*. Stop as soon as possible, and inflate the tires to the pressure value shown on the Tire and Loading Information label. See *Tire Pressure on page 10-48*.

#### When the Light Flashes First and Then Is On Steady

If the light flashes for about a minute and then stays on, there may be a problem with the TPMS. If the problem is not corrected, the light will come on at every ignition cycle. See *Tire Pressure Monitor Operation on page 10-51*.

### Engine Oil Pressure Light

#### Caution

Lack of proper engine oil maintenance can damage the engine. Driving with the engine oil low can also damage the engine. The repairs would not be covered by the vehicle warranty. Check the oil level as soon as possible. Add oil if required, but if the oil level is within the operating range and the oil pressure is still low, have the vehicle serviced. Always follow the maintenance schedule for changing engine oil.



This light should come on briefly as the engine is started. If it does not come on, have the vehicle serviced by your dealer.

If the light comes on and stays on, it means that oil is not flowing through the engine properly. The vehicle could be low on oil and might have some other system problem. See your dealer.

## Fuel Economy Light

eco

This light is in the Driver Information Center (DIC) display.

For vehicles with the fuel economy mode light, it comes on when the eco (economy) button, located next to the shift lever, is pressed. Press the button again to turn off the light and exit the fuel economy mode.

See *Driving for Better Fuel Economy on page 1-20* and *Fuel Economy Mode on page 9-25* for more information.

## Low Fuel Warning Light



This light is near the fuel gauge and comes on briefly when the ignition is turned on as a check to show it is working.

It also comes on when the fuel tank is low on fuel. The light turns off when fuel is added. If it does not, have the vehicle serviced.

## Security Light



The security light should come on briefly as the engine is started. If it does not come on, have the vehicle serviced by your dealer. If the system is working normally, the indicator light turns off.

If the light stays on and the engine does not start, there could be a problem with the theft-deterrent system. See *Immobilizer Operation on page 2-19*.

### High-Beam On Light



This light comes on when the high-beam headlamps are in use.

See *Headlamp High/Low-Beam Changer* on page 6-3.

### IntelliBeam® Light



This light comes on when the IntelliBeam system, if equipped, is enabled.

See *Exterior Lamp Controls* on page 6-1.

### Adaptive Forward Lighting (AFL) Light



This light should come on briefly as the vehicle is started. If it does not come on, have the vehicle serviced by your dealer.

This light comes on solid when there is a problem with the AFL system. It flashes when the system is switching between lighting modes. See *Adaptive Forward Lighting (AFL)* on page 6-4.

### Front Fog Lamp Light



The fog lamp light comes on when the fog lamps are in use.

The light goes out when the fog lamps are turned off. See *Front Fog Lamps* on page 6-6 for more information.

### Lamps On Reminder



This light comes on when the exterior lamps are in use. See *Exterior Lamp Controls* on page 6-1.

## Cruise Control Light



The cruise control light is white when the cruise control is on and ready, and turns green when the cruise control is set and active.

See *Cruise Control* on page 9-33.

## Adaptive Cruise Control Light



This light in the Driver Information Center (DIC) comes on when the Adaptive Cruise Control (if equipped) is active. See *Adaptive Cruise Control* on page 9-35.

## Information Displays

### Driver Information Center (DIC)

The DIC displays are shown in the left and right interactive display zones on the instrument cluster. The displays show the status of many vehicle systems. The controls for the DIC are on the right steering wheel control.

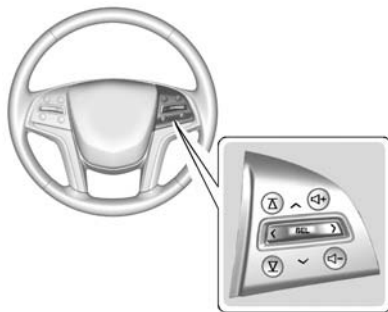

**^ or v** : Press the five-way control to move up or down in a list.

**< or >** : Press the five-way control to move between the interactive display zones in the cluster. Press **<** to go back to the previous menu.

**SEL (Select)**: Press the center to open a menu or select a menu item. Press and hold to reset values on certain screens.

### DIC Information Display Options

The information displays on the DIC can be turned on or off through the Settings menu.

1. Press SEL while viewing the Settings page in the center display zone on the cluster.
2. Scroll to Info Pages and press SEL.
3. Press **^** or **v** to move through the list of possible information displays.

## 5-26 Instruments and Controls

---

4. Press SEL while an item is highlighted to select or deselect that item. When an item is selected, a checkmark will appear next to it.

### DIC Information Displays

The following is the list of all possible DIC information displays. Some of the information displays may not be available for your particular vehicle.

**Speed:** Shows the vehicle speed in either kilometers per hour (km/h) or miles per hour (mph).

**Trip 1 and Trip 2:** Shows the current distance traveled, in either kilometers (km) or miles (mi), since the trip odometer was last reset. The trip odometer can be reset by pressing and holding SEL while this display is active.

**Fuel Range:** Shows the approximate distance the vehicle can be driven without refueling. LOW will be displayed when the vehicle is low on fuel. The fuel

range estimate is based on an average of the vehicle's fuel economy over recent driving history and the amount of fuel remaining in the fuel tank.

**Average Fuel Economy:** Shows the approximate average liters per 100 kilometers (L/100 km) or miles per gallon (mpg). This number is calculated based on the number of L/100 km (mpg) recorded since the last time this menu item was reset. This number reflects only the approximate average fuel economy that the vehicle has right now, and will change as driving conditions change. The Average Fuel Economy can be reset by pressing and holding SEL while this display is active.

**Instantaneous Fuel Economy:** Shows the current fuel economy in either liters per 100 kilometers (L/100 km) or miles per gallon (mpg). This number reflects only the approximate fuel economy

that the vehicle has right now and changes frequently as driving conditions change.

**Average Speed:** Shows the average speed of the vehicle in kilometers per hour (km/h) or miles per hour (mph). This average is calculated based on the various vehicle speeds recorded since the last reset of this value. The average speed can be reset by pressing and holding SEL while this display is active.

**Timer:** This display can be used as a timer. To start the timer, press SEL while this display is active. The display will show the amount of time that has passed since the timer was last reset. To stop the timer, press SEL briefly while this display is active and the timer is running. To reset the timer to zero, press and hold SEL while this display is active.

**Compass:** Shows the direction the vehicle is driving.

**Turn Arrow:** Shows the next maneuver when using route guidance.

**Travel Time:** Shows the estimated time duration remaining for the current route.

**Distance to Destination:** Shows the distance to the destination when using route guidance.

**Speed Limit:** Shows sign information, which comes from a roadway database in the onboard navigation.

**Speed Warning:** Allows the driver to set a speed that they do not want to exceed. To set the Speed Warning, press SEL when Speed Warning is displayed. Press  $\wedge$  or  $\vee$  to adjust the value. This feature can be turned off by pressing and holding SEL while viewing this page. If the selected speed limit is exceeded, a pop-up warning is displayed with a chime.

**Cruise Set Speed:** Shows the speed the cruise control or Adaptive Cruise Control is set to.

**Follow Distance:** Shows the current following distance to the vehicle ahead.

**Battery Voltage:** Shows the current battery voltage.

**Oil Life:** Shows an estimate of the oil's remaining useful life. If REMAINING OIL LIFE 99% is displayed, that means 99% of the current oil life remains.

When the remaining oil life is low, the CHANGE ENGINE OIL SOON message will appear on the display. See *Engine Oil Messages on page 5-31*. The oil should be changed as soon as possible. See *Engine Oil on page 10-7*. In addition to the engine oil life system monitoring the oil life, additional maintenance is recommended in the Maintenance Schedule. See *Maintenance Schedule on page 11-3*.

The Oil Life display must be reset after each oil change. It will not reset itself. Do not to reset the Oil Life display accidentally at any time other than when the oil has just been changed. It cannot be reset accurately until the next oil change. To reset the engine oil life system, press and hold SEL for several seconds while the Oil Life display is active. See *Engine Oil Life System on page 10-9*.

**Tire Pressure:** Shows the approximate pressures of all four tires. Tire pressure is displayed in either kilopascal (kPa) or in pounds per square inch (psi). If the pressure is low, the value for that tire is shown in amber. See *Tire Pressure Monitor System on page 10-50* and *Tire Pressure Monitor Operation on page 10-51*.

**Blank Page:** Allows for no information to be displayed in the DIC display zone(s).

## Vehicle Messages

Messages displayed on the DIC indicate the status of the vehicle or some action that may be needed to correct a condition. Multiple messages may display one after the other.

The messages that do not require immediate action can be acknowledged and cleared by pressing SET/CLR. The messages that require immediate action cannot be cleared until that action is performed. All messages should be taken seriously and clearing the messages does not correct the problem.

The following are some of the vehicle messages that may be displayed depending on your vehicle content.

## Battery Voltage and Charging Messages

### BATTERY SAVER ACTIVE

This message displays when the vehicle has detected that the battery voltage is dropping beyond a reasonable point. The battery saver system starts reducing features of the vehicle that may be noticed. At the point that features are disabled, this message displays. Turn off unnecessary accessories to allow the battery to recharge.

### LOW BATTERY

This message is displayed when the battery voltage is low. See *Battery on page 10-21*.

### SERVICE BATTERY CHARGING SYSTEM

This message is displayed when there is a fault in the battery charging system. Take the vehicle to your dealer for service.

## TRANSPORT MODE ON

This message is displayed when the vehicle is in transport mode. Some features can be disabled while in this mode, including Remote Keyless Entry (RKE), remote start, and the vehicle alarm system. Take the vehicle to your dealer for service to turn transport mode off.

## Brake System Messages

### BRAKE FLUID LOW

This message is displayed when the brake fluid level is low. See *Brake Fluid on page 10-20*.

### STEP ON BRAKE TO RELEASE PARK BRAKE

This message is displayed if you attempt to release the Electric Parking Brake without the brake pedal applied. See *Parking Brake on page 9-27*.

**RELEASE PARKING BRAKE**

This message is displayed if the Electric Parking Brake is on while the vehicle is in motion. See *Parking Brake on page 9-27*.

**SERVICE BRAKE ASSIST**

This message may be displayed when there is a problem with the brake boost assist system. When this message is displayed, the brake boost assist motor might be heard operating and you might notice pulsation in the brake pedal. This is normal under these conditions. Take the vehicle to your dealer for service.

**SERVICE PARKING BRAKE**

This message is displayed when there is a problem with the parking brake. Take the vehicle to your dealer for service.

**Compass Messages****CAL**

This message is displayed when the compass needs to be calibrated. See *Compass on page 5-5*.

--

Dashes will be displayed if the compass needs service. See your dealer for service.

**Cruise Control Messages****ADAPTIVE CRUISE SET TO XXX**

This message displays when the Adaptive Cruise Control (ACC) speed is set. See *Adaptive Cruise Control on page 9-35*.

**ADAPTIVE CRUISE TEMPORARILY UNAVAILABLE**

This message displays when attempting to activate Adaptive Cruise Control (ACC) when it is temporarily unavailable. The ACC system does not need service.

This can occur under the following conditions:

- The radar is not clean. Keep the radar sensors free of mud, dirt, snow, ice, and slush. Clean the entire front and/or rear of the vehicle. For cleaning instructions, see *Exterior Care on page 10-85*.
- Heavy rain or snow is interfering with the radar object detection or camera performance.

**CRUISE SET TO XXX**

This message displays when the cruise control speed is set. See *Cruise Control on page 9-33*.



**NO CRUISE BRAKING GAS  
PEDAL APPLIED**

This message displays when Adaptive Cruise Control (ACC) is active and the driver is pressing the gas pedal. When this occurs, ACC will not brake. See *Adaptive Cruise Control* on page 9-35.

**SERVICE ADAPTIVE CRUISE  
CONTROL**

This message displays when the Adaptive Cruise Control (ACC) needs service. Take the vehicle to your dealer.

**SHIFT TO PARK BEFORE  
EXITING**

This message may display if Adaptive Cruise Control (ACC) is engaged holding the vehicle at a stop, and the driver attempts to exit the vehicle. Put the vehicle in P (Park) before exiting.

**Door Ajar Messages**

**DOOR OPEN**

A door open symbol will be displayed on the DIC showing which door is open. If the vehicle has been shifted out of P (Park), a DOOR OPEN message will also be displayed. Close the door completely.

**HOOD OPEN**

This message will display along with a hood open symbol when the hood is open. Close the hood completely.

**REAR ACCESS OPEN**

This message will display along with a symbol when the liftgate is open. Close the liftgate completely.

**Engine Cooling System  
Messages**

**A/C OFF DUE TO HIGH  
ENGINE TEMP**

This message displays when the engine coolant becomes hotter than the normal operating temperature. To avoid added strain on a hot engine, the air conditioning compressor automatically turns off. When the coolant temperature returns to normal, the air conditioning compressor turns back on. The vehicle can continue to be driven.

If this message continues to appear, have the system repaired by your dealer as soon as possible to avoid damage to the engine.

**ENGINE OVERHEATED —  
IDLE ENGINE**

This message displays when the engine coolant temperature is too hot. Stop and allow the vehicle to idle until it cools down.

## **ENGINE OVERHEATED — STOP ENGINE**

This message displays and a continuous chime sounds if the engine cooling system reaches unsafe temperatures for operation. Stop and turn off the vehicle as soon as it is safe to do so to avoid severe damage. This message clears when the engine has cooled to a safe operating temperature.

## **HIGH COOLANT TEMPERATURE**

This message displays if the coolant temperature is hot. See *Engine Overheating on page 10-16*.

## **Engine Oil Messages**

### **CHANGE ENGINE OIL SOON**

This message displays when the engine oil needs to be changed. When you change the engine oil, be sure to reset the oil life system. See *Engine Oil Life System on page 10-9, Driver Information*

*Center (DIC) on page 11-3, Engine Oil on page 10-7, and Maintenance Schedule on page 11-3.*

### **ENGINE OIL HOT, IDLE ENGINE**

This message displays when the engine oil temperature is too hot. Stop and allow the vehicle to idle until it cools down.

### **ENGINE OIL LOW — ADD OIL**

On some vehicles, this message displays when the engine oil level may be too low. Check the oil level before filling to the recommended level. If the oil is not low and this message remains on, take the vehicle to your dealer for service. See *Engine Oil on page 10-7*.

### **OIL PRESSURE LOW — STOP ENGINE**

This message displays if low oil pressure levels occur. Stop the vehicle as soon as safely possible and do not operate it until the cause of the low oil pressure has been

corrected. Check the oil as soon as possible and have the vehicle serviced by your dealer.

## **Engine Power Messages**

### **ENGINE POWER IS REDUCED**

This message displays when the vehicle's engine power is reduced. Reduced engine power can affect the vehicle's ability to accelerate. If this message is on, but there is no reduction in performance, proceed to your destination. The performance may be reduced the next time the vehicle is driven. The vehicle may be driven at a reduced speed while this message is on, but maximum acceleration and speed may be reduced. Anytime this message stays on, the vehicle should be taken to your dealer for service as soon as possible.

### Fuel System Messages

#### FUEL LEVEL LOW

This message displays when the vehicle is low on fuel. Refuel as soon as possible.

#### TIGHTEN GAS CAP

This message displays when the fuel cap is not on tight. Tighten the fuel cap.

### Key and Lock Messages

#### NO REMOTE DETECTED

This message displays when the transmitter battery may be weak. See “Starting the Vehicle with a Low Transmitter Battery” under *Remote Keyless Entry (RKE) System Operation on page 2-3*.

#### NO REMOTE KEY WAS DETECTED PLACE KEY IN TRANSMITTER POCKET THEN START YOUR VEHICLE

This message displays when trying to start the vehicle if an RKE transmitter is not detected. The transmitter battery may be weak. See “Starting the Vehicle with a Low Transmitter Battery” under *Remote Keyless Entry (RKE) System Operation on page 2-3*.

#### NO REMOTE PRESS BRAKE TO RESTART

This message is displayed if the remote is no longer detected in the vehicle. Press the brake pedal to restart the vehicle.

#### NUMBER OF KEYS PROGRAMMED

This message displays when programming new keys to the vehicle.

#### REMOTE LEFT IN VEHICLE

This message displays when leaving the vehicle with the RKE transmitter still inside.

#### REPLACE BATTERY IN REMOTE KEY

This message displays when the battery in the RKE transmitter needs to be replaced.

### Lamp Messages

#### AFL (ADAPTIVE FORWARD LIGHTING) LAMPS NEED SERVICE

This message displays when the AFL system is disabled and needs service. See your dealer. See *Adaptive Forward Lighting (AFL) on page 6-4*.

**AUTOMATIC LIGHT CONTROL ON**

This message is displayed when the exterior lamp control is in AUTO and the lights have turned on. See *Twilight Sentinel* on page 6-5.

**AUTOMATIC LIGHT CONTROL OFF**

This message is displayed when the exterior lamp control is in AUTO and the lights have turned off. See *Twilight Sentinel* on page 6-5.

**XXX TURN INDICATOR FAILURE**

When one of the turn signals is out, this message displays to show which bulb needs to be replaced. See *Bulb Replacement* on page 10-25 and *Replacement Bulbs* on page 10-32.

**TURN SIGNAL ON**

This message is displayed if the turn signal has been left on. Turn off the turn signal.

**Object Detection System Messages****24 GHz RADARS OFF**

This message displays when driving in certain areas where there may be radar interference. Adaptive Cruise Control (ACC), Forward Collision Alert (FCA), and the Active Emergency Braking System may not work or may not work as well. The vehicle does not need service.

**AUTOMATIC COLLISION PREP OFF**

This message displays when the Active Emergency Braking System has been turned off. See *Active Emergency Braking System* on page 9-51.

**AUTOMATIC COLLISION PREP REDUCED**

This message displays when the Active Emergency Braking System has been set to the Alert setting. This setting disables most automatic

braking functions of the Auto Collision Preparation feature. Some last-second automatic braking capability is still provided with the Alert setting, but braking is less likely to occur. See *Active Emergency Braking System* on page 9-51.

**AUTOMATIC COLLISION PREP UNAVAILABLE**

This message displays when the Active Emergency Braking System has been unavailable for some time. The Active Emergency Braking System does not need service.

This can occur under the following conditions:

- The radar is not clean. Keep the radar sensors free of mud, dirt, snow, ice, and slush. Clean the entire front and/or rear of the vehicle. For cleaning instructions, see *Exterior Care* on page 10-85.

## 5-34 Instruments and Controls

---

- Heavy rain or snow is interfering with the radar object detection or camera performance.

This message may also be displayed if there is a problem with the StabiliTrak system.

### **FORWARD COLLISION ALERT OFF**

This message displays when the Forward Collision Alert has been turned off.

### **FRONT CAMERA BLOCKED CLEAN WINDSHIELD**

This message displays when the camera is blocked. Cleaning the outside of the windshield behind the rearview mirror may correct the issue. The Lane Departure Warning (LDW) system will not operate. Adaptive Cruise Control (ACC), Forward Collision Alert (FCA), and the Active Emergency Braking System may not work or may not work as well.

### **LANE DEPARTURE WARNING UNAVAILABLE**

This message displays when attempting to activate the Lane Departure Warning (LDW) system when it is temporarily unavailable. The LDW system does not need service.

This message could be due to the camera being blocked. Cleaning the outside of the windshield behind the rearview mirror may correct the issue.

### **REAR AUTO BRAKE/PARK ASSIST OFF**

This message displays when the Parking Assist system has been turned off or when there is a temporary condition causing the system to be disabled.

### **REAR AUTO BRAKE AND PARK ASSIST UNAVAILABLE**

This message displays when attempting to activate the parking and backing features of the Driver

Assistance System when they are temporarily unavailable. The system does not need service.

This can occur under the following conditions:

- The radar is not clean. Keep the radar sensors free of mud, dirt, snow, ice, and slush. Clean the entire front and/or rear of the vehicle. For cleaning instructions, see *Exterior Care on page 10-85*.
- Heavy rain or snow is interfering with the radar object detection or camera performance.

See *Driver Assistance Systems on page 9-43*.

### **SERVICE AUTOMATIC COLLISION PREP**

If this message displays, take the vehicle to your dealer to repair the system.

### **SERVICE DRIVER ASSIST SYSTEM**

If this message displays, take the vehicle to your dealer to repair the system.

Adaptive Cruise Control (ACC), Forward Collision Alert (FCA), Active Emergency Braking System, Assistance Systems for Parking or Backing, and/or Lane Departure Warning (LDW) system may not work. Do not use these systems until the vehicle has been repaired.

### **SERVICE FRONT CAMERA**

If this message remains on after continued driving, the vehicle needs service. Do not use the Lane Departure Warning (LDW) and Forward Collision Alert (FCA) features. Take the vehicle to your dealer.

### **SERVICE PARK ASSIST**

This message displays if there is a problem with the Parking Assist system. Do not use this system to help you park. See your dealer for service.

### **SERVICE REAR AUTO BRAKE AND PARK ASSIST**

This message displays if there is a problem with the parking and backing features of the Driver Assistance System. Do not use this system to help park or back the vehicle. See your dealer for service.

### **SIDE BLIND ZONE ALERT OFF**

This message indicates that the driver has turned the Side Blind Zone Alert (SBZA) system off.

### **SERVICE SIDE DETECTION SYSTEM**

If this message remains on after continued driving, the vehicle needs service. Side Blind Zone Alert

(SBZA) and Rear Cross Traffic Alert (RCTA) features will not work. Take the vehicle to your dealer.

### **SIDE DETECTION SYSTEM UNAVAILABLE**

This message indicates that Side Blind Zone Alert (SBZA) and Rear Cross Traffic Alert (RCTA) are disabled either because the sensor is blocked and cannot detect vehicles in the blind zone, or the vehicle is passing through an open area, such as the desert, where there is insufficient data for operation. This message may also activate during heavy rain or due to road spray. The vehicle does not need service. For cleaning, see "Washing the Vehicle" under *Exterior Care on page 10-85*.

### Ride Control System Messages

#### SERVICE ALL WHEEL DRIVE

This message displays when there is a problem with the All Wheel Drive (AWD) system. This message could be set by a number of issues. Some may require service of the AWD system some will not. The vehicle will run in normal two-wheel drive mode when this message has been set. This could be caused by:

- A vehicle or an AWD system electronics problem.
- Various vehicle electrical issues.
- Worn out or overheated clutch plates.
- Loss of fluids.

If this message appears, stop when convenient and turn off the ignition for 30 seconds. Restart the vehicle and check for the message on the DIC display. If the message has gone off and stays off, it is not necessary to take your vehicle to

the dealer. If the message still displays or appears again when you begin driving, the system needs service. See your dealer.

#### SERVICE STABILITRAK

This message displays if there is a problem with the StabiliTrak system. See *Traction Control/Electronic Stability Control on page 9-30*.

#### SERVICE SUSPENSION SYSTEM

This message displays if there is a problem with the Selective Ride Control. See *Selective Ride Control on page 9-32*.

#### SERVICE TRACTION CONTROL

This message displays when there is a problem with the Traction Control System (TCS). See *Traction Control/Electronic Stability Control on page 9-30*.

#### SPORT MODE ON

This message displays when Sport Mode has been activated. See *Selective Ride Control on page 9-32* and *Manual Mode on page 9-24*.

#### TRACTION CONTROL OFF

This message displays when the Traction Control System (TCS) has been turned off. See *Traction Control/Electronic Stability Control on page 9-30*.

#### TRACTION CONTROL ON

This message displays when the Traction Control System (TCS) has been turned on. See *Traction Control/Electronic Stability Control on page 9-30*.

### Airbag System Messages

#### SERVICE AIRBAG

This message displays if there is a problem with the airbag system. Take the vehicle to your dealer for service.

## Security Messages

### THEFT ATTEMPTED

This message displays if the vehicle detects a tamper condition.

## Service Vehicle Messages

### SERVICE POWER STEERING

This message is displayed if there is a problem with the power steering system and a chime may sound. Take the vehicle to your dealer for service.

### SERVICE VEHICLE SOON

This message is displayed if there is a problem with the vehicle. Take the vehicle to your dealer for service.

## Starting the Vehicle Messages

### PRESS BRAKE TO START VEHICLE

This message is displayed when attempting to start the vehicle without first pressing the brake pedal.

### SERVICE KEYLESS START SYSTEM

This message is displayed if there is a problem with the pushbutton start system. Take the vehicle to your dealer for service.

## Tire Messages

### SERVICE TIRE MONITOR SYSTEM

This message displays if there is a problem with the Tire Pressure Monitor System (TPMS). See *Tire Pressure Monitor Operation on page 10-51*.

### TIRE LEARNING ACTIVE

This message displays when the system is learning new tires. See *Tire Pressure Monitor Operation on page 10-51*.

### TIRE LOW ADD AIR TO TIRE

This message displays when the pressure in one or more of the tires is low.

This message also displays LEFT FRONT, RIGHT FRONT, LEFT REAR, or RIGHT REAR to indicate the location of the low tire.

The low tire pressure warning light will also come on. See *Tire Pressure Light on page 5-22*.

If a tire pressure message appears on the DIC, stop as soon as you can. Inflate the tires by adding air until the tire pressure is equal to the values shown on the Tire and Loading Information label. See *Tires on page 10-41*, *Vehicle Load Limits on page 9-9*, and *Tire Pressure on page 10-48*.



You can receive more than one tire pressure message at a time. The DIC also shows the tire pressure values. See *Driver Information Center (DIC)* on page 5-25.

### Transmission Messages

#### SERVICE TRANSMISSION

This message displays if there is a problem with the transmission. See your dealer.

#### SHIFT DENIED

This message displays when using the Driver Shift Control (DSC) and attempting to shift to a gear not appropriate for the vehicle speed and engine revolutions per minute (rpm). See *Manual Mode* on page 9-24.

#### SHIFT TO PARK

This message displays when the transmission needs to be shifted to P (Park). This may appear when turning the ignition off if the vehicle is not in P (Park).

#### TRANSMISSION HOT — IDLE ENGINE

This message displays and a chime sounds if the transmission fluid in the vehicle gets hot. Driving with the transmission fluid temperature high can cause damage to the vehicle. Stop the vehicle and let it idle to allow the transmission to cool. This message clears when the fluid temperature reaches a safe level.

#### Vehicle Reminder Messages

##### ICE POSSIBLE DRIVE WITH CARE

This message is displayed when ice conditions are possible.

##### TURN WIPER CONTROL TO INTERMITTENT FIRST

This message is displayed when attempting to adjust the intermittent wiper speed without intermittent

selected on the wiper control. See *Windshield Wiper/Washer* on page 5-3.

### Vehicle Speed Messages

#### SELECTED SPEED LIMIT EXCEEDED

This message is displayed when the vehicle speed is greater than the set speed. See "Speed Warning" under *Driver Information Center (DIC)* on page 5-25.

### Washer Fluid Messages

#### WASHER FLUID LOW ADD FLUID

This message may display when the washer fluid level is low. Fill the windshield washer reservoir as soon as possible. See *Engine Compartment Overview* on page 10-5 for the location of the windshield washer reservoir. Also, see *Washer Fluid* on page 10-18.

## Vehicle Personalization

Use the audio system controls to access the personalization menus for customizing vehicle features.

The following are all possible personalization features. Depending on the vehicle, some may not be available.

### Infotainment System Audio System Controls

To access the personalization menu:

1. Press **SETTINGS** on the Home page on the infotainment system display.
2. Press the desired feature to display a list of available options.
3. Press to select the desired feature setting.
4. Press the  Back screen button to return to the previous menu.

### Personalization Menus

The following list of menu items may be available:

- Time and Date
- Language (Language)
- Valet Mode
- Radio
- Vehicle
- Bluetooth
- Voice
- Display
- Rear Camera
- Return to Factory Settings
- Software Information

Each menu is detailed in the following information.

#### Time and Date

Manually set the time and date. See *Clock* on page 5-6.

### Language (Language)

Select Language, then select from the available language(s).

Select the language. The selected language will display on the system, and voice recognition will reflect the selected language.

### Valet Mode (If Equipped)

This will lock the infotainment system and steering wheel controls. It may also limit top speed, power, and access to vehicle storage locations (if equipped).

To enable valet mode:

1. Enter a four-digit code on the keypad.
2. Press Enter to go to the confirmation screen.
3. Re-enter the four-digit code.

Press **LOCK** or **UNLOCK** to lock or unlock the system. Press **Back** to go back to the previous menu.

### Radio

Press to display the Radio Menu and the following may be displayed:

- Manage Favorites
- Number of Favorites Shown
- Audible Touch Feedback
- Bose Audio Pilot
- Maximum Startup Volume

#### Manage Favorites

This allows favorites to be edited. See “Manage Favorites” in “Settings” under “Radio” in the infotainment manual.

#### Number of Favorites Shown

Press to set the number of favorites to display.

Select the desired number or select Auto and the infotainment system will automatically adjust the number of favorites shown.

#### Audible Touch Feedback

This allows Audible Touch Feedback to be turned on or off.

Select Off or On.

### Bose Audio Pilot

This feature adjusts the volume based on the noise in the vehicle. See “Bose AudioPilot Noise Compensation Technology” under “Infotainment System Settings” in the infotainment manual.

### Maximum Startup Volume

This feature sets the maximum startup volume. If the vehicle is started and the volume is greater than this level, the volume is adjusted to this level. To set the maximum startup volume, press + or – to increase or decrease.

### Vehicle

Select and the following may be displayed:

- Climate and Air Quality
- Collision/Detection Systems
- Comfort and Convenience
- Lighting

- Power Door Locks
- Remote Lock, Unlock, Start

### Climate and Air Quality

Select and the following may be displayed:

- Auto Fan Max Speed
- Air Quality Sensor
- Auto Defog
- Auto Rear Defog

### Auto Fan Max Speed

This feature will set the maximum auto fan speed.

Select Low, Medium, or High.

### Air Quality Sensor

This allows for selection of air quality sensor operation at high or low sensitivity.

Select Off, Low Sensitivity, or High Sensitivity.

**Auto Defog**

When set to On, the front defog will automatically react to temperature and humidity conditions that may cause fogging.

Select Off or On.

**Auto Rear Defog**

If equipped, this allows auto rear defog to be turned on or off.

Select Off or On.

**Collision/Detection Systems**

Select the Collision/Detection Systems menu and the following may display:

- Alert Type
- Auto Collision Preparation
- Go Notifier
- Side Blind Zone Alert
- Rear Cross Traffic Alert

**Alert Type**

This feature will set crash alerts to beeps or seat vibrations. This setting affects all crash alerts including:

- Forward Collision
- Lane Departure Warning
- Adaptive Cruise Control
- Parking Assist
- Backing Warning

Select Beeps or Safety Alert Seat.

**Auto Collision Preparation**

This feature will turn on or off the Forward Collision Alert feature as well as the Automatic Braking capability of the Auto Collision Preparation feature. With the Alert and Brake setting, both Forward Collision Alert as well as the Automatic Braking capability of the Auto Collision Preparation feature are available. The Alert setting disables most automatic braking functions of the Auto Collision Preparation feature. Some

last-second automatic braking capability is still provided with the Alert setting, but it is much less likely to be triggered by most driving conditions. Off disables all Forward Collision Alert and Automatic Braking capabilities of the Auto Collision Preparation feature. See *Active Emergency Braking System on page 9-51*.

Select Off, Alert and Brake, or Alert.

**Go Notifier**

This feature will give a reminder that Adaptive Cruise Control provides when it has brought the vehicle to a complete stop behind another stopping vehicle, and then that vehicle drives on. See *Adaptive Cruise Control on page 9-35*.

Select Off or On.

**Side Blind Zone Alert**

This allows the feature to be turned on or off. See *Side Blind Zone Alert (SBZA) on page 9-52*.

Select Off or On.

## 5-42 Instruments and Controls

---

### Rear Cross Traffic Alert

Select Off or On. See *Assistance Systems for Parking or Backing* on page 9-44.

### Comfort and Convenience

Select and the following may be displayed:

- Auto Memory Recall
- Easy Exit Options
- Chime Volume
- Reverse Tilt Mirror

### Auto Memory Recall

This feature moves the seat rearward automatically allowing the driver more room to exit the vehicle. See *Memory Seats* on page 3-6.

Select Off, On - Driver Door Open, or On - At ignition On.

### Easy Exit Options

This feature moves the seat rearward automatically allowing the driver more room to exit the vehicle. See *Memory Seats* on page 3-6.

Select Off or On.

### Chime Volume

This allows the selection of the chime volume level.

Press + or - to adjust the volume.

### Reverse Tilt Mirror

This allows the feature to be turned on or off.

Select Off, On - Driver and Passenger, On - Driver, or On - Passenger.

### Lighting

Select and the following may be displayed:

- Vehicle Locator Lights
- Exit Lighting
- Auto High Beam

### Vehicle Locator Lights

This feature will flash the exterior lamps when  on the Remote Keyless Entry (RKE) transmitter is pressed to locate the vehicle.

Select Off or On.

### Exit Lighting

This allows the selection of how long the exterior lamps stay on when leaving the vehicle when it is dark outside.

Select Off, 30 Seconds, 60 Seconds, or 120 Seconds.

### Auto High Beam

This allows the feature to be turned on or off. See "IntelliBeam System" in *Exterior Lamp Controls* on page 6-1.

Select On or Off. On some vehicles select Off, Normal Sensitivity, or Low Sensitivity.

### Power Door Locks

Select and the following may be displayed:

- Unlocked Door Anti Lock Out
- Auto Door Unlock
- Delayed Door Lock

**Unlocked Door Anti Lock Out**

When on, this feature will keep the driver door from locking when the door is open. If Off is selected, the Delayed Door Lock menu will be available.

Select Off or On.

**Auto Door Unlock**

This allows selection of which of the doors will automatically unlock when the vehicle is shifted into P (Park).

Select Off, All Doors, or Driver Door.

**Delayed Door Lock**

When on, this feature will delay the locking of the doors. To override the delay, press the power door lock switch on the door.

Select Off or On.

**Remote Lock, Unlock, Start**

Select and the following may be displayed:

- Remote Unlock Light Feedback
- Remote Lock Feedback

- Remote Door Unlock
- Remote Start Auto Cool Seats
- Remote Start Auto Heat Seats
- Passive Door Unlock
- Passive Door Lock
- Remote Left in Vehicle Alert

**Remote Unlock Light Feedback**

When on, the exterior lamps will flash when unlocking the vehicle with the RKE transmitter.

Select Off or On.

**Remote Lock Feedback**

This allows selection of what type of feedback is given when locking the vehicle with the RKE transmitter.

Select Off, Lights and Horn, Lights Only, or Horn Only.

**Remote Door Unlock**

This allows selection of which doors will unlock when pressing  on the RKE transmitter.

Select All Doors or Driver Door.

**Remote Start Auto Cool Seats**

If equipped and turned on, this feature will turn the ventilated seats on when using remote start on warm days.

Select Off or On.

**Remote Start Auto Heat Seats**

If equipped and turned on, this feature will turn the heated seats on when using remote start on cold days.

Select Off or On.

**Passive Door Unlock**

This allows the selection of what doors will unlock when using the button on the driver door to unlock the vehicle.

Select All Doors or Driver Door.

**Passive Door Lock**

This feature can be turned on or off, or can be used to select feedback when using the button on the driver

## 5-44 Instruments and Controls

---

door to lock the vehicle. See *Remote Keyless Entry (RKE) System Operation on page 2-3*.

Select Off, On with Horn Chirp, or On.

### Remote Left in Vehicle Alert

This feature sounds an alert when the RKE transmitter is left in the vehicle.

Select Off or On.

### Bluetooth

Select and the following may be displayed:

- Pair New Device
- Device Management
- Ringtones
- Voice Mail Numbers

### Pair New Device

Select to pair a new device. See “Pairing” in “Infotainment Controls” under “Bluetooth” in the infotainment manual.

### Device Management

Select to connect to a different phone source, disconnect a phone, or delete a phone.

### Ringtones

Press to change the ring tone for the specific phone. The phone does not need to be connected to change the ring.

### Voice Mail Numbers

This feature displays the voice mail number for all connected phones. To change the voice mail number, select EDIT or press the EDIT button. Type a new number, then select SAVE or press the SAVE button.

### Voice

Select and the following may be displayed:

- Confidence Threshold
- Prompt Length
- Audio Feedback Speed

### Confidence Threshold

This feature allows the adjustment of the sensitivity of the speech recognition system.

Select Confirm More or Confirm Less.

### Prompt Length

This feature adjusts the voice prompt length.

Select Short or Long.

### Audio Feedback Speed

This feature adjusts the audio feedback speed.

Select Slow, Medium, or Fast.

### Display

Select and the following may be displayed:

- Mode
- Calibrate Touchscreen
- Turn Display Off

**Mode**

Select to change the display screen for day or night driving.

Select Auto, Day, or Night.

**Calibrate Touchscreen**

Select to calibrate the touchscreen, then follow the prompts.

**Turn Display Off**

Select to turn the display off. Press anywhere on the display area or any faceplate button to turn the display on.

**Rear Camera**

Select and the following may be displayed:

- Guidance Lines
- Rear Park Assist Symbols

**Guidance Lines**

Select to turn Off or On. See *Assistance Systems for Parking or Backing on page 9-44.*

**Rear Park Assist Symbols**

Select to turn Off or On. See *Assistance Systems for Parking or Backing on page 9-44.*

**Return to Factory Settings**

Select and the following may be displayed:

- Restore Vehicle Settings
- Clear All Private Data
- Restore Radio Settings

**Restore Vehicle Settings**

This allows selection of restoring vehicle settings.

Select Cancel or Restore.

**Clear All Private Data**

This allows selection to clear all private information from the vehicle.

Select Cancel or Delete.

**Restore Radio Settings**

This allows selection to restore radio settings.

Select Cancel or Restore.

**Software Information**

Select to view the infotainment system current software information.



## Universal Remote System

See *Radio Frequency Statement on page 13-12*.

### Universal Remote System Programming



If equipped, these buttons are in the overhead console.

This system can replace up to three remote control transmitters used to activate devices such as garage door openers, security systems, and home automation devices. These instructions refer to a garage door opener, but can be used for other devices.

Do not use the Universal Remote system with any garage door opener that does not have the stop and reverse feature. This includes any garage door opener model manufactured before April 1, 1982.

Read these instructions completely before programming the Universal Remote system. It may help to have another person assist with the programming process.

Keep the original hand-held transmitter for use in other vehicles as well as for future programming. Erase the programming when vehicle ownership is terminated. See “Erasing Universal Remote System Buttons” later in this section.

To program a garage door opener, park outside directly in line with and facing the garage door opener receiver. Clear all people and objects near the garage door.

Make sure the hand-held transmitter has a new battery for quick and accurate transmission of the radio-frequency signal.

### Programming the Universal Remote System

For questions or help programming the Universal Remote system, call 1-800-355-3515 or see [www.homelink.com](http://www.homelink.com).

Programming involves time-sensitive actions, and may time out causing the procedure to be repeated.

To program up to three devices:

1. Hold the end of the hand-held transmitter about 3 to 8 cm (1 to 3 in) away from the Universal Remote system buttons with the indicator light in view. The hand-held transmitter was supplied by the manufacturer of the garage door opener receiver.

2. At the same time, press and hold both the hand-held transmitter button and one of the three Universal Remote system buttons to be used to operate the garage door. Do not release either button until the indicator light changes from a slow to a rapid flash. Then release both buttons.

Some garage door openers may require substitution of Step 2 with the procedure under “Radio Signals for Canada and Some Gate Operators” later in this section.

3. Press and hold the newly programmed Universal Remote system button for five seconds while watching the indicator light and garage door activation.
  - If the indicator light stays on continuously or the garage door moves when the button is pressed, then

programming is complete. There is no need to complete Steps 4–6.

- If the indicator light does not come on or the garage door does not move, a second button press may be required. For a second time, press and hold the newly programmed button for five seconds. If the light stays on or the garage door moves, programming is complete.
- If the indicator light blinks rapidly for two seconds, then changes to a solid light and the garage door does not move, continue with programming Steps 4–6.

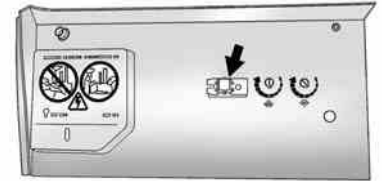

#### Learn or Smart Button

4. After completing Steps 1–3, locate the Learn or Smart button inside garage on the garage door opener receiver. The name and color of the button may vary by manufacturer.
5. Press and release the Learn or Smart button. Step 6 must be completed within 30 seconds of pressing this button.
6. Inside the vehicle, press and hold the newly programmed Universal Remote system button for two seconds and then release it. If the garage door does not move or the lamp on the garage door opener receiver

does not flash, press and hold the same button a second time for two seconds, then release it. Again, if the door does not move or the garage door lamp does not flash, press and hold the same button a third time for two seconds, then release it.

The Universal Remote system should now activate the garage door.

Repeat the process for programming the two remaining buttons.

### **Radio Signals for Canada and Some Gate Operators**

For questions or programming help call 1-800-355-3515 or see [www.homelink.com](http://www.homelink.com).

Canadian radio-frequency laws and some U.S. gate operators require transmitter signals to time out or quit after several seconds of transmission. This may not be long

enough for the Universal Remote system to pick up the signal during programming.

If the programming did not work, replace Step 2 under "Programming the Universal Remote System" with the following:

Press and hold the Universal Remote system button while pressing and releasing the hand-held transmitter button every two seconds until the signal has been successfully accepted by the Universal Remote system. The Universal Remote system indicator light will flash slowly at first and then rapidly. Proceed with Step 3 under "Programming the Universal Remote System" to complete.

## **Universal Remote System Operation**

### **Using the Universal Remote System**

Press and hold the appropriate Universal Remote system button for at least one-half second. The indicator light will come on while the signal is being transmitted.

### **Erasing Universal Remote System Buttons**

Erase all programmed buttons when vehicle ownership is terminated.

To erase:

1. Press and hold the two outside buttons until the indicator light begins to flash. This should take about 10 seconds.
2. Release both buttons.

### **Reprogramming a Single Universal Remote System Button**

To reprogram any of the system buttons:

1. Press and hold any one of the buttons. Do not release the button.
2. The indicator light will begin to flash after 20 seconds. Without releasing the button, proceed with Step 1 under "Programming the Universal Remote System."



## Lighting

### Exterior Lighting

Exterior Lamp Controls .....	6-1
Headlamp High/Low-Beam Changer .....	6-3
Flash-to-Pass .....	6-3
Daytime Running Lamps (DRL) .....	6-3
Adaptive Forward Lighting (AFL) .....	6-4
Twilight Sentinel .....	6-5
Hazard Warning Flashers .....	6-6
Turn and Lane-Change Signals .....	6-6
Front Fog Lamps .....	6-6

### Interior Lighting

Instrument Panel Illumination Control .....	6-7
Cargo Lamp .....	6-7
Courtesy Lamps .....	6-7
Dome Lamps .....	6-8
Reading Lamps .....	6-8

### Lighting Features

Entry Lighting .....	6-8
Exit Lighting .....	6-8
Battery Load Management .....	6-9
Battery Power Protection .....	6-10
Exterior Lighting Battery Saver .....	6-10

## Exterior Lighting

### Exterior Lamp Controls

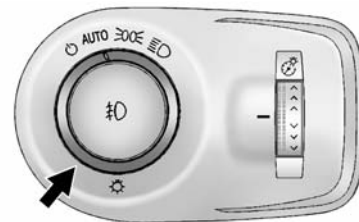

This control is on the instrument panel to the left of the steering column.

Turn the control to the following positions:

**OFF**: Briefly turn to this position to turn the automatic light control off or on again.

**AUTO (Automatic)**: Automatically turns the exterior lamps on and off, depending on outside lighting.

## 6-2 Lighting

---

 (**Parking Lamps**): Turns on the parking lamps including all lamps, except the headlamps.

 (**Headlamps**): Turns on the headlamps together with the parking lamps and instrument panel lights. A warning chime sounds if the driver door is opened when the ignition switch is off and the headlamps are on.

 (**Front Fog Lamps, If Equipped**): Press to turn the lamps on or off.

See *Front Fog Lamps* on page 6-6.

### IntelliBeam® System

If equipped, this system turns the vehicle's high-beam headlamps on and off according to surrounding traffic conditions.

The system turns the high-beam headlamps on when it is dark enough and there is no other traffic present.



This light comes on in the instrument cluster when the IntelliBeam system is enabled.

### Turning On and Enabling IntelliBeam

To enable the IntelliBeam system, with the turn signal lever in the neutral position, turn the exterior lamp control to AUTO. The blue high-beam on light appears on the instrument cluster when the high beams are on.

### Driving with IntelliBeam

The system only activates the high beams when driving over 40 km/h (25 mph).

There is a sensor near the top center of the windshield that automatically controls the system.

Keep this area of the windshield clear of debris to allow for best system performance.

The high-beam headlamps remain on, under the automatic control, until one of the following situations occurs:

- The system detects an approaching vehicle's headlamps.
- The system detects a preceding vehicle's taillamps.
- The outside light is bright enough that high-beam headlamps are not required.
- The vehicle's speed drops below 20 km/h (12 mph).
- The IntelliBeam system can be disabled by the High/Low-Beam Changer or the Flash-to-Pass feature. If this happens, the High/Low-Beam Changer must be activated two times within five seconds to reactivate the IntelliBeam system. The instrument cluster light will come

on to indicate the IntelliBeam is reactivated. See *Headlamp High/Low-Beam Changer* on page 6-3 or *Flash-to-Pass* on page 6-3.

The high beams may not turn off automatically if the system cannot detect another vehicle's lamps because of any of the following:

- The other vehicle's lamps are missing, damaged, obstructed from view, or otherwise undetected.
- The other vehicle's lamps are covered with dirt, snow, and/or road spray.
- The other vehicle's lamps cannot be detected due to dense exhaust, smoke, fog, snow, road spray, mist, or other airborne obstructions.
- The vehicle's windshield is dirty, cracked, or obstructed by something that blocks the view of the light sensor.

- The vehicle is loaded such that the front end points upward, causing the light sensor to aim high and not detect headlamps and taillamps.
- Driving on winding or hilly roads.

The high-beam headlamps may need to be disabled if any of the above conditions exist.

This feature can be turned on or off in vehicle personalization. See *Vehicle Personalization* on page 5-39.

### Headlamp High/ Low-Beam Changer

Push the turn signal lever away from you and release to turn the high beams on. To return to low beams, push the lever again or pull it toward you and release.



This indicator light turns on in the instrument cluster when the high-beam headlamps are on.

### Flash-to-Pass

The flash-to-pass feature works with the low beams or Daytime Running Lamps (DRL) on or off.

To flash the high beams, pull the turn signal lever all the way toward you, then release it.

### Daytime Running Lamps (DRL)

DRL can make it easier for others to see the front of your vehicle during the day. Fully functional DRL are required on all vehicles first sold in Canada.



## 6-4 Lighting

---

A light sensor on top of the instrument panel makes the DRL work, so be sure it is not covered.

The DRL system makes the low-beam headlamps come on at a reduced brightness or for vehicles with High Intensity Discharge (HID) headlamps, the DRL lights will come on when the following conditions are met:

- The ignition is in the ON/RUN mode.
- The exterior lamp control is in AUTO.
- The engine is running.
- The vehicle is not in P (Park).

When the DRL are on, only the low-beam headlamps, at a reduced level of brightness, will be on. The high-beam headlamps, taillamps, sidemarker, instrument panel lamps, and other lamps will not be on.

The headlamps automatically change from DRL to the regular headlamps depending on the

darkness of the surroundings. The other lamps that come on with the headlamps will also come on.

When it is bright enough outside, the headlamps go off and the DRL come on.

To turn the DRL lamps off or on again, turn the exterior lamp control to the off position and then release. For vehicles first sold in Canada, the DRL cannot be turned off.

This vehicle may have a DRL disabling function. When the DRL are on and a turn signal is activated, the DRL on that side will be off until the turn signal goes off.

### **Adaptive Forward Lighting (AFL)**

For vehicles with uplevel headlamps, the Adaptive Forward Lighting System (AFL) adjusts the headlamps to provide greater road illumination in various driving conditions.

To enable AFL, set the exterior lamp control to the AUTO position.

Moving the control out of the AUTO position will deactivate the system. AFL will operate when the vehicle speed is greater than 3 km/h (2 mph). AFL will not operate when the transmission is in R (Reverse). AFL is not immediately operable after starting the vehicle. Driving a short distance is required to calibrate the AFL. See *Exterior Lamp Controls* on page 6-1.

### **Curve Lighting**

The light beam pivots based on the steering wheel position and vehicle speed of at least 10 km/h (6 mph). The headlamps shine at an angle of up to 15 degrees to the right or left of the direction of travel.

## Twilight Sentinel

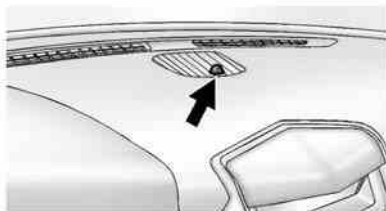



This feature automatically turns the lamps on and off. A light sensor on top of the instrument panel makes the Twilight Sentinel® work, so be sure it is not covered.

With Twilight Sentinel the following will happen:



- When it is dark enough outside, and the exterior lamp control is in the AUTO position, the Daytime Running Lamps (DRL) go off, and the headlamps and parking lamps come on. The other lamps that come on with the headlamps also come on.

- When it is bright enough outside, the headlamps go off, and the DRL come on, as long as the exterior lamp control is in the AUTO position. See *Exterior Lamp Controls* on page 6-1.

If the vehicle is started in a dark garage, the automatic headlamp system comes on immediately. If it is light outside when the vehicle leaves the garage, there is a slight delay before the automatic headlamp system changes to the DRL. During that delay, the instrument cluster may not be as bright as usual. Make sure the instrument panel brightness control is in full bright position. See *Instrument Panel Illumination Control* on page 6-7.

The vehicle can be idled with the lamps off, even when it is dark outside. After starting the vehicle, turn the exterior lamps control to , then release it. The lamps will remain off until the control is turned to  again.

Twilight Sentinel also provides exterior illumination when exiting the vehicle until one of the following occurs:

- The exterior lamp control is moved to  from the AUTO position or to .
- The delay time selected has elapsed.

See *Vehicle Personalization* on page 5-39 to select the delay time. You can also select no delay time.



If the ignition is turned off with the exterior lamp control in the parking lamp or headlamp position, the Twilight Sentinel delay will not occur. The lamps will turn off as soon as the control is turned off.

The regular headlamp system should be turned on when needed.

### Lights On with Wipers

If the windshield wipers are activated in daylight with the engine on, and the exterior lamp control is in AUTO, the headlamps, parking

## 6-6 Lighting

lamps, and other exterior lamps come on. The transition time for the lamps coming on varies based on wiper speed. When the wipers are not operating, these lamps turn off. Move the exterior lamp control to  or  to disable this feature.

### Hazard Warning Flashers

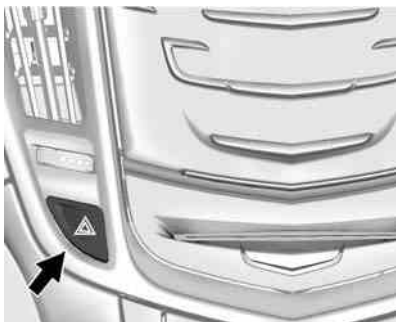

 (**Hazard Warning Flashers**): Press this button on the instrument panel to make the front and rear turn signal lamps flash on and off.

This warns others that you are having trouble. Press again to turn the flashers off.

### Turn and Lane-Change Signals

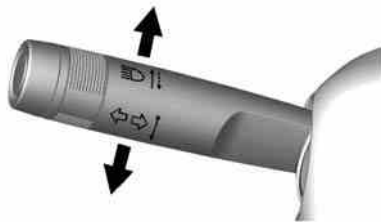

Move the lever all the way up or down to signal a turn.

An arrow on the instrument cluster will flash in the direction of the turn or lane change.

Raise or lower the lever until the arrow starts to flash to signal a lane change. The turn signal flashes three times.

The lever returns to its starting position when it is released.

If after signaling a turn or lane change the arrow flashes rapidly or does not come on, a signal bulb may be burned out.

Replace any burned out bulbs. If a bulb is not burned out, check the fuse. See *Fuses and Circuit Breakers* on page 10-33.

### Front Fog Lamps

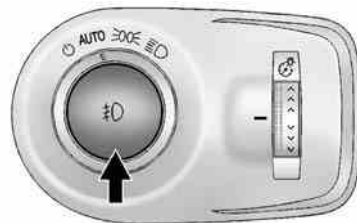

The front fog lamp button is on the exterior lamp control on the outboard side of the steering wheel.

The ignition must be on to turn on the fog lamps.

**☾ (Front Fog Lamps):** Press to turn the fog lamps on or off. An indicator light on the instrument cluster comes on when the fog lamps are on.

The fog lamps come on together with the parking lamps.

Some localities have laws that require the headlamps to be on along with the fog lamps.

## Interior Lighting

### Instrument Panel Illumination Control

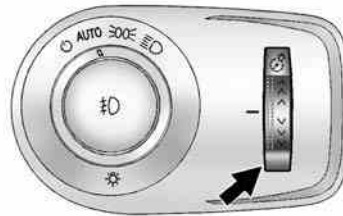

The brightness of the instrument panel lights and steering wheel controls can be adjusted.

**☼ (Instrument Panel Brightness):** Move and hold the thumbwheel up or down to brighten or dim the lights.

The brightness of the displays automatically adjusts based on outdoor lighting. The instrument panel illumination control will set the lowest level to which the displays will automatically be adjusted.

### Cargo Lamp

The cargo lamp is located in the rear compartment and is controlled by the dome lamp. See *Dome Lamps* on page 6-8.

### Courtesy Lamps

The courtesy lamps come on automatically when any door is opened and the dome lamp is in the door position.

### Dome Lamps



To change the dome lamp settings, press the following:

 **(Dome Lamp Override):** Turns the lamp off, even when a door is open.



 **(Door):** The lamp comes on when a door is opened.

 **(On):** Turns the dome lamp on.

### Reading Lamps



There are reading lamps in the overhead console and over the rear passenger doors. These lamps come on automatically when any door is opened.

To manually turn the reading lamps on or off:

- Press  or  next to each overhead console reading lamp.
- Press the lamp lens on the rear passenger reading lamps.

## Lighting Features

### Entry Lighting

The headlamps, taillamps, license plate lamps, dome lamps, and most of the interior lights turn on briefly at night, or in areas with limited lighting, when  is pressed on the Remote Keyless Entry (RKE) transmitter. After about 30 seconds the exterior lamps turn off, and then the dome and remaining interior lights dim to off. The entry lighting can be manually turned off by changing the ignition out of the off position, or by pressing  on the RKE transmitter.

This feature can be changed. See *Vehicle Personalization on page 5-39*.

### Exit Lighting

The headlamps, taillamps, parking lamps, and license plate lamps come on at night, or in areas with limited lighting, when a door is

opened after the ignition is turned off. The dome lamps also come on when the driver door is opened after the ignition is changed to the off position.

The exterior lamps and dome lamp remain on after the door is closed for a set amount of time, then automatically turn off.

The exterior lamps turn off immediately by turning the exterior lamps control to off.

This feature can be changed. See *Vehicle Personalization on page 5-39*.

## Battery Load Management

The vehicle has Electric Power Management (EPM) that estimates the battery's temperature and state of charge. It then adjusts the voltage for best performance and extended life of the battery.

When the battery's state of charge is low, the voltage is raised slightly to quickly bring the charge back up. When the state of charge is high, the voltage is lowered slightly to prevent overcharging. If the vehicle has a voltmeter gauge or a voltage display on the Driver Information Center (DIC), you may see the voltage move up or down. This is normal. If there is a problem, an alert will be displayed.

The battery can be discharged at idle if the electrical loads are very high. This is true for all vehicles. This is because the generator (alternator) may not be spinning fast enough at idle to produce all of the power needed for very high electrical loads.

A high electrical load occurs when several of the following are on, such as: headlamps, high beams, fog lamps, rear window defogger, climate control fan at high speed, heated seats, engine cooling fans, trailer loads, and loads plugged into accessory power outlets.

EPM works to prevent excessive discharge of the battery. It does this by balancing the generator's output and the vehicle's electrical needs. It can increase engine idle speed to generate more power whenever needed. It can temporarily reduce the power demands of some accessories.

Normally, these actions occur in steps or levels, without being noticeable. In rare cases at the highest levels of corrective action, this action may be noticeable to the driver. If so, a DIC message might be displayed and it is recommended that the driver reduce the electrical loads as much as possible. See *Battery Voltage and Charging Messages on page 5-28*.

### **Battery Power Protection**

The battery saver feature is designed to protect the vehicle's battery.

If some interior lamps are left on and the ignition is turned off, the battery rundown protection system automatically turns the lamp off after some time.

### **Exterior Lighting Battery Saver**

The exterior lamps turn off about 10 minutes after the ignition is turned off, if the parking lamps or headlamps have been manually left on. This protects against draining the battery. To restart the 10-minute timer, turn the exterior lamp control to the off position and then back to the parking lamp or headlamp position.

To keep the lamps on for more than 10 minutes, the ignition must be in the ACC/ACCESSORY or ON/RUN position.

# Infotainment System

## Introduction

Infotainment ..... 7-1

## Introduction

### Infotainment

See the infotainment manual for information on the radio, audio players, phone, navigation system, and voice or speech recognition. It also includes information on settings and downloadable applications (if equipped).





## Climate Controls

### Climate Control Systems

Dual Automatic Climate Control System .....	8-1
Rear Climate Control System .....	8-6

### Air Vents

Air Vents .....	8-7
-----------------	-----

### Maintenance

Passenger Compartment Air Filter .....	8-8
--	-----

## Climate Control Systems

### Dual Automatic Climate Control System

The climate control buttons and the touch screen are used to adjust the heating, cooling, and ventilation.

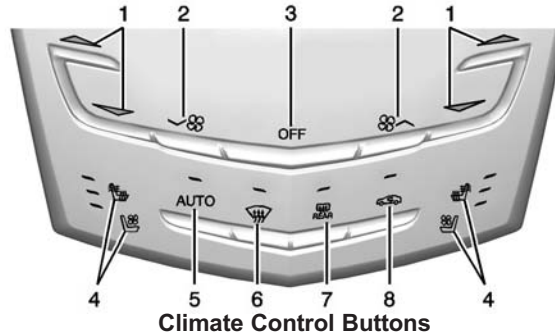

1. Driver and Passenger Temperature Controls
2. Fan Control
3. OFF (Fan)

4. Driver and Passenger Heated and Ventilated Seats (If Equipped)
5. AUTO (Automatic Operation)
6. Defrost

## 8-2 Climate Controls

7. Rear Window Defogger
8. Recirculation

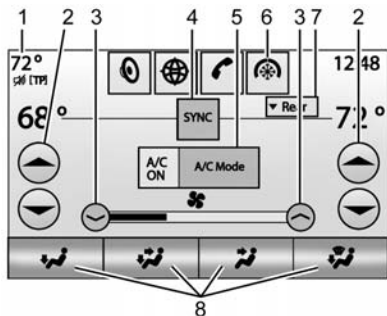

### Climate Touch Screen Controls

1. Outside Temperature Display
2. Driver and Passenger Temperature Controls
3. Fan Control

4. SYNC (Synchronized Temperature)
5. A/C Mode (Air Conditioning)
6. Climate Control Selection (Application Tray Button)
7. Rear (Rear Climate Control Touch Screen)
8. Air Delivery Mode Control

### Climate Control Touch Screen

The fan, air delivery mode, air conditioning, driver and passenger temperatures and SYNC settings can be controlled by pressing CLIMATE on the infotainment home screen or the climate button in the touch screen application tray. A selection can then be made on the front climate control page displayed. See the infotainment manual.

### Climate Control Status Screen

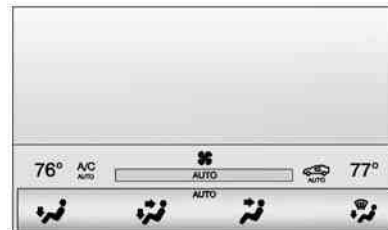

The climate control status screen appears briefly when the climate control buttons on the faceplate are adjusted. The air delivery mode can be adjusted on the climate control status screen.

### Automatic Operation

The system automatically controls the fan speed, air delivery, air conditioning, and recirculation in order to heat or cool the vehicle to the desired temperature.

When the indicator light is on or AUTO is displayed on the touch screen, the system is in full automatic operation. If the air delivery mode or fan setting is manually adjusted, the auto indicator turns off and the display will show the selected settings. Auto operation can be turned off individually for climate settings.

For automatic operation:

1. Press AUTO.
2. Set the temperature. Allow the system time to stabilize. Then adjust the temperature as needed for best comfort.

To improve fuel efficiency and to cool the vehicle faster, recirculation may be automatically selected in warm weather. The recirculation light will not come on. Press  to select recirculation; press it again to select outside air.



**OFF (Fan):** Press to turn the fan on or off. The temperature control and air delivery mode can still be adjusted.

**△ / ▽ (Driver and Passenger Temperature Controls):** The temperature can be adjusted separately for the driver and the passenger. Press to increase or decrease the temperature. Press and hold to rapidly increase or decrease the temperature.

The driver and passenger temperatures can also be adjusted by pressing the controls on the touch screen.

**SYNC (Synchronized Temperature):** Press SYNC on the touch screen to link all climate zone settings to the driver settings. Adjust the driver side temperature control to change the linked temperature. When the passenger settings are adjusted, the SYNC button is displayed when the temperatures are unlinked.

## Manual Operation

**▽  or  ^ (Fan Control):** Press the fan control buttons or the touch screen fan control, to increase or decrease the fan speed. Press and hold the buttons or the touch screen control to adjust speed more quickly. The fan speed setting displays. Pressing either button cancels automatic fan control and the fan can be controlled manually. Press AUTO to return to automatic operation. To turn off the fan and climate control system, press and hold the fan down button or touch screen fan control until it is off.

**Air Delivery Mode Control:** When the climate information is displayed, press the desired air delivery mode on the touch screen to change the direction of the airflow. The selected air delivery mode button is lit. Pressing any of the air delivery buttons cancels automatic air delivery control and the direction of the airflow can be controlled manually. Press AUTO to return to automatic operation.

## 8-4 Climate Controls

---



To change the current mode, select one of the following:

 (**Vent**): Air is directed to the instrument panel outlets.

 (**Bi-Level**): Air is divided between the instrument panel outlets and the floor outlets.

 (**Floor**): Air is directed to the floor outlets.

 (**Defog**): Clears the windows of fog or moisture. Air is directed to the windshield and floor outlets.

 (**Defrost**): Clears the windshield of fog or frost more quickly. Air is directed to the windshield. Press the  button to turn on or off. Changing the air delivery mode also turns the defrost off.

**AC Mode (Air Conditioning):** Press the AC Mode touch screen control to turn the automatic air conditioning on or off. If the fan is turned off or the outside temperature falls below freezing, the air conditioner will not run.

Press AUTO to return to automatic operation and the air conditioner runs as needed.

**Automatic Air Recirculation:** When the AUTO indicator light is on, the air inside the vehicle may automatically recirculate as needed to help quickly cool the inside of the vehicle.

If equipped, an air quality sensor may also activate recirculation when it detects increasing levels of poor quality air outside the vehicle. The air quality sensor will not maintain recirculation for an extended period and may not activate during cold weather. To adjust the sensitivity of the air quality sensor, see "Climate and Air Quality" under *Vehicle Personalization on page 5-39*.

The air quality sensor system does not protect against carbon monoxide (CO), which cannot be seen or smelled. See *Engine Exhaust on page 9-21*.



**(Recirculation):** Press to alternate between recirculating air inside the vehicle or pulling in outside air. The indicator light on the button is lit when recirculation mode is active. This helps to quickly cool the air inside the vehicle or reduce the outside air and odors that may enter.

Pressing this button cancels automatic recirculation. Press AUTO to return to automatic operation; recirculation runs automatically as needed.

Manual recirculation mode is not available when in Defrost or Defog modes.

**Auto Defog:** The climate control system may have a sensor to automatically detect high humidity inside the vehicle. When high humidity is detected, the climate control system may adjust to outside air supply and turn on the air conditioner. If the climate control system does not detect possible window fogging, it returns to normal

operation. To turn Auto Defog off or on, see “Climate and Air Quality” under *Vehicle Personalization* on page 5-39.

## Rear Window Defogger

### (Rear Window Defogger):

Press to turn the rear window defogger on or off. An indicator light on the button comes on to show that the rear window defogger is on.



The rear window defogger can be set to automatic operation. See “Climate and Air Quality” under *Vehicle Personalization* on page 5-39. When Auto Rear Defog is selected, the rear window defogger turns on automatically when the interior temperature is cold and the outside temperature is about 4°C (40°F) and below.



The heated outside mirrors turn on when the rear window defogger button is on and help to clear fog or frost from the surface of the mirrors.

### Caution

Do not try to clear frost or other material from the inside of the front windshield and rear window with a razor blade or anything else that is sharp. This may damage the rear window defogger grid and affect the radio's ability to pick up stations clearly. The repairs would not be covered by the vehicle warranty.

### Driver and Passenger Heated and Ventilated Seats (If Equipped):

Press  or  to heat the driver or passenger seat cushion and seatback.

Press  or  to ventilate the driver or passenger seat. See *Heated and Ventilated Seats* on page 1-8.

### Remote Start Climate Control

**Operation:** If equipped, the climate control system may run when the vehicle is started remotely. The system uses the driver's previous

settings to heat or cool the inside of the vehicle. The rear defog may come on during remote start based on cold ambient conditions. The rear defog indicator light does not come on during a remote start. If the vehicle has heated or ventilated seats, they may come on during a remote start. See *Remote Vehicle Start* on page 2-9 and *Heated and Ventilated Seats* on page 1-8.

The rear window defogger turns on if it is cold outside.

### Sensor

The solar sensor, located on top of the instrument panel near the windshield, monitors the solar heat.

The climate control system uses the sensor information to adjust the temperature, fan speed, recirculation, and air delivery mode for best comfort.

If the sensor is covered, the automatic climate control system may not work properly.

## 8-6 Climate Controls

### Rear Climate Control System

If equipped with a rear climate control system, the settings can be adjusted with the rear climate control buttons and the touch screen.

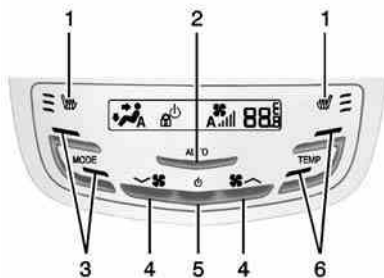

#### Rear Climate Control Buttons

1. Heated Rear Seats (If Equipped)
2. AUTO (Automatic Operation)
3. Air Delivery Mode Control
4. Fan Control

5. (On/Off)
6. TEMP (Temperature Control)

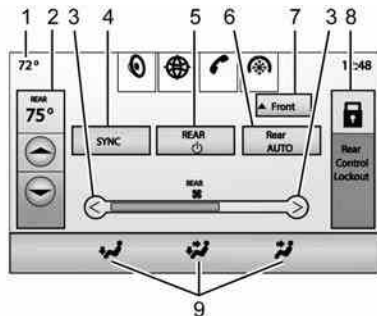

#### Rear Climate Touch Screen Controls

1. Outside Temperature Display
2. Rear Climate Temperature Control
3. Fan Control
4. SYNC (Synchronized Temperatures)
5. REAR (On/Off)

6. Rear AUTO (Automatic Operation)
7. Front (Front Climate Control Touch Screen)
8. Rear Control Lockout
9. Air Delivery Mode Control

**Rear:** Press this button on the front climate control touch screen to open the rear climate control screen. The rear climate control settings can now be adjusted from the front passenger area.

**(On/Off):** Press or REAR to turn the rear climate control on or off. The rear climate control system can also be turned off by pressing the fan down button until the system turns off. If the rear climate control is turned off using REAR on the touch screen, the button on the rear climate control faceplate must be pressed twice to turn the system back on.



**SYNC:** Press the SYNC button on the touch screen to match the rear climate control temperature to the front climate control driver temperature. The SYNC button will be lit. Press the TEMP, MODE, or AUTO button twice to unlink the set driver and rear temperatures. The SYNC button turns off.

**Rear Control Lockout:** Press to lock or unlock control of the rear climate control system from the rear seat passengers. When locked the rear climate control can only be adjusted from the front seat.

### Automatic Operation





**Rear AUTO:** Press to turn on or off. The air delivery and fan speed are controlled automatically. The AUTO indicator appears on the display. If any of the climate control settings are manually adjusted, this cancels full automatic operation.

### Manual Operation

**<  > (Fan Control):** Press briefly or press and hold the rear climate control buttons or touch screen to increase or decrease the airflow. Pressing  > when the system is off will turn the system on. The air delivery mode remains in its previous setting.

**+/- (Temperature Control):** Press briefly or press and hold the rear temperature control buttons or touch screen to adjust the rear passenger temperature. Press + for warmer air and press - for cooler air.

**   (Air Delivery Mode Control):** Press the desired mode button on the touch screen or the MODE button on the rear faceplate to change the direction of the airflow in the rear seating area.

** or  (Heated Rear Seats, If Equipped):** Press  or  to heat the left or right outboard seat cushion and seatback. See *Heated Rear Seats on page 3-11*.

## Air Vents

Move the sliding knob on the air outlets up and down or left and right to direct the airflow. Use the thumbwheels near the air outlets to open or close off the airflow.

### Operation Tips

- Clear away any ice, snow, or leaves from air inlets at the base of the windshield that could block the flow of air into the vehicle.
- Keep the path under the front seats clear of objects to help circulate the air inside the vehicle more effectively.
- Use of non-GM approved hood deflectors can adversely affect the performance of the system. Check with your dealer before adding equipment to the outside of the vehicle.
- Do not insert any objects in the outlets, as failure of the mechanism may occur.



### Maintenance

#### Passenger Compartment Air Filter

The filter reduces the dust, pollen, and other airborne irritants from outside air that is pulled into the vehicle.

The filter should be replaced as part of routine scheduled maintenance, see *Maintenance Schedule on page 11-3*. To find out what type of filter to use, see *Maintenance Replacement Parts on page 11-13*.

1. Open the glove box completely and remove the four screws along the upper portion of the glove box.
2. When released, lower the upper portion of the glove box.
3. Locate the service door for the passenger compartment air filter.

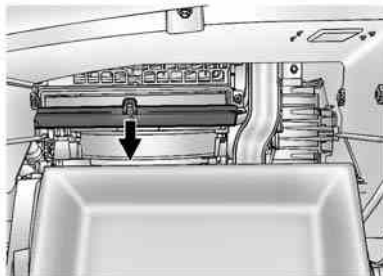

4. Release the latch holding the service door. Lower the service door.

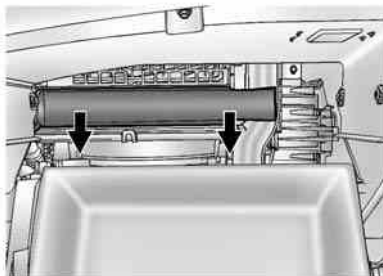

5. Remove the old air filter.
  6. Install the new air filter.
  7. Close the service door and latches.
  8. Reinstall the upper portion of the glove box.
- See your dealer if additional assistance is needed.

# Driving and Operating

## Driving Information

Distracted Driving .....	9-2
Defensive Driving .....	9-3
Drunk Driving .....	9-3
Control of a Vehicle .....	9-3
Braking .....	9-3
Steering .....	9-4
Off-Road Recovery .....	9-4
Loss of Control .....	9-5
Driving on Wet Roads .....	9-5
Hill and Mountain Roads .....	9-6
Winter Driving .....	9-7
If the Vehicle Is Stuck .....	9-9
Vehicle Load Limits .....	9-9

## Starting and Operating

New Vehicle Break-In .....	9-14
Adjustable Throttle and Brake Pedal .....	9-14
Ignition Positions .....	9-15
Starting the Gasoline Engine .....	9-16
Engine Heater .....	9-18

Retained Accessory Power (RAP) .....	9-19
Shifting Into Park .....	9-19
Shifting out of Park .....	9-20
Parking over Things That Burn .....	9-21

## Engine Exhaust

Engine Exhaust .....	9-21
Running the Vehicle While Parked .....	9-22

## Automatic Transmission

Automatic Transmission .....	9-22
Manual Mode .....	9-24
Fuel Economy Mode .....	9-25

## Drive Systems

All-Wheel Drive .....	9-26
-----------------------	------

## Brakes

Antilock Brake System (ABS) .....	9-26
Parking Brake .....	9-27
Brake Assist .....	9-29
Hill Start Assist (HSA) .....	9-29

## Ride Control Systems

Traction Control/Electronic Stability Control .....	9-30
Limited-Slip Rear Axle .....	9-32
Selective Ride Control .....	9-32

## Cruise Control

Cruise Control .....	9-33
Adaptive Cruise Control .....	9-35

## Driver Assistance Systems

Driver Assistance Systems .....	9-43
Assistance Systems for Parking or Backing .....	9-44
Assistance Systems for Driving .....	9-48
Forward Collision Alert (FCA) System .....	9-48
Active Emergency Braking System .....	9-51
Side Blind Zone Alert (SBZA) .....	9-52
Lane Departure Warning (LDW) .....	9-54

## Fuel

Fuel .....	9-56
California Fuel Requirements .....	9-57

## 9-2 Driving and Operating

---

Fuels in Foreign Countries ...	9-57
Fuel Additives .....	9-57
Filling the Tank .....	9-58
Filling a Portable Fuel Container .....	9-59
<b>Trailer Towing</b>	
General Towing Information .....	9-60
Driving Characteristics and Towing Tips .....	9-60
Trailer Towing .....	9-63
Towing Equipment .....	9-66
Trailer Sway Control (TSC) .....	9-67
<b>Conversions and Add-Ons</b>	
Add-On Electrical Equipment .....	9-68

### Driving Information

#### Distracted Driving

Distraction comes in many forms and can take your focus from the task of driving. Exercise good judgment and do not let other activities divert your attention away from the road. Many local governments have enacted laws regarding driver distraction. Become familiar with the local laws in your area.

To avoid distracted driving, always keep your eyes on the road, hands on the wheel, and mind on the drive.

- Do not use a phone in demanding driving situations. Use a hands-free method to place or receive necessary phone calls.
- Watch the road. Do not read, take notes, or look up information on phones or other electronic devices.

- Designate a front seat passenger to handle potential distractions.
- Become familiar with vehicle features before driving, such as programming favorite radio stations and adjusting climate control and seat settings. Program all trip information into any navigation device prior to driving.
- Wait until the vehicle is parked to retrieve items that have fallen to the floor.
- Stop or park the vehicle to tend to children.
- Keep pets in an appropriate carrier or restraint.
- Avoid stressful conversations while driving, whether with a passenger or on a cell phone.

 **Warning**

Taking your eyes off the road too long or too often could cause a crash resulting in injury or death. Focus your attention on driving.

Refer to the infotainment manual for more information on using that system, including pairing and using a cell phone

### Defensive Driving

Defensive driving means “always expect the unexpected.” The first step in driving defensively is to wear the safety belt. See *Safety Belts on page 3-12*.

- Assume that other road users (pedestrians, bicyclists, and other drivers) are going to be careless and make mistakes. Anticipate what they might do and be ready.

- Allow enough following distance between you and the driver in front of you.
- Focus on the task of driving.

### Drunk Driving

Death and injury associated with drinking and driving is a global tragedy.

 **Warning**

Drinking and then driving is very dangerous. Your reflexes, perceptions, attentiveness, and judgment can be affected by even a small amount of alcohol. You can have a serious — or even fatal — collision if you drive after drinking.

Do not drink and drive or ride with a driver who has been drinking. Ride home in a cab; or if you are with a group, designate a driver who will not drink.

### Control of a Vehicle

Braking, steering, and accelerating are important factors in helping to control a vehicle while driving.

### Braking

Braking action involves perception time and reaction time. Deciding to push the brake pedal is perception time. Actually doing it is reaction time.

Average driver reaction time is about three-quarters of a second. In that time, a vehicle moving at 100 km/h (60 mph) travels 20 m (66 ft), which could be a lot of distance in an emergency.

Helpful braking tips to keep in mind include:

- Keep enough distance between you and the vehicle in front of you.
- Avoid needless heavy braking.
- Keep pace with traffic.

## 9-4 Driving and Operating

If the engine ever stops while the vehicle is being driven, brake normally but do not pump the brakes. Doing so could make the pedal harder to push down. If the engine stops, there will be some power brake assist but it will be used when the brake is applied. Once the power assist is used up, it can take longer to stop and the brake pedal will be harder to push.

### Steering

#### Hydraulic Power Steering

This vehicle has hydraulic power steering. It may require maintenance. See *Power Steering Fluid* on page 10-18.

If power steering assist is lost because the engine stops or because of a system malfunction, the vehicle can be steered but may require increased effort. See your dealer if there is a problem.

#### Caution

If the steering wheel is turned until it reaches the end of its travel, and is held in that position for more than 15 seconds, damage may occur to the power steering system and there may be loss of power steering assist.

#### Curve Tips

- Take curves at a reasonable speed.
- Reduce speed before entering a curve.
- Maintain a reasonable steady speed through the curve.
- Wait until the vehicle is out of the curve before accelerating gently into the straightaway.

#### Steering in Emergencies

- There are some situations when steering around a problem may be more effective than braking.
- Holding both sides of the steering wheel allows you to turn 180 degrees without removing a hand.
- Antilock Brake System (ABS) allows steering while braking.

#### Off-Road Recovery

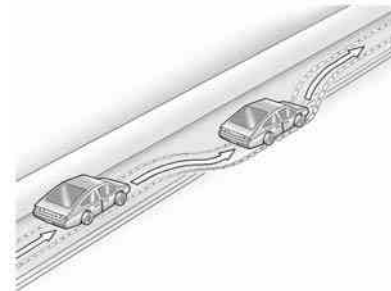

The vehicle's right wheels can drop off the edge of a road onto the shoulder while driving. Follow these tips:

1. Ease off the accelerator and then, if there is nothing in the way, steer the vehicle so that it straddles the edge of the pavement.
2. Turn the steering wheel about one-eighth of a turn, until the right front tire contacts the pavement edge.
3. Turn the steering wheel to go straight down the roadway.

## Loss of Control

### Skidding

There are three types of skids that correspond to the vehicle's three control systems:

- Braking Skid — wheels are not rolling.

- Steering or Cornering Skid — too much speed or steering in a curve causes tires to slip and lose cornering force.
- Acceleration Skid — too much throttle causes the driving wheels to spin.

Defensive drivers avoid most skids by taking reasonable care suited to existing conditions, and by not overdriving those conditions. But skids are always possible.

If the vehicle starts to slide, follow these suggestions:

- Ease your foot off the accelerator pedal and steer the way you want the vehicle to go. The vehicle may straighten out. Be ready for a second skid if it occurs.
- Slow down and adjust your driving according to weather conditions. Stopping distance can be longer and vehicle control can be affected when traction is reduced by water, snow, ice, gravel, or other

material on the road. Learn to recognize warning clues — such as enough water, ice, or packed snow on the road to make a mirrored surface — and slow down when you have any doubt.

- Try to avoid sudden steering, acceleration, or braking, including reducing vehicle speed by shifting to a lower gear. Any sudden changes could cause the tires to slide.

Remember: Antilock brakes help avoid only the braking skid.

### Driving on Wet Roads

Rain and wet roads can reduce vehicle traction and affect your ability to stop and accelerate. Always drive slower in these types of driving conditions and avoid driving through large puddles and deep-standing or flowing water.

### Warning

Wet brakes can cause crashes. They might not work as well in a quick stop and could cause pulling to one side. You could lose control of the vehicle.

After driving through a large puddle of water or a car/vehicle wash, lightly apply the brake pedal until the brakes work normally.

Flowing or rushing water creates strong forces. Driving through flowing water could cause the vehicle to be carried away. If this happens, you and other vehicle occupants could drown. Do not ignore police warnings and be very cautious about trying to drive through flowing water.

### Hydroplaning

Hydroplaning is dangerous. Water can build up under the vehicle's tires so they actually ride on the water. This can happen if the road is wet enough and you are going fast enough. When the vehicle is hydroplaning, it has little or no contact with the road.

There is no hard and fast rule about hydroplaning. The best advice is to slow down when the road is wet.

### Other Rainy Weather Tips

Besides slowing down, other wet weather driving tips include:

- Allow extra following distance.
- Pass with caution.
- Keep windshield wiping equipment in good shape.
- Keep the windshield washer fluid reservoir filled.
- Have good tires with proper tread depth. See *Tires on page 10-41*.

- Turn off cruise control.

### Hill and Mountain Roads

Driving on steep hills or through mountains is different than driving on flat or rolling terrain. Tips for driving in these conditions include:

- Keep the vehicle serviced and in good shape.
- Check all fluid levels and brakes, tires, cooling system, and transmission.
- Shift to a lower gear when going down steep or long hills.

### Warning

Using the brakes to slow the vehicle on a long downhill slope can cause brake overheating, can reduce brake performance, and could result in a loss of braking. Shift the transmission to a lower gear to let the engine assist the brakes on a steep downhill slope.

 **Warning**

Coasting downhill in N (Neutral) or with the ignition off is dangerous. This can cause overheating of the brakes and loss of steering. Always have the engine running and the vehicle in gear.

- Stay in your own lane. Do not swing wide or cut across the center of the road. Drive at speeds that let you stay in your own lane.
- Be alert on top of hills; something could be in your lane (stalled car, accident).
- Pay attention to special road signs (falling rocks area, winding roads, long grades, passing or no-passing zones) and take appropriate action.

## Winter Driving

### Driving on Snow or Ice

Drive carefully when there is snow or ice between the tires and the road, creating less traction or grip. Wet ice can occur at about 0°C (32°F) when freezing rain begins to fall, resulting in even less traction. Avoid driving on wet ice or in freezing rain until roads can be treated with salt or sand.

Drive with caution, whatever the condition. Accelerate gently so traction is not lost. Accelerating too quickly causes the wheels to spin and makes the surface under the tires slick, so there is even less traction.

If equipped, Traction Control should be turned on. See *Traction Control/ Electronic Stability Control* on page 9-30.

The Antilock Brake System (ABS) improves vehicle stability during hard stops on slippery roads, but apply the brakes sooner than when on dry pavement.

Allow greater following distance on any slippery road and watch for slippery spots. Icy patches can occur on otherwise clear roads in shaded areas. The surface of a curve or an overpass can remain icy when the surrounding roads are clear. Avoid sudden steering maneuvers and braking while on ice.

See *Antilock Brake System (ABS)* on page 9-26.

Turn off cruise control on slippery surfaces.



### Blizzard Conditions

Being stuck in snow can be a serious situation. Stay with the vehicle unless there is help nearby. If possible, use Roadside Service. See *Roadside Service on page 13-5*. To get help and keep everyone in the vehicle safe:

- Turn on the hazard warning flashers.
- Tie a red cloth to an outside mirror.

#### Warning

Snow can trap engine exhaust under the vehicle. This may cause exhaust gases to get inside. Engine exhaust contains carbon monoxide (CO) which cannot be seen or smelled. It can cause unconsciousness and even death.

(Continued)

#### Warning (Continued)

If the vehicle is stuck in the snow:

- Clear away snow from around the base of your vehicle, especially any that is blocking the exhaust pipe.
- Check again from time to time to be sure snow does not collect there.
- Open a window about 5 cm (2 in) on the side of the vehicle that is away from the wind to bring in fresh air.
- Fully open the air outlets on or under the instrument panel.
- Adjust the climate control system to a setting that circulates the air inside the vehicle and set the fan speed to the highest setting. See “Climate Control Systems.”

(Continued)

#### Warning (Continued)

For more information about carbon monoxide, see *Engine Exhaust on page 9-21*.

To save fuel, run the engine for only short periods as needed to warm the vehicle and then shut the engine off and close the window most of the way to save heat. Repeat this until help arrives but only when you feel really uncomfortable from the cold. Moving about to keep warm also helps.

If it takes some time for help to arrive, now and then when you run the engine, push the accelerator pedal slightly so the engine runs faster than the idle speed. This keeps the battery charged to restart the vehicle and to signal for help with the headlamps. Do this as little as possible to save fuel.

## If the Vehicle Is Stuck

Slowly and cautiously spin the wheels to free the vehicle when stuck in sand, mud, ice, or snow.

If stuck too severely for the traction system to free the vehicle, turn the traction system off and use the rocking method. See *Traction Control/Electronic Stability Control* on page 9-30.

### Warning

If the vehicle's tires spin at high speed, they can explode, and you or others could be injured. The vehicle can overheat, causing an engine compartment fire or other damage. Spin the wheels as little as possible and avoid going above 56 km/h (35 mph).

## Rocking the Vehicle to Get it Out

Turn the steering wheel left and right to clear the area around the front wheels. Turn off any traction system. Shift back and forth between R (Reverse) and a low forward gear, spinning the wheels as little as possible. To prevent transmission wear, wait until the wheels stop spinning before shifting gears. Release the accelerator pedal while shifting, and press lightly on the accelerator pedal when the transmission is in gear. Slowly spinning the wheels in the forward and reverse directions causes a rocking motion that could free the vehicle. If that does not get the vehicle out after a few tries, it might need to be towed out. If the vehicle does need to be towed out, see *Towing the Vehicle* on page 10-82.

## Vehicle Load Limits

It is very important to know how much weight the vehicle can carry. This weight is called the vehicle capacity weight and includes the weight of all occupants, cargo and all nonfactory-installed options. Two labels on the vehicle show how much weight it may properly carry, the Tire and Loading Information label and the Certification label.

### Warning

Do not load the vehicle any heavier than the Gross Vehicle Weight Rating (GVWR), or either the maximum front or rear Gross Axle Weight Rating (GAWR). This can cause systems to break and change the way the

(Continued)

## 9-10 Driving and Operating

### Warning (Continued)

vehicle handles. This could cause loss of control and a crash. Overloading can also shorten the life of the vehicle.

### Tire and Loading Information Label

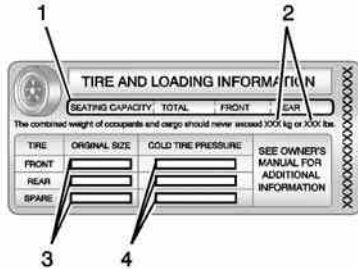

### Label Example

A vehicle-specific Tire and Loading Information label is attached to the vehicle's center

pillar (B-pillar). With the driver door open, the label is attached near the door lock post. The Tire and Loading Information label shows the number of occupant seating positions (1), and the maximum vehicle capacity weight (2) in kilograms and pounds.

The Tire and Loading Information label also shows the tire size of the original equipment tires (3) and the recommended cold tire inflation pressures (4). For more information on tires and inflation see *Tires on page 10-41* and *Tire Pressure on page 10-48*.

There is also important loading information on the Certification label. It tells you the Gross Vehicle Weight Rating (GVWR) and the Gross Axle Weight

Rating (GAWR) for the front and rear axle. See "Certification Label" later in this section.

### "Steps for Determining Correct Load Limit—

1. Locate the statement "The combined weight of occupants and cargo should never exceed XXX kg or XXX lbs." on your vehicle's placard.
2. Determine the combined weight of the driver and passengers that will be riding in your vehicle.
3. Subtract the combined weight of the driver and passengers from XXX kg or XXX lbs.
4. The resulting figure equals the available amount of cargo and luggage load capacity. For example, if the "XXX" amount equals 1400 lbs. and

there will be five 150 lb passengers in your vehicle, the amount of available cargo and luggage load capacity is 650 lbs. (1400-750 (5 x 150) = 650 lbs.)

5. Determine the combined weight of luggage and cargo being loaded on the vehicle. That weight may not safely exceed the available cargo and luggage load capacity calculated in Step 4.
6. If your vehicle will be towing a trailer, load from your trailer will be transferred to your vehicle. Consult this manual to determine how this reduces the available cargo and luggage load capacity of your vehicle."

See *Trailer Towing on page 9-63* for important information on towing a trailer, towing safety rules and trailering tips.

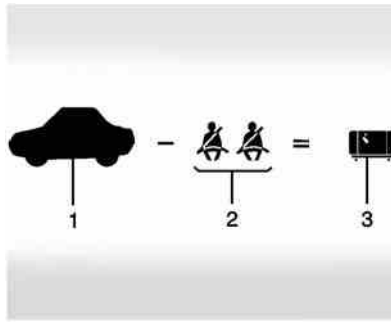

**Example 1**

1. Vehicle Capacity Weight for Example 1 = 453 kg (1,000 lbs).
2. Subtract Occupant Weight @ 68 kg (150 lbs) × 2 = 136 kg (300 lbs).
3. Available Occupant and Cargo Weight = 317 kg (700 lbs).

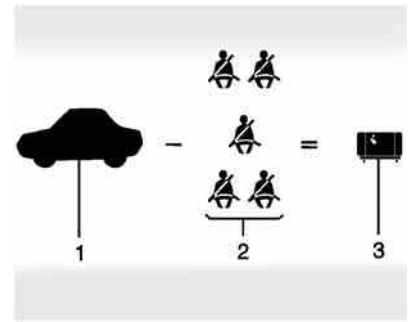

**Example 2**

1. Vehicle Capacity Weight for Example 2 = 453 kg (1,000 lbs).
2. Subtract Occupant Weight @ 68 kg (150 lbs) × 5 = 340 kg (750 lbs).
3. Available Cargo Weight = 113 kg (250 lbs).

## 9-12 Driving and Operating

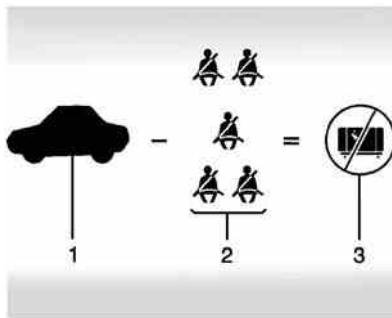

**Example 3**

1. Vehicle Capacity Weight for Example 3 = 453 kg (1,000 lbs).
2. Subtract Occupant Weight @ 91 kg (200 lbs) × 5 = 453 kg (1,000 lbs).
3. Available Cargo Weight = 0 kg (0 lbs).

Refer to the vehicle's Tire and Loading Information label for specific information about the vehicle's capacity weight and

seating positions. The combined weight of the driver, passengers, and cargo should never exceed the vehicle's capacity weight.

### Certification Label

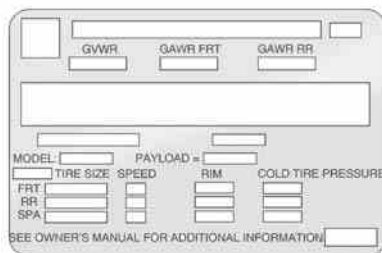

### Label Example

A vehicle-specific Certification/Tire label is attached to the driver side center pillar (B-pillar). The label shows the size of the vehicle's original tires and the inflation pressures needed to obtain the gross weight capacity of the vehicle. This is called

Gross Vehicle Weight Rating (GVWR). The GVWR includes the weight of the vehicle, all occupants, fuel, and cargo.

The Certification/Tire label also tells you the maximum weights for the front and rear axles, called Gross Axle Weight Rating (GAWR). To find out the actual loads on the front and rear axles, you need to go to a weigh station and weigh the vehicle. Your dealer can help you with this. Be sure to spread out the load equally on both sides of the center line.

Never exceed the GVWR for the vehicle, or the GAWR for either the front or rear axle.

If the vehicle is carrying a heavy load, it should be spread out. See "Steps for Determining Correct Load Limit" earlier in this section.

 **Warning**

Do not load the vehicle any heavier than the Gross Vehicle Weight Rating (GVWR), or either the maximum front or rear Gross Axle Weight Rating (GAWR). This can cause systems to break and change the way the vehicle handles. This could cause loss of control and a crash. Overloading can also shorten the life of the vehicle.

Your warranty does not cover parts or components that fail because of overloading.

The label will help you decide how much cargo and installed equipment your vehicle can carry.

Using heavier suspension components to get added durability might not change your weight ratings. Ask your dealer to help you load your vehicle the right way.

If you put things inside your vehicle – like suitcases, tools, packages, or anything else – they will go as fast as the vehicle goes. If you have to stop or turn quickly, or if there is a crash, they will keep going.

 **Warning**

Things inside the vehicle can strike and injure people in a sudden stop or turn, or in a crash.

- Put things in the cargo area of the vehicle. In the cargo area, put them as

(Continued)

**Warning (Continued)**

far forward as possible. Try to spread the weight evenly.

- Never stack heavier things, like suitcases, inside the vehicle so that some of them are above the tops of the seats.
- Do not leave an unsecured child restraint in the vehicle.
- Secure loose items in the vehicle.
- Do not leave a seat folded down unless needed.

## Starting and Operating

### New Vehicle Break-In

#### Caution

The vehicle does not need an elaborate break-in. But it will perform better in the long run if you follow these guidelines:

- Do not drive at any one constant speed, fast or slow, for the first 805 km (500 mi). Do not make full-throttle starts. Avoid downshifting to brake or slow the vehicle.
- Avoid making hard stops for the first 322 km (200 mi) or so. During this time the new brake linings are not yet broken in. Hard stops with new linings can mean premature wear and earlier replacement. Follow this

(Continued)

#### Caution (Continued)

breaking-in guideline every time you get new brake linings.

Following break-in, engine speed and load can be gradually increased.

### Adjustable Throttle and Brake Pedal

If the vehicle has this feature, the position of the throttle and brake pedals can be adjusted.

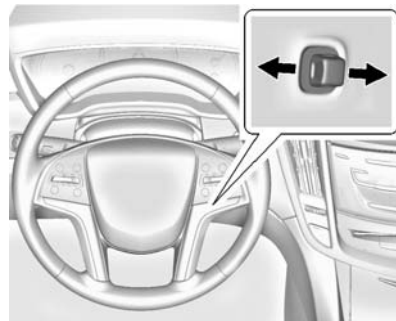

The switch used to adjust the pedals is located on the right side of the steering column, below the wiper stalk. Pull the switch toward you to move the pedals further from the floor, or push the switch away from you to move the pedals closer to the floor.

Adjust the throttle and brake pedals while the vehicle is in P (Park) without pressing on the pedals. The pedals cannot be adjusted while the vehicle is in R (Reverse) or when cruise control is engaged. The throttle and brake pedals can also be adjusted while driving.

## Ignition Positions



The vehicle has an electronic keyless ignition with pushbutton start.

Pressing the button cycles it through three modes: ACC/ACCESSORY, ON/RUN/START, and STOPPING THE ENGINE/OFF.

If the pushbutton start is not working, the vehicle may be near a strong radio antenna signal causing interference to the keyless entry system. See *Key and Lock Messages* on page 5-32.

To shift out of P (Park), the vehicle must be in ON/RUN mode and the brake pedal must be applied.

**STOPPING THE ENGINE/OFF (No Indicator Light):** When the vehicle is stopped, press the ENGINE START/STOP button once to turn the engine off.

If the vehicle is in P (Park), the ignition will turn off, and Retained Accessory Power (RAP) will remain active. See *Retained Accessory Power (RAP)* on page 9-19.

If the vehicle is not in P (Park), the ignition will return to ACC/ACCESSORY and display the message SHIFT TO PARK in the Driver Information Center (DIC). See *Driver Information Center (DIC)* on page 5-25. When the vehicle is shifted into P (Park), the ignition system will switch to OFF.

Do not turn the engine off when the vehicle is moving. This will cause a loss of power assist in the brake and steering systems and disable the airbags.

If the vehicle must be shut off in an emergency:

1. Brake using a firm and steady pressure. Do not pump the brakes repeatedly. This may deplete power assist, requiring increased brake pedal force.
2. Shift the vehicle to N (Neutral). This can be done while the vehicle is moving. After shifting to N (Neutral), firmly apply the brakes and steer the vehicle to a safe location.
3. Come to a complete stop, shift to P (Park), and turn the ignition to OFF. On vehicles with an automatic transmission, the shift lever must be in P (Park) to turn the ignition switch to the OFF position.
4. Set the parking brake. See *Parking Brake* on page 9-27.



### Warning

Turning off the vehicle while moving may cause loss of power assist in the brake and steering systems and disable the airbags. While driving, only shut the vehicle off in an emergency.

If the vehicle cannot be pulled over and must be shut off while driving, press and hold the ENGINE START/STOP button for longer than two seconds, or press twice in five seconds.

**ACC/ACCESSORY (Amber Indicator Light):** This mode allows you to use some electrical accessories when the engine is off.

With the ignition off, pressing the button one time without the brake pedal applied will place the ignition system in ACC/ACCESSORY.

The ignition will switch from ACC/ACCESSORY to OFF after 10 minutes to prevent battery rundown.

**ON/RUN/START (Green Indicator Light):** This mode is for driving and starting. With the ignition off and the brake pedal applied, pressing the button once will place the ignition system in ON/RUN/START. Once engine cranking begins, release the button. Engine cranking will continue until the engine starts. See *Starting the Gasoline Engine on page 9-16*. The ignition will then remain in ON/RUN.

### **Service Only Mode**

This power mode is available for service and diagnostics, and to verify the proper operation of the malfunction indicator lamp as may be required for emission inspection purposes. With the vehicle off, and the brake pedal not applied, pressing and holding the button for more than five seconds will place the vehicle in Service Only Mode.

The instruments and audio systems will operate as they do in ON/RUN, but the vehicle will not be able to be driven. The engine will not start in Service Only Mode. Press the button again to turn the vehicle off.

## Starting the Gasoline Engine

Place the transmission in the proper gear by moving the shift lever to P (Park) or N (Neutral). To restart the engine when the vehicle is already moving, use N (Neutral).

### Caution

Do not try to shift to P (Park) if the vehicle is moving. If you do, you could damage the transmission. Shift to P (Park) only when the vehicle is stopped.

 **Caution**

If the steering wheel is turned until it reaches the end of its travel, and is held in that position while starting the vehicle, damage may occur to the hydraulic power steering system and there may be loss of power steering assist.

 **Caution**

If you add electrical parts or accessories, you could change the way the engine operates. Any resulting damage would not be covered by the vehicle warranty. See *Add-On Electrical Equipment* on page 9-68.

To start the vehicle:

**Starting Procedure**

1. With the Keyless Access System, the RKE transmitter must be in the vehicle. Press the ENGINE START/STOP button with the brake pedal applied. When the engine begins cranking, let go of the button. The idle speed will go down as the engine warms up. Do not race the engine immediately after starting it.

If the RKE transmitter is not in the vehicle, if there is interference, or the RKE battery is low, a Driver Information Center (DIC) message will display. See *Driver Information Center (DIC)* on page 5-25 and *Remote Keyless Entry (RKE) System Operation* on page 2-3.

 **Caution**

Cranking the engine for long periods of time, by pressing the ENGINE START/STOP button immediately after cranking has ended, can overheat and damage the cranking motor, and drain the battery. Wait at least 15 seconds between each try, to let the cranking motor cool down.

2. If the engine does not start after five to 10 seconds, especially in very cold weather (below  $-18^{\circ}\text{C}$  or  $0^{\circ}\text{F}$ ), it could be flooded with too much gasoline. Try pushing the accelerator pedal all the way to the floor and holding it there as you press the ENGINE START/STOP button, for up to a maximum of 15 seconds. Wait at least 15 seconds between each try, to allow the cranking motor to cool down. When the engine starts, let go of the button and the

accelerator. If the vehicle starts briefly but then stops again, do the same thing. This clears the extra gasoline from the engine. Do not race the engine immediately after starting it. Operate the engine and transmission gently until the oil warms up and lubricates all moving parts.

### Engine Heater

The engine coolant heater, if available, can help in cold weather conditions at or below  $-18^{\circ}\text{C}$  ( $0^{\circ}\text{F}$ ) for easier starting and better fuel economy during engine warm-up. Plug in the coolant heater at least four hours before starting the vehicle. An internal thermostat in the plug end of the cord will prevent engine coolant heater operation at temperatures above  $-18^{\circ}\text{C}$  ( $0^{\circ}\text{F}$ ).

### To Use the Engine Coolant Heater

1. Turn off the engine.
2. Open the hood and unwrap the electrical cord. The cord is located near the air cleaner.  
  
Check the heater cord for damage. If it is damaged, do not use it. See your dealer for a replacement. Inspect the cord for damage yearly.
3. Plug it into a normal, grounded 110-volt AC outlet.

#### Warning

Improper use of the heater cord or an extension cord can damage the cord and may result in overheating and fire.

- Plug the cord into a three-prong electrical utility receptacle that is protected by a ground fault detection

(Continued)

#### Warning (Continued)

function. An ungrounded outlet could cause an electric shock.

- Use a weatherproof, heavy-duty, 15 amp-rated extension cord if needed. Failure to use the recommended extension cord in good operating condition, or using a damaged heater or extension cord, could make it overheat and cause a fire, property damage, electric shock, and injury.
- Do not operate the vehicle with the heater cord permanently attached to the

(Continued)

**Warning (Continued)**

vehicle. Possible heater cord and thermostat damage could occur.

- While in use, do not let the heater cord touch vehicle parts or sharp edges. Never close the hood on the heater cord.
- Before starting the vehicle, unplug the cord, reattach the cover to the plug, and securely fasten the cord. Keep the cord away from any moving parts.

4. Before starting the engine, be sure to unplug and store the cord as it was before to keep it away from moving engine parts. If you do not it could be damaged.

The length of time the heater should remain plugged in depends on several factors. Ask a dealer in the area where you will be parking the vehicle for the best advice on this.

**Retained Accessory Power (RAP)**

These accessories can be used after the engine is turned off:

- Infotainment system (up to 10 minutes or until the driver door is opened).
- Power windows, sunroof (if equipped), and power outlets (up to 10 minutes or until any door is opened).

**Shifting Into Park**

1. Hold the brake pedal down and set the parking brake. See *Parking Brake on page 9-27*.
2. Move the shift lever into P (Park) by pushing the lever all the way toward the front of the vehicle.

3. Turn the ignition off.

**Leaving the Vehicle with the Engine Running** **Warning**

It can be dangerous to leave the vehicle with the engine running. It could overheat and catch fire.

It is dangerous to get out of the vehicle if the shift lever is not fully in P (Park) with the parking brake firmly set. The vehicle can roll.

Do not leave the vehicle when the engine is running. If you have left the engine running, the vehicle can move suddenly. You or others could be injured. To be sure the vehicle will not move, even when you are on fairly level ground, always set the parking brake and move the shift lever to P (Park). See *Shifting Into Park on*

(Continued)

### Warning (Continued)

*page 9-19.* If you are towing a trailer, see *Driving Characteristics and Towing Tips on page 9-60.*

If you have to leave the vehicle with the engine running, be sure the vehicle is in P (Park) and the parking brake is firmly set before you leave it. After you have moved the shift lever into P (Park), hold down the regular brake pedal. See if you can move the shift lever away from P (Park) without first pulling it toward you. If you can, it means that the shift lever was not fully locked into P (Park).

### Torque Lock

Torque lock is when the weight of the vehicle puts too much force on the parking pawl in the transmission. This happens when parking on a hill and shifting the transmission into P (Park) is not done properly and then it is difficult

to shift out of P (Park). To prevent torque lock, set the parking brake and then shift into P (Park). To find out how, see "Shifting Into P (Park)" listed previously.

If torque lock does occur, your vehicle may need to be pushed uphill by another vehicle to relieve the parking pawl pressure, so you can shift out of P (Park).

If you are towing a trailer and parking on a hill, see *Driving Characteristics and Towing Tips on page 9-60.*

### Shifting out of Park

This vehicle is equipped with an automatic transmission shift lock control system. The shift lock control is designed to prevent movement of the shift lever out of P (Park), unless the ignition is in ON/RUN and the brake pedal is applied.

The shift lock control is always functional except in the case of an uncharged or low voltage (less than 9-volt) battery.

If the vehicle has an uncharged battery or a battery with low voltage, try charging or jump starting the battery. See *Jump Starting on page 10-78.*

To shift out of P (Park):

1. Apply the brake pedal.
2. Press the ENGINE START/STOP button.
3. Press the shift lever button.
4. Move the shift lever to the desired position.

If you still are unable to shift out of P (Park):

1. Fully release the shift lever button.
2. Hold the brake pedal down and press the shift lever button again.

3. Move the shift lever to the desired position.

If you still cannot move the shift lever from P (Park), consult your dealer or a professional towing service.

## Parking over Things That Burn

### Warning

Things that can burn could touch hot exhaust parts under the vehicle and ignite. Do not park over papers, leaves, dry grass, or other things that can burn.

## Engine Exhaust

### Warning

Engine exhaust contains carbon monoxide (CO) which cannot be seen or smelled. Exposure to CO can cause unconsciousness and even death.

Exhaust may enter the vehicle if:

- The vehicle idles in areas with poor ventilation (parking garages, tunnels, deep snow that may block underbody airflow or tail pipes).
- The exhaust smells or sounds strange or different.
- The exhaust system leaks due to corrosion or damage.
- The vehicle exhaust system has been modified, damaged, or improperly repaired.

(Continued)

### Warning (Continued)

- There are holes or openings in the vehicle body from damage or aftermarket modifications that are not completely sealed.

If unusual fumes are detected or if it is suspected that exhaust is coming into the vehicle:

- Drive it only with the windows completely down.
- Have the vehicle repaired immediately.

Never park the vehicle with the engine running in an enclosed area such as a garage or a building that has no fresh air ventilation.

### Running the Vehicle While Parked

It is better not to park with the engine running.

If the vehicle is left with the engine running, follow the proper steps to be sure the vehicle will not move. See *Shifting Into Park* on page 9-19 and *Engine Exhaust* on page 9-21.

If parking on a hill and pulling a trailer, see *Driving Characteristics and Towing Tips* on page 9-60.

### Automatic Transmission

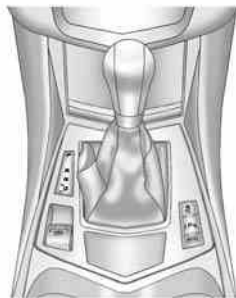

There are several different positions for the shift lever.

**P (Park):** This position locks the front wheels. It is the best position to use when you start the engine because the vehicle cannot move easily.

#### Warning

It is dangerous to get out of the vehicle if the shift lever is not fully in P (Park) with the parking brake firmly set. The vehicle can roll.

Do not leave the vehicle when the engine is running. If you have left the engine running, the vehicle can move suddenly. You or others could be injured. To be sure the vehicle will not move, even when you are on fairly level ground, always set the parking brake and move the shift lever to P (Park). See *Shifting Into Park* on page 9-19 and *Driving Characteristics and Towing Tips* on page 9-60.

Make sure the shift lever is fully in P (Park) before starting the engine. The vehicle has an automatic transmission shift lock control system. You must fully apply the regular brakes first and then press

the shift lever button before you can shift from P (Park) when the ignition is in ON/RUN. If you cannot shift out of P (Park), ease pressure on the shift lever and push the shift lever all the way into P (Park) as you maintain brake application. Then press the shift lever button and move the shift lever into another gear. See *Shifting out of Park on page 9-20*.

 **Caution**

Shifting to R (Reverse) while the vehicle is moving forward could damage the transmission. The repairs would not be covered by the vehicle warranty. Shift to R (Reverse) only after the vehicle is stopped.

**R (Reverse):** Use this gear to back up.

At low vehicle speeds, R (Reverse) can be used to rock the vehicle back and forth to get out of snow,

ice, or sand without damaging your transmission. See *If the Vehicle Is Stuck on page 9-9*.

**N (Neutral):** In this position, the engine does not connect with the wheels. To restart when the vehicle is already moving, use N (Neutral) only. You can also use N (Neutral) when the vehicle is being towed.

 **Warning**

Shifting into a drive gear while the engine is running at high speed is dangerous. Unless your foot is firmly on the brake pedal, the vehicle could move very rapidly. You could lose control and hit people or objects. Do not shift into a drive gear while the engine is running at high speed.

 **Caution**

Shifting out of P (Park) or N (Neutral) with the engine running at high speed may damage the transmission. The repairs would not be covered by the vehicle warranty. Be sure the engine is not running at high speed when shifting the vehicle.

**D (Drive):** This position is for normal driving. It provides the best fuel economy. If you need more power for passing, and you are:

- Going less than 35 mph (55 km/h), push the accelerator pedal about halfway down.
- Going about 35 mph (55 km/h) or more, push the accelerator all the way down.

The transmission will shift down to a lower gear and have more power.



Downshifting the transmission in slippery road conditions could result in skidding. See “Skidding” under *Loss of Control* on page 9-5.

### Caution

Spinning the tires or holding the vehicle in one place on a hill using only the accelerator pedal may damage the transmission. The repair will not be covered by the vehicle warranty. If you are stuck, do not spin the tires. When stopping on a hill, use the brakes to hold the vehicle in place.

## Manual Mode

### Driver Shift Control (DSC)

#### Caution

Driving with the engine at a high rpm without upshifting while using Driver Shift Control (DSC), could damage the vehicle. Always upshift when necessary while using DSC.

DSC allows you to shift an automatic transmission similar to a manual transmission. To use the DSC feature:

1. Move the shift lever to the left from D (Drive) to M (Manual Mode).

If you do not move the shift lever forward or rearward, the vehicle will be in Sport Mode. When you are in Sport Mode the vehicle will still shift automatically. The transmission may remain in a gear longer than it would in the normal driving mode based on braking, throttle input, and vehicle lateral acceleration.

SPORT MODE ON will be displayed in the DIC. See *Ride Control System Messages* on page 5-36. The word “sport” will display below the odometer. The gear position will also be indicated in the tachometer.

Within Sport Mode there is a further performance feature called Performance Mode Lift Foot (PMLF) Mode. The feature is activated automatically when sports oriented driving is detected, based on cornering and on/off throttle application. PMLF allows the transmission to

hold the current gear instead of upshifting when the throttle is lifted.

- To enter M (Manual Mode), press the shift lever forward to upshift or rearward to downshift.

An M will be displayed in the DIC.

- To return to Sport Mode from M (Manual Mode), press and briefly hold the shift lever forward.

Gear position is indicated in the bottom right corner of the display area in the instrument cluster. The number indicates the requested gear range when moving the shift lever forward or rearward.

While using the DSC feature, the vehicle will have firmer, quicker shifting. You can use this for sport driving or when climbing or descending hills, to stay in gear longer, or to downshift for more power or engine braking.

The transmission will only allow you to shift into gears appropriate for the vehicle speed and engine revolutions per minute (rpm). The transmission will not automatically shift to the next lower gear if the engine rpm is too high, nor to the next higher gear when the maximum engine rpm is reached.

If shifting is prevented for any reason, the currently selected gear will flash multiple times, indicating that the transmission has not shifted gears.

While in the DSC mode, the transmission will automatically downshift when the vehicle comes to a stop. This will allow for more power during take-off.

When accelerating the vehicle from a stop in snowy and icy conditions, you may want to shift into second gear. A higher gear ratio allows you to gain more traction on slippery surfaces.

## Fuel Economy Mode

Driving habits can affect fuel mileage. For driving tips to get the best fuel economy possible, see *Driving for Better Fuel Economy* on page 1-20.

The vehicle may have a fuel economy mode. When engaged, fuel economy mode can improve the vehicle's fuel economy.

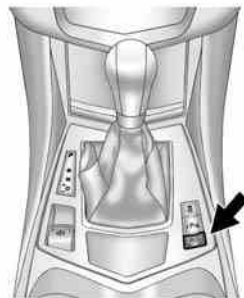

Pressing the eco button by the shift lever will engage fuel economy mode. When activated, the eco light in the instrument cluster will come

on. See *Fuel Economy Light* on page 5-23. Pressing the button a second time will turn fuel economy mode off.

When fuel economy mode is on:

- The transmission will upshift sooner, and downshift later.
- The torque converter will lock up sooner, and stay on longer.
- The gas pedal will be less sensitive.
- The vehicle's computers will more aggressively shut off fuel to the engine under deceleration.
- The engine operates at lower rpm's in fuel economy mode, which can increase noise and vibration. This is normal.

## Drive Systems

### All-Wheel Drive

Vehicles with this feature transfer torque as required to the rear wheels. It is fully automatic, and adjusts itself as needed for road conditions.

AWD system performance will be automatically reduced when you use the compact spare. To restore full AWD operation and prevent excessive wear on the system, replace the compact spare with a full-size tire as soon as possible. See *Compact Spare Tire* on page 10-77.

## Brakes

### Antilock Brake System (ABS)

This vehicle has ABS, an advanced electronic braking system that helps prevent a braking skid.

When the vehicle begins to drive away, ABS checks itself. A momentary motor or clicking noise might be heard while this test is going on, and it might even be noticed that the brake pedal moves a little. This is normal.



If there is a problem with ABS, this warning light stays on. See *Antilock Brake System (ABS) Warning Light* on page 5-19.

If driving safely on a wet road and it becomes necessary to slam on the brakes and continue braking to avoid a sudden obstacle, a computer senses the wheels are slowing down. If one of the wheels is about to stop rolling, the computer will separately work the brakes at each wheel.

ABS can change the brake pressure to each wheel, as required, faster than any driver could. This can help you steer around the obstacle while braking hard.

As the brakes are applied, the computer keeps receiving updates on wheel speed and controls braking pressure accordingly.

Remember: ABS does not change the time needed to get a foot up to the brake pedal or always decrease stopping distance. If you get too close to the vehicle in front of you, there will not be enough time to apply the brakes if that vehicle

suddenly slows or stops. Always leave enough room up ahead to stop, even with ABS.

### Using ABS

Do not pump the brakes. Just hold the brake pedal down firmly and let ABS work. You may hear the ABS pump or motor operating and feel the brake pedal pulsate. This is normal.

### Braking in Emergencies

ABS allows you to steer and brake at the same time. In many emergencies, steering can help more than even the very best braking.

## Parking Brake

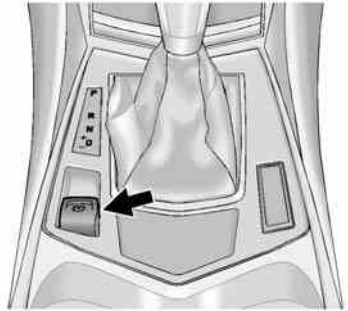

The Electric Parking Brake (EPB) switch is on the center console. The EPB can always be activated, even if the ignition is off. To prevent draining the battery, avoid repeated cycles of the EPB when the engine is not running.

The system has a red parking brake status light and an amber parking brake warning light. See *Electric Parking Brake Light* on page 5-18 and *Service Electric Parking Brake Light* on page 5-19. There are also

## 9-28 Driving and Operating

---

parking brake-related Driver Information Center (DIC) messages. See *Brake System Messages on page 5-28*. In case of insufficient electrical power, the EPB cannot be applied or released.

Before leaving the vehicle, check the red parking brake status light to ensure that the parking brake is applied.

### EPB Apply

To apply the EPB:

1. Be sure the vehicle is at a complete stop.
2. Lift up the EPB switch momentarily.

The red parking brake status light will flash and then stay on once the EPB is fully applied. If the red parking brake status light flashes continuously, then the EPB is only partially applied or there is a problem with the EPB. A DIC message will display. Release the EPB and try to apply it again. If the light does not come on, or keeps

flashing, have the vehicle serviced. Do not drive the vehicle if the red parking brake status light is flashing. See your dealer. See *Electric Parking Brake Light on page 5-18*.

If the amber parking brake warning light is on, lift up on the EPB switch and hold it up. Continue to hold the switch until the red parking brake status light remains on. If the amber parking brake warning light remains on, see your dealer.

If the EPB is applied while the vehicle is moving, the vehicle will decelerate as long as the switch is held up. If the switch is held up until the vehicle comes to a stop, the EPB will remain applied.

The vehicle may automatically apply the EPB in some situations when the vehicle is not moving. This is normal, and is done to periodically check the correct operation of the EPB system.

If the EPB fails to apply, the rear wheels should be blocked to prevent vehicle movement.

### EPB Release

To release the EPB:

1. Place the ignition in the ACC/ACCESSORY or ON/RUN position.
2. Apply and hold the brake pedal.
3. Push down momentarily on the EPB switch.

The EPB is released when the red parking brake status light is off.

If the amber parking brake warning light is on, release the EPB by pushing down on the EPB switch and holding it down. Continue to hold the switch until the red parking brake status light is off. If either light stays on after release is attempted, see your dealer.

 **Caution**

Driving with the parking brake on can overheat the brake system and cause premature wear or damage to brake system parts. Make sure that the parking brake is fully released and the brake warning light is off before driving.

### Automatic EPB Release

The EPB automatically releases differently on vehicles with Adaptive Cruise Control. Avoid rapid acceleration when the EPB is applied, to preserve parking brake lining life.

- With Adaptive Cruise Control, the parking brake will automatically release with the engine running, the brake pedal applied, and the transmission is shifted out of P (Park).

- Without Adaptive Cruise Control, the parking brake will automatically release when the engine is running, the transmission is placed into gear, and an attempt is made to drive away by pressing the accelerator pedal.

If parking on a hill, or if the vehicle is pulling a trailer, see *Driving Characteristics and Towing Tips* on page 9-60.

### Brake Assist

The Brake Assist feature is designed to assist the driver in stopping or decreasing vehicle speed in emergency driving conditions. This feature uses the stability system hydraulic brake control module to supplement the power brake system under conditions where the driver has quickly and forcefully applied the brake pedal in an attempt to quickly

stop or slow down the vehicle. The stability system hydraulic brake control module increases brake pressure at each corner of the vehicle until the ABS activates. Minor brake pedal pulsation or pedal movement during this time is normal and the driver should continue to apply the brake pedal as the driving situation dictates. The Brake Assist feature will automatically disengage when the brake pedal is released or brake pedal pressure is quickly decreased.

### Hill Start Assist (HSA)

This vehicle has an HSA feature, which may be useful when the vehicle is stopped on a grade sufficient enough to activate HSA. This feature is designed to prevent the vehicle from rolling, either forward or rearward, during vehicle

drive off. After the driver completely stops and holds the vehicle in a complete standstill on a grade, HSA will be automatically activated. During the transition period between when the driver releases the brake pedal and starts to accelerate to drive off on a grade, HSA holds the braking pressure for a maximum of two seconds to ensure that there is no rolling. The brakes will automatically release when the accelerator pedal is applied within the two-second window. It will not activate if the vehicle is in a drive gear and facing downhill, or if the vehicle is facing uphill and in R (Reverse).

## Ride Control Systems

### Traction Control/ Electronic Stability Control

#### System Operation

The vehicle has a Traction Control System (TCS) and StabiliTrak<sup>®</sup>, an electronic stability control system. These systems help limit wheel slip and assist the driver in maintaining control, especially on slippery road conditions.

TCS activates if it senses that any of the drive wheels are spinning or beginning to lose traction. When this happens, TCS applies the brakes to the spinning wheels and reduces engine power to limit wheel spin.

StabiliTrak activates when the vehicle senses a difference between the intended path and the direction the vehicle is actually traveling. StabiliTrak selectively applies braking pressure to any one of the

vehicle wheel brakes to assist the driver in keeping the vehicle on the intended path. Trailer Sway Control (TSC) is also on automatically when the vehicle is started. See *Trailer Sway Control (TSC)* on page 9-67.

If cruise control is being used and traction control or StabiliTrak begins to limit wheel spin, cruise control will disengage. Cruise control may be turned back on when road conditions allow.

Both systems come on automatically when the vehicle is started and begins to move. The systems may be heard or felt while they are operating or while performing diagnostic checks. This is normal and does not mean there is a problem with the vehicle.

It is recommended to leave both systems on for normal driving conditions, but it may be necessary to turn TCS off if the vehicle gets stuck in sand, mud, ice, or snow.

See *If the Vehicle Is Stuck on page 9-9* and “Turning the Systems Off and On” later in this section.



The indicator light for both systems is in the instrument cluster. This light will:

- Flash when TCS is limiting wheel spin.
- Flash when StabiliTrak is activated.
- Turn on and stay on when either system is not working.

If either system fails to turn on or to activate, a message displays in the Driver Information Center (DIC), and  comes on and stays on to indicate that the system is inactive and is not assisting the driver in

maintaining control. The vehicle is safe to drive, but driving should be adjusted accordingly.

If  comes on and stays on:

1. Stop the vehicle.
2. Turn the engine off and wait 15 seconds.
3. Start the engine.

Drive the vehicle. If  comes on and stays on, the vehicle may need more time to diagnose the problem. If the condition persists, see your dealer.

### Turning the Systems Off and On







OFF

The button for TCS and StabiliTrak is on the center stack.

### Caution

Do not repeatedly brake or accelerate heavily when TCS is off. The vehicle driveline could be damaged.

To turn off only TCS, press and release the  button. The traction off light  displays in the instrument cluster. The appropriate message is displayed in the DIC. See *Ride Control System Messages on page 5-36*.



To turn TCS on again, press and release the  button. The traction off light  displayed in the instrument cluster will turn off. The appropriate message is displayed in the DIC. See *Ride Control System Messages on page 5-36*.



If TCS is limiting wheel spin when the  button is pressed, the system will not turn off until the wheels stop spinning.



## 9-32 Driving and Operating

---

To turn off both TCS and StabiliTrak, press and hold the  button until the traction off light  and the StabiliTrak OFF light  come on and stay on in the instrument cluster. The appropriate message is displayed in the DIC. See *Ride Control System Messages on page 5-36*.

To turn TCS and StabiliTrak on again, press and release the  button. The traction off light  and the StabiliTrak OFF light  in the instrument cluster turn off. The appropriate message is displayed in the DIC. See *Ride Control System Messages on page 5-36*.

Adding accessories can affect the vehicle performance. See *Accessories and Modifications on page 10-3*.

### Limited-Slip Rear Axle

Vehicles with a limited-slip rear axle can give more traction on snow, mud, ice, sand, or gravel. When traction is low, this feature allows the drive wheel with the most traction to move the vehicle. The limited-slip rear axle also gives the driver enhanced control when cornering hard or completing a maneuver, such as a lane change.

### Selective Ride Control

The vehicle may have a ride control system called Selective Ride Control. The setting can be changed at any time. Based on road conditions, steering wheel angle, and the vehicle speed, the system automatically adjusts to provide the best handling while providing a smooth ride. The Tour and Sport modes will feel similar on a smooth road.

**Tour:** Use for normal city and highway driving. This setting provides a smooth, soft ride.

**Sport:** Use where road conditions or personal preference demand more control. This setting provides more “feel,” or response to road conditions through increased steering effort and suspension control. Transmission shift points and shift firmness are also enhanced.

The vehicle is normally in the Tour Mode. To switch from Tour Mode to Sport Mode, move the shift lever to the left while the transmission is in D (Drive). Sport Mode is automatically engaged when the shift lever is moved to the left. Moving the shift lever forward or rearward will put the transmission in the M (Manual) Mode.

The Driver Information Center (DIC) will display SPORT MODE ON when the Sport Mode has been activated. When the shift lever is moved to the right in D (Drive), the system will revert back to Tour Mode. See *Manual Mode on page 9-24* under Automatic Transmission.

If there is a problem detected with Selective Ride Control, SERVICE SUSPENSION SYSTEM displays on the DIC. See *Ride Control System Messages on page 5-36*. Driving should be adjusted accordingly.

## Cruise Control

With cruise control, a speed of about 40 km/h (25 mph) or more can be maintained without keeping your foot on the accelerator. Cruise control does not work at speeds below about 40 km/h (25 mph).

### Warning

Cruise control can be dangerous where you cannot drive safely at a steady speed. Do not use cruise control on winding roads or in heavy traffic.

Cruise control can be dangerous on slippery roads. On such roads, fast changes in tire traction can cause excessive wheel slip, and you could lose control. Do not use cruise control on slippery roads.

If the StabiliTrak<sup>®</sup> system begins to limit wheel spin while using cruise control, the cruise control automatically disengages. See

*Traction Control/Electronic Stability Control on page 9-30*. If a collision alert occurs when cruise control is activated, cruise control is disengaged. See *Forward Collision Alert (FCA) System on page 9-48*. When road conditions allow the cruise control to be safely used, you can apply the cruise control again.

If the brakes are applied, cruise control disengages.

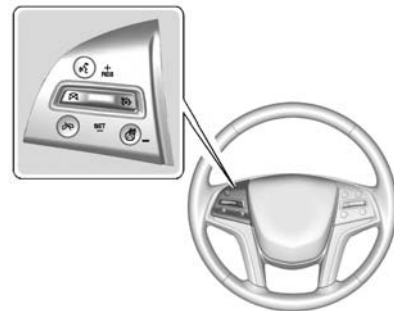

## 9-34 Driving and Operating

 **(On/Off):** Press to turn the system on and off. A white indicator appears in the instrument cluster when cruise is turned on.

**+RES (Resume/Accelerate):** If there is a set speed in memory, press the control up briefly to resume to that speed or press and hold to accelerate. If cruise control is already active, use to increase vehicle speed.

**SET- (Set/Coast):** Press the control down briefly to set the speed and activate cruise control. If cruise control is already active, use to decrease vehicle speed.

 **(Cancel):** Press to disengage cruise control without erasing the set speed from memory.

### Setting Cruise Control

If the  button is on when not in use, SET- or +RES could get pressed and the vehicle could go

into cruise when not desired. Keep the  button off when cruise is not being used.

1. Press  to turn the cruise system on.
2. Get up to the desired speed.
3. Move the control down to SET- and release it.
4. Remove foot from the accelerator pedal.

The cruise control indicator on the instrument cluster turns green after the cruise control has been set to the desired speed. See *Instrument Cluster on page 5-9*.

### Resuming a Set Speed

If the cruise control is set at a desired speed and then the brakes are applied or  is pressed, the cruise control is disengaged without erasing the set speed from memory.

Once the vehicle reaches about 40 km/h (25 mph) or more, press +RES up briefly. The vehicle returns to the previous set speed.

### Increasing Speed While Cruise Control is at a Set Speed

If the cruise control system is already activated:

- Press and hold +RES up until the vehicle accelerates to the desired speed, then release it.
- To increase vehicle speed in small increments, press +RES up briefly. For each press, the vehicle goes about 1.6 km/h (1 mph) faster.

The speedometer reading can be displayed in either English or metric units. See *Instrument Cluster on page 5-9*. The increment value used depends on the units displayed.

### Reducing Speed While Cruise Control is at a Set Speed

If the cruise control system is already activated:

- Press and hold SET- down until the desired lower speed is reached, then release it.
- To slow down in small increments, press SET- down briefly. For each press, the vehicle goes about 1.6 km/h (1 mph) slower.

The speedometer reading can be displayed in either English or metric units. See *Instrument Cluster on page 5-9*. The increment value used depends on the units displayed.

### Passing Another Vehicle While Using Cruise Control

Use the accelerator pedal to increase the vehicle speed. When you take your foot off the pedal, the vehicle will slow down to the previously set cruise speed. While pressing the accelerator pedal or shortly following the release to



override cruise control, briefly pressing SET- will result in cruise set to the current vehicle speed.

### Using Cruise Control on Hills

How well the cruise control will work on hills depends upon the vehicle speed, load, and the steepness of the hills. When going up steep hills, you might have to step on the accelerator pedal to maintain your speed. When going downhill, you might have to brake or shift to a lower gear to keep your speed down. If the brake pedal is applied, the cruise control will disengage.

### Ending Cruise Control

There are four ways to end cruise control:

- Step lightly on the brake pedal.
- Press .
- Shift the transmission to N (Neutral).
- To turn off the cruise control, press .

### Erasing Speed Memory

The cruise control set speed is erased from memory if  is pressed or if the ignition is turned off.

### Adaptive Cruise Control

If equipped with Adaptive Cruise Control (ACC), it allows the driver to select the cruise control set speed and following gap. Read this entire section before using this system. The following gap is the following time between your vehicle and a vehicle detected directly ahead in your path moving in the same direction. If no vehicle is detected in your path, ACC works like regular cruise control. ACC uses camera and radar sensors. See *Radio Frequency Statement on page 13-12*.

If a vehicle is detected in your path, ACC can apply acceleration or limited, moderate braking to maintain the selected following gap. To disengage ACC, apply the brake.

## 9-36 Driving and Operating

If ACC is controlling your vehicle speed when the traction control system (TCS) or electronic stability control system activates, the ACC may automatically disengage. See *Traction Control/Electronic Stability Control on page 9-30*. When road conditions allow ACC to be safely used, the ACC can be turned back on.

ACC will not engage if the TCS or StabiliTrak electronic stability control system is disabled.

### **Warning**

ACC has limited braking ability and may not have time to slow the vehicle down enough to avoid a collision with another vehicle you are following. This can occur when vehicles suddenly slow or stop ahead, or enter your lane. Also see "Alerting the Driver" in this section. Complete attention is always required while driving and

(Continued)

### **Warning (Continued)**

you should be ready to take action and apply the brakes. See *Defensive Driving on page 9-3*.

### **Warning**

Adaptive Cruise Control will not detect or brake for children, pedestrians, animals, or other objects.

Do not use Adaptive Cruise Control when:

- On winding and hilly roads or when the sensors are blocked by snow, ice, or dirt. The system may not detect a vehicle ahead. Keep the entire front of the vehicle clean.

(Continued)

### **Warning (Continued)**

- Visibility is low, such as in fog, rain, or snow conditions. Adaptive Cruise Control performance is limited under these conditions.
- On slippery roads where fast changes in tire traction can cause excessive wheel slip.

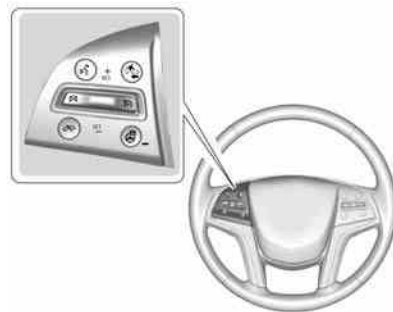

 **(On/Off):** Press to turn the system on or off. A white cruise control indicator comes on.

**+RES (Resume/Accelerate):** Press the control up briefly to resume to the previous set speed or hold upwards to accelerate. If cruise control is already active, use to increase vehicle speed.

**SET- (Set/Coast):** Press the control down briefly to set the speed and activate ACC. If cruise control is already active, use to decrease vehicle speed.

 **(Cancel):** Press to disengage ACC without erasing the set speed from memory.

 **(Follow Distance Gap):** Press to select a following gap time (or distance) setting for ACC of Far, Medium, or Near.

### Setting Adaptive Cruise Control

If cruise control is on when not in use, the cruise control on/off control could get pressed and cruise control

could become active when not desired. Keep the cruise control off when cruise is not being used.

Select the set speed desired for cruise. This is the vehicle speed when no vehicle is detected in its path slower than the set speed.

ACC will not set at a speed less than 25 km/h (16 mph), although it can be resumed when driving at lower speeds.

To set ACC:

1. Press .
2. Get up to the desired speed.
3. Press and release the SET- control.
4. Remove foot from the accelerator.

After ACC is set, it may immediately apply the brakes if a vehicle ahead is detected closer than the selected following gap.



The ACC indicator displays on the instrument cluster. When the ACC is active, the indicator turns green.

Be mindful of speed limits, surrounding traffic speeds, and weather conditions when selecting the set speed.

### Resuming a Set Speed

If the ACC is set at a desired speed and then the brakes are applied, the ACC is disengaged without erasing the set speed from memory.

To begin using ACC again, press +RES up briefly. The vehicle returns to the previous set speed.

### Increasing Speed While ACC is at a Set Speed

If ACC is already activated, do one of the following:

- Use the accelerator to get to the higher speed. Press SET– down. Release the control and the accelerator pedal. The vehicle will now cruise at the higher speed.

When the accelerator pedal is pressed, ACC will not brake because it is overridden.

A warning message will appear on the Driver Information Center (DIC). See *Cruise Control Messages on page 5-29*.

- Press and hold +RES up until the desired set speed appears on the display, then release it.
- To increase vehicle speed in small increments, press +RES up briefly. For each press, the vehicle goes to the next 1 km/h (1 mph) faster mark on the speedometer.

When it is determined that there is no vehicle ahead or the vehicle ahead is beyond the selected following gap, then the vehicle speed will increase to the set speed.

The speedometer reading can be displayed in either English or metric units. See *Instrument Cluster on page 5-9*. The increment value used depends on the units displayed.

### Reducing Speed While ACC is at a Set Speed

If ACC is already activated, do one of the following:

- Use the brake to get to the desired lower speed. Press SET– down and release the accelerator pedal. The vehicle will now cruise at the lower speed.
- Press and hold SET– down until the desired lower speed is reached, then release it.

- To decrease the vehicle speed in smaller increments, press SET– down briefly. For each press, the vehicle goes to the next 1 km/h (1 mph) slower mark on the speedometer.

The speedometer reading can be displayed in either English or metric units. See *Instrument Cluster on page 5-9*. The increment value used depends on the units displayed.

### Selecting the Follow Distance

When a slower moving vehicle is detected ahead within the selected following gap, ACC will adjust the vehicle's speed and attempt to maintain the follow distance gap selected.

Press  on the steering wheel to adjust the following gap. When pressed, the current gap setting displays briefly on the instrument cluster. Subsequent presses cycle the gap button through three settings: Far, Medium, or Near.

When pressed, the current gap setting displays briefly on the instrument cluster. The gap setting will be maintained until it is changed.

Since each gap setting corresponds to a following time (Far, Medium, or Near), the following distance will vary based on vehicle speed. The faster the vehicle speed, the further back your vehicle will follow a vehicle detected ahead. Consider traffic and weather conditions when selecting the following gap. The range of selectable gaps may not be appropriate for all drivers and driving conditions.

Changing the gap setting automatically changes the alert timing sensitivity (Far, Medium, or Near) for the Forward Collision Alert (FCA) feature. See *Forward Collision Alert (FCA) System on page 9-48*.

### Alerting the Driver



If ACC is engaged, driver action may be required when ACC cannot apply sufficient braking because of approaching a vehicle too rapidly.

When this condition occurs, six red lights will flash on the windshield and either eight beeps will sound from the front, or both sides of the Safety Alert Seat will pulse five times. See "Collision/Detection Systems" under *Vehicle Personalization on page 5-39*.

See *Defensive Driving on page 9-3*.

### Approaching and Following a Vehicle



The vehicle ahead symbol is in the instrument cluster.

The vehicle ahead symbol only displays when a vehicle is detected in your vehicle's path moving in the same direction.

If this symbol is not displaying, ACC will not respond to or brake to vehicles ahead.

ACC automatically slows the vehicle down and adjusts vehicle speed to follow the vehicle in front at the selected follow gap. The vehicle speed increases or decreases to follow the vehicle in front of you, but will not exceed the set speed. It may apply limited braking, if necessary. When braking is active, the brake



lights will come on. The automatic braking may feel or sound different than if the brakes were applied manually. This is normal.

### Stationary or Very Slow-Moving Objects

#### Warning

Adaptive Cruise Control (ACC) may not detect and react to stopped or slow-moving vehicles ahead of you. For example, the system may not brake for a vehicle it has never detected moving. This can occur in stop-and-go traffic or when a vehicle suddenly appears due to a vehicle ahead changing lanes. Your vehicle may not stop and could cause a crash. Use caution when using ACC. Your complete attention is always required while driving and you should be ready to take action and apply the brakes.

### ACC Automatically Disengages

ACC may automatically disengage and the driver will need to manually apply the brakes to slow the vehicle when:

- The sensors are blocked.
- The Traction Control System (TCS) or electronic stability control system has activated or been disabled.
- There is no traffic and nothing to detect on the side of the road.
- There is a fault in the system.
- The brakes get heated.

The ACC active symbol will not be displayed when ACC is no longer active.

### Notification to Resume ACC

ACC will maintain a follow time/distance gap behind a detected vehicle and slow your vehicle to a stop behind that vehicle.

If the vehicle ahead has driven away and ACC has not resumed, the vehicle ahead symbol will flash as a reminder. In addition, the left and right sides of the Safety Alert Seat will pulse three times, or three beeps will sound. See "Alert Type" and "Go Notifier" in "Collision/Detection Systems" under *Vehicle Personalization on page 5-39*.

When the vehicle ahead drives away, press +RES or the accelerator pedal to resume ACC. If stopped for more than two minutes or if the driver door is opened and the driver safety belt is unbuckled, the ACC automatically applies the electric parking brake to hold the vehicle. The electric parking brake status light will turn on. See *Parking Brake on page 9-27*. To release the electric parking brake, press the accelerator pedal.

A DIC warning message may display indicating to shift to P (Park) before exiting the vehicle. See *Vehicle Messages on page 5-28*.

 **Warning**

If ACC has stopped the vehicle, and if ACC is disengaged, turned off, or canceled, the vehicle will no longer be held at a stop. The vehicle can move. When ACC is holding the vehicle at a stop, always be prepared to manually apply the brakes.

 **Warning**

Leaving the vehicle without placing it in P (Park) can be dangerous. Do not leave the vehicle while it is being held at a stop by ACC. Always place the vehicle in P (Park) and turn off the ignition before leaving the vehicle.

**ACC Override**

If using the accelerator pedal while ACC is active, a warning message on the DIC will indicate that automatic braking will not occur. See *Vehicle Messages on page 5-28*. ACC will resume operation when the accelerator pedal is not being pressed.

 **Warning**

The ACC will not automatically apply the brakes if your foot is resting on the accelerator pedal. You could crash into a vehicle ahead of you.

**Curves in the Road** **Warning**

On curves, ACC may not detect a vehicle ahead in your lane. You could be startled if the vehicle

(Continued)

**Warning (Continued)**

accelerates up to the set speed, especially when following a vehicle exiting or entering exit ramps. You could lose control of the vehicle or crash. Do not use ACC while driving on an entrance or exit ramp. Always be ready to use the brakes if necessary.

 **Warning**

On curves, ACC may respond to a vehicle in another lane, or may not have time to react to a vehicle in your lane. You could crash into a vehicle ahead of you, or lose control of your vehicle. Give extra attention in curves and be ready to use the brakes if necessary. Select an appropriate speed while driving in curves.

## 9-42 Driving and Operating

ACC may operate differently in a sharp curve. It may reduce the vehicle speed if the curve is too sharp.

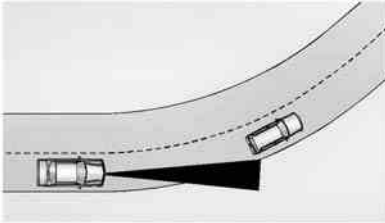

When following a vehicle and entering a curve, ACC may not detect the vehicle ahead and accelerate to the set speed. When this happens the vehicle ahead symbol will not appear.

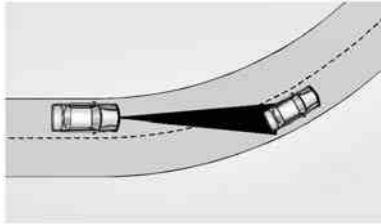

ACC may detect a vehicle that is not in your lane and apply the brakes.

ACC may occasionally provide an alert and/or braking that is considered unnecessary. It could respond to vehicles in different lanes, signs, guardrails, and other stationary objects when entering or exiting a curve. This is normal operation. The vehicle does not need service.

### Other Vehicle Lane Changes

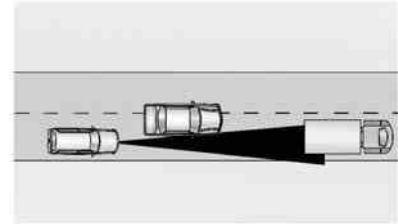

ACC will not detect a vehicle ahead until it is completely in the lane. The brake may need to be manually applied.

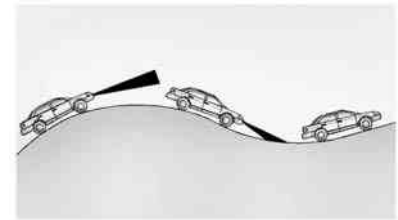

### Do Not Use ACC on Hills and When Towing a Trailer



Do not use ACC when driving on steep hills or when towing a trailer. ACC will not detect a vehicle in the lane while driving on steep hills. The driver will often need to take over acceleration and braking on steep hills, especially when towing a trailer. If the brakes are applied, the ACC disengages.

### Ending ACC

There are three ways to end ACC:

- Step lightly on the brake pedal.
- Press .
- Press .

### Erasing Speed Memory

The cruise control set speed is erased from memory if  is pressed or if the ignition is turned off.

### Cleaning the Sensing System

The camera sensor on the back of the rearview mirror and the radar sensors on the front of the vehicle can become blocked by snow, ice, dirt, or mud. These areas need to be cleaned for ACC to operate properly.

For cleaning instructions, see "Washing the Vehicle" under *Exterior Care on page 10-85*.

System operation may also be limited under snow, heavy rain or road spray conditions.

## Driver Assistance Systems

This vehicle may have features that work together to help avoid crashes or reduce crash damage while driving, backing, and parking. Read this entire section before using these systems.

### Warning

Do not rely on the Driver Assistance Systems. These systems do not replace the need for paying attention and driving safely. You may not hear or feel alerts or warnings provided by these systems. Failure to use proper care when driving may result in injury, death, or vehicle damage. See *Defensive Driving on page 9-3*.

Under many conditions, these systems will not:

(Continued)

### Warning (Continued)

- Detect children, pedestrians, bicyclists, or animals.
- Detect vehicles or objects outside the area monitored by the system.
- Work at all driving speeds.
- Warn you or provide you with enough time to avoid a crash.
- Work under poor visibility or bad weather conditions.
- Work if the detection sensor is not cleaned or is covered by ice, snow, mud, or dirt.

Complete attention is always required while driving, and you should be ready to take action and apply the brakes and/or steer the vehicle to avoid crashes.

### Audible or Safety Alert Seat

Some driver assistance features alert the driver of obstacles by beeping. To change the volume of the warning chime, see “Comfort and Convenience” under *Vehicle Personalization* on page 5-39.

If equipped with the Safety Alert Seat, the driver seat cushion may provide a vibrating pulse alert instead of beeping. To change this, see “Collision/Detection Systems” under *Vehicle Personalization* on page 5-39.

### Assistance Systems for Parking or Backing

If equipped, the Rear Vision Camera (RVC), Rear Parking Assist (RPA), Front Park Assist (FPA), Rear Automatic Braking (RAB) and Backing Warning System, and Rear Cross Traffic Alert (RCTA) may help the driver park or avoid objects. Always check around the vehicle when parking or backing.

When the vehicle is shifted into R (Reverse), the RVC displays an image of the area behind the vehicle in the center stack display. The previous screen displays when the vehicle is shifted out of R (Reverse) after a short delay. To return to the previous screen sooner, press a button on the infotainment system, shift into P (Park), or reach a vehicle speed of 8 km/h (5 mph).



### Warning

The RVC system does not display children, pedestrians, bicyclists, crossing traffic, animals, or any other object located outside the camera’s field of view, below the bumper, or under the vehicle. Perceived distances may be different from actual distances. Do not back the vehicle using only the RVC screen. Failure to use proper care before backing may result in injury, death,

(Continued)

**Warning (Continued)**

or vehicle damage. Always check behind and around the vehicle before backing.

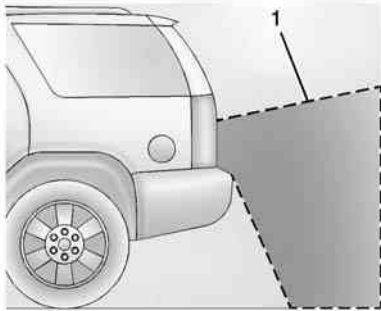

1. View Displayed by the Camera

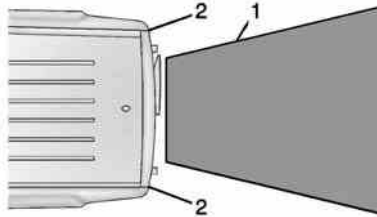

1. View Displayed by the Camera
2. Corners of the Rear Bumper

Displayed images may be farther or closer than they appear. The area displayed is limited and objects that are close to either corner of the bumper or under the bumper do not display.

A warning triangle may display on the RVC screen to show where the RPA has detected an object. This triangle changes from amber to red and increases in size the closer the object.

If equipped, Rear Cross Traffic Alert (RCTA), displays a red warning triangle with a left or right pointing

arrow on the RVC screen to warn of traffic coming from the left or right. This system detects objects coming from up to 20 m (65 ft) from the left or right side of the vehicle. When an object is detected, either three beeps sound from the left or right or three Safety Alert Seat pulses occur on the left or right side, depending on the direction of the detected vehicle.

Use caution while backing up when towing a trailer, as the RCTA detection zones that extend out from the back of the vehicle do not move further back when a trailer is towed.

With RPA, and if equipped with FPA, as the vehicle moves at speeds of less than 8 km/h (5 mph) the sensors on the bumpers may detect objects up to 2.5 m (8 ft) behind and 1.2 m (4 ft) in front of the vehicle within a zone 25 cm (10 in) high off the ground and below bumper level. These detection distances may be shorter during warmer or humid weather. Blocked sensors will not

## 9-46 Driving and Operating

detect objects and can also cause false detections. Keep the sensors clean of mud, dirt, snow, ice, and slush; and clean sensors after a car wash in freezing temperatures.

### Warning

The parking assist system does not detect children, pedestrians, bicyclists, animals, or objects located below the bumper or that are too close or too far from the vehicle. It is not available at speeds greater than 8 km/h (5 mph). To prevent injury, death, or vehicle damage, even with parking assist, always check the area around the vehicle and check all mirrors before moving forward or backing.



The instrument cluster may have a parking assist display with bars that show “distance to object” and object location information for RPA, and on some vehicles, FPA. As the object gets closer, more bars light up and the bars change color from yellow to amber to red.

When an object is first detected in the rear, one beep will be heard from the rear, or both sides of the Safety Alert Seat will pulse two times. When an object is very close (<0.6 m (2 ft) in the vehicle rear, or <0.3 m (1 ft) in the vehicle front), five beeps will sound from the front or rear depending on object location, or both sides of the Safety Alert Seat will pulse five times.

Beeps for Front Parking Assist are higher pitched than for Rear Parking Assist.

Vehicles with Adaptive Cruise Control (ACC) have the Backing Warning and Rear Automatic Braking (RAB) system. The Backing Warning part of this system can warn of rear objects when backing up at speeds greater than 8 km/h (5 mph).

The Backing Warning System will beep once from the rear when an object is first detected, or pulse twice on both sides of the Safety Alert Seat. When the system detects a potential crash, beeps will be heard from the rear, or five pulses will be felt on both sides of the Safety Alert Seat. There may also be a brief, sharp application of the brakes.

**⚠ Warning**

The Backing Warning System only operates at speeds greater than 8 km/h (5 mph). It does not detect children, pedestrians, bicyclists, animals, or objects below the bumper or that are too close or too far from the vehicle. In some situations, such as at higher backing speeds, there may not be enough time for the short, sharp application of the vehicle brake system to occur. To prevent injury, death, or vehicle damage, even with the Backing Warning System, always check the area around the vehicle and check all mirrors before backing.

When the vehicle is in R (Reverse) and if it is backing too fast to avoid a crash with a detected object directly behind the vehicle, the Rear Automatic Braking (RAB) system

may automatically brake hard to a stop to help avoid or reduce the harm caused by a backing crash.

**⚠ Warning**

Rear Automatic Braking may not avoid many types of backing crashes. Do not wait for the automatic braking to apply. This system is not designed to replace driver braking and only works in R (Reverse) when an object is detected directly behind the vehicle. It may not brake or stop in time to avoid a crash. It will not brake for objects when the vehicle is moving at very low speeds. It does not detect children, pedestrians, bicyclists, animals, or objects below the bumper or that are too close or too far from the vehicle. To prevent injury, death, or vehicle damage, even with Rear

(Continued)

**Warning (Continued)**

Automatic Braking, always check the area around the vehicle before and while backing.

Pressing the brake pedal after the vehicle comes to a stop will release the Rear Automatic Braking. If the brake pedal is not pressed soon after the stop, the Electric Parking Brake (EPB) may be set. When it is safe, press the accelerator pedal firmly at any time to override the Rear Automatic Braking.

**⚠ Warning**

There may be instances where unexpected or undesired automatic braking occurs. If this happens, either press the brake pedal or firmly press the accelerator pedal to release the brakes from the Rear Automatic

(Continued)



### Warning (Continued)

Braking system. Before releasing the brakes, check the RVC screen and check the area around the vehicle to make sure it is safe to proceed.

### Turning the Features On or Off



The  button near the shift lever is used to turn on or off the Front and Rear Parking Assist, Rear Automatic Braking, and Backing Warning System at the same time. The indicator light next to the button comes on when the features are on and turns off when the features have been disabled.

Turn off parking assist and Rear Automatic Braking when towing a trailer.

To turn the parking assist symbols or guidance lines on or off:

1. On the infotainment system, press the Settings screen button, or turn the MENU knob to highlight Settings and press MENU.
2. Select Rear Camera.
3. Press Rear Park Assist Symbols or Guidance Lines and then select Off or On.

RCTA can be turned on or off through vehicle personalization. See “Collision/Detection Systems” under *Vehicle Personalization* on page 5-39.

### Assistance Systems for Driving

If equipped, when driving the vehicle forward, Forward Collision Alert (FCA), Lane Departure Warning (LDW), Side Blind Zone Alert (SBZA), and/or the Active Emergency Braking System can help to avoid a crash or reduce crash damage.

### Forward Collision Alert (FCA) System

If equipped, the FCA system may help to avoid or reduce the harm caused by front-end crashes. When approaching a vehicle ahead too quickly, FCA provides a red flashing alert on the windshield and rapidly beeps or pulses the driver seat. FCA also lights an amber visual alert if following another vehicle much too closely.

FCA detects vehicles within a distance of approximately 60 m (197 ft) and operates at speeds above 40 km/h (25 mph). If the vehicle has Adaptive Cruise Control (ACC), it can detect vehicles to distances of approximately 110 m (360 ft) and operates at all speeds. See *Adaptive Cruise Control* on page 9-35.

### Warning

FCA is a warning system and does not apply the brakes. When approaching a slower-moving or stopped vehicle ahead too rapidly, or when following a vehicle too closely, FCA may not provide a warning with enough time to help avoid a crash. FCA does not warn of pedestrians, animals, signs, guardrails, bridges, construction barrels, or other objects. Be ready to take action and apply the brakes. For more information, see *Defensive Driving* on page 9-3.

FCA can be disabled with the FCA steering wheel control, or if your vehicle is equipped with Adaptive Cruise Control (ACC), through vehicle personalization. See the “Auto Collision Preparation” portion of “Collision/Detection Systems” under *Vehicle Personalization* on page 5-39.

### Detecting the Vehicle Ahead



FCA warnings will not occur unless the FCA system detects a vehicle ahead. When a vehicle is detected, the vehicle-ahead indicator will display green. Vehicles may not be detected on curves, highway exit ramps, or hills; or due to poor visibility. FCA will not detect another vehicle ahead until it is completely in the driving lane.

### Warning

FCA does not provide a warning to help avoid a crash, unless it detects a vehicle. FCA may not detect a vehicle ahead if the FCA sensor is blocked by dirt, snow, or ice, or if the windshield is damaged. It may also not detect a vehicle on winding or hilly roads, or in conditions that can limit visibility such as fog, rain, or snow, or if the headlamps or windshield are not cleaned or in proper condition. Keep the windshield, headlamps, and FCA sensors clean and in good repair.

### Collision Alert



## 9-50 Driving and Operating

When your vehicle approaches another detected vehicle too rapidly, the red FCA display will flash on the windshield. Also, eight rapid high-pitched beeps will sound from the front, or both sides of the Safety Alert Seat will pulse five times. When this Collision Alert occurs, the brake system may prepare for driver braking to occur more rapidly which can cause a brief, mild deceleration. Continue to apply the brake pedal as needed. Cruise control may be disengaged when the Collision Alert occurs.

### Tailgating Alert



The vehicle-ahead indicator will display amber when you are following a detected vehicle ahead much too closely.

### Selecting the Alert Timing



The Collision Alert control is on the steering wheel. Press  on the steering wheel to set the FCA timing to far, medium, near, or on some vehicles, off. The first button press shows the current setting on the DIC. Additional button presses will change this setting. The chosen setting will remain until it is changed and will affect the timing of both the Collision Alert and the Tailgating Alert features. The timing of both alerts will vary based on vehicle speed. The faster the vehicle speed,

the farther away the alert will occur. Consider traffic and weather conditions when selecting the alert timing. The range of selectable alert timing may not be appropriate for all drivers and driving conditions.

If your vehicle is equipped with Adaptive Cruise Control (ACC), changing the FCA timing setting automatically changes the following gap setting (Far, Medium, or Near).

### Unnecessary Alerts

FCA may provide unnecessary alerts for turning vehicles, vehicles in other lanes, objects that are not vehicles, or shadows. These alerts are normal operation and the vehicle does not need service.

### Cleaning the System

If the FCA system does not seem to operate properly, cleaning the outside of the windshield in front of the camera sensor on the back of the rearview mirror, and cleaning the

front of the vehicle where radar sensors are located (if equipped with ACC), may correct the issue.

## Active Emergency Braking System

If the vehicle has Adaptive Cruise Control (ACC) it also has the Active Emergency Braking System, which includes Intelligent Brake Assist (IBA) and the Automatic Collision Preparation (ACP) System. These systems can provide a boost to braking or automatically brake the vehicle to help avoid or lessen the severity of crashes when driving in a forward gear.

### Intelligent Brake Assist (IBA)

IBA may activate when the brake pedal is applied quickly by providing a boost to braking based on the speed of approach and distance to a vehicle ahead.

Minor brake pedal pulsations or pedal movement during this time is normal and the brake pedal should

continue to be applied as needed. IBA will automatically disengage only when the brake pedal is released.

### Warning

IBA may increase vehicle braking in situations when it may not be necessary. You could block the flow of traffic. If this occurs, take your foot off the brake pedal and then apply the brakes as needed.

### Automatic Collision Preparation (ACP) System

When driving in a forward gear above 4 km/h (2.5 mph), ACP may help reduce crash damage by applying the brakes. It has a detection range of approximately 60 m (197 ft). This front automatic braking can only occur if a vehicle is detected. This is shown by the FCA vehicle ahead indicator being lit. See *Forward Collision Alert (FCA) System* on page 9-48.

### Warning

ACP is an emergency crash preparation feature and is not designed to avoid crashes. Do not rely on ACP to brake the vehicle.

ACP may not:

- Respond to stopped vehicles, pedestrians, or animals.
- Detect a vehicle ahead on winding or hilly roads.
- Detect a stopped or slow-moving vehicle or other object ahead.
- Detect a vehicle when weather limits visibility, such as in fog, rain, or snow. In these situations, ACP sensor performance is limited.

(Continued)

### Warning (Continued)

Complete attention is always required while driving, and you should be ready to take action and apply the brakes and/or steer the vehicle to avoid crashes.

### Brake Preparation

When quickly approaching a vehicle ahead, Brake Preparation reduces brake response time by having the brake system prepared for driver braking to occur more rapidly.

### Automatic Braking

If ACP detects it is about to crash with the vehicle you are following that is moving or has come to a stop, and the brakes have not been applied, it may automatically brake hard. This can help to reduce crash damage and it may even help to avoid some very low speed crashes. Automatic Braking may slow the vehicle to a complete stop to try to avoid a potential crash. If this

happens, Automatic Braking may engage the Electric Parking Brake (EPB) to hold the vehicle at a stop. To release the EPB, press the EPB button. A firm press of the accelerator pedal will also release Automatic Braking and the EPB.

### Warning

Automatic Braking may automatically brake the vehicle suddenly in situations where it is unexpected and undesired. It could respond to a turning vehicle ahead, guardrails, signs, and other non-moving objects. To override Automatic Braking, firmly press the accelerator pedal, if it is safe to do so.

Automatic Braking can be disabled or reduced through vehicle personalization. See the “Auto Collision Preparation” portion of “Collision/Detection Systems” under *Vehicle Personalization on page 5-39*.

### Warning

Using the Automatic Collision Preparation System while towing a trailer could cause you to lose control of the vehicle and crash. Turn the system off when towing a trailer.

### Side Blind Zone Alert (SBZA)

If equipped, the SBZA system is a lane-changing aid that assists drivers with avoiding crashes that occur with vehicles in the side blind zone (or spot) areas. The SBZA warning display will light up in the corresponding outside side mirror and will flash if the turn signal is on.

**Warning**

SBZA does not alert the driver to vehicles rapidly approaching outside of the side blind zones, pedestrians, bicyclists, or animals. It may not provide alerts when changing lanes under all driving conditions. Failure to use proper care when changing lanes may result in injury, death, or vehicle damage. Before making a lane change, always check mirrors, glance over your shoulder, and use the turn signals.

**SBZA Detection Zones**

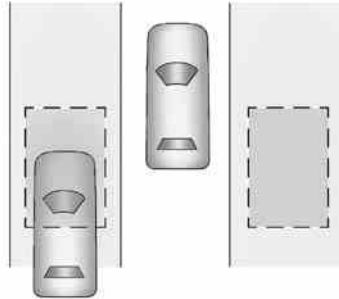

The SBZA sensor covers a zone of approximately one lane over from both sides of the vehicle, or 3.5 m (11 ft). The height of the zone is approximately between 0.5 m (1.5 ft) and 2 m (6 ft) off the ground. This zone starts at approximately the middle of the vehicle and goes back 5 m (16 ft).

**How the System Works**

The SBZA symbol lights up in the side mirrors when the system detects a vehicle in the next lane

over that is in the side blind zone. This indicates it may be unsafe to change lanes. Before making a lane change, check the SBZA display, check mirrors, glance over your shoulder, and use the turn signals.

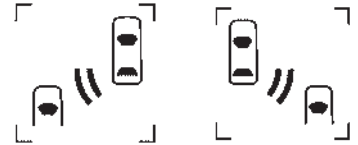

**Left Side Mirror Display      Right Side Mirror Display**

When the vehicle is started, both outside mirror SBZA displays will briefly come on to indicate the system is operating. When the vehicle is moving forward, the left or right side mirror display will light up if a vehicle is detected in that blind zone. If the turn signal is activated in the same direction of a detected vehicle, this display will flash as an extra warning not to change lanes.

SBZA can be disabled through vehicle personalization. See "Collision Detection Systems" under *Vehicle Personalization on page 5-39*. If SBZA is disabled by the driver, the SBZA mirror displays will not light up.

### **When the System Does Not Seem to Work Properly**

SBZA displays may not come on when passing a vehicle quickly or when towing a trailer. The SBZA detection zones that extend back from the side of the vehicle do not move further back when a trailer is towed. Use caution while changing lanes when towing a trailer. SBZA may alert to objects attached to the vehicle, such as a trailer, bicycle, or object extending out to either side of the vehicle. This is normal system operation; the vehicle does not need service.

SBZA may not always alert the driver to vehicles in the side blind zone, especially in wet conditions. The system does not need to be

serviced. The system may light up due to guardrails, signs, trees, shrubs, and other non-moving objects. This is normal system operation; the vehicle does not need service.

SBZA may not operate when the SBZA sensors in the left or right corners of the rear bumper are covered with mud, dirt, snow, ice, or slush, or in heavy rainstorms. For cleaning instructions, see "Washing the Vehicle" under *Exterior Care on page 10-85*. If the DIC still displays the system unavailable message after cleaning both sides of the vehicle toward the rear corners of the vehicle, see your dealer.

If the SBZA displays do not light up when vehicles are in the blind zone and the system is clean, the system may need service. Take the vehicle to your dealer.

When SBZA is disabled for any reason other than the driver turning it off, the Side Blind Zone Alert On option will not be available on the personalization menu.

### **Radio Frequency Information**

See *Radio Frequency Statement on page 13-12*.

### **Lane Departure Warning (LDW)**

If equipped, LDW may help avoid crashes due to unintentional lane departures. It may provide an alert if the vehicle is crossing a lane without using a turn signal in that direction. LDW uses a camera sensor to detect the lane markings at speeds of 56 km/h (35 mph) or greater.

### Warning

The LDW system does not steer the vehicle. The LDW system may not:

- Provide enough time to avoid a crash.
- Detect lane markings under poor weather or visibility conditions. This can occur if the windshield or headlamps are blocked by dirt, snow, or ice; if they are not in proper condition; or if the sun shines directly into the camera.
- Detect road edges.
- Detect lanes on winding or hilly roads.

If LDW only detects lane markings on one side of the road, it will only warn you when departing the lane on the side where it has detected a lane

(Continued)

### Warning (Continued)



marking. Always keep your attention on the road and maintain proper vehicle position within the lane, or vehicle damage, injury, or death could occur. Always keep the windshield, headlamps, and camera sensors clean and in good repair. Do not use LDW in bad weather conditions.

### How the System Works

The LDW camera sensor is on the windshield ahead of the rearview mirror.

To turn LDW on and off, press  near the shift lever. The control indicator will light when LDW is on.



When LDW is on,  is green if LDW is available to warn of a lane departure. If the vehicle crosses a detected lane marking without using the turn signal in that direction,  changes to amber and flashes. Additionally, there will be three beeps, or the driver seat will pulse three times, on the right or left, depending on the lane departure direction.



### When the System Does Not Seem to Work Properly

The system may not detect lanes as well when there are:

- Close vehicles ahead.
- Sudden lighting changes, such as when driving through tunnels.
- Banked roads.

If the LDW system is not functioning properly when lane markings are clearly visible, cleaning the windshield may help.

LDW alerts may occur due to tar marks, shadows, cracks in the road, temporary or construction lane markings, or other road imperfections. This is normal system operation; the vehicle does not need service. Turn LDW off if these conditions continue.

### Fuel

Use of the recommended fuel is an important part of the proper maintenance of this vehicle. When driving in the U.S. and Canada, to help keep the engine clean and maintain optimum vehicle performance, we recommend using TOP TIER Detergent Gasolines. See [www.toptiergas.com](http://www.toptiergas.com) for a list of TOP TIER Detergent Gasolines.



Use regular unleaded gasoline meeting ASTM specification D4814 with a posted octane rating of 87 or

higher. Do not use gasoline with an octane rating below 87, as it may cause engine damage and will lower fuel economy.

### Use of Seasonal Fuels

Use summer and winter fuels in the appropriate season. The fuels industry automatically modifies the fuel for the appropriate season. If fuel is left in the vehicle tank for long periods of time, driving or starting could be affected. Drive the vehicle until the fuel is at one-half tank or less, then refuel with the current seasonal fuel.

### Prohibited Fuels

Gasolines containing oxygenates such as ethers and ethanol, as well as reformulated gasolines, are available in some cities. If these gasolines comply with the previously described specification, then they are acceptable to use. However, E85 (85% ethanol) and other fuels containing more than 15% ethanol must be used only in FlexFuel vehicles.

 **Caution**

Do not use fuel containing methanol. It can corrode metal parts in the fuel system and also damage plastic and rubber parts. That damage would not be covered under the vehicle warranty.

Some gasolines, mainly high octane racing gasolines, can contain an octane-enhancing additive called methylcyclopentadienyl manganese tricarbonyl (MMT). Do not use gasolines and/or fuel additives with MMT as they can reduce spark plug life and affect emission control system performance. The malfunction indicator lamp may turn on. If this occurs, see your dealer for service.

## California Fuel Requirements

If the vehicle is certified to meet California Emissions Standards, it is designed to operate on fuels that meet California specifications. See the underhood emission control label. If this fuel is not available in states adopting California Emissions Standards, the vehicle will operate satisfactorily on fuels meeting federal specifications, but emission control system performance might be affected. The malfunction indicator lamp could turn on and the vehicle may not pass a smog-check test. See *Malfunction Indicator Lamp* on page 5-15. If this occurs, return to your authorized dealer for diagnosis. If it is determined that the condition is caused by the type of fuel used, repairs may not be covered by the vehicle warranty.

## Fuels in Foreign Countries

If planning to drive in countries outside the U.S. or Canada, the proper fuel might be hard to find. Check regional auto club or fuel retail brand websites for availability in the country where driving. Never use leaded gasoline, fuel containing methanol, manganese, or any other fuel not recommended. Costly repairs caused by use of improper fuel would not be covered by the vehicle warranty.

## Fuel Additives

To keep fuel systems clean, TOP TIER Detergent Gasoline is recommended. See *Fuel* on page 9-56.

If TOP TIER Detergent Gasoline is not available, one bottle of Fuel System Treatment PLUS added to the fuel tank at every engine oil change, can help. Fuel System Treatment PLUS is the only

gasoline additive recommended by General Motors. It is available at your dealer.

### Filling the Tank

#### Warning

Fuel vapors and fuel fires burn violently and can cause injury or death.

- To help avoid injuries to you and others, read and follow all the instructions on the fuel pump island.
- Turn off the engine when refueling.
- Keep sparks, flames, and smoking materials away from fuel.
- Do not leave the fuel pump unattended.
- Do not reenter the vehicle while pumping fuel.

(Continued)

#### Warning (Continued)

- Keep children away from the fuel pump and never let children pump fuel.
- Fuel can spray out if the fuel cap is opened too quickly. This spray can happen if the tank is nearly full, and is more likely in hot weather. Open the fuel cap slowly and wait for any hiss noise to stop then unscrew the cap all the way.

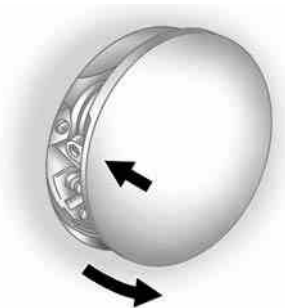

The fuel cap is located behind a hinged fuel door on the passenger side of the vehicle. If equipped, the fuel door is locked when the vehicle doors are locked. Press  on the RKE transmitter to unlock. To open the fuel door, push and release the rearward center edge of the door.

To remove the fuel cap, turn it slowly counterclockwise.

While refueling, hang the tethered fuel cap from the hook on the fuel door.

When reinstalling the cap, turn it clockwise until it clicks once, otherwise the malfunction indicator lamp could turn on. See *Malfunction Indicator Lamp on page 5-15*.

Be careful not to spill fuel. Do not top off or overfill the tank and wait a few seconds after you have finished pumping before removing the nozzle. Clean fuel from painted surfaces as soon as possible. See *Exterior Care on page 10-85*.

When replacing the fuel cap, turn it clockwise until it clicks once. Make sure the cap is fully installed. The diagnostic system can determine if the fuel cap has been left off or improperly installed. This would allow fuel to evaporate into the atmosphere. See *Malfunction Indicator Lamp on page 5-15*.

### Warning

If a fire starts while you are refueling, do not remove the nozzle. Shut off the flow of fuel by shutting off the pump or by notifying the station attendant. Leave the area immediately.

### Caution

If a new fuel cap is needed, be sure to get the right type of cap from your dealer. The wrong type of fuel cap may not fit properly, may cause the malfunction indicator lamp to light, and could damage the fuel tank and emissions system. See *Malfunction Indicator Lamp on page 5-15*.

## Filling a Portable Fuel Container

### Warning

Filling a portable fuel container while it is in the vehicle can cause fuel vapors that can ignite either by static electricity or other means. You or others could be badly burned and the vehicle could be damaged. Always:

- Use approved fuel containers.
- Remove the container from the vehicle, trunk, or pickup bed before filling.
- Place the container on the ground.

(Continued)

### Warning (Continued)

- Place the nozzle inside the fill opening of the container before dispensing fuel, and keep it in contact with the fill opening until filling is complete.
- Fill the container no more than 95% full to allow for expansion.
- Do not smoke, light matches, or use lighters while pumping fuel.
- Avoid using cell phones or other electronic devices.

## Trailer Towing

### General Towing Information

Only use towing equipment that has been designed for the vehicle. Contact your dealer or trailering dealer for assistance with preparing the vehicle for towing a trailer. Read the entire section before towing a trailer.

For towing a disabled vehicle, see *Towing the Vehicle on page 10-82*. For towing the vehicle behind another vehicle such as a motor home, see *Recreational Vehicle Towing on page 10-82*.

### Driving Characteristics and Towing Tips

#### Driving with a Trailer

When towing a trailer:

- Become familiar with the state and local laws that apply specifically to trailer towing.

- Do not tow a trailer during the first 800 km (500 mi), to prevent damage to the engine, axle or other parts.
- Then, during the first 800 km (500 mi) trailer towing, do not drive over 80 km/h (50 mph) and do not make starts at full throttle.
- The vehicle can tow in D (Drive). Use a lower gear if the transmission shifts too often.
- Do not use Adaptive Cruise Control when towing.
- The Automatic Collision Preparation System should be set to "Off" when towing. See *Active Emergency Braking System on page 9-51*.
- Turn off Park Assist when towing.

 **Warning**

When towing a trailer, exhaust gases may collect at the rear of the vehicle and enter if the liftgate, trunk/hatch, or rear-most window is open.

When towing a trailer:

- Do not drive with the liftgate, trunk/hatch, or rear-most window open.
- Fully open the air outlets on or under the instrument panel.
- Also adjust the Climate Control system to a setting that brings in only outside air. See "Climate Control Systems" in the Index.

For more information about Carbon Monoxide, see *Engine Exhaust on page 9-21*.

Towing a trailer requires a certain amount of experience. The combination you are driving is longer and not as responsive as the vehicle itself. Get acquainted with the handling and braking of the rig before setting out for the open road.

Before starting, check all trailer hitch parts and attachments, safety chains, electrical connectors, lamps, tires, and mirrors. If the trailer has electric brakes, start the combination moving and then apply the trailer brake controller by hand to be sure the brakes work.

During the trip, check occasionally to be sure that the load is secure and the lamps and any trailer brakes still work.

### **Towing with a Stability Control System**

When towing, the sound of the stability control system might be heard. The system is reacting to the vehicle movement caused by the

trailer, which mainly occurs during cornering. This is normal when towing heavier trailers.

### **Following Distance**

Stay at least twice as far behind the vehicle ahead as you would when driving the vehicle without a trailer. This can help to avoid situations that require heavy braking and sudden turns.

### **Passing**

More passing distance is needed when towing a trailer. Because the rig is longer, it is necessary to go farther beyond the passed vehicle before returning to the lane.

### **Backing Up**

Hold the bottom of the steering wheel with one hand. To move the trailer to the left, move your hand to the left. To move the trailer to the right, move your hand to the right. Always back up slowly and, if possible, have someone guide you.

### Making Turns

 **Caution**

Making very sharp turns while trailering could cause the trailer to come in contact with the vehicle. The vehicle could be damaged. Avoid making very sharp turns while trailering.

When turning with a trailer, make wider turns than normal so the trailer will not strike soft shoulders, curbs, road signs, trees or other objects. Use the turn signal well in advance and avoid jerky or sudden maneuvers.

### Turn Signals When Towing a Trailer

The turn signal indicators on the instrument cluster flash whenever signaling a turn or lane change. Properly hooked up, the trailer

lamps also flash, telling other drivers the vehicle is turning, changing lanes, or stopping.

When towing a trailer, the arrows on the instrument cluster flash for turns even if the bulbs on the trailer are burned out. Check occasionally to be sure the trailer bulbs are still working.

### Driving on Grades

Reduce speed and shift to a lower gear before starting down a long or steep downgrade. If the transmission is not shifted down, the brakes might have to be used so much that they would get hot and no longer work well.

The vehicle can tow in D (Drive). Use a lower gear if the transmission shifts too often.

When towing at high altitude on steep uphill grades, engine coolant boils at a lower temperature than at normal altitudes. If the engine is turned off immediately after towing at high altitude on steep uphill

grades, the vehicle could show signs similar to engine overheating. To avoid this, let the engine run while parked, preferably on level ground, with the transmission in P (Park) for a few minutes before turning the engine off. If the overheat warning comes on, see *Engine Overheating on page 10-16*.

### Parking on Hills

 **Warning**

Parking the vehicle on a hill with the trailer attached can be dangerous. If something goes wrong, the rig could start to move. People can be injured, and both the vehicle and the trailer can be damaged. When possible, always park the rig on a flat surface.

If parking the rig on a hill:

1. Press the brake pedal, but do not shift into P (Park) yet. Turn the wheels into the curb if facing downhill or into traffic if facing uphill.
2. Have someone place chocks under the trailer wheels.
3. When the wheel chocks are in place, release the brake pedal until the chocks absorb the load.
4. Reapply the brake pedal. Then apply the parking brake and shift into P (Park).
5. Release the brake pedal.

### **Leaving After Parking on a Hill**

1. Apply and hold the brake pedal while you:
  - Start the engine.
  - Shift into a gear.
  - Release the parking brake.
2. Let up on the brake pedal.
3. Drive slowly until the trailer is clear of the chocks.
4. Stop and have someone pick up and store the chocks.

### **Maintenance When Trailer Towing**

The vehicle needs service more often when pulling a trailer. See the *Maintenance Schedule on page 11-3*. Things that are especially important in trailer operation are automatic transmission fluid, engine oil, axle lubricant, belts, cooling system, and brake system. Inspect these before and during the trip.

Check periodically to see that all hitch nuts and bolts are tight.

### **Engine Cooling When Trailer Towing**

The cooling system may temporarily overheat during severe operating conditions. See *Engine Overheating on page 10-16*.

### **Trailer Towing**

Before pulling a trailer, there are three important considerations that have to do with weight:

- The weight of the trailer.
- The weight of the trailer tongue.
- The total weight on the vehicle's tires.



### **Weight of the Trailer**

How heavy can a trailer safely be?

It depends on how the rig is used. For example, speed, altitude, road grades, outside temperature and how much the vehicle is used to pull a trailer are all important. It can depend on any special equipment on the vehicle, and the amount of tongue weight the vehicle can carry. See "Weight of the Trailer Tongue" later in this section.

Maximum trailer weight is calculated assuming only the driver is in the tow vehicle and it has all the required trailering equipment. The weight of additional optional equipment, passengers and cargo in the tow vehicle must be subtracted from the maximum trailer weight.

Use the following chart to determine how much the vehicle can weigh, based upon the vehicle model and options.

Vehicle	Maximum Trailer Weight	GCWR*	Maximum Tongue Weight
3.6L Engine, FWD without Trailering Package	1 134 kg (2,500 lb)	3 185 kg (7,022 lb)	113 kg (250 lb)
3.6L Engine, FWD with Trailering Package	1 588 kg (3,500 lb)	3 640 kg (8,025 lb)	159 kg (350 lb)
3.6L Engine, AWD without Trailering Package	1 134 kg (2,500 lb)	3 270 kg (7,209 lb)	113 kg (250 lb)
3.6L Engine, AWD with Trailering Package	1 588 kg (3,500 lb)	3 725 kg (8,212 lb)	159 kg (350 lb)

\*The Gross Combination Weight Rating (GCWR) is the total allowable weight of the completely loaded vehicle and trailer including any passengers, cargo, equipment and conversions. The GCWR for the vehicle should not be exceeded.

Ask your dealer for trailering information or advice.

### Weight of the Trailer Tongue

The tongue load (1) of any trailer is an important weight to measure because it affects the total gross weight of the vehicle. The Gross Vehicle Weight (GVW) includes the curb weight of the vehicle, any cargo carried in it, and the people who will be riding in the vehicle.

If there are a lot of options, equipment, passengers or cargo in the vehicle, it will reduce the tongue weight the vehicle can carry, which will also reduce the trailer weight the vehicle can tow. If towing a trailer, the tongue load must be added to the GVW because the vehicle will be carrying that weight, too. See *Vehicle Load Limits* on page 9-9 for more information about the vehicle's maximum load capacity.

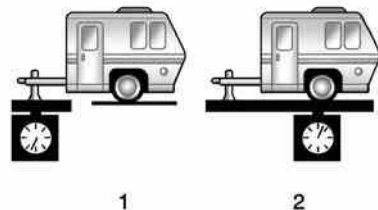

If a weight-carrying hitch or a weight-distributing hitch is being used, the trailer tongue (1) should weigh 10-15 percent of the total loaded trailer weight (2).

After loading the trailer, weigh the trailer and then the tongue, separately, to see if the weights are proper. If they are not, adjustments might be made by moving some items around in the trailer.

Trailerage may be limited by the vehicle's ability to carry tongue weight. Tongue weight cannot cause the vehicle to exceed the GVWR (Gross Vehicle Weight Rating) or the RGAWR (Rear Gross Axle Weight Rating). The effect of additional weight may reduce the trailering capacity more than the total of the additional weight.

It is important that the vehicle does not exceed any of its ratings — GCWR, GVWR, RGAWR, Maximum Trailer Rating or Tongue Weight.

The only way to be sure it is not exceeding any of these ratings is to weigh the vehicle and trailer.

### **Total Weight on the Vehicle's Tires**

Be sure the vehicle's tires are inflated to the upper limit for cold tires. These numbers can be found on the Certification label or see *Vehicle Load Limits on page 9-9*. Make sure not to go over the GVW limit for the vehicle, or the GAWR, including the weight of the trailer tongue. If using a weight distributing hitch, make sure not to go over the rear axle limit before applying the weight distribution spring bars.

## **Towing Equipment**

### **Hitches**

It is important to have the correct hitch equipment. Crosswinds, large trucks going by, and rough roads are a few reasons why the right hitch is needed.

- The rear bumper on the vehicle is not intended for hitches. Do not attach rental hitches or other bumper-type hitches to it. Use only a frame-mounted hitch that does not attach to the bumper.
- Will any holes be made in the body of the vehicle when the trailer hitch is installed? If there are, then be sure to seal the holes later when the hitch is removed. If the holes are not sealed, dirt, water, and deadly carbon monoxide (CO) from the exhaust can get into the vehicle. See *Engine Exhaust on page 9-21*.

## Hitch Cover

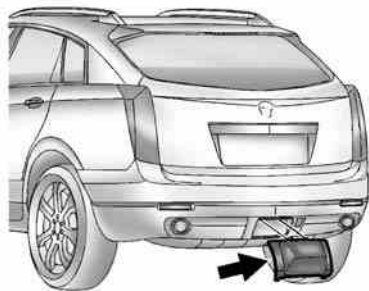

To remove the hitch cover, if equipped:

1. Turn the fasteners on the lower tabs 90 degrees counterclockwise.
2. Lift the lower edge of the cover about 45 degrees.
3. Pull the cover downward to disengage the upper attachments.

To reinstall the hitch cover:

1. Hold the cover at a 45 degree angle to the vehicle and push the upper tabs in the hitch cover into the slots in the fascia.
2. Move the bottom of the cover forward until the lower tabs line up with the lower fascia slots.
3. Snap the hitch cover into place by pushing the upper corners forward.
4. Turn the fasteners on the lower tabs 90 degrees clockwise to lock the cover in place.

## Safety Chains

Always attach chains between the vehicle and the trailer. Cross the safety chains under the tongue of the trailer to help prevent the tongue from contacting the road if it becomes separated from the hitch. Always leave just enough slack so the rig can turn. Never allow safety chains to drag on the ground.

## Trailer Brakes

A loaded trailer that weighs more than 450 kg (1,000 lb) needs to have its own brake system that is adequate for the weight of the trailer. Be sure to read and follow the instructions for the trailer brakes so they are installed, adjusted, and maintained properly.

Because the vehicle has antilock brakes, do not tap into the vehicle's brake system. If you do, both brake systems will not work well, or at all.

## Trailer Sway Control (TSC)

The vehicle has a TSC feature as part of the StabiliTrak system. If TSC detects that the trailer is swaying, the vehicle's brakes are automatically applied.



When TSC is applying the brakes, the TCS/StabiliTrak indicator light flashes to notify the driver to reduce speed. If the trailer continues to sway, StabiliTrak will reduce engine torque to help slow the vehicle.

TSC will not function if StabiliTrak is turned off. See *Traction Control/Electronic Stability Control* on page 9-30.

## Conversions and Add-Ons

### Add-On Electrical Equipment

 <b>Caution</b>
--

Some electrical equipment can damage the vehicle or cause components to not work and would not be covered by the warranty. Always check with your dealer before adding electrical equipment.
--

Add-on equipment can drain the vehicle's 12-volt battery, even if the vehicle is not operating.

The vehicle has an airbag system. Before attempting to add anything electrical to the vehicle, see *Servicing the Airbag-Equipped Vehicle* on page 3-31 and *Adding Equipment to the Airbag-Equipped Vehicle* on page 3-31.

## Vehicle Care

### General Information

General Information .....	10-2
California Proposition 65 Warning .....	10-2
California Perchlorate Materials Requirements ....	10-3
Accessories and Modifications .....	10-3

### Vehicle Checks

Doing Your Own Service Work .....	10-3
Hood .....	10-4
Engine Compartment Overview .....	10-5
Engine Cover .....	10-6
Engine Oil .....	10-7
Engine Oil Life System .....	10-9
Automatic Transmission Fluid .....	10-10
Engine Air Cleaner/Filter ....	10-10
Cooling System .....	10-12
Engine Coolant .....	10-13
Engine Overheating .....	10-16
Power Steering Fluid .....	10-18
Washer Fluid .....	10-18

Brakes .....	10-19
Brake Fluid .....	10-20
Battery .....	10-21
All-Wheel Drive .....	10-22
Starter Switch Check .....	10-22
Automatic Transmission Shift Lock Control Function Check .....	10-23
Park Brake and P (Park) Mechanism Check .....	10-23
Wiper Blade Replacement .....	10-23

### Headlamp Aiming

Headlamp Aiming .....	10-25
-----------------------	-------

### Bulb Replacement

Bulb Replacement .....	10-25
Halogen Bulbs .....	10-25
High Intensity Discharge (HID) Lighting .....	10-26
Headlamps .....	10-26
Turn Signal Lamps .....	10-29
Back-Up Lamps .....	10-30
License Plate Lamp .....	10-31
Replacement Bulbs .....	10-32

### Electrical System

Electrical System Overload .....	10-32
Fuses and Circuit Breakers .....	10-33
Engine Compartment Fuse Block .....	10-33
Instrument Panel Fuse Block .....	10-36
Rear Compartment Fuse Block .....	10-38

### Wheels and Tires

Tires .....	10-41
All-Season Tires .....	10-42
Winter Tires .....	10-42
Summer Tires .....	10-42
Tire Sidewall Labeling .....	10-43
Tire Designations .....	10-45
Tire Terminology and Definitions .....	10-45
Tire Pressure .....	10-48
Tire Pressure for High-Speed Operation .....	10-49
Tire Pressure Monitor System .....	10-50
Tire Pressure Monitor Operation .....	10-51
Tire Inspection .....	10-54

## 10-2 Vehicle Care

---

Tire Rotation .....	10-55
When It Is Time for New Tires .....	10-56
Buying New Tires .....	10-57
Different Size Tires and Wheels .....	10-58
Uniform Tire Quality Grading .....	10-59
Wheel Alignment and Tire Balance .....	10-60
Wheel Replacement .....	10-60
Tire Chains .....	10-61
If a Tire Goes Flat .....	10-62
Tire Sealant and Compressor Kit .....	10-63
Storing the Tire Sealant and Compressor Kit .....	10-71
Tire Changing .....	10-71
Compact Spare Tire .....	10-77
<b>Jump Starting</b>	
Jump Starting .....	10-78
<b>Towing the Vehicle</b>	
Towing the Vehicle .....	10-82
Recreational Vehicle Towing .....	10-82

### Appearance Care

Exterior Care .....	10-85
Interior Care .....	10-90
Floor Mats .....	10-93

## General Information

For service and parts needs, visit your dealer. You will receive genuine GM parts and GM-trained and supported service people.

Genuine GM parts have one of these marks:

---

***ACDelco.***

---

Genuine  Parts

---

 Accessories

## California Proposition 65 Warning

Most motor vehicles, including this one, contain and/or emit chemicals known to the State of California to

cause cancer and birth defects or other reproductive harm. Engine exhaust, many parts and systems, many fluids, and some component wear by-products contain and/or emit these chemicals.

## California Perchlorate Materials Requirements

Certain types of automotive applications, such as airbag initiators, safety belt pretensioners, and lithium batteries contained in Remote Keyless Entry transmitters, may contain perchlorate materials. Special handling may be necessary. For additional information, see [www.dtsc.ca.gov/hazardouswaste/perchlorate](http://www.dtsc.ca.gov/hazardouswaste/perchlorate).

## Accessories and Modifications

Adding non-dealer accessories or making modifications to the vehicle can affect vehicle performance and safety, including such things as airbags, braking, stability, ride and

handling, emissions systems, aerodynamics, durability, and electronic systems like antilock brakes, traction control, and stability control. These accessories or modifications could even cause malfunction or damage not covered by the vehicle warranty.

Damage to vehicle components resulting from modifications or the installation or use of non-GM certified parts, including control module or software modifications, is not covered under the terms of the vehicle warranty and may affect remaining warranty coverage for affected parts.

GM Accessories are designed to complement and function with other systems on the vehicle. See your dealer to accessorize the vehicle using genuine GM Accessories installed by a dealer technician.

Also, see *Adding Equipment to the Airbag-Equipped Vehicle* on page 3-31.

## Vehicle Checks

### Doing Your Own Service Work

#### Warning

It can be dangerous to work on your vehicle if you do not have the proper knowledge, service manual, tools, or parts. Always follow owner manual procedures and consult the service manual for your vehicle before doing any service work.

If doing some of your own service work, use the proper service manual. It tells you much more about how to service the vehicle than this manual can. To order the proper service manual, see *Service Publications Ordering Information* on page 13-10.



## 10-4 Vehicle Care

This vehicle has an airbag system. Before attempting to do your own service work, see *Servicing the Airbag-Equipped Vehicle on page 3-31*.

Keep a record with all parts receipts and list the mileage and the date of any service work performed. See *Maintenance Records on page 11-14*.

### **Caution**

Even small amounts of contamination can cause damage to vehicle systems. Do not allow contaminants to contact the fluids, reservoir caps, or dipsticks.

## Hood

To open the hood:

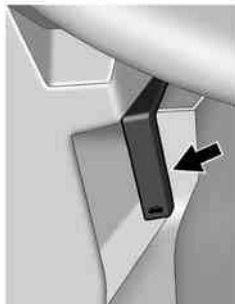

1. Pull the release handle with the above symbol on it. It is located below the instrument panel to the left of the steering wheel.



2. Move the secondary hood release lever up to release the striker. The lever is located near the middle of the hood.
3. Lift the hood.

Before closing the hood, be sure all the filler caps are on properly.

## Engine Compartment Overview

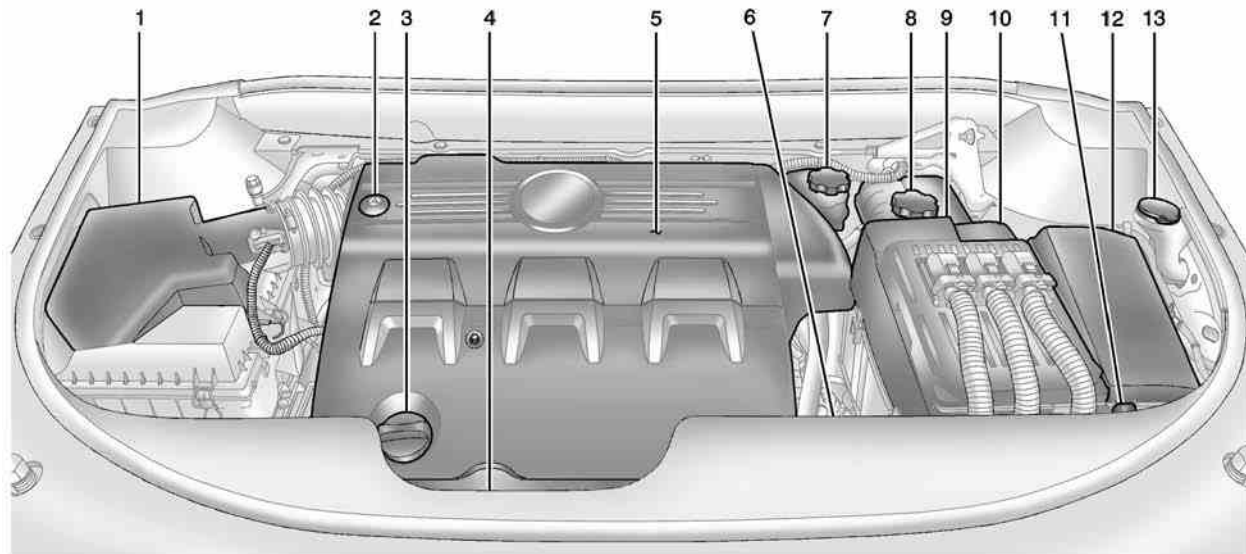

## 10-6 Vehicle Care

1. *Engine Air Cleaner/Filter on page 10-10.*
2. *Power Steering Reservoir and Cap (Under Engine Cover). See [Power Steering Fluid on page 10-18.](#)*
3. *Engine Oil Fill Cap. See [Engine Oil on page 10-7.](#)*
4. *Engine Oil Dipstick (Out of View). See [Engine Oil on page 10-7.](#)*
5. *Engine Cover on page 10-6.*
6. *Transmission Fluid Cap and Dipstick (Out of View). See [Automatic Transmission Fluid on page 10-10.](#)*
7. *Brake Fluid Reservoir. See [Brakes on page 10-19.](#)*
8. *Engine Coolant Surge Tank and Pressure Cap. See [Engine Coolant on page 10-13.](#)*
9. *Battery (Out of View). See [Battery on page 10-21.](#)*

10. *Remote Positive (+) Terminal. See [Jump Starting on page 10-78.](#)*
11. *Remote Negative (-) Terminal (Out of View). See [Jump Starting on page 10-78.](#)*
12. *Engine Compartment Fuse Block on page 10-33.*
13. *Windshield Washer Fluid Reservoir. See [Washer Fluid on page 10-18.](#)*

### Engine Cover

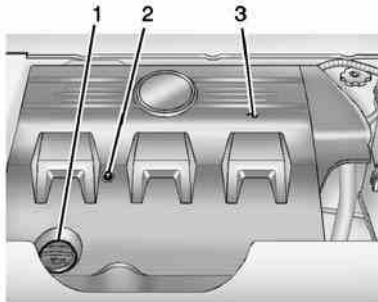

1. *Oil Fill Cap*
2. *Engine Cover Bolt*
3. *Engine Cover*

To remove:

1. *Remove the oil fill cap (1).*
2. *Remove the engine cover bolt (2).*
3. *Raise the engine cover (3) to release from the retainers.*
4. *Lift and remove the engine cover.*
5. *Reverse Steps 1–4 to reinstall engine cover.*

## Engine Oil

To ensure proper engine performance and long life, careful attention must be paid to engine oil. Following these simple, but important steps will help protect your investment:

- Always use engine oil approved to the proper specification and of the proper viscosity grade. See “Selecting the Right Engine Oil” in this section.
- Check the engine oil level regularly and maintain the proper oil level. See “Checking Engine Oil” and “When to Add Engine Oil” in this section.
- Change the engine oil at the appropriate time. See *Engine Oil Life System* on page 10-9.
- Always dispose of engine oil properly. See “What to Do with Used Oil” in this section.

## Checking Engine Oil

It is a good idea to check the engine oil level at each fuel fill. In order to get an accurate reading, the vehicle must be on level ground. The engine oil dipstick handle is a loop. See *Engine Compartment Overview* on page 10-5 for the location of the engine oil dipstick.

1. If the engine has been running recently, turn off the engine and allow several minutes for the oil to drain back into the oil pan. Checking the oil level too soon after engine shutoff will not provide an accurate oil level reading.

### Warning

The engine oil dipstick handle may be hot; it could burn you. Use a towel or glove to touch the dipstick handle.

2. Pull out the dipstick and wipe it with a clean paper towel or cloth, then push it back in all the way. Remove it again, keeping the tip down, and check the level.

## When to Add Engine Oil



If the oil is below the cross-hatched area at the tip of the dipstick, add 1 L (1 qt) of the recommended oil and then recheck the level. See “Selecting the Right Engine Oil” in this section for an explanation of what kind of oil to use. For engine oil crankcase capacity, see *Capacities and Specifications* on page 12-2.

### Caution

Do not add too much oil. Oil levels above or below the acceptable operating range shown on the dipstick are harmful to the engine. If you find that you have an oil level above the operating range, i.e., the engine has so much oil that the oil level gets above the cross-hatched area that shows the proper operating range, the engine could be damaged. You should drain out the excess oil or limit driving of the vehicle and seek a service professional to remove the excess amount of oil.

See *Engine Compartment Overview* on page 10-5 for the location of the engine oil fill cap.

Add enough oil to put the level somewhere in the proper operating range. Push the dipstick all the way back in when finished.

### Selecting the Right Engine Oil

Selecting the right engine oil depends on both the proper oil specification and viscosity grade. See *Recommended Fluids and Lubricants* on page 11-12.

#### Specification

Ask for and use engine oils that meet the dexos1™ specification. Engine oils that have been approved by GM as meeting the dexos1 specification are marked with the dexos1 approved logo. See [www.gmdexos.com](http://www.gmdexos.com).



### Caution

Failure to use the recommended engine oil can result in engine damage not covered by the vehicle warranty. Check with your dealer or service provider on whether the oil is approved to the dexos1 specification.

#### Viscosity Grade

Use SAE 5W-30 viscosity grade engine oil.

**Cold Temperature Operation:** In an area of extreme cold, where the temperature falls below  $-29^{\circ}\text{C}$  ( $-20^{\circ}\text{F}$ ), an SAE 0W-30 oil may be used. An oil of this viscosity grade will provide easier cold starting for the engine at extremely low temperatures. When selecting an oil of the appropriate viscosity grade, always select an oil of the correct specification. See “Specification” earlier in this section for more information.

## Engine Oil Additives/Engine Oil Flushes

Do not add anything to the oil. The recommended oils meeting the dexos1 specification are all that is needed for good performance and engine protection.

Engine oil system flushes are not recommended and could cause engine damage not covered by the vehicle warranty.

## What to Do with Used Oil

Used engine oil contains certain elements that can be unhealthy for your skin and could even cause cancer. Do not let used oil stay on your skin for very long. Clean your skin and nails with soap and water, or a good hand cleaner. Wash or properly dispose of clothing or rags containing used engine oil. See the manufacturer's warnings about the use and disposal of oil products.

Used oil can be a threat to the environment. If you change your own oil, be sure to drain all the oil

from the filter before disposal. Never dispose of oil by putting it in the trash or pouring it on the ground, into sewers, or into streams or bodies of water. Recycle it by taking it to a place that collects used oil.

## Engine Oil Life System

### When to Change Engine Oil

This vehicle has a computer system that indicates when to change the engine oil and filter. This is based on a combination of factors which include engine revolutions, engine temperature, and miles driven.

Based on driving conditions, the mileage at which an oil change is indicated can vary considerably. For the oil life system to work properly, the system must be reset every time the oil is changed.

When the system has calculated that oil life has been diminished, it indicates that an oil change is necessary. A CHANGE ENGINE OIL SOON message comes on. See *Engine Oil Messages on page 5-31*.

Change the oil as soon as possible within the next 1 000 km (600 mi). It is possible that, if driving under the best conditions, the oil life system might indicate that an oil change is not necessary for up to a year. The engine oil and filter must be changed at least once a year and at this time the system must be reset. Your dealer has trained service people who will perform this work and reset the system. It is also important to check the oil regularly over the course of an oil drain interval and keep it at the proper level.

If the system is ever reset accidentally, the oil must be changed at 5 000 km (3,000 mi) since the last oil change. Remember to reset the oil life system whenever the oil is changed.

### How to Reset the Engine Oil Life System

Reset the system whenever the engine oil is changed so that the system can calculate the next engine oil change. To reset the system:

1. Using the DIC controls on the right side of the steering wheel, display REMAINING OIL LIFE on the DIC. See *Driver Information Center (DIC) on page 5-25*. When remaining oil life is low, the CHANGE ENGINE OIL SOON message will appear on the display. See *Engine Oil Messages on page 5-31*.
2. Press SEL on the DIC controls and hold SEL down for a few seconds to clear the CHANGE ENGINE OIL SOON message and reset the oil life at 100%.

Be careful not to reset the oil life display accidentally at any time other than after the oil is changed. It cannot be reset accurately until the next oil change.

The oil life system can also be reset as follows:

1. Turn the ignition on with the engine off.
2. Fully press and release the accelerator pedal three times within five seconds.

If the CHANGE ENGINE OIL SOON message is not on, the system is reset.

The system is reset when the CHANGE ENGINE OIL SOON message is off.

If the CHANGE ENGINE OIL SOON message comes back on when the vehicle is started, the engine oil life system has not been reset. Repeat the procedure.

### Automatic Transmission Fluid

A transmission fluid leak is the only reason for fluid loss. If a leak occurs, take the vehicle to your dealer and have it repaired as soon as possible.

Change the fluid and filter at the intervals listed in *Maintenance Schedule on page 11-3*, and be sure to use the fluid listed in *Recommended Fluids and Lubricants on page 11-12*.

### Engine Air Cleaner/Filter

See *Engine Compartment Overview on page 10-5* for the location of the engine air cleaner/filter.

### When to Inspect the Engine Air Cleaner/Filter

Inspect the air cleaner/filter at the scheduled maintenance intervals and replace it at the first oil change after each 80 000 km (50,000 mi) interval. See *Maintenance Schedule*

on page 11-3. If driving in dusty/dirty conditions, inspect the filter at each engine oil change.

### How to Inspect the Engine Air Cleaner/Filter

To inspect the air cleaner/filter, remove the filter from the vehicle and lightly shake the filter to release loose dust and dirt. If the filter remains covered with dirt, a new filter is required. Never use compressed air to clean the filter.

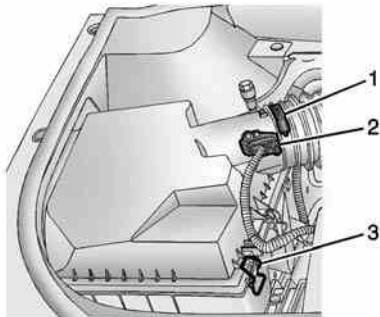

1. Air Duct Clamp
2. Electrical Connector

### 3. Retaining Clips

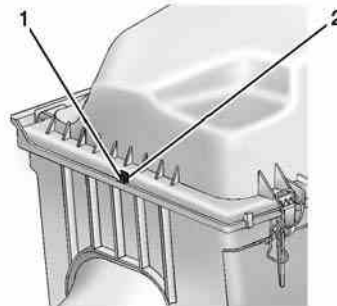

1. Cover Cut Outs
2. Air Filter Tabs

To inspect or replace the engine air cleaner/filter:

1. Open the hood. See *Hood* on page 10-4.
2. Locate the air filter housing on the front passenger side of the engine compartment. See *Engine Compartment Overview* on page 10-5.

3. Disconnect the outlet duct by loosening the air duct clamp (1).
4. Disconnect the electrical connector (2). First, remove the connector lock clip at the bottom of the connector, then press on the top and bottom of the connector to remove.
5. Lift the retaining clips (3) on the air filter housing.
6. Tilt and lift the cover slightly upward and slide the cover away from outside edge of the vehicle. Remove the air filter.
7. To install the air filter, place filter inside box where the pleats fit in between the tabs inside the lower box. Ensure that the cover cut outs (1) on both sides match the air filter tabs (2) on both sides.
8. Replace air cleaner cover by inserting the four tabs into the slots. Lower cover to meet bottom of the box. Attach the retaining clips (3).



## 10-12 Vehicle Care

9. Reconnect outlet duct to the cover and tighten the air duct clamp (1).
10. Reconnect the electrical connector (2). Install connector lock clip to the bottom of connector.

### Warning

Operating the engine with the air cleaner/filter off can cause you or others to be burned. The air cleaner not only cleans the air; it helps to stop flames if the engine backfires. Use caution when working on the engine and do not drive with the air cleaner/filter off.

### Caution

If the air cleaner/filter is off, dirt can easily get into the engine, which could damage it. Always have the air cleaner/filter in place when you are driving.

### Cooling System

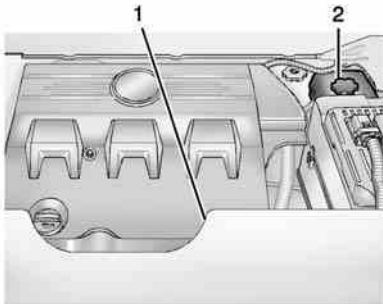

1. Engine Cooling Fan (Out of View)
2. Engine Coolant Surge Tank and Pressure Cap

### Warning

An electric engine cooling fan under the hood can start up even when the engine is not running and can cause injury. Keep hands, clothing, and tools away from any underhood electric fan.

If the coolant inside the coolant surge tank is boiling, do not do anything else until it cools down. The vehicle should be parked on a level surface.

The coolant level should be between the MIN and MAX lines. If it is not, the vehicle may have a leak at the radiator hoses, heater hoses, radiator, water pump, or somewhere else in the cooling system.

 **Warning**

Heater and radiator hoses, and other engine parts, can be very hot. Do not touch them. If you do, you can be burned.

Do not run the engine if there is a leak. If you run the engine, it could lose all coolant. That could cause an engine fire, and you could be burned. Get any leak fixed before you drive the vehicle.

If there seems to be no leak, with the engine on, check to see if the engine cooling fan is running. If the engine is overheating, the fan should be running. If it is not, the vehicle needs service. Turn off the engine.

 **Caution**

Using coolant other than DEX-COOL<sup>®</sup> can cause premature engine, heater core, or radiator corrosion. In addition, the engine coolant could require changing sooner. Any repairs would not be covered by the vehicle warranty. Always use DEX-COOL (silicate-free) coolant in the vehicle.

## Engine Coolant

The cooling system in the vehicle is filled with DEX-COOL<sup>®</sup> engine coolant. This coolant needs to be checked and replaced at appropriate intervals. See *Maintenance Schedule on page 11-3*.

The following explains the cooling system and how to check and add coolant when it is low. If there is a

problem with engine overheating, see *Engine Overheating on page 10-16*.

## What to Use

 **Warning**

Adding only plain water or some other liquid to the cooling system can be dangerous. Plain water and other liquids, can boil before the proper coolant mixture will. The coolant warning system is set for the proper coolant mixture. With plain water or the wrong mixture, the engine could get too hot but you would not get the overheat warning. The engine could catch fire and you or others could be burned. Use a 50/50 mixture of clean, drinkable water and DEX-COOL coolant.

## 10-14 Vehicle Care

Use a 50/50 mixture of clean, drinkable water and DEX-COOL coolant. If using this mixture, nothing else needs to be added. This mixture:

- Gives freezing protection down to  $-37^{\circ}\text{C}$  ( $-34^{\circ}\text{F}$ ), outside temperature.
- Gives boiling protection up to  $129^{\circ}\text{C}$  ( $265^{\circ}\text{F}$ ), engine temperature.
- Protects against rust and corrosion.
- Will not damage aluminum parts.
- Helps keep the proper engine temperature.

### Caution

If improper coolant mixture, inhibitors, or additives are used in the vehicle cooling system, the engine could overheat and be damaged. Too much water in the

(Continued)

### Caution (Continued)

mixture can freeze and crack engine cooling parts. The repairs would not be covered by the vehicle warranty. Use only the proper mixture of engine coolant for the cooling system. See *Recommended Fluids and Lubricants* on page 11-12.

Never dispose of engine coolant by putting it in the trash, pouring it on the ground, or into sewers, streams, or bodies of water. Have the coolant changed by an authorized service center, familiar with legal requirements regarding used coolant disposal. This will help protect the environment and your health.

### Checking Coolant

The vehicle must be on a level surface when checking the coolant level.

Check to see if coolant is visible in the coolant surge tank. If the coolant inside the coolant surge tank is boiling, do not do anything else until it cools down. If coolant is visible but the coolant level is not at the indicated mark, add a 50/50 mixture of clean, drinkable water and DEX-COOL coolant at the coolant surge tank, but be sure the cooling system is cool before this is done. See *Engine Overheating* on page 10-16.

The coolant surge tank is located in the engine compartment on the driver side of the vehicle. See *Engine Compartment Overview* on page 10-5.

## How to Add Coolant to the Coolant Surge Tank

### Caution

This vehicle has a specific coolant fill procedure. Failure to follow this procedure could cause the engine to overheat and be severely damaged.

If no problem is found, check to see if coolant is visible in the coolant surge tank. If coolant is visible but the coolant level is not at the indicated level mark, add a 50/50 mixture of clean, drinkable water and DEX-COOL coolant at the coolant surge tank, but be sure the cooling system, including the coolant surge tank pressure cap, is cool before you do it.

### Warning

Steam and scalding liquids from a hot cooling system can blow out and burn you badly. Never turn the cap when the cooling system, including the surge tank pressure cap, is hot. Wait for the cooling system and surge tank pressure cap to cool.

### Warning

Adding only plain water or some other liquid to the cooling system can be dangerous. Plain water and other liquids, can boil before the proper coolant mixture will. The coolant warning system is set for the proper coolant mixture. With plain water or the wrong mixture, the engine could get too hot but you would not get the overheat warning. The engine

(Continued)

### Warning (Continued)

could catch fire and you or others could be burned. Use a 50/50 mixture of clean, drinkable water and DEX-COOL coolant.

### Caution

In cold weather, water can freeze and crack the engine, radiator, heater core, and other parts. Use the recommended coolant and the proper coolant mixture.

### Warning

You can be burned if you spill coolant on hot engine parts. Coolant contains ethylene glycol and it will burn if the engine parts are hot enough. Do not spill coolant on a hot engine.

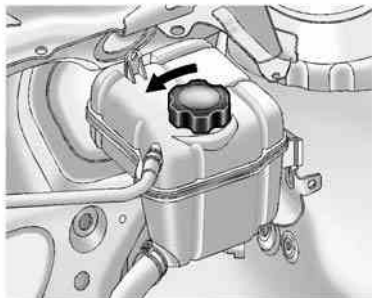

1. Remove the coolant surge tank pressure cap when the cooling system, including the coolant surge tank pressure cap and upper radiator hose, is no longer hot.

Turn the pressure cap slowly counterclockwise about one-quarter of a turn. If you hear a hiss, wait for that to stop. This will allow any pressure still left to be vented out the discharge hose.

2. Keep turning the pressure cap slowly and remove it.

3. Fill the coolant surge tank with the proper mixture to the indicated level mark.
4. With the coolant surge tank pressure cap off, start the engine and let it run until you can feel the upper radiator hose getting hot. Watch out for the engine cooling fan.

By this time, the coolant level inside the coolant surge tank may be lower. If the level is lower, add more of the proper mixture to the coolant surge tank until the level reaches the indicated level mark.

5. Replace the pressure cap tightly.
6. Verify coolant level after the engine is shut off and the coolant is cold. If necessary, repeat coolant fill procedure Steps 1–6.

If the coolant still is not at the proper level when the system cools down again, see your dealer.

### **Caution**

If the pressure cap is not tightly installed, coolant loss and possible engine damage may occur. Be sure the cap is properly and tightly secured.

## Engine Overheating

The vehicle has an indicator to warn of engine overheating.

There is an engine coolant temperature warning light on the vehicle's instrument cluster. See *Engine Coolant Temperature Gauge* on page 5-12.

If the decision is made not to lift the hood when this warning appears, but instead get service help right away. See *Roadside Service* on page 13-5.

If the decision is made to lift the hood, make sure the vehicle is parked on a level surface.

Then check to see if the engine cooling fans are running. If the engine is overheating, both fans should be running. If they are not, do not continue to run the engine and have the vehicle serviced.

 **Caution**

Running the engine without coolant may cause damage or a fire. Vehicle damage would not be covered by the vehicle warranty.

**If Steam Is Coming from the Engine Compartment**

 **Warning**

Steam from an overheated engine can burn you badly, even if you just open the hood. Stay away from the engine if you see or hear steam coming from it. Just turn it off and get everyone away from the vehicle until it cools down.

(Continued)

**Warning (Continued)**

Wait until there is no sign of steam or coolant before you open the hood.

If you keep driving when the engine is overheated, the liquids in it can catch fire. You or others could be badly burned. Stop the engine if it overheats, and get out of the vehicle until the engine is cool.

**If No Steam Is Coming from the Engine Compartment**

If an engine overheat warning is displayed but no steam can be seen or heard, the problem may not be too serious. Sometimes the engine can get a little too hot when the vehicle:

- Climbs a long hill on a hot day.
- Stops after high-speed driving.
- Idles for long periods in traffic.

- Tows a trailer.

If the overheat warning displays with no sign of steam:

1. Turn the air conditioning off.
2. Turn the heater on to the highest temperature and to the highest fan speed. Open the windows as necessary.
3. When it is safe to do so, pull off the road, shift to P (Park) or N (Neutral), and let the engine idle.

If the temperature overheat gauge is no longer in the overheat zone or an overheat warning no longer displays, the vehicle can be driven. Continue to drive the vehicle slowly for about 10 minutes. Keep a safe vehicle distance from the vehicle in front. If the warning does not come back on, continue to drive normally and have the cooling system checked for proper fill and function.

If the warning continues, pull over, stop, and park the vehicle right away.

If there is no sign of steam, idle the engine for three minutes while parked. If the warning is still displayed, turn off the engine until it cools down.

### Power Steering Fluid



See *Engine Compartment Overview* on page 10-5 for reservoir location.

### When to Check Power Steering Fluid

It is not necessary to regularly check power steering fluid unless a leak is suspected in the system or unusual noise is heard. A fluid loss in this system could indicate a problem. Have the system inspected and repaired.

### How to Check Power Steering Fluid

To check the power steering fluid:

1. Turn the engine off and let the engine compartment cool down.
2. Remove the engine cover, if required. See *Engine Cover* on page 10-6.
3. Wipe the cap and the top of the reservoir clean.
4. Unscrew the cap and wipe the dipstick with a clean rag.
5. Replace the cap and completely tighten it.
6. Remove the cap again and look at the fluid level on the dipstick.

The level should be within the HOT mark. If necessary, add only enough fluid to bring the level within the mark.

### What to Use



Use of the incorrect fluid may damage the vehicle and the damages may not be covered by the vehicle warranty. Always use the correct fluid listed in *Recommended Fluids and Lubricants* on page 11-12.

To determine what kind of fluid to use, see *Recommended Fluids and Lubricants* on page 11-12. Always use the proper fluid.

### Washer Fluid

#### What to Use

When windshield washer fluid is needed, be sure to read the manufacturer's instructions before use. If operating the vehicle in an area where the temperature may fall

below freezing, use a fluid that has sufficient protection against freezing.

### Adding Washer Fluid

The WASHER FLUID LOW ADD FLUID message appears on the Driver Information Center (DIC) when the fluid level is low. See *Washer Fluid Messages on page 5-38*.



Open the cap with the washer symbol on it. Add washer fluid up to the fill mark. See *Engine Compartment Overview on page 10-5* for reservoir location.

#### Caution

- Do not use engine coolant (antifreeze) in the windshield washer. It can damage the windshield washer system and paint.
- Do not mix water with ready-to-use washer fluid. Water can cause the solution to freeze and damage the washer fluid tank and other parts of the washer system.
- When using concentrated washer fluid, follow the manufacturer instructions for adding water.
- Fill the washer fluid tank only three-quarters full when it is very cold. This allows for fluid expansion if freezing occurs, which could damage the tank if it is completely full.

## Brakes

Disc brake pads have built-in wear indicators that make a high-pitched warning sound when the brake pads are worn and new pads are needed. The sound can come and go or be heard all the time when the vehicle is moving, except when applying the brake pedal firmly.

#### Warning

The brake wear warning sound means that soon the brakes will not work well. That could lead to a crash. When the brake wear warning sound is heard, have the vehicle serviced.

#### Caution

Continuing to drive with worn-out brake pads could result in costly brake repair.



Some driving conditions or climates can cause a brake squeal when the brakes are first applied or lightly applied. This does not mean something is wrong with the brakes.

Properly torqued wheel nuts are necessary to help prevent brake pulsation. When tires are rotated, inspect brake pads for wear and evenly tighten wheel nuts in the proper sequence to torque specifications. See *Capacities and Specifications on page 12-2*.

Brake pads should be replaced as complete sets.

### Brake Pedal Travel

See your dealer if the brake pedal does not return to normal height, or if there is a rapid increase in pedal travel. This could be a sign that brake service may be required.

### Replacing Brake System Parts

Always replace brake system parts with new, approved replacement parts. If this is not done, the brakes may not work properly. The braking performance expected can change in many other ways if the wrong replacement brake parts are installed or parts are improperly installed.

### Brake Fluid



The brake master cylinder reservoir is filled with DOT 3 brake fluid as indicated on the reservoir cap. See *Engine Compartment Overview on page 10-5* for the location of the reservoir.

There are only two reasons why the brake fluid level in the reservoir might go down:

- The brake fluid level goes down because of normal brake lining wear. When new linings are installed, the fluid level goes back up.
- A fluid leak in the brake hydraulic system can also cause a low fluid level. Have the brake hydraulic system fixed, since a leak means that sooner or later the brakes will not work well.

Do not top off the brake fluid. Adding fluid does not correct a leak. If fluid is added when the linings are worn, there will be too much fluid when new brake linings are installed. Add or remove brake fluid, as necessary, only when work is done on the brake hydraulic system.

**⚠ Warning**

If too much brake fluid is added, it can spill on the engine and burn, if the engine is hot enough. You or others could be burned, and the vehicle could be damaged. Add brake fluid only when work is done on the brake hydraulic system.

When the brake fluid falls to a low level, the brake warning light comes on. See *Brake System Warning Light* on page 5-18.

**What to Add**

Use only new DOT 3 brake fluid from a sealed container. See *Recommended Fluids and Lubricants* on page 11-12.

Always clean the brake fluid reservoir cap and the area around the cap before removing it. This helps keep dirt from entering the reservoir.

**⚠ Warning**

With the wrong kind of fluid in the brake hydraulic system, the brakes might not work well. This could cause a crash. Always use the proper brake fluid.

**⚠ Caution**

- Using the wrong fluid can badly damage brake hydraulic system parts. For example, just a few drops of mineral-based oil, such as engine oil, in the brake hydraulic system can damage brake hydraulic system parts so badly that they will have to be replaced. Do not let someone put in the wrong kind of fluid.

(Continued)

**Caution (Continued)**

- If brake fluid is spilled on the vehicle's painted surfaces, the paint finish can be damaged. Be careful not to spill brake fluid on the vehicle. If you do, wash it off immediately.

**Battery**

The original equipment battery is maintenance free. Do not remove the cap and do not add fluid.

Refer to the replacement number shown on the original battery label when a new battery is needed. See *Engine Compartment Overview* on page 10-5 for battery location.

### Warning

Battery posts, terminals, and related accessories contain lead and lead compounds, chemicals known to the State of California to cause cancer and reproductive harm. Wash hands after handling.

### Vehicle Storage

### Warning

Batteries have acid that can burn you and gas that can explode. You can be badly hurt if you are not careful. See *Jump Starting on page 10-78* for tips on working around a battery without getting hurt.

**Infrequent Usage:** Remove the black, negative (-) cable from the battery to keep the battery from running down.

**Extended Storage:** Remove the black, negative (-) cable from the battery or use a battery trickle charger.

### All-Wheel Drive

#### Transfer Case

Under normal driving conditions, transfer case fluid does not require changing or checking unless there is a fluid leak or unusual noise. If required, have the transfer case serviced by your dealer.

### Starter Switch Check

### Warning

When you are doing this inspection, the vehicle could move suddenly. If the vehicle moves, you or others could be injured.

1. Before starting this check, be sure there is enough room around the vehicle.
2. Apply both the parking brake and the regular brake.  
  
Do not use the accelerator pedal, and be ready to turn off the engine immediately if it starts.
3. Try to start the engine in each gear. The vehicle should start only in P (Park) or N (Neutral). If the vehicle starts in any other position, contact your dealer for service.

## Automatic Transmission Shift Lock Control Function Check

### Warning

When you are doing this inspection, the vehicle could move suddenly. If the vehicle moves, you or others could be injured.

1. Before starting this check, be sure there is enough room around the vehicle. It should be parked on a level surface.
2. Apply the parking brake. Be ready to apply the regular brake immediately if the vehicle begins to move.
3. With the engine off, turn the ignition on, but do not start the engine. Without applying the regular brake, try to move the shift lever out of P (Park) with

normal effort. If the shift lever moves out of P (Park), contact your dealer for service.

## Park Brake and P (Park) Mechanism Check

### Warning

When you are doing this check, the vehicle could begin to move. You or others could be injured and property could be damaged. Make sure there is room in front of the vehicle in case it begins to roll. Be ready to apply the regular brake at once should the vehicle begin to move.

Park on a fairly steep hill, with the vehicle facing downhill. Keeping your foot on the regular brake, set the parking brake.

- To check the parking brake's holding ability: With the engine running and the transmission in N (Neutral), slowly remove foot

pressure from the regular brake pedal. Do this until the vehicle is held by the parking brake only.

- To check the P (Park) mechanism's holding ability: With the engine running, shift to P (Park). Then release the parking brake followed by the regular brake.

Contact your dealer if service is required.

## Wiper Blade Replacement

Windshield wiper blades should be inspected for wear or cracking.

It is a good idea to clean or replace the wiper blade assembly on a regular basis or when worn. For proper windshield wiper blade length and type, see *Maintenance Replacement Parts on page 11-13*.

### Caution

Allowing the wiper arm to touch the windshield when no wiper blade is installed could damage the windshield. Any damage that occurs would not be covered by the vehicle warranty. Do not allow the wiper arm to touch the windshield.

### Front Wiper Blade Replacement

To replace the wiper blade assembly:

1. Pull the windshield wiper assembly away from the windshield.

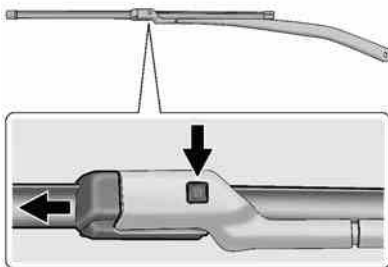

2. Press the button in the middle of the wiper arm connector, and pull the wiper blade away from the arm connector.
3. Remove the wiper blade.
4. Reverse steps 1–3 for wiper blade replacement.

### Rear Wiper Blade Replacement

The rear wiper blade and wiper arm have a cover for protection. The cover must be removed before the wiper blade can be replaced.

To remove the cover:



1. Slide a plastic tool under the cover and push upward to unsnap.
2. Slide the cover toward the wiper blade tip to unhook it from the blade assembly.
3. Remove the cover.
4. After wiper blade replacement, ensure that the cover hook slides into the slot in the blade assembly.
5. Snap the cover down to secure.

To remove the wiper blade:

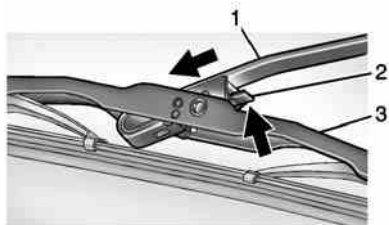

1. Lift the wiper arm away from the window.
2. Push the release lever (2) to disengage the hook and push the wiper arm (1) out of the blade assembly (3).
3. Push the new blade assembly securely on the wiper arm until the release lever clicks into place.
4. Replace the wiper cover.

## Headlamp Aiming

Headlamp aim has been preset and should need no further adjustment.

If the vehicle is damaged in a crash, the headlamp aim may be affected. If adjustment to the headlamps is necessary, see your dealer.

## Bulb Replacement

For the proper type of replacement bulbs, see *Replacement Bulbs on page 10-32*.

For any bulb changing procedure not listed in this section, contact your dealer.

## Halogen Bulbs

### Warning

Halogen bulbs have pressurized gas inside and can burst if you drop or scratch the bulb. You or others could be injured. Be sure to read and follow the instructions on the bulb package.

## High Intensity Discharge (HID) Lighting

### Warning

The high intensity discharge lighting system operates at a very high voltage. If you try to service any of the system components, you could be seriously injured. Have your dealer or a qualified technician service them.

After an HID headlamp bulb has been replaced, the beam might be a slightly different shade than it was originally. This is normal.

## Headlamps

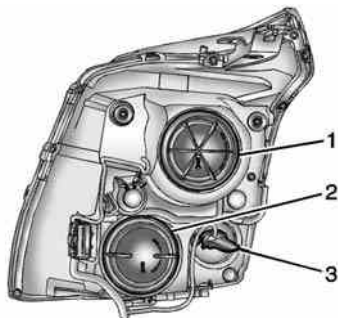

### Base Headlamp Assembly (Rear View Passenger Side)

1. Low-Beam Headlamp/Daytime Running Lamp (DRL)
2. High-Beam Headlamp
3. Turn Signal Lamp

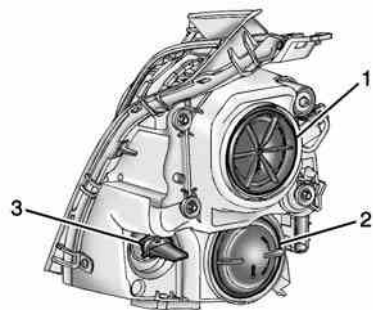

### Uplevel Headlamp Assembly (Rear View Driver Side)

1. High/Low-Beam Headlamp (To be replaced at dealer only)
2. Daytime Running Lamp (DRL)
3. Turn Signal Lamp

## Driver Side

The removal of the underhood electrical center cover is required for the replacement of one of these bulbs:

1. Open the hood. See *Hood* on page 10-4.

### Warning

Liquids from environment or spillage and/or tools placed on top of or used in the underhood electrical center while the cover is removed can pose a risk of electrical shock/burn to anyone in the vicinity. These conditions can also cause damage to electrical components on the vehicle. Keep liquids and tools away from the underhood electrical center when the cover is removed.

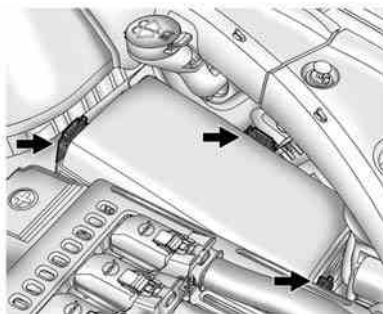

2. Unlatch the three clips and lift up the underhood electrical center cover to remove.

## Passenger Side

The removal of the air filter/cleaner assembly and base is required for the replacement of one of these bulbs:

1. Open the hood. See *Hood* on page 10-4.
2. Remove the air cleaner/filter cover. See *Engine Air Cleaner/Filter* on page 10-10.

3. Lift the air cleaner/filter base to disengage from the three pins.

## Low-Beam Headlamps/Daytime Running Lamps (DRL), High-Beam Headlamps (Base)



1. From the back side of the headlamp assembly, remove the top cap to replace the low-beam headlamp/DRL bulb.





2. From the back side of the headlamp assembly, remove the bottom cap to replace the high-beam headlamp bulb.
3. Disconnect the electrical connector.
4. Remove the bulb socket from the headlamp assembly.
5. Replace the bulb in the bulb socket.
6. Install the bulb socket in the headlamp assembly.
7. Connect the electrical connector.

8. Install the cap with the down arrow pointing down in the back of the headlamp assembly.
9. For the driver side, reinstall the underhood electrical center cover by latching three clips.
10. For the passenger side, reinstall the air filter/cleaner assembly base by pushing to seat. Verify the base is seated securely, then install the engine air filter/cleaner assembly.

### High/Low-Beam Headlamps (Uplevel)

The high/low-beam headlamps on the uplevel are High Intensity Discharge (HID) and should be replaced at the dealer.

### Daytime Running Lamp (DRL) (Uplevel)

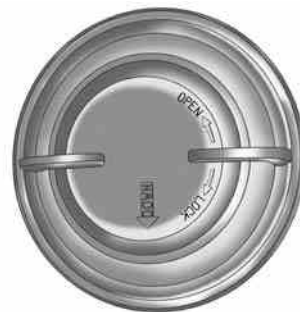

1. From the back side of the headlamp assembly, remove the bottom cap to replace the DRL bulb.
2. Disconnect electrical connector.
3. Remove the DRL bulb socket from the headlamp assembly.
4. Replace the bulb in the bulb socket.
5. Install the bulb socket in the headlamp assembly.

6. Connect the electrical connector.
  7. Install the cap with the down arrow pointing down in the back of the headlamp assembly.
  8. For the driver side, reinstall the underhood electrical center cover by latching three clips.
  9. For the passenger side, reinstall the air filter/cleaner assembly base by pushing to seat. Verify the base is seated securely, then install the engine air filter/cleaner assembly.
4. Install the bulb socket in the headlamp assembly.
  5. For the driver side, reinstall the underhood electrical center cover by latching the three clips.
  6. For the passenger side, reinstall the air filter/cleaner assembly base by pushing to seat. Verify the base is seated securely, then install the engine air filter/cleaner assembly.

### Front Turn Signal Lamp (Base and Uplevel)

To replace the front turn signal lamp:

1. Remove the turn signal lamp bulb socket from the headlamp assembly.
2. Remove the turn signal lamp bulb from the socket.
3. Replace the bulb in the bulb socket.

### Turn Signal Lamps

To replace one of these bulbs:

1. Open the liftgate. See *Liftgate* on page 2-14.

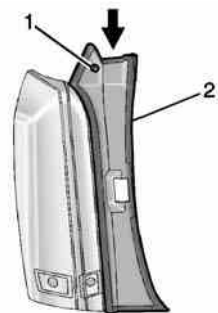

2. Remove the push pin (1) on the taillamp cover (2).
3. Remove the taillamp cover from the lamp assembly by pulling rearward from the top to unfasten the snap tabs.

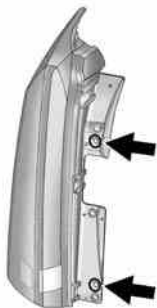

4. Remove the two screws from the taillamp assembly.
5. Pull the taillamp assembly straight back to remove.

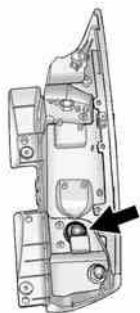

6. Turn the turn signal lamp bulb socket counterclockwise to remove it from the taillamp assembly.
7. Pull the bulb straight out from the socket.
8. Press a new bulb into the socket, insert it into the taillamp assembly, and turn the bulb socket clockwise until it clicks.
9. Reinstall the taillamp assembly and tighten the screws.
10. Reinstall the taillamp cover by snapping it into place.

11. Push the push pin to secure the taillamp cover.

## Back-Up Lamps

To replace one of these bulbs:

1. Open the liftgate. See *Liftgate* on page 2-14.

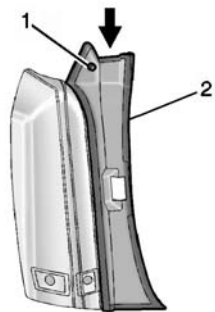

2. Remove the push pin (1) on the taillamp cover (2).
3. Remove the taillamp cover from the lamp assembly by pulling rearward from the top to unfasten from the snap tabs.

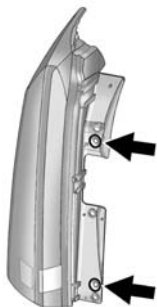

4. Remove the two screws from the taillamp assembly.
5. Pull the taillamp assembly straight back to remove.

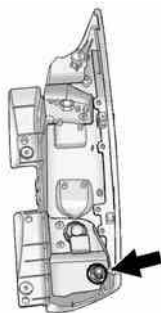

6. Disconnect the wiring harness connector from the back-up bulb/socket assembly.
7. Turn the back-up bulb socket counterclockwise to remove it from the taillamp assembly.
8. Install a new bulb/socket assembly into the taillamp assembly, and turn the bulb/socket clockwise until it clicks.
9. Reinstall the taillamp assembly and tighten the screws.
10. Reinstall the taillamp cover by snapping it into place.

11. Push the push pin to secure the taillamp cover.

### License Plate Lamp

To replace one of these bulbs:

1. Open the liftgate. See *Liftgate* on page 2-14.

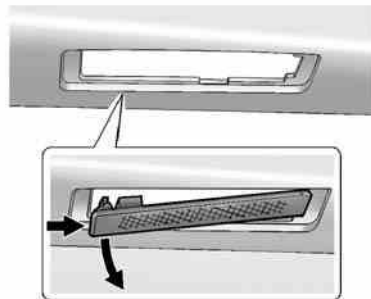

**Passenger Side Shown, Driver Side Similar**

2. Push the left end of the lamp assembly toward the right.
3. Turn the lamp assembly down to remove it from the liftgate.

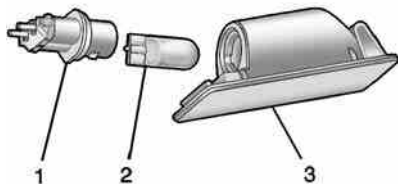

4. Turn the bulb socket (1) counterclockwise to remove it from the lamp assembly (3).
5. Pull the bulb (2) straight out of the bulb socket.
6. Push the replacement bulb straight into the bulb socket and turn the bulb socket clockwise to install into the lamp assembly.
7. Turn the lamp assembly into the liftgate, engaging the clip side first.

8. Push on the lamp side opposite the clip until the lamp assembly snaps into place.

### Replacement Bulbs

Exterior Lamp	Bulb Number
Back-up Lamp	Hyperclick PH16W
Daytime Running Lamp	7443 ULL
Headlamp High-Beam	9005LL
Headlamp Low-Beam	H11LL
License Plate Lamp	W5WLL
Turn Signal Front	7444NA
Tail/Turn Signal Rear	7440

For replacement bulbs not listed here, contact your dealer.

## Electrical System

### Electrical System Overload

The vehicle has fuses and circuit breakers to protect against an electrical system overload.

When the current electrical load is too heavy, the circuit breaker opens and closes, protecting the circuit until the current load returns to normal or the problem is fixed. This greatly reduces the chance of circuit overload and fire caused by electrical problems.

Fuses and circuit breakers protect power devices in the vehicle.

Replace a bad fuse with a new one of the identical size and rating.

If there is a problem on the road and a fuse needs to be replaced, the same amperage fuse can be borrowed. Choose some feature of the vehicle that is not needed to use and replace it as soon as possible.

## Headlamp Wiring

An electrical overload may cause the lamps to go on and off, or in some cases to remain off. Have the headlamp wiring checked right away if the lamps go on and off or remain off.

## Windshield Wipers

If the wiper motor overheats due to heavy snow or ice, the windshield wipers will stop until the motor cools and will then restart.

Although the circuit is protected from electrical overload, overload due to heavy snow or ice may cause wiper linkage damage. Always clear ice and heavy snow from the windshield before using the windshield wipers.

If the overload is caused by an electrical problem and not snow or ice, be sure to get it fixed.

## Fuses and Circuit Breakers

The wiring circuits in the vehicle are protected from short circuits by a combination of fuses and circuit breakers. This greatly reduces the chance of damage caused by electrical problems.

To check a fuse, look at the silver-colored band inside the fuse. If the band is broken or melted, replace the fuse. Be sure to replace a bad fuse with a new one of the identical size and rating.

Fuses of the same amperage can be temporarily borrowed from another fuse location, if a fuse goes out. Replace the fuse as soon as possible.

To identify and check fuses, circuit breakers, and relays, see *Engine Compartment Fuse Block* on page 10-33, *Instrument Panel Fuse Block* on page 10-36, and *Rear Compartment Fuse Block* on page 10-38.

## Engine Compartment Fuse Block

To remove the fuse block cover, press the clips on the cover and lift it straight up.



Spilling liquid on any electrical component on the vehicle may damage it. Always keep the covers on any electrical component.

## 10-34 Vehicle Care

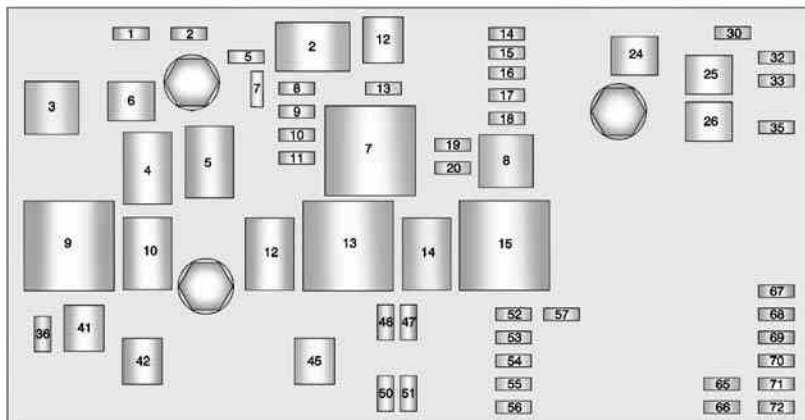

**Engine Compartment Fuse Block**

The vehicle may not be equipped with all of the fuses, relays, and features shown.

J-Case Fuses	Usage
6	Wiper
12	Vacuum Pump

J-Case Fuses	Usage
24	Antilock Brake System Pump
25	Rear Electrical Center 1

J-Case Fuses	Usage
26	Rear Electrical Center 2
41	Cooling Fan 2
42	Starter
45	Cooling Fan 1

Mini Fuses	Usage
1	Engine Control Module Battery
2	Transmission Control Module Battery
5	Engine Control Module Run Crank
7	Post-Catalytic Converter O2 Sensor
8	Pre-Catalytic Converter O2 Sensor

<b>Mini Fuses</b>	<b>Usage</b>
9	Engine Control Module Powertrain
10	Fuel Injectors – Even
11	Fuel Injectors – Odd
13	Washer
14	Heated Steering Wheel
15	Not Used
16	Instrument Cluster/ Malfunction Indicator Lamp/Ignition
17	Air Quality Sensor
18	Not Used
19	Transmission Control Module Run Crank
20	Rear Electrical Center Run Crank
30	Switch Back Light

<b>Mini Fuses</b>	<b>Usage</b>
32	Battery Sense (Regulated Voltage Control)
33	Adaptive Forward Lighting
35	Electronic Brake Control Module
36	Air Conditioning Compressor Clutch
46	Low-Beam Headlamp – Right
47	Low-Beam Headlamp – Left
50	Front Fog Lamps
51	Horn
52	Fuel System Control Module
53	Headlamp Level
54	Sensing Diagnostic Module Ignition

<b>Mini Fuses</b>	<b>Usage</b>
55	High-Beam Headlamp – Right
56	High-Beam Headlamp – Left
57	Ignition Steering Column Lock
65	Trailer Right Stoplamp
66	Trailer Left Stoplamp
67	Spare
68	Spare
69	Spare
70	Spare
71	Spare
72	Spare



## 10-36 Vehicle Care

Mini Relays	Usage
7	Powertrain
9	Cooling Fan 2
13	Cooling Fan 1
15	Run/Crank

Micro Relays	Usage
2	Vacuum Pump
4	Wiper Control
5	Wiper Speed
10	Starter
12	Cool Fan 3
14	Low Beam/HID

U Micro Relays	Usage
3	Air Conditioning Compressor Clutch
8	Not Used

### Instrument Panel Fuse Block

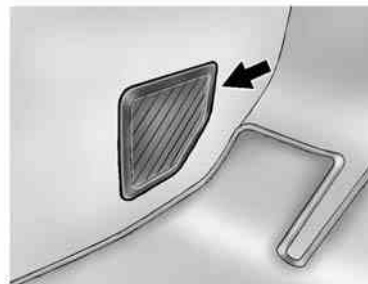

The instrument panel fuse block is located in the center console between the driver and passenger seats. To access the fuses, open the fuse panel door from the passenger side by pulling it out.

To reinstall the door, push the door back into its original location.

The vehicle may not be equipped with all of the fuses, relays and features shown.

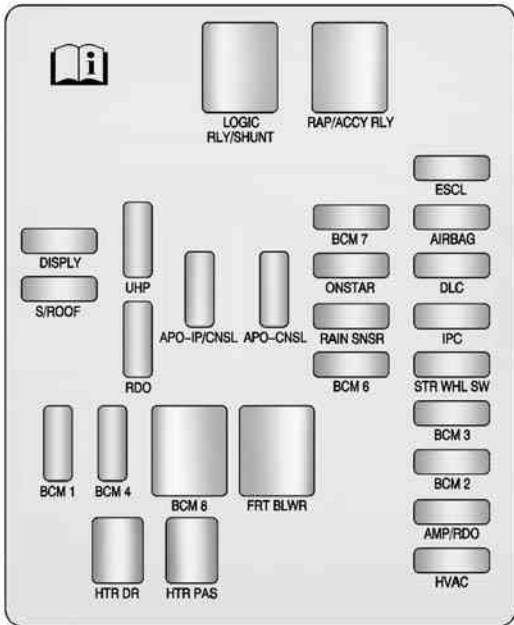

Instrument Panel Fuse Block

Mini Fuses	Usage
DISPLY	Display
S/ROOF	Sunroof
UHP	Universal Handsfree Phone (If Equipped)
RDO	Radio
APO – IP/CNSL	Auxiliary Power Outlet – Instrument Panel/Console
APO – CNSL	Auxiliary Power Outlet – Floor Console
BCM 1	Body Control Module 3
BCM 4	Body Control Module 4
BCM 7	Body Control Module 7
ONSTAR	OnStar® System (If Equipped)
RAIN SNSR	Rain Sensor

Mini Fuses	Usage
BCM 6	Body Control Module 6
ESCL	Electronic Steering Column Lock
AIRBAG	Sensing and Diagnostic Module
DLC	Data Link Connector
IPC	Instrument Cluster
STR WHL SW	Steering Wheel Switch
BCM 3	Body Control Module 1
BCM 2	Body Control Module 2
AMP/RDO	Amplifier/Radio
HVAC	Heating Ventilation & Air Conditioning

J-Case Fuses	Usage
BCM 8	Body Control Module 8
FRT BLWR	Front Blower

Relays	Usage
LOGIC RLY/ SHUNT	Logistics Relay/ Shunt
RAP/ ACCY RLY	Retained Accessory Power/ Accessory Relay

Breakers	Usage
HTR DR	Heated Driver Seat
HTR PAS	Heated Passenger Seat

### Rear Compartment Fuse Block

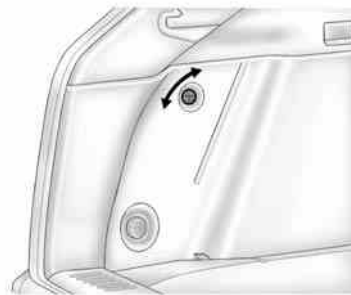

The rear compartment fuse block is in the cargo area, on the driver side of the vehicle behind the lower trim panel. To open, turn the latch with a flat bladed tool and pull the trim panel from the edges to fold it down.

The vehicle may not be equipped with all of the fuses, relays, and features shown.

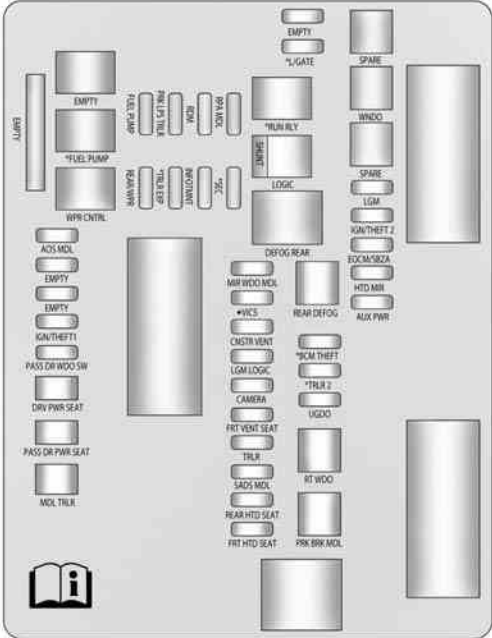

Rear Compartment Fuse Block

Fuses	Usage
AOS MDL	Automatic Occupant Sensing Module
AUX PWR	Auxiliary Power Outlet
* BCM THEFT	Body Control Module Theft
CAMERA	Rear Vision Camera
CNSTR VENT	Canister Vent
DRV PWR SEAT	Driver Power Seat
EOCM/ SBZA	External Object Calculating Module/ Side Blind Zone Alert
EMPTY	Not Used
FRT HTD SEAT	Front Heated Seats
FRT VENT SEAT	Front Ventilated Seats
FUEL PUMP	Fuel Pump

## 10-40 Vehicle Care

Fuses	Usage
HTD MIR	Heated Mirror
IGN/ THEFT 1	Ignition/Theft 1
IGN/ THEFT 2	Ignition/Theft 2
INFOTMNT	Infotainment
* L/GATE	Liftgate
LGM	Liftgate Module
LGM LOGIC	Liftgate Module Logic
MDL TRLR	Trailer Module
MIR WDO MDL	Mirror Window Module
PRK BRK MDL	Park Brake Module
PASS DR WDO SW	Passenger Door Window Switch
PASS DR PWR SEAT	Passenger/Driver Power Seats
PRK LPS TRLR	Trailer Park Lamps

Fuses	Usage
RDM	Rear Drive Module
REAR DEFOG	Rear Defog
REAR HTD SEAT	Rear Heated Seats
REAR/WPR	Rear Wiper
RT WDO	Right Window
RPA MDL	Rear Parking Assist Module
SADS MDL	Semi Active Damping System Module
* SEC	Security
SHUNT	Shunt
SPARE	Not Used
SPARE FUSES	Spare Fuses
* TRLR EXP	Trailer Export
TRLR	Trailer Module
* TRLR 2	Trailer 2

Fuses	Usage
UGDO	Universal Garage Door Opener
VICS	Vehicle Information Communications System (Export)
WDO	Power Window

Relays	Usage
DEFOG REAR	Rear Window Defogger
* FUEL PUMP	Fuel Pump
LOGIC	Logistic Relay (Export)
* RUN RLY	Run Relay
SPARE	Not Used
WPR CONTRL	Wiper Control

\*Denotes uplevel content.

## Wheels and Tires

### Tires

Every new GM vehicle has high-quality tires made by a leading tire manufacturer. See the warranty manual for information regarding the tire warranty and where to get service. For additional information refer to the tire manufacturer.

#### Warning

- Poorly maintained and improperly used tires are dangerous.
- Overloading the tires can cause overheating as a result of too much flexing. There could be a blowout

(Continued)

#### Warning (Continued)

and a serious crash. See *Vehicle Load Limits on page 9-9*.

- Underinflated tires pose the same danger as overloaded tires. The resulting crash could cause serious injury. Check all tires frequently to maintain the recommended pressure. Tire pressure should be checked when the tires are cold.
- Overinflated tires are more likely to be cut, punctured, or broken by a sudden impact — such as when hitting a pothole. Keep tires at the recommended pressure.

(Continued)

#### Warning (Continued)

- Worn or old tires can cause a crash. If the tread is badly worn, replace them.
- Replace any tires that have been damaged by impacts with potholes, curbs, etc.
- Improperly repaired tires can cause a crash. Only the dealer or an authorized tire service center should repair, replace, dismount, and mount the tires.
- Do not spin the tires in excess of 56 km/h (35 mph) on slippery surfaces such as snow, mud, ice, etc. Excessive spinning may cause the tires to explode.

See *Tire Pressure for High-Speed Operation on page 10-49* for inflation pressure adjustment for high-speed driving.

### All-Season Tires

This vehicle may come with all-season tires. These tires are designed to provide good overall performance on most road surfaces and weather conditions. Original equipment tires designed to GM's specific tire performance criteria have a TPC specification code molded onto the sidewall. Original equipment all-season tires can be identified by the last two characters of this TPC code, which will be "MS."

Consider installing winter tires on the vehicle if frequent driving on snow or ice-covered roads is expected. All-season tires provide adequate performance for most winter driving conditions, but they may not offer the same level of

traction or performance as winter tires on snow or ice-covered roads. See *Winter Tires on page 10-42*.

### Winter Tires

This vehicle was not originally equipped with winter tires. Winter tires are designed for increased traction on snow and ice-covered roads. Consider installing winter tires on the vehicle if frequent driving on ice or snow covered roads is expected. See your dealer for details regarding winter tire availability and proper tire selection. Also, see *Buying New Tires on page 10-57*.

With winter tires, there may be decreased dry road traction, increased road noise, and shorter tread life. After changing to winter tires, be alert for changes in vehicle handling and braking.

If using winter tires:

- Use tires of the same brand and tread type on all four wheel positions.

- Use only radial ply tires of the same size, load range, and speed rating as the original equipment tires.

Winter tires with the same speed rating as the original equipment tires may not be available for H, V, W, Y, and ZR speed rated tires. If winter tires with a lower speed rating are chosen, never exceed the tire's maximum speed capability.

### Summer Tires

This vehicle may come with high performance summer tires. These tires have a special tread and compound that are optimized for maximum dry and wet road performance. This special tread and compound will have decreased performance in cold climates, and on ice and snow. We recommend installing winter tires on the vehicle if frequent driving at temperatures below approximately 5°C (40°F) or on ice or snow covered roads is expected. See *Winter Tires on page 10-42*.

## Tire Sidewall Labeling

Useful information about a tire is molded into its sidewall. The examples show a typical passenger vehicle tire and a compact spare tire sidewall.

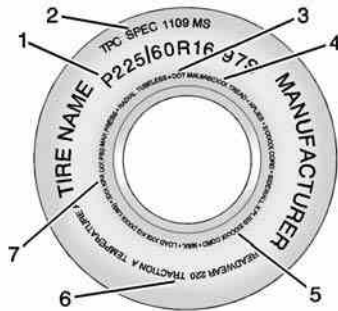

### Passenger (P-Metric) Tire Example

**(1) Tire Size:** The tire size is a combination of letters and numbers used to define a particular tire's width, height, aspect ratio, construction type,

and service description. See the "Tire Size" illustration later in this section.

**(2) TPC Spec (Tire Performance Criteria Specification):** Original equipment tires designed to GM's specific tire performance criteria have a TPC specification code molded onto the sidewall. GM's TPC specifications meet or exceed all federal safety guidelines.

**(3) DOT (Department of Transportation):** The Department of Transportation (DOT) code indicates that the tire is in compliance with the U.S. Department of Transportation Motor Vehicle Safety Standards.

**DOT Tire Date of Manufacture:** The last four digits of the TIN indicate the tire manufactured date. The first two

digits represent the week (01–52) and the last two digits, the year. For example, the third week of the year 2010 would have a four-digit DOT date of 0310.

**(4) Tire Identification Number (TIN):** The letters and numbers following the DOT (Department of Transportation) code are the Tire Identification Number (TIN). The TIN shows the manufacturer and plant code, tire size, and date the tire was manufactured. The TIN is molded onto both sides of the tire, although only one side may have the date of manufacture.

**(5) Tire Ply Material:** The type of cord and number of plies in the sidewall and under the tread.

**(6) Uniform Tire Quality Grading (UTQG):** Tire manufacturers are required to grade tires based on three



performance factors: treadwear, traction, and temperature resistance. For more information see *Uniform Tire Quality Grading on page 10-59*.

### (7) Maximum Cold Inflation

**Load Limit:** Maximum load that can be carried and the maximum pressure needed to support that load.

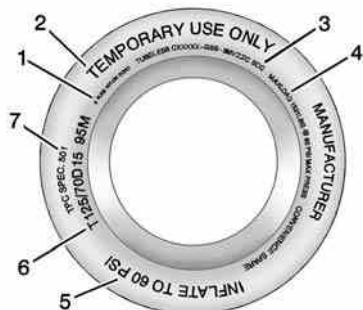

Compact Spare Tire Example

**(1) Tire Ply Material:** The type of cord and number of plies in the sidewall and under the tread.

**(2) Temporary Use Only:** The compact spare tire or temporary use tire should not be driven at speeds over 80 km/h (50 mph). The compact spare tire is for emergency use when a regular road tire has lost air and gone flat. If the vehicle has a compact spare tire, see *Compact Spare Tire on page 10-77* and *If a Tire Goes Flat on page 10-62*.

### (3) Tire Identification Number

**(TIN):** The letters and numbers following the DOT (Department of Transportation) code are the Tire Identification Number (TIN). The TIN shows the manufacturer and plant code, tire size, and date the tire was manufactured. The TIN is molded onto both sides of the tire, although only one side may have the date of manufacture.

**(4) Maximum Cold Inflation Load Limit:** Maximum load that can be carried and the maximum pressure needed to support that load.

**(5) Tire Inflation:** The temporary use tire or compact spare tire should be inflated to 420 kPa (60 psi). For more information on tire pressure and inflation see *Tire Pressure on page 10-48*.

**(6) Tire Size:** A combination of letters and numbers define a tire's width, height, aspect ratio, construction type, and service description. The letter T as the first character in the tire size means the tire is for temporary use only.

### (7) TPC Spec (Tire Performance Criteria Specification):

Original equipment tires designed to GM's specific tire performance

criteria have a TPC specification code molded onto the sidewall. GM's TPC specifications meet or exceed all federal safety guidelines.

## Tire Designations

### Tire Size

The following is an example of a typical passenger vehicle tire size.

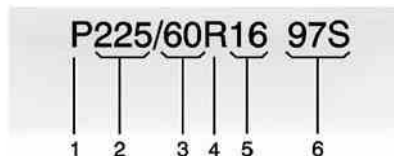

**(1) Passenger (P-Metric) Tire:** The United States version of a metric tire sizing system. The letter P as the first character in the tire size means a passenger

vehicle tire engineered to standards set by the U.S. Tire and Rim Association.

**(2) Tire Width:** The three-digit number indicates the tire section width in millimeters from sidewall to sidewall.

**(3) Aspect Ratio:** A two-digit number that indicates the tire height-to-width measurements. For example, if the tire size aspect ratio is 60, as shown in item 3 of the illustration, it would mean that the tire's sidewall is 60 percent as high as it is wide.

**(4) Construction Code:** A letter code is used to indicate the type of ply construction in the tire. The letter R means radial ply construction; the letter D means diagonal or bias ply construction; and the letter B means belted-bias ply construction.

**(5) Rim Diameter:** Diameter of the wheel in inches.

**(6) Service Description:** These characters represent the load index and speed rating of the tire. The load index represents the load carrying capacity a tire is certified to carry. The speed rating is the maximum speed a tire is certified to carry a load.

## Tire Terminology and Definitions

**Air Pressure:** The amount of air inside the tire pressing outward on each square inch of the tire. Air pressure is expressed in kPa (kilopascal) or psi (pounds per square inch).

**Accessory Weight:** The combined weight of optional accessories. Some examples of optional accessories are

## 10-46 Vehicle Care

---

automatic transmission, power windows, power seats, and air conditioning.

**Aspect Ratio:** The relationship of a tire's height to its width.

**Belt:** A rubber coated layer of cords between the plies and the tread. Cords may be made from steel or other reinforcing materials.

**Bead:** The tire bead contains steel wires wrapped by steel cords that hold the tire onto the rim.

**Bias Ply Tire:** A pneumatic tire in which the plies are laid at alternate angles less than 90 degrees to the centerline of the tread.

**Cold Tire Pressure:** The amount of air pressure in a tire, measured in kPa (kilopascal) or psi (pounds per square inch)

before a tire has built up heat from driving. See *Tire Pressure on page 10-48*.

**Curb Weight:** The weight of a motor vehicle with standard and optional equipment including the maximum capacity of fuel, oil, and coolant, but without passengers and cargo.

**DOT Markings:** A code molded into the sidewall of a tire signifying that the tire is in compliance with the U.S. Department of Transportation (DOT) Motor Vehicle Safety Standards. The DOT code includes the Tire Identification Number (TIN), an alphanumeric designator which can also identify the tire manufacturer, production plant, brand, and date of production.

**GVWR:** Gross Vehicle Weight Rating. See *Vehicle Load Limits on page 9-9*.

**GAWR FRT:** Gross Axle Weight Rating for the front axle. See *Vehicle Load Limits on page 9-9*.

**GAWR RR:** Gross Axle Weight Rating for the rear axle. See *Vehicle Load Limits on page 9-9*.

**Intended Outboard Sidewall:** The side of an asymmetrical tire that must always face outward when mounted on a vehicle.

**Kilopascal (kPa):** The metric unit for air pressure.

**Light Truck (LT-Metric) Tire:** A tire used on light duty trucks and some multipurpose passenger vehicles.

**Load Index:** An assigned number ranging from 1 to 279 that corresponds to the load carrying capacity of a tire.

**Maximum Inflation Pressure:**

The maximum air pressure to which a cold tire can be inflated. The maximum air pressure is molded onto the sidewall.

**Maximum Load Rating:** The load rating for a tire at the maximum permissible inflation pressure for that tire.

**Maximum Loaded Vehicle**

**Weight:** The sum of curb weight, accessory weight, vehicle capacity weight, and production options weight.

**Normal Occupant Weight:** The number of occupants a vehicle is designed to seat multiplied by 68 kg (150 lb). See *Vehicle Load Limits* on page 9-9.

**Occupant Distribution:** Designated seating positions.

**Outward Facing Sidewall:** The side of an asymmetrical tire that has a particular side that faces outward when mounted on a vehicle. The side of the tire that contains a whitewall, bears white lettering, or bears manufacturer, brand, and/or model name molding that is higher or deeper than the same moldings on the other sidewall of the tire.

**Passenger (P-Metric) Tire:** A tire used on passenger cars and some light duty trucks and multipurpose vehicles.

**Recommended Inflation Pressure:** Vehicle manufacturer's recommended tire inflation pressure as shown on the tire placard. See *Tire Pressure* on page 10-48 and *Vehicle Load Limits* on page 9-9.

**Radial Ply Tire:** A pneumatic tire in which the ply cords that extend to the beads are laid at 90 degrees to the centerline of the tread.

**Rim:** A metal support for a tire and upon which the tire beads are seated.

**Sidewall:** The portion of a tire between the tread and the bead.

**Speed Rating:** An alphanumeric code assigned to a tire indicating the maximum speed at which a tire can operate.

**Traction:** The friction between the tire and the road surface. The amount of grip provided.

**Tread:** The portion of a tire that comes into contact with the road.

**Treadwear Indicators:** Narrow bands, sometimes called wear bars, that show across the tread of a tire when only 1.6 mm (1/16 in) of tread remains. See *When It Is Time for New Tires* on page 10-56.

**UTQGS (Uniform Tire Quality Grading Standards):** A tire information system that provides consumers with ratings for a tire's traction, temperature, and treadwear. Ratings are determined by tire manufacturers using government testing procedures. The ratings are molded into the sidewall of the tire. See *Uniform Tire Quality Grading* on page 10-59.

**Vehicle Capacity Weight:** The number of designated seating positions multiplied by

68 kg (150 lb) plus the rated cargo load. See *Vehicle Load Limits* on page 9-9.

**Vehicle Maximum Load on the Tire:** Load on an individual tire due to curb weight, accessory weight, occupant weight, and cargo weight.

**Vehicle Placard:** A label permanently attached to a vehicle showing the vehicle capacity weight and the original equipment tire size and recommended inflation pressure. See "Tire and Loading Information Label" under *Vehicle Load Limits* on page 9-9.

### Tire Pressure

Tires need the correct amount of air pressure to operate effectively.

### Caution

Neither tire underinflation nor overinflation is good. Underinflated tires, or tires that do not have enough air, can result in:

- Tire overloading and overheating which could lead to a blowout.
- Premature or irregular wear.
- Poor handling.
- Reduced fuel economy.

Overinflated tires, or tires that have too much air, can result in:

- Unusual wear.
- Poor handling.
- Rough ride.
- Needless damage from road hazards.

The Tire and Loading Information label on the vehicle indicates the original equipment tires and the correct cold tire inflation pressures. The recommended pressure is the minimum air pressure needed to support the vehicle's maximum load carrying capacity. See *Vehicle Load Limits* on page 9-9.

How the vehicle is loaded affects vehicle handling and ride comfort. Never load the vehicle with more weight than it was designed to carry.

**When to Check**

Check the tires once a month or more. Do not forget the compact spare, if the vehicle has one. The cold compact spare tire pressure should be at 420 kPa (60 psi). See *Compact Spare Tire* on page 10-77.

**How to Check**

Use a good quality pocket-type gauge to check tire pressure. Proper tire inflation cannot be determined by looking at the tire. Check the tire inflation pressure when the tires are cold, meaning the vehicle has not been driven for at least three hours or no more than 1.6 km (1 mi).

Remove the valve cap from the tire valve stem. Press the tire gauge firmly onto the valve to get a pressure measurement. If the cold tire inflation pressure matches the recommended pressure on the Tire and Loading Information label, no further adjustment is necessary. If the inflation pressure is low, add air until the recommended pressure is reached. If the inflation pressure is high, press on the metal stem in the center of the tire valve to release air.

Recheck the tire pressure with the tire gauge.

Return the valve caps on the valve stems to prevent leaks and keep out dirt and moisture.

**Tire Pressure for High-Speed Operation**

 **Warning**

Driving at high speeds, 160 km/h (100 mph) or higher, puts an additional strain on tires. Sustained high-speed driving causes excessive heat buildup and can cause sudden tire failure. You could have a crash and you or others could be killed. Some high-speed rated tires require inflation pressure adjustment for high-speed operation. When speed limits and road conditions are such that a vehicle can be driven at high speeds, make sure

(Continued)

### Warning (Continued)

the tires are rated for high-speed operation, in excellent condition, and set to the correct cold tire inflation pressure for the vehicle load.

Vehicles with P235/65R18, P235/55R20, or 235/55R20 size tires require inflation pressure adjustment when driving the vehicle at speeds of 160 km/h (100 mph) or higher. Set the cold inflation pressure to the maximum inflation pressure shown on the tire sidewall, or 260 kPa (38 psi), whichever is lower. Return the tires to the recommended cold tire inflation pressure when high-speed driving has ended. See *Vehicle Load Limits* on page 9-9 and *Tire Pressure* on page 10-48.

The maximum load and inflation pressure is molded on the tire sidewall, in small letters, near the rim flange. It will read something like

this: Maximum load  
690 kg (1521 lbs) 300 kPa (44 psi)  
Max. Press.

### Tire Pressure Monitor System

The Tire Pressure Monitor System (TPMS) uses radio and sensor technology to check tire pressure levels. The TPMS sensors monitor the air pressure in your tires and transmit tire pressure readings to a receiver located in the vehicle.

Each tire, including the spare (if provided), should be checked monthly when cold and inflated to the inflation pressure recommended by the vehicle manufacturer on the vehicle placard or tire inflation pressure label. (If your vehicle has tires of a different size than the size indicated on the vehicle placard or tire inflation pressure label, you should determine the proper tire inflation pressure for those tires.)

As an added safety feature, your vehicle has been equipped with a tire pressure monitoring system (TPMS) that illuminates a low tire pressure telltale when one or more of your tires is significantly under-inflated.

Accordingly, when the low tire pressure telltale illuminates, you should stop and check your tires as soon as possible, and inflate them to the proper pressure. Driving on a significantly under-inflated tire causes the tire to overheat and can lead to tire failure. Under-inflation also reduces fuel efficiency and tire tread life, and may affect the vehicle's handling and stopping ability.

Please note that the TPMS is not a substitute for proper tire maintenance, and it is the driver's responsibility to maintain correct tire pressure, even if under-inflation has not reached the level to trigger illumination of the TPMS low tire pressure telltale.

Your vehicle has also been equipped with a TPMS malfunction indicator to indicate when the system is not operating properly. The TPMS malfunction indicator is combined with the low tire pressure telltale. When the system detects a malfunction, the telltale will flash for approximately one minute and then remain continuously illuminated. This sequence will continue upon subsequent vehicle start-ups as long as the malfunction exists.

When the malfunction indicator is illuminated, the system may not be able to detect or signal low tire pressure as intended. TPMS malfunctions may occur for a variety of reasons, including the installation of replacement or alternate tires or wheels on the vehicle that prevent the TPMS from functioning properly. Always check the TPMS malfunction telltale after replacing one or more tires or wheels on your vehicle to ensure that the replacement or

alternate tires and wheels allow the TPMS to continue to function properly.

See *Tire Pressure Monitor Operation* on page 10-51.

See *Radio Frequency Statement* on page 13-12.

## Tire Pressure Monitor Operation

This vehicle may have a Tire Pressure Monitor System (TPMS). The TPMS is designed to warn the driver when a low tire pressure condition exists. TPMS sensors are mounted onto each tire and wheel assembly, excluding the spare tire and wheel assembly. The TPMS sensors monitor the air pressure in the tires and transmits the tire pressure readings to a receiver located in the vehicle.



When a low tire pressure condition is detected, the TPMS illuminates the low tire pressure warning light on the instrument cluster. If the warning light comes on, stop as soon as possible and inflate the tires to the recommended pressure shown on the Tire and Loading Information label. See *Vehicle Load Limits* on page 9-9.

A message to check the pressure in a specific tire displays in the Driver Information Center (DIC). The low tire pressure warning light and the DIC warning message come on at each ignition cycle until the tires are inflated to the correct inflation pressure. Using the DIC, tire pressure levels can be viewed. For additional information and details



about the DIC operation and displays see *Driver Information Center (DIC)* on page 5-25.

The low tire pressure warning light may come on in cool weather when the vehicle is first started, and then turn off as the vehicle is driven. This could be an early indicator that the air pressure is getting low and needs to be inflated to the proper pressure.

A Tire and Loading Information label, attached to your vehicle, shows the size of the original equipment tires and the correct inflation pressure for the tires when they are cold. See *Vehicle Load Limits* on page 9-9, for an example of the Tire and Loading Information label and its location. Also see *Tire Pressure* on page 10-48.

The TPMS can warn about a low tire pressure condition but it does not replace normal tire

maintenance. See *Tire Inspection* on page 10-54, *Tire Rotation* on page 10-55 and *Tires* on page 10-41.

### **Caution**

Tire sealant materials are not all the same. A non-approved tire sealant could damage the TPMS sensors. TPMS sensor damage caused by using an incorrect tire sealant is not covered by the vehicle warranty. Always use only the GM approved tire sealant available through your dealer or included in the vehicle.

Factory-installed Tire Inflator Kits use a GM approved liquid tire sealant. Using non-approved tire sealants could damage the TPMS sensors. See *Tire Sealant and Compressor Kit* on page 10-63 for information regarding the inflator kit materials and instructions.

## **TPMS Malfunction Light and Message**

The TPMS will not function properly if one or more of the TPMS sensors are missing or inoperable. When the system detects a malfunction, the low tire warning light flashes for about one minute and then stays on for the remainder of the ignition cycle. A DIC warning message also displays. The malfunction light and DIC warning message come on at each ignition cycle until the problem is corrected. Some of the conditions that can cause these to come on are:

- One of the road tires has been replaced with the spare tire. The spare tire does not have a TPMS sensor. The malfunction light and DIC message should go off after the road tire is replaced and the sensor matching process is performed successfully. See “TPMS Sensor Matching Process” later in this section.

- The TPMS sensor matching process was not done or not completed successfully after rotating the tires. The malfunction light and the DIC message should go off after successfully completing the sensor matching process. See "TPMS Sensor Matching Process" later in this section.
- One or more TPMS sensors are missing or damaged. The malfunction light and the DIC message should go off when the TPMS sensors are installed and the sensor matching process is performed successfully. See your dealer for service.
- Replacement tires or wheels do not match the original equipment tires or wheels. Tires and wheels other than those recommended could prevent the TPMS from functioning properly. See *Buying New Tires* on page 10-57.

- Operating electronic devices or being near facilities using radio wave frequencies similar to the TPMS could cause the TPMS sensors to malfunction.

If the TPMS is not functioning properly it cannot detect or signal a low tire condition. See your dealer for service if the TPMS malfunction light and DIC message comes on and stays on.

### TPMS Sensor Matching Process

Each TPMS sensor has a unique identification code. The identification code needs to be matched to a new tire/wheel position after rotating the vehicle's tires or replacing one or more of the TPMS sensors. The TPMS sensor matching process should also be performed after replacing a spare tire with a road tire containing the TPMS sensor. The malfunction light and the DIC message should go off at the next ignition cycle. The sensors are matched to the tire/wheel positions,

using a TPMS relearn tool, in the following order: driver side front tire, passenger side front tire, passenger side rear tire, and driver side rear. See your dealer for service or to purchase a relearn tool. A TPMS relearn tool can also be purchased. See Tire Pressure Monitor Sensor Activation Tool at [www.gmtoolsandequipment.com](http://www.gmtoolsandequipment.com) or call 1-800-GM TOOLS (1-800-468-6657).

There are two minutes to match the first tire/wheel position, and five minutes overall to match all four tire/wheel positions. If it takes longer, the matching process stops and must be restarted.

The TPMS sensor matching process is:

1. Set the parking brake.
2. Place the vehicle power mode in ON/RUN/START. See *Ignition Positions* on page 9-15.

3. Make sure the Tire Pressure info display option is turned on. The info displays on the DIC can be turned on and off through the Settings menu. See *Driver Information Center (DIC) on page 5-25*.
4. Use the five-way DIC control on the right side of the steering wheel to scroll to the Tire Pressure screen under the DIC info page. See *Driver Information Center (DIC) on page 5-25*.
5. Press and hold the SEL button in the center of the five-way DIC control.  

The horn sounds twice to signal the receiver is in relearn mode and the TIRE LEARNING ACTIVE message displays on the DIC screen.
6. Start with the driver side front tire.

7. Place the relearn tool against the tire sidewall, near the valve stem. Then press the button to activate the TPMS sensor. A horn chirp confirms that the sensor identification code has been matched to this tire and wheel position.
8. Proceed to the passenger side front tire, and repeat Step 7.
9. Proceed to the passenger side rear tire, and repeat Step 7.
10. Proceed to the driver side rear tire, and repeat Step 7. The horn sounds two times to indicate the sensor identification code has been matched to the driver side rear tire, and the TPMS sensor matching process is no longer active. The TIRE LEARNING ACTIVE message on the DIC display screen goes off.
11. Shut the ignition off.

12. Set all four tires to the recommended air pressure level as indicated on the Tire and Loading Information label.

### Tire Inspection

We recommend that the tires, including the spare tire, if the vehicle has one, be inspected for signs of wear or damage at least once a month.

Replace the tire if:

- The indicators at three or more places around the tire can be seen.
- There is cord or fabric showing through the tire's rubber.
- The tread or sidewall is cracked, cut, or snagged deep enough to show cord or fabric.
- The tire has a bump, bulge, or split.

- The tire has a puncture, cut, or other damage that cannot be repaired well because of the size or location of the damage.

## Tire Rotation

Tires should be rotated every 12 000 km (7,500 mi). See *Maintenance Schedule on page 11-3*.

Tires are rotated to achieve a uniform wear for all tires. The first rotation is the most important.

Anytime unusual wear is noticed, rotate the tires as soon as possible, check for proper tire inflation pressure, and check for damaged tires or wheels. If the unusual wear continues after the rotation, check the wheel

alignment. See *When It Is Time for New Tires on page 10-56* and *Wheel Replacement on page 10-60*.

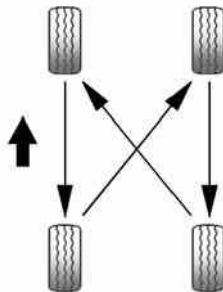

Use this rotation pattern when rotating the tires.

Do not include the compact spare tire in the tire rotation.

Adjust the front and rear tires to the recommended inflation pressure on the Tire and Loading Information label after

the tires have been rotated. See *Tire Pressure on page 10-48* and *Vehicle Load Limits on page 9-9*.

Reset the Tire Pressure Monitor System. See *Tire Pressure Monitor Operation on page 10-51*.

Check that all wheel nuts are properly tightened. See “Wheel Nut Torque” under *Capacities and Specifications on page 12-2*.

### Warning

Rust or dirt on a wheel, or on the parts to which it is fastened, can make wheel nuts become loose after time. The wheel could come off and cause an accident. When changing a wheel, remove any rust or dirt from places where the wheel attaches to the vehicle. In

(Continued)

### Warning (Continued)

an emergency, a cloth or a paper towel can be used; however, use a scraper or wire brush later to remove all rust or dirt.

Lightly coat the center of the wheel hub with wheel bearing grease after a wheel change or tire rotation to prevent corrosion or rust build-up. Do not get grease on the flat wheel mounting surface or on the wheel nuts or bolts.

### When It Is Time for New Tires

Factors such as maintenance, temperatures, driving speeds, vehicle loading, and road conditions affect the wear rate of the tires.

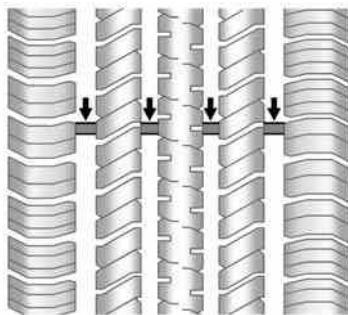

Treadwear indicators are one way to tell when it is time for new tires. Treadwear indicators appear when the tires have only 1.6 mm (1/16 in) or less of tread remaining. See *Tire Inspection* on page 10-54 and *Tire Rotation* on page 10-55.

The rubber in tires ages over time. This also applies to the spare tire, if the vehicle has one, even if it is never used. Multiple factors including temperatures, loading conditions, and inflation pressure maintenance affect how fast aging takes place. GM recommends that tires, including the spare if

equipped, be replaced after six years, regardless of tread wear. The tire manufacture date is the last four digits of the DOT Tire Identification Number (TIN) which is molded into one side of the tire sidewall. The first two digits represent the week (01–52) and the last two digits, the year. For example, the third week of the year 2010 would have a four-digit DOT date of 0310.

### Vehicle Storage

Tires age when stored normally mounted on a parked vehicle. Park a vehicle that will be stored for at least a month in a cool, dry, clean area away from direct sunlight to slow aging. This area should be free of grease, gasoline, or other substances that can deteriorate rubber.

Parking for an extended period can cause flat spots on the tires that may result in vibrations while driving. When storing a vehicle for

at least a month, remove the tires or raise the vehicle to reduce the weight from the tires.

## Buying New Tires

GM has developed and matched specific tires for the vehicle. The original equipment tires installed were designed to meet General Motors Tire Performance Criteria Specification (TPC Spec) system rating. When replacement tires are needed, GM strongly recommends buying tires with the same TPC Spec rating.

GM's exclusive TPC Spec system considers over a dozen critical specifications that impact the overall performance of the vehicle, including brake system performance, ride and handling, traction control, and tire pressure monitoring performance. GM's TPC Spec

number is molded onto the tire's sidewall near the tire size. If the tires have an all-season tread design, the TPC Spec number will be followed by MS for mud and snow. See *Tire Sidewall Labeling* on page 10-43.

GM recommends replacing worn tires in complete sets of four. Uniform tread depth on all tires will help to maintain the performance of the vehicle. Braking and handling performance may be adversely affected if all the tires are not replaced at the same time. If proper rotation and maintenance have been done, all four tires should wear out at about the same time. See *Tire Rotation* on page 10-55. However, if it is necessary to replace only one axle set of worn tires, place the new tires on the rear axle.

Winter tires with the same speed rating as the original equipment tires may not be available for H, V, W, Y and ZR speed rated tires. Never exceed the winter tires' maximum speed capability when using winter tires with a lower speed rating.

### Warning

Tires could explode during improper service. Attempting to mount or dismount a tire could cause injury or death. Only your dealer or authorized tire service center should mount or dismount the tires.

 **Warning**

Mixing tires of different sizes, brands, or types may cause loss of control of the vehicle, resulting in a crash or other vehicle damage. Use the correct size, brand, and type of tires on all wheels.

 **Warning**

Using bias-ply tires on the vehicle may cause the wheel rim flanges to develop cracks after many miles of driving. A tire and/or wheel could fail suddenly and cause a crash. Use only radial-ply tires with the wheels on the vehicle.

If the vehicle tires must be replaced with a tire that does not have a TPC Spec number, make

sure they are the same size, load range, speed rating, and construction (radial) as the original tires.

Vehicles that have a tire pressure monitoring system could give an inaccurate low-pressure warning if non-TPC Spec rated tires are installed. See *Tire Pressure Monitor System on page 10-50*.

The Tire and Loading Information label indicates the original equipment tires on the vehicle. See *Vehicle Load Limits on page 9-9*.

### **Different Size Tires and Wheels**

If wheels or tires are installed that are a different size than the original equipment wheels and tires, vehicle performance, including its braking, ride and handling characteristics, stability, and resistance to rollover

may be affected. If the vehicle has electronic systems such as antilock brakes, rollover airbags, traction control, electronic stability control, or All-Wheel Drive, the performance of these systems can also be affected.

 **Warning**

If different sized wheels are used, there may not be an acceptable level of performance and safety if tires not recommended for those wheels are selected. This increases the chance of a crash and serious injury. Only use GM specific wheel and tire systems developed for the vehicle, and have them properly installed by a GM certified technician.

See *Buying New Tires on page 10-57* and *Accessories and Modifications on page 10-3*.

## Uniform Tire Quality Grading

The following information relates to the system developed by the United States National Highway Traffic Safety Administration (NHTSA), which grades tires by treadwear, traction, and temperature performance. This applies only to vehicles sold in the United States. The grades are molded on the sidewalls of most passenger car tires. The Uniform Tire Quality Grading (UTQG) system does not apply to deep tread, winter tires, compact spare tires, tires with nominal rim diameters of 10 to 12 inches (25 to 30 cm), or to some limited-production tires.

While the tires available on General Motors passenger cars and light trucks may vary with respect to these grades, they

must also conform to federal safety requirements and additional General Motors Tire Performance Criteria (TPC) standards.

Quality grades can be found where applicable on the tire sidewall between tread shoulder and maximum section width. For example:

### **Treadwear 200 Traction AA Temperature A**

All Passenger Car Tires Must Conform to Federal Safety Requirements In Addition To These Grades.

### **Treadwear**

The treadwear grade is a comparative rating based on the wear rate of the tire when tested under controlled conditions on a specified government test course. For example, a tire graded 150 would wear one and

one-half (1½) times as well on the government course as a tire graded 100. The relative performance of tires depends upon the actual conditions of their use, however, and may depart significantly from the norm due to variations in driving habits, service practices and differences in road characteristics and climate.

### **Traction**

The traction grades, from highest to lowest, are AA, A, B, and C. Those grades represent the tire's ability to stop on wet pavement as measured under controlled conditions on specified government test surfaces of asphalt and concrete. A tire marked C may have poor traction performance. Warning: The traction grade assigned to this tire is based on straight-ahead braking traction



tests, and does not include acceleration, cornering, hydroplaning, or peak traction characteristics.

### Temperature

The temperature grades are A (the highest), B, and C, representing the tire's resistance to the generation of heat and its ability to dissipate heat when tested under controlled conditions on a specified indoor laboratory test wheel. Sustained high temperature can cause the material of the tire to degenerate and reduce tire life, and excessive temperature can lead to sudden tire failure. The grade C corresponds to a level of performance which all passenger car tires must meet under the Federal Motor Safety Standard No. 109. Grades B and A represent higher levels of performance on the laboratory

test wheel than the minimum required by law. Warning: The temperature grade for this tire is established for a tire that is properly inflated and not overloaded. Excessive speed, underinflation, or excessive loading, either separately or in combination, can cause heat buildup and possible tire failure.

### Wheel Alignment and Tire Balance

The tires and wheels were aligned and balanced at the factory to provide the longest tire life and best overall performance. Adjustments to wheel alignment and tire balancing are not necessary on a regular basis. Consider an alignment check if there is unusual tire wear or the vehicle is significantly pulling to one side or the other. Some slight pull to the left or right, depending on the crown of the road and/or other road surface variations such as troughs or ruts, is normal. If the vehicle is

vibrating when driving on a smooth road, the tires and wheels may need to be rebalanced. See your dealer for proper diagnosis.

### Wheel Replacement

Replace any wheel that is bent, cracked, or badly rusted or corroded. If wheel nuts keep coming loose, the wheel, wheel bolts, and wheel nuts should be replaced. If the wheel leaks air, replace it. Some aluminum wheels can be repaired. See your dealer if any of these conditions exist.

Your dealer will know the kind of wheel that is needed.

Each new wheel should have the same load-carrying capacity, diameter, width, offset, and be mounted the same way as the one it replaces.

Replace wheels, wheel bolts, wheel nuts, or Tire Pressure Monitor System (TPMS) sensors with new GM original equipment parts.

 **Warning**

Using the wrong replacement wheels, wheel bolts, or wheel nuts can be dangerous. It could affect the braking and handling of the vehicle. Tires can lose air, and cause loss of control, causing a crash. Always use the correct wheel, wheel bolts, and wheel nuts for replacement.

 **Caution**

The wrong wheel can also cause problems with bearing life, brake cooling, speedometer or odometer calibration, headlamp aim, bumper height, vehicle ground clearance, and tire or tire chain clearance to the body and chassis.

**Used Replacement Wheels**

 **Warning**

Replacing a wheel with a used one is dangerous. How it has been used or how far it has been driven may be unknown. It could fail suddenly and cause a crash. When replacing wheels, use a new GM original equipment wheel.

**Tire Chains**

 **Warning**

Do not use tire chains. There is not enough clearance. Tire chains used on a vehicle without the proper amount of clearance can cause damage to the brakes, suspension, or other vehicle

(Continued)

**Warning (Continued)**

parts. The area damaged by the tire chains could cause loss of control and a crash.

Use another type of traction device only if its manufacturer recommends it for the vehicle's tire size combination and road conditions. Follow that manufacturer's instructions. To avoid vehicle damage, drive slow and readjust or remove the traction device if it contacts the vehicle. Do not spin the wheels. If traction devices are used, install them on the front tires.

## If a Tire Goes Flat

It is unusual for a tire to blow out while driving, especially if the tires are maintained properly. See *Tires on page 10-41*. If air goes out of a tire, it is much more likely to leak out slowly. But if there is ever a blowout, here are a few tips about what to expect and what to do:

If a front tire fails, the flat tire creates a drag that pulls the vehicle toward that side. Take your foot off the accelerator pedal and grip the steering wheel firmly. Steer to maintain lane position, and then gently brake to a stop, well off the road, if possible.

A rear blowout, particularly on a curve, acts much like a skid and may require the same correction as used in a skid. Stop pressing the accelerator pedal and steer to straighten the vehicle. It may be very bumpy and noisy. Gently brake to a stop, well off the road, if possible.

### Warning

Driving on a flat tire will cause permanent damage to the tire. Re-inflating a tire after it has been driven on while severely underinflated or flat may cause a blowout and a serious crash. Never attempt to re-inflate a tire that has been driven on while severely underinflated or flat. Have your dealer or an authorized tire service center repair or replace the flat tire as soon as possible.

### Warning

Lifting a vehicle and getting under it to do maintenance or repairs is dangerous without the appropriate safety equipment and training. If a jack is provided with the vehicle, it is designed only for

(Continued)

### Warning (Continued)

changing a flat tire. If it is used for anything else, you or others could be badly injured or killed if the vehicle slips off the jack. If a jack is provided with the vehicle, only use it for changing a flat tire.

If a tire goes flat, avoid further tire and wheel damage by driving slowly to a level place, well off the road, if possible. Turn on the hazard warning flashers. See *Hazard Warning Flashers on page 6-6*.

### Warning

Changing a tire can be dangerous. The vehicle can slip off the jack and roll over or fall causing injury or death. Find a level place to change the tire. To help prevent the vehicle from moving:

(Continued)

**Warning (Continued)**

1. Set the parking brake firmly.
2. Put an automatic transmission in P (Park) or a manual transmission in 1 (First) or R (Reverse).
3. Turn off the engine and do not restart while the vehicle is raised.
4. Do not allow passengers to remain in the vehicle.
5. Place wheel blocks, if equipped, on both sides of the tire at the opposite corner of the tire being changed.

This vehicle may come with a jack and spare tire or a tire sealant and compressor kit. To use the jacking equipment to change a spare tire safely, follow the instructions below.

Then see *Tire Changing on page 10-71*. To use the tire sealant and compressor kit, see *Tire Sealant and Compressor Kit on page 10-63*.

When the vehicle has a flat tire (2), use the following example as a guide to assist you in the placement of wheel blocks (1), if equipped.

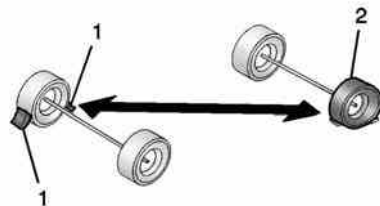

1. Wheel Block (If Equipped)
2. Flat Tire

The following information explains how to repair or change a tire.

**Tire Sealant and Compressor Kit****⚠ Warning**

Idling a vehicle in an enclosed area with poor ventilation is dangerous. Engine exhaust may enter the vehicle. Engine exhaust contains carbon monoxide (CO) which cannot be seen or smelled. It can cause unconsciousness and even death. Never run the engine in an enclosed area that has no fresh air ventilation. For more information, see *Engine Exhaust on page 9-21*.

**⚠ Warning**

Overinflating a tire could cause the tire to rupture and you or others could be injured. Be sure to read and follow the tire sealant

(Continued)

### Warning (Continued)

and compressor kit instructions and inflate the tire to its recommended pressure. Do not exceed the recommended pressure.

### Warning

Storing the tire sealant and compressor kit or other equipment in the passenger compartment of the vehicle could cause injury. In a sudden stop or collision, loose equipment could strike someone. Store the tire sealant and compressor kit in its original location.

If this vehicle has a tire sealant and compressor kit, there may not be a spare tire or tire changing

equipment, and on some vehicles there may not be a place to store a tire.

The tire sealant and compressor can be used to temporarily seal punctures up to 6 mm (0.25 in) in the tread area of the tire. It can also be used to inflate an underinflated tire.

If the tire has been separated from the wheel, has damaged sidewalls, or has a large puncture, the tire is too severely damaged for the tire sealant and compressor kit to be effective. See *Roadside Service* on page 13-5.

Read and follow all of the tire sealant and compressor kit instructions.

The kit includes:



1. Selector Switch (Sealant/Air or Air Only)
2. On/Off Button
3. Pressure Gauge
4. Pressure Deflation Button
5. Tire Sealant Canister
6. Sealant/Air Hose (Clear)
7. Air Only Hose (Black)
8. Power Plug
9. Canister Release Button (Under Sealant/Air Hose)

### Tire Sealant

Read and follow the safe handling instructions on the label adhered to the sealant canister.

Check the tire sealant expiration date on the sealant canister. The sealant canister should be replaced before its expiration date.

Replacement sealant canisters are available at your local dealer. See "Removal and Installation of the Sealant Canister" following.

There is only enough sealant to seal one tire. After usage, the sealant canister and sealant/air hose assembly must be replaced. See "Removal and Installation of the Sealant Canister" following.

### Using the Tire Sealant and Compressor Kit to Temporarily Seal and Inflate a Punctured Tire

Follow the directions closely for correct sealant usage.



1. Selector Switch (Sealant/Air or Air Only)
2. On/Off Button

## 10-66 Vehicle Care

---

3. Pressure Gauge
4. Pressure Deflation Button
5. Tire Sealant Canister
6. Sealant/Air Hose (Clear)
7. Air Only Hose (Black)
8. Power Plug
9. Canister Release Button (Under Sealant/Air Hose)

When using the tire sealant and compressor kit during cold temperatures, warm the kit in a heated environment for five minutes. This will help to inflate the tire faster.

If a tire goes flat, avoid further tire and wheel damage by driving slowly to a level place. Turn on the hazard warning flashers. See *Hazard Warning Flashers* on page 6-6.

See *If a Tire Goes Flat* on page 10-62 for other important safety warnings.

Do not remove any objects that have penetrated the tire.

1. Remove the tire sealant and compressor kit from its storage location. See *Storing the Tire Sealant and Compressor Kit* on page 10-71.
2. Unwrap the sealant/air hose (6) and the power plug (8).
3. Place the kit on the ground.  
Make sure the tire valve stem is positioned close to the ground so the hose will reach it.
4. Remove the valve stem cap from the flat tire by turning it counterclockwise.
5. Attach the sealant/air hose (6) onto the tire valve stem. Turn it clockwise until it is tight.

6. Plug the power plug (8) into the accessory power outlet in the vehicle. Unplug all items from other accessory power outlets. See *Power Outlets* on page 5-6.

If the vehicle has an accessory power outlet, do not use the cigarette lighter.

If the vehicle only has a cigarette lighter, use the cigarette lighter.

Do not pinch the power plug cord in the door or window.

7. Start the vehicle. The vehicle must be running while using the air compressor.
8. Press and turn the selector switch (1) counterclockwise to the Sealant + Air position.

9. Press the on/off button (2) to turn the tire sealant and compressor kit on.

The compressor will inject sealant and air into the tire.

The pressure gauge (3) will initially show a high pressure while the compressor pushes the sealant into the tire. Once the sealant is completely dispersed into the tire, the pressure will quickly drop and start to rise again as the tire inflates with air only.

10. Inflate the tire to the recommended inflation pressure using the pressure gauge (3). The recommended inflation pressure can be found on the Tire and Loading Information label. See *Tire Pressure* on page 10-48.

The pressure gauge (3) may read higher than the actual tire pressure while the compressor is on. Turn the compressor off to get an accurate pressure

reading. The compressor may be turned on/off until the correct pressure is reached.

 **Caution**

If the recommended pressure cannot be reached after approximately 25 minutes, the vehicle should not be driven farther. The tire is too severely damaged and the tire sealant and compressor kit cannot inflate the tire. Remove the power plug from the accessory power outlet and unscrew the inflating hose from the tire valve. See *Roadside Service* on page 13-5.

11. Press the on/off button (2) to turn the tire sealant and compressor kit off.

The tire is not sealed and will continue to leak air until the vehicle is driven and the sealant is distributed in the tire, therefore, Steps 12–18 must be done immediately after Step 11.

Be careful while handling the tire sealant and compressor kit as it could be warm after usage.

12. Unplug the power plug (8) from the accessory power outlet in the vehicle.
13. Turn the sealant/air hose (6) counterclockwise to remove it from the tire valve stem.
14. Replace the tire valve stem cap.
15. Replace the sealant/air hose (6), and the power plug (8) back in their original location.





16. If the flat tire was able to inflate to the recommended inflation pressure, remove the maximum speed label from the sealant canister (5) and place it in a highly visible location. Do not exceed the speed on this label until the damaged tire is repaired or replaced.
17. Return the equipment to its original storage location in the vehicle.
18. Immediately drive the vehicle 8 km (5 mi) to distribute the sealant in the tire.

19. Stop at a safe location and check the tire pressure. Refer to Steps 1–11 under “Using the Tire Sealant and Compressor Kit without Sealant to Inflate a Tire (Not Punctured).”

If the tire pressure has fallen more than 68 kPa (10 psi) below the recommended inflation pressure, stop driving the vehicle. The tire is too severely damaged and the tire sealant cannot seal the tire. See *Roadside Service* on page 13-5.

If the tire pressure has not dropped more than 68 kPa (10 psi) from the recommended inflation pressure, inflate the tire to the recommended inflation pressure.

20. Wipe off any sealant from the wheel, tire, and vehicle.

21. Dispose of the used sealant canister (5) and sealant/air hose (6) assembly at a local dealer or in accordance with local state codes and practices.
22. Replace with a new canister assembly available from your dealer.
23. After temporarily sealing the tire using the tire sealant and compressor kit, take the vehicle to an authorized dealer within 161 km (100 mi) of driving to have the tire repaired or replaced.

**Using the Tire Sealant and Compressor Kit without Sealant to Inflate a Tire (Not Punctured)**

To use the air compressor to inflate a tire with air only and not sealant:



1. Selector Switch (Sealant/Air or Air Only)
2. On/Off Button

3. Pressure Gauge
4. Pressure Deflation Button
5. Tire Sealant Canister
6. Sealant/Air Hose (Clear)
7. Air Only Hose (Black)
8. Power Plug
9. Canister Release Button (Under Sealant/Air Hose)

If a tire goes flat, avoid further tire and wheel damage by driving slowly to a level place. Turn on the hazard warning flashers. See *Hazard Warning Flashers* on page 6-6.

See *If a Tire Goes Flat* on page 10-62 for other important safety warnings.

1. Remove the tire sealant and compressor kit from its storage location. See *Storing the Tire Sealant and Compressor Kit* on page 10-71.
2. Unwrap the air only hose (7) and the power plug (8).

3. Place the kit on the ground.

Make sure the tire valve stem is positioned close to the ground so the hose will reach it.

4. Remove the tire valve stem cap from the flat tire by turning it counterclockwise.
5. Attach the air only hose (7) onto the tire valve stem by turning it clockwise until it is tight.
6. Plug the power plug (8) into the accessory power outlet in the vehicle. Unplug all items from other accessory power outlets. See *Power Outlets* on page 5-6.

If the vehicle has an accessory power outlet, do not use the cigarette lighter.

If the vehicle only has a cigarette lighter, use the cigarette lighter.

Do not pinch the power plug cord in the door or window.

7. Start the vehicle. The vehicle must be running while using the air compressor.

## 10-70 Vehicle Care

8. Press and turn the selector switch (1) clockwise to the Air Only position.

9. Press the on/off button (2) to turn the compressor on.

The compressor will inflate the tire with air only.

10. Inflate the tire to the recommended inflation pressure using the pressure gauge (3). The recommended inflation pressure can be found on the Tire and Loading Information label. See *Tire Pressure* on page 10-48.

The pressure gauge (3) may read higher than the actual tire pressure while the compressor is on. Turn the compressor off to get an accurate reading. The compressor may be turned on/off until the correct pressure is reached.

If you inflate the tire higher than the recommended pressure you can adjust the

excess pressure by pressing the pressure deflation button (4) until the proper pressure reading is reached. This option is only functional when using the air only hose (7).

11. Press the on/off button (2) to turn the tire sealant and compressor kit off.

Be careful while handling the tire sealant and compressor kit as it could be warm after usage.

12. Unplug the power plug (8) from the accessory power outlet in the vehicle.

13. Disconnect the air only hose (7) from the tire valve stem, by turning it counterclockwise, and replace the tire valve stem cap.

14. Replace the air only hose (7) and the power plug (8) and cord back in its original location.

15. Place the equipment in the original storage location in the vehicle.



The tire sealant and compressor kit has an accessory adapter located in a compartment on the bottom of its housing that may be used to inflate air mattresses, balls, etc.

### Removal and Installation of the Sealant Canister

To remove the sealant canister:

1. Unwrap the sealant hose.

2. Press the canister release button (9).
3. Pull up and remove the canister.
4. Replace with a new canister which is available from your dealer.
5. Push the new canister into place.

## Storing the Tire Sealant and Compressor Kit



This vehicle may have a tire sealant and compressor kit in place of a jack or spare tire. It is located in a foam container in the rear compartment storage area. If the vehicle has a cargo cover, see *Cargo Management System on page 4-5* for instructions on how to access the tire sealant and compressor kit.

## Tire Changing

### Removing the Spare Tire and Tools

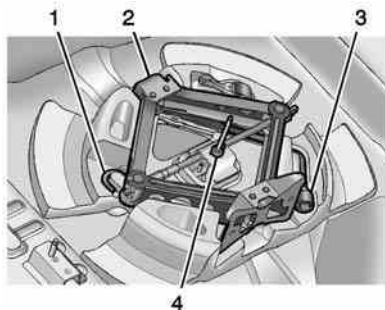

1. Extension
2. Jack
3. Wheel Wrench
4. Wing Nut

To access the spare tire and tools:

1. Open the liftgate. See *Liftgate on page 2-14*.

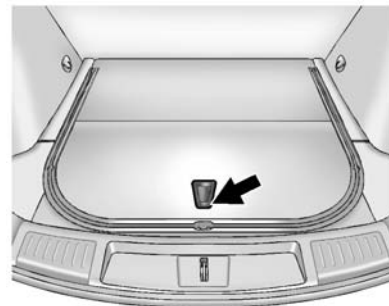

2. Press on the bottom of the handle assembly to unlatch it and lift up on the handle.

The prop rod locks into place when open.

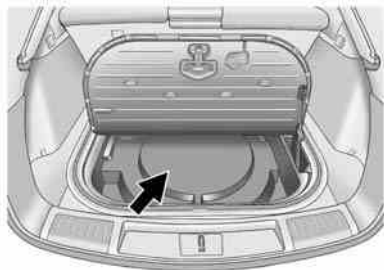

3. Remove the spare tire cover.

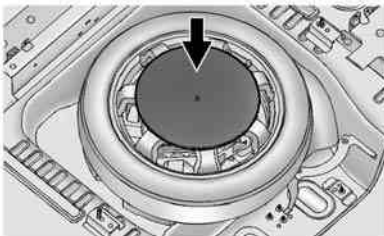

4. Remove the rubber cover.

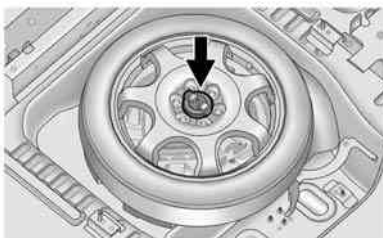

5. Remove the nut retaining the spare tire.
6. Remove the spare tire and place it next to the tire being changed.
7. Remove the wing nut.
8. Remove the extension, jack, and wheel wrench and place them near the tire being changed.

### Removing the Flat Tire and Installing the Spare Tire

Take off the wheel cover or center cap, if the vehicle has one, to reach the wheel bolts.

1. Do a safety check before proceeding. See *If a Tire Goes Flat* on page 10-62 for more information.
2. Turn the wheel wrench counterclockwise to loosen and remove the wheel nut caps.  
  
Do not try to remove plastic caps from the cover or center cap.
3. Pull the cover or center cap away from the wheel. Store the wheel cover in the cargo area until you have the flat tire repaired or replaced.

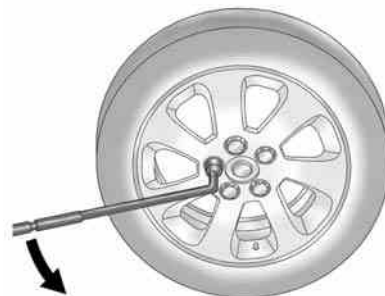

4. Turn the wheel wrench counterclockwise to loosen all the wheel nuts, but do not remove them yet.
5. Place the jack near the flat tire.

**⚠ Caution**

Make sure that the jack lift head is in the correct position or you may damage your vehicle. The repairs would not be covered by your warranty.

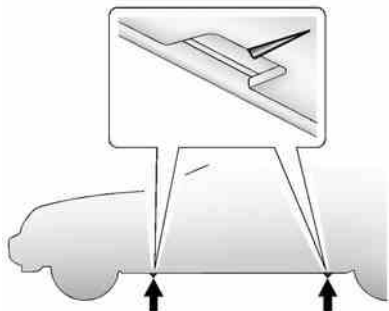

6. Position the jack lift head at the jack location nearest the flat tire.  
The jacking location is indicated by a V-shaped notch in the plastic molding. The jack must not be used in any other position.

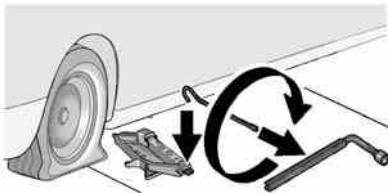

7. Insert the hooked end of the extension handle through the jack and the flat end through the wheel wrench.

**⚠ Warning**

Getting under a vehicle when it is lifted on a jack is dangerous. If the vehicle slips off the jack, you could be badly injured or killed. Never get under a vehicle when it is supported only by a jack.

**⚠ Warning**

Raising the vehicle with the jack improperly positioned can damage the vehicle and even make the vehicle fall. To help avoid personal injury and vehicle damage, be sure to fit the jack lift head into the proper location before raising the vehicle.

**Warning**

Lifting a vehicle and getting under it to do maintenance or repairs is dangerous without the appropriate safety equipment and training. If a jack is provided with the vehicle, it is designed only for changing a flat tire. If it is used for anything else, you or others could be badly injured or killed if the vehicle slips off the jack. If a jack is provided with the vehicle, only use it for changing a flat tire.

8. Turn the extension with the wheel wrench clockwise to raise the jack lift head until the jack just fits under the vehicle.

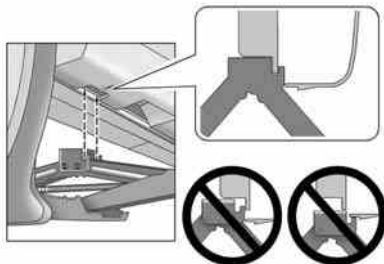

9. Raise the vehicle by turning the wheel wrench clockwise until the slots in the jack head fit into the metal flange located behind the triangle on the plastic moulding.

**Caution**

Using a jack to raise the vehicle without positioning it correctly could damage your vehicle. When raising your vehicle on a jack, be sure to position it correctly under the frame and avoid contact with the plastic molding.

10. Put the compact spare tire near you.

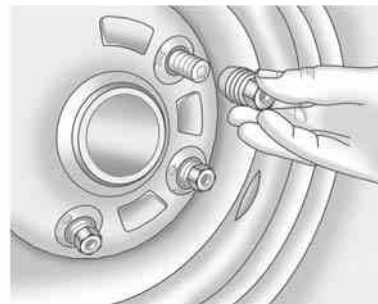

Remove all of the wheel nuts.

11. Remove the flat tire.

**Warning**

Rust or dirt on a wheel, or on the parts to which it is fastened, can make wheel nuts become loose after time. The wheel could come off and cause an accident. When

(Continued)

**Warning (Continued)**

changing a wheel, remove any rust or dirt from places where the wheel attaches to the vehicle. In an emergency, a cloth or a paper towel can be used; however, use a scraper or wire brush later to remove all rust or dirt.

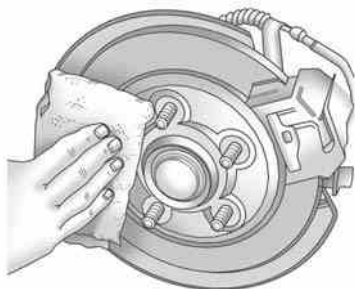

12. Remove any rust or dirt from the wheel bolts, mounting surfaces, and spare wheel.

13. Place the compact spare tire on the wheel-mounting surface.

**Warning**

Never use oil or grease on bolts or nuts because the nuts might come loose. The vehicle's wheel could fall off, causing a crash.

14. Reinstall the wheel nuts. Tighten each nut by hand until the wheel is held against the hub.
15. Lower the vehicle by turning the jack handle counterclockwise.

**Warning**

Wheel nuts that are improperly or incorrectly tightened can cause the wheels to become loose or come off. The wheel nuts should be tightened with a torque wrench

(Continued)

**Warning (Continued)**

to the proper torque specification after replacing. Follow the torque specification supplied by the aftermarket manufacturer when using accessory locking wheel nuts. See *Capacities and Specifications on page 12-2* for original equipment wheel nut torque specifications.

**Caution**

Improperly tightened wheel nuts can lead to brake pulsation and rotor damage. To avoid expensive brake repairs, evenly tighten the wheel nuts in the proper sequence and to the proper torque specification. See *Capacities and Specifications on page 12-2* for the wheel nut torque specification.



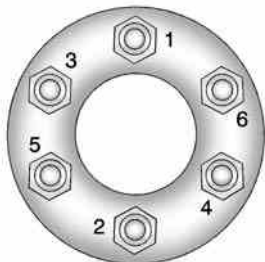

16. Tighten the wheel nuts firmly in a crisscross sequence, as shown.
17. Lower the jack all the way and remove the jack from under the vehicle.
18. Tighten the wheel nuts firmly with the wheel wrench.

When reinstalling the wheel cover or center cap on the full-size tire, tighten all six plastic caps hand snug with the aid of the wheel wrench and tighten them with the wheel wrench an additional one-quarter of a turn.

**⚠ Caution**

Wheel covers will not fit on the vehicle's compact spare. If you try to put a wheel cover on the compact spare, the cover or the spare could be damaged.

**Storing a Flat or Spare Tire and Tools**

**⚠ Warning**

Storing a jack, a tire, or other equipment in the passenger compartment of the vehicle could cause injury. In a sudden stop or collision, loose equipment could strike someone. Store all these in the proper place.

To store the flat or spare tire and tools:

1. Open the liftgate. See *Liftgate* on page 2-14 for more information.

2. Put back all tools as they were stored in the rear storage compartment and put the compartment cover back on. For more information, see "Storing the Compact Spare Tire and Tools" next in this section.
3. Install the cargo cover. For more information, see *Cargo Management System* on page 4-5.
4. Place the tire, lying flat, in the rear storage compartment.



- Attach the strap to the cargo tie-down in the rear of the vehicle.

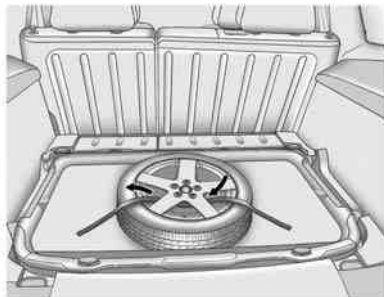

- Route the strap through the wheel, as shown.
- Attach the strap to the other cargo tie-down in the rear of the vehicle.
- Tighten the strap.
- Replace the rubber cover.

The compact spare is for temporary use only. Replace the compact spare tire with a full-size tire as soon as you can.

### Compact Spare Tire

#### Warning

Driving with more than one compact spare tire at a time could result in loss of braking and handling. This could lead to a crash and you or others could be injured. Use only one compact spare tire at a time.

If this vehicle has a compact spare tire, it was fully inflated when new; however, it can lose air over time. Check the inflation pressure regularly. It should be 420 kPa (60 psi).

Stop as soon as possible and check that the spare tire is correctly inflated after being installed on the vehicle. The compact spare tire is

designed for temporary use only. The vehicle will perform differently with the spare tire installed and it is recommended that the vehicle speed be limited to 80 km/h (50 mph). To conserve the tread of the spare tire, have the standard tire repaired or replaced as soon as convenient and return the spare tire to the storage area.

When using a compact spare tire, the ABS and Traction Control systems may engage until the spare tire is recognized by the vehicle, especially on slippery roads. Adjust driving to reduce possible wheel slip.

#### Caution

When the compact spare is installed, do not take the vehicle through an automatic car wash with guide rails. The compact spare can get caught on the rails which can damage the tire, wheel, and other parts of the vehicle.

## 10-78 Vehicle Care

Do not use the compact spare on other vehicles.

Do not mix the compact spare tire or wheel with other wheels or tires. They will not fit. Keep the spare tire and its wheel together.

### Caution

Tire chains will not fit the compact spare. Using them can damage the vehicle and the chains. Do not use tire chains on the compact spare.

## Jump Starting

For more information about the vehicle battery, see *Battery on page 10-21*.

If the vehicle battery has run down, you may want to use another vehicle and some jumper cables to start your vehicle. Be sure to use the following steps to do it safely.

### Warning

Batteries can hurt you. They can be dangerous because:

- They contain acid that can burn you.
- They contain gas that can explode or ignite.
- They contain enough electricity to burn you.

If you do not follow these steps exactly, some or all of these things can hurt you.

### Caution

Ignoring these steps could result in costly damage to the vehicle that would not be covered by the vehicle warranty. Trying to start the vehicle by pushing or pulling it will not work, and it could damage the vehicle.

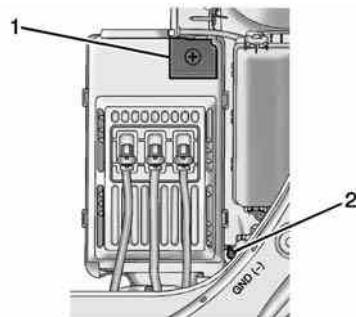

1. Remote Positive (+) Terminal
2. Remote Negative (-) Terminal

Your vehicle is equipped with a remote positive (+) terminal (1) and a remote negative (-) terminal (2). The remote positive (+) terminal is located in the engine compartment on the driver side of the vehicle, above the rear of the battery. The remote negative (-) terminal is a stud located in the engine compartment on the driver side of the vehicle, on the front tie bar. See *Engine Compartment Overview on page 10-5*.

To uncover the remote positive (+) terminal, lift open the access panel on the battery cover indicated by the (+) sign.

1. Check the other vehicle. It must have a 12-volt battery with a negative ground system.

 **Caution**

If the other vehicle does not have a 12-volt system with a negative ground, both vehicles can be

(Continued)

**Caution (Continued)**

damaged. Only use a vehicle that has a 12-volt system with a negative ground for jump starting.

2. Get the vehicles close enough so the jumper cables can reach, but be sure the vehicles are not touching each other. If they are, it could cause a ground connection you do not want. You would not be able to start your vehicle, and the bad grounding could damage the electrical systems.

To avoid the possibility of the vehicles rolling, set the parking brake firmly on both vehicles involved in the jump start procedure. Put the transmission in P (Park) before setting the parking brake.

 **Caution**

If any accessories are left on or plugged in during the jump starting procedure, they could be damaged. The repairs would not be covered by the vehicle warranty. Whenever possible, turn off or unplug all accessories on either vehicle when jump starting.

3. Turn off the ignition on both vehicles. Unplug unnecessary accessories plugged into the cigarette lighter or the accessory power outlet. Turn off the radio and all lamps that are not needed. This will avoid sparks, helping save both batteries and the radio.

4. Open the hood on the other vehicle and locate the positive (+) and negative (-) terminal locations on that vehicle.

Open the hood on your vehicle and find the remote positive (+) and remote negative (-) jump starting terminals.

 **Warning**

An electric fan can start up even when the engine is not running and can injure you. Keep hands, clothing and tools away from any underhood electric fan.

 **Warning**

Using a match near a battery can cause battery gas to explode. People have been hurt doing this,  
(Continued)

**Warning (Continued)**

and some have been blinded. Use a flashlight if you need more light.

Battery fluid contains acid that can burn you. Do not get it on you. If you accidentally get it in your eyes or on your skin, flush the place with water and get medical help immediately.

 **Warning**

Fans or other moving engine parts can injure you badly. Keep your hands away from moving parts once the engine is running.

5. Check that the jumper cables do not have loose or missing insulation. If they do, you could get a shock. The vehicles could also be damaged.

Before you connect the cables, here are some basic things you should know. Positive (+) will go to positive (+) or to a remote positive (+) terminal if the vehicle has one. Negative (-) will go to a heavy, unpainted metal engine part or to a remote negative (-) terminal if the vehicle has one.

Do not connect positive (+) to negative (-) or you will get a short that would damage the battery and maybe other parts. Do not connect the negative (-) cable to the negative (-) terminal on the dead battery because this can cause sparks.

6. Connect the red positive (+) cable to the positive (+) terminal on the vehicle with the dead battery. Use a remote positive (+) terminal if the vehicle has one.
7. Do not let the other end touch metal. Connect it to the positive (+) terminal of the good battery. Use a remote positive (+) terminal if the vehicle has one.
8. Now connect the black negative (-) cable to the negative (-) terminal of the good battery. Use a remote negative (-) terminal if the vehicle has one.

Do not let the other end touch anything until the next step. The other end of the negative (-) cable does not go to the dead battery. It goes to a heavy, unpainted metal engine part or to a remote negative (-) terminal on the vehicle with the dead battery.

9. Connect the other end of the negative (-) cable away from the dead battery, but not near engine parts that move. The electrical connection is just as good there, and the chance of sparks getting back to the battery is much less.  
  
Your vehicle has a remote (-) terminal for this purpose.
10. Now start the vehicle with the good battery and run the engine for a while.
11. Try to start the vehicle that had the dead battery. If it will not start after a few tries, it probably needs service.

 **Caution**

If the jumper cables are connected or removed in the wrong order, electrical shorting may occur and damage the vehicle. The repairs would not be covered by the vehicle warranty. Always connect and remove the jumper cables in the correct order, making sure that the cables do not touch each other or other metal.

**Jumper Cable Removal**

Reverse the sequence exactly when removing the jumper cables.

## Towing the Vehicle

 **Caution**

Incorrectly towing a disabled vehicle may cause damage. The damage would not be covered by the vehicle warranty.

Have the vehicle towed on a flatbed car carrier. A wheel lift tow truck could damage the vehicle.

Consult your dealer or a professional towing service if the disabled vehicle must be towed.

## Recreational Vehicle Towing

Recreational vehicle towing means towing the vehicle behind another vehicle, such as behind a motor home. The two most common types of recreational vehicle towing are known as dinghy towing and dolly towing. Dinghy towing is towing the vehicle with all four wheels on the

ground. Dolly towing is towing the vehicle with two wheels on the ground and two wheels up on a device known as a dolly.

Here are some important things to consider before recreational vehicle towing:

- The towing capacity of the towing vehicle. Be sure to read the tow vehicle manufacturer's recommendations.
- How far the vehicle will be towed. Some vehicles have restrictions on how far and how long they can tow.
- The proper towing equipment. See your dealer or trailering professional for additional advice and equipment recommendations.
- If the vehicle is ready to be towed. Just as preparing the vehicle for a long trip, make sure the vehicle is prepared to be towed.

## Dinghy Towing

Front-wheel-drive and all-wheel-drive vehicles may be dinghy towed from the front. These vehicles can also be towed by placing them on a platform trailer with all four wheels off of the ground. For other towing options, see the information on dolly towing that follows.

 **Caution**

If 105 km/h (65 mph) is exceeded while towing the vehicle, it could be damaged. Never exceed 105 km/h (65 mph) while towing the vehicle.

For vehicles being dinghy towed, the vehicle should be run at the beginning of each day and at each RV fuel stop for about five minutes. This will ensure proper lubrication of transmission components.

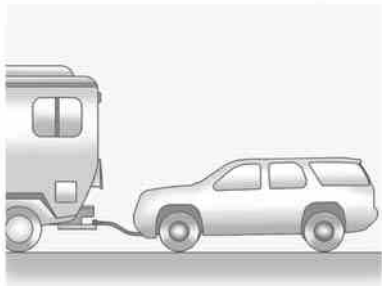

To tow the vehicle from the front with all four wheels on the ground:

1. Position the vehicle that will be towed and secure it to the towing vehicle.

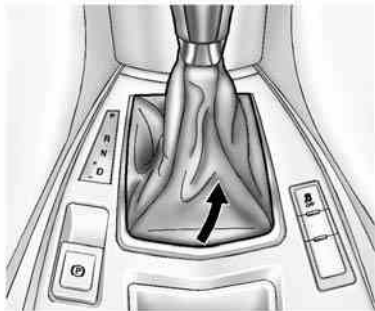

2. Remove the shift lever boot by pulling up on the rear of the trim plate.

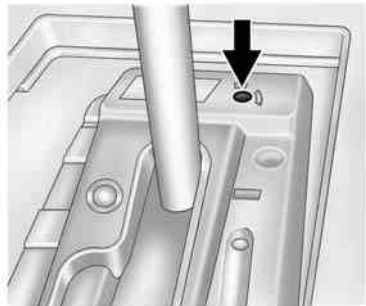

3. Use a small screwdriver or tool to press and hold the manual release button on the front right.
4. Put the vehicle in N (Neutral).

**⚠ Caution**

If the vehicle is towed without performing each of the steps listed under “Dinghy Towing,” the automatic transmission could be damaged. Be sure to follow all steps of the dinghy towing procedure prior to and after towing the vehicle.



## 10-84 Vehicle Care

Once the destination has been reached:

1. Shift the vehicle to P (Park).
2. Reinstall the shift lever boot by inserting the front edge and pressing the rear of the trim plate until it snaps into place.
3. Start the engine and let it idle for more than three minutes before driving the vehicle.

### Caution

Too much or too little fluid can damage the transmission. Be sure that the transmission fluid is at the proper level before towing with all four wheels on the ground.

### Caution

Do not tow a vehicle with the front drive wheels on the ground if one of the front tires is a compact spare tire. Towing with two different tire sizes on the front of the vehicle can cause severe damage to the transmission.

### Dolly Towing (All-Wheel-Drive Vehicles)

All-wheel-drive vehicles should not be towed with two wheels on the ground. To properly tow these vehicles, they should be placed on a platform trailer with all four wheels off of the ground or dinghy towed from the front. See "Dinghy Towing" earlier in this section.

### Dolly Towing (Front-Wheel-Drive Vehicles)



To tow the vehicle from the front with the rear wheels on the ground:

1. Put the front wheels on a dolly.
2. Move the shift lever to P (Park). See *Shifting Into Park* on page 9-19.
3. Set the parking brake.
4. Secure the vehicle to the dolly.
5. Follow the dolly manufacturer's instructions for preparing the vehicle and dolly for towing.

6. Release the parking brake.

### Towing the Vehicle from the Rear

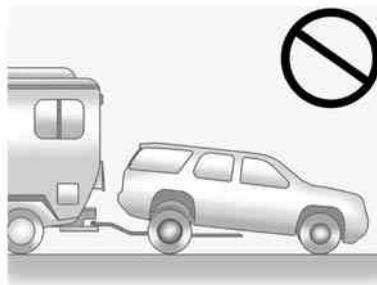
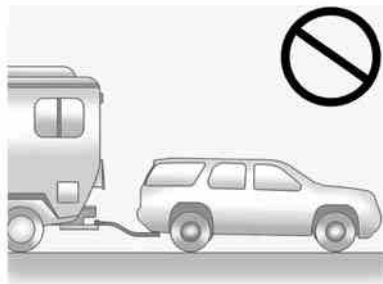

#### **Caution**

Towing the vehicle from the rear could damage it. Also, repairs would not be covered by the vehicle warranty. Never have the vehicle towed from the rear.

## Appearance Care

### Exterior Care

#### Locks

Locks are lubricated at the factory. Use a de-icing agent only when absolutely necessary, and have the locks greased after using. See *Recommended Fluids and Lubricants* on page 11-12.

#### Washing the Vehicle

To preserve the vehicle's finish, wash it often and out of direct sunlight.

#### **Caution**

Do not use petroleum-based, acidic, or abrasive cleaning agents as they can damage the vehicle's paint, metal, or plastic parts. If damage occurs, it would not be covered by the vehicle warranty. Approved cleaning

(Continued)

**Caution (Continued)**

products can be obtained from your dealer. Follow all manufacturer directions regarding correct product usage, necessary safety precautions, and appropriate disposal of any vehicle care product.

 **Caution**

Avoid using high-pressure washes closer than 30 cm (12 in) to the surface of the vehicle. Use of power washers exceeding 8,274 kPa (1,200 psi) can result in damage or removal of paint and decals.

The  symbol is on any underhood compartment electrical center that should not be power

washed. This could cause damage that would not be covered by the vehicle warranty.

If using an automatic car wash, follow the car wash instructions. The windshield wiper and rear window wiper, if equipped, must be off. Remove any accessories that may be damaged or interfere with the car wash equipment.

Rinse the vehicle well, before washing and after, to remove all cleaning agents completely. If they are allowed to dry on the surface, they could stain.

Dry the finish with a soft, clean chamois or an all-cotton towel to avoid surface scratches and water spotting.

**Finish Care**

Application of aftermarket clearcoat sealant/wax materials is not recommended. If painted surfaces are damaged, see your dealer to have the damage assessed and repaired. Foreign materials such as

calcium chloride and other salts, ice melting agents, road oil and tar, tree sap, bird droppings, chemicals from industrial chimneys, etc., can damage the vehicle's finish if they remain on painted surfaces. Wash the vehicle as soon as possible. If necessary, use non-abrasive cleaners that are marked safe for painted surfaces to remove foreign matter.

Occasional hand waxing or mild polishing should be done to remove residue from the paint finish. See your dealer for approved cleaning products.

Do not apply waxes or polishes to uncoated plastic, vinyl, rubber, decals, simulated wood, or flat paint as damage can occur.

 **Caution**

Machine compounding or aggressive polishing on a basecoat/clearcoat paint finish

(Continued)

**Caution (Continued)**

may damage it. Use only non-abrasive waxes and polishes that are made for a basecoat/clearcoat paint finish on the vehicle.

To keep the paint finish looking new, keep the vehicle garaged or covered whenever possible.

**Protecting Exterior Bright Metal Moldings**

 **Caution**

Failure to clean and protect the bright metal moldings can result in a hazy white finish or pitting. This damage would not be covered by the vehicle warranty.

The bright metal moldings on the vehicle are aluminum or stainless steel. To prevent damage always follow these cleaning instructions:

- Be sure the molding is cool to the touch before applying any cleaning solution.
- Use a cleaning solution approved for aluminum or stainless steel. Some cleaners are highly acidic or contain alkaline substances and can damage the moldings.
- Always dilute a concentrated cleaner according to the manufacturer's instructions.
- Do not use chrome cleaners.
- Do not use cleaners that are not intended for automotive use.
- Use a nonabrasive wax on the vehicle after washing to protect and extend the molding finish.

**Cleaning Exterior Lamps/ Lenses, Emblems, Decals and Stripes**

Use only lukewarm or cold water, a soft cloth, and a car washing soap to clean exterior lamps, lenses, emblems, decals and stripes. Follow instructions under "Washing the Vehicle" previously in this section.

Lamp covers are made of plastic, and some have a UV protective coating. Do not clean or wipe them when dry.

Do not use any of the following on lamp covers:

- Abrasive or caustic agents.
- Washer fluids and other cleaning agents in higher concentrations than suggested by the manufacturer.
- Solvents, alcohols, fuels, or other harsh cleaners.
- Ice scrapers or other hard items.

## 10-88 Vehicle Care

- Aftermarket appearance caps or covers while the lamps are illuminated, due to excessive heat generated.

### **Caution**

Failure to clean lamps properly can cause damage to the lamp cover that would not be covered by the vehicle warranty.

### **Caution**

Using wax on low gloss black finish stripes can increase the gloss level and create a non-uniform finish. Clean low gloss stripes with soap and water only.

### **Air Intakes**

Clear debris from the air intakes, between the hood and windshield when washing the vehicle.

### **Windshield and Wiper Blades**

Clean the outside of the windshield with glass cleaner.

Clean rubber blades using a lint-free cloth or paper towel soaked with windshield washer fluid or a mild detergent. Wash the windshield thoroughly when cleaning the blades. Bugs, road grime, sap, and a buildup of vehicle wash/wax treatments may cause wiper streaking.

Replace the wiper blades if they are worn or damaged. Damage can be caused by extreme dusty conditions, sand, salt, heat, sun, snow, and ice.

### **Weatherstrips**

Apply Dielectric silicone grease on weatherstrips to make them last longer, seal better, and not stick or squeak. Lubricate weatherstrips at least once a year. Hot, dry climates may require more frequent application. Black marks from rubber material on painted surfaces

can be removed by rubbing with a clean cloth. See *Recommended Fluids and Lubricants on page 11-12*.

### **Tires**

Use a stiff brush with tire cleaner to clean the tires.

### **Caution**

Using petroleum-based tire dressing products on the vehicle may damage the paint finish and/or tires. When applying a tire dressing, always wipe off any overspray from all painted surfaces on the vehicle.

### **Wheels and Trim — Aluminum or Chrome**

Use a soft, clean cloth with mild soap and water to clean the wheels. After rinsing thoroughly with clean water, dry with a soft, clean towel. A wax may then be applied.

 **Caution**

Chrome wheels and other chrome trim may be damaged if the vehicle is not washed after driving on roads that have been sprayed with magnesium, calcium, or sodium chloride. These chlorides are used on roads for conditions such as ice and dust. Always wash the chrome with soap and water after exposure.

 **Caution**

To avoid surface damage, do not use strong soaps, chemicals, abrasive polishes, cleaners, brushes, or cleaners that contain acid on aluminum or chrome-plated wheels. Use only approved cleaners. Also, never drive a vehicle with aluminum or chrome-plated wheels through an  
(Continued)

**Caution (Continued)**

automatic car wash that uses silicone carbide tire cleaning brushes. Damage could occur and the repairs would not be covered by the vehicle warranty.

**Steering, Suspension, and Chassis Components**

Visually inspect steering, suspension, and chassis components for damaged, loose, or missing parts or signs of wear at least once a year.

Inspect power steering for proper hook-up, binding, leaks, cracks, chafing, etc.

Visually check constant velocity joint boots and axle seals for leaks.

**Body Component Lubrication**

Lubricate all key lock cylinders, hood hinges, liftgate hinges, steel fuel door hinge, unless the components are plastic. Applying

silicone grease on weatherstrips with a clean cloth will make them last longer, seal better, and not stick or squeak.

**Underbody Maintenance**

At least twice a year, spring and fall use plain water to flush any corrosive materials from the underbody. Take care to thoroughly clean any areas where mud and other debris can collect.

**Sheet Metal Damage**

If the vehicle is damaged and requires sheet metal repair or replacement, make sure the body repair shop applies anti-corrosion material to parts repaired or replaced to restore corrosion protection.

Original manufacturer replacement parts will provide the corrosion protection while maintaining the vehicle warranty.

### Finish Damage

Quickly repair minor chips and scratches with touch-up materials available from your dealer to avoid corrosion. Larger areas of finish damage can be corrected in your dealer's body and paint shop.

### Chemical Paint Spotting

Airborne pollutants can fall upon and attack painted vehicle surfaces causing blotchy, ring-shaped discolorations, and small, irregular dark spots etched into the paint surface. See "Finish Care" previously in this section.

### Interior Care

To prevent dirt particle abrasions, regularly clean the vehicle's interior. Immediately remove any soils. Note that newspapers or dark garments that can transfer color to home furnishings can also permanently transfer color to the vehicle's interior.

Use a soft bristle brush to remove dust from knobs and crevices on the instrument cluster. Using a mild soap solution, immediately remove hand lotions, sunscreen, and insect repellent from all interior surfaces or permanent damage may result.

Your dealer may have products for cleaning the interior. Use cleaners specifically designed for the surfaces being cleaned to prevent permanent damage. Apply all cleaners directly to the cleaning cloth. Do not spray cleaners directly on any switches or controls. Cleaners should be removed quickly. Never allow cleaners to remain on the surface being cleaned for extended periods of time.

Cleaners may contain solvents that can become concentrated in the interior. Before using cleaners, read and adhere to all safety instructions on the label. While cleaning the interior, maintain adequate ventilation by opening the doors and windows.

To prevent damage, do not clean the interior using the following cleaners or techniques:

- Never use a razor or any other sharp object to remove a soil from any interior surface.
- Never use a brush with stiff bristles.
- Never rub any surface aggressively or with excessive pressure.
- Do not use laundry detergents or dishwashing soaps with degreasers. For liquid cleaners, use approximately 20 drops per 3.8 L (1 gal) of water. A concentrated soap solution will leave a residue that creates streaks and attracts dirt. Do not use solutions that contain strong or caustic soap.
- Do not heavily saturate the upholstery when cleaning.
- Do not use solvents or cleaners containing solvents.

### Interior Glass

To clean, use a terry cloth fabric dampened with water. Wipe droplets left behind with a clean dry cloth. Commercial glass cleaners may be used, if necessary, after cleaning the interior glass with plain water.

 <b>Caution</b>
--

<p>To prevent scratching, never use abrasive cleaners on automotive glass. Abrasive cleaners or aggressive cleaning may damage the rear window defogger.</p>
--

Cleaning the windshield with water during the first three to six months of ownership will reduce tendency to fog.

### Speaker Covers

Vacuum around a speaker cover gently, so that the speaker will not be damaged. Clean spots with just water and mild soap.

### Coated Moldings

Coated moldings should be cleaned.

- When lightly soiled, wipe with a sponge or soft lint-free cloth dampened with water.
- When heavily soiled, use warm soapy water.

### Fabric/Carpet/Suede

Start by vacuuming the surface using a soft brush attachment. If a rotating brush attachment is being used during vacuuming, only use it on the floor carpet. Before cleaning, gently remove as much of the soil as possible using one of the following techniques:

- Gently blot liquids with a paper towel. Continue blotting until no more soil can be removed.
- For solid soils, remove as much as possible prior to vacuuming.

To clean:

1. Saturate a clean lint-free colorfast cloth with water. Microfiber cloth is recommended to prevent lint transfer to the fabric or carpet.
2. Remove excess moisture by gently wringing until water does not drip from the cleaning cloth.
3. Start on the outside edge of the soil and gently rub toward the center. Fold the cleaning cloth to a clean area frequently to prevent forcing the soil in to the fabric.
4. Continue gently rubbing the soiled area until there is no longer any color transfer from the soil to the cleaning cloth.
5. If the soil is not completely removed, use a mild soap solution followed only by plain water.

If the soil is not completely removed, it may be necessary to use a commercial upholstery



cleaner or spot lifter. Test a small hidden area for colorfastness before using a commercial upholstery cleaner or spot lifter. If ring formation occurs, clean the entire fabric or carpet.

Following the cleaning process, a paper towel can be used to blot excess moisture.

### **Cleaning High Gloss Surfaces and Vehicle Information and Radio Displays**

For vehicles with high gloss surfaces or vehicle displays, use a microfiber cloth to wipe surfaces. Before wiping the surface with the microfiber cloth, use a soft bristle brush to remove dirt that could scratch the surface. Then use the microfiber cloth by gently rubbing to clean. Never use window cleaners or solvents. Periodically hand wash the microfiber cloth separately, using mild soap. Do not use bleach or fabric softener. Rinse thoroughly and air dry before next use.

#### **Caution**

Do not attach a device with a suction cup to the display. This may cause damage and would not be covered by the vehicle warranty.

### **Instrument Panel, Leather, Vinyl, Other Plastic Surfaces, Low Gloss Paint Surfaces and Natural Open Pore Wood Surfaces**

Use a soft microfiber cloth dampened with water to remove dust and loose dirt. For a more thorough cleaning, use a soft microfiber cloth dampened with a mild soap solution.

#### **Caution**

Soaking or saturating leather, especially perforated leather, as well as other interior surfaces, may cause permanent damage. Wipe excess moisture from these surfaces after cleaning and allow them to dry naturally. Never use heat, steam, or spot removers. Do not use cleaners that contain silicone or wax-based products. Cleaners containing these solvents can permanently change the appearance and feel of leather or soft trim, and are not recommended.

Do not use cleaners that increase gloss, especially on the instrument panel. Reflected glare can decrease visibility through the windshield under certain conditions.

 **Caution**

Use of air fresheners may cause permanent damage to plastics and painted surfaces. If an air freshener comes in contact with any plastic or painted surface in the vehicle, blot immediately and clean with a soft cloth dampened with a mild soap solution. Damage caused by air fresheners would not be covered by the vehicle warranty.

**Cargo Cover and Convenience Net**

Wash with warm water and mild detergent. Do not use chlorine bleach. Rinse with cold water, and then dry completely.

**Care of Safety Belts**

Keep belts clean and dry.

 **Warning**

Do not bleach or dye safety belts. It may severely weaken them. In a crash, they might not be able to provide adequate protection. Clean safety belts only with mild soap and lukewarm water.

**Floor Mats**

 **Warning**

If a floor mat is the wrong size or is not properly installed, it can interfere with the pedals. Interference with the pedals can cause unintended acceleration and/or increased stopping distance which can cause a crash and injury. Make sure the floor mat does not interfere with the pedals.

Use the following guidelines for proper floor mat usage.

- The original equipment floor mats were designed for your vehicle. If the floor mats need replacing, it is recommended that certified floor mats be purchased. Non-certified floor mats may not fit properly and may interfere with the pedals. Always check that the floor mats do not interfere with the pedals.
- Do not use a floor mat if the vehicle is not equipped with a floor mat retainer on the driver side floor.
- Use the floor mat with the correct side up. Do not turn it over.
- Do not place anything on top of the driver side floor mat.
- Use only a single floor mat on the driver side.
- Do not place one floor mat on top of another.

### Removing and Replacing the Floor Mats

The driver side floor mat is held in place by two button-type retainers. The passenger side floor mat is held in place by one button-type retainer.



1. Pull up on the rear of the floor mat to unlock each retainer and remove.

2. Reinstall by lining up the floor mat retainer openings over the carpet retainers and snapping into position.
3. Make sure the floor mat is properly secured and verify that it does not interfere with the pedals.

# Service and Maintenance

## General Information

General Information ..... 11-1

## Cadillac Premium Care Maintenance

Cadillac Premium Care Maintenance ..... 11-3

## Maintenance Schedule

Maintenance Schedule ..... 11-3

## Special Application Services

Special Application Services ..... 11-9

## Additional Maintenance and Care

Additional Maintenance and Care ..... 11-9

## Recommended Fluids, Lubricants, and Parts

Recommended Fluids and Lubricants ..... 11-12  
Maintenance Replacement Parts ..... 11-13

## Maintenance Records

Maintenance Records ..... 11-14

## General Information

Your vehicle is an important investment. This section describes the required maintenance for the vehicle. Follow this schedule to help protect against major repair expenses resulting from neglect or inadequate maintenance. It may also help to maintain the value of the vehicle if it is sold. It is the responsibility of the owner to have all required maintenance performed.

Your dealer has trained technicians who can perform required maintenance using genuine replacement parts. They have up-to-date tools and equipment for fast and accurate diagnostics. Many dealers have extended evening and Saturday hours, courtesy transportation, and online scheduling to assist with service needs.

Your dealer recognizes the importance of providing competitively priced maintenance and repair services. With trained

## 11-2 Service and Maintenance

technicians, the dealer is the place for routine maintenance such as oil changes and tire rotations and additional maintenance items like tires, brakes, batteries, and wiper blades.

### Caution

Damage caused by improper maintenance can lead to costly repairs and may not be covered by the vehicle warranty. Maintenance intervals, checks, inspections, recommended fluids, and lubricants are important to keep the vehicle in good working condition.

The Tire Rotation and Required Services are the responsibility of the vehicle owner. It is recommended to have your dealer perform these services every 12 000 km/7,500 mi. Proper vehicle maintenance helps to keep the vehicle in good working condition, improves fuel economy, and reduces vehicle emissions.

Because of the way people use vehicles, maintenance needs vary. There may need to be more frequent checks and services. The Additional Required Services - Normal are for vehicles that:

- Carry passengers and cargo within recommended limits on the Tire and Loading Information label. See *Vehicle Load Limits on page 9-9*.
- Are driven on reasonable road surfaces within legal driving limits.
- Use the recommended fuel. See *Fuel on page 9-56*.

Refer to the information in the Maintenance Schedule Additional Required Services - Normal chart.

The Additional Required Services - Severe are for vehicles that are:

- Mainly driven in heavy city traffic in hot weather.
- Mainly driven in hilly or mountainous terrain.

- Frequently towing a trailer.
- Used for high speed or competitive driving.
- Used for taxi, police, or delivery service.

Refer to the information in the Maintenance Schedule Additional Required Services - Severe chart.

### Warning

Performing maintenance work can be dangerous and can cause serious injury. Perform maintenance work only if the required information, proper tools, and equipment are available. If they are not, see your dealer to have a trained technician do the work. See *Doing Your Own Service Work on page 10-3*.

## Cadillac Premium Care Maintenance

Your vehicle comes with the Cadillac Premium Care Maintenance. It is a maintenance program that covers select maintenance services during the first 4 years or 80 000 km (50,000 mi), whichever comes first.

Cadillac Premium Care Maintenance covers routine maintenance services, when scheduled in accordance with the owner manual, including:

- Oil changes based on the vehicle's oil life monitor system.

- Tire rotation every 12 000 km (7,500 mi).
- Engine air cleaner filter replacement.
- Passenger compartment air filter replacement.
- Multi-point vehicle inspection (MPVI) performed by a qualified technician.

Cadillac requires that all Cadillac Premium Care Maintenance services be performed by a Cadillac authorized service dealer.

## Maintenance Schedule

### Owner Checks and Services

#### At Each Fuel Stop

- Check the engine oil level. See *Engine Oil on page 10-7*.

#### Once a Month

- Check the tire inflation pressures. See *Tire Pressure on page 10-48*.
- Inspect the tires for wear. See *Tire Inspection on page 10-54*.
- Check the windshield washer fluid level. See *Washer Fluid on page 10-18*.

### Engine Oil Change

When the CHANGE ENGINE OIL SOON message displays, have the engine oil and filter changed within the next 1 000 km/600 mi. If driven under the best conditions, the engine oil life system may not indicate the need for vehicle service

## 11-4 Service and Maintenance

---

for up to a year. The engine oil and filter must be changed at least once a year and the oil life system must be reset. Your trained dealer technician can perform this work. If the engine oil life system is reset accidentally, service the vehicle within 5 000 km/3,000 mi since the last service. Reset the oil life system when the oil is changed. See *Engine Oil Life System* on page 10-9.

### **Tire Rotation and Required Services Every 12 000 km/ 7,500 mi**

Rotate the tires, if recommended for the vehicle, and perform the following services. See *Tire Rotation* on page 10-55.

- Check engine oil level and oil life percentage. If needed, change engine oil and filter, and reset oil life system. See *Engine Oil* on page 10-7 and *Engine Oil Life System* on page 10-9.

- Check engine coolant level. See *Engine Coolant* on page 10-13.
- Check windshield washer fluid level. See *Washer Fluid* on page 10-18.
- Visually inspect windshield wiper blades for wear, cracking, or contamination. See *Exterior Care* on page 10-85. Replace worn or damaged wiper blades. See *Wiper Blade Replacement* on page 10-23.
- Check tire inflation pressures. See *Tire Pressure* on page 10-48.
- Inspect tire wear. See *Tire Inspection* on page 10-54.
- Visually check for fluid leaks.
- Inspect engine air cleaner filter. See *Engine Air Cleaner/Filter* on page 10-10.
- Inspect brake system.
- Visually inspect steering, suspension, and chassis components for damaged, loose,

or missing parts or signs of wear. See *Exterior Care* on page 10-85.

- Check restraint system components. See *Safety System Check* on page 3-19.
- Visually inspect fuel system for damage or leaks.
- Visually inspect exhaust system and nearby heat shields for loose or damaged parts.
- Lubricate body components. See *Exterior Care* on page 10-85.
- Check starter switch. See *Starter Switch Check* on page 10-22.
- Check automatic transmission shift lock control function. See *Automatic Transmission Shift Lock Control Function Check* on page 10-23.
- Check parking brake and automatic transmission park mechanism. See *Park Brake and P (Park) Mechanism Check* on page 10-23.

- Check accelerator pedal for damage, high effort, or binding. Replace if needed.
- Visually inspect gas strut for signs of wear, cracks, or other damage. Check the hold open ability of the strut. See your dealer if service is required.
- Check tire sealant expiration date, if equipped. See *Tire Sealant and Compressor Kit on page 10-63*.
- Inspect sunroof track and seal, if equipped. See *Sunroof on page 2-26*.



## 11-6 Service and Maintenance

Maintenance Schedule Additional Required Services - Normal	12 000 km/7,500 mi	24 000 km/15,000 mi	36 000 km/22,500 mi	48 000 km/30,000 mi	60 000 km/37,500 mi	72 000 km/45,000 mi	84 000 km/52,500 mi	96 000 km/60,000 mi	108 000 km/67,500 mi	120 000 km/75,000 mi	132 000 km/82,500 mi	144 000 km/90,000 mi	156 000 km/97,500 mi	168 000 km/105,000 mi	180 000 km/112,500 mi	192 000 km/120,000 mi	204 000 km/127,500 mi	216 000 km/135,000 mi	228 000 km/142,500 mi	240 000 km/150,000 mi
	Rotate tires and perform Required Services. Check engine oil level and oil life percentage. Change engine oil and filter, if needed.	✓	✓	✓	✓	✓	✓	✓	✓	✓	✓	✓	✓	✓	✓	✓	✓	✓	✓	✓
Replace passenger compartment air filter. (1)			✓			✓			✓			✓			✓			✓		
Inspect evaporative control system. (2)						✓						✓							✓	
Replace engine air cleaner filter. (3)						✓						✓							✓	
Replace spark plugs. Inspect spark plug wires.													✓							
Drain and fill engine cooling system. (4)																				✓
Visually inspect accessory drive belts. (5)																				✓
Replace brake fluid. (6)						✓						✓						✓		

**Footnotes — Maintenance  
Schedule Additional Required  
Services - Normal**

(1) Or every two years, whichever comes first. More frequent replacement may be needed if the vehicle is driven in areas with heavy traffic, areas with poor air quality, or areas with high dust levels. Replacement may also be needed if there is a reduction in air flow, excessive window fogging, or odors.

(2) Check all fuel and vapor lines and hoses for proper hook-up, routing, and condition.

(3) Or every four years, whichever comes first.

(4) Or every five years, whichever comes first. See *Cooling System on page 10-12*.

(5) Or every 10 years, whichever comes first. Inspect for fraying, excessive cracking, or damage; replace, if needed.

(6) Or every three years, whichever comes first.

## 11-8 Service and Maintenance

Maintenance Schedule Additional Required Services - Severe	12 000 km/7,500 mi	24 000 km/15,000 mi	36 000 km/22,500 mi	48 000 km/30,000 mi	60 000 km/37,500 mi	72 000 km/45,000 mi	84 000 km/52,500 mi	96 000 km/60,000 mi	108 000 km/67,500 mi	120 000 km/75,000 mi	132 000 km/82,500 mi	144 000 km/90,000 mi	156 000 km/97,500 mi	168 000 km/105,000 mi	180 000 km/112,500 mi	192 000 km/120,000 mi	204 000 km/127,500 mi	216 000 km/135,000 mi	228 000 km/142,500 mi	240 000 km/150,000 mi
	Rotate tires and perform Required Services. Check engine oil level and oil life percentage. Change engine oil and filter, if needed.	✓	✓	✓	✓	✓	✓	✓	✓	✓	✓	✓	✓	✓	✓	✓	✓	✓	✓	✓
Replace passenger compartment air filter. (1)			✓			✓			✓			✓			✓			✓		
Inspect evaporative control system. (2)						✓						✓							✓	
Replace engine air cleaner filter. (3)						✓						✓							✓	
Change automatic transmission fluid.						✓						✓							✓	
Replace spark plugs. Inspect spark plug wires.													✓							
Drain and fill engine cooling system. (4)																				✓
Visually inspect accessory drive belts. (5)																				✓
Replace brake fluid. (6)						✓						✓						✓		

### Footnotes — Maintenance Schedule Additional Required Services - Severe

(1) Or every two years, whichever comes first. More frequent replacement may be needed if the vehicle is driven in areas with heavy traffic, areas with poor air quality, or areas with high dust levels. Replacement may also be needed if there is a reduction in air flow, excessive window fogging, or odors.

(2) Check all fuel and vapor lines and hoses for proper hook-up, routing, and condition.

(3) Or every four years, whichever comes first.

(4) Or every five years, whichever comes first. See *Cooling System* on page 10-12.

(5) Or every 10 years, whichever comes first. Inspect for fraying, excessive cracking, or damage; replace, if needed.

(6) Or every three years, whichever comes first.

### Special Application Services

- Severe Commercial Use Vehicles Only: Lubricate chassis components every 5 000 km/ 3,000 mi.
- Have underbody flushing service performed. See "Underbody Maintenance" in *Exterior Care* on page 10-85.

### Additional Maintenance and Care

Your vehicle is an important investment and caring for it properly may help to avoid future costly repairs. To maintain vehicle performance, additional maintenance services may be required.

It is recommended that your dealer perform these services — their trained dealer technicians know your vehicle best. Your dealer can also perform a thorough assessment with a multi-point inspection to recommend when your vehicle may need attention.

The following list is intended to explain the services and conditions to look for that may indicate services are required.

#### Battery

The battery supplies power to start the engine and operate any additional electrical accessories.

## 11-10 Service and Maintenance

---

- To avoid break-down or failure to start the vehicle, maintain a battery with full cranking power.
- Trained dealer technicians have the diagnostic equipment to test the battery and ensure that the connections and cables are corrosion-free.

### Belts

- Belts may need replacing if they squeak or show signs of cracking or splitting.
- Trained dealer technicians have access to tools and equipment to inspect the belts and recommend adjustment or replacement when necessary.

### Brakes

Brakes stop the vehicle and are crucial to safe driving.

- Signs of brake wear may include chirping, grinding, or squealing noises, or difficulty stopping.

- Trained dealer technicians have access to tools and equipment to inspect the brakes and recommend quality parts engineered for the vehicle.

### Fluids

Proper fluid levels and approved fluids protect the vehicle's systems and components. See *Recommended Fluids and Lubricants on page 11-12* for GM approved fluids.

- Engine oil and windshield washer fluid levels should be checked at every fuel fill.
- Instrument cluster lights may come on to indicate that fluids may be low and need to be filled.

### Hoses

Hoses transport fluids and should be regularly inspected to ensure that there are no cracks or leaks. With a multi-point inspection, your dealer can inspect the hoses and advise if replacement is needed.

### Lamps

Properly working headlamps, taillamps, and brake lamps are important to see and be seen on the road.

- Signs that the headlamps need attention include dimming, failure to light, cracking, or damage. The brake lamps need to be checked periodically to ensure that they light when braking.
- With a multi-point inspection, your dealer can check the lamps and note any concerns.

### Shocks and Struts

Shocks and struts help aid in control for a smoother ride.

- Signs of wear may include steering wheel vibration, bounce/sway while braking, longer stopping distance, or uneven tire wear.
- As part of the multi-point inspection, trained dealer technicians can visually inspect

the shocks and struts for signs of leaking, blown seals, or damage, and can advise when service is needed.

### **Tires**

Tires need to be properly inflated, rotated, and balanced. Maintaining the tires can save money and fuel, and can reduce the risk of tire failure.

- Signs that the tires need to be replaced include three or more visible treadwear indicators; cord or fabric showing through the rubber; cracks or cuts in the tread or sidewall; or a bulge or split in the tire.
- Trained dealer technicians can inspect and recommend the right tires. Your dealer can also provide tire/wheel balancing services to ensure smooth vehicle operation at all speeds. Your dealer sells and services name brand tires.

### **Vehicle Care**

To help keep the vehicle looking like new, vehicle care products are available from your dealer. For information on how to clean and protect the vehicle's interior and exterior, see *Interior Care on page 10-90* and *Exterior Care on page 10-85*.

### **Wheel Alignment**

Wheel alignment is critical for ensuring that the tires deliver optimal wear and performance.

- Signs that the alignment may need to be adjusted include pulling, improper vehicle handling, or unusual tire wear.
- Your dealer has the required equipment to ensure proper wheel alignment.

### **Windshield**

For safety, appearance, and the best viewing, keep the windshield clean and clear.

- Signs of damage include scratches, cracks, and chips.
- Trained dealer technicians can inspect the windshield and recommend proper replacement if needed.

### **Wiper Blades**

Wiper blades need to be cleaned and kept in good condition to provide a clear view.

- Signs of wear include streaking, skipping across the windshield, and worn or split rubber.
- Trained dealer technicians can check the wiper blades and replace them when needed.

## Recommended Fluids, Lubricants, and Parts

### Recommended Fluids and Lubricants

Usage	Fluid/Lubricant
Engine Oil	Use only engine oil meeting the dexos1™ specification of the proper SAE viscosity grade. Look for the dexos1 approved logo for GM approved engine oil. See <i>Engine Oil</i> on page 10-7.
Engine Coolant	50/50 mixture of clean, drinkable water and use only DEX-COOL® Coolant. See <i>Engine Coolant</i> on page 10-13.
Fuel Additive	Fuel System Treatment PLUS (Part No. 88861013).
Hydraulic Brake System	DOT 3 Hydraulic Brake Fluid (GM Part No. 19299818, in Canada 19299819).
Windshield Washer	Automotive windshield washer fluid that meets regional freeze protection requirements.
Hydraulic Power Steering System	DEXRON®-VI Automatic Transmission Fluid.
Automatic Transmission	DEXRON®-VI Automatic Transmission Fluid.
Transfer Case (All-Wheel Drive)	Transfer Case Fluid (GM Part No. 19256084, in Canada 19256085).
Chassis Lubrication	Chassis Lubricant (GM Part No. 12377985, in Canada 88901242) or lubricant meeting requirements of NLGI #2, Category LB or GC-LB.
Key Lock Cylinders, Hood, and Door Hinges	Multi-Purpose Lubricant, Superlube (GM Part No. 12346241, in Canada 10953474).

Usage	Fluid/Lubricant
Power Liftgate Actuator Ball Joint, Hood Latch Assembly, Secondary Latch, Pivots, Spring Anchor, and Release Pawl	Lubriplate Lubricant Aerosol (GM Part No. 89021668, in Canada 89021674) or lubricant meeting requirements of NLGI #2, Category LB or GC-LB.
Weatherstrip Conditioning	Weatherstrip Lubricant (GM Part No. 3634770, in Canada 10953518) or Dielectric Silicone Grease (GM Part No. 12345579, in Canada 10953481).

## Maintenance Replacement Parts

Replacement parts identified below by name, part number, or specification can be obtained from your dealer.

Part	GM Part Number	ACDelco Part Number
Engine Air Cleaner/Filter	20897358	A3147C
Engine Oil Filter	89017525	PF63
Passenger Compartment Air Filter Element	13271191	CF176
Spark Plugs	12622561	41-109
Wiper Blades		
Driver Side – 65.0 cm (25.6 in)	22870539	—
Passenger Side – 42.5 cm (16.7 in)	22870540	—
Rear – 30.0 cm (11.8 in)	20825882	—





## Technical Data

### Vehicle Identification

Vehicle Identification Number (VIN) .....	12-1
Service Parts Identification Label .....	12-1

### Vehicle Data

Capacities and Specifications .....	12-2
Engine Drive Belt Routing ...	12-4

## Vehicle Identification

### Vehicle Identification Number (VIN)



This legal identifier is in the front corner of the instrument panel, on the left side of the vehicle. It can be seen through the windshield from outside. The VIN also appears on the Vehicle Certification and Service Parts labels and certificates of title and registration.

## Engine Identification

The eighth character in the VIN is the engine code. This code identifies the vehicle's engine, specifications, and replacement parts. See "Engine Specifications" under *Capacities and Specifications* on page 12-2 for the vehicle's engine code.

### Service Parts Identification Label

This label, on the inside of the rear side cargo management cover, has the following information:

- Vehicle Identification Number (VIN).
- Model designation.
- Paint information.
- Production options and special equipment.

Do not remove this label from the vehicle.

## Vehicle Data

### Capacities and Specifications

Application	Capacities	
	Metric	English
Air Conditioning Refrigerant	For the air conditioning system refrigerant type, and charge amount, see the refrigerant label located under the hood. See your dealer for more information.	
Engine Cooling System		
3.6L V6 Engine	12.8 L	13.5 qt
Engine Oil with Filter	5.7 L	6.0 qt
Fuel Tank	79.5 L	21.0 gal
Transfer Case Fluid	0.65 L	0.69 qt
Wheel Nut Torque	190 N•m	140 lb ft
All capacities are approximate. When adding, be sure to fill to the approximate level, as recommended in this manual. Recheck fluid level after filling.		

**Engine Specifications**

<b>Engine</b>	<b>VIN Code</b>	<b>Transmission</b>	<b>Spark Plug Gap</b>
3.6L V6 (LFX)	3	Automatic	0.95–1.10 mm (0.037–0.043 in)

**Engine Drive Belt Routing**

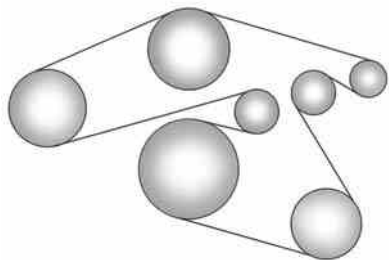

## Customer Information

### Customer Information

Customer Satisfaction Procedure .....	13-1
Customer Assistance Offices .....	13-3
Customer Assistance for Text Telephone (TTY) Users .....	13-4
Online Owner Center .....	13-4
Roadside Service .....	13-5
Scheduling Service	
Appointments .....	13-7
Courtesy Transportation Program .....	13-7
Collision Damage Repair .....	13-8
Service Publications	
Ordering Information .....	13-10
Radio Frequency Identification (RFID) .....	13-11
Radio Frequency Statement .....	13-12

### Reporting Safety Defects

Reporting Safety Defects to the United States Government .....	13-12
Reporting Safety Defects to the Canadian Government .....	13-13
Reporting Safety Defects to General Motors .....	13-13

### Vehicle Data Recording and Privacy

Vehicle Data Recording and Privacy .....	13-13
Event Data Recorders .....	13-14
OnStar® .....	13-15
Infotainment System .....	13-15

## Customer Information

### Customer Satisfaction Procedure

Your satisfaction and goodwill are important to your dealer and to Cadillac. Normally, any concerns with the sales transaction or the operation of the vehicle will be resolved by your dealer's sales or service departments. Sometimes, however, despite the best intentions of all concerned, misunderstandings can occur. If your concern has not been resolved to your satisfaction, the following steps should be taken:

**STEP ONE:** Discuss your concern with a member of dealership management. Normally, concerns can be quickly resolved at that level. If the matter has already been reviewed with the sales, service or parts manager, contact the owner of your dealership or the general manager.

## 13-2 Customer Information

---

**STEP TWO:** If after contacting a member of dealership management, it appears your concern cannot be resolved by your dealership without further help, in the U.S., call the Cadillac Customer Assistance Center at 1-800-458-8006. In Canada, call the Canadian Cadillac Customer Care Centre at 1-888-446-2000.

We encourage you to call the toll-free number in order to give your inquiry prompt attention. Have the following information available to give the Customer Assistance representative:

- Vehicle Identification Number (VIN). This is available from the vehicle registration or title, or the plate at the top left of the instrument panel and visible through the windshield.
- Dealership name and location.
- Vehicle delivery date and present mileage.

When contacting Cadillac, remember that your concern will likely be resolved at a dealer's facility. That is why we suggest following Step One first.

**STEP THREE — U.S. Owners:** Both General Motors and your dealer are committed to making sure you are completely satisfied with the new vehicle. However, if you continue to remain unsatisfied after following the procedure outlined in Steps One and Two, you can file with the Better Business Bureau (BBB) Auto Line® Program to enforce your rights.

The BBB Auto Line Program is an out-of-court program administered by the Council of Better Business Bureaus to settle automotive disputes regarding vehicle repairs or the interpretation of the New Vehicle Limited Warranty. Although you may be required to resort to this informal dispute resolution program prior to filing a court action, use of the program is free of charge and your case will generally be heard within

40 days. If you do not agree with the decision given in your case, you may reject it and proceed with any other venue for relief available to you.

You may contact the BBB Auto Line Program using the toll-free telephone number or write them at the following address:

BBB Auto Line Program  
Council of Better Business Bureaus, Inc.  
4200 Wilson Boulevard  
Suite 800  
Arlington, VA 22203-1838

Telephone: 1-800-955-5100  
[www.dr.bbb.org/goauto](http://www.dr.bbb.org/goauto)

This program is available in all 50 states and the District of Columbia. Eligibility is limited by vehicle age, mileage, and other factors. General Motors reserves the right to change eligibility limitations and/or discontinue its participation in this program.

**STEP THREE — Canadian**

**Owners:** In the event that you do not feel your concerns have been addressed after following the procedure outlined in Steps One and Two, General Motors of Canada Limited wants you to be aware of its participation in a no-charge mediation/arbitration program. General Motors of Canada Limited has committed to binding arbitration of owner disputes involving factory-related vehicle service claims. The program provides for the review of the facts involved by an impartial third party arbiter, and may include an informal hearing before the arbiter. The program is designed so that the entire dispute settlement process, from the time you file your complaint to the final decision, should be completed in approximately 70 days. We believe our impartial program offers advantages over courts in most jurisdictions because it is informal, quick, and free of charge.

For further information concerning eligibility in the Canadian Motor Vehicle Arbitration Plan (CAMVAP), call toll-free 1-800-207-0685, or call the General Motors Customer Care Centre, 1-888-446-2000 (English), 1-800-263-7854 (French), or write to:

Mediation/Arbitration Program  
c/o Customer Care Centre  
General Motors of Canada Limited  
Mail Code: CA1-163-005  
1908 Colonel Sam Drive  
Oshawa, Ontario L1H 8P7

The inquiry should be accompanied by the Vehicle Identification Number (VIN).

**Customer Assistance Offices**

Cadillac encourages customers to call the toll-free number for assistance. However, if a customer wishes to write or e-mail Cadillac, the letter should be addressed to:

**United States and Puerto Rico**

Cadillac Customer Assistance Center  
Cadillac Motor Car Division  
P.O. Box 33169  
Detroit, MI 48232-5169  
[www.Cadillac.com](http://www.Cadillac.com)

1-800-458-8006  
1-800-833-2622 (For Text Telephone devices (TTYs))  
Roadside Service: 1-800-224-1400

From U.S. Virgin Islands:  
1-800-496-9994



## 13-4 Customer Information

---

### Canada

General Motors of Canada Limited  
Canadian Cadillac Customer Care  
Centre, Mail Code: CA1-163-005  
1908 Colonel Sam Drive  
Oshawa, Ontario L1H 8P7  
www.gm.ca

1-888-446-2000 (English)  
1-800-263-7854 (French)  
Roadside Service: 1-800-882-1112

### Overseas

Contact the local General Motors  
Business Unit.

### Customer Assistance for Text Telephone (TTY) Users

To assist customers who are deaf,  
hard of hearing, or speech-impaired  
and who use Text Telephones  
(TTYs), Cadillac has TTY equipment  
available at its Customer Assistance  
Center. Any TTY user can

communicate with Cadillac by  
dialing: 1-800-833-2622. TTY users  
in Canada can dial 1-800-263-3830.

### Online Owner Center

#### Online Owner Experience (U.S.) my.cadillac.com

The Cadillac online owner  
experience allows interaction with  
Cadillac and keeps important  
vehicle-specific information in one  
place.

#### Membership Benefits

 **(Vehicle Information):**  
Download owner manuals and view  
vehicle-specific how-to videos.

 **(Maintenance Information):**  
View maintenance schedules,  
required alerts, and OnStar onboard  
vehicle diagnostic information.  
Schedule service appointments.

 **(Service History):** View  
printable dealer-recorded service  
records and self-recorded service  
records.

 **(Preferred Dealer  
Information):** Select a dealer and  
view locations, maps, phone  
numbers, and hours.

 **(Warranty Tracking  
Information):** Track the vehicle's  
warranty information.

 **(Recall Information):** View  
active recalls or search by Vehicle  
Identification Number (VIN). See  
*Vehicle Identification Number (VIN)*  
on page 12-1.

 **(Other Account Information):**  
View GM Card, SiriusXM Satellite  
radio, and OnStar account  
information.

 **(Live Chat Support):** Chat with  
online help representatives.

See my.cadillac.com to register your  
vehicle.

## Cadillac Owner Centre (Canada) [cadillacowner.ca](http://cadillacowner.ca)

Visit the Cadillac Owner Centre:

- Chat live with online help representatives.
- Locate owner resources such as lease-end, financing, and warranty information.
- Retrieve favorite articles, quizzes, tips, and multimedia galleries organized into the Featured Articles and Auto Care Sections.
- Download owner manuals.
- Find Cadillac-recommended maintenance services.

## Roadside Service

U.S.: 1-800-224-1400.

Canada: 1-800-882-1112.

Text Telephone (TTY) Users (U.S. Only): 1-888-889-2438.

Service is available 24 hours a day, 365 days a year.

## Calling for Service

When calling Roadside Service, have the following information ready:

- Your name, home address, and home telephone number.
- Telephone number of your location.
- Location of the vehicle.
- Model, year, color, and license plate number of the vehicle.
- Odometer reading, Vehicle Identification Number (VIN), and delivery date of the vehicle.
- Description of the problem.

## Coverage

Services are provided up to 6 years/110 000 km (70,000 mi), whichever comes first.

In the U.S., anyone driving the vehicle is covered. In Canada, a person driving the vehicle without permission from the owner is not covered.

Roadside Service is not a part of the New Vehicle Limited Warranty. General Motors North America and Cadillac reserve the right to make any changes or discontinue the Roadside Service program at any time without notification.

General Motors North America and Cadillac reserve the right to limit services or payment to an owner or driver if they decide the claims are made too often, or the same type of claim is made many times.

## Cadillac Owner Privileges™

- **Emergency Fuel Delivery:** Delivery of enough fuel for the vehicle to get to the nearest service station.
- **Lock-Out Service:** Service to unlock the vehicle if you are locked out. A remote unlock may be available if you have OnStar. For security reasons, the driver must present identification before this service is given.

## 13-6 Customer Information

---

- **Emergency Tow from a Public Road or Highway:** Tow to the nearest Cadillac dealer for warranty service, or if the vehicle was in a crash and cannot be driven. Assistance is not given when the vehicle is stuck in the sand, mud, or snow.
- **Flat Tire Change:** Service to change a flat tire with a spare tire. The spare tire, if equipped, must be in good condition and properly inflated. It is your responsibility for the repair or replacement of the tire if it is not covered by the warranty.
- **Battery Jump Start:** Service to jump start a dead battery.
- **Trip Interruption Benefits and Service:** If your trip is interrupted due to a warranty failure, incidental expenses may be reimbursed during the 6 years/110 000 km (70,000 mi) Powertrain warranty period. Items considered are hotel, meals, and rental car.

### Cadillac Technician Roadside Service (U.S. Only)

Cadillac's exceptional Roadside Service is more than an auto club or towing service. It provides every Cadillac owner in the United States with the advantage of contacting a Cadillac advisor and, where available, a Cadillac trained dealer technician who can provide on-site service.

A dealer technician will travel to your location within a 30-mile radius of a participating Cadillac dealership. If beyond this radius, we will arrange to have your car towed to the nearest Cadillac dealership. Each technician travels with a specially equipped service vehicle complete with the necessary Cadillac parts and tools required to handle most roadside repairs.

### Services Not Included in Roadside Service

- Impound towing caused by violation of any laws.

- Legal fines.
- Mounting, dismounting, or changing of snow tires, chains, or other traction devices.

Service is not provided if a vehicle is in an area that is not accessible to the service vehicle or is not a regularly traveled or maintained public road, which includes ice and winter roads. Off-road use is not covered.

### Services Specific to Canadian-Purchased Vehicles

- **Fuel delivery:** Reimbursement is up to 7 liters. Diesel fuel delivery may be restricted. Propane and other fuels are not provided through this service.
- **Lock-Out Service:** Vehicle registration is required.
- **Trip Interruption Benefits and Service:** Pre-authorization, original detailed receipts, and a copy of the repair orders are required. Once authorization has been received, the Roadside

Service advisor will help you make arrangements and explain how to receive payment.

- **Alternative Service:** If assistance cannot be provided right away, the Roadside Service advisor may give you permission to get local emergency road service. You will receive payment, up to \$100, after sending the original receipt to Roadside Service. Mechanical failures may be covered, however any cost for parts and labor for repairs not covered by the warranty are the owner responsibility.

## Scheduling Service Appointments

When the vehicle requires warranty service, contact your dealer and request an appointment. By scheduling a service appointment and advising the service consultant

of your transportation needs, your dealer can help minimize your inconvenience.

If the vehicle cannot be scheduled into the service department immediately, keep driving it until it can be scheduled for service, unless, of course, the problem is safety related. If it is, please call your dealership, let them know this, and ask for instructions.

If your dealer requests you to bring the vehicle for service, you are urged to do so as early in the work day as possible to allow for same-day repair.

## Courtesy Transportation Program

To enhance your ownership experience, we and our participating dealers are proud to offer Courtesy Transportation, a customer support program for vehicles with the Bumper-to-Bumper (Base Warranty Coverage period in Canada),

extended powertrain, and/or hybrid-specific warranties in both the U.S. and Canada.

Several Courtesy Transportation options are available to assist in reducing inconvenience when warranty repairs are required.

Courtesy Transportation is not a part of the New Vehicle Limited Warranty. A separate booklet entitled "Limited Warranty and Owner Assistance Information" furnished with each new vehicle provides detailed warranty coverage information.

### Transportation Options

Warranty service can generally be completed while you wait. However, if you are unable to do so, your dealer may offer the following transportation options:

#### Shuttle Service

This includes one-way or round-trip shuttle service within reasonable time and distance parameters of your dealer's area.

## 13-8 Customer Information

---

### **Public Transportation or Fuel Reimbursement**

If overnight warranty repairs are needed, and public transportation is used, the expense must be supported by original receipts and within the maximum amount allowed by GM for shuttle service. If U.S. customers arrange their own transportation, limited reimbursement for reasonable fuel expenses may be available. Claim amounts should reflect actual costs and be supported by original receipts. See your dealer for information.

### **Courtesy Rental Vehicle**

For an overnight warranty repair, the dealer may provide an available courtesy rental vehicle or provide for reimbursement of a rental vehicle. Reimbursement is limited and must be supported by original receipts as well as a signed and completed rental agreement and meet state/provincial, local, and rental vehicle provider requirements.

Requirements vary and may include minimum age requirements, insurance coverage, credit card, etc. Additional fees such as fuel usage charges, taxes, levies, usage fees, excessive mileage, or rental usage beyond the completion of the repair are also your responsibility.

It may not be possible to provide a like vehicle as a courtesy rental.

### **Additional Program Information**

All program options, such as shuttle service, may not be available at every dealer. Contact your dealer for specific availability.

*General Motors reserves the right to unilaterally modify, change, or discontinue Courtesy Transportation at any time and to resolve all questions of claim eligibility pursuant to the terms and conditions described herein at its sole discretion.*

### **Collision Damage Repair**

If the vehicle is involved in a collision and it is damaged, have the damage repaired by a qualified technician using the proper equipment and quality replacement parts. Poorly performed collision repairs diminish the vehicle resale value, and safety performance can be compromised in subsequent collisions.

### **Collision Parts**

Genuine GM Collision parts are new parts made with the same materials and construction methods as the parts with which the vehicle was originally built. Genuine GM Collision parts are the best choice to ensure that the vehicle's designed appearance, durability, and safety are preserved. The use of Genuine GM parts can help maintain the GM New Vehicle Limited Warranty.

Recycled original equipment parts may also be used for repair. These parts are typically removed from

vehicles that were total losses in prior crashes. In most cases, the parts being recycled are from undamaged sections of the vehicle. A recycled original equipment GM part may be an acceptable choice to maintain the vehicle's originally designed appearance and safety performance; however, the history of these parts is not known. Such parts are not covered by the GM New Vehicle Limited Warranty, and any related failures are not covered by that warranty.

Aftermarket collision parts are also available. These are made by companies other than GM and may not have been tested for the vehicle. As a result, these parts may fit poorly, exhibit premature durability/corrosion problems, and may not perform properly in subsequent collisions. Aftermarket parts are not covered by the GM New Vehicle Limited Warranty, and any vehicle failure related to such parts is not covered by that warranty.

### **Repair Facility**

GM also recommends that you choose a collision repair facility that meets your needs before you ever need collision repairs. Your dealer may have a collision repair center with GM-trained technicians and state-of-the-art equipment, or be able to recommend a collision repair center that has GM-trained technicians and comparable equipment.

### **Insuring the Vehicle**

Protect your investment in the GM vehicle with comprehensive and collision insurance coverage. There are significant differences in the quality of coverage afforded by various insurance policy terms. Many insurance policies provide reduced protection to the GM vehicle by limiting compensation for damage repairs by using aftermarket collision parts. Some insurance companies will not specify aftermarket collision parts. When purchasing insurance, we

recommend that you ensure that the vehicle will be repaired with GM original equipment collision parts. If such insurance coverage is not available from your current insurance carrier, consider switching to another insurance carrier.

If the vehicle is leased, the leasing company may require you to have insurance that ensures repairs with Genuine GM Original Equipment Manufacturer (OEM) parts or Genuine Manufacturer replacement parts. Read the lease carefully, as you may be charged at the end of the lease for poor quality repairs.

### **If a Crash Occurs**

If there has been an injury, call emergency services for help. Do not leave the scene of a crash until all matters have been taken care of. Move the vehicle only if its position puts you in danger, or you are instructed to move it by a police officer.

## 13-10 Customer Information

---

Give only the necessary information to police and other parties involved in the crash.

For emergency towing see *Roadside Service* on page 13-5.

Gather the following information:

- Driver name, address, and telephone number.
- Driver license number.
- Owner name, address, and telephone number.
- Vehicle license plate number.
- Vehicle make, model, and model year.
- Vehicle Identification Number (VIN).
- Insurance company and policy number.
- General description of the damage to the other vehicle.

Choose a reputable repair facility that uses quality replacement parts. See “Collision Parts” earlier in this section.

If the airbag has inflated, see *What Will You See after an Airbag Inflates?* on page 3-25.

### **Managing the Vehicle Damage Repair Process**

In the event that the vehicle requires damage repairs, GM recommends that you take an active role in its repair. If you have a pre-determined repair facility of choice, take the vehicle there, or have it towed there. Specify to the facility that any required replacement collision parts be original equipment parts, either new Genuine GM parts or recycled original GM parts. Remember, recycled parts will not be covered by the GM vehicle warranty.

Insurance pays the bill for the repair, but you must live with the repair. Depending on your policy limits, your insurance company may initially value the repair using aftermarket parts. Discuss this with the repair professional, and insist on Genuine GM parts. Remember, if the vehicle is leased, you may be

obligated to have the vehicle repaired with Genuine GM parts, even if your insurance coverage does not pay the full cost.

If another party's insurance company is paying for the repairs, you are not obligated to accept a repair valuation based on that insurance company's collision policy repair limits, as you have no contractual limits with that company. In such cases, you can have control of the repair and parts choices as long as the cost stays within reasonable limits.

### **Service Publications Ordering Information**

#### **Service Manuals**

Service Manuals have the diagnosis and repair information on the engines, transmission, axle, suspension, brakes, electrical, steering, body, etc.

### Service Bulletins

Service Bulletins give additional technical service information needed to knowledgeably service General Motors cars and trucks. Each bulletin contains instructions to assist in the diagnosis and service of the vehicle.

### Owner Information

Owner publications are written specifically for owners and intended to provide basic operational information about the vehicle. The Owner Manual includes the Maintenance Schedule for all models.

In-Portfolio: Includes a Portfolio, Owner Manual, and Warranty Manual.

RETAIL SELL PRICE: \$35.00 – \$40.00 (U.S.) plus handling and shipping fees.

Without Pouch: Owner Manual only.

RETAIL SELL PRICE:  
\$25.00 (U.S.) plus handling and shipping fees.

### Current and Past Models

Technical Service Bulletins and Manuals are available for current and past model GM vehicles.

ORDER TOLL FREE:  
1-800-551-4123 Monday – Friday  
8:00 AM – 6:00 PM Eastern Time

For Credit Card Orders Only  
(VISA-MasterCard-Discover), see  
Helm, Inc. at: [www.helminc.com](http://www.helminc.com).

Or write to:

Helm, Incorporated  
Attention: Customer Service  
47911 Halyard Drive  
Plymouth, MI 48170

Prices are subject to change without notice and without incurring obligation. Allow ample time for delivery.

All listed prices are quoted in U.S. funds. Make checks payable in U.S. funds.

### Radio Frequency Identification (RFID)

RFID technology is used in some vehicles for functions such as tire pressure monitoring and ignition system security, as well as in connection with conveniences such as Remote Keyless Entry (RKE) transmitters for remote door locking/unlocking and starting, and in-vehicle transmitters for garage door openers. RFID technology in GM vehicles does not use or record personal information or link with any other GM system containing personal information.



### Radio Frequency Statement

This vehicle has systems that operate on a radio frequency that complies with Part 15/Part 18 of the Federal Communications Commission (FCC) rules and with Industry Canada Standards RSS-GEN/210/220/310, ICES-001.

Operation is subject to the following two conditions:

1. The device may not cause harmful interference.
2. The device must accept any interference received, including interference that may cause undesired operation of the device.

Changes or modifications to any of these systems by other than an authorized service facility could void authorization to use this equipment.

### Reporting Safety Defects

#### Reporting Safety Defects to the United States Government

If you believe that your vehicle has a defect which could cause a crash or could cause injury or death, you should immediately inform the National Highway Traffic Safety Administration (NHTSA) in addition to notifying General Motors.

If NHTSA receives similar complaints, it may open an investigation, and if it finds that a safety defect exists in a group of vehicles, it may order a recall and remedy campaign.

However, NHTSA cannot become involved in individual problems between you, your dealer, or General Motors.

To contact NHTSA, you may call the Vehicle Safety Hotline toll-free at 1-888-327-4236 (TTY: 1-800-424-9153); go to <http://www.safercar.gov>; or write to:

Administrator, NHTSA  
1200 New Jersey Avenue, S.E.  
Washington, D.C. 20590

You can also obtain other information about motor vehicle safety from <http://www.safercar.gov>.

## Reporting Safety Defects to the Canadian Government

If you live in Canada, and you believe that the vehicle has a safety defect, notify Transport Canada immediately, and notify General Motors of Canada Limited. Call Transport Canada at 1-800-333-0510 or write to:

Transport Canada  
Road Safety Branch  
80 rue Noel  
Gatineau, QC J8Z 0A1

## Reporting Safety Defects to General Motors

In addition to notifying NHTSA (or Transport Canada) in a situation like this, notify General Motors.

Call 1-800-458-8006, or write:

Cadillac Customer Assistance Center  
Cadillac Motor Car Division  
P.O. Box 33169  
Detroit , MI 48232-5169

In Canada, call 1-888-446-2000, or write:

Canadian Cadillac Customer Care Centre, Mail Code: CA1-163-005  
General Motors of Canada Limited  
1908 Colonel Sam Drive  
Oshawa , Ontario L1H 8P7

## Vehicle Data Recording and Privacy

The vehicle has a number of computers that record information about the vehicle's performance and how it is driven. For example, the vehicle uses computer modules to monitor and control engine and transmission performance, to monitor the conditions for airbag deployment and deploy them in a crash, and, if equipped, to provide antilock braking to help the driver control the vehicle. These modules may store data to help the dealer technician service the vehicle. Some modules may also store data about how the vehicle is operated, such as rate of fuel consumption or average speed. These modules may retain personal preferences, such as radio presets, seat positions, and temperature settings.

### Event Data Recorders

This vehicle is equipped with an event data recorder (EDR). The main purpose of an EDR is to record, in certain crash or near crash-like situations, such as an air bag deployment or hitting a road obstacle, data that will assist in understanding how a vehicle's systems performed. The EDR is designed to record data related to vehicle dynamics and safety systems for a short period of time, typically 30 seconds or less. The EDR in this vehicle is designed to record such data as:

- How various systems in your vehicle were operating;
- Whether or not the driver and passenger safety belts were buckled/fastened;
- How far (if at all) the driver was depressing the accelerator and/or brake pedal; and,
- How fast the vehicle was traveling.

These data can help provide a better understanding of the circumstances in which crashes and injuries occur. NOTE: EDR data are recorded by your vehicle only if a non-trivial crash situation occurs; no data are recorded by the EDR under normal driving conditions and no personal data (e.g., name, gender, age, and crash location) are recorded. However, other parties, such as law enforcement, could combine the EDR data with the type of personally identifying data routinely acquired during a crash investigation.

To read data recorded by an EDR, special equipment is required, and access to the vehicle or the EDR is needed. In addition to the vehicle manufacturer, other parties, such as law enforcement, that have the special equipment, can read the information if they have access to the vehicle or the EDR.

GM will not access this data or share it with others except: with the consent of the vehicle owner or, if the vehicle is leased, with the consent of the lessee; in response to an official request by police or similar government office; as part of GM's defense of litigation through the discovery process; or, as required by law. Data that GM collects or receives may also be used for GM research needs or may be made available to others for research purposes, where a need is shown and the data is not tied to a specific vehicle or vehicle owner.

## OnStar®

If the vehicle is equipped with OnStar® and has an active subscription, additional data may be collected through the OnStar system. This includes information about the vehicle's operation; collisions involving the vehicle; the use of the vehicle and its features; and, in certain situations, the location and approximate GPS speed of the vehicle. Refer to the OnStar Terms and Conditions and Privacy Statement on the OnStar website.

## Infotainment System

If the vehicle is equipped with a navigation system as part of the infotainment system, use of the system may result in the storage of destinations, addresses, telephone numbers, and other trip information. See the infotainment manual for information on stored data and for deletion instructions.



# OnStar

## OnStar Overview

OnStar Overview ..... 14-1

## OnStar Services



Emergency ..... 14-2  
 Security ..... 14-3  
 Navigation ..... 14-3  
 Connections ..... 14-4  
 Vehicle Diagnostics ..... 14-6

## OnStar Additional Information

OnStar Additional Information ..... 14-6

## OnStar Overview



-  Voice Command Button
-  Blue OnStar Button
-  Emergency Button

This vehicle may be equipped with a comprehensive, in-vehicle system that can connect to a live OnStar Advisor for Emergency, Security, Navigation, Connection, and Diagnostic Services. OnStar services may require a paid subscription. OnStar requires the vehicle battery and electrical system, cellular service, and GPS satellite signals to be available and operating. OnStar acts as a link to existing public emergency service providers. OnStar may collect information about you and your

vehicle, including location information. See OnStar's Terms and Conditions and Privacy Statement for more details including system limitations at [www.onstar.com](http://www.onstar.com) (U.S.) or [www.onstar.ca](http://www.onstar.ca) (Canada).

The OnStar system status light is next to the OnStar buttons. If the status light is:

- Solid Green: System is on.
- Flashing Green: On a call.
- Red: Indicates a problem.
- Off: System is off. Press the blue OnStar button twice to speak with an OnStar Advisor.

Press  or call 1-888-4-ONSTAR (1-888-466-7827) to speak to an Advisor.

Press  to:

- Make a call, end a call, or answer an incoming call.
- Give OnStar Hands-Free Calling voice commands.

- Give OnStar Turn-by-Turn Navigation voice commands. Requires a specific OnStar subscription plan.
- Obtain the WiFi network name, or Service Set Identifier or SSID, and passphrase (if equipped).

Press  to connect to a live Advisor to:

- Verify account information or update contact information.
- Get driving directions. Requires a specific OnStar subscription plan.
- Receive On-Demand Diagnostics for a check of the vehicle's key operating systems.

- Receive Roadside Assistance.
- Manage WiFi Settings (if equipped).

Press  to get a priority connection to an OnStar Emergency Advisor available 24/7 to:

- Get help for an emergency.
- Be a Good Samaritan or respond to an AMBER Alert.
- Get assistance in severe weather or other crisis and evacuation routes.

## OnStar Services

### Emergency

With Automatic Crash Response, the OnStar system can automatically connect to an OnStar Emergency Advisor. The built-in system can automatically connect to help in certain crashes.

Press  to connect to an OnStar Emergency Advisor. GPS technology is used to identify the vehicle location and can provide important information to emergency personnel. OnStar Emergency Advisors are trained to provide assistance and link to existing public emergency service providers in emergency situations.

With OnStar Crisis Assist, specially trained Crisis Advisors are available 24 hours a day, 7 days a week, to provide a central point of contact, assistance, and information if a crisis occurs.

## Security

OnStar provides services including Stolen Vehicle Assistance, Remote Ignition Block, and Roadside Assistance, if equipped. OnStar can unlock the vehicle doors remotely, if equipped with automatic door locks, and can help police locate the vehicle if it is stolen.

## Navigation

OnStar navigation requires a specific OnStar subscription plan.

Press  to receive directions or have them sent to the vehicle navigation screen, if equipped. Destinations can also be forwarded to the vehicle from MapQuest.com.

### Turn-by-Turn Navigation

1. Press  to connect to a live Advisor.
2. Request directions.
3. Directions are downloaded to the vehicle.

4. Follow the voice-guided commands.

### Using Voice Commands During a Planned Route

#### Cancel Route

1. Press . System responds: “OnStar ready,” then a tone. Say “Cancel route.” System responds: “Do you want to cancel directions?”
2. Say “Yes.” System responds: “OK, request completed, thank you, goodbye.”

#### Route Preview

1. Press . System responds: “OnStar ready,” then a tone.
2. Say “Route preview.” System responds with the next three maneuvers.

#### Repeat

1. Press . System responds: “OnStar ready,” then a tone.

2. Say “Repeat.” System responds with the last direction given, then responds with “OnStar ready,” then a tone.

#### Get My Destination

1. Press . System responds: “OnStar ready,” then a tone.
2. Say “Get my destination.” System responds with the address and the distance to the destination, then responds with “OnStar ready,” then a tone.

### Other Navigation Services Available from OnStar

**OnStar eNav:** Subscribers can send destinations from MapQuest.com to the vehicle Turn-by-Turn Navigation or screen-based navigation system (if equipped). When ready, the directions will be downloaded to the vehicle.

**Destination Download:** Press , then request the Advisor to download directions to the



navigation system in the vehicle (if equipped). After the call ends, press the "Go" button on the navigation screen to begin driving directions.

If directions are downloaded to the navigation system, the route can only be canceled through the navigation system.

Destinations can also be downloaded on the go. For information about eNav or Destination Download, see [www.onstar.com](http://www.onstar.com) (U.S.) or [www.onstar.ca](http://www.onstar.ca) (Canada).



### Connections

The required specific OnStar subscription plan includes the services that follow to help customers stay connected.

For coverage maps, see [www.onstar.com](http://www.onstar.com) (U.S.) or [www.onstar.ca](http://www.onstar.ca) (Canada).

### WiFi Connectivity (If Equipped)

The vehicle has a WiFi hotspot that provides a high-speed, wireless Internet connection to connect multiple mobile devices (data plan required).

1. To retrieve WiFi hotspot information, press  and select or say "WiFi settings."
2. The WiFi settings will display the WiFi network name/SSID, passphrase, and level of encryption.
3. To change the SSID or passphrase, press  or call 1-888-4-ONSTAR to connect with an Advisor.

### OnStar RemoteLink® Mobile App (If Equipped)

Download the OnStar RemoteLink mobile app to select Apple®, Android™, and BlackBerry® or Windows 7 or 8 mobile devices. From the mobile device, check the vehicle's fuel level, oil life, or tire

pressure (if the vehicle is equipped with the tire pressure monitoring system); or activate remote horn and lights. Also remote start the vehicle (if factory equipped) or unlock the doors from anywhere with a wireless connection (if equipped with automatic locks). With a required specific OnStar subscription plan, a destination can be sent to the vehicle. For OnStar RemoteLink information and compatibility, see [www.onstar.com](http://www.onstar.com) (U.S.) or [www.onstar.ca](http://www.onstar.ca) (Canada).

### OnStar RemoteLink® Key Fob Services

This feature is included for five years and allows for remote door lock/unlock (if equipped with automatic locks), remote start (if factory equipped), or activation of horn and lights from anywhere with a wireless signal. Download the app and start using it any time during the trial period to get started.

## OnStar Hands-Free Calling

This service allows calls to be made and received from the vehicle.

### To Make a Call

1. Press . System responds: "OnStar ready."
2. Say "Call." System responds: "Call. Please say the name or number to call."
3. Say the entire number without pausing, including a "1" and the area code. System responds: "OK calling."

### Calling 911 Emergency

1. Press . System responds: "OnStar Ready," followed by a tone.
2. Say "Call." System responds: "Call. Please say the name or number to call."

3. Say "911" without pausing. System responds: "911."
4. Say "Call." System responds: "OK, dialing 911."

### Retrieve My Number

1. Press . System responds: "OnStar ready."
2. Say "My number." System responds: "Your OnStar Hands-Free Calling number is," then says the number.

### End a Call

Press . System responds: "Call ended."

### Store a Name Tag for Speed Dialing

1. Press . System responds: "OnStar ready."
2. Say "Store." System responds: "Please say the number you would like to store."

3. Say the entire number without pausing. System responds: "Please say the name tag."
4. Pick a name tag. System responds: "About to store <name tag>. Does that sound OK?"
5. Say "Yes" or say "No" to try again. System responds: "OK, storing <name tag>."

### Place a Call Using a Stored Number

1. Press . System responds: "OnStar ready."
2. Say "Call <name tag>." System responds: "OK, calling <name tag>."

### Verify Minutes and Expiration

Press  and say "Minutes" then "Verify" to check how many minutes remain and their expiration date.

## Vehicle Diagnostics

OnStar Vehicle Diagnostics can perform a vehicle check every month. It will check the engine, transmission, antilock brakes, and other major vehicle systems. It also checks the tire pressures, if the vehicle is equipped with the Tire Pressure Monitoring System. If an On-Demand Diagnostics check is needed, press **On**, and an Advisor can run a check.

## OnStar Additional Information

### Transferring Service

Press **On** to request account transfer eligibility information. The Advisor can assist in canceling or removing account information.

### Selling/Transferring the Vehicle

Call 1-888-4-ONSTAR immediately to terminate your OnStar services if the vehicle is disposed of, sold, transferred, or if the lease ends.

### Reactivation for Subsequent Owners

Press **On** and follow the prompts to speak to an Advisor as soon as possible. The Advisor will update vehicle records and explain the OnStar service options available.

## How OnStar Service Works

Automatic Crash Response, Emergency Services, Crisis Assist, Stolen Vehicle Assistance, Vehicle Diagnostics, Remote Door Unlock, Roadside Assistance, Turn-by-Turn Navigation, and Hands-Free Calling are available on most vehicles. Not all OnStar services are available everywhere or on all vehicles. For more information, a full description of OnStar services, system limitations, and OnStar terms and conditions:

- Call 1-888-4-ONSTAR (1-888-466-7827).
- See [www.onstar.com](http://www.onstar.com) (U.S.).
- See [www.onstar.ca](http://www.onstar.ca) (Canada).
- Call TTY 1-877-248-2080.
- Press **On** to speak with an Advisor.

OnStar services cannot work unless the vehicle is in a place where OnStar has an agreement with a wireless service provider for service

in that area. The wireless service provider must also have coverage, network capacity, reception, and technology compatible with OnStar services. Service involving location information about the vehicle cannot work unless GPS signals are available, unobstructed, and compatible with the OnStar hardware. OnStar services may not work if the OnStar equipment is not properly installed or it has not been properly maintained. If equipment or software is added, connected, or modified, OnStar services may not work. Other problems beyond the control of OnStar may prevent service such as hills, tall buildings, tunnels, weather, electrical system design and architecture of the vehicle, damage to the vehicle in a crash, or wireless phone network congestion or jamming.

See *Radio Frequency Statement on page 13-12*.

## Services for People with Disabilities

Advisors provide services to help subscribers with physical disabilities and medical conditions.

Press  for help with:

- Locating a gas station with an attendant to pump gas.
- Finding a hotel, restaurant, etc., that meets accessibility needs.
- Providing directions to the closest hospital or pharmacy in urgent situations.

## TTY Users

OnStar has the ability to communicate to deaf, hard-of-hearing, or speech-impaired customers while in the vehicle. The available dealer-installed TTY system can provide in-vehicle access to all of the OnStar services, except Virtual Advisor and OnStar Turn-by-Turn Navigation.

## OnStar Personal Identification Number (PIN)

A PIN is needed to access some of the OnStar services, like Remote Door Unlock and Stolen Vehicle Assistance. The PIN will need to be changed the first time when speaking with an Advisor. To change the OnStar PIN, contact an OnStar Advisor by pressing  or calling 1-888-4-ONSTAR.

## Warranty

OnStar equipment may be warranted as part of the vehicle warranty.

## Languages

The vehicle can be programmed to respond in multiple languages.

Press  and ask for an Advisor. Advisors are available in English, Spanish, and French. Available languages may vary by country.

### Potential Issues

OnStar cannot perform Remote Door Unlock or Stolen Vehicle Assistance after the vehicle has been off continuously for five days. After five days, OnStar can contact Roadside Assistance and a locksmith to help gain access to the vehicle.

### Global Positioning System (GPS)

- Obstruction of the GPS can occur in a large city with tall buildings; in parking garages; around airports; in tunnels, underpasses; or in an area with very dense trees. If GPS signals are not available, the OnStar system should still operate to call OnStar. However, OnStar could have difficulty identifying the exact location.
- In emergency situations, OnStar can use the last stored GPS location to send to emergency responders.

A temporary loss of GPS can cause loss of the ability to send a Turn-by-Turn Navigation route. The Advisor may give a verbal route or may ask for a call back after the vehicle is driven into an open area.

### Cellular and GPS Antennas

Do not place items over or near the antenna to prevent blocking cellular and GPS signal reception. Cellular reception is required for OnStar to send remote signals to the vehicle.

### Unable to Connect to OnStar Message

If there is limited cellular coverage or the cellular network has reached maximum capacity, this message may come on. Press  to try the call again or try again after driving a few miles into another cellular area.

### Vehicle and Power Issues

OnStar services require a vehicle electrical system, wireless service, and GPS satellite technologies to be available and operating for features

to function properly. These systems may not operate if the battery is discharged or disconnected.

### Add-on Electrical Equipment

The OnStar system is integrated into the electrical architecture of the vehicle. Do not add any electrical equipment. See *Add-On Electrical Equipment on page 9-68*. Added electrical equipment may interfere with the operation of the OnStar system and cause it to not operate.

### Privacy

The complete OnStar Privacy Statement may be found at [www.onstar.com](http://www.onstar.com) (U.S.), or [www.onstar.ca](http://www.onstar.ca) (Canada). We recommend that you review it. If you have any questions, call 1-888-4-ONSTAR (1-888-466-7827) or press  to speak with an Advisor. Users of wireless communications are cautioned that the privacy of any information sent via wireless cellular communications cannot be assured. Third parties

may unlawfully intercept or access transmissions and private communications without consent.

### **OnStar - software acknowledgements**

Certain OnStar components include libcurl and unzip software and other third party software. Below are the notices and licenses associated with libcurl and unzip and for other third party software please see <http://www.lg.com/global/support/opensource/index> and <https://www.onstar.com/web/portal/getdocuments>

#### **libcurl:**

#### **COPYRIGHT AND PERMISSION NOTICE**

Copyright (c) 1996 - 2010, Daniel Stenberg, <[daniel@haxx.se](mailto:daniel@haxx.se)>.

All rights reserved.

Permission to use, copy, modify, and distribute this software for any purpose with or without fee is hereby granted, provided that the

above copyright notice and this permission notice appear in all copies.

THE SOFTWARE IS PROVIDED "AS IS," WITHOUT WARRANTY OF ANY KIND, EXPRESS OR IMPLIED, INCLUDING BUT NOT LIMITED TO THE WARRANTIES OF MERCHANTABILITY, FITNESS FOR A PARTICULAR PURPOSE AND NONINFRINGEMENT OF THIRD PARTY RIGHTS. IN NO EVENT SHALL THE AUTHORS OR COPYRIGHT HOLDERS BE LIABLE FOR ANY CLAIM, DAMAGES OR OTHER LIABILITY, WHETHER IN AN ACTION OF CONTRACT, TORT OR OTHERWISE, ARISING FROM, OUT OF OR IN CONNECTION WITH THE SOFTWARE OR THE USE OR OTHER DEALINGS IN THE SOFTWARE.

Except as contained in this notice, the name of a copyright holder shall not be used in advertising or otherwise to promote the sale, use

or other dealings in this Software without prior written authorization of the copyright holder.

#### **unzip:**

This is version 2005-Feb-10 of the Info-ZIP copyright and license. The definitive version of this document should be available at <ftp://ftp.info-zip.org/pub/infozip/license.html> indefinitely.

Copyright (c) 1990-2005 Info-ZIP. All rights reserved.

For the purposes of this copyright and license, "Info-ZIP" is defined as the following set of individuals:

Mark Adler, John Bush, Karl Davis, Harald Denker, Jean-Michel Dubois, Jean-loup Gailly, Hunter Goatley, Ed Gordon, Ian Gorman, Chris Herborth, Dirk Haase, Greg Hartwig, Robert Heath, Jonathan Hudson, Paul Kienitz, David Kirschbaum, Johnny Lee, Onno van der Linden, Igor Mandrichenko, Steve P. Miller, Sergio Monesi, Keith Owens, George Petrov, Greg Roelofs, Kai

Uwe Rommel, Steve Salisbury, Dave Smith, Steven M. Schweda, Christian Spieler, Cosmin Truta, Antoine Verheijen, Paul von Behren, Rich Wales, Mike White.

This software is provided “as is,” without warranty of any kind, express or implied. In no event shall Info-ZIP or its contributors be held liable for any direct, indirect, incidental, special or consequential damages arising out of the use of or inability to use this software.

Permission is granted to anyone to use this software for any purpose, including commercial applications, and to alter it and redistribute it freely, subject to the following restrictions:

1. Redistributions of source code must retain the above copyright notice, definition, disclaimer, and this list of conditions.
2. Redistributions in binary form (compiled executables) must reproduce the above copyright notice, definition, disclaimer, and

this list of conditions in documentation and/or other materials provided with the distribution. The sole exception to this condition is redistribution of a standard UnZipSFX binary (including SFXWiz) as part of a self-extracting archive; that is permitted without inclusion of this license, as long as the normal SFX banner has not been removed from the binary or disabled.

3. Altered versions—including, but not limited to, ports to new operating systems, existing ports with new graphical interfaces, and dynamic, shared, or static library versions—must be plainly marked as such and must not be misrepresented as being the original source. Such altered versions also must not be misrepresented as being Info-ZIP releases—including, but not limited to, labeling of the altered versions with the names “Info-ZIP” (or any variation

thereof, including, but not limited to, different capitalizations), “Pocket UnZip,” “WiZ” or “MacZip” without the explicit permission of Info-ZIP. Such altered versions are further prohibited from misrepresentative use of the Zip-Bugs or Info-ZIP e-mail addresses or of the Info-ZIP URL(s).

4. Info-ZIP retains the right to use the names “Info-ZIP,” “Zip,” “UnZip,” “UnZipSFX,” “WiZ,” “Pocket UnZip,” “Pocket Zip,” and “MacZip” for its own source and binary releases.

**A**

Accessories and Modifications . . . . .	10-3	Airbag System Check . . . . .	3-32	All-Wheel Drive . . . . .	9-26, 10-22
Accessory Power . . . . .	9-19	How Does an Airbag Restrain? . . . . .	3-24	Antilock Brake System (ABS) . . . . .	9-26
Active Emergency Braking System . . . . .	1-18, 9-51	Passenger Sensing System . . . . .	3-26	Warning Light . . . . .	5-19
Adaptive Cruise Control . . . . .	9-35	What Makes an Airbag Inflate? . . . . .	3-24	Appearance Care Exterior . . . . .	10-85
Adaptive Forward Lighting (AFL) . . . . .	6-4	What Will You See after an Airbag Inflates? . . . . .	3-25	Interior . . . . .	10-90
Adaptive Forward Lighting (AFL) Light . . . . .	5-24	When Should an Airbag Inflate? . . . . .	3-23	Armrest Storage . . . . .	4-2
Add-On Electrical Equipment . . . . .	9-68	Where Are the Airbags? . . . . .	3-22	Ashtrays . . . . .	5-7
Additional Information OnStar® . . . . .	14-6	Airbags Adding Equipment to the Vehicle . . . . .	3-31	Assistance Systems for Driving . . . . .	9-48
Additional Maintenance and Care . . . . .	11-9	Passenger Status Indicator . . . . .	5-14	Assistance Systems for Parking and Backing . . . . .	9-44
Adjustable Throttle and Brake Pedal . . . . .	9-14	Readiness Light . . . . .	5-13	Automatic Dimming Mirrors . . . . .	2-22
Adjustments Lumbar, Front Seats . . . . .	3-4	Servicing Airbag-Equipped Vehicles . . . . .	3-31	Door Locks . . . . .	2-12
Thigh Support . . . . .	3-5	System Check . . . . .	3-20	Transmission . . . . .	9-22
Air Cleaner/Filter, Engine . . . . .	10-10	Alarm Vehicle Security . . . . .	2-17	Transmission Fluid . . . . .	10-10
Air Filter, Passenger Compartment . . . . .	8-8	Alert Side Blind Zone (SBZA) . . . . .	9-52	Automatic Transmission Manual Mode . . . . .	9-24
Air Vents . . . . .	8-7	All-Season Tires . . . . .	10-42	Shift Lock Control Function Check . . . . .	10-23



**B**

Battery .....	10-21
Exterior Lighting Battery Saver .....	6-10
Jump Starting .....	10-78
Load Management .....	6-9
Power Protection .....	6-10
Voltage and Charging Messages .....	5-28
Blade Replacement, Wiper ...	10-23
Brake	
Pedal and Adjustable Throttle .....	9-14
System Warning Light .....	5-18
Brakes .....	10-19
Antilock .....	9-26
Assist .....	9-29
Fluid .....	10-20
Parking .....	9-27
System Messages .....	5-28
Braking .....	9-3
Braking System	
Active Emergency .....	1-18
Break-In, New Vehicle .....	9-14

Bulb Replacement .....	10-32
Back-up Lamps .....	10-30
Halogen Bulbs .....	10-25
Headlamp Aiming .....	10-25
Headlamps .....	10-25, 10-26
High Intensity Discharge (HID) Lighting .....	10-26
License Plate Lamps .....	10-31
Turn Signal Lamps .....	10-29
Buying New Tires .....	10-57

**C**

Cadillac Premium Care Maintenance .....	11-3
Calibration .....	5-5
California	
Fuel Requirements .....	9-57
Perchlorate Materials Requirements .....	10-3
Warning .....	10-2
Canadian Vehicle Owners .....	iii
Capacities and Specifications .....	12-2

Carbon Monoxide	
Engine Exhaust .....	9-21
Liftgate .....	2-14
Winter Driving .....	9-7
Cargo	
Cover .....	4-3
Management System .....	4-5
Tie-Downs .....	4-5
Cargo Lamp .....	6-7
Cargo Net .....	4-9
Cautions, Danger, and Warnings .....	iv
Center Console Storage .....	4-3
Chains, Tire .....	10-61
Charging System Light .....	5-15
Check	
Engine Light .....	5-15
Child Restraints	
Infants and Young Children .....	3-35
Lower Anchors and Tethers for Children .....	3-40
Older Children .....	3-33
Securing .....	3-48, 3-51
Systems .....	3-37
Cigarette Lighter .....	5-7

Circuit Breakers ..... 10-33

Cleaning

    Exterior Care ..... 10-85

    Interior Care ..... 10-90

Climate Control Systems

    Dual Automatic ..... 8-1

    Rear ..... 8-6

Clock ..... 5-6

Cluster, Instrument ..... 5-9

Collision Damage Repair ..... 13-8

Compact Spare Tire ..... 10-77

Compartments

    Storage ..... 4-1

Compass ..... 5-5

    Messages ..... 5-29

Compressor Kit, Tire

    Sealant ..... 10-63

Connections

    OnStar® ..... 14-4

Control

    Traction and Electronic

        Stability ..... 9-30

Control of a Vehicle ..... 9-3

Convenience Net ..... 4-11

Convex Mirrors ..... 2-20

Coolant

    Engine ..... 10-13

    Engine Temperature

        Gauge ..... 5-12

    Engine Temperature

        Warning Light ..... 5-21

Cooling System ..... 10-12

    Engine Messages ..... 5-30

Courtesy Lamps ..... 6-7

Courtesy Transportation

    Program ..... 13-7

Cover

    Cargo ..... 4-3

    Engine ..... 10-6

Cruise Control ..... 9-33

    Light ..... 5-25

    Messages ..... 5-29

Cruise Control, Active ..... 9-35

Cupholders ..... 4-2

Customer Assistance ..... 13-4

    Offices ..... 13-3

    Text Telephone (TTY)

        Users ..... 13-4

Customer Information

    Service Publications

        Ordering Information ..... 13-10

Customer Satisfaction

    Procedure ..... 13-1

**D**

Damage Repair, Collision ..... 13-8

Danger, Warnings, and

    Cautions ..... iv

Data Recorders, Event ..... 13-14

Daytime Running

    Lamps (DRL) ..... 6-3

Defensive Driving ..... 9-3

Delayed Locking ..... 2-12

Distracted Driving ..... 9-2

Dome Lamps ..... 6-8

Door

    Ajar Messages ..... 5-30

    Delayed Locking ..... 2-12

    Locks ..... 2-11

    Power Locks ..... 2-12

    Rear Seat Pass-Through ..... 3-12

Drive Belt Routing, Engine . . . . .	12-4
Drive Systems	
All-Wheel Drive . . . . .	9-26, 10-22
Driver Assistance Systems . . . . .	9-43
Driver Information	
Center (DIC) . . . . .	5-25
Driving	
Assistance Systems . . . . .	9-48
Characteristics and	
Towing Tips . . . . .	9-60
Defensive . . . . .	9-3
Drunk . . . . .	9-3
For Better Fuel Economy . . . . .	1-20
Hill and Mountain Roads . . . . .	9-6
If the Vehicle is Stuck . . . . .	9-9
Loss of Control . . . . .	9-5
Off-Road Recovery . . . . .	9-4
Vehicle Load Limits . . . . .	9-9
Wet Roads . . . . .	9-5
Winter . . . . .	9-7
Dual Automatic Climate	
Control System . . . . .	8-1

**E**

ECO Button . . . . .	9-25
Economy Mode	
Fuel . . . . .	9-25
Electric Parking Brake Light . . . . .	5-18
Electrical Equipment,	
Add-On . . . . .	9-68
Electrical System	
Engine Compartment	
Fuse Block . . . . .	10-33
Fuses and Circuit	
Breakers . . . . .	10-33
Instrument Panel Fuse	
Block . . . . .	10-36
Overload . . . . .	10-32
Rear Compartment Fuse	
Block . . . . .	10-38
Emergency	
OnStar® . . . . .	14-2
Engine	
Air Cleaner/Filter . . . . .	10-10
Check and Service Engine	
Soon Light . . . . .	5-15
Compartment Overview . . . . .	10-5
Coolant . . . . .	10-13

Engine (cont'd)	
Coolant Temperature	
Gauge . . . . .	5-12
Coolant Temperature	
Warning Light . . . . .	5-21
Cooling System . . . . .	10-12
Cooling System Messages . . . . .	5-30
Cover . . . . .	10-6
Drive Belt Routing . . . . .	12-4
Exhaust . . . . .	9-21
Gasoline Starting . . . . .	9-16
Heater . . . . .	9-18
Oil Life System . . . . .	10-9
Oil Messages . . . . .	5-31
Overheating . . . . .	10-16
Power Messages . . . . .	5-31
Pressure Light . . . . .	5-22
Running While Parked . . . . .	9-22
Entry Lighting . . . . .	6-8
Equipment, Towing . . . . .	9-66
Event Data Recorders . . . . .	13-14
Exit Lighting . . . . .	6-8
Extender, Safety Belt . . . . .	3-19
Exterior Lamp Controls . . . . .	6-1
Exterior Lighting Battery	
Saver . . . . .	6-10

**F**

Features  
 Memory ..... 1-8  
 Filter,  
   Engine Air Cleaner ..... 10-10  
 Flash-to-Pass ..... 6-3  
 Flashers, Hazard Warning ..... 6-6  
 Flat Tire ..... 10-62  
   Changing ..... 10-71  
 Floor Mats ..... 10-93  
 Fluid  
   Automatic Transmission .... 10-10  
   Brakes ..... 10-20  
   Power Steering ..... 10-18  
   Washer ..... 10-18  
 Fog Lamps  
   Front ..... 6-6  
 Folding Mirrors ..... 2-21  
 Forward Collision Alert  
   (FCA) System ..... 9-48  
 Frequency Statement  
   Radio ..... 13-12  
 Front Fog Lamp  
   Light ..... 5-24

Front Seats  
   Adjustment ..... 3-3  
   Heated and Ventilated ..... 3-8  
 Front Storage ..... 4-2  
 Fuel ..... 9-56  
   Additives ..... 9-57  
   Economy Driving ..... 1-20  
   Economy Light ..... 5-23  
   Filling a Portable Fuel  
     Container ..... 9-59  
   Filling the Tank ..... 9-58  
   Foreign Countries ..... 9-57  
   Gauge ..... 5-11  
   Low Fuel Warning Light ..... 5-23  
   Requirements, California .... 9-57  
   System Messages ..... 5-32  
 Fuel Economy Mode ..... 9-25  
 Fuses  
   Engine Compartment  
     Fuse Block ..... 10-33  
   Fuses and Circuit  
     Breakers ..... 10-33  
   Instrument Panel Fuse  
     Block ..... 10-36  
   Rear Compartment Fuse  
     Block ..... 10-38

**G**

Garage Door Opener ..... 5-46  
   Programming ..... 5-46  
 Gasoline Engine, Starting ..... 9-16  
 Gauges  
   Engine Coolant  
     Temperature ..... 5-12  
   Fuel ..... 5-11  
   Odometer ..... 5-10  
   Speedometer ..... 5-10  
   Tachometer ..... 5-11  
   Trip Odometer ..... 5-10  
   Warning Lights and  
     Indicators ..... 5-8  
 General Information  
   Service and Maintenance .... 11-1  
   Towing ..... 9-60  
   Vehicle Care ..... 10-2  
 Glove Box ..... 4-1

**H**

Halogen Bulbs .....	10-25
Hazard Warning Flashers .....	6-6
Head Restraints .....	3-2
Headlamps .....	10-26
Adaptive Forward	
Lighting (AFL) .....	6-4
Aiming .....	10-25
Bulb Replacement .....	10-25
Daytime Running	
Lamps (DRL) .....	6-3
Flash-to-Pass .....	6-3
High Intensity Discharge	
(HID) Lighting .....	10-26
High-Beam On Light .....	5-24
High/Low Beam Changer .....	6-3
Lamps On Reminder .....	5-24
Turn Signal Lamps .....	10-29
Twilight Sentinel .....	6-5
Heated	
Rear Seats .....	3-11
Steering Wheel .....	5-2
Heated and Ventilated Front	
Seats .....	3-8
Heated Mirrors .....	2-22

## Heater

Engine .....	9-18
High-Beam On Light .....	5-24
High-Speed Operation .....	10-49
Hill and Mountain Roads .....	9-6
Hill Start Assist (HSA) .....	9-29
Hood .....	10-4
Horn .....	5-3
How to Wear Safety Belts	
Properly .....	3-13

**I**

Ignition Positions .....	9-15
Immobilizer .....	2-19
Indicator	
Vehicle Ahead .....	5-20
Infants and Young Children,	
Restraints .....	3-35
Infotainment .....	7-1
Infotainment System .....	13-15
Instrument Cluster .....	5-9
Interior Rearview Mirrors .....	2-23
Introduction .....	iii

**J**

Jump Starting .....	10-78
---------------------	-------

**K**

Key and Lock Messages .....	5-32
Keyless Entry	
Remote (RKE) System .....	2-3
Keys .....	2-1

**L**

Labeling, Tire Sidewall .....	10-43
Lamps	
Cargo .....	6-7
Courtesy .....	6-7
Daytime Running (DRL) .....	6-3
Dome .....	6-8
Exterior Controls .....	6-1
Exterior Lighting Battery	
Saver .....	6-10
Front Fog .....	6-6
License Plate .....	10-31
Malfunction Indicator .....	5-15

Lamps (cont'd)  
 Messages ..... 5-32  
 On Reminder ..... 5-24  
 Reading ..... 6-8  
 Lane Departure  
 Warning (LDW) ..... 9-54  
 Lane Departure Warning  
 Light ..... 5-20  
 Lap-Shoulder Belt ..... 3-14  
 LATCH System  
 Replacing Parts after a  
 Crash ..... 3-48  
 LATCH, Lower Anchors and  
 Tethers for Children ..... 3-40  
 Liftgate ..... 2-14  
 Light  
 Adaptive Forward Lighting  
 (AFL) Light ..... 5-24  
 Lighter, Cigarette ..... 5-7  
 Lighting  
 Adaptive Forward ..... 6-4  
 Entry ..... 6-8  
 Exit ..... 6-8  
 Illumination Control ..... 6-7

Lights  
 Airbag Readiness ..... 5-13  
 Antilock Brake System  
 (ABS) Warning ..... 5-19  
 Brake System Warning ..... 5-18  
 Charging System ..... 5-15  
 Cruise Control ..... 5-25  
 Electric Parking Brake ..... 5-18  
 Engine Coolant  
 Temperature Warning ..... 5-21  
 Engine Oil Pressure ..... 5-22  
 Flash-to-Pass ..... 6-3  
 Front Fog Lamp ..... 5-24  
 Fuel Economy ..... 5-23  
 High-Beam On ..... 5-24  
 High/Low Beam Changer ..... 6-3  
 Lane Departure Warning ..... 5-20  
 Low Fuel Warning ..... 5-23  
 Safety Belt Reminders ..... 5-12  
 Security ..... 5-23  
 Service Electric Parking  
 Brake ..... 5-19  
 StabiliTrak® OFF ..... 5-20

Lights (cont'd)  
 Tire Pressure ..... 5-22  
 Traction Control System  
 (TCS)/StabiliTrak® ..... 5-21  
 Traction Off ..... 5-20  
 Limited-Slip Rear Axle ..... 9-32  
 Locks  
 Automatic Door ..... 2-12  
 Delayed Locking ..... 2-12  
 Door ..... 2-11  
 Lockout Protection ..... 2-13  
 Power Door ..... 2-12  
 Safety ..... 2-13  
 Loss of Control ..... 9-5  
 Low Fuel Warning Light ..... 5-23  
 Lower Anchors and Tethers  
 for Children (LATCH  
 System) ..... 3-40  
 Lumbar Adjustment ..... 3-4  
 Front Seats ..... 3-4

**M**

Maintenance	
Records .....	11-14
Maintenance and Care	
Additional .....	11-9
Maintenance Schedule .....	11-3
Recommended Fluids and Lubricants .....	11-12
Malfunction Indicator Lamp ....	5-15
Manual Mode .....	9-24
Memory Features .....	1-8
Memory Seats .....	3-6
Messages	
Airbag System .....	5-36
Battery Voltage and Charging .....	5-28
Brake System .....	5-28
Compass .....	5-29
Door Ajar .....	5-30
Engine Cooling System .....	5-30
Engine Oil .....	5-31
Engine Power .....	5-31
Fuel System .....	5-32
Key and Lock .....	5-32
Lamp .....	5-32
Object Detection System .....	5-33

## Messages (cont'd)

Ride Control System .....	5-36
Security .....	5-37
Service Vehicle .....	5-37
Starting the Vehicle .....	5-37
Tire .....	5-37
Transmission .....	5-38
Vehicle .....	5-28
Vehicle Reminder .....	5-38
Vehicle Speed .....	5-38
Washer Fluid .....	5-38
Mirrors	
Automatic Dimming .....	2-22
Automatic Dimming Rearview .....	2-23
Convex .....	2-20
Folding .....	2-21
Heated .....	2-22
Manual Rearview .....	2-23
Power .....	2-21
Tilt in Reverse .....	2-22
Mirrors, Interior Rearview .....	2-23
Monitor System, Tire Pressure .....	10-50

**N**

Navigation	
OnStar® .....	14-3
Net	
Cargo .....	4-9
Net, Convenience .....	4-11
New Vehicle Break-In .....	9-14

**O**

Object Detection System	
Messages .....	5-33
Odometer .....	5-10
Trip .....	5-10
Off-Road	
Recovery .....	9-4
Oil	
Engine .....	10-7
Engine Oil Life System .....	10-9
Messages .....	5-31
Pressure Light .....	5-22
Older Children, Restraints .....	3-33
Online Owner Center .....	13-4
OnStar .....	13-15
OnStar® System, In Brief .....	1-21

OnStar® Additional Information ..... 14-6

OnStar® Connections ..... 14-4

OnStar® Emergency ..... 14-2

OnStar® Navigation ..... 14-3

OnStar® Overview ..... 14-1

OnStar® Security ..... 14-3

OnStar® Vehicle Diagnostics ..... 14-6

Ordering Service Publications ..... 13-10

Outlets Power ..... 5-6

Overheating, Engine ..... 10-16

**P**

Park Shifting Into ..... 9-19

Shifting Out of ..... 9-20

Parking Brake ..... 9-27

Brake and P (Park) Mechanism Check ..... 10-23

Over Things That Burn ..... 9-21

Parking or Backing Assistance Systems ..... 9-44

Passenger Airbag Status Indicator ..... 5-14

Passenger Compartment Air Filter ..... 8-8

Passenger Sensing System ... 3-26

Perchlorate Materials Requirements, California ..... 10-3

Personalization Vehicle ..... 5-39

Power Door Locks ..... 2-12

Mirrors ..... 2-21

Outlets ..... 5-6

Protection, Battery ..... 6-10

Retained Accessory (RAP) ... 9-19

Seat Adjustment ..... 3-4

Steering Fluid ..... 10-18

Windows ..... 2-24

Pregnancy, Using Safety Belts ..... 3-18

Premium Care Maintenance Cadillac ..... 11-3

Privacy Vehicle Data Recording ..... 13-13

Program Courtesy Transportation ..... 13-7

Proposition 65 Warning, California ..... 10-2

**R**

Radio Frequency Identification (RFID) ..... 13-11

Radio Frequency Statement ..... 13-12

Reading Lamps ..... 6-8

Rear Axle Limited-Slip ..... 9-32

Rear Climate Control System ... 8-6

Rear Seat Pass-Through Door ..... 3-12

Rear Seats ..... 3-10

Heated ..... 3-11

Rear Window Washer/Wiper .... 5-4

Rearview Mirrors ..... 2-23

Automatic Dimming ..... 2-23

Reclining Seatbacks ..... 3-5

Recommended Fluids and Lubricants ..... 11-12

Records Maintenance ..... 11-14



Recreational Vehicle	
Towing .....	10-82
Remote Keyless Entry	
(RKE) System .....	2-2, 2-3
Remote Vehicle Start .....	2-9
Replacement Bulbs .....	10-32
Replacement Parts	
Airbags .....	3-32
Maintenance .....	11-13
Replacing Airbag System .....	3-32
Replacing LATCH System	
Parts after a Crash .....	3-48
Replacing Safety Belt	
System Parts after a Crash ...	3-19
Reporting Safety Defects	
Canadian Government .....	13-13
General Motors .....	13-13
U.S. Government .....	13-12
Restraints	
Where to Put .....	3-39
Retained Accessory	
Power (RAP) .....	9-19
Reverse Tilt Mirrors .....	2-22

Ride Control Systems	
Limited Slip Rear Axle .....	9-32
Messages .....	5-36
Selective .....	9-32
Roads	
Driving, Wet .....	9-5
Roadside Service .....	13-5
Roof	
Sunroof .....	2-26
Roof Rack System .....	4-11
Rotation, Tires .....	10-55
Routing, Engine Drive Belt .....	12-4
Running the Vehicle While	
Parked .....	9-22
<b>S</b>	
Safety Belts .....	3-12
Care .....	3-19
Extender .....	3-19
How to Wear Safety Belts	
Properly .....	3-13
Lap-Shoulder Belt .....	3-14
Reminders .....	5-12
Replacing after a Crash .....	3-19
Use During Pregnancy .....	3-18

Safety Defects Reporting	
Canadian Government .....	13-13
General Motors .....	13-13
U.S. Government .....	13-12
Safety Locks .....	2-13
Safety System Check .....	3-19
Scheduling Appointments .....	13-7
Sealant Kit, Tire .....	10-63
Seats	
Adjustment, Front .....	3-3
Head Restraints .....	3-2
Heated and Ventilated Front ...	3-8
Heated, Rear .....	3-11
Lumbar Adjustment, Front .....	3-4
Memory .....	3-6
Power Adjustment, Front .....	3-4
Rear .....	3-10
Reclining Seatbacks .....	3-5
Securing Child	
Restraints .....	3-48, 3-51
Security	
Light .....	5-23
Messages .....	5-37
OnStar® .....	14-3
Vehicle .....	2-17
Vehicle Alarm .....	2-17

Selective Ride Control . . . . .	9-32	Side Blind Zone		Storage Areas	
Service		Alert (SBZA) . . . . .	9-52	Armrest . . . . .	4-2
Accessories and		Signals, Turn and		Cargo Cover . . . . .	4-3
Modifications . . . . .	10-3	Lane-Change . . . . .	6-6	Cargo Management System . . .	4-5
Doing Your Own Work . . . . .	10-3	Spare Tire		Center Console . . . . .	4-3
Engine Soon Light . . . . .	5-15	Compact . . . . .	10-77	Convenience Net . . . . .	4-11
Maintenance Records . . . . .	11-14	Special Application Services . . .	11-9	Front . . . . .	4-2
Maintenance, General		Specifications and		Glove Box . . . . .	4-1
Information . . . . .	11-1	Capacities . . . . .	12-2	Roof Rack System . . . . .	4-11
Parts Identification Label . . . . .	12-1	Speedometer . . . . .	5-10	Storage Compartments . . . . .	4-1
Publications Ordering		StabiliTrak		Storing the Tire Sealant	
Information . . . . .	13-10	OFF Light . . . . .	5-20	and Compressor Kit . . . . .	10-71
Scheduling Appointments . . . . .	13-7	Start Assist, Hills . . . . .	9-29	Stuck Vehicle . . . . .	9-9
Vehicle Messages . . . . .	5-37	Start Vehicle, Remote . . . . .	2-9	Summer Tires . . . . .	10-42
Service Electric Parking		Starter Switch Check . . . . .	10-22	Sun Visors . . . . .	2-26
Brake Light . . . . .	5-19	Starting the Gasoline		Sunroof . . . . .	2-26
Services		Engine . . . . .	9-16	Symbols . . . . .	iv
Special Application . . . . .	11-9	Starting the Vehicle		System	
Service the Airbag . . . . .	3-31	Messages . . . . .	5-37	Active Emergency Braking . . . .	9-51
Shift Lock Control Function		Steering . . . . .	9-4	Forward Collision	
Check, Automatic		Fluid, Power . . . . .	10-18	Alert (FCA) . . . . .	9-48
Transmission . . . . .	10-23	Heated Wheel . . . . .	5-2	Infotainment . . . . .	7-1, 13-15
Shifting		Wheel Adjustment . . . . .	5-2	Roof Rack . . . . .	4-11
Into Park . . . . .	9-19	Wheel Controls . . . . .	5-2	Systems	
Out of Park . . . . .	9-20			Driver Assistance . . . . .	9-43

## T

Tachometer .....	5-11
Text Telephone (TTY) Users ...	13-4
Theft-Deterrent Systems .....	2-19
Immobilizer .....	2-19
Thigh Support Adjustment .....	3-5
Throttle, Adjustable .....	9-14
Time .....	5-6
Tires .....	10-41
All-Season .....	10-42
Buying New Tires .....	10-57
Chains .....	10-61
Changing .....	10-71
Compact Spare .....	10-77
Designations .....	10-45
Different Size .....	10-58
If a Tire Goes Flat .....	10-62
Inflation Monitor System ...	10-51
Inspection .....	10-54
Messages .....	5-37
Pressure .....	10-49
Pressure Light .....	5-22
Pressure Monitor System ...	10-50
Rotation .....	10-55
Sealant and Compressor Kit .....	10-63

Tires (cont'd)	
Sealant and Compressor Kit, Storing .....	10-71
Sidewall Labeling .....	10-43
Terminology and Definitions .....	10-45
Uniform Tire Quality Grading .....	10-59
Wheel Alignment and Tire Balance .....	10-60
Wheel Replacement .....	10-60
When It Is Time for New Tires .....	10-56
Winter .....	10-42
Towing	
Driving Characteristics .....	9-60
Equipment .....	9-66
General Information .....	9-60
Recreational Vehicle .....	10-82
Trailer .....	9-63
Trailer Sway Control (TSC) ...	9-67
Vehicle .....	10-82

Traction	
Control System (TCS)/ StabiliTrak <sup>®</sup> Light .....	5-21
Limited-Slip Rear Axle .....	9-32
Off Light .....	5-20
Selective Ride Control .....	9-32
Traction Control/Electronic Stability Control .....	9-30
Trailer	
Sway Control (TSC) .....	9-67
Towing .....	9-63
Transmission	
Automatic .....	9-22
Fluid, Automatic .....	10-10
Messages .....	5-38
Transportation Program, Courtesy .....	13-7
Trip Odometer .....	5-10
Turn and Lane-Change Signals .....	6-6
Twilight Sentinel .....	6-5

**U**

Uniform Tire Quality  
 Grading ..... 10-59  
 Universal Remote System ..... 5-46  
 Operation ..... 5-48  
 Programming ..... 5-46  
 Using This Manual ..... iii

**V**

Vehicle  
 Alarm System ..... 2-17  
 Canadian Owners ..... iii  
 Control ..... 9-3  
 Identification  
 Number (VIN) ..... 12-1  
 Load Limits ..... 9-9  
 Messages ..... 5-28  
 Personalization ..... 5-39  
 Reminder Messages ..... 5-38  
 Remote Start ..... 2-9  
 Security ..... 2-17  
 Speed Messages ..... 5-38  
 Towing ..... 10-82  
 Vehicle Ahead Indicator ..... 5-20

Vehicle Care  
 Storing the Tire Sealant  
 and Compressor Kit ..... 10-71  
 Tire Pressure ..... 10-48  
 Vehicle Data Recording  
 and Privacy ..... 13-13  
 Vehicle Diagnostics  
 OnStar® ..... 14-6  
 Ventilation, Air ..... 8-7  
 Visors ..... 2-26

**W**

Warning  
 Brake System Light ..... 5-18  
 Lane Departure (LDW) ..... 9-54  
 Warning Lights, Gauges, and  
 Indicators ..... 5-8  
 Warnings ..... iv  
 Cautions and Danger ..... iv  
 Hazard Flashers ..... 6-6  
 Washer Fluid ..... 10-18  
 Messages ..... 5-38

Wheels  
 Alignment and Tire  
 Balance ..... 10-60  
 Different Size ..... 10-58  
 Replacement ..... 10-60  
 When It Is Time for New  
 Tires ..... 10-56  
 Where to Put the Restraint ..... 3-39  
 Windows ..... 2-23  
 Power ..... 2-24  
 Windshield  
 Wiper/Washer ..... 5-3  
 Winter  
 Driving ..... 9-7  
 Winter Tires ..... 10-42  
 Wiper Blade Replacement ..... 10-23  
 Wipers  
 Rear Washer ..... 5-4

