

CADILLAC

CREATING A HIGHER STANDARD



DE VILLE

1995 OWNER'S LITERATURE

REPRODUCTION

CADILLAC OWNER

Privileges

3547065

The PENALTY OF LEADERSHIP

IN every field of human endeavor, he that is first must perpetually live in the white light of publicity. ¶ Whether the leadership be vested in a man or in a manufactured product, emulation and envy are ever at work. ¶ In art, in literature, in music, in industry, the reward and the punishment are always the same. ¶ The reward is widespread recognition; the punishment, fierce denial and detraction. ¶ When a man's work becomes a standard for the whole world, it also becomes a target for the shafts of the envious few. ¶ If his work be merely mediocre, he will be left severely alone — if he achieve a masterpiece, it will set a million tongues a-wagging. ¶ Jealousy does not protrude its forked tongue at the artist who produces a commonplace painting. ¶ Whatever you write, or paint, or play, or sing, or build, no one will strive to surpass, or to slander you, unless your work be stamped with the seal of genius. ¶ Long, long after a great work or a good work has been done, those who are disappointed or envious continue to cry out that it can not be done. ¶ Spiteful little voices in the domain of art were raised against our own Whistler as a mountebank, long after the big world had acclaimed him its greatest artistic genius. ¶ Multitudes flocked to Bayreuth to worship at the musical shrine of Wagner, while the little group of those whom he had dethroned and displaced argued angrily that he was no musician at all. ¶ The little world continued to protest that Fulton could never build a steamboat, while the big world flocked to the river banks to see his boat steam by. ¶ The leader is assailed because he is a leader, and the effort to equal him is merely added proof of that leadership. ¶ Failing to equal or to excel, the follower seeks to depreciate and to destroy — but only confirms once more the superiority of that which he strives to supplant. ¶ There is nothing new in this. ¶ It is as old as the world and as old as the human passions — envy, fear, greed, ambition, and the desire to surpass. ¶ And it all avails nothing. ¶ If the leader truly leads, he remains — the leader. ¶ Master-poet, master-painter, master-workman, each in his turn is assailed, and each holds his laurels through the ages. ¶ That which is good or great makes itself known, no matter how loud the clamor of denial. ¶ That which deserves to live — lives.

Cadillac Motor Car Co. Detroit, Mich.



Henry M. Lehman, founder of Cadillac, stands beside the 1905 "Osweta" which was built to evaluate the feasibility of a closed bodied car.



The automobile revolution was made possible by the fact that the automobile was not a single machine but a collection of machines. The automobile was a collection of machines that were designed to work together. The automobile was a collection of machines that were designed to work together.

Henry M. Leland, known as the master of precision, initiated his precision manufacturing techniques at the founding of Cadillac in 1902. His exacting standards prompted the motto by which Cadillac has been guided over the years – "Craftsmanship A Creed – Accuracy A Law."

The introduction of the first four cylinder engine in 1905 led the industry and enabled Cadillacs to travel at speeds up to 50 mph.

For attention to quality and innovation, the Royal Automobile

Club of England awarded the prestigious **Warranted** to Cadillac twice . . .



first in 1908 for achieving perfect interchangeability of parts and again in 1912 for introducing the electric self starter, electric lighting and ignition system.

Cadillac is the only American manufacturer to win this honor and the only manufacturer in the world to win it twice. As commonplace as standardized parts are today, in 1908 parts were still individually hand fitted both in production and service.

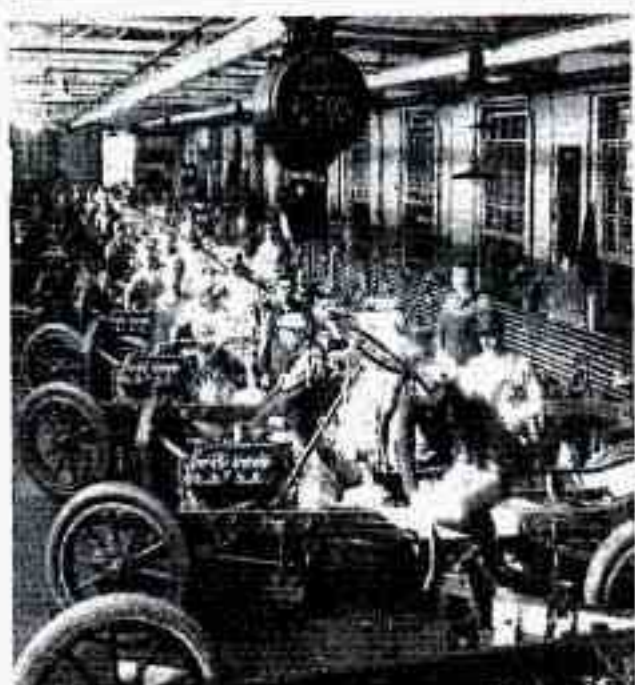
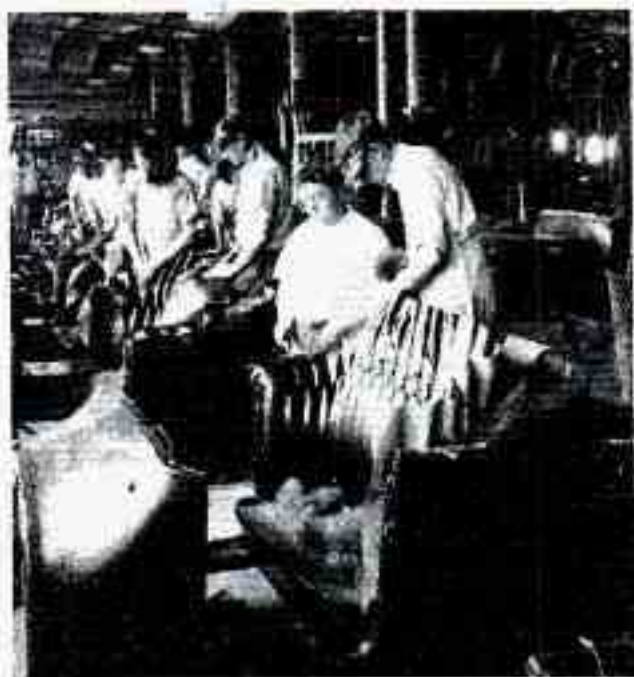
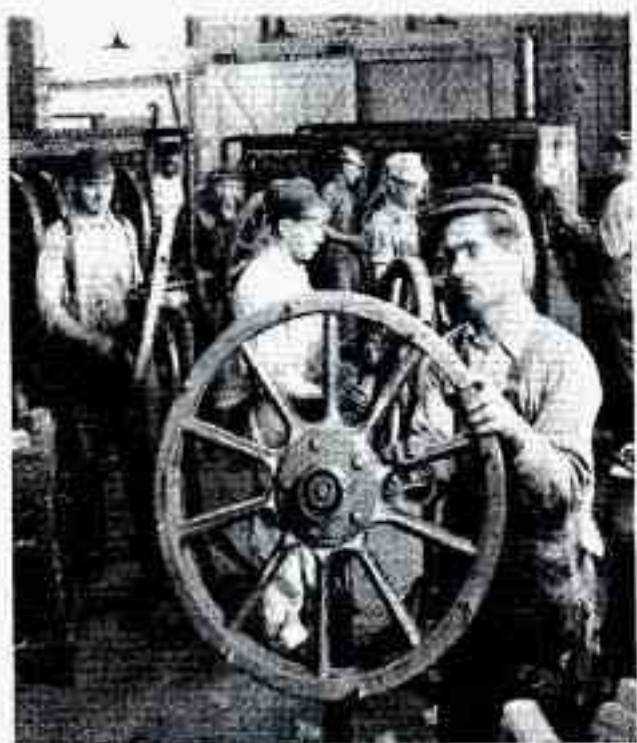

Standardization opened the eyes of the industrial world and was the cornerstone of modern **assembly line** production. From this achievement evolved the reference to Cadillac as "Standard of the World."

In 1909 Cadillac was purchased by the then new General Motors Corporation. Convenience, cleanliness, and all-weather comfort were greatly enhanced in 1910 when Cadillac became the first manufacturer to offer closed bodies as standard equipment.

"The Penalty of Leadership" first appeared in the January 2, 1915 issue of The Saturday Evening Post as an expression of the Cadillac commitment to leadership, quality, and innovation. It is widely regarded as one of the finest documents ever written and was published following the introduction of the first production V8 engine. The V8 was standard in all 1915 model Cadillacs.

Many Cadillac "firsts" have followed over the years, including the synchro-mech clutchless transmission, a nation-wide comprehensive

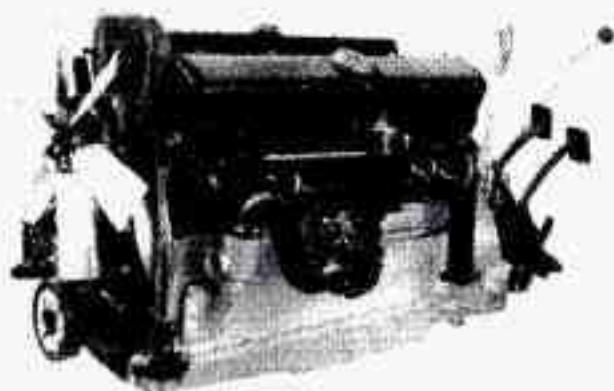

45° V16 Engine

service policy, security plate glass, chrome plating and the first car to be designed by a stylist (1927 LaSalle/Harley Earl). The '30s witnessed production of the smooth and quiet V12 and **V16 engines**. The crisp, contemporary lines of the 1938 60 Special series ushered in a new era in styling.

During World War II, shortly after Pearl Harbor, Cadillac discontinued car production for the first time since 1902 in order to construct light tanks, combat vehicles and internal parts for Allison V1710 engines. Two Cadillac V8 engines and Hydra-Matic transmissions were used in each tank.



1915 Cadillac

Cadillac



It Will Add to Your Happiness!

When you consider the many ways in which a Cadillac can add to your happiness, you will be amazed. With such a fine car, you can enjoy the finest of living. You can enjoy the finest of living. You can enjoy the finest of living. You can enjoy the finest of living.

When you consider the many ways in which a Cadillac can add to your happiness, you will be amazed. With such a fine car, you can enjoy the finest of living. You can enjoy the finest of living. You can enjoy the finest of living. You can enjoy the finest of living.

When you consider the many ways in which a Cadillac can add to your happiness, you will be amazed. With such a fine car, you can enjoy the finest of living. You can enjoy the finest of living. You can enjoy the finest of living. You can enjoy the finest of living.

EXHIBIT NO. 1000111 • 1000111 • 1000111 • 1000111 • 1000111 • 1000111 • 1000111 • 1000111 • 1000111 • 1000111

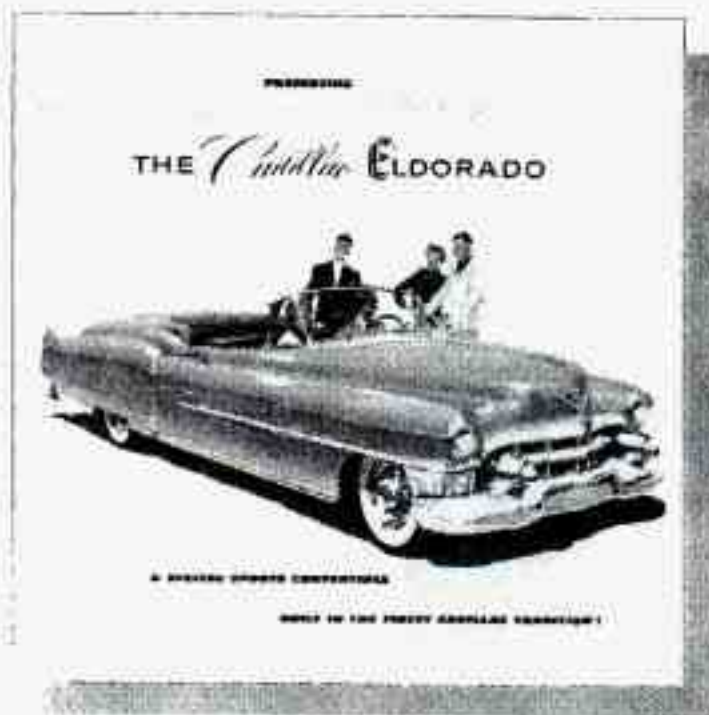

For the 1948 model, Cadillac introduced the **Continental** which set the trend in automotive styling for nearly two decades. This was followed by the 1949 model with the two door hardtop Coupe DeVille and the modern overhead valve, high compression V8 engine.

Engineering innovations, conveniences and styling dominated the '50s and '60s. Cruise control, automatic climate control, tilt and telescoping steering wheels, twilight sentinel and four door hard tops all debuted in these years. In 1957 the Eldorado Brougham featured advances such as air suspension, memory seat, automatic electric door locks, transistor radio, a brushed

stainless steel roof and low profile tires.

Wildcat introduced in 1953, was redesigned for 1967 as the first front wheel drive personal luxury car. The 472 cu. in. V8 engine used in all Cadillacs in 1968 and 1969 was enlarged to 500 cu. in. for all 1970 Eldorados.

An Air Cushion Restraint System (airbag) was available for 1974, 1975 and 1976 Cadillacs.

Analog Electronic Fuel Injection was available, on 1975 Cadillacs and was standard on the new international size 1976 Seville. In 1978, the Trip Computer option incorporated an on-board microprocessor.



1957 Eldorado Brougham

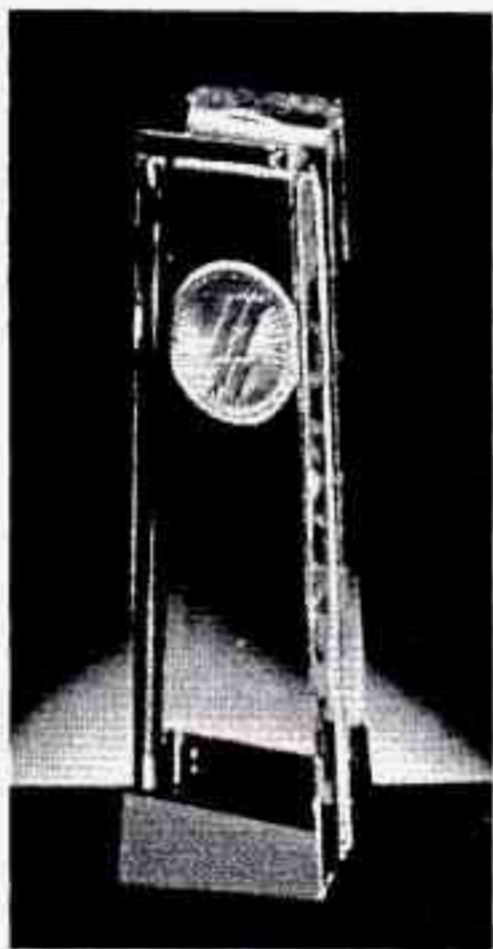

This rich tradition continues into the '90s as Cadillac became the first automobile manufacturer to be awarded the prestigious Malcolm Baldrige National Quality Award.

The 1992 Seville STS was the first car ever to win all three major automotive awards: Car of the Year, Motor Trend; Ten Best List, Car & Driver; Car of the Year, Automobile Magazine.



A 1993 Cadillac Allante in stock technical configuration, was selected as the pace car for the 76th Indianapolis 500. The demanding pace-car performance and handling requirements were met because of such advances as the Northstar system. The system includes the 32 valve, dual overhead camshaft, Northstar 4.6 liter V8 engine, 4T80 E electronically controlled automatic transaxle, road sensing suspension, speed sensitive steering, antilock brakes and traction control.

For more than nine decades Cadillac has been a leader in quality and technical innovation. Now more than ever, substance takes shape

[www.Cadillac.com](http://www.cadillac.com)



1949 COUPE DE VILLE

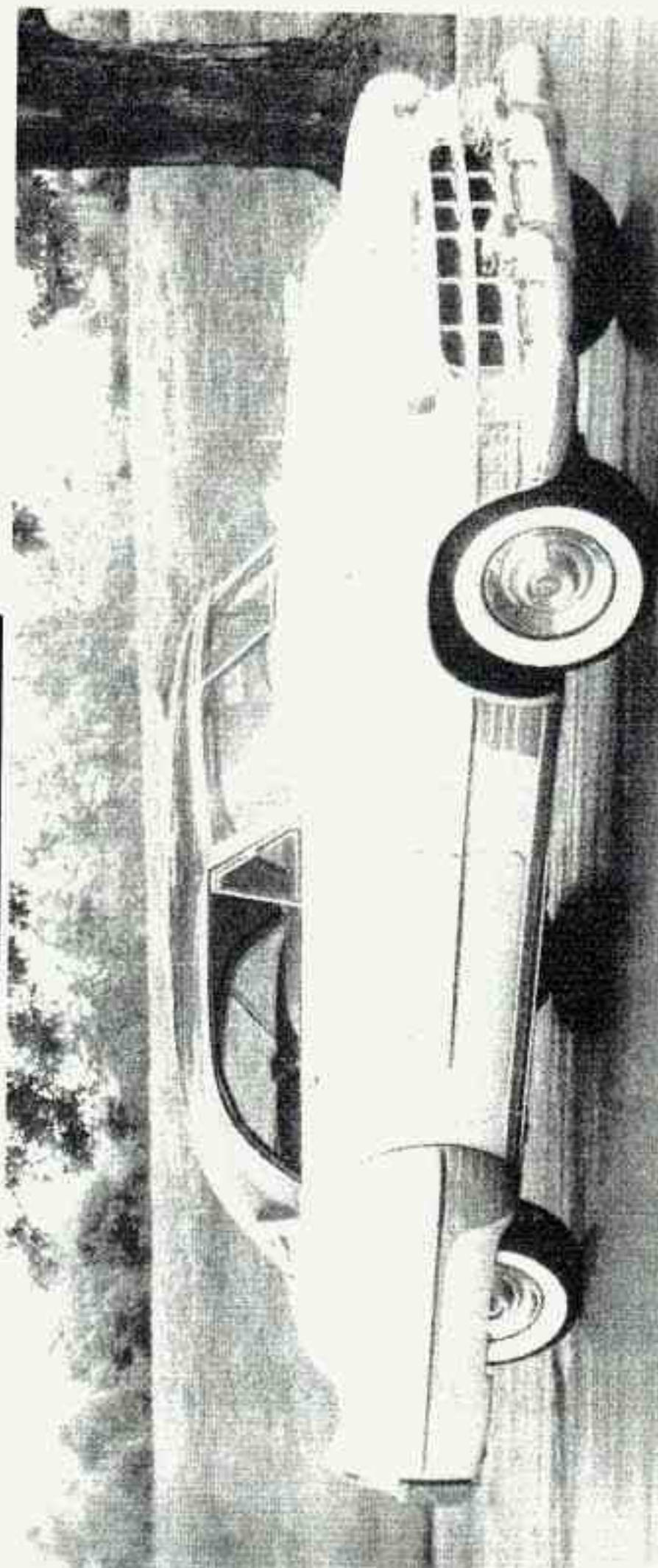

OPERATION AND CARE

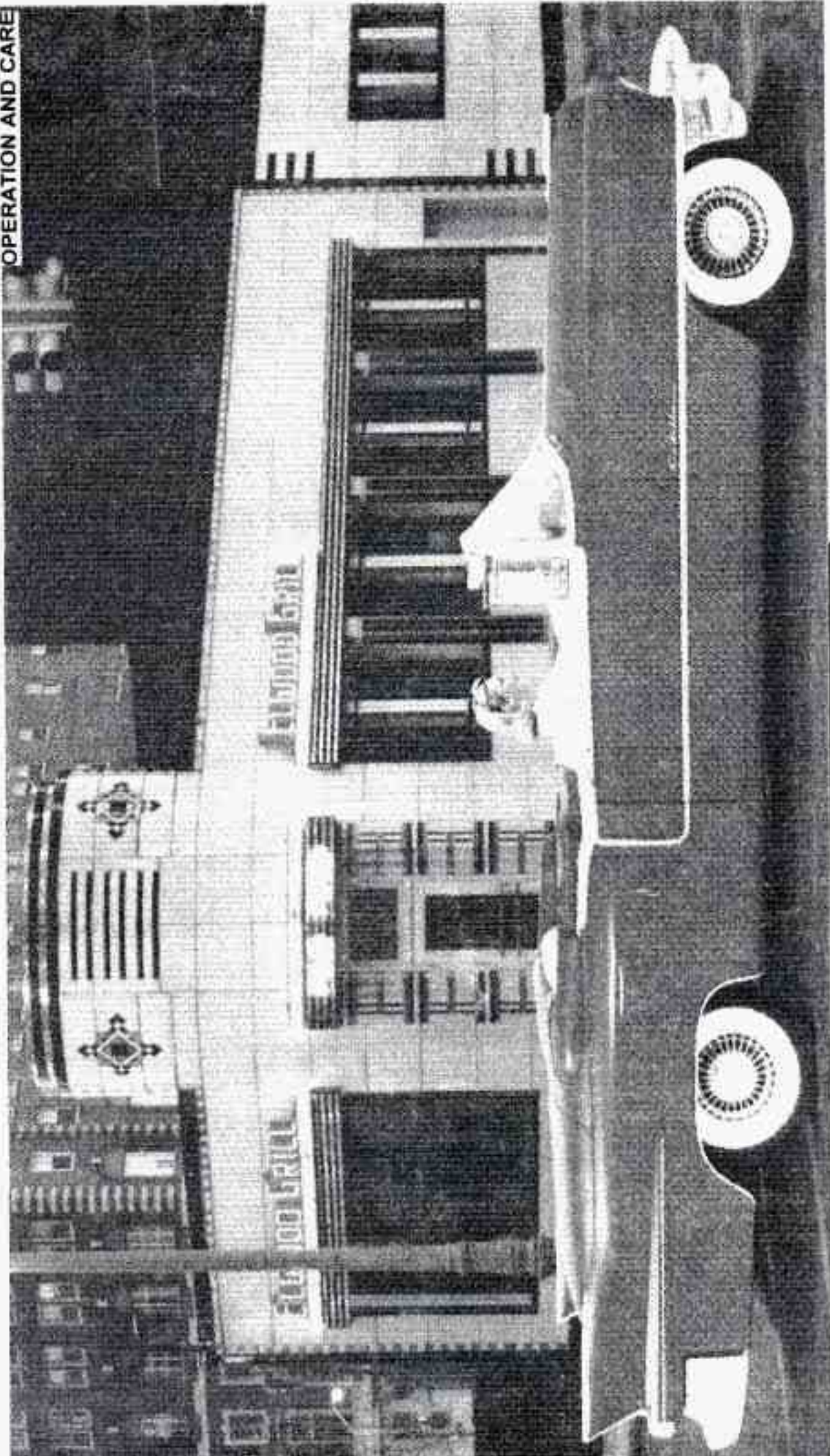

1955 ELDORADO CONVERTIBLE



TABLE OF CONTENTS

This Cadillac Manual is divided into major sections.

Introduction – How to Use this Manual iii

This section tells you how to use your manual and includes safety and vehicle damage warnings and symbols.

Section 1 – Seats and Restraint Systems 1-1

This section tells you how to use your seats and safety belts properly. It also explains the “SIR” system.

Section 2 – Features and Controls 2-1

This section explains how to start and operate your Cadillac.

Section 3 – Comfort Controls and Audio Systems 3-1

This section tells you how to adjust the ventilation and comfort controls and how to operate your audio system.

Section 4 – Your Driving and the Road 4-1

Here you’ll find helpful information and tips about the road and how to drive under different conditions.

Section 5 – Problems on the Road 5-1

This section tells you what to do if you have a problem while driving, such as a flat tire, or engine overheating, etc.

Section 6 – Service and Appearance Care 6-1

Here the manual tells you how to keep your Cadillac running properly and looking good.

For more information on “Reporting Safety Defects”, see Owner Assistance, Page 4.

First Edition



THE 1995 SEDAN DEVILLE LITERATURE



Please keep this manual in your Cadillac, so it will be there if you ever need it when you're on the road. If you sell the vehicle, please leave this manual in it so the new owner can use it.

FOR CANADIAN OWNERS WHO PREFER A FRENCH LANGUAGE MANUAL:

Aux propriétaires canadiens: Vous pouvez vous procurer un exemplaire de ce guide en français chez votre concessionnaire ou au DGN Marketing Services Ltd., 1500 Bonhill Rd., Mississauga, Ontario L5T 1C7.

This manual includes the latest information at the time it was printed. We reserve the right to make changes in the product after that time without further notice. For vehicles first sold in Canada, substitute the name "General Motors of Canada Limited" for Cadillac Motor Car Division whenever it appears in this literature.

GENERAL MOTORS, GM and the GM Emblem, CADILLAC, and the CADILLAC Emblem are registered trademarks of General Motors Corporation.

© Copyright General Motors Corporation 1994. All Rights Reserved.



HOW TO USE THIS MANUAL

Many people read their owner's manual from beginning to end when they first receive their new vehicle. This will help you learn about the features and controls for your vehicle. In this manual, you'll find that pictures and words work together to explain things quickly.

INDEX: A good place to look for what you need is the Index in back of the manual. It's an alphabetical list of all that's in the manual, and the page number where you'll find it.

SAFETY WARNINGS AND SYMBOLS

You will find a number of safety cautions in this book. We use a box with gray background and the word **CAUTION** to tell you about things that could hurt you if you were to ignore the warning.



CAUTION:

These mean there is something that could hurt you or other people.

In the gray caution area, we tell you what the hazard is. Then we tell you what to do to help avoid or reduce the hazard. Please read these cautions. If you don't, you or others could be hurt.

You will also find a circle with a slash through it in this book. This safety symbol means “Don’t,” “Don’t do this,” or “Don’t let this happen.”



Vehicle Damage Warnings

Also, in this book you will find these notices:

NOTICE:

These mean there is something that could damage your vehicle.

In the notice area, we tell you about something that can damage your vehicle. Many times, this damage would not be covered by your warranty, and it could be costly. But the notice will tell you what to do to help avoid the damage.

When you read other manuals, you might see CAUTION and NOTICE warnings in different colors or in different words.

You'll also see warning labels on your vehicle. They use yellow for cautions, blue for notices and the words CAUTION or NOTICE.

Vehicle Symbols

These are some of the symbols you will find on your vehicle. For example, these symbols are used on an original battery:



These symbols are important for you and your passengers whenever your vehicle is driven:



These symbols have to do with your lights:

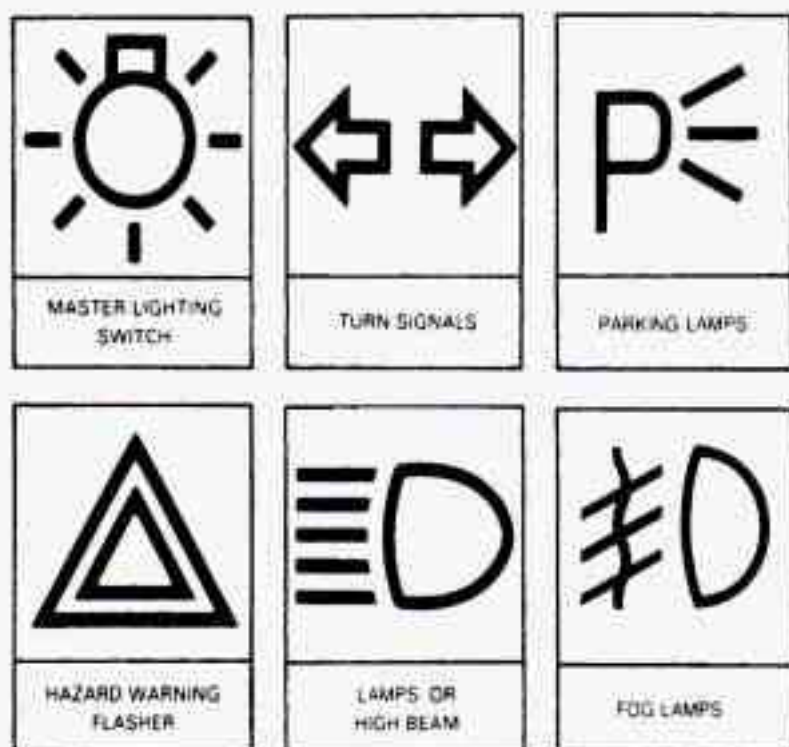

These symbols are on some of your controls:

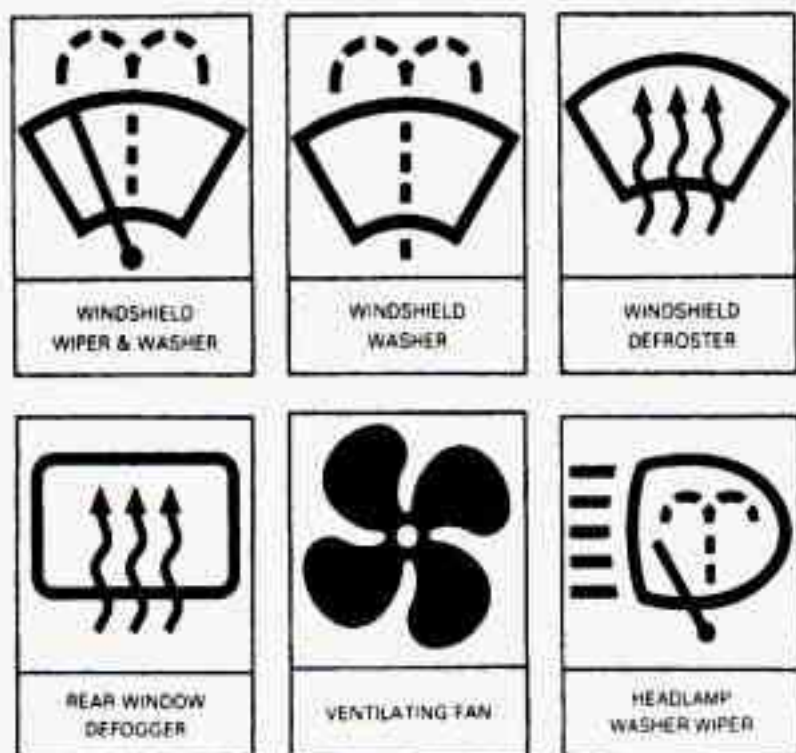

These symbols are used on warning and indicator lights:

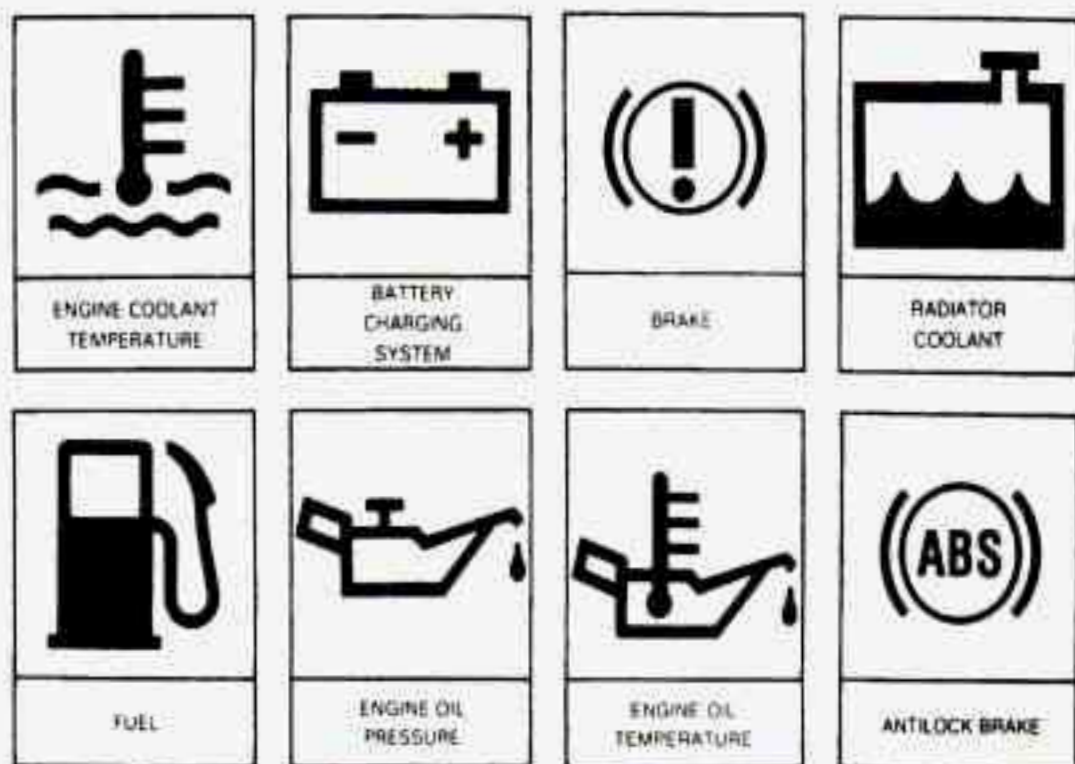

Here are some other symbols you may see:



NOTES



SECTION 1

SEATS AND RESTRAINT SYSTEMS

Here you'll find information about the seats in your Cadillac and how to use your safety belts properly. You can also learn about some things you should *not* do with air bags and safety belts.

SEATS AND SEAT CONTROLS

This section tells you about the seats -- how to adjust them, and also about reclining front seatbacks, heated seats and head restraints.

Power Seat Controls



The power seat control switches are located on the front doors.

The power control switches move the seat forward and backward, up and down, and adjust the angle of the seat.

Seat Adjuster

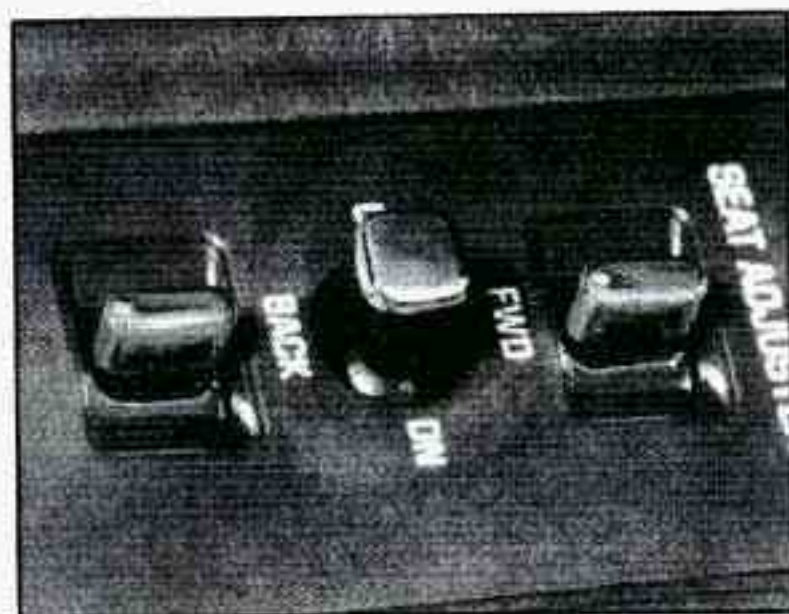

- Pressing the front SEAT ADJUSTER switch tilts the front portion of the seat cushion either up or down.
- Pressing the rear SEAT ADJUSTER switch tilts the rear portion of the seat cushion up or down.

- Moving the center switch either to the UP or DN position moves the entire seat up or down.
- Push the center switch to the FWD or BACK position to move the entire seat forward or rearward.

Reclining Front Seatbacks

Manual Seatback Recliner

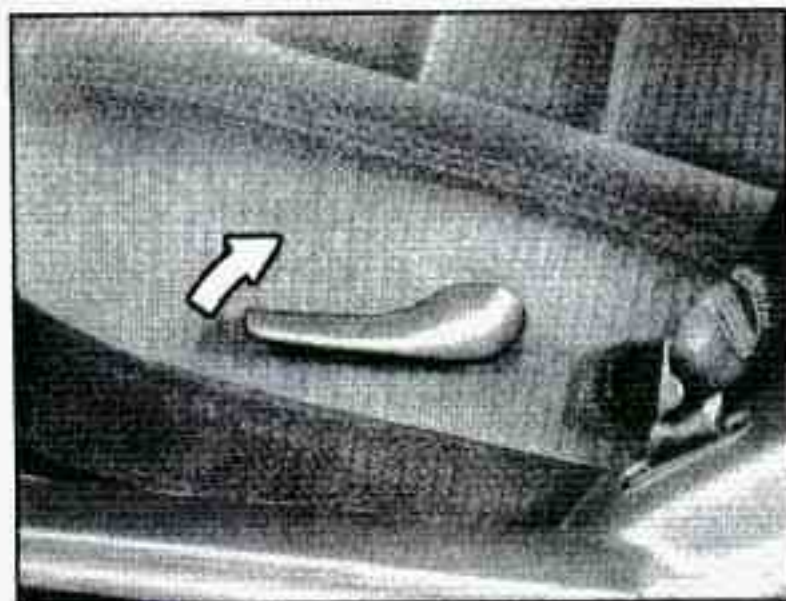

To recline the seatback, lift the lever on the outer side of the front seat and adjust the position of the seatback to where you want it. Release the lever to lock the seatback in place. Pull up on the lever and the seat will return to its full upright position.

Power Seatback Recliner (Option)

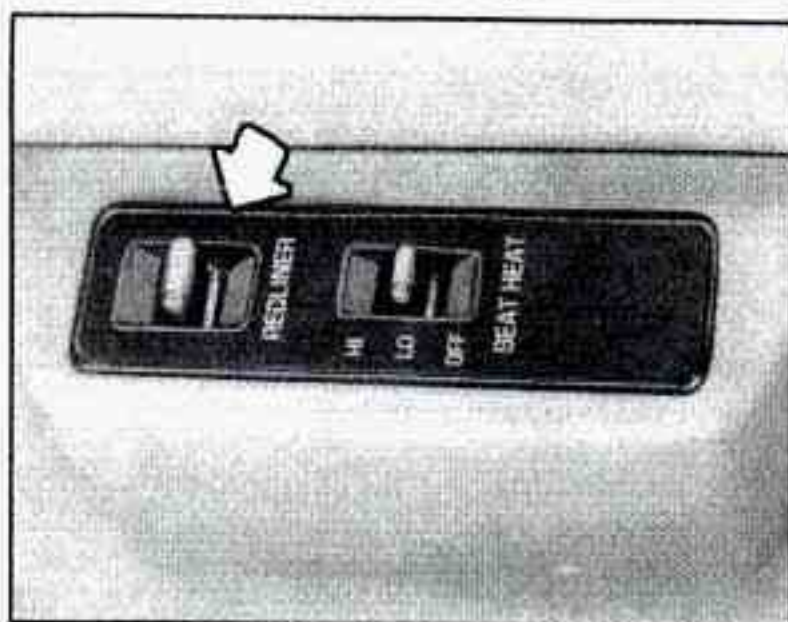

Move the RECLINER switch rearward to recline the seatback and push the switch forward to return the seatback to an upright position.



But don't have a seatback reclined if your vehicle is moving.

⚠ CAUTION:

Sitting in a reclined position when your vehicle is in motion can be dangerous. Even if you buckle up, your safety belts can't do their job when you're reclined like this.

The shoulder belt can't do its job because it won't be against your body. Instead, it will be in front of you. In a crash you could go into it, receiving neck or other injuries.

The lap belt can't do its job either. In a crash the belt could go up over your abdomen. The belt forces would be there, not at your pelvic bones. This could cause serious internal injuries.

For proper protection when the vehicle is in motion, have the seatback upright. Then sit well back in the seat and wear your safety belt properly.

Heated Front Seat Feature (Option)

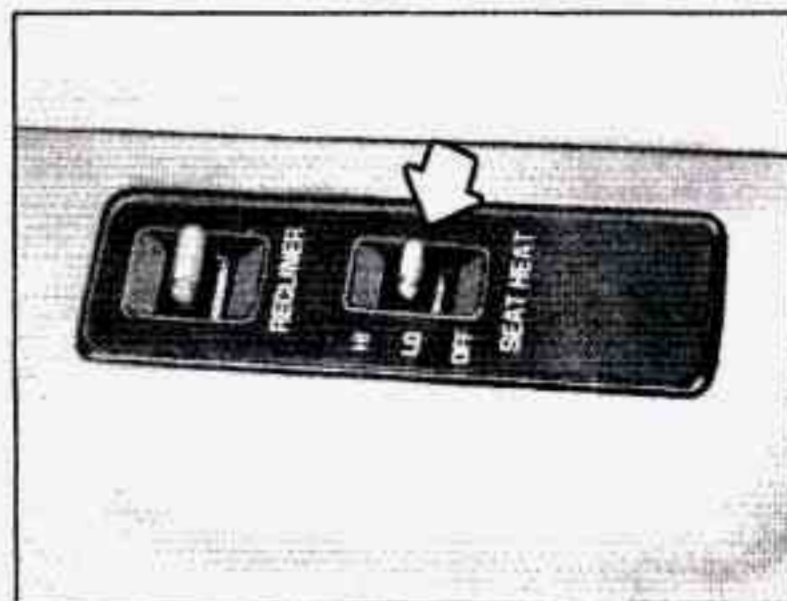

The control panel is located on the outboard side of the front seats.

Move the SEAT HEAT switch to either LO or HI to turn on the heating element in the seat.

This feature is designed primarily for use on damp and chilly days. The LO setting warms the seatback and cushion until the seat approximates body temperature. On colder days, the HI setting heats the seats to an even higher temperature. To prevent uncomfortable overheating of the seats, the heating elements are thermostatically regulated to automatically maintain the temperature at the selected setting. A telltale light in the control switch reminds you that the heating system is in use. To preserve the battery, the heated seats can only be used when the ignition is turned on, and are deactivated when the ignition is turned off.

Head Restraints

Slide the head restraint up or down so that the top of the restraint is closest to the top of your ears. This position reduces the chance of a neck injury in a crash.

SAFETY BELTS: THEY'RE FOR EVERYONE

This part of the manual tells you how to use safety belts properly. It also tells you some things you should not do with safety belts.

And it explains the Supplemental Inflatable Restraint, or "air bag" system.

CAUTION:

Don't let anyone ride where he or she can't wear a safety belt properly. If you are in a crash and you're not wearing a safety belt, your injuries can be much worse. You can hit things inside the vehicle or be ejected from it. You can be seriously injured or killed. In the same crash, you might not be if you are buckled up. Always fasten your safety belt, and check that your passengers' belts are fastened properly too.



Your vehicle has a light that comes on as a reminder to buckle up. (See "Safety Belt Reminder Light" in the Index.)

In many states and Canadian provinces, the law says to wear safety belts. Here's why: *They work.*

You never know if you'll be in a crash. If you do have a crash, you don't know if it will be a bad one.

A few crashes are mild, and some crashes can be so serious that even buckled up a person wouldn't survive. But most crashes are in between. In many of them, people who buckle up can survive and sometimes walk away. Without belts they could have been badly hurt or killed.

After more than 25 years of safety belts in vehicles, the facts are clear. In most crashes buckling up does matter ... a lot!

Why Safety Belts Work

When you ride in or on anything, you go as fast as it goes.

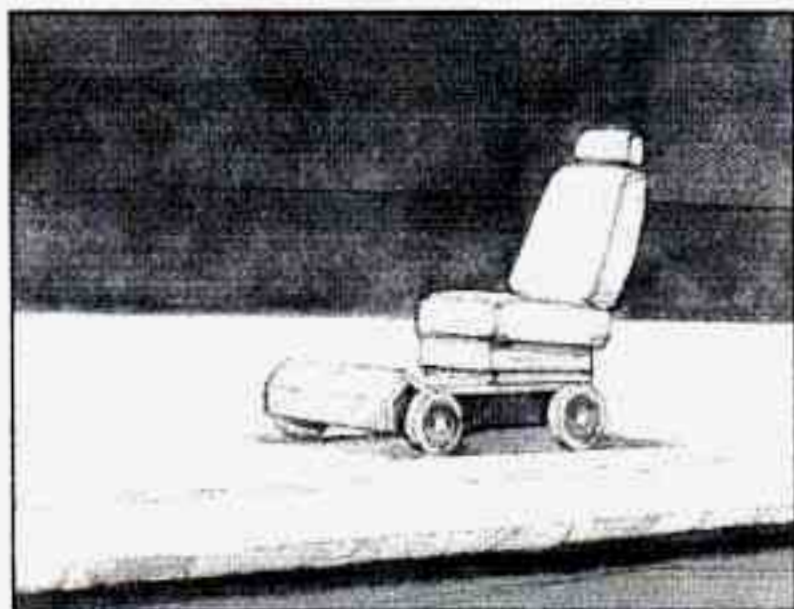

Take the simplest vehicle. Suppose it's just a seat on wheels.

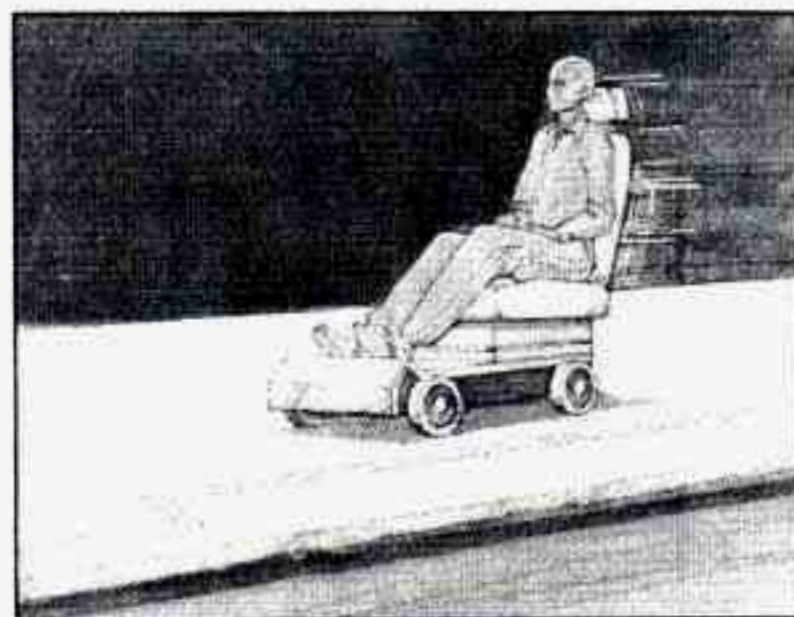

Put someone on it.

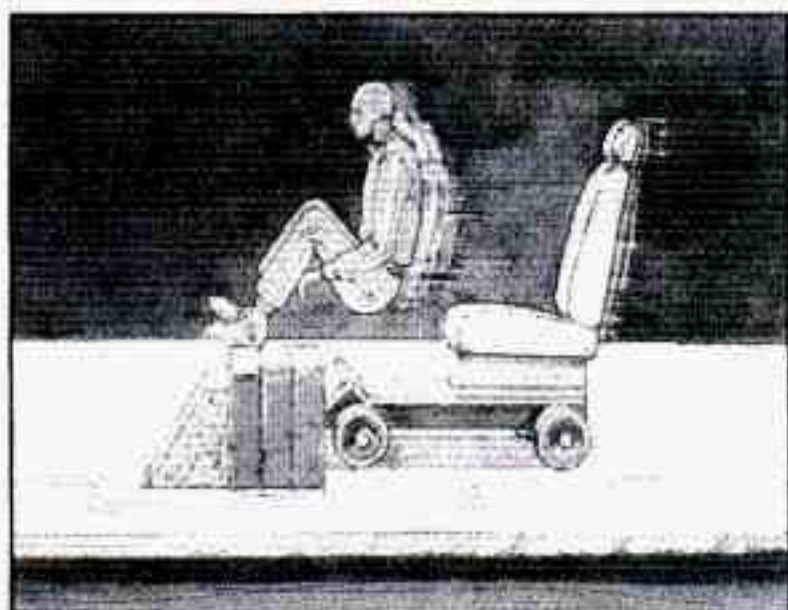

Get it up to speed.
Then stop the vehicle.
The rider doesn't stop.



The person keeps
going until stopped by
something.

In a real vehicle, it
could be the
windshield ...

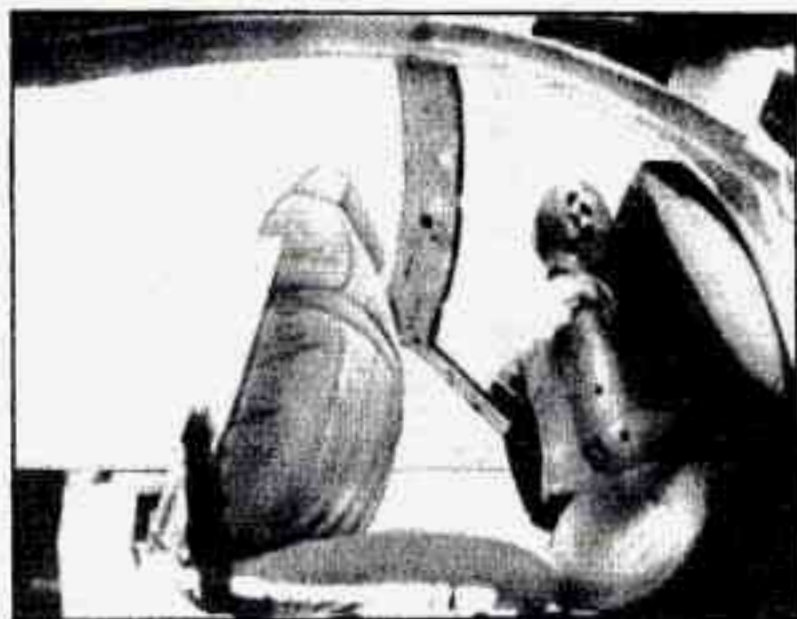

or the instrument panel ...



or the safety belts!

With safety belts, you slow down as the vehicle does. You get more time to stop. You stop over more distance, and your strongest bones take the forces. That's why safety belts make such good sense.

HERE ARE QUESTIONS MANY PEOPLE ASK ABOUT SAFETY BELTS -- AND THE ANSWERS

Q: *Won't I be trapped in the vehicle after an accident if I'm wearing a safety belt?*

A: You *could* be -- whether you're wearing a safety belt or not. But you can unbuckle a safety belt, even if you're upside down. And your chance of being conscious during and after an accident, so you *can* unbuckle and get out, is *much* greater if you are belted.

Q: *Why don't they just put in air bags so people won't have to wear safety belts?*

A: Air bags are in many vehicles today and will be in more of them in the future. But they are supplemental systems only; so they work *with* safety belts -- not instead of them. Every air bag system ever offered for sale has required the use of safety belts. Even if you're in a vehicle that has air bags, you still have to buckle up to get the most protection. That's true not only in frontal collisions, but especially in side and other collisions.

Q: *If I'm a good driver, and I never drive far from home, why should I wear safety belts?*

A: You may be an excellent driver, but if you're in an accident -- even one that isn't your fault -- you and your passengers can be hurt. Being a good driver doesn't protect you from things beyond your control, such as bad drivers.

Most accidents occur within 25 miles (40 km) of home. And the greatest number of serious injuries and deaths occur at speeds of less than 40 mph (65 km/h).

Safety belts are for everyone.

HOW TO WEAR SAFETY BELTS PROPERLY

Adults

This part is only for people of adult size.

Be aware that there are special things to know about safety belts and children. And there are different rules for smaller children and babies. If a child will be riding in your Cadillac, see the part of this manual called "Children." Follow those rules for everyone's protection.

First, you'll want to know which restraint systems your vehicle has.

We'll start with the driver position.

DRIVER POSITION

This part describes the driver's restraint system.

Lap-Shoulder Belt

The driver has a lap-shoulder belt. Here's how to wear it properly.

1. Close and lock the door.
2. Adjust the seat (to see how, see "Seats" in the Index) so you can sit up straight.



3. Pick up the latch plate and pull the belt across you. Don't let it get twisted.

4. Push the latch plate into the buckle until it clicks.

Pull up on the latch plate to make sure it is secure. If the belt isn't long enough, see "Safety Belt Extender" at the end of this section.

Make sure the release button on the buckle is positioned so you would be able to unbuckle the safety belt quickly if you ever had to.

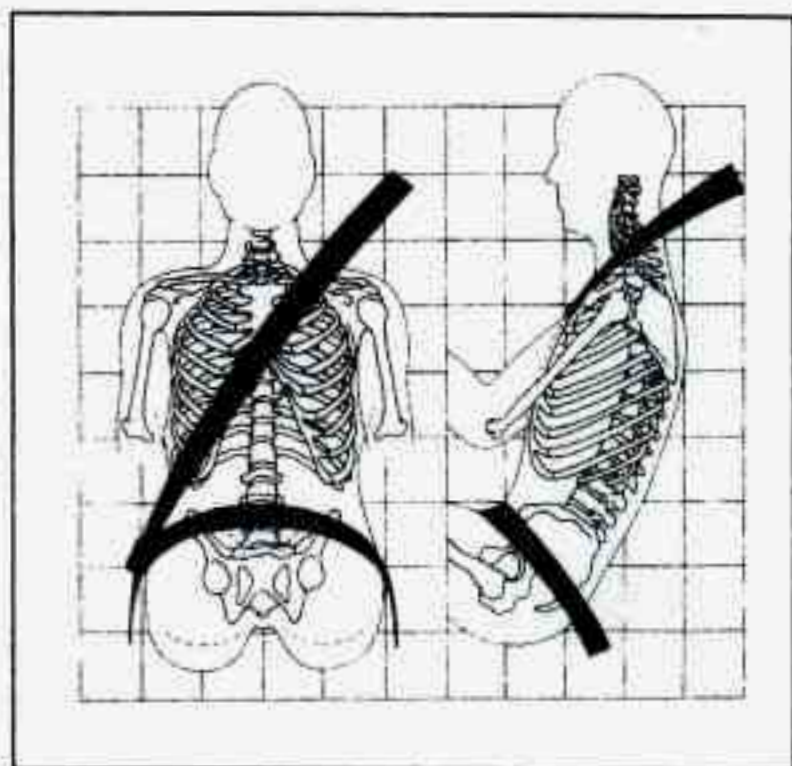

The lap part of the belt should be worn low and snug on the hips, just touching the thighs. In a crash, this applies force to the strong pelvic bones. And you'd be less likely to slide under the lap belt. If you slid under it, the belt would apply force at your abdomen. This could cause serious or even fatal injuries. The shoulder belt should go over the shoulder and across the chest. These parts of the body are best able to take belt restraining forces.

The safety belt locks if there's a sudden stop or crash.

Shoulder Belt Height Adjuster

Before you begin to drive, move the shoulder belt adjuster to the height that is right for you.



To move it down, squeeze the release handle and move the height adjuster to the desired position. You can move the adjuster up just by pushing up on the bottom of the release handle. After you move the adjuster to where you want it, try to move it down without squeezing the release handle to make sure it has locked into position.

Adjust the height so that the shoulder portion of the belt is centered on your shoulder. The belt should be away from your face and neck, but not falling off your shoulder.

Shoulder Belt Tightness Adjustment

Your car has a shoulder belt tightness adjustment feature. If the shoulder belt seems too tight, adjust it before you begin to drive.

1. Sit well back in the seat.
2. Start pulling the shoulder belt out.



3. Just before it reaches the end, give it a quick pull.

4. Let the belt go back all the way. You should hear a slight clicking sound. If you don't, the adjustment feature won't set, and you'll have to start again.



5. Now you can add a small amount of slack. Lean forward slightly, then sit back. If you've added more than 1 inch (25 mm) of slack, pull the shoulder belt out as you did before and start again.

If you move around in the vehicle enough, or if you pull out the shoulder belt, the belt will become tight again. If this happens, you can reset it.

Q: What's wrong with this?

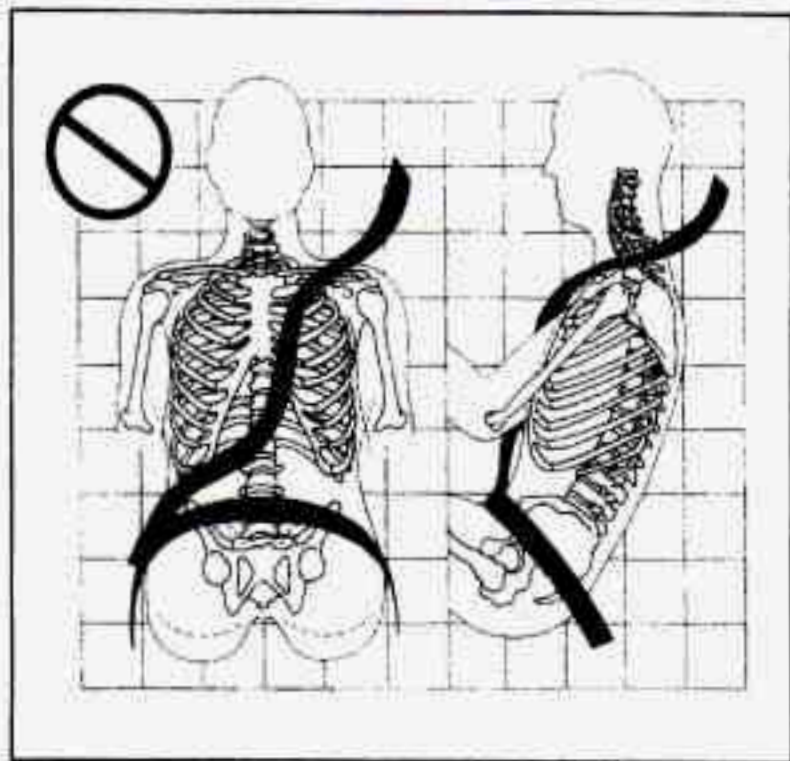

A: The shoulder belt is too loose. It won't give nearly as much protection this way.

⚠ CAUTION:

You can be seriously hurt if your shoulder belt is too loose. In a crash you would move forward too much, which could increase injury. The shoulder belt should fit against your body. Don't allow more than 1 inch (25 mm) of slack.

Q: What's wrong with this?

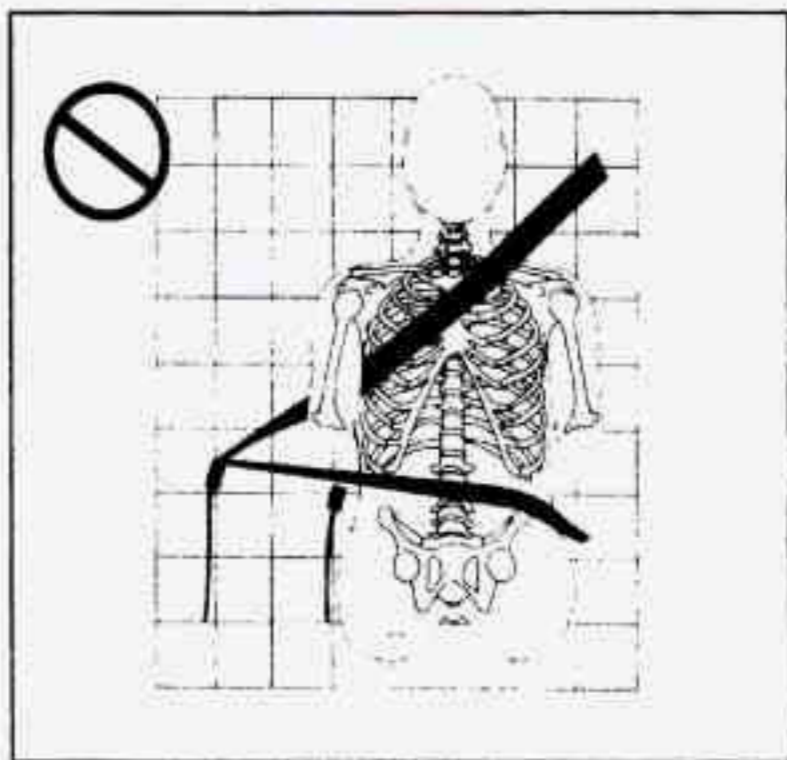

A: The belt is buckled in the wrong place.



CAUTION:

You can be seriously injured if your belt is buckled in the wrong place like this. In a crash, the belt would go up over your abdomen. The belt forces would be there, not at the pelvic bones. This could cause serious internal injuries. Always buckle your belt into the buckle nearest you.

Q: What's wrong with this?

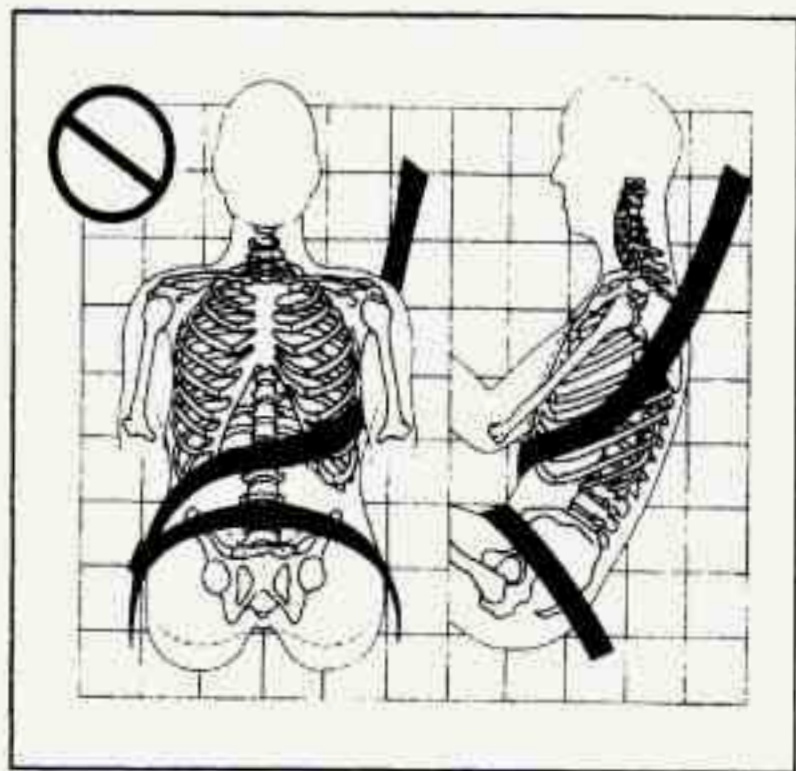

A: The shoulder belt is worn under the arm. It should be worn over the shoulder at all times.



CAUTION:

You can be seriously injured if you wear the shoulder belt under your arm. In a crash, your body would move too far forward, which would increase the chance of head and neck injury. Also, the belt would apply too much force to the ribs, which aren't as strong as shoulder bones. You could also severely injure internal organs like your liver or spleen.

Q: What's wrong with this?

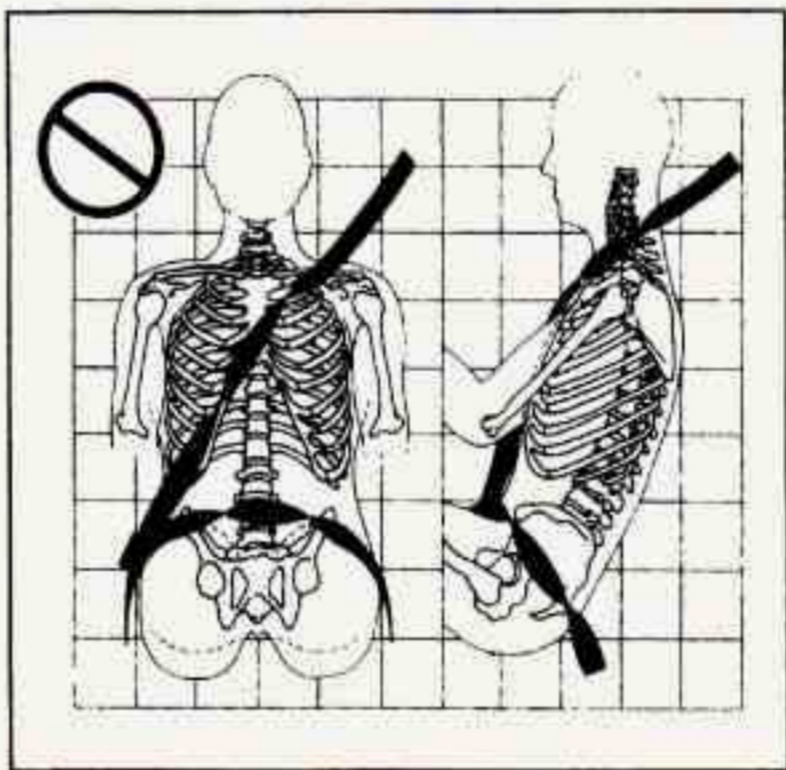

A: The belt is twisted across the body.

 **CAUTION:**

You can be seriously injured by a twisted belt. In a crash, you wouldn't have the full width of the belt to spread impact forces. If a belt is twisted, make it straight so it can work properly, or ask your dealer to fix it.

To unlatch the belt, just push the button on the buckle. The belt should go back out of the way.



Before you close the door, be sure the belt is out of the way. If you slam the door on it, you can damage both the belt and your vehicle.

SUPPLEMENTAL INFLATABLE RESTRAINT SYSTEM (SIR)

This part explains the Supplemental Inflatable Restraint (SIR), or air bag, system.

Your Cadillac has two air bags -- one air bag for the driver and another air bag for the right front passenger.

Here are the most important things to know about the air bag system:

 **CAUTION:**

You can be severely injured or killed in a crash if you aren't wearing your safety belt -- even if you have an air bag. Wearing your safety belt during a crash helps reduce your chance of hitting things inside the vehicle or being ejected from it. The air bag is only a "supplemental restraint." That is, it works with safety belts but doesn't replace them. Air bags are designed to work only in moderate to severe crashes where the front of your vehicle hits something. They aren't designed to inflate at all in rollover, rear, side, or low-speed frontal crashes. Everyone in your vehicle, including the driver, should wear a safety belt properly -- whether or not there's an air bag for that person.

 **CAUTION:**

Air bags inflate with great force, faster than the blink of an eye. If you're too close to an inflating air bag, it could seriously injure you. Safety belts help keep you in position for an air bag inflation in a crash. Always wear your safety belt, even with an air bag. The driver should sit as far back as possible while still maintaining control of the vehicle.



CAUTION:

An inflating air bag can seriously injure small children. Always secure children properly in your vehicle. To read how, see the part of this manual called "Children" and the caution label on the right front passenger's safety belt.



AIR BAG

There is an air bag readiness light on the instrument panel, which shows AIR BAG. The system checks the air bag's electrical system for malfunctions. The light tells you if there is an electrical problem. See "Air Bag Readiness Light" in the Index for more information.

How the Air Bag System Works



Where is the air bag?

The driver's air bag is in the middle of the steering wheel. The right front passenger's air bag is in the instrument panel on the passenger's side.



CAUTION:

Don't put anything on, or attach anything to, the steering wheel or instrument panel. Also, don't put anything (such as pets, or objects) between any occupant and the steering wheel or instrument panel. If something is between an occupant and an air bag, it could affect the performance of the air bag -- or worse, it could cause injury.

When should an air bag inflate?

The air bag is designed to inflate in moderate to severe frontal or near-frontal crashes. The air bag will inflate only if the impact speed is above the system's designed "threshold level." If your vehicle goes straight into a wall that doesn't move or deform, the threshold level is about 9 to 15 mph (14 to 24 km/h). The threshold level can vary, however, with specific vehicle design, so that it can be somewhat above or below this range. If your vehicle strikes something that will move or deform, such as a parked car, the threshold level will be higher. The air bag is not designed to inflate in rollovers, side impacts, or rear impacts, because inflation would not help the occupant.

In any particular crash, no one can say whether an air bag should have inflated simply because of the damage to a vehicle or because of what the repair costs were. Inflation is determined by the angle of the impact and the vehicle's deceleration. Vehicle damage is only one indication of this.

What makes an air bag inflate?

In a frontal or near-frontal impact of sufficient severity, the air bag sensing system detects that the vehicle is suddenly stopping as a result of a crash. The sensing system triggers a chemical reaction of the sodium azide sealed in the inflator. The reaction produces nitrogen gas, which inflates the air bag. The inflator, air bag, and related hardware are all part of the air bag modules packed inside the steering wheel and in the instrument panel in front of the right front passenger.

How does an air bag restrain?

In moderate to severe frontal or near-frontal collisions, even belted occupants can contact the steering wheel or the instrument panel. The air bag supplements the protection provided by safety belts. Air bags distribute the force of the impact more evenly over the occupant's upper body, stopping the occupant more gradually. But air bags would not help you in many types of collisions, including rollovers and rear and side impacts, primarily because an occupant's motion is not toward the air bag. Air bags should never be regarded as anything more than a supplement to safety belts, and then only in moderate to severe frontal or near-frontal collisions.

What will you see after an air bag inflates?

After the air bag inflates, it quickly deflates. This occurs so quickly that some people may not even realize the air bag inflated. Some components of the air bag module in the steering wheel hub for the driver's air bag, or the instrument panel for the right front passenger's bag, will be hot for a short time, but the part of the bag that comes into contact with you will not be hot to the touch. There will be some smoke and dust coming from vents in the deflated air bags. Air bag inflation will not prevent the driver from seeing or from being able to steer the vehicle, nor will it stop people from leaving the vehicle.



CAUTION:

When an air bag inflates, there is dust in the air. This dust could cause breathing problems for people with a history of asthma or other breathing trouble. To avoid this, everyone in the vehicle should get out as soon as it is safe to do so. If you have breathing problems but can't get out of the vehicle after an air bag inflates, then get fresh air by opening a window or door.

In many crashes severe enough to inflate an air bag, windshields are broken by vehicle deformation. Additional windshield breakage may also occur from the right front passenger air bag.

- The air bags are designed to inflate only once. After they inflate, you'll need some new parts for your air bag system. If you don't get them, the air bag system won't be there to help protect you in another crash. A new system will include air bag modules and possibly other parts. The service manual for your vehicle covers the need to replace other parts.
- Your vehicle is equipped with a diagnostic module, which records information about the air bag system. The module records information about the readiness of the system, when the sensors are activated and driver's safety belt usage at deployment.
- Let only qualified technicians work on your air bag system. Improper service can mean that your air bag system won't work properly. See your dealer for service.

NOTICE:

If you damage the cover for the driver's or the right front passenger's air bag, they may not work properly. You may have to replace the air bag module in the steering wheel or both the air bag module and the instrument panel for the right front passenger's air bag. Do not open or break the air bag covers.

Servicing Your Air Bag-Equipped Cadillac

Air bags affect how your Cadillac should be serviced. There are parts of the air bag system in several places around your vehicle. You don't want the system to inflate while someone is working on your vehicle. Your Cadillac dealer and the 1995 DeVille Service Manual have information about servicing your vehicle and the air bag system. To purchase a service manual, see "Service Publications" in the Index.

The air bag system does not need regular maintenance.



CAUTION:

For up to 10 seconds after the ignition key is turned off and the battery is disconnected, an air bag can still inflate during improper service. You can be injured if you are close to an air bag when it inflates. Avoid wires wrapped with yellow tape, or yellow connectors. They are probably part of the air bag system. Be sure to follow proper service procedures, and make sure the person performing work for you is qualified to do so.

SAFETY BELT USE DURING PREGNANCY

Safety belts work for everyone, including pregnant women. Like all occupants, they are more likely to be seriously injured if they don't wear safety belts.

A pregnant woman should wear a lap-shoulder belt, and the lap portion should be worn as low as possible throughout the pregnancy.

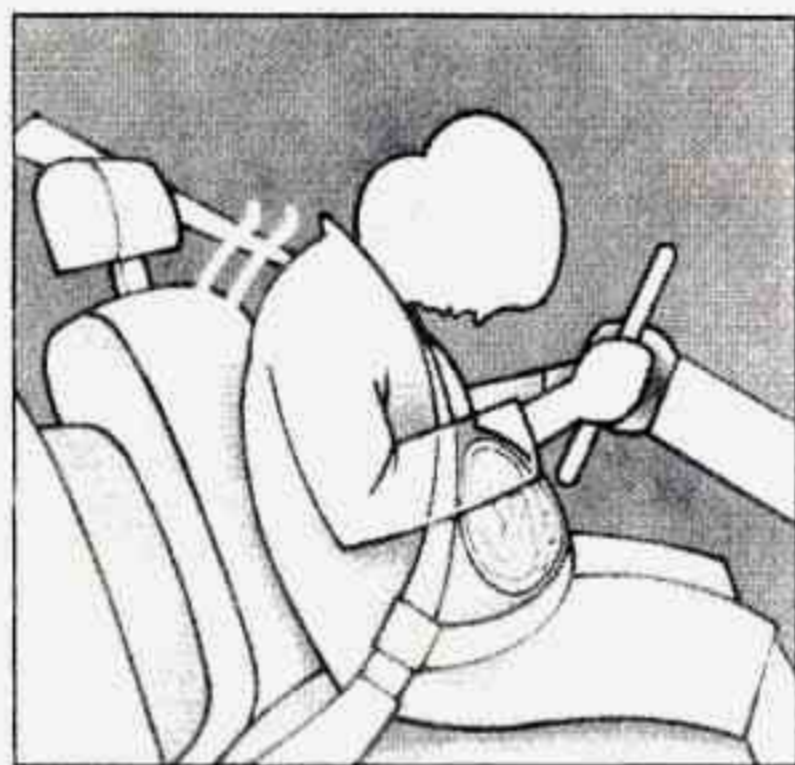

The best way to protect the fetus is to protect the mother. When a safety belt is worn properly, it's more likely that the fetus won't be hurt in a crash. For pregnant women, as for anyone, the key to making safety belts effective is wearing them properly.

RIGHT FRONT PASSENGER POSITION

The right front passenger's safety belt works the same way as the driver's safety belt. See "Driver Position," earlier in this section.

When the lap portion of the belt is pulled out all the way, it will lock. If it does, let it go back all the way and start again.

Be sure to use the correct buckle when buckling your lap-shoulder belt. If you find that the latch plate will not go fully into the buckle, see if you are using the buckle for the center passenger position.

CENTER PASSENGER POSITION

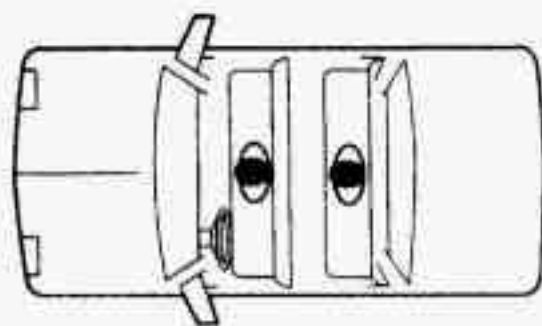

Lap Belt

If your vehicle has a front split seat and a rear bench seat, someone can sit in the center positions.



When you sit in a center seating position, you have a lap safety belt, which has no retractor. To make the belt longer, tilt the latch plate and pull it along the belt.



To make the belt shorter, pull its free end as shown until the belt is snug.

Buckle, position and release it the same way as the lap part of a lap-shoulder belt. If the belt isn't long enough, see "Safety Belt Extender" at the end of this section.

Make sure the release button on the buckle is positioned so you would be able to unbuckle the safety belt quickly if you ever had to.

REAR SEAT PASSENGERS

It's very important for rear seat passengers to buckle up! Accident statistics show that unbelted people in the rear seat are hurt more often in crashes than those who are wearing safety belts.

Rear passengers who aren't safety belted can be thrown out of the vehicle in a crash. And they can strike others in the vehicle who are wearing safety belts.

Rear Seat Outside Passenger Positions

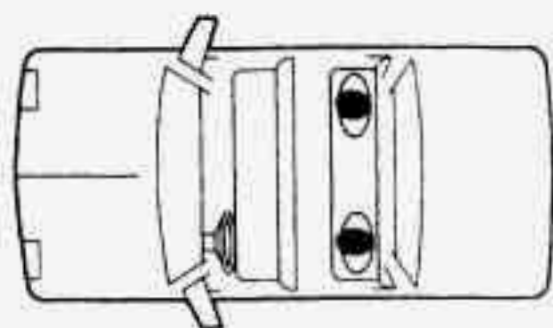

Lap-Shoulder Belt

The positions next to the windows have lap-shoulder belts. Here's how to wear one properly.



1. Pick up the latch plate and pull the belt across you. Don't let it get twisted.

The shoulder belt may lock if you pull the belt across you very quickly. If this happens, let the belt go back slightly to unlock it. Then pull the belt across you more slowly.

2. Push the latch plate into the buckle until it clicks.



If the belt stops before it reaches the buckle, tilt the latch plate and keep pulling until you can buckle it.

Pull up on the latch plate to make sure it is secure.

If the belt is not long enough, see "Safety Belt Extender" at the end of this section. Make sure the release button on the buckle is positioned so you would be able to unbuckle the safety belt quickly if you ever had to.



3. To make the lap part tight, pull down on the buckle end of the belt as you pull up on the shoulder part.

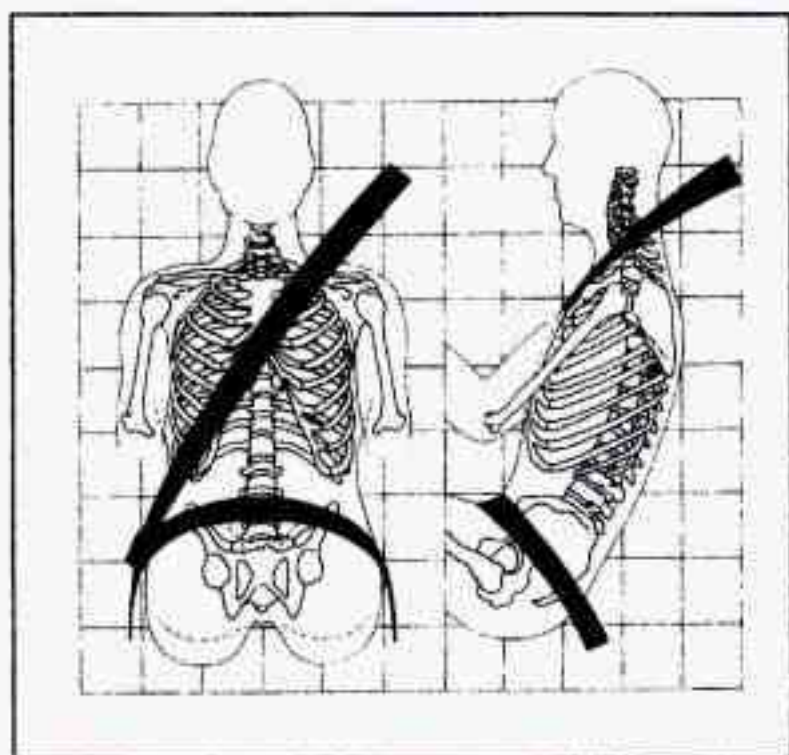

The lap part of the belt should be worn low and snug on the hips, just touching the thighs. In a crash, this applies force to the strong pelvic bones. And you'd be less likely to slide under the lap belt. If you slid under it, the belt would apply force at your abdomen. This could cause serious or even fatal injuries. The shoulder belt should go over the shoulder and across the chest. These parts of the body are best able to take belt restraining forces.

The safety belt locks if there's a sudden stop or a crash, or if you pull the belt very quickly out of the retractor.

⚠ CAUTION:

You can be seriously hurt if your shoulder belt is too loose. In a crash you would move forward too much, which could increase injury. The shoulder belt should fit against your body.



To unlatch the belt, just push the button on the buckle.

CHILDREN

Everyone in a vehicle needs protection! That includes infants and all children smaller than adult size. In fact, the law in every state in the United States and in every Canadian province says children up to some age must be restrained while in a vehicle.

Smaller Children and Babies

 **CAUTION:**

Smaller children and babies should always be restrained in a child or infant restraint. The instructions for the restraint will say whether it is the right type and size for your child. A very young child's hip bones are so small that a regular belt might not stay low on the hips, as it should. Instead, the belt will likely be over the child's abdomen. In a crash the belt would apply force right on the child's abdomen, which could cause serious or fatal injuries. So, be sure that any child small enough for one is always properly restrained in a child or infant restraint.



 **CAUTION:**

Never hold a baby in your arms while riding in a vehicle. A baby doesn't weigh much -- until a crash. During a crash a baby will become so heavy you can't hold it. For example, in a crash at only 25 mph (40 km/h), a 12-pound (5.5 kg) baby will suddenly become a 240-pound (110 kg) force on your arms. The baby would be almost impossible to hold.

Secure the baby in an infant restraint.

CHILD RESTRAINTS

Be sure to follow the instructions for the restraint. You may find these instructions on the restraint itself or in a booklet, or both. These restraints use the belt system in your vehicle, but the child also has to be secured within the restraint to help reduce the chance of personal injury. The instructions that come with the infant or child restraint will show you how to do that.

Where to Put the Restraint

Accident statistics show that children are safer if they are restrained in the rear rather than the front seat. We at General Motors therefore recommend that you put your child restraint in the rear seat. *Never* put a rear-facing child restraint in the front passenger seat. Here's why:

 **CAUTION:**

A child in a rear-facing child restraint can be seriously injured if the right front passenger's air bag inflates. This is because the back of a rear-facing child restraint would be very close to the inflating air bag. Always secure a rear-facing child restraint in the rear seat.

You may, however, secure a forward-facing child restraint in the right front seat. Before you secure a forward-facing child restraint, always move the front passenger seat as far back as it will go. Or, secure the child restraint in the rear seat.

 **CAUTION:**

A child in a child restraint in the center front seat can be badly injured by the passenger air bag if it inflates. Never use a child restraint in the center front seat. It's always better to secure a child restraint in the rear seat. You may, however, secure a forward-facing child restraint in the right front passenger seat, but only with the seat moved all the way back.

Wherever you install it, be sure to secure the child restraint properly.

Keep in mind that an unsecured child restraint can move around in a collision or sudden stop and injure people in the vehicle. Be sure to properly secure any child restraint in your vehicle -- even when no child is in it.

Top Strap

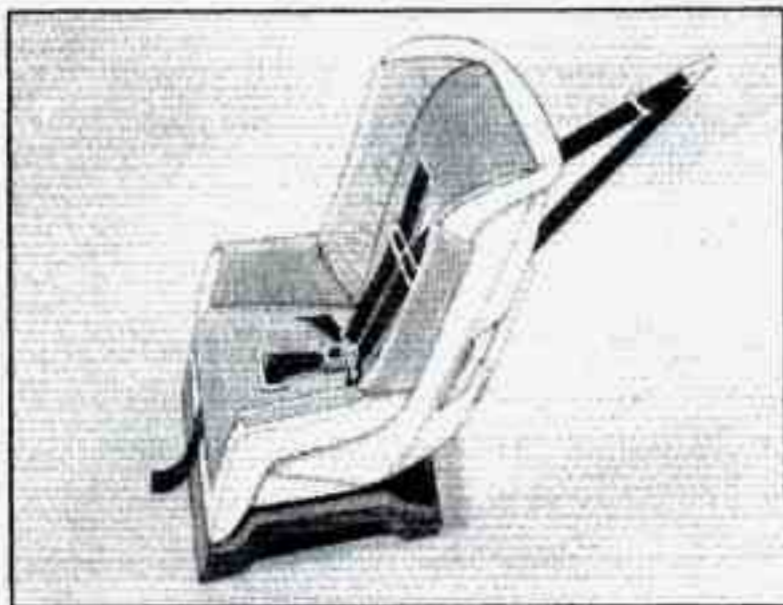

If your child restraint has a top strap, it should be anchored.

If you need to have an anchor installed, you can ask your Cadillac dealer to put it in for you. If you want to install an anchor yourself, your dealer can tell you how to do it.

For cars first sold in Canada, child restraints with a top strap must be anchored according to Canadian Law.

Your dealer can obtain the hardware kit and install it for you, or you may install it yourself using the instructions provided in the kit.

Use the tether hardware kit available from the dealer. The hardware and installation instructions were specifically designed for this vehicle.

Securing a Child Restraint in a Rear Outside Seat Position

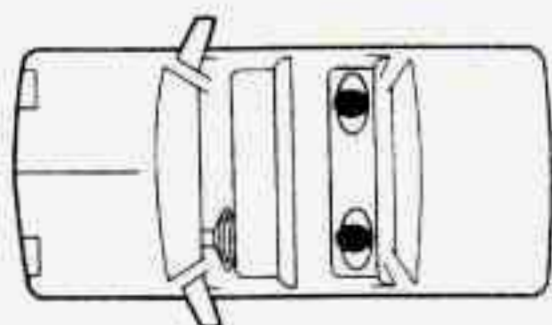

You'll be using the lap-shoulder belt. See the earlier part about the top strap if the child restraint has one.

1. Put the restraint on the seat. Follow the instructions for the child restraint.
2. Secure the child in the child restraint as the instructions say.
3. Pick up the latch plate, and run the lap and shoulder portions of the vehicle's safety belt through or around the restraint. The child restraint instructions will show you how. Tilt the latch plate to adjust the belt if needed.

If the shoulder belt goes in front of the child's face or neck, put it behind the child restraint.



4. Buckle the belt. Make sure the release button is positioned so you would be able to unbuckle the safety belt quickly if you ever had to.

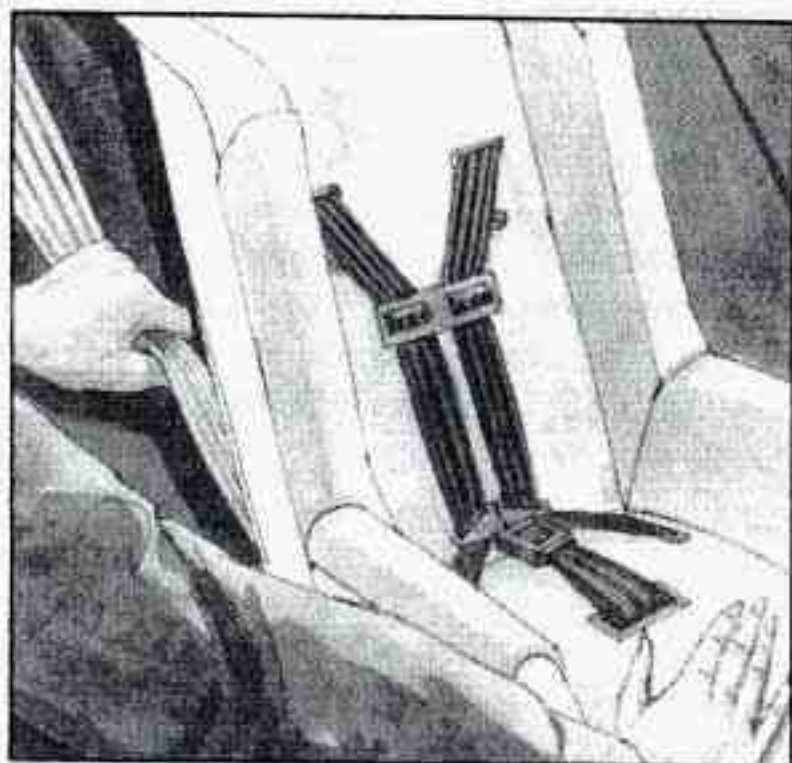

5. To tighten the belt, pull up on the shoulder belt while you push down on the child restraint.

6. Push and pull the child restraint in different directions to be sure it is secure.

To remove the child restraint, just unbuckle the vehicle's safety belt and let it go back all the way. The safety belt will move freely again and be ready to work for an adult or larger child passenger.

Securing a Child Restraint in the Center Rear Seat Position

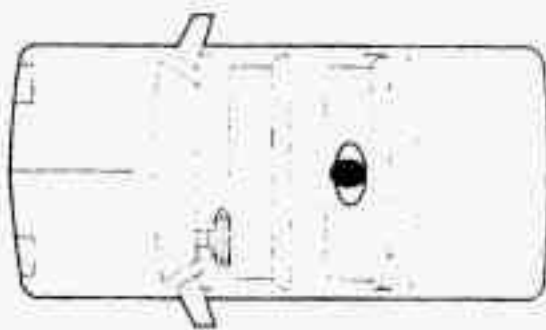

You'll be using the lap belt.

⚠ CAUTION:

A child in a child restraint in the center front seat can be badly injured by the right front passenger air bag if it inflates. Never secure a child restraint in the center front seat. It's always better to secure a child restraint in the rear seat. You may, however, secure a forward-facing child restraint in the right front passenger seat, but only with the seat moved all the way back.

See the earlier part about the top strap if the child restraint has one.

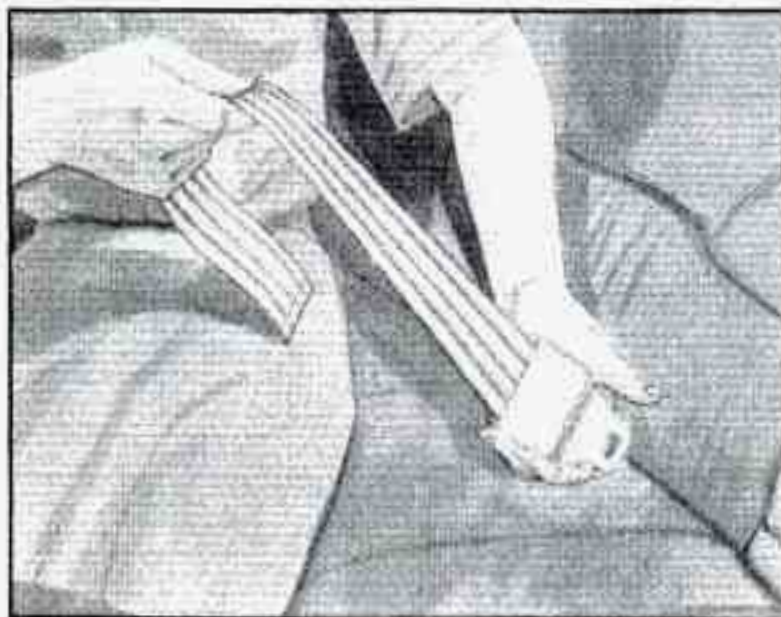

1. Make the belt as long as possible by tilting the latch plate and pulling it along the belt.

2. Put the restraint on the seat. Follow the instructions for the child restraint.
3. Secure the child in the child restraint as the instructions say.

4. Run the vehicle's safety belt through or around the restraint. The child restraint instructions will show you how.



5. Buckle the belt. Make sure the release button is positioned so you would be able to unbuckle the safety belt quickly if you ever had to.

6. To tighten the belt, pull its free end while you push down on the child restraint.
7. Push and pull the child restraint in different directions to be sure it is secure. If the child restraint isn't secure, turn the latch plate over and buckle it again. Then see if it is secure. If it isn't, secure the restraint in a different place in the vehicle and contact the child restraint maker for their advice about how to attach the child restraint properly.

To remove the child restraint, just unbuckle the vehicle's safety belt. It will be ready to work for an adult or larger child passenger.

Securing a Child Restraint in the Right Front Seat Position

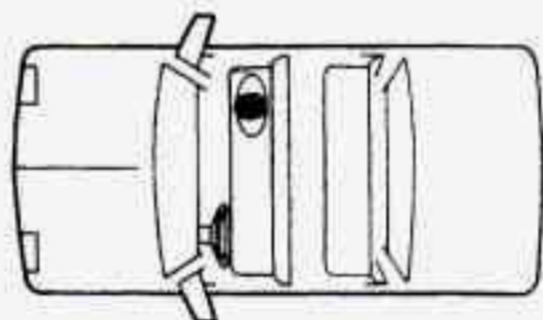

Your vehicle has a right front passenger air bag. *Never* put a rear-facing child restraint in this seat. Here's why:

⚠ CAUTION:

A child in a rear-facing child restraint can be seriously injured if the right front passenger's air bag inflates. This is because the back of a rear-facing child restraint would be very close to the inflating air bag. Always secure a rear-facing child restraint in the rear seat.

You'll be using the lap-shoulder belt. See the earlier part about the top strap if the child restraint has one.

1. Because your vehicle has a right front passenger air bag, always move the seat as far back as it will go before securing a forward-facing child restraint. (See "Seats" in the Index.)
2. Put the restraint on the seat. Follow the instructions for the child restraint.
3. Secure the child in the child restraint as the instructions say.



4. Pick up the latch plate, and run the lap and shoulder portions of the vehicle's safety belt through or around the restraint. The child restraint instructions will show you how.

If the shoulder belt goes in front of the child's face or neck, put it behind the child restraint.

5. Buckle the belt.

Make sure the release button is positioned so you would be able to unbuckle the safety belt quickly if you ever had to.



6. Pull the rest of the lap belt all the way out of the retractor to set the lock.



7. To tighten the belt, feed the lap belt back into the retractor while you push down on the child restraint.

8. Push and pull the child restraint in different directions to be sure it is secure.

To remove the child restraint, just unbuckle the vehicle's safety belt and let it go back all the way.

The safety belt will move freely again and be ready to work for an adult or larger child passenger.

Larger Children



Children who have outgrown child restraints should wear the vehicle's safety belts.

If you have the choice, a child should sit next to a window so the child can wear a lap-shoulder belt and get the additional restraint a shoulder belt can provide.

Accident statistics show that children are safer if they are restrained in the rear seat. But they need to use the safety belts properly.

- Children who aren't buckled up can be thrown out in a crash.
- Children who aren't buckled up can strike other people who are.



⚠ CAUTION:

Never do this.

Here two children are wearing the same belt. The belt can't properly spread the impact forces. In a crash, the two children can be crushed together and seriously injured. A belt must be used by only one person at a time.

Q: What if a child is wearing a lap-shoulder belt, but the child is so small that the shoulder belt is very close to the child's face or neck?

A: Move the child toward the center of the vehicle, but be sure that the shoulder belt still is on the child's shoulder, so that in a crash the child's upper body would have the restraint that belts provide. If the child is so small that the shoulder belt is still very close to the child's face or neck, you might want to place the child in the center seat position, the one that has only a lap belt.



⚠ CAUTION:

Never do this.

Here a child is sitting in a seat that has a lap-shoulder belt, but the shoulder part is behind the child. If the child wears the belt in this way, in a crash the child might slide under the belt. The belt's force would then be applied right on the child's abdomen. That could cause serious or fatal injuries.

Wherever the child sits, the lap portion of the belt should be worn low and snug on the hips, just touching the child's thighs. This applies belt force to the child's pelvic bones in a crash.

SAFETY BELT EXTENDER

If the vehicle's safety belt will fasten around you, you should use it.

But if a safety belt isn't long enough to fasten, your dealer will order you an extender. It's free. When you go in to order it, take the heaviest coat you will wear, so the extender will be long enough for you. The extender will be just for you, and just for the seat in your vehicle that you choose. Don't let someone else use it, and use it only for the seat it is made to fit. To wear it, just attach it to the regular safety belt.

CHECKING YOUR RESTRAINT SYSTEMS

Now and then, make sure all your belts, buckles, latch plates, retractors, anchorages and reminder systems are working properly. Look for any other loose or damaged restraint system parts. If you see anything that might keep a restraint system from doing its job, have it repaired.

Torn or frayed belts may not protect you in a crash. They can rip apart under impact forces. If a belt is torn or frayed, get a new one right away.

REPLACING SEAT AND RESTRAINT SYSTEM PARTS AFTER A CRASH

If you've had a crash, do you need new belts?

After a very minor collision, nothing may be necessary. But if the belts were stretched, as they would be if worn during a more severe crash, then you need new belts.

If belts are cut or damaged, replace them. Collision damage also may mean you will need to have safety belt or seat parts repaired or replaced. New parts and repairs may be necessary even if the belt wasn't being used at the time of the collision.



SECTION 2

FEATURES AND CONTROLS

Here you can learn about the many standard and optional features on your Cadillac, and information on starting, shifting and braking. Also explained are the instrument panel and the warning systems that tell you if everything is working properly -- and what to do if you have a problem.

KEYS



CAUTION:

Leaving young children in a vehicle with the ignition key is dangerous for many reasons. A child or others could be badly injured or even killed.

They could operate power windows or other controls or even make the vehicle move. If they turned the ignition to ON and moved the shift lever out of PARK (P), that would release the parking brake. Don't leave the keys in a vehicle with young children.



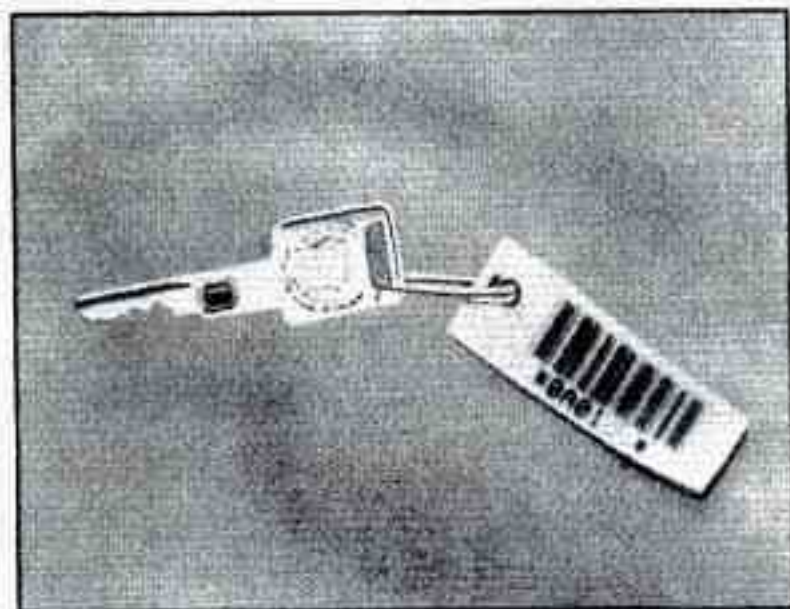

The square key is for the ignition only. It has a resistor pellet which is part of the vehicle's PASS-Key II[®] system.

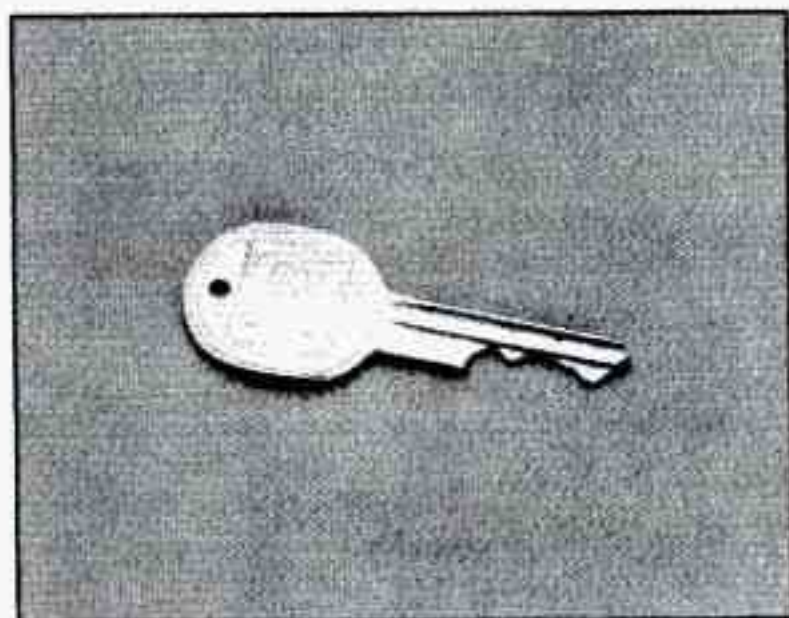

The oval is for the doors and all other locks.

When your new Cadillac is delivered, the dealer removes the plug from the door key. The plug has a code on it that tells the dealer or a qualified locksmith how to make extra keys. However, the ignition key does not have the knockout plug. The ignition key has a bar code tag attached to it. Your dealer or qualified locksmith, by reading the bar code tag, can then make your ignition key.

There are 15 alternative ignition PASS-Key II[®] blanks to help discourage theft. Keep the bar code tag and the door key plugs in a safe place. If you ever lose your keys, you will be able to have new ones made easily using the plug or the bar code tag.

NOTICE:

Your Cadillac has a number of new features that can help prevent theft. But you can have a lot of trouble getting into your vehicle if you ever lock your keys inside. You may even have to damage your vehicle to get in. So be sure you have extra keys.

DOOR LOCKS



CAUTION:

Unlocked doors can be dangerous.

Passengers -- especially children -- can easily open the doors and fall out. When a door is locked, the inside handle won't open it.

Outsiders can easily enter through an unlocked door when you slow down or stop your vehicle.

This may not be so obvious: You increase the chance of being thrown out of the vehicle in a crash if the doors aren't locked. Wear safety belts properly, lock your doors, and you will be far better off whenever you drive your vehicle.

There are several ways to lock and unlock your vehicle:



From the outside, use your door key.

If your vehicle has the optional Theft Deterrent System and it is armed, unlock the doors only with the key or Keyless Entry System. This will avoid setting off the alarm.

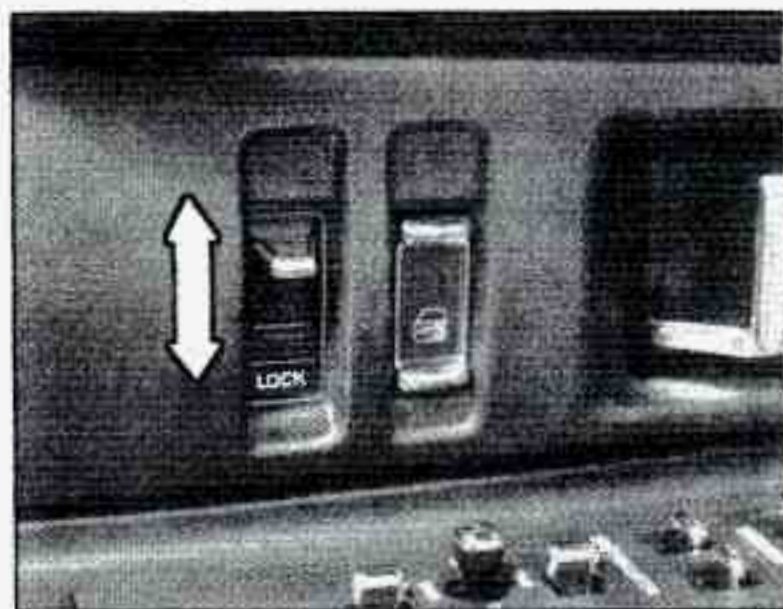

To lock the door from the inside, slide the lock lever down.

To unlock the door, slide the lock lever up.

Power Door Locks



Press the power door lock switch to lock or unlock all the doors at once. The rear power door lock switches only provide a lock function as a safety feature. They will not unlock the doors.

Automatic Door Locks

Just close your doors and turn on the ignition. Every time you move your shift lever out of PARK (P) all of the doors will lock. Your doors will unlock every time you stop and move your shift lever back into PARK (P). If someone needs to get out while you're not in PARK (P), have that person use the manual or power lock. When the door is closed again, it will not lock automatically. Just use the manual or power lock to lock the door again.

You can also have this feature changed where the doors will stay locked when you shift back into PARK (P). Ask your dealer for details.

Rear Door Security Locks

Your Cadillac is equipped with rear door security locks that help prevent passengers from opening the rear doors of your car from the inside. To use this lock:



1. Move the lever on the door all the way up to the ENGAGED position.
2. Close the door.
3. Do the same thing to the other rear door lock.

The rear doors of your vehicle cannot be opened from the inside when this feature is in use.

When you want to open a rear door when the security lock is on:

1. Unlock the door from the inside.
2. Then open the door from the outside.

To cancel the rear door lock:

1. Unlock the door from the inside and open the door from the outside.
2. Move the lever all the way down.
3. Do the same for the other rear door.

The rear door locks will now work normally.

Leaving Your Vehicle

If you are leaving the vehicle, open the door, set the locks from inside, get out and close the door.

Central Door Unlocking System (Option)

Your vehicle will have this feature if it is equipped with the optional Theft Deterrent system. When unlocking either door, you can unlock the other doors by holding the key in the turned position for a few seconds.

Anti-Lockout Feature

Your vehicle is equipped with this feature. If you leave the key in the ignition whether in the ACCESSORY, LOCK or OFF position with the driver's door open, you cannot lock your vehicle using the power locks. If you close the door, you can lock it using the Keyless Entry System. It is always recommended that you remove your ignition key when locking your vehicle.

The Anti-Lockout feature is disabled when the ignition is on.

Illuminated Entry System

Your illuminated entry system turns on all the courtesy lamps when any door is opened or if you press the Remote Keyless Entry (RKE) button. The courtesy lamps will go out approximately 20 seconds after the last door is closed, only if the RKE button is pressed.

KEYLESS ENTRY SYSTEM

With this feature you can turn on your interior lamps, lock and unlock your doors, or unlock your trunk from up to 30 feet (9 meters) using the key chain transmitter supplied with your vehicle.

Your Keyless Entry System is intended to be used as a supplementary vehicle entry device. It is not intended to replace, but rather should be used in conjunction with a door lock key. It operates on a radio frequency subject to Federal Communications Commission (FCC) Rules.

This device complies with Part 15 of the FCC Rules. Operation is subject to the following two conditions: (1) This device may not cause harmful interference, and (2) This device must accept any interference received, including interference that may cause undesired operation.

Should interference to this system occur, try this:

- Check to determine if battery replacement is necessary. See the instructions on battery replacement.
- Check the distance. You may be too far from your vehicle. This product has a maximum range.
- Check the location. Other vehicles or objects may be blocking the signal.
- See your Cadillac dealer or a qualified technician for service.

Changes or modifications to this system by other than an authorized service facility could void authorization to use this equipment.

Operation



- Press this symbol to unlock the driver's door. Press it again within five seconds to unlock the other doors. Pressing this button will also disarm the optional Theft Deterrent System and turn on the interior lamps.



- Press this symbol to lock your doors. This also arms the optional Theft Deterrent System.



- Press this symbol to open the trunk.



- Press this button to turn on the interior lamps only.

Matching Transmitter(s) To Your Vehicle

Each key chain transmitter is coded to prevent another transmitter from unlocking your vehicle. If a transmitter is lost or stolen, a replacement can be purchased through your dealer. Remember to bring any remaining transmitters with you when you go to your dealer. When the dealer matches the replacement transmitter to your vehicle, the remaining transmitters must also be matched. Once the new transmitter is coded, the lost transmitter will not unlock your vehicle.

You can match a transmitter to as many different vehicles as you own, provided they are equipped with *exactly the same model system*. (General Motors offers several different models of these systems on their vehicles.) Each vehicle can have only two transmitters matched to it.

See your dealer to match transmitters to another vehicle.

Battery Replacement

Under normal use, the batteries in your key chain transmitter should last about two years.

You can tell the batteries are weak if the transmitter won't work at the normal range in any location. If you have to get close to your vehicle before the transmitter works, it's probably time to change the batteries.

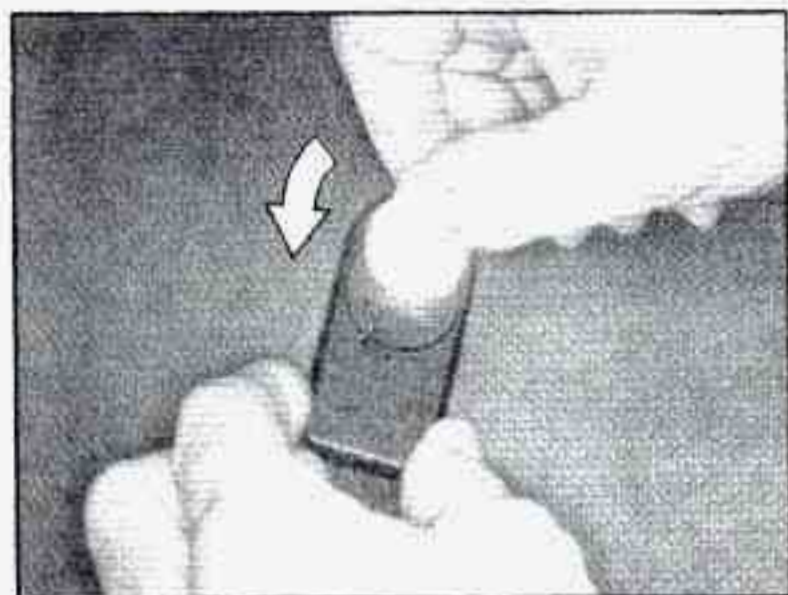

1. Use the round end of the door key, or a coin to rotate the cover counterclockwise $1/16$ of a turn.



2. Remove the battery and replace with CR2025 or an equivalent. Using the wrong size battery can damage the transmitter.



3. Make sure the battery is positioned with the "plus" (+) sign facing the cover.



4. Align the notches on the cover and the transmitter. Rotate the cover clockwise to reinstall.

AUTOMATIC PULL-DOWN FEATURE

⚠ CAUTION:

Your car has an automatic pull-down feature that helps close the trunk electronically. Your fingers can be trapped under the trunk lid as it goes down. Your fingers could be injured, and you would need someone to help you free them. Keep your fingers away from the trunk lid as you close it and as it is going down.

NOTICE:

Don't slam your trunk lid down. If you slam it, you can damage the pull-down system.

Trunk Security Override



Inside the glove box is an override switch that is useful if you want to leave valuables in the trunk when using a commercial parking lot.

Press the VALET button to disable the Remote Trunk Release button. Then lock your glove box with the door key. If you have your door key with you, this will help keep someone from getting into your trunk. Press the button again to make the power trunk release button usable.

You can still use your Keyless Entry transmitter to open the trunk even if the override button is pressed in.

Remote Trunk Release



You'll find this button in the Headlamp Control Panel. Press this button to release the trunk lid. The shift lever has to be in PARK (P) and the ignition in the RUN position or in the Retained Accessory Power mode.

CAUTION:

It can be dangerous to drive with the trunk lid open because carbon monoxide (CO) gas can come into your vehicle. You can't see or smell CO. It can cause unconsciousness and even death.

If you must drive with the trunk lid open or if electrical wiring or other cable connections must pass through the seal between the body and the trunk lid:

- Make sure all windows are shut.
- Turn the fan on your heating or cooling system to its highest speed with the setting on between 65° F (18° C) and 85° F (29° C). That will force outside air into your vehicle. See "Comfort Controls" in the Index.
- If you have air outlets on or under the instrument panel, open them all the way.

See "Engine Exhaust" in the Index.

FRONT STORAGE ARMREST

The front armrest opens into a storage area. To open it lift the front edge.

Inside you will find storage for tapes or CD's, a coinholder and a cupholder that flips forward for use.

REAR STORAGE ARMREST

Your vehicle is also equipped with a rear seat flip-up armrest which includes a storage compartment for tapes or CD's and a dual cupholder that flips forward for use. To open, lift the front edge.

GLOVE BOX

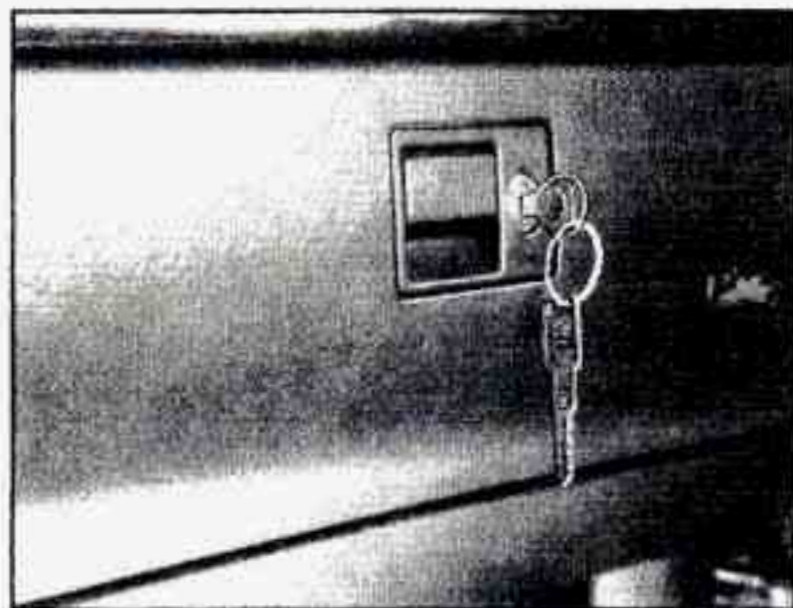

The glove box is directly in front of the front passenger seat. To lock the glove box door, insert the oval key into the lock cylinder and turn it clockwise a quarter turn and remove the key. The key may be removed in the locked or unlocked position. To unlock the door, turn the key counterclockwise and remove the key.

THEFT

Vehicle theft is big business, especially in some cities. Although your Cadillac has a number of theft deterrent features, we know that nothing we put on it can make it impossible to steal. However, there are ways you can help.

Key in the Ignition

If you walk away from your vehicle with the keys inside, it's an easy target for joy riders or professional thieves -- so don't do it.

When you park your Cadillac and open the driver's door, you'll hear a chime reminding you to remove your key from the ignition and take it with you. Always do this. Your steering wheel will be locked, and so will your ignition and transaxle. And remember to lock the doors.

Parking at Night

Park in a lighted spot, close all windows and lock your vehicle. Remember to keep your valuables out of sight. Put them in a storage area, or take them with you.

Parking Lots

If you park in a lot where someone will be watching your vehicle, it's best to lock it up and take your keys. But what if you have to leave your ignition key? What if you have to leave something valuable in your vehicle?

- Put your valuables in a storage area, like your trunk or glove box.
- Lock the glove box.
- Lock all the doors except the driver's.
- Then take the door key with you.

THEFT DETERRENT (OPTION)

SECURITY

If your Cadillac has this option, it has a Theft Deterrent Alarm System. With this system, the SECURITY light will flash as you open the door (if your ignition is off).

This light reminds you to arm the Theft Deterrent system. Here's how to do it:

1. Open the door.
2. Lock the door using the power door lock switch or Keyless Entry System. The SECURITY light should come on and stay on.
3. Close all doors. The SECURITY light should go off.

If a door or the trunk is opened without the key or Keyless Entry System, the alarm will go off. It will also go off if the trunk lock is damaged. Your vehicle's lamps will flash and the horn will sound for three minutes and then the alarm will go off to save battery power.

Remember, the Theft Deterrent system won't arm if you lock the doors with a key or use the manual door lock. It arms only if you use a power door lock switch or Keyless Entry System.

Here's how to avoid setting off the alarm by accident:

- If you don't want to arm the Theft Deterrent system, the vehicle should be locked with the door key *after* the doors are closed.
- Always unlock a door with a key or use the Keyless Entry System. Unlocking a door any other way will set off the alarm.

If you set off the alarm by accident, unlock any door with your key. You can also turn off the alarm by using the Keyless Entry System. The alarm won't stop if you try to unlock a door any other way.

How to Test the Alarm

1. From inside the vehicle roll down your window, then get out of your vehicle, keeping the door open.
2. From outside the vehicle with the door open, lock the vehicle using the power door lock or the Keyless Entry System and close the door.
3. Reach in and unlock the door using the manual lock and open the door. The horn will sound and your headlamps will flash.

If the alarm does not sound when it should, check to see if the horn works. The horn fuse may be blown. To replace the fuse, see "Fuses and Circuit Breakers" in the Index. If the fuse does not need to be replaced you may need to have your Cadillac serviced.

To reduce the possibility of theft, always arm the Theft Deterrent system when leaving your vehicle.

PASS-KEY II

Your vehicle is equipped with the PASS-Key[®] II (Personalized Automotive Security System) theft deterrent system. PASS-Key[®] II is a passive theft deterrent system. This means you don't have to do anything different to arm or disarm the system. It works when you insert or remove the key from the ignition. PASS-Key[®] II uses a resistor pellet in the ignition key that matches a decoder in your vehicle.

When the PASS-Key[®] II system senses that someone is using the wrong key, it shuts down the vehicle's starter and fuel systems. For about three minutes, the starter won't work and fuel won't go to the engine. If someone tries to start your vehicle again or uses another key during this time, the vehicle will not start. This discourages someone from randomly trying different keys with different resistor pellets in an attempt to make a match.

The ignition key must be clean and dry before it's inserted in the ignition or the engine may not start. If the engine does not start and the **STARTING DISABLED DUE TO THEFT SYSTEM REMOVE IGNITION KEY** message is displayed, the key may be dirty or wet. Turn the ignition off.

Clean and dry the key. Wait about three minutes and try again. The security light may remain on during this time. If the starter still won't work, and the key appears to be clean and dry, wait about three minutes and try another ignition key. At this time, you may also want to check the fuse (see "Fuses and Circuit Breakers" in the Index). If the starter won't work with the other key, your vehicle needs service. If your vehicle does start, the first ignition key may be faulty. See your Cadillac dealer or a locksmith who can service the PASS-Key[®] II.

If you accidentally use a key that has a damaged or missing resistor pellet, the starter won't work and the SECURITY light will flash. But you don't have to wait three minutes before trying another ignition key.

See your Cadillac dealer or a locksmith who can service the PASS-Key[®] II to have a new key made.

If you're ever driving and you get the **THEFT SYSTEM PROBLEM CAR MAY NOT RESTART** message, you will be able to restart your engine if you turn it off. Your PASS-Key[®] II system, however, is not working properly and must be serviced by your Cadillac dealer. Your vehicle is not protected by the PASS-Key[®] II system.

If you lose or damage a PASS-Key[®] II ignition key, see your Cadillac dealer or a locksmith who can service PASS-Key[®] II to have a new key made.

NEW VEHICLE "BREAK-IN"

NOTICE:

Your modern Cadillac doesn't need an elaborate "break-in." But it will perform better in the long run if you follow these guidelines:

- Don't drive at any one speed -- fast or slow -- for the first 500 miles (804 km). Don't make full-throttle starts.
- Avoid making hard stops for the first 200 miles (322 km) or so. During this time your new brake linings aren't yet broken in. Hard stops with new linings can mean premature wear and earlier replacement. Follow this "breaking-in" guideline every time you get new brake linings.
- Don't tow a trailer during "break-in." See "Towing a Trailer" in the Index for more information.

IGNITION KEY POSITIONS

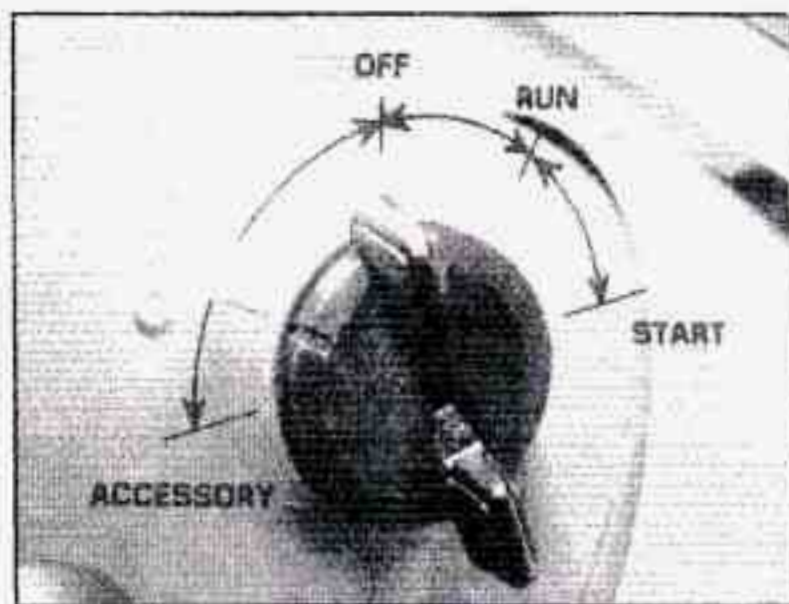

This lock gives you five different positions.

Before you put the key in, your ignition will be in the **LOCK** position. This position locks your ignition, steering wheel and transaxle. It's a theft deterrent feature.

The other positions let you perform these functions:

ACCESSORY: This position lets you use things like the radio and the windshield wipers when the engine is off. To get into **ACCESSORY**, push in the key and turn it toward you. Your steering wheel will remain locked, just as it was before you inserted the key.

LOCK: Before you put the key in, your ignition will be in the **LOCK** position. This is the only position in which you can remove the key. This position locks your ignition, steering wheel and transmission. It's a theft deterrent feature.

OFF: This position lets you turn off the engine but still turn the steering wheel. It doesn't lock the steering wheel like **LOCK**. Use **OFF** if you must have your car in motion while the engine is off (for example, if your car is being pushed).

RUN: This is the position for driving.

START: This starts your engine.

NOTICE:

If your key seems stuck in **LOCK** and you can't turn it, be sure it is all the way in. If it is, then turn the steering wheel left and right while you turn the key hard. But turn the key only with your hand. Using a tool to force it could break the key or the ignition switch. If none of this works, then your vehicle needs service.

STARTING YOUR ENGINE

Move your shift lever to PARK (P) or NEUTRAL (N). Your engine won't start in any other position -- that's a safety feature. To restart when you're already moving, use NEUTRAL (N) only.

NOTICE:

Don't try to shift to PARK (P) if your Cadillac is moving. If you do, you could damage the transaxle. Shift to PARK (P) only when your vehicle is stopped.

1. Without pushing the accelerator pedal, turn your ignition key to START. When the engine starts, let go of the key. The idle speed will go down as your engine gets warm.

NOTICE:

Holding your key in START for longer than 15 seconds at a time will cause your battery to be drained much sooner. And the excessive heat can damage your starter motor.

2. If it doesn't start right away, hold your key in **START** for about three seconds at a time until your engine starts. Wait about 15 seconds between each try to help avoid draining your battery.

Your left headlamp and left taillamp may be on as you start your engine, but the right headlamp and taillamp won't. This provides some light as you start but doesn't drain your battery as much.

3. If your engine still won't start (or starts but then stops), it could be flooded with too much gasoline. Try pushing your accelerator pedal all the way to the floor and holding it there as you hold the key in **START** for about three seconds. If the vehicle starts briefly but then stops again, do the same thing.

NOTICE:

Your engine is designed to work with the electronics in your vehicle. If you add electrical parts or accessories, you could change the way the fuel injection system operates. Before adding electrical equipment, check with your dealer. If you don't, your engine might not perform properly.

If you ever have to have your vehicle towed, see the part of this manual that tells how to do it without damaging your vehicle. See "Towing Your Vehicle" in the Index.

DRIVING THROUGH DEEP STANDING WATER

NOTICE:

If you drive too quickly through deep puddles or standing water, water can come in through your engine's air intake and badly damage your engine. Never drive through water that is slightly lower than the underbody of your vehicle. If you can't avoid deep puddles or standing water, drive through them very slowly.

ENGINE COOLANT HEATER (OPTION)

In very cold weather, 0° F (-18° C) or colder, the engine coolant heater can help. You'll get easier starting and better fuel economy during engine warm-up. Usually, the coolant heater should be plugged in a minimum of four hours prior to starting your vehicle.

To use the coolant heater:

1. Turn off the engine.
2. Open the hood and unwrap the electrical cord.
3. Plug it into a normal, grounded 110-volt outlet.



CAUTION:

Plugging the cord into an ungrounded outlet could cause an electrical shock. Also, the wrong kind of extension cord could overheat and cause a fire. You could be seriously injured. Plug the cord into a properly grounded three-prong 110-volt outlet. If the cord won't reach, use a heavy-duty three-prong extension cord rated for at least 15 amps.

NOTICE:

After you've used the coolant heater, be sure to store the cord as it was before to keep it away from moving engine parts. If you don't, it could be damaged.

How long should you keep the coolant heater plugged in? The answer depends on the weather, the kind of oil you have, and some other things. Instead of trying to list everything here, we ask that you contact your Cadillac dealer in the area where you'll be parking your vehicle. The dealer can give you the best advice for that particular area.

AUTOMATIC TRANSAXLE

Your automatic transaxle has a shift lever located on the steering column.



There are several different positions for your shift lever:

PARK (P): This locks your front wheels. It's the best position to use when you start your engine because your vehicle can't move easily.



CAUTION:

It is dangerous to get out of your vehicle if the shift lever is not fully in PARK (P) with the parking brake firmly set. Your vehicle can roll.

CAUTION: (Continued)

CAUTION: (Continued)

Don't leave your vehicle when the engine is running unless you have to. If you have left the engine running, the vehicle can move suddenly. You or others could be injured. To be sure your vehicle won't move, even when you're on fairly level ground, always set your parking brake and move the shift lever to PARK (P).

See "Shifting Into PARK (P)" in the Index. If you're pulling a trailer, see "Towing a Trailer" in the Index.

Ensure the shift lever is fully in PARK (P) range before starting the engine. Your Cadillac has a brake-transaxle shift interlock. You have to fully *apply* your regular brakes *before* you can shift from PARK (P) when the ignition key is in the RUN position. If you cannot shift out of PARK (P), ease pressure on the shift lever, push the shift lever all the way into PARK (P) as you maintain brake application. Then move the shift lever into the gear you wish. See "Shifting Out of PARK (P)" in this section.

REVERSE (R): Use this gear to back up.

NOTICE:

Shifting to REVERSE (R) while your vehicle is moving forward could damage your transaxle. Shift to REVERSE (R) only after your vehicle is stopped.

Also use this gear to rock your vehicle back and forth to get out of snow, ice or sand without damaging your transaxle. See "If You're Stuck in Sand, Mud, Ice or Snow" in the Index.

NEUTRAL (N): In this position your engine doesn't connect with the wheels. To restart when you're already moving, use NEUTRAL (N) only. Also use NEUTRAL (N) when your vehicle is being towed.



CAUTION:

Shifting out of **PARK (P)** or **NEUTRAL (N)** while your engine is “racing” (running at high speed) is dangerous. Unless your foot is firmly on the brake pedal, your vehicle could move very rapidly. You could lose control and hit people or objects. Don't shift out of **PARK (P)** or **NEUTRAL (N)** while your engine is racing.

NOTICE:

Damage to your transaxle caused by shifting out of **PARK (P)** or **NEUTRAL (N)** with the engine racing isn't covered by your warranty.

AUTOMATIC OVERDRIVE (Ⓢ): This position is for normal driving. If you need more power for passing, and you're:

- Going less than 35 mph (55 km/h), push your accelerator pedal about halfway down.
- Going about 35 mph (55 km/h) or more, push the accelerator all the way down.

You'll shift down to the next gear and have more power.

NOTICE:

If your vehicle seems to start up rather slowly, or if it seems not to shift gears as you accelerate, something may be wrong with a transaxle system sensor. If you drive very far that way, your vehicle can be damaged. So, if this happens, have your vehicle serviced right away. Until then, you can use **SECOND (2)** when you are driving less than 35 mph (55 km/h) and **AUTOMATIC OVERDRIVE (Ⓢ)** for higher speeds.

THIRD (3): This position limits upshifting and will not allow you to shift into **AUTOMATIC OVERDRIVE (D)**.

Here are examples for using **THIRD (3)** instead of **AUTOMATIC OVERDRIVE (D)**:

- When driving on hilly, winding roads
- When towing a trailer, so there is less shifting between gears
- When going down a steep hill

SECOND (2): This position gives you more power. You can use **SECOND (2)** on hills. It can help control your speed as you go down steep mountain roads, but then you would also want to use your brakes off and on.

NOTICE:

Don't drive in SECOND (2) for more than five miles (8 km), or at speeds over 55 mph (88 km/h), or you can damage your transaxle. Use AUTOMATIC OVERDRIVE (D) or THIRD (3) as much as possible.

Don't shift into SECOND (2) unless you are going slower than 65 mph (105 km/h), or you can damage your engine.

FIRST (1): This position gives you even more power than **SECOND (2)**. You can use it on very steep hills, or in deep snow or mud. (If the shift lever is put in **FIRST (1)**, the transaxle won't shift into **FIRST (1)** until the vehicle is going slowly enough.)

NOTICE:

If your front wheels can't rotate, don't try to drive. This might happen if you were stuck in very deep sand or mud or were up against a solid object. You could damage your transaxle.

Also, if you stop when going uphill, don't hold your vehicle there with only the accelerator pedal. This could overheat and damage the transaxle. Use your brakes to hold your vehicle in position on a hill.

PARKING BRAKE

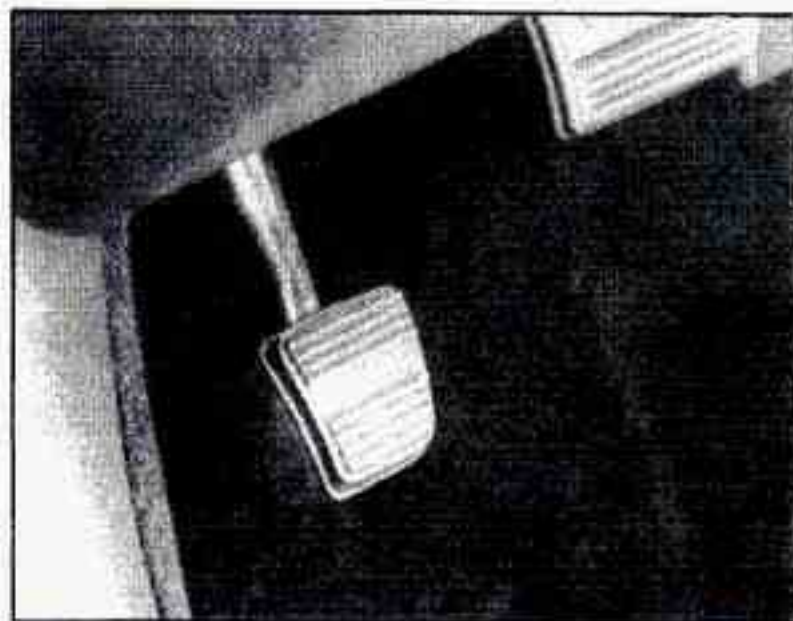

To set the parking brake hold the regular brake pedal down with your right foot and push down the parking brake pedal with your left foot. If the ignition is on, the brake system warning light will come on.

When you move out of PARK (P) or NEUTRAL (N), if your engine is running, your parking brake should release. If it doesn't, you have a parking brake problem and should have it fixed. In the meantime, you can manually release your parking brake as shown by the illustration below.

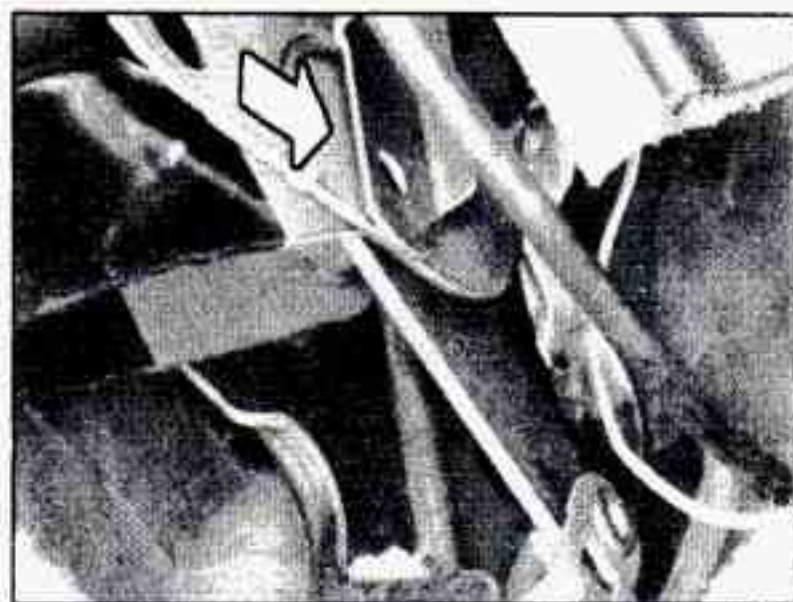

Just pull down on the manual release lever.

 **CAUTION:**

If your hand or arm is in the way of the pedal, you could be hurt. The pedal springs back quickly. Keep your hand and arm away when you use the manual release lever.

NOTICE:

Driving with the parking brake on can cause your rear brakes to overheat. You may have to replace them and you could also damage other parts of your vehicle.

If you are towing a trailer and are parking on a hill, see "Towing a Trailer" in the Index. This section shows what to do first to keep the trailer from moving.

SHIFTING INTO PARK (P)

 **CAUTION:**

It can be dangerous to get out of your vehicle if the shift lever is not fully in PARK (P) with the parking brake firmly set. Your vehicle can roll.

If you have left the engine running, the vehicle can move suddenly. You or others could be injured. To be sure your vehicle won't move, even when you're on fairly level ground, use the steps that follow. If you're pulling a trailer, see "Towing a Trailer" in the Index.

Steering Column shift Lever

1. Turn the ignition key to the OFF or RUN position.
2. Hold the brake pedal down with your right foot.
3. Move the shift lever into the PARK (P) position like this:



- Pull the lever toward you.



- Move the lever up as far as it will go.

4. With your right foot still holding the brake pedal down, set the parking brake.
5. Move the ignition key to LOCK.
6. Remove the key and take it with you. If you can walk away from your vehicle with the ignition key in your hand, your vehicle is in PARK (P).

Leaving Your Vehicle with the Engine Running

CAUTION:

It can be dangerous to leave your vehicle with the engine running. Your vehicle could move suddenly if the shift lever is not fully in PARK (P) with the parking brake firmly set. And, if you leave the vehicle with the engine running, it could overheat and even catch fire. You or others could be injured. Don't leave your vehicle with the engine running unless you have to.

If you have to leave your vehicle with the engine running, be sure your vehicle is in PARK (P) and your parking brake is firmly set before you leave it. After you've moved the shift lever into the PARK (P) position, hold the regular brake pedal down. Then, see if you can move the shift lever away from PARK (P) without first pulling it toward you. If you can, it means that the shift lever wasn't fully locked into PARK (P).

Torque Lock

If you are parking on a hill and you don't shift your transaxle into PARK (P) properly, the weight of the vehicle may put too much force on the parking pawl in the transaxle. You may find it difficult to pull the shift lever out of PARK (P). This is called "torque lock." To prevent torque lock, set the parking brake and then shift into PARK (P) properly before you leave the driver's seat. To find out how, see "Shifting Into PARK (P)" in the Index.

If "torque lock" does occur, you may need to have another vehicle push yours a little uphill to take some of the pressure from the transaxle, so you can pull the shift lever out of PARK (P).

SHIFTING OUT OF PARK (P)

Your Cadillac has a brake-transaxle shift interlock. You have to fully *apply* your regular brakes *before* you can shift from PARK (P) when the ignition is in the RUN position. See "Automatic Transaxle" in the Index.

If you cannot shift out of PARK (P), ease pressure on the shift lever -- push the shift lever all the way into PARK (P) as you maintain brake application. Then move the shift lever into the gear you want. If you ever hold the brake pedal down but still can't shift out of PARK (P), try this:

1. Turn the key to OFF. Open and close the driver's door to turn off the Retained Accessory Power feature.
2. Apply and hold the brake until the end of Step 4.
3. Shift to NEUTRAL (N).
4. Start the vehicle and then shift to the drive gear you want.
5. Have the vehicle fixed as soon as you can.

PARKING OVER THINGS THAT BURN



⚠ CAUTION:

Things that can burn could touch hot exhaust parts under your vehicle and ignite. Don't park over papers, leaves, dry grass or other things that can burn.

ENGINE EXHAUST

⚠ CAUTION:

Engine exhaust can kill. It contains the gas carbon monoxide (CO), which you can't see or smell. It can cause unconsciousness and death.

You might have exhaust coming in if:

- Your exhaust system sounds strange or different.
- Your vehicle gets rusty underneath.
- Your vehicle was damaged in a collision.
- Your vehicle was damaged when driving over high points on the road or over road debris.
- Repairs weren't done correctly.
- Your vehicle or exhaust system had been modified improperly.

If you ever suspect exhaust is coming into your vehicle:

- Drive it only with all the windows down to blow out any CO; and
- Have your vehicle fixed immediately.

RUNNING YOUR ENGINE WHILE YOU'RE PARKED

It's better not to park with the engine running. But if you ever have to, here are some things to know.

CAUTION:

Idling the engine with the air system control off could allow dangerous exhaust into your vehicle (see the earlier Caution under "Engine Exhaust").

Also, idling in a closed-in place can let deadly carbon monoxide (CO) into your vehicle even if the fan switch is at the highest setting. One place this can happen is a garage. Exhaust -- with CO -- can come in easily. **NEVER** park in a garage with the engine running.

Another closed-in place can be a blizzard. (See "Blizzard" in the Index.)

CAUTION:

It can be dangerous to get out of your vehicle if the shift lever is not fully in PARK (P) with the parking brake firmly set. Your vehicle can roll. Don't leave your vehicle when the engine is running unless you have to. If you've left the engine running, the vehicle can move suddenly. You or others could be injured. To be sure your vehicle won't move, even when you're on fairly level ground, always set your parking brake after you move the shift lever to PARK (P).

Follow the proper steps to be sure your vehicle won't move. See "Shifting Into PARK (P)" in the Index.

If you are parking on a hill and if you're pulling a trailer, also see "Towing a Trailer" in the Index.

POWER WINDOWS

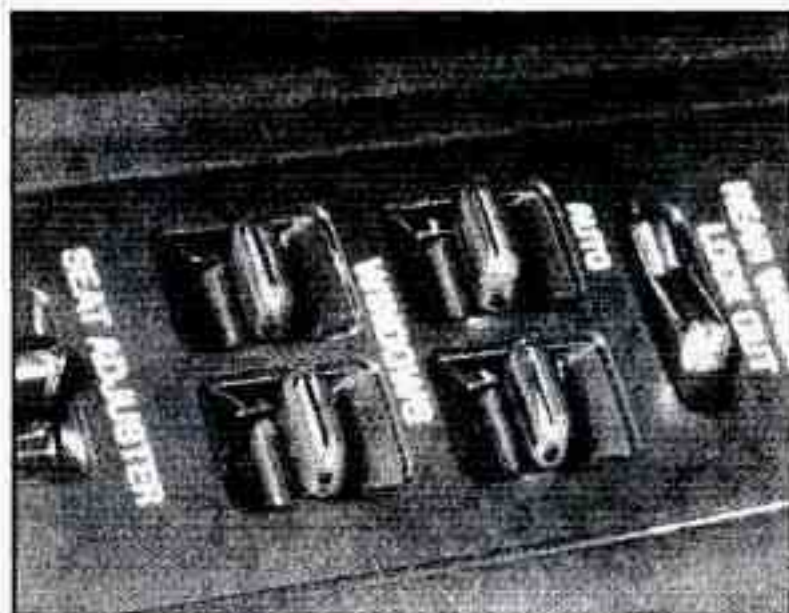

The controls are near each window. Here's how the master control works.

- Move the switch forward to raise the window.
- Move the switch rearward to lower the window.

Your vehicle has Retained Accessory Power (RAP). When you stop your vehicle and turn the ignition key to OFF, you can still use your power windows. The electrical power to operate the windows will not shut off until you open a door or 10 minutes has passed. If you want this power for another 10 minutes, just turn the key to RUN and back to OFF.

Express Down Window (Auto)

The driver's power window has this feature. Just press the switch rearward for half a second or more and then let go. The window will lower completely. If you want to stop the window as it is lowering, press the switch again. To raise the window, press and hold the switch forward.

Rear Window Lock Out



Press the right side of the switch to disable rear passenger window switches. This is a useful feature when you have children as passengers.

Press the left side of the switch to allow your passengers to use their window switches again.

HORN

To sound the horn just press a corner of the air bag located in the center of the steering wheel.

TILT WHEEL

A tilt steering wheel allows you to adjust the steering wheel before you drive.

You can also raise the steering wheel to the highest level to give your legs more room when you exit and enter the vehicle.



To tilt the wheel hold the steering wheel and pull the lever. Move the steering wheel to a comfortable level, then release the lever to lock the wheel in place.

TURN SIGNAL/MULTIFUNCTION LEVER



The lever on the left side of the steering column includes your:

- Turn Signal and Lane Change Indicator
- Headlamp High-Low Beam
- Flash-To-Pass Feature
- Windshield Wipers
- Windshield Washer
- Cruise Control

Turn Signal and Lane Change Indicator Lever

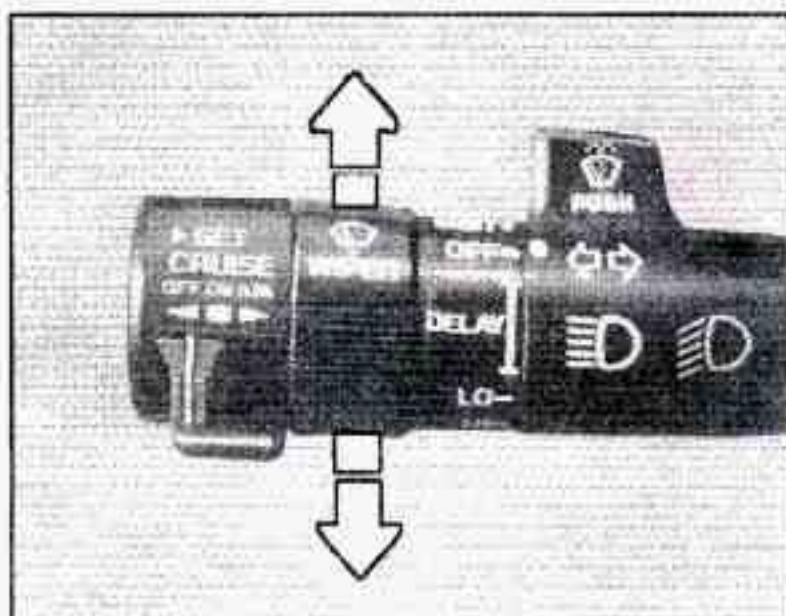

The turn signal has two upward (for right) and two downward (for left) positions. These positions allow you to signal a turn or a lane change.

To signal a turn move the lever all the way up or down. When the turn is finished, the lever will return automatically.

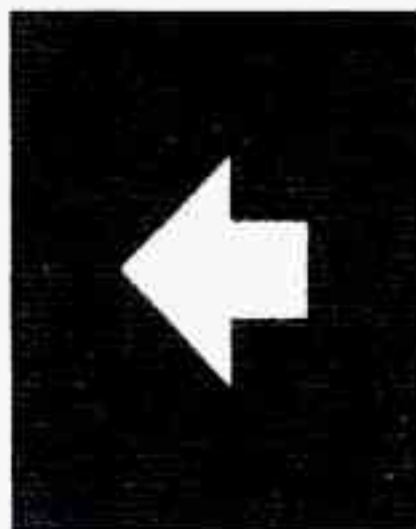

A green arrow on the instrument panel will flash in the direction of the turn or lane change.

To signal a lane change just raise or lower the lever until the green arrow starts to flash. Hold it there until you complete your lane change. The lever will return by itself when you release it.

If for some reason your turn signal is left on, the Driver Information Center will display **TURN SIGNAL ON** (after driving about a mile) to remind you to turn it off.

As you signal a turn or a lane change, if the arrows don't flash but just stay on a signal bulb may be burned out and other drivers won't see your turn signal.

If a bulb is burned out, replace it to help avoid an accident. If the green arrows don't go on at all when you signal a turn, check the fuse (see "Fuses" in the Index) and for burned-out bulbs.

Wiper Activated Headlamps

This feature activates the headlamps and parking lamps after the windshield wipers have been in use for approximately 23 seconds.

In order to operate the wiper activated headlamps, the twilight sentinel must be in the ON position. This feature lights the way in poor weather and it also makes your vehicle more visible to other drivers. If the wiper activated headlamps are on, and the ignition switch is turned off, the wiper activated headlamps will immediately turn off.

The wiper activated headlamps will deactivate if you turn off the twilight sentinel or if the windshield wipers have been turned off for a period of one or two seconds.

Headlamp High-Low Beam

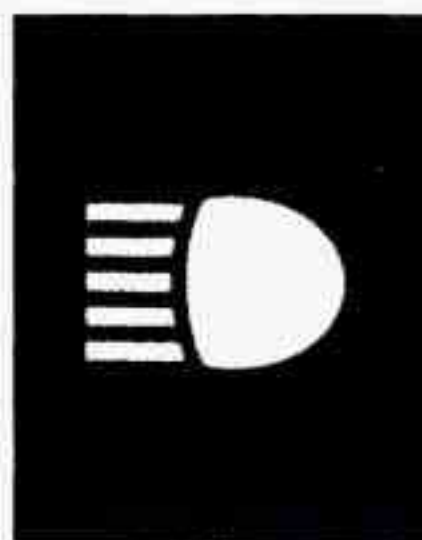

To change the headlamps from low beam to high or high to low, pull the turn signal lever all the way toward you. Then release it. When the high beams are on, this blue light on the instrument panel will also be on.

Flash-To-Pass Feature

This lets you use your high beam headlamps to signal a driver in front of you that you want to pass. It works even if your headlamps are off.

To use it, pull the multifunction lever toward you. When you do:

- If your headlamps are off, your high beam headlamps will turn on. They'll stay on as long as you hold the lever there. Release the lever to turn them off.
- If your headlamps are on low beam, they will shift to high beam and stay there. To return to low beam just pull the lever toward you.
- If your headlamps are on high beam, they will switch to low beam. To get back to high beam pull the lever toward you.

Windshield Wipers

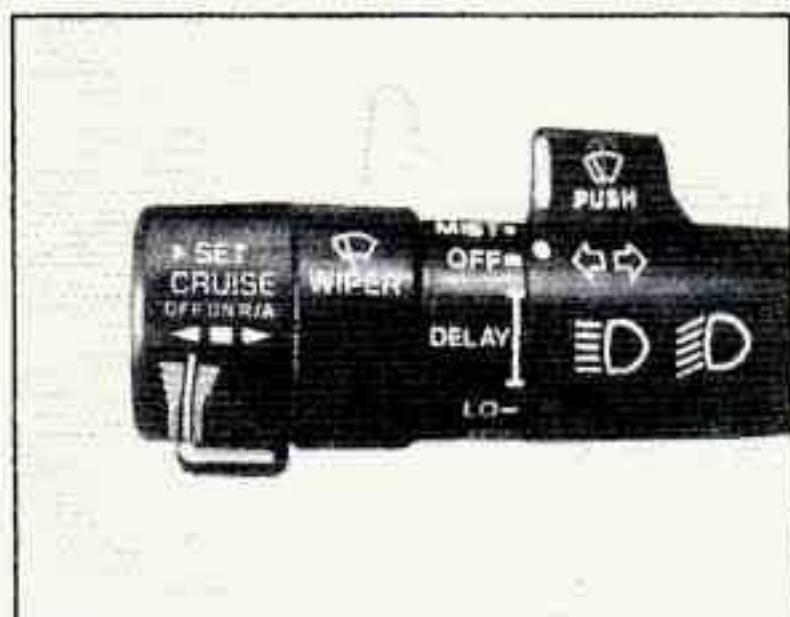

WIPER: To control the wipers turn the band on the multifunction lever.

MIST: Turn the band away from you and then release it for a single wipe cycle. For more cycles hold the band on MIST longer.

LO or HI: Turn the band toward you to either LO (low speed) or to HI (high speed), depending on the wiper speed you want.

DELAY: With this you can set the wiper speed for a long or short delay between wipes. Move the band to the DELAY position. The closer you move it to LO the shorter the delay.

OFF: To turn the wipers off, turn the band to OFF.

Damaged wiper blades may prevent you from seeing well enough to drive safely. To avoid damage, be sure to clear ice and snow from the wiper blades before using them. If they're frozen to the windshield, carefully loosen or thaw them. If your blades do become damaged, get new blades or blade inserts.

Heavy snow or ice can overload your wiper motor. A circuit breaker will stop the motor until it cools. Clear away snow or ice to prevent an overload.

Windshield Washer

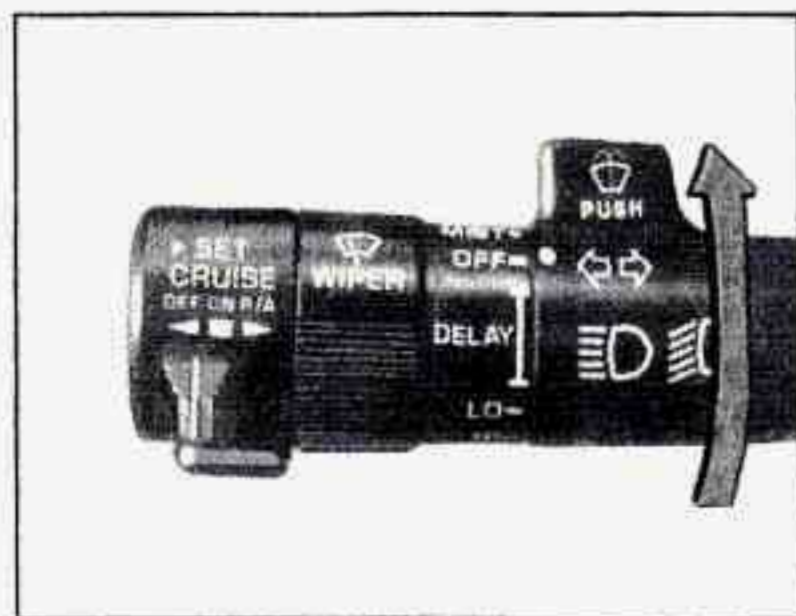

To wash your windshield, press and hold the paddle labeled PUSH. Once you feel you have enough washer fluid on the windshield, release the paddle. The wipers will continue to clear the windshield, then either stop or return to your preset speed.

When the washer fluid reaches a low level, LOW WASHER FLUID will be displayed in the Driver Information Center.

Driving without washer fluid can be dangerous. A bad mud splash can block your vision. You could hit another vehicle or go off the road. Check your washer fluid level often.

 **CAUTION:**

In freezing weather, don't use your washer until the windshield is warmed. Otherwise the washer fluid can form ice on the windshield, blocking your vision.

NOTICE:

- When using concentrated washer fluid, follow the manufacturer's instructions for adding water.
- Don't mix water with ready-to-use washer fluid. Water can cause the solution to freeze and damage your washer fluid tank and other parts of the washer system. Also, water doesn't clean as well as washer fluid.
- Fill your washer fluid tank only 3/4 full when it's very cold. This allows for expansion, which could damage the tank if it is completely full.
- Don't use radiator antifreeze in your windshield washer. It can damage your washer system and paint.

CRUISE CONTROL

With cruise control, you can maintain a speed of about 25 mph (40 km/h) or more without keeping your foot on the accelerator. This can really help on long trips. Cruise control does not work at speeds below about 25 mph (40 km/h).

When you apply your brakes, the cruise control shuts off.



CAUTION:

- **Cruise control can be dangerous where you can't drive safely at a steady speed. So, don't use your cruise control on winding roads or in heavy traffic.**
- **Cruise control can be dangerous on slippery roads. On such roads, fast changes in tire traction can cause needless wheel spinning, and you could lose control. Don't use cruise control on slippery roads.**

If your vehicle is in cruise control when the traction control system begins to limit wheel spin, the cruise control will automatically disengage. (See "Traction Control System" in the Index.) When road conditions allow you to safely use it again, you may turn the cruise control back on.

To Set Cruise Control

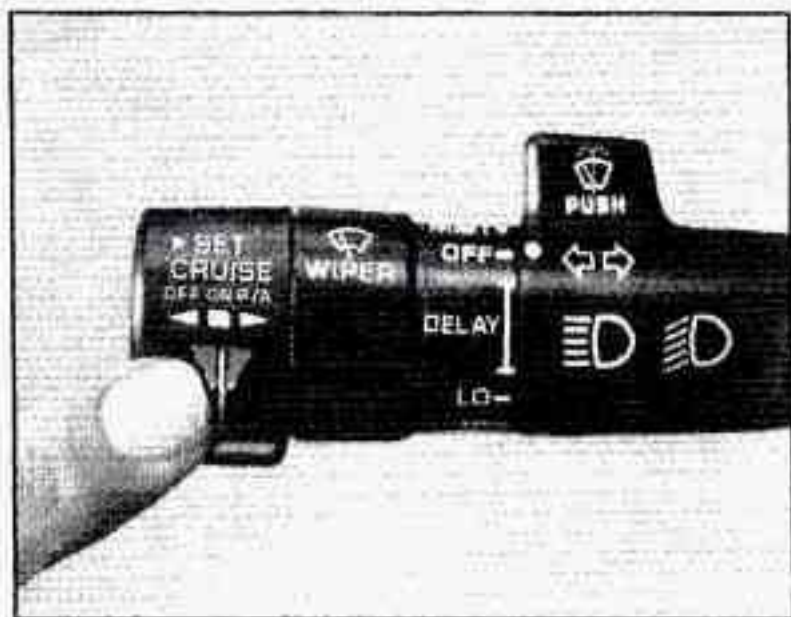

1. Move the cruise control switch to ON.

CAUTION:

If you leave your cruise control switch on when you're not using cruise, you might hit a button and go into cruise when you don't want to. You could be startled and even lose control. Keep the cruise control switch **OFF** until you want to use it.

2. Get up to the speed you want.

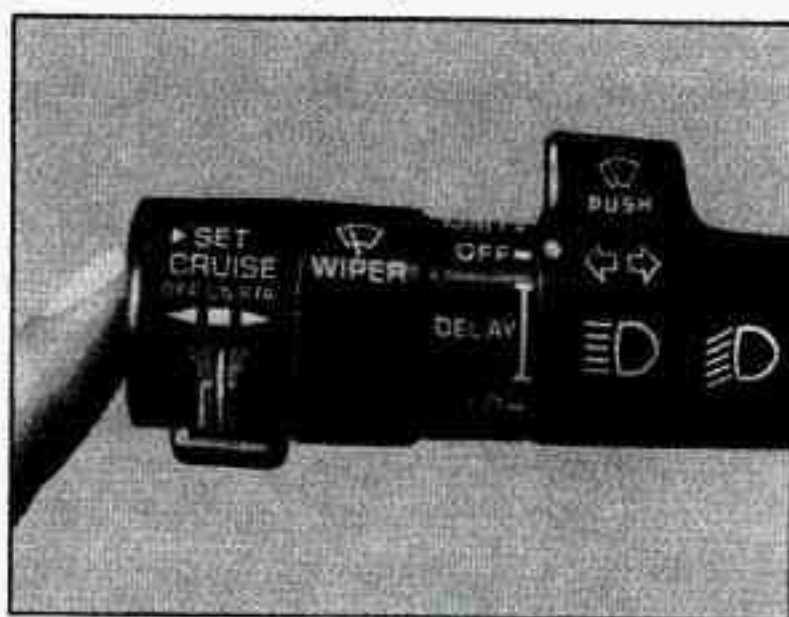

3. Press the button at the end of the lever and release it.

4. The **CRUISE ENGAGED** message will display on the Driver Information Center for a few seconds indicating the cruise is working.

5. Take your foot off the accelerator pedal.

To Resume a Set Speed

Suppose you set your cruise control at a desired speed and then you apply the brake. This, of course, shuts off the cruise control, however, you don't need to reset it. Once you're going about 25 mph (40 km/h) or more, you can move the cruise control switch from ON to R/A (Resume/Accelerate) for about half a second.

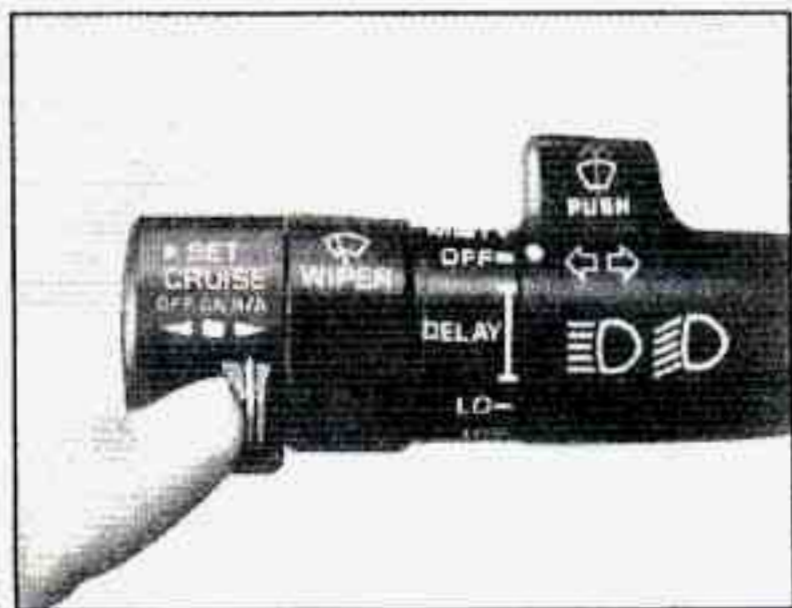

You'll go right back up to your chosen speed and stay there.

Remember, if you hold the switch at R/A longer than half a second, the vehicle will keep going faster until you release the switch or apply the brake. You could be startled and even lose control. So unless you want to go faster, don't hold the switch at R/A.

To Increase Speed While Using Cruise Control

There are two ways to go to a higher speed. Here's the first:

1. Use the accelerator pedal to get to the higher speed.
2. Press the button at the end of the lever, then release the button and the accelerator pedal. You'll now cruise at the higher speed.

Here's the second way to go to a higher speed:

- Move the cruise switch from ON to R/A. Hold it there until you get up to the speed you want, and then release the switch.
- To increase your speed in very small amounts, move the switch to R/A. Each time you do this, your vehicle will go about 1 mph (1.6 km/h) faster.

The accelerate feature will only work after you have set the cruise control speed by pressing the SET CRUISE button.

To Reduce Speed While Using Cruise Control

There are two ways to reduce your speed while using cruise control:

- Press in the button at the end of the lever until you reach your desired speed, then release it.
- To slow down in very small amounts, press the button for less than half a second. Each time you do this, you'll go 1 mph (1.6 km/h) slower.

Passing Another Vehicle While Using Cruise Control

Use the accelerator pedal to increase your speed. When you take your foot off the pedal, your vehicle will slow down to the cruise control speed you set earlier.

Using Cruise Control on Hills

How well your cruise control will work on hills depends upon your speed, load and the steepness of the hills. When going up steep hills, you may have to step on the accelerator pedal to maintain your speed. When going downhill, you may have to brake or shift to a lower gear to keep your speed down. Of course, applying the brake takes you out of cruise control. Many drivers find this to be too much trouble and don't use cruise control on steep hills.

To Get Out of Cruise Control

There are two ways to turn off the cruise control:

1. Step lightly on the brake pedal; OR

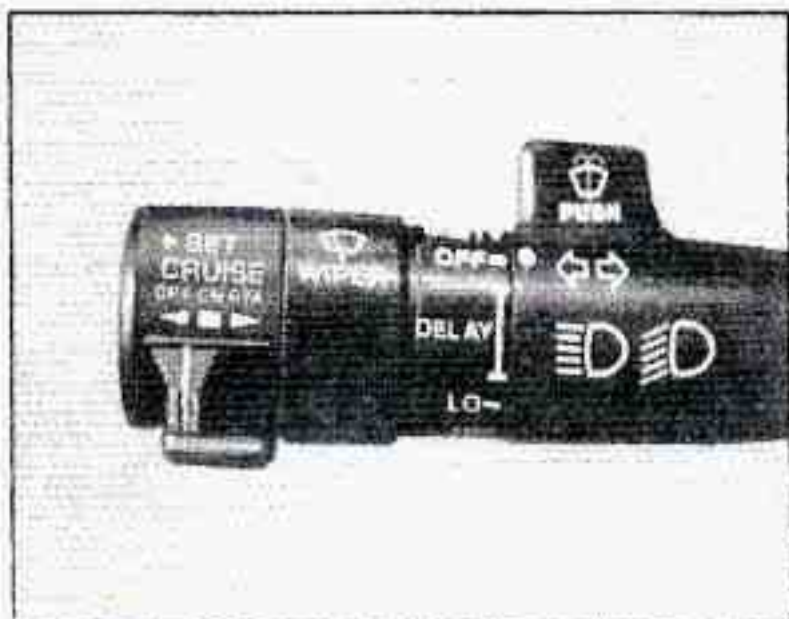

2. Move the CRUISE switch to OFF.

To Erase Speed Memory

When you turn off the cruise control or the ignition, your cruise-control set speed memory is erased.

LAMPS

You'll find the control on the left side of the instrument panel.

It controls these lamp systems:

- Headlamps
- Taillamps
- Parking Lamps
- Underhood Lamp
- Instrument Panel Lamps
- License Plate Lamp
- Interior Courtesy Lamps

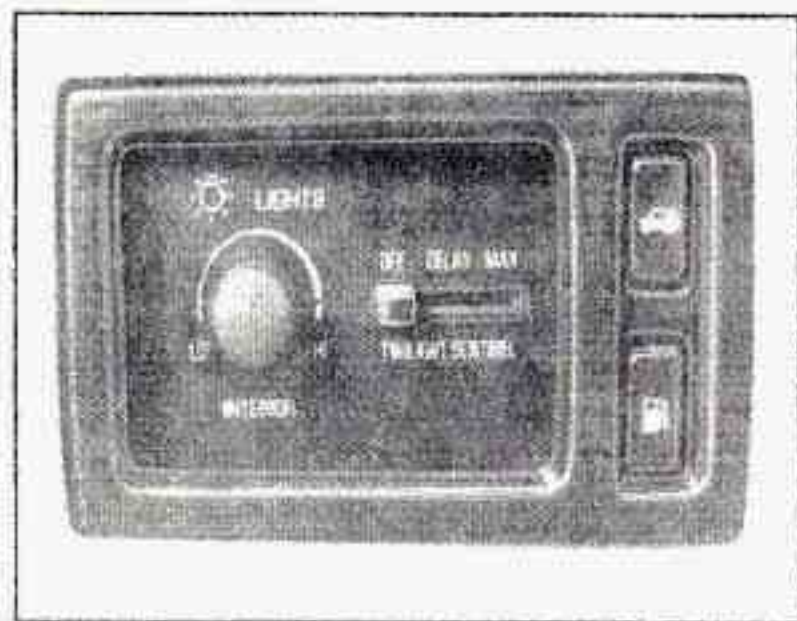

Here's how to manually work your lamp system:

- Pull the switch out to the first stop to turn on your parking and taillamps, sidemarker lamps and instrument panel lamps.
- Pull the switch out all the way to turn on the headlamps.
- You can brighten or dim your instrument cluster by rotating the headlamp switch.
- Press the switch all the way in to turn them off.

Your Cadillac is also equipped with a feature that will automatically turn your exterior lamps on after about 25 seconds of wiper operation.

Lamps on Reminder

If you open the door while leaving the lamps on, except when using twilight sentinel, you will hear a warning tone.

Interior Lamps

Turn the headlamp switch past HI to turn on the interior lamps.

Twilight Sentinel



The control is next to the headlamp switch. It automatically switches your lamps on and off by sensing how dark it is outside. To operate the twilight sentinel, leave the lamp switch off and move the control to any position but OFF.

If you move the control all the way to MAX, your lamps will remain on for 180 seconds after you turn your engine off. If you move the control so it is just on, the lamps will go off quickly when you turn off your engine. You can change this delay time from only a few seconds to 180 seconds.

Light Sensor

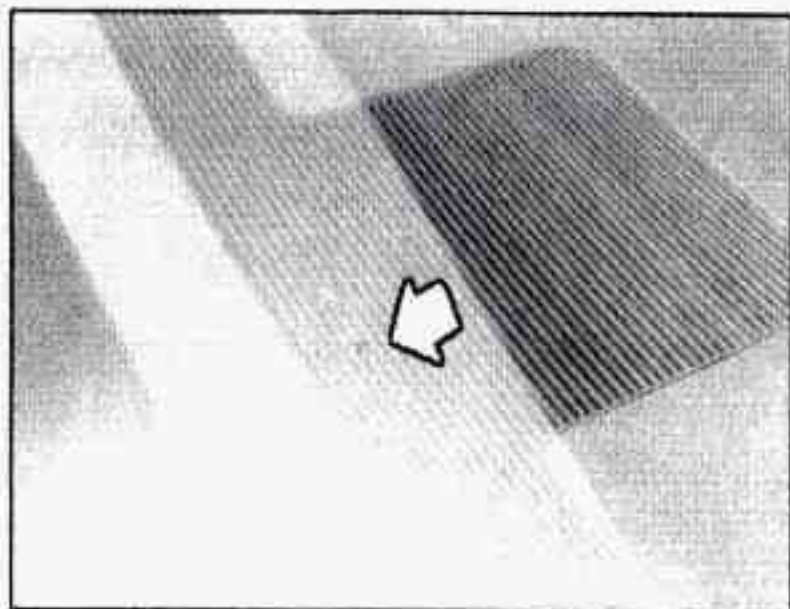

The light sensor for the twilight sentinel is located in the center of the front defogger grille. If you cover the sensor, it will read "dark" and your lamps will come on.

Cornering Lamps

The cornering lamps come on when you signal a turn and the headlamps or parking lamps are on. They provide more light for cornering.

Underhood Lamp

To operate the underhood lamp, turn on your parking lamps. Then the underhood lamp will illuminate when the hood is open.

Daytime Running Lamps (Canada Only)

Daytime Running Lamps (DRL) can make it easier for others to see the front of your vehicle during the day. DRL can be helpful in many different driving conditions, but they can be especially helpful in the short periods after dawn and before sunset.

A light sensor on top of the instrument panel makes the DRL work, so be sure it isn't covered.

The DRL system will make your low beam headlamps come on at reduced brightness when:

- The ignition is on
- The headlamp switch is off, and
- The transaxle is not in PARK (P).

When it's dark enough outside, your low beam headlamps will change to full brightness. When it's bright enough outside, the regular lamps will go off, and your low beam headlamps change to the reduced brightness of DRL.

To idle your vehicle with the DRL off shift the transaxle into PARK (P). The DRL will stay off until you shift out of PARK (P).

As with any vehicle, you should turn on the regular headlamp system when you need it.

Map/Reading Lamps

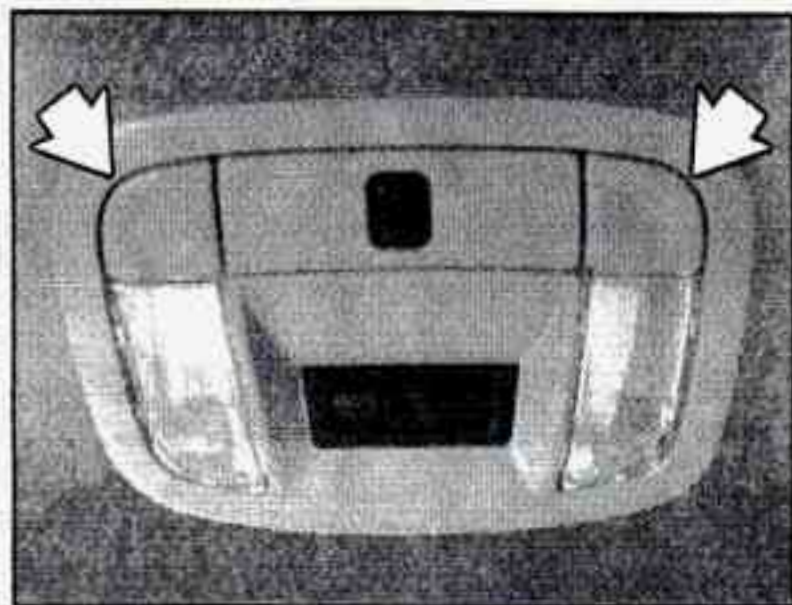

You have map lamps located in the overhead panel. Press the button to turn them on. Press it again to turn them off.

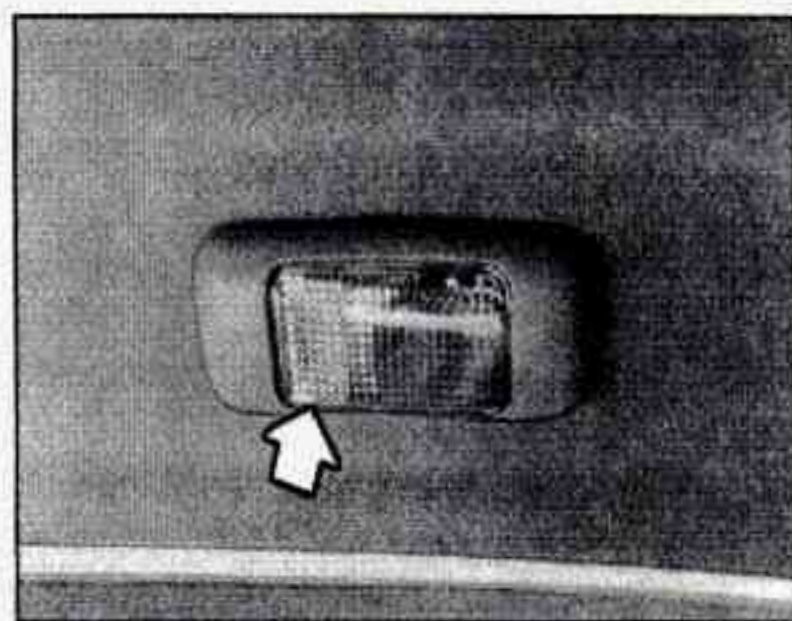

If your vehicle is equipped with the optional astroroof, you can illuminate the rear courtesy lamps by pressing the lens. Press it again to turn them off.

These lamps and the interior courtesy lamps will come on when you open a door.

Rear Taillamp Monitor

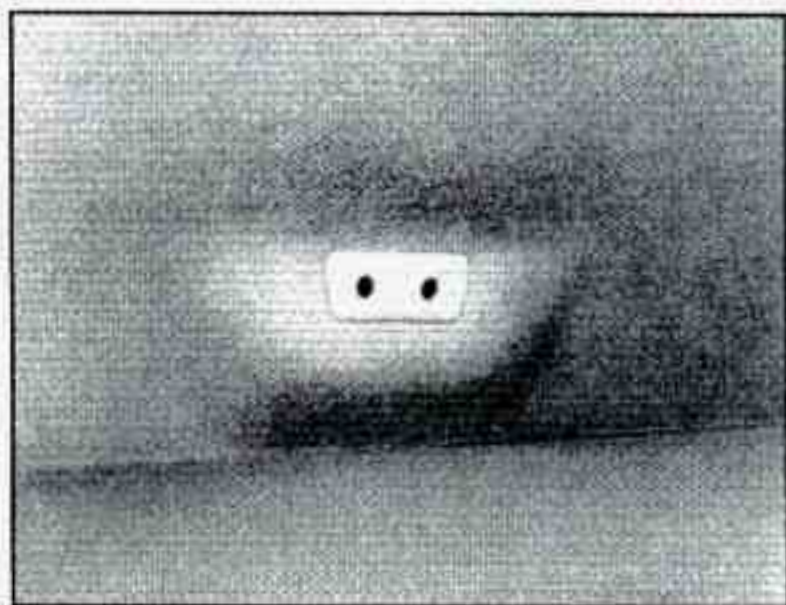

The rear taillamp monitors are located at the top center at the back glass. You will see them as you are looking through your inside rearview mirror. The two red indicators will illuminate to show that your taillamps and brake lamps are working.

Assist Handles

A folding handle over each passenger door can be used when getting out of the vehicle.

Over the rear doors there is a coat hook on the handles.

MIRRORS

Automatic Inside Rearview Mirror

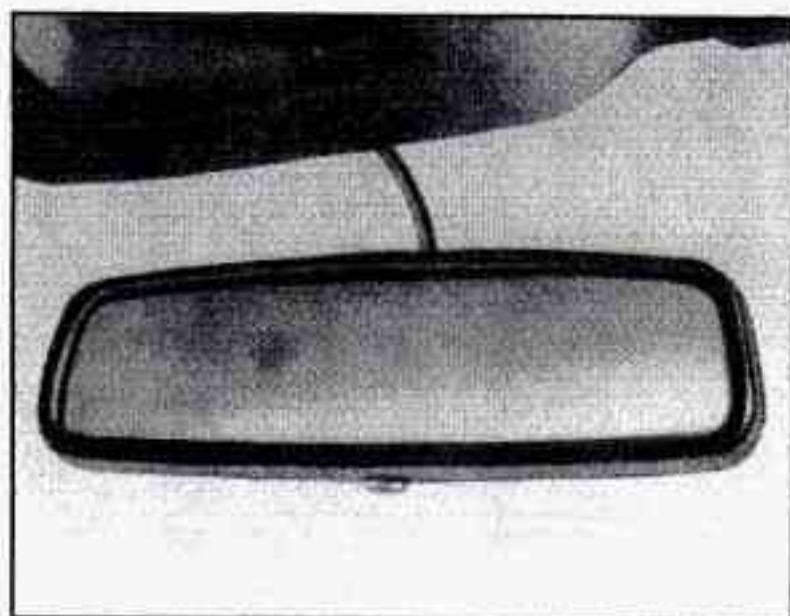

Your Cadillac is equipped with an automatic electrochromic inside rearview mirror.

This mirror automatically changes to reduce glare from headlamps behind you. A photocell on the back of the mirror senses when it is becoming dark outside. Another photocell built into the mirror surface senses the headlamps behind you.

The mirror will darken gradually to reduce glare. This change may take a few seconds. When the glare subsides, the mirror returns to its clear daytime state.

On/Off Switch

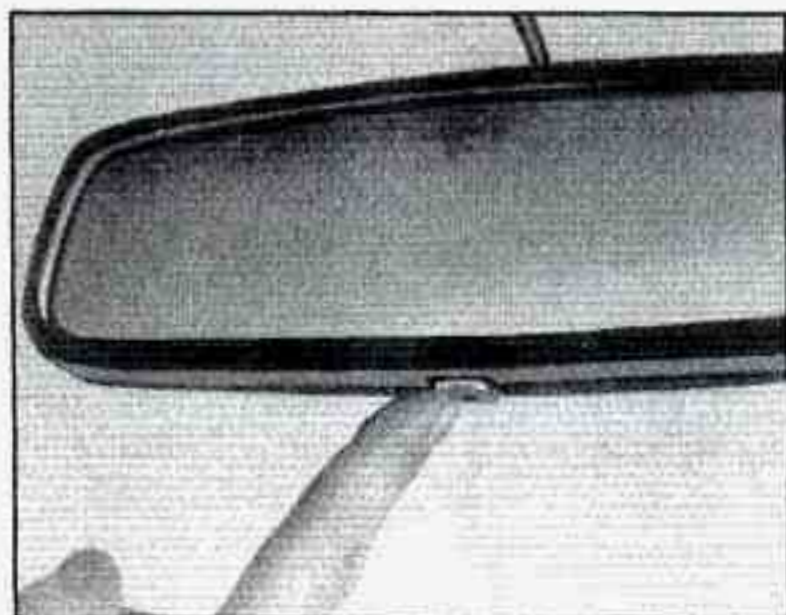

To turn the auto-dimming feature on press the switch located at the base of the mirror.

The switch will light indicating it is on.

Reverse Gear Day Mode

The reverse mode is another important feature of the automatic mirror. When the shift lever is placed in REVERSE (R), the mirror changes to the daytime mode for a bright image in the mirror as you back up.

Cleaning Photocells

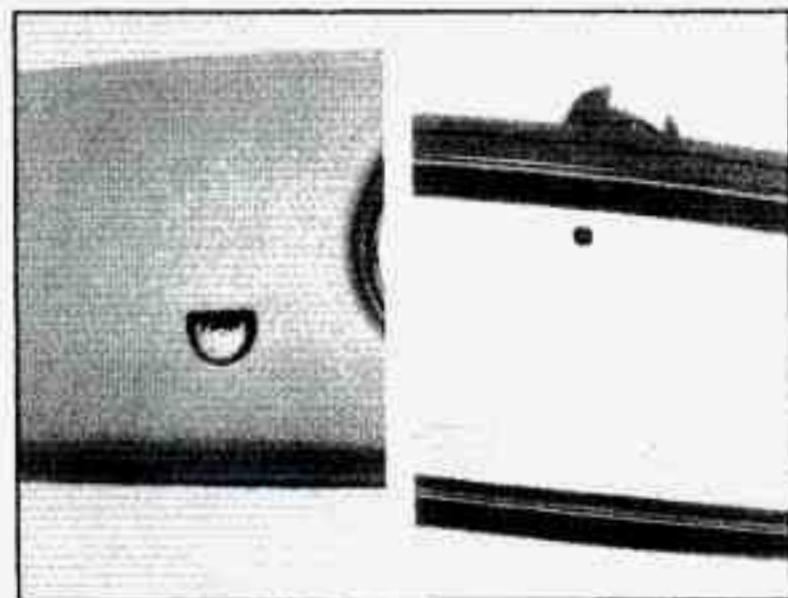

Use a cotton swab and glass cleaner to clean the front and rear photocells that make the auto-dimming feature work.

Electrochromic Day/Night Rearview Mirror with Compass (Option)

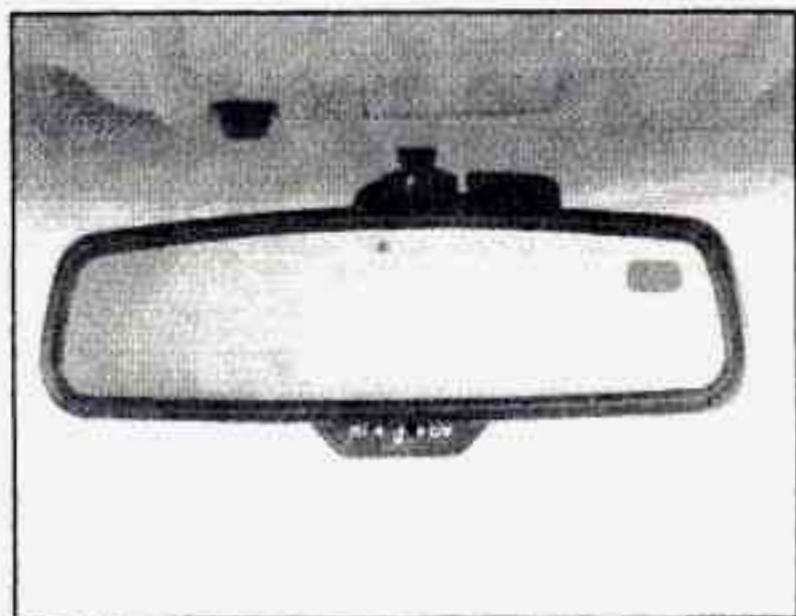

This mirror automatically changes to reduce glare when set in the M (Mirror) or C/M (Compass/Mirror) positions. One photocell on the back of the mirror senses when it is becoming dark outside. Another photocell is built into the mirror surface to sense headlamps behind you.

The mirror will darken gradually to reduce glare. This change may take a few moments.

The mirror goes to a clear position whenever you shift to REVERSE (R).

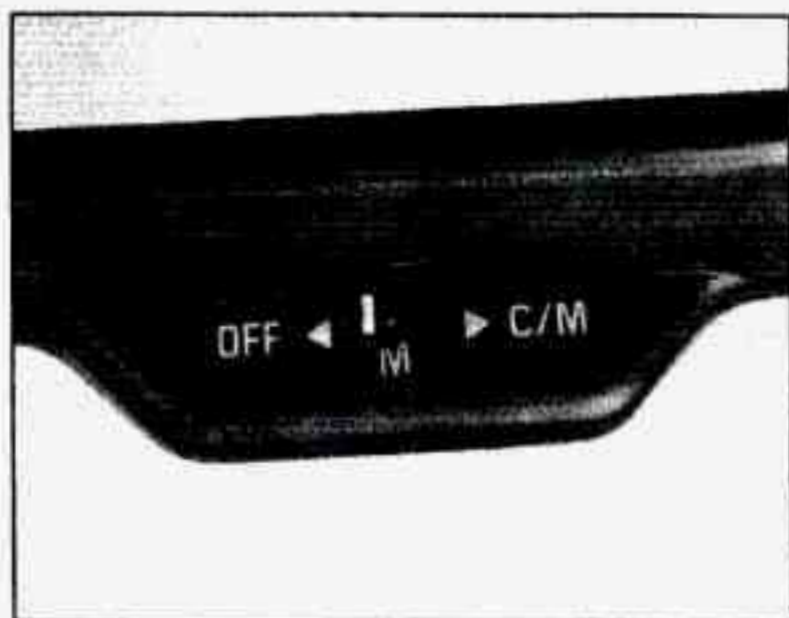

OFF: Turns off the day/night function and compass. The mirror will stay in the day setting.

To keep the photocells operating well, occasionally clean them with a cotton swab and glass cleaner.

M: This turns on the day/night portion of the mirror to automatically reduce glare.

C/M: This setting turns on the compass in addition to the day/night function. A letter denoting the direction headed will appear in the top right corner of the mirror.

Once the compass is calibrated, it does not need to be recalibrated.

To calibrate the compass:

1. Set the switch on the mirror control to C/M.
2. Turn the vehicle ignition switch ON. The letter C should be displayed in the mirror compass window. If not, hold the Cal switch (bottom of the mirror) for more than 10 seconds, and the letter C will appear. To hold in the Cal switch, insert a paper clip into the small hole on the bottom of the mirror housing. The display will show a number first, but keep holding until the letter C appears.
3. For quick calibration, drive the vehicle in a 360-degree circle at less than 5 mph (8 km/h) until the display reads a compass direction. For

normal calibration, drive the vehicle on your everyday routine, and the compass will eventually calibrate.

Compass Variance

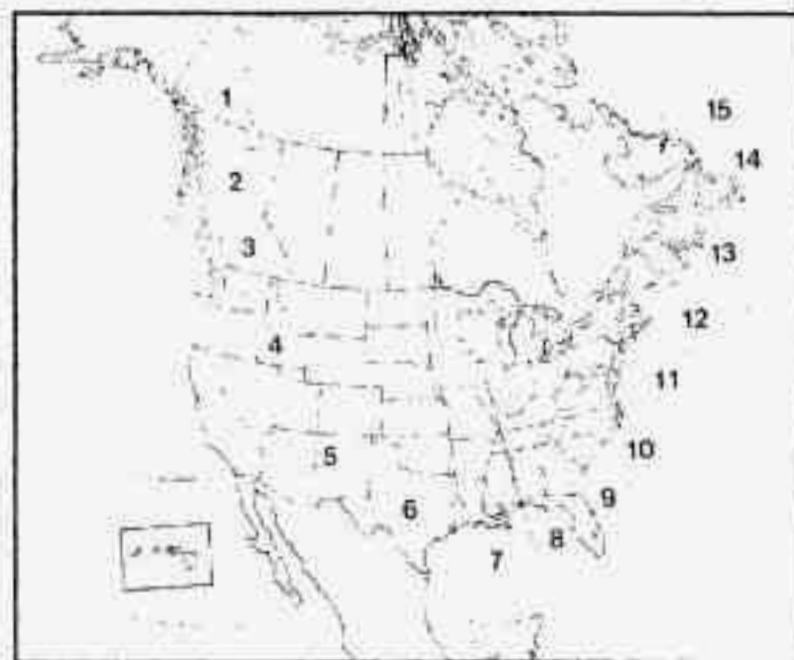

Variance is the difference between magnetic north and geographic north. In some areas the difference between the two can be great enough to cause false compass readings. If this happens, follow these instructions to set the variance for your particular location:

1. Determine your location on the zone map. Note your zone number.
2. Hold in the Cal switch (bottom of the mirror housing) for five seconds until the current zone entry number appears in the display. To hold in the Cal switch, insert a paper clip into the small hole on the bottom of the mirror housing.
3. Repeatedly press the Cal switch until the number for the new zone entry is displayed.

Once the desired zone number is displayed, stop pressing the Cal switch and the display will show compass direction within a few seconds.

Power Remote Control Mirrors



The control on the driver's door armrest operates both outside rearview mirrors. Rotate the control knob to the left to select the driver side mirror, or to the right to select the passenger side mirror. Then push the control knob in the direction of the desired mirror movement to adjust each mirror so that you can just see the side of your vehicle.

When you operate the rear window defogger, it also warms both outside mirrors to help clear them of fog or ice.

Driver's Outside Auto-Dimming Rearview Mirror (Option)

This mirror automatically dims to minimize glare for maximum rear visibility. It operates in conjunction with the inside rearview mirror. As glare increases, the mirror darkens accordingly. When the glare subsides the mirror returns to its clear daytime state.

CONVEX OUTSIDE MIRROR

Your passenger's side mirror is convex.

A convex mirror's surface is curved so you can see more from the driver's seat.



CAUTION:

A convex mirror can make things (like other vehicles) look farther away than they really are. If you cut too sharply into the right lane, you could hit a vehicle on your right. Check your inside mirror or glance over your shoulder before changing lanes.

BREAK-AWAY OUTSIDE MIRROR (EXPORT ONLY)

The mirrors will collapse in either the forward or rearward direction and then return to the normal position.

POWER FOLDING MIRROR (EXPORT ONLY)

The control switch in the driver's door armrest operates the fold and extend feature for both outside rearview mirrors.

- Move the switch rearward to fold both mirrors toward the vehicle's body.
- Move the switch forward to extend both mirrors back to the normal viewing position.

FLOOR MATS

Your Cadillac is equipped with rubber-backed front and rear floor mats. Keep them clean by vacuuming and using a spot cleaner, if necessary. Do not machine wash.

CONVENIENCE NET



You'll find the convenience net just inside the back wall of the trunk.

Put small loads, like grocery bags, behind the net. It can help keep them from falling over during sharp turns or quick starts and stops.

The net is not for larger, heavier loads. Store them in the trunk as far forward as you can. When not using the net, hook the net to the tabs securing it to the sill plate.

Front Visor and Auxiliary Sunshade System

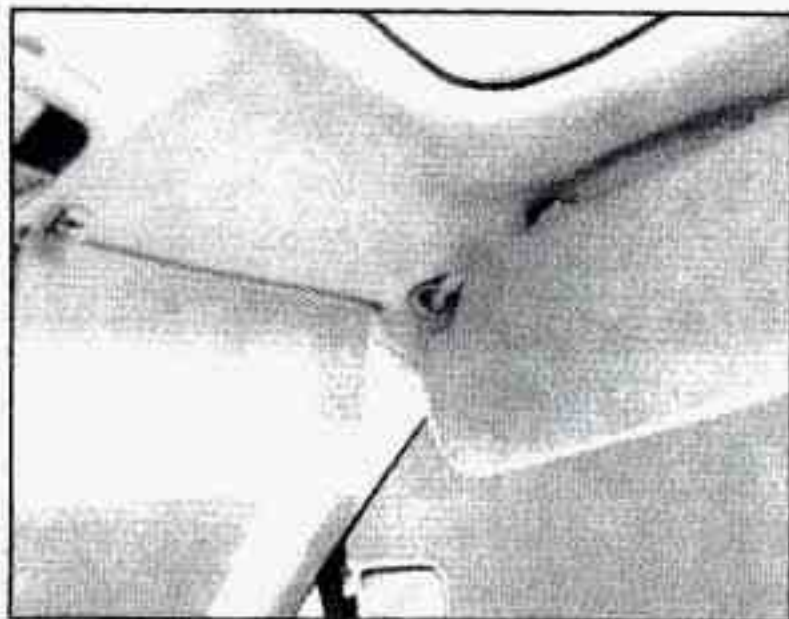

To block out glare, swing down the visor. You can also remove them from the center mount and swing them to the side, while the auxiliary sunshade remains to block glare from the front.

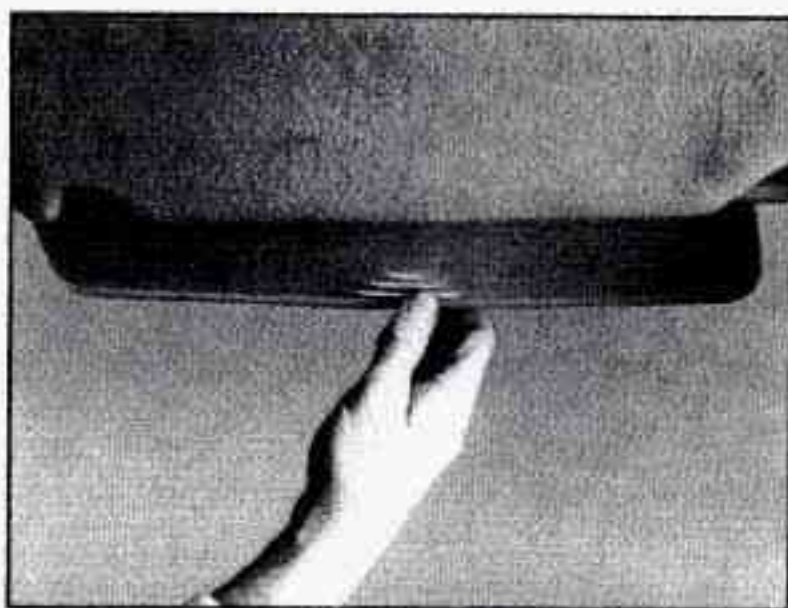

To use one, pull the front shade from the headliner and position it to your preference.

Front Seat Vanity Mirrors

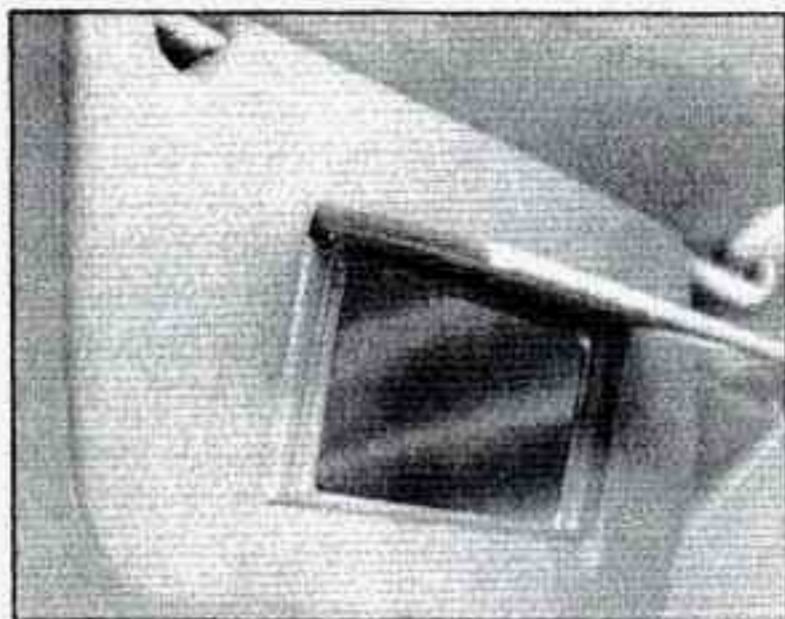

To use one, turn the sunshade down. Then lift the cover up to see the mirror. The slide switch controls the lamps intensity.

Illuminated Front Seat Vanity Mirrors

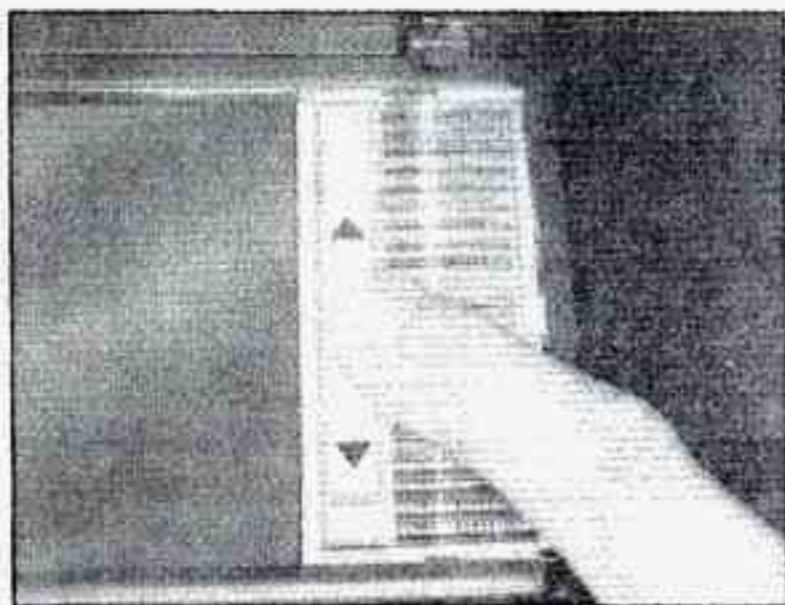

To use the lighted vanity mirrors, turn the sunshade down. Then lift the cover up to see the mirror. Move the slide switch up or down to either brighten or dim the light.

ASTROROOF - EXPRESS OPEN

If you have this option, the switch is here:

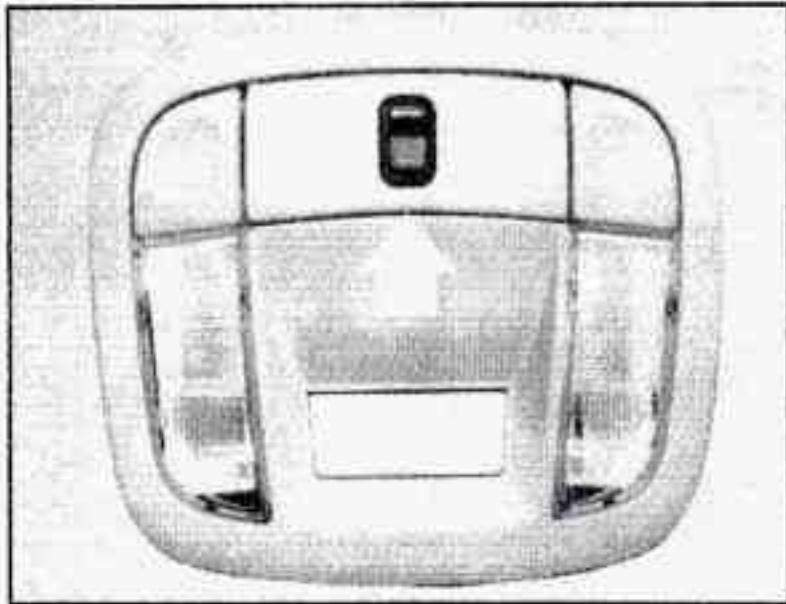

The astroroof includes an express open feature, a sliding glass panel and a sliding sunshade. The control switch only works with the ignition on or in Retained Accessory Power (RAP) mode.

To open the glass panel and sunshade, press the switch rearward. The sunshade can also be opened by hand. If you want to stop the roof in a partially opened position, press the switch in either direction. Press the switch again to open it fully.

Press and hold the switch forward to close the glass panel. The sunshade can only be closed by hand.

To vent, press the switch forward when the glass panel is closed. Open the sunshade by hand. To close the vent press the switch rearward.

HomeLink™ Universal Transmitter (Option)

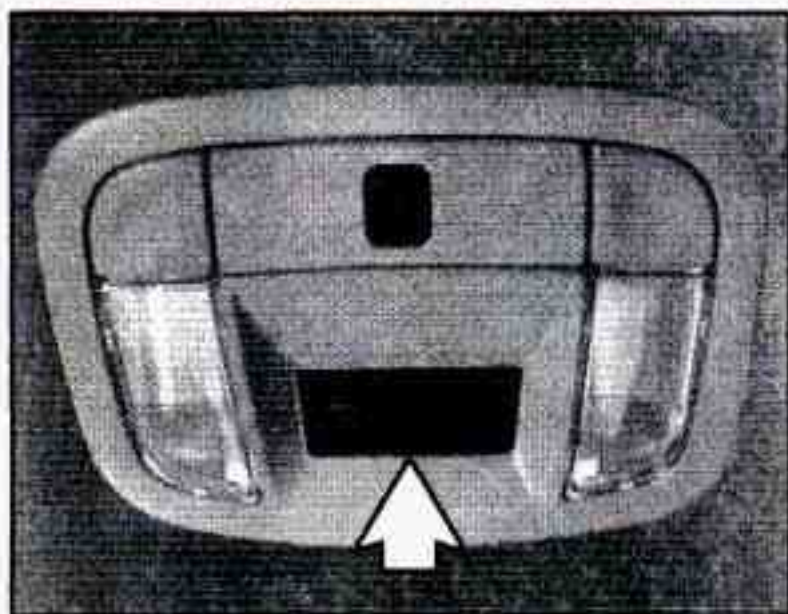

This transmitter allows you to consolidate the functions of up to three individual hand-held transmitters. It will operate garage doors and gates, or with the accessory package, other devices controlled by radio frequency such as home/office lighting systems and security systems.

The transmitter will learn and transmit the frequencies of most current transmitters and is powered by your vehicle's battery and charging system.

This device complies with Part 15 of the FCC Rules. Operation is subject to the following two conditions: (1) This device may not cause harmful interference, and (2) This device must accept any interference received, including interference that may cause undesired operation.

Programming the Transmitter

Do not use the HomeLink™ Transmitter with any garage door opener that does not have the "stop and reverse" safety feature. This includes any garage door opener model manufactured before April 1, 1982.

Be sure that people and objects are clear of the garage door you are programming!

Your vehicle's engine should be turned off while programming your transmitter. Follow these steps to program up to three channels:

1. If you have previously programmed a HomeLink™ channel, proceed to Step 2. Otherwise, hold down the two outside buttons on the HomeLink™ Transmitter until the red light begins to flash rapidly (approximately 20 seconds). Then release the buttons. This procedure initializes the memory and erases any previous settings for all three channels.
2. Hold the end of your hand-held transmitter against the bottom surface of the HomeLink™ Transmitter so that you can still see the red light.
3. Decide which one of the three channels you want to program. Using both hands, press the hand-held transmitter button and the desired button on the HomeLink™ Transmitter. Continue to hold both buttons through Step 4.
4. Hold down both buttons until you see the red light on the HomeLink™ Transmitter flash rapidly. The rapid flashing, which could take up to 90 seconds, indicates that the HomeLink™ Transmitter has been programmed. Release both buttons once the light starts to flash rapidly.

If you have trouble programming the HomeLink™ Transmitter, make sure that you have followed the directions exactly as described and that the batteries in the hand-held transmitter are not dead. If you still cannot program it, rotate your hand-held transmitter end over end and try again. The HomeLink™ Transmitter may not work with older garage door openers that do not meet current Federal Consumer Safety Standards. If you cannot program the transmitter after repeated attempts, consult your Cadillac dealer or call 1-800-355-3515.

Be sure to keep your original hand-held transmitter in case you need to erase and reprogram the HomeLink™ transmitter.

Note to Canadian Owners: During programming, your hand-held transmitter may stop transmitting after one or two seconds. If you are programming from one of these transmitters, the HomeLink™ indicator light may prompt you to re-activate your hand-held transmitter with a series of double blinks. After you re-activate your hand-held transmitter, the HomeLink™ light should flash rapidly. If it flashes slowly, continue to periodically re-activate your hand-held transmitter until the light flashes rapidly.

Operating the Transmitter

Press the appropriate button on the HomeLink™ Universal Transmitter. The red light comes on while the signal is being transmitted.

Note that the effective transmission range of the HomeLink™ Transmitter may differ from your hand-held transmitter and from one channel to another.

Erasing Channels

To erase all three programmed channels, hold down the two outside buttons until the red light begins to flash. Individual channels cannot be erased, but can be reprogrammed using the procedure for programming the transmitter explained earlier.

Accessories

Accessories for your HomeLink™ Universal Transmitter are available from the manufacturer of the unit. If you would like additional information, please call 1-800-355-3515.

HomeLink™ is a trademark of Prince Corporation.

ASHTRAYS AND LIGHTERS



To access the front ashtray pull the drawer out.

To clean the ashtray lift it out by pulling on the snuffer.

If the ashtray will not come out, try reaching under the drawer and gently push upon the ashtray bowl and remove it.

Rear Door Ashtray

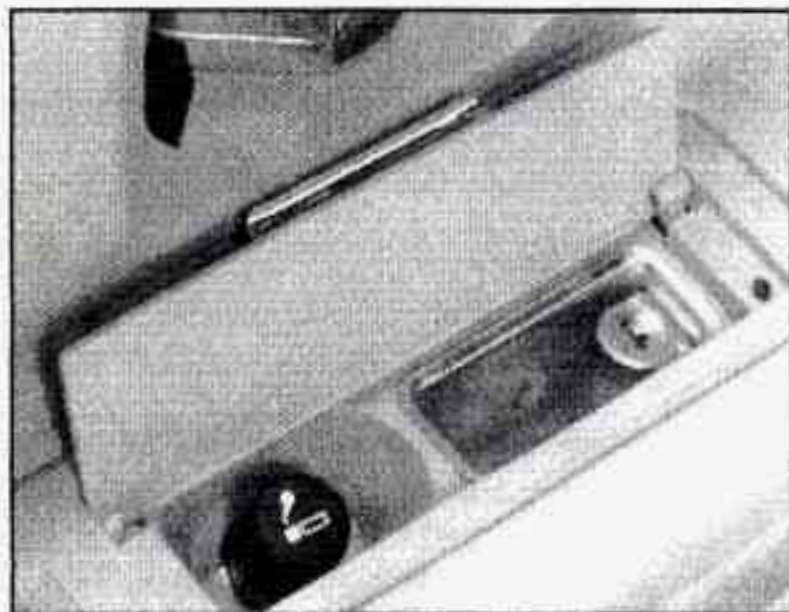

To open the rear ashtray lift the lid.

NOTICE:

Don't put papers or other flammable items into your ashtrays. Hot cigarettes or other smoking materials could ignite them, causing a damaging fire.

Cigarette Lighter

It's located near the ashtray. To use the lighter just press it in all the way and let go. When it's ready, it will pop back by itself.

NOTICE:

Don't hold a cigarette lighter in with your hand while it is heating. If you do, it won't be able to back away from the heating element when it's ready. That can make it overheat, damaging the lighter and the heating element.

Speedometer and Odometer

Your speedometer lets you see your speed in both miles per hour (mph) and kilometers per hour (km/h). Your odometer shows how far your vehicle has been driven, in either miles (used in the United States) or kilometers (used in Canada).

You may wonder what happens if a car has to have a new odometer installed. The new one will read the correct mileage. This is because your car's computer has stored the mileage in memory.

English/Metric Button

This button is located on the Driver Information Center (DIC). You can go back and forth from English (miles) to metric (kilometers) by pressing this button.

The same button also makes other readings (like temperature, fuel and odometer) go between English and metric.

Trip Odometer

This button is located on the Driver Information Center (DIC). You can tell how far you've gone since you last set it back to zero. To reset, press and hold the button until zeros appear.

If your vehicle is domestic, the trip odometer will return to zero after 999.9 miles (1 609 km). If your vehicle is Canadian, the trip odometer will return to zero after 1 999.9 km (1,242 miles).

WARNING LIGHTS

This part describes the warning lights that are on your vehicle. The pictures will help you locate them.

Warning lights can signal that something is wrong before it becomes serious enough to cause an expensive repair or replacement. Paying attention to your warning lights could also save you or others from injury.

Warning lights come on when there may be or is a problem with one of your vehicle's functions. As you will see in the details on the next few pages, some warning lights come on briefly when you start the engine just to let you know they're working. If you are familiar with this section, you should not be alarmed when this happens.

When one of the warning lights comes on and stays on when you are driving, check the section that tells you what to do about it. Please follow this manual's advice. Waiting to do repairs can be costly -- and even dangerous. So please get to know your warning lights. They're a big help.

Your vehicle may also have a Driver Information Center that works along with the warning lights. See "Driver Information Center" in the Index.

Safety Belt Reminder Light



When the key is turned to RUN or START, a chime will come on for about eight seconds to remind people to fasten their safety belts.

The safety belt light will also come on and stay on for about 75 seconds. If the driver's belt is already buckled, neither the chime nor the light will come on.

Air Bag Readiness Light

There is an air bag readiness light on the instrument panel, which shows AIR BAG. The system checks the air bag's electrical system for malfunctions. The light tells you if there is an electrical problem. The system check includes the air bag sensors and modules, the wiring and the diagnostic module. For more information on the air bag system, see "Air Bag" in the Index.



AIR BAG

You will see this light flash for a few seconds when you turn your ignition to RUN or START. Then the light should go out. This means the system is ready.

If the air bag readiness light doesn't come on when you start your vehicle, or stays on, or comes on when you are driving, your air bag system may not work properly. Have your vehicle serviced right away.

Battery Charge Light (Canadian Only)



When you turn the key to RUN or START, this red battery light will come on briefly, to show that your alternator and battery charging systems are working.

If the light stays on you need service, and you should take your Cadillac to the dealer at once. To save your battery until you get there turn off all accessories.

Brake System Warning Light



Your Cadillac's hydraulic brake system is divided into two parts. If one part isn't working, the other part can still work and stop you. For good braking, though, you need both parts working well.

If the warning light comes on, there could be a brake problem. Have your brake system inspected right away.

This light should come on briefly as you start the vehicle. If it doesn't come on then, have it fixed so it will be ready to warn you if there's a problem.

If the light comes on while you are driving, pull off the road and stop carefully. You may notice that the pedal is harder to push. Or, the pedal may go closer to the floor. It may take longer to stop. If the light is still on, have the vehicle towed for service. (See "Towing Your Vehicle" in the Index.)

CAUTION:

Your brake system may not be working properly if the brake system warning light is on. Driving with the brake system warning light on can lead to an accident. If the light is still on after you've pulled off the road and stopped carefully, have the vehicle towed for service.

The brake system warning light will also come on when you set your parking brake, and it will stay on if your parking brake doesn't release fully. If it stays on after your parking brake is fully released, it means you have a brake problem.

Anti-Lock Brake System Warning Light



With the anti-lock brake system, this light will come on when you start your engine and may stay on for several seconds. That's normal. If the light doesn't come on, have it fixed so it will be ready to warn you if there is a problem.

If the light stays on, turn the ignition off. Or, if the light comes on when you're driving, stop as soon as possible and turn the ignition off. Then start the engine again to reset the system. If the light still stays on, or comes on again while you're driving, your Cadillac needs service. If the regular brake system warning light isn't on, you still have brakes, but you don't have anti-lock brakes. If the regular brake system warning light is also on, you don't have anti-lock brakes and there's a problem with your regular brakes. See "Brake System Warning Light" earlier in this part.

Traction Disabled Message

If this message is displayed, there's a problem with your traction control system and your vehicle needs service. When this message is displayed, the system will not limit wheel spin. Adjust your driving accordingly.

Traction Control System Active Message

When your traction control system is limiting wheel spin, the TRACTION ACTIVE message will be displayed. Slippery road conditions may exist if this message is displayed, so adjust your driving accordingly. This message will stay on for a few seconds after the traction control system stops limiting wheel spin.

Engine Temperature Warning Light (Canadian Only)



This light tells you that your engine has overheated. You should stop the car and turn the engine off as soon as possible. A warning chime should also sound if this light comes on.

As a check, the light should come on for a few seconds when you start your engine.

HOT COOLANT CAN BURN YOU BADLY!

In the section "Problems on the Road," this manual explains what to do. See "Engine Overheating" in the Index.

Malfunction Indicator Lamp (Service Engine Soon Light)

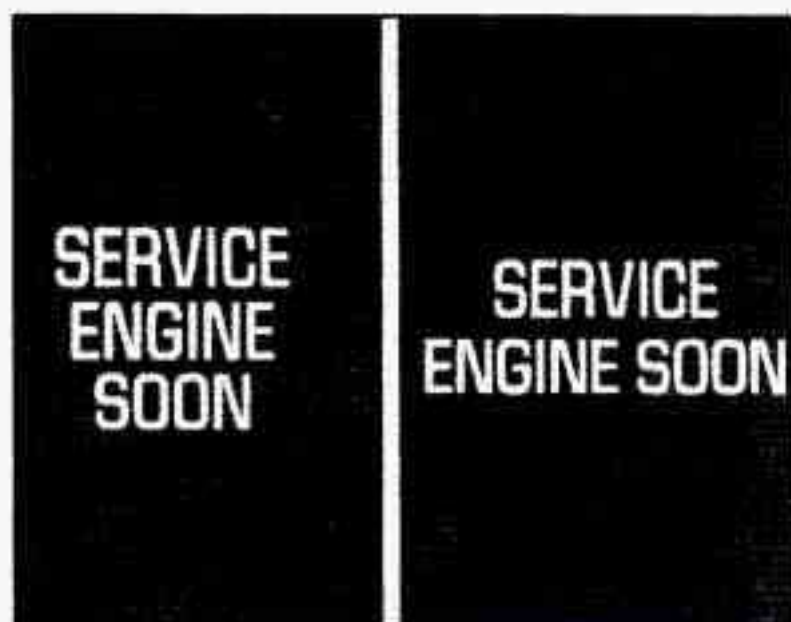

A computer monitors operation of your fuel, ignition and emission control systems. One of these amber SERVICE ENGINE SOON indicator lights should come on when the ignition is on, but the engine is not running, as a check to show you it is working. If it does not come on at all, have it fixed right away. If the malfunction indicator lamp stays on or it comes on while you are driving, the computer is indicating that you have a problem. You should take your vehicle in for service soon.

NOTICE:

If you keep driving your vehicle with this light on, after a while the emission controls won't work as well, your fuel economy won't be as good and your engine may not run as smoothly. This could lead to costly repairs not covered by your warranty.

Engine Oil Warning Light (Canadian Only)



This light tells you if there could be a problem with your engine oil pressure.

The light goes on when you turn your key to RUN or START. It goes off once you start your engine. That's just a check to be sure the light works. If it doesn't, be sure to have it fixed so it will be there to warn you if something goes wrong.

When the light *comes* on and *stays* on, it means that oil isn't flowing through your engine properly. You could be low on oil or you might have some other system problem.



CAUTION:

Don't keep driving if the oil pressure is low. If you do, your engine can become so hot that it catches fire. You or others could be burned. Check your oil as soon as possible and have your vehicle serviced.

NOTICE:

Damage to your engine from neglected oil problems can be costly and is not covered by your warranty.

Fuel Gage



Your fuel gage shows approximately how much fuel is in your tank. It works only when the ignition is in the RUN position.

Digital Gage

If the fuel level is within approximately 1 gallon (3.8 liters) of being full the letter F is shown.

If the fuel level is between 1 and 2 gallons (3.8 and 7.6 liters) from being empty, the letter E is shown. If the fuel supply gets down to approximately 1 gallon (3.8 liters) the E will flash and the FUEL LEVEL VERY LOW message will appear in the Driver Information Center (DIC).

Here are a few concerns some owners have had about the fuel gage. All these situations are normal and indicate that nothing is wrong with the fuel gage.

- At the gas station the gas pump shuts off before the gage reads F.
- It takes more (or less) gas to fill up than the gage said. For example, the gage read 8 GALLONS, but it took more (or less) than the tank's remaining capacity to fill it.
- The gage may change when you turn, stop, or speed up.

Fuel Data Panel



Your Fuel Data Panel tells you all you want to know about your fuel economy and how far you can travel with the fuel remaining. Here's how it works.

Press the AVG button to display the Average Mile Per Gallon (AVG MPG). You can also display it in metric units by pressing the ENG MET button.

When AVG MPG is selected, the total distance is divided by the total fuel used.

When the INST MPG (Instantaneous Fuel Economy) is selected, you will see what your fuel economy is at that instant. The computer takes a new reading twice every second. It will show economy up to 70 miles per gallon (or two liters per 100 kilometers).

To reset the average fuel economy, press the INFORMATION button until the AVG MPG is displayed on the Driver Information Center (DIC). Press and hold the RESET button until both the Fuel Data Center and DIC display reads 0.0. Another method to reset the average fuel economy is to press the AVG button to display the average miles per gallon then press the RESET button followed by the AVG button to reset this calculation.

The RANGE display shows how far the computer thinks you can travel with the fuel that is in your tank. The computer does not know what driving conditions will be like for the rest of your trip, so the range is estimated based on your recent fuel economy. Therefore, your range reading may change as your driving habits change. (Going from city to highway driving may increase the range reading.)

If the range display shows LO, you should stop for fuel as soon as possible.

Your computer needs enough data for the RANGE reading to work, however, so it will read LO when your vehicle is brand new (under 25 miles). It may also show LO if your battery has been disconnected.

Driver Information Center

Your Driver Information Center (DIC) display gives you the status of many of your vehicle's systems. The DIC is used to display driver selectable information and warning/status messages.

If more than one problem is detected, the Driver Information Center will automatically display all current messages.

Driver Information Center Control Buttons



INFORMATION Button

Pressing the INFORMATION button repeatedly will display the AVG MPH, MPG AVG, FUEL USED, OIL LIFE LEFT, and TIMER .

RESET Button

Pressing the RESET button will reset the AVG MPH, MPG AVG, FUEL USED, OIL LIFE LEFT, and TIMER when each function is displayed.

TIMER Button

The TIMER feature is like a stopwatch, in that you can clock the time it takes to get from one point to another.

To operate, press either the TIMER button or successively press the INFORMATION button until TIMER 00:00:00 is displayed on the Driver Information Center. Each of the fields for the HOURS, MINUTES, and SECONDS are two numeric digits.

Once TIMER 00:00:00 is displayed, press the TIMER button to start the timing feature. Press the TIMER button again to stop it. If you will be starting and stopping your Cadillac, during a trip for instance, the TIMER feature will automatically start timing where it left off when you last stopped. To reset it, press and hold the RESET button until the display reads TIMER 00:00:00. Press the INFORMATION button to exit from the TIMER function.

AVG MPH (Average Speed) Reset

Press repeatedly the INFORMATION button to display the AVG MPH, then press and hold the RESET button until 0.0 AVG MPH is displayed.

MPG AVG (Average Fuel Economy) Reset

Press repeatedly the INFORMATION button to display the MPG AVG, then press and hold the RESET button until 0.0 AVG MPG is displayed.

Fuel Used Reset

Press repeatedly the INFORMATION button to display the FUEL USED on the Driver Information Center, then press and hold the RESET button until FUEL USED 0.0 is displayed.

Oil Life Left Reset

Press repeatedly the INFORMATION button to display the OIL LIFE LEFT, then press and hold the RESET button until 100 OIL LIFE LEFT is displayed.

DISPLAY ON/OFF Button

Pressing this button will turn off the Driver Information Center, Electronic Climate Control and Fuel Data Center displays. If you have the digital cluster, the fuel gage, trip odometer and odometer will also turn off. While displays are off, pressing the INFORMATION button will turn on only the Driver Information Center. If any other button is pressed or a driving warning message needs to be displayed or fuel level falls below four gallons, all the displays will come back on.

TRIP SET Button

Press and hold this button to set the trip odometer back to zero.

ENG/MET (English/Metric Button)

Press this button to switch from English (miles and Degrees Fahrenheit), to metric (kilometers and Degrees Celsius).

Driver Information Center Messages

These messages will appear if there is a problem sensed in one of your vehicle's systems. Vehicles that are first sold in Canada will have a number after each message. This number helps to identify the message, which is only displayed in English.

APPLY BRAKE TO SHIFT - 46

This message will appear if your vehicle is in PARK (P) for about 15 seconds and the brake is not depressed. If you do not want this message to appear, you can cancel it by holding the OFF and the blue (cooler) button on the Electronic Climate Control panel for about five seconds. Hold the same two buttons again to have this message displayed.

A/C OVERHEATED - A/C COMPRESSOR OFF - 15

If the refrigerant system ever reaches an over-pressure condition, this message will appear to tell you that the air conditioning compressor has been turned off. Air conditioned air will not be delivered to cool your vehicle. If the pressure returns to a normal operating range, you must select AUTO, DEFOG, or DEFROST to start the compressor. If this message continues to appear, have the system repaired as soon as possible to avoid compressor damage.

BATTERY NO CHARGE - 07

This message will appear if your battery is not being charged. Have your electrical system checked by your Cadillac dealership at your earliest convenience.

BATTERY VOLTS HIGH - 08

This message shows that the electrical charging system is overcharging, (more than 16 volts). To avoid being stranded have the electrical system checked by your Cadillac dealership. You can reduce the charging overload by using the accessories. Turn on the lamps and radio, set the climate control on AUTO and the fan speed on HI, and turn the rear window defogger on. You can monitor battery voltage on the Driver Information Center by toggling the INFORMATION button. The normal range is 11.5 to 15.5 volts when the engine is running.

BATTERY VOLTS LOW - 06

This message will appear when the electrical system is charging less than 10 volts or if the battery has been drained. If this message appears immediately after starting, it is possible that the generator can still recharge the battery. The battery should recharge after driving a few miles and the message should go out. If this message appears while driving or after starting your vehicle and stays on, have it checked immediately to determine the cause of this problem. To help the generator recharge the battery quickly you can reduce the load on the electrical system by turning off your accessories. You can monitor battery voltage on the Driver Information Center by toggling the INFORMATION button. The normal range is 11.5 to 15.5 volts.

CHANGE TRANS FLUID - 47

This message will appear when it is time to replace the transaxle fluid. See your maintenance schedule booklet for the proper fluid and change intervals.

CHECK BRAKE FLUID - 37

This message is displayed to inform the driver that the brake reservoir fluid level is low. Check the brake reservoir level and add as needed. Have the brake system serviced by a Cadillac technician as soon as possible. If the brake warning light is on, follow the directions in that section.

CHECK COOLANT LEVEL - 04

This message will appear when there is a low level of engine coolant. Have the cooling system serviced by a Cadillac technician as soon as possible.

CHECK FUEL GAGE - 39

This message will appear when your fuel supply is less than four gallons and your display is turned off.

LOW OIL LEVEL - 36

For correct operation of the low oil sensing system, the vehicle should be on a level surface. A false LOW OIL LEVEL message may appear if the vehicle is parked on grades. The oil level sensing system does not check for actual oil level if the engine has been off for a short period of time, and the oil level is never sensed while the engine is running. If the LOW OIL LEVEL message appears, and your vehicle has been parked on level ground with the engine off for at least 30 minutes, your oil level should be checked by observing the oil dipstick. Prior to checking your oil level be sure your engine has been off for five minutes and your vehicle is on a level surface. Then check your dipstick and add oil if necessary. See "Engine Oil" in the Index.

CHECK WASHER FLUID - 25

This message will appear for a few seconds indicating that you need washer solvent.

CHANGE OIL SOON - 40

This message will appear when you have used 90% of the engine oil's expected life, based on your driving patterns.

CHANGE ENGINE OIL - 82

This means that the life of your engine oil has expired and it should be changed within 200 miles. See engine oil and filter recommendations in the Maintenance Schedule. After an oil change the Oil Life Index must be reset. See "Oil Life Indicator" in the Index on how to reset it.

CRUISE ENGAGED - 43

This message will appear for a few seconds when you select a speed at which to cruise.

ENGINE COOLANT HOT - 44

This message will appear when your engine coolant temperature is over 248° F (126° C). To avoid added strain on a hot engine turn off your Climate Control system. Stop and allow your vehicle to idle until it cools down or the message is removed. If it does not cool down, turn off your engine and have it serviced before driving it again. Severe engine damage can result from an overheated engine. See "Engine Overheating" in the Index.

ENGINE HOT - A/C COMPRESSOR OFF - 16

This message will appear when the Climate Control is in AUTO or DEFROST and the engine coolant is hotter than the normal operating temperature. To avoid added strain on a hot engine the air conditioning compressor is automatically turned off. When that happens, air conditioned air is not delivered. If the coolant temperature returns to normal, you must select AUTO, DEFOG or DEFROST to return to a normal A/C compressor operation.

FUEL LEVEL VERY LOW - 11

This message serves as a warning that the fuel level in your tank is critically low. It means you should stop for fuel immediately.

SERVICE A/C SYSTEM A/C COMPRESSOR OFF - 14

This message appears when the electronic sensors that control the A/C and heating system are no longer working. Have your Climate Control system serviced if you notice a drop in heating and A/C efficiency.

STARTING DISABLED DUE TO THEFT SYSTEM REMOVE IGNITION KEY - 33

This message will appear when the Personalized Automotive Security System (PASS-Key[®] II) senses that an improper ignition key is being used to try to start the vehicle. Check the ignition key for damage. If it is damaged, it may need to be replaced. If you see no damage, clean the pellet contacts with a soft cloth or napkin. Remove the ignition key and wait for the Driver Information Center to display WAIT 3 MINUTES. The instrument panel cluster will then run a timer and change the messages to WAIT 2 MINUTES, WAIT 1 MINUTE, and then START CAR. When the START CAR message is displayed, try again to start the engine.

SERVICE NOW - REFER TO OWNERS MANUAL - 02

This message appears if you have a problem with the Powertrain Control Module (PCM). To correct this problem have your vehicle serviced at your Cadillac dealership.

SERVICE RIDE CONTROL - 84

This message is displayed to indicate that the Suspension System is not operating properly. To correct this problem have your vehicle serviced at your Cadillac dealership.

STOP ENGINE ENGINE OVERHEATED - 42

This message will appear when your engine has overheated. Stop and turn your engine off immediately to avoid severe engine damage. See "Engine Overheating" in the Index.

SERVICE VEHICLE SOON - 03

This message will appear if there is a problem with your Emission Control System. If the SERVICE ENGINE SOON light on the instrument panel appears and then turns off, it is an indication that a temporary problem has cleared itself. Have your vehicle checked at your earliest convenience.

STOP ENGINE LOW OIL PRESSURE - 35

If this message appears while the engine is running, stop the engine and do not operate it until the cause of low oil pressure is corrected. Severe damage to the engine can result.

SERVICE AIR BAG SYSTEM - 83

If this message appears, there is a problem with your Supplemental Inflatable Restraint (Air Bag) system. Let only a qualified technician work on your vehicle. See your Cadillac dealer for service at once.

THEFT SYSTEM PROBLEM/CAR MAY NOT RESTART - 34

This message means there is a problem in the Personalized Automotive Security System (PASS-Key[®] II). PASS-Key[®] II will prevent the vehicle from restarting if it is turned off, so you should take the vehicle to a proper service center before turning the engine off. Never leave an unattended vehicle with the engine running. Once you are where you can get service, turn the engine off and then try to restart it. If the vehicle does not restart, the PASS-Key[®] II system will need servicing.

TRACTION ACTIVE - 91

This message will be displayed if Traction Control is being used to reduce wheel slippage.

TRACTION DISABLED - 88

This message will be displayed if a problem is noted in the Traction Control System. Have your vehicle serviced as soon as possible.

TRANS FLUID RESET - 48

With the engine not running and the ignition ON, press and hold the OFF and REAR DEFOG buttons until the TRANS FLUID RESET message appears in the Information Center (between five and 20 seconds).

TURN SIGNAL ON - 20

This message is a reminder, after driving about a mile, that you have your turn signal on.

TRUNK OPEN - 24

This message indicates that your trunk is open when the ignition is ON.

VERY LOW REFRIGERANT A/C COMPRESSOR OFF - 12

This message means that the Air Conditioning system detects a refrigerant level that is low enough to cause damage to the A/C compressor. To avoid damage, the A/C compressor automatically turns off and the Electronic Climate Control will automatically switch from AUTO to ECON and remain there. Have your A/C system serviced if this message appears.

Speed Sensitive Steering (SSS)

This system varies the amount of steering effort proportionate to your vehicle speed. Steering is easier at a lower speed for increased maneuverability and parking ease. As your vehicle speed increases, the steering effort is also increased proportionately. At highway speeds the amount of steering effort is greatly increased to provide a manual-like steering feel for maximum control and enhanced vehicle stability.

Speed Sensitive Suspension

The Speed Sensitive Suspension automatically controls the firmness of the car's ride by automatically controlling an actuator in each of the four struts. The system has three damping modes -- Comfort, Normal and Firm. Damping mode selection is controlled by the electronic control module according to vehicle speed conditions, lift/dive input, lateral acceleration switch input and any error conditions which may exist.

The control module is a computer used to control and monitor the Speed Sensitive Suspension system. It also controls the operation of the Speed Sensitive Steering. If the control module receives an incorrect feedback signal for two successive ignition cycles, an error code will be set in memory and a SERVICE RIDE CONTROL message will be displayed on the Driver Information Center. If the message should appear, have your vehicle serviced at your Cadillac dealer at your earliest convenience.

Oil Life Indicator

This feature lets you know when to change your engine oil. It's based upon the engine oil temperatures and your driving patterns.

To see the display press the INFORMATION button several times until XX OIL LIFE LEFT appears.

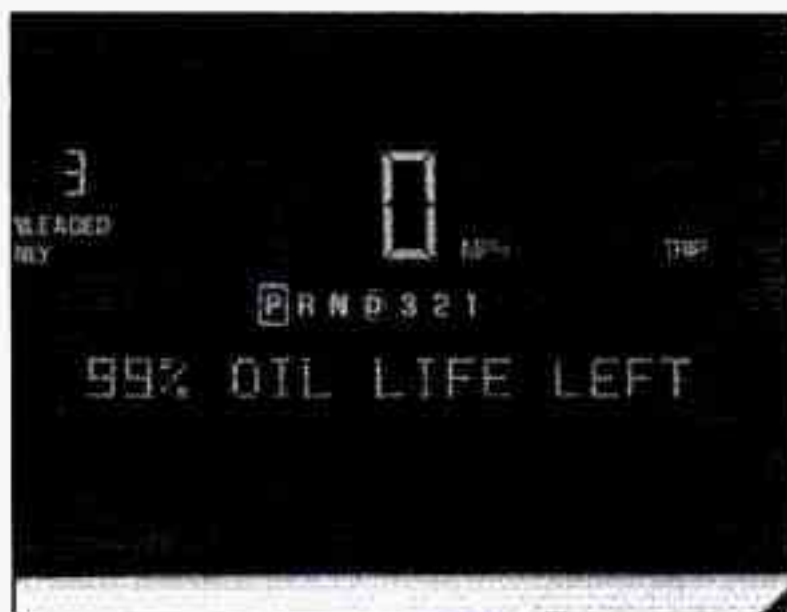

You'll see how much oil life you have left as a percentage. So, if you see 95 OIL LIFE LEFT, for example, that means that the way you're driving your car, 95% of your current oil life is still left.

The Oil Life Indicator may say to change the oil sooner than your maintenance schedule. This can happen if driving conditions, such as short trips in cold weather, cause shorter oil life. Always keep a written record of the mileage and date when you last changed your oil. For more information on when to change your oil, see the Cadillac Maintenance Schedule Booklet.

If you see CHANGE OIL SOON, it means that you have less than 10% of your oil life left and you should consider changing your engine oil.

If you see CHANGE ENGINE OIL, it means the oil life is gone and you should change the oil right away (certainly within 200 more miles [320 km]).

The system should indicate to change the oil between 3,000 miles (5 000 km) and 7,500 miles (12 500 km), but it may even indicate to change it before 3,000 miles under very severe conditions. It all depends on your driving patterns. If it's been 7,500 miles (12 500 km), it indicates to change the oil.

There are two things the system *doesn't* do:

- It can't sense heavy dust in the places where you drive. If you drive in a dusty area, you should change your oil every 3,000 miles (5 000 km) or three months (whichever comes first) unless the display says to change it even sooner than that.
- It doesn't check *how much* oil you have, so you'll still have to check for that. To see how, see "Engine Oil" in the Index.

When You've Changed the Oil

When new oil is put in, you'll need to reset your system. To do this, display the OIL LIFE INDEX by pressing the INFORMATION button. Then press and hold the RESET button until the display shows 100 OIL LIFE LEFT.

Electronic Level Control

The Electronic Level Control (ELC) system automatically adjusts the rear trim height in response to changes in vehicle loading. The system consists of an air compressor assembly, air dryer, exhaust solenoid, compressor relay, height sensor, air adjustable shocks and air tubing. The compressor is activated when the ignition is on and a sufficient amount of weight is added to the car to cause the rear suspension to deflect more than approximately one inch. The exhaust solenoid is powered at all times, allowing the system to exhaust with the ignition off when excess weight is removed from the vehicle.

If the system has a slight leak, the air compressor will run frequently for a few seconds each time.

For a larger air leak the air compressor may stay on for up to seven minutes. You should see your dealer for service, but you can keep driving your Cadillac.

NOTES



SECTION 3

COMFORT CONTROLS AND AUDIO SYSTEMS

In this section you'll find out how to operate the comfort control systems and audio systems offered with your Cadillac. Be sure to read about the particular system supplied with your vehicle.

YOUR CADILLAC AIR SYSTEM

Outside Air

Outside air flows through your vehicle when it is moving. It enters your vehicle through an inlet at the base of the windshield. Keep this area clear of debris. Under most operating conditions this system uses outside air when heating or cooling your vehicle. If you select the 60° F (16° C) AUTO setting, a door will close to stop the flow of most outside air allowing recirculated interior air to cool your vehicle. Your vehicle can also use this recirculate mode during normal auto air conditioning if maximum cooling is needed to maintain the selected temperature.

Air Outlets

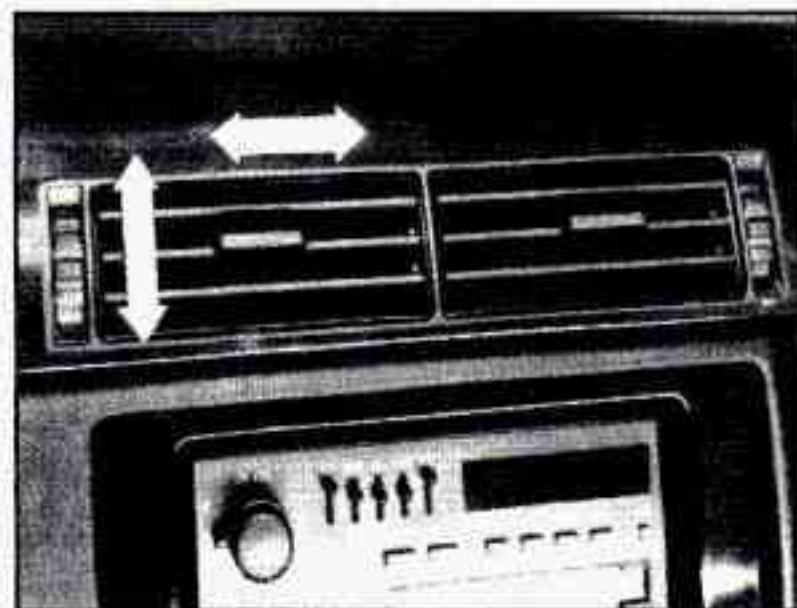

Air outlets are located in the center and at each side of the instrument panel. You can adjust the direction of airflow by moving the center control levers or stop the airflow by moving the lever located on each side of the outlets downward.

Electronic Climate Control (ECC)



Your vehicle has strategically placed electronic sensors that feed information to the vehicle's computer systems. Your vehicle can control the ventilation, heating and air conditioning automatically year round. The outside temperature, inside temperature setting, fan speeds and the ECC selection are displayed on a digital screen.

When the OFF button is selected, nothing is on, but air will still flow through your vehicle if you're moving. The system will try to keep the air at the selected temperature, but it might not be able to maintain it if it's hot, or cold, outside.

The OUTSIDE temperature is always displayed when your vehicle is running. You can change it from Celsius to Fahrenheit by pressing the ENG/MET (English/Metric) button.

Temperature

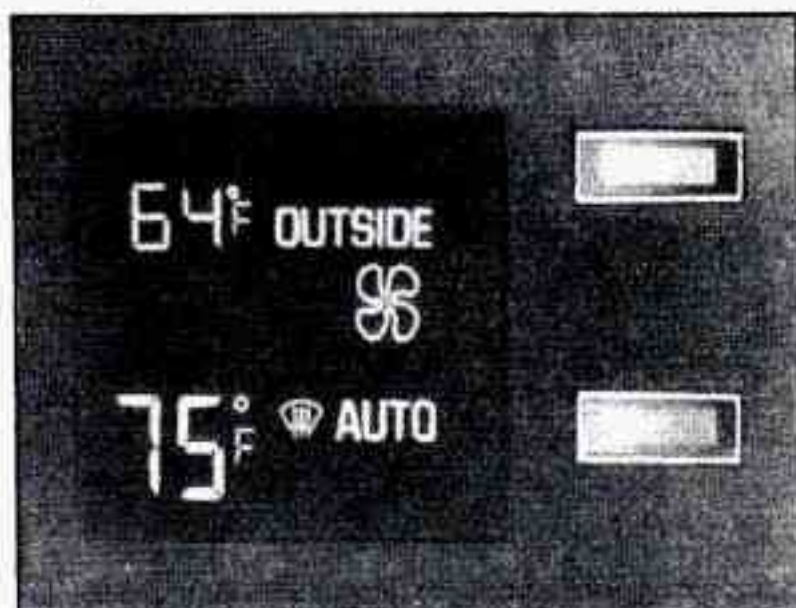

To select the temperature you want, press the blue button for a cooler setting or the red button for a warmer setting. The temperature setting will be displayed on the digital screen.

Temperatures from 65° F (18° C) to 85° F (29° C) may be selected for automatic temperature control. You may choose 60° F (16° C) for maximum cooling, and 90° F (33° C) for maximum heating. We recommend when first getting familiar with your vehicle, select 75° F (24° C). You may find that your own personal comfort requires a slightly higher or lower setting. Once you set the temperature, the system will automatically maintain the set temperature.

ECON

Even though the ECON setting is automatic, the air conditioning compressor does not operate and it won't remove humidity from the air. The system will, however, attempt to keep the air at the selected temperature. Use this setting in cold or cool weather to save fuel.

Use the AUTO setting when it's warm outside and you need to cool the air.

AUTO

With this setting, the air conditioning compressor cycles when needed to cool the air and it's all automatic. In cold weather when the system senses the need for heat, the airflow will be directed out the floor ducts. As the interior temperature approaches the desired setting, the blower speed will decrease and the airflow could be directed through the defroster and floor ducts. To maintain interior comfort, the airflow may move to the instrument panel air outlets and floor ducts (Bi-Level). On bright sunny days in cold weather, the airflow may come out of the A/C outlets (Bi-Level mode) to maintain comfort and prevent stuffiness.

Electronic Climate Control Features

A/C Purge

If your vehicle is sitting out on a hot day and you have it set on AUTO, the air will first flow out the floor air ducts for a few seconds. That is normal. This is to expel hot air in the air ducts. As the air is cooled, the flow will move through the A/C outlets. If you start your vehicle with the fan setting on HI it will skip the A/C Purge.

Cold Weather Purge

On cold days when your system is first turned on, in either the AUTO or ECON setting, and the fan setting is not on HI, a small amount of air will flow through the defroster duct while the system is waiting for the engine coolant to warm up enough to provide heat. This prevents your breath from fogging your windshield. As the coolant warms up, the blower fan speed will gradually increase and air will flow from the heater outlets, with some airflow to the windshield to prevent fogging under most normal conditions.

Manually Recirculate Inside Air

There may be times when you want less air from the outside. To recirculate the air from the inside, in the AUTO setting, just set the temperature to 60° F (16° C) and adjust your fan speed.

DEFOG

Press this button to divide the air between the windshield and the heater ducts. This is useful when fog appears on the windshield or side glass due to sudden rain or snowy conditions.

Fan Speeds

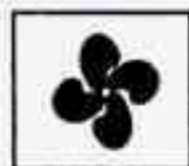

Press the fan symbol button until AUTO is displayed on the screen.

At this setting, the fan speed is controlled automatically.

If it is cold outside, the blower may not run in the maximum high fan speed right away. The system checks the temperature of the coolant to assure it is warm enough to provide heat. When the coolant is warm, the

controller allows the fan to gradually increase to a higher speed. This prevents cold air from blowing into the passenger compartment.

If you want the blower fan to run only at a fixed high speed, press the (upper) button until you see HI on the display.

If you want the fan speed to be automatic, but you like the fan speed to be higher than the AUTO setting, just press the fan button until HI/AUTO is shown on the display.

If you want the blower to run only at a fixed low speed, press the (lower) button until LO is shown on the display.

If you want the fan speed to run lower than the AUTO setting, press the button until AUTO LO is shown on the display.

DEFROSTER



Press this button to remove fog or frost from the windshield.

This setting sends most of the airflow to the windshield with only a small amount to the floor outlets.

The fan speed will work automatically to maintain your requested interior temperature. If you need more air directed to your windshield, you should select a higher fan speed.

In some cold start conditions, the AUTO blower fan speed may be limited until the engine cooling system warms up. This is normal to prevent windshield fogging.

It will help if you first clear any ice and snow from the hood and the air inlet (it's between the hood and the windshield).

REAR DEFOGGER

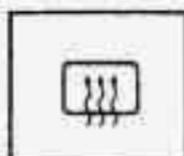

Press this button to turn on the rear defogger.

With it, your rear window and both outside rearview mirrors are heated. The system will automatically shut off after 10 minutes. If further defogging is desired, simply press the button again.

NOTICE:

Scraping the inside of your rear window could cut and damage the heating grids. Your warranty would not cover this damage. And don't put decals there; you might have to scrape them off.

Electronic Solar Sensor

The Electronic Solar Sensor is part of the Electronic Climate Control System.

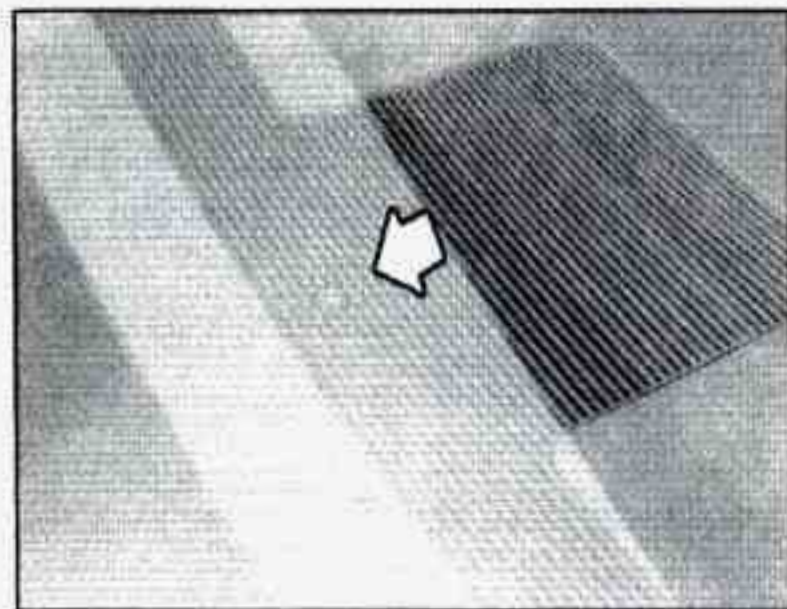

The sensor monitors the sun's solar radiation. The Electronic Climate Control system uses this information to automatically make the necessary temperature and airflow adjustments to maintain your comfort.

Rear Seat Air Outlet

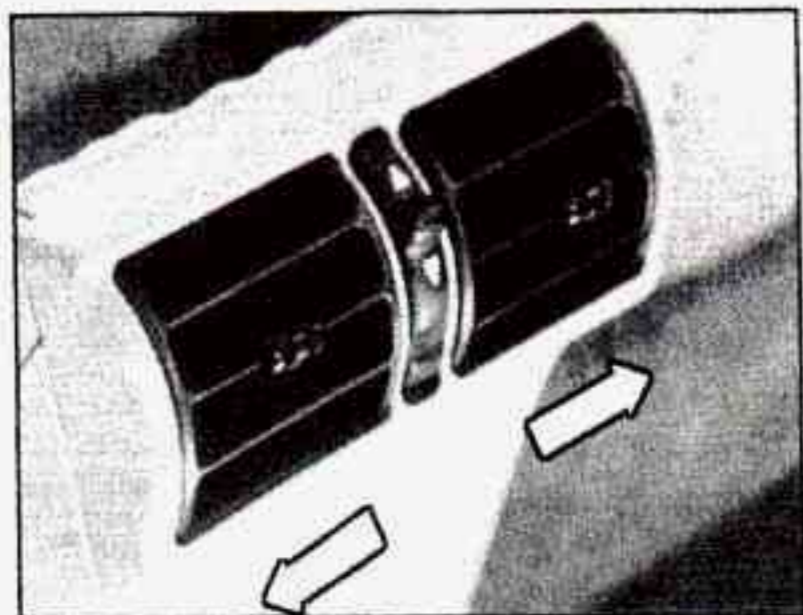

Move the center dial vent lever to direct airflow from either the upper or floor outlets.

To direct airflow from side to side, move the lever located in the center of each vent either to the right or to the left.

Heated Windshield (Option)

Front De-Ice

Here's how to use your heated windshield in cold weather to remove ice or frost quickly:

1. If any snow is piled up on the windshield, brush it away.
2. Start your Cadillac and leave it in PARK (P).



3. Press the DE-ICE switch. A light will come on to tell you it is working.
4. Try not to use other electrical equipment while the system is working.

The system will go off after a four-minute heating cycle. If you shift out of PARK (P), the system will only cycle for two minutes. If you want it to cycle again, press the switch. It will go on for two-minute cycles after that. If it has cleared your windshield before the cycle is over, you can turn it off by just pressing the switch again.

Use the defroster or defog features of the Electronic Climate Control to clear fog from the windshield as previously described. In warm weather the heated windshield system helps keep the vehicle's interior cool by blocking much of the sun's heat-producing radiation. The system's solar control properties also help reduce interior fading.

There is a metal film in the windshield which will block out some radio or microwave signals. Therefore, the heated windshield will reduce the useful range of devices such as garage door openers and radar detectors. (In certain states radar detectors are legal.)

AUDIO SYSTEMS

Your Delco[®] audio system has been designed to operate easily and give years of listening pleasure. You will get the most enjoyment out of your audio system if you acquaint yourself with it first. Find out what your Delco[®] system can do and how to operate all its controls, to be sure you're getting the most out of the advanced engineering that went into it.

FM Stereo

FM stereo will give you the best sound, however, FM signals will only reach about 10 to 40 miles (16 to 65 km). Tall buildings or hills may interfere with FM signals causing sounds to fade and may also cause popping, crackling or momentary hissing noises.

AM

The range for most AM stations is greater than for FM, especially at night. The longer range, however, can cause stations to interfere with each other. (FCC regulations require some AM radio stations to reduce signal strength at night to minimize interference.) AM can pick up noise from things like storms and power lines. Try reducing the treble to reduce this noise if you ever get it.

AMAX[®]

This means your radio can produce quality AM sound comparable to FM stereo. AMAX[®] reduces noise without reducing the high frequencies you need for the best sound. In addition to improved sound quality, AMAX[®] includes more stations on the AM band. You don't have to do anything in your radio because AMAX[®] is automatic.

AM Stereo

This means the Delco[®] system can receive C-QUAM[®] stereo broadcasts. Many AM stations around the country use C-QUAM[®] to produce stereo, although some do not. (C-QUAM[®] is a registered trademark of Motorola, Inc.) If your Delco[®] system can get C-QUAM[®], your ST stereo light will come on when you're receiving it.

Setting the Clock

Turn the ignition on and the radio off. Then:

To Set the Hour:

- Press SET, and within five seconds,
- Press and hold SEEK. When the clock gets to the correct hour, release.

To Set the Minutes:

- Press SET, and within five seconds,
- Press and hold SCAN. When the clock gets to the correct minute, release.

Your clock is set.

How to Operate Your Audio Systems

Your Cadillac will have one of the following Delco™ Radio Systems. Please read about the system that pertains to your vehicle.

AM/FM ETR Cassette Stereo with Equalizer



The Upper Knob

The upper knob does the following:

- It turns the radio on and off.
- It controls the volume.
- It lets you see what station you have. (When the radio is on, press the knob to display the station.)
- It tells you the time. (When the ignition is off, press the upper knob to display the time.)
- It allows you to hear the other side of a tape play. (When a cassette is inserted in the player, press the knob to change sides.)

Behind the upper knob is the balance control. It moves the sound between the left and right speakers.

The Lower Knob

Turn the lower knob to choose radio stations. Press the knob to switch between AM and FM.

Behind the lower knob is the fade control. It moves the sound between the front and rear speakers.

Finding a Station

SCAN: When you press this button, the SCAN indicator in the display will light and the radio will find the next station and stay there for about five seconds. Then it will go to the next station and pause, and keep doing that until you press either the SCAN button again or the upper knob.

SEEK: This button selects stations, but it doesn't keep moving as SCAN does. When you press SEEK the radio will automatically go to the next station and stay there.

AM-ST: Pressing this button enables the AM stereo reproduction of an AM station that is broadcasting in stereo. Switching to stereo on weaker non AM stereo stations improves fidelity, but may increase noise due to interference from power lines, neon signs, atmosphere conditions and unwanted stations. The STEREO indicator light only comes on when the radio is tuned to a clear, noise free station broadcasting C-QUAMSM AM stereo.

Pushbuttons: You can set the pushbuttons to get up to 14 favorite stations (seven on FM and seven more on AM.)

1. Choose either AM or FM.
2. Tune in a desired station.
3. Press the SET button.
4. Press one of the four pushbuttons within five seconds.
5. Repeat these steps for each of the four pushbuttons.

In addition to the four stations set as above, up to three additional stations may be present on each band by pressing two adjoining buttons at the same time.

1. Tune in a desired station.
2. Press the SET button.
3. Press any two adjoining pushbuttons at the same time within five seconds. (The station will return when the same two buttons are pressed again.)

Five Band Graphic Equalizer

The equalizer lets you set the bass, midrange and treble to sound just the way you want. The 60 and 250 controls work the bass side. The midrange is the 1K. The 3.5K and 10K are the treble sound controls.

We suggest that you start with the midrange (1K) control lever in the center. Then move the other controls until you get the sound you want.

Moving the control levers up gives you more sound in that range. Moving it down gives you less.

If the 10K control lever is near the top, you may hear a hissing sound. To eliminate it, move the 10K control lever down until the hiss disappears.

Your Cassette Tape Player

Your cassette tape player works best with tapes that are 30 to 45 minutes long on each side. Tapes longer than that are so thin that they may not work well in this player.

If you look at the tape, or on its label or box, it should say whether its bias, "equalization," is 70 microseconds (70 μ) or 120 microseconds (120 μ). Chrome (CRO₂) and metal tapes are 70 μ sec and standard iron tapes are 120 μ sec. For the best performance when playing chrome tapes, press the CRO₂ button.

CRO₂: This button sets tape bias. When playing high bias chrome or metal tapes, press CRO₂ to turn the feature on. When playing standard tapes, press the button again to turn the feature off.

To Play a Cassette Tape

1. Turn the radio on.
2. Insert the cassette through the tape door. (The "TAPE" indicator in the display will light.)

If you hear nothing or hear just a garbled sound, the cassette may not be in squarely. Press the STOP- EJECT button to remove the tape and start over. The tape equalization is automatically sensed and set. Inserting the cassette also automatically disables DNR[®] and activates DOLBY[®] noise reduction.

DNR[®] is the Dynamic Noise Reduction. It helps remove background hiss noise from the radio.

[®]DNR[®] is a registered trademark of National Semiconductor Corporation.

3. Once the tape is playing, use the upper and lower knobs to adjust the volume and balance, just as you do for the radio. Press the upper knob to change tape direction. The arrow in the display shows which direction the tape is being played.

Forward: To rapidly advance the tape, press the right arrow button and the tape will rapidly go Forward until you press the STOP button.

Reverse: To rapidly reverse the tape, press the left arrow button and the tape will rapidly Reverse until you press the STOP button.

SEARCH: When your are playing a tape, the search feature lets you advance ahead to the start of the next selection or rewind to the beginning of the selection being played. Pressing the right (Forward) or left (Reverse) arrow button will then advance or rewind to the beginning or end of the selection being played.

NOTICE:

There must be at least a five second pause between selections on the tape for the SEARCH feature to operate properly.

PUSH-PROG: Press this button (upper knob) to switch from playing one side of the tape to the other.

STOP-EJECT: Press this button to stop or remove the tape.

The Delco[®] Active Audio Music System with Cassette Player (Option)



This optional music system is the Delco[®] Active Audio System with dual playback. The system includes an AM and FM stereo electronically tuned radio receiver with an integral cassette, and eleven Delco custom designed speakers with very specific frequency ranges. It includes a digital clock.

The Upper Knob

The upper knob does the following:

- It turns the radio on and off.
- It controls the volume.
- It lets you see what station you have. (When the radio is on, press the RCL/PROG knob to display the station.)
- It tells you the time. (When the ignition is off, press the RCL/PROG knob to display the time.)

- It allows you to hear the other side of tape play. (When a cassette is inserted into the player, press the knob to change sides.)

Behind the upper knob is the balance control. It moves the sound between the left and right speakers.

The Lower Knob

Turn the lower knob to choose radio stations. Press the knob to switch between AM and FM.

Behind the lower knob is the fade control. It moves the sound between the front and rear speakers.

Finding a Station

SCAN: When you press this button, up or down, the SCAN indicator in the display will light and the radio will find the next station and stay there for about five seconds. Then it will go to the next station and pause, and keep doing that until you press either the SCAN button again or the upper knob.

SEEK: This button selects stations, but it doesn't keep moving as SCAN does. When you press SEEK, up or down, the radio will automatically go to the next station and stay there.

Pushbuttons: You can set the pushbuttons to get up to 10 favorite stations (five on FM and five more on AM.)

- Choose either AM or FM.
- Tune in a desired station.
- Press the SET button.
- Press one of the five pushbuttons within five seconds.
- Repeat these steps for each of the five pushbuttons.

Setting the Tone

BASS: The slide control increases or decreases the bass response tone. Moving the control to the right increases bass while moving it to the left decreases it.

TREB: The slide control increases or decreases the treble response tone. Moving the control to the right increases treble while moving to the left decreases it.

Your Cassette Tape Player

Your cassette tape player works best with tapes that are 30 to 45 minutes long on each side. Tapes longer than that are so thin that they may not work well in this player.

If you look at the tape, or on its label or box, it should say whether its bias, "equalization," is 70 microseconds (70 μ) or 120 microseconds (120 μ). Chrome and metal tapes are 70 μ sec and standard iron tapes are 120 μ sec. Your tape player will adjust automatically for either type of cassette tape.

To Play a Cassette Tape

1. Turn the radio on.
2. Insert the cassette through the tape door. (The TAPE indicator in the display will light.)

If you hear nothing or hear just a garbled sound, the cassette may not be in squarely. Press the EJCT button to remove the tape and start over. The tape equalization is automatically sensed and set. Inserting the cassette also activates DOLBY[®] noise reduction.

3. Once the tape is playing, use the upper and lower knobs to adjust the volume and balance, just as you do for the radio. Press the upper knob to change tape direction. The arrow in the display shows which direction the tape is being played.

FWD: Press this button to go forward rapidly to another part of the tape.

REV: Press this button to reverse the tape.

PREV: Press this button to go back to the beginning of the track. Pressing this button when in the pause period between tracks will take it back to the start of the track preceding the pause.

NEXT: Press this button to advance to the next selection.

ST/PL: Press this button and the tape will stop without ejecting it and the radio will start to play. Press it again and the tape will start to play again.

EJCT: Press this button to remove the tape.

The Delco[®] Active Audio Music System with Cassette and CD Player (Option)



This optional music system is the Delco[®] Active Audio System with dual playback. The system includes an AM and FM Stereo electronically tuned radio receiver with an integral cassette and compact disc (CD) player and eleven Delco[®] custom designed speakers with very specific frequency ranges. It includes a digital clock.

The Upper Knob

The upper knob does the following:

- It turns the radio on and off.
- It controls the volume.
- It lets you see what station you have. (When the radio is on, press the RCL/PROG knob to display the station.)
- It tells you the time. (When the ignition is off, press the RCL/PROG knob to display the time.)
- It allows you to hear the other side of tape play. (When a cassette is inserted into the player, press the knob to change sides.)

The Lower Knob

Turn the lower knob to choose radio stations. Press the knob to switch between AM and FM.

Behind the lower knob is the fade control. It moves the sound between the front and rear speakers.

Finding a Station

SCAN: When you press this button, up or down, the SCAN indicator in the display will light and the radio will find the next station and stay there for about five seconds. Then it will go to the next station and pause, and keep doing that until you press either the SCAN button again or the upper knob.

SEEK: This button selects stations, but it doesn't keep moving as SCAN does. When you press SEEK, up or down, the radio will automatically go to the next station and stay there.

Pushbuttons: You can set the pushbuttons to get up to 10 favorite stations (five on FM and five more on AM).

1. Choose either AM or FM.
2. Tune in the station.
3. Press the SET button.
4. Press one of the five pushbuttons within five seconds.
5. Repeat these steps for each of the five pushbuttons.

Setting the Tone

BASS: The slide control increases or decreases the bass response tone. Moving the control to the right increases bass while moving it to the left decreases it.

TREBLE: The slide control increases or decreases the treble response tone. Moving the control to the right increases the treble while moving it to the left decreases it.

Your Cassette Tape Player

Your cassette tape player works best with tapes that are 30 to 45 minutes long on each side. Tapes longer than that are so thin that they may not work well in this player.

If you look at the tape, or on its label or box, it should say whether its bias, "equalization," is 70 microseconds (70 μ) or 120 microseconds (120 μ). Chrome and metal tapes are 70 μ sec and standard iron tapes are 120 μ sec. Your tape player will adjust automatically for either type of cassette tape.

To Play a Cassette Tape

1. Turn the radio on.
2. Insert the cassette through the tape door. (The TAPE indicator in the display will light.)

If you hear nothing or hear just a garbled sound, the cassette may not be in squarely. Press the EJCT button to remove the tape and start over. The tape equalization is automatically sensed and set. Inserting the cassette also activates DOLBY[®] noise reduction.

3. Use the upper and lower knobs to adjust the volume and balance, once the tape is playing, just as you do for the radio. Press the upper knob to change tape direction. The arrow in the display shows which direction the tape is being played.

FWD and REV: Press the FWD button to go forward rapidly to another part of the tape. Press the REV button to reverse the tape.

ST/PL: Press this button in either SEEK, SCAN, FWD or REV to stop tape movement and switch to radio without ejecting the tape. (In ST/PL the radio may be tuned by the tuner knob only.)

EJCT: Press this button to remove the tape. EJCT is operational even when the ignition or the radio is off.

To Play a Compact Disc

NOTICE:

Before you begin, please note: don't use the mini-discs that are called "singles" (even with an adapter). They won't eject. Use full-size compact discs only.

1. Turn the radio on.
2. Insert the CD (label side up) partway into the slot. The player will pull it in. Wait a few seconds and the CD will play. Then only the time of day and CD will display.

If the CD comes back out, check to see if:

- The disc is upside down.
- The disc is dirty, scratched or wet.
- There is too much moisture in the air. If there is, wait about an hour and try it again.

ERR: This error message is displayed if you have a condition of either extreme temperature, moisture or an incorrect CD. The CD will automatically be ejected. When conditions are back to normal the CD should play again.

RCL/PROG: Press the recall/program button once to see what track is being played. Within five seconds press it a second time to see how long the track has been playing. Press it a third time to see the time of day.

REV: Press and hold the reverse button to return rapidly within a track. Release it to play the passage. The elapsed time will be displayed to show the reverse progress of the CD.

FWD: Press and hold this forward button to advance rapidly within a track. Release it to resume playing. Elapsed time will be displayed to show the forward progress of the CD.

PREV: Press this button to go back to the beginning of the track. Pressing this button when in the pause period between tracks will take it back to the start of the track preceding the pause.

NEXT: Press this button to advance to the next track.

ST/PL: Press this button and the tape or CD will stop without ejecting and the radio will start to play. Press it again and the tape or CD will start to play again.

EJCT: Press this button to remove the CD or tape. If you have both a CD and tape in the player, then the other playback media will start to play. Press it again and the other media will eject.

COMP: Pressing COMP makes soft and loud passages more equal in volume. For example, classical and jazz music have very quiet and very loud passages in the same tune. The COMP display will light as long as COMP is on.

TAPE and CD Operation

With both a tape and a CD inserted, both the TP and CD indicators in the display will be lit and either the TP or CD (LED) will also be lit, depending on which has the current priority.

TP-CD: Press the lower knob to switch between tape and CD.

Tips about Your Audio System

Be aware that hearing damage from loud noise is almost undetectable until it is too late. Your hearing can adapt to higher volumes of sound. Sound that seems normal can be loud and harmful to your hearing. Take precautions by adjusting the volume control on your radio to a safe sound level before your hearing adapts to it.

To help avoid hearing loss or damage:

- Adjust the volume control to the lowest setting.
- Increase volume slowly until you hear comfortably and clearly.

NOTICE:

Before you add any sound equipment to your vehicle -- like a tape player, CB radio, mobile telephone or two-way radio -- be sure you can add what you want. If you can, it's very important to do it properly. Added sound equipment may interfere with the operation of your vehicle's engine, Delco[®] radio or other systems, and even damage them. And, your vehicle's systems may interfere with the operation of sound equipment that has been added improperly.

So before adding sound equipment, check with your dealer and be sure to check Federal rules covering mobile radio and telephone units.

Care of Your Cassette Tape Player

A tape player that is not cleaned regularly can cause reduced sound quality, ruined cassettes or a damaged mechanism. Cassette tapes should be stored in their cases away from contaminants, direct sunlight and extreme heat. If they aren't, they may not operate properly or cause failure of the tape player.

Your tape player should be cleaned regularly each month or after every 50 hours of use. If you notice a reduction in sound quality, try a known good cassette to see if the tape or the tape player is at fault. If this other cassette has no improvement in sound quality, clean the tape player.

Cleaning may be done with a scrubbing action, non-abrasive cleaning cassette. This system uses a cleaning cassette with pads which scrub the tape head as the hubs of the cleaner cassette turn. It is normal for the cartridge to eject while cleaning. Insert the cassette at least three times to ensure thorough cleaning. A scrubbing action cleaning cassette is available through your Cadillac dealership.

You may also choose a non-scrubbing action, wet-type cleaner which uses a cassette with a fabric belt to clean the tape head. This type of cleaning cassette will not eject. It may not clean as thoroughly as the scrubbing type cleaner.

Cassette tapes are subject to wear and the sound quality may degrade over time. Always make sure that the cassette tape is in good condition before you have your tape player serviced.

Care of Your Compact Discs

Handle discs carefully. Store them in their original cases or other protective cases and away from direct sunlight and dust. If the surface of a disc is soiled, dampen a clean, soft cloth in a mild, neutral detergent solution and clean it, wiping from the center to the edge.

Be sure never to touch the signal surface when handling discs. Pick up discs by grasping the outer edges or the edge of the hole and the outer edge.

Power Antenna Mast Care

Your power antenna will look its best and work well if it's cleaned from time to time.

To Clean the Antenna Mast

1. Turn on the ignition and radio to raise the antenna to full mast extension.
2. Dampen a clean cloth with mineral spirits or equivalent solvent.
3. Wipe the cloth over the mast sections, removing any dirt.
4. Wipe dry with a clean cloth before retracting.
5. Make the antenna go up and down by turning the radio or ignition on and off.
6. Then repeat if necessary.

NOTICE:

Don't lubricate the power antenna. Lubrication could damage it.

NOTICE:

Before entering an automatic car wash, turn off your radio to make the power antenna go down. This will prevent the mast from possibly getting damaged. If the antenna does not go down when you turn the radio off, it may be damaged or need to be cleaned. In either case, lower the antenna by hand by carefully pressing the antenna down.



SECTION 4

YOUR DRIVING AND THE ROAD



Here you'll find information about driving on different kinds of roads and in varying weather conditions. We've also included many other useful tips on driving.

DEFENSIVE DRIVING

The best advice anyone can give about driving is: Drive defensively.

Please start with a very important safety device in your Cadillac: Buckle up. (See "Safety Belts" in the Index.)

Defensive driving really means "be ready for anything." On city streets, rural roads, or freeways, it means "always expect the unexpected."

Assume that pedestrians or other drivers are going to be careless and make mistakes. Anticipate what they might do. Be ready for their mistakes.

Rear-end collisions are about the most preventable of accidents. Yet they are common. Allow enough following distance. It's the best defensive driving maneuver, in both city and rural driving. You never know when the vehicle in front of you is going to brake or turn suddenly.

DRUNKEN DRIVING

Death and injury associated with drinking and driving is a national tragedy. It's the number one contributor to the highway death toll, claiming thousands of victims every year.

Alcohol affects four things that anyone needs to drive a vehicle:

- Judgment
- Muscular Coordination
- Vision
- Attentiveness

Police records show that almost half of all motor vehicle-related deaths involve alcohol. In most cases, these deaths are the result of someone who was drinking and driving. In recent years, some 18,000 annual motor vehicle-related deaths have been associated with the use of alcohol, with more than 300,000 people injured.

Many adults -- by some estimates, nearly half the adult population -- choose never to drink alcohol, so they never drive after drinking. For persons under 21, it's against the law in every U.S. state to drink alcohol. There are good medical, psychological and developmental reasons for these laws.

The obvious way to solve this highway safety problem is for people never to drink alcohol and then drive. But what if people do? How much is "too much" if the driver plans to drive? It's a lot less than many might think. Although it depends on each person and situation, here is some general information on the problem.

The Blood Alcohol Concentration (BAC) of someone who is drinking depends upon four things:

- How much alcohol consumed
- The drinker's body weight
- The amount of food that is consumed before and during drinking
- The length of time it has taken the drinker to consume the alcohol

According to the American Medical Association, a 180-pound (82 kg) person who drinks three 12-ounce (355 ml) bottles of beer in an hour will end up with a BAC of about 0.06 percent. The person would reach the same BAC by drinking three 4-ounce (120 ml) glasses of wine or three mixed drinks if each had 1-1/2 ounces (45 ml) of a liquor like whiskey, gin or vodka.

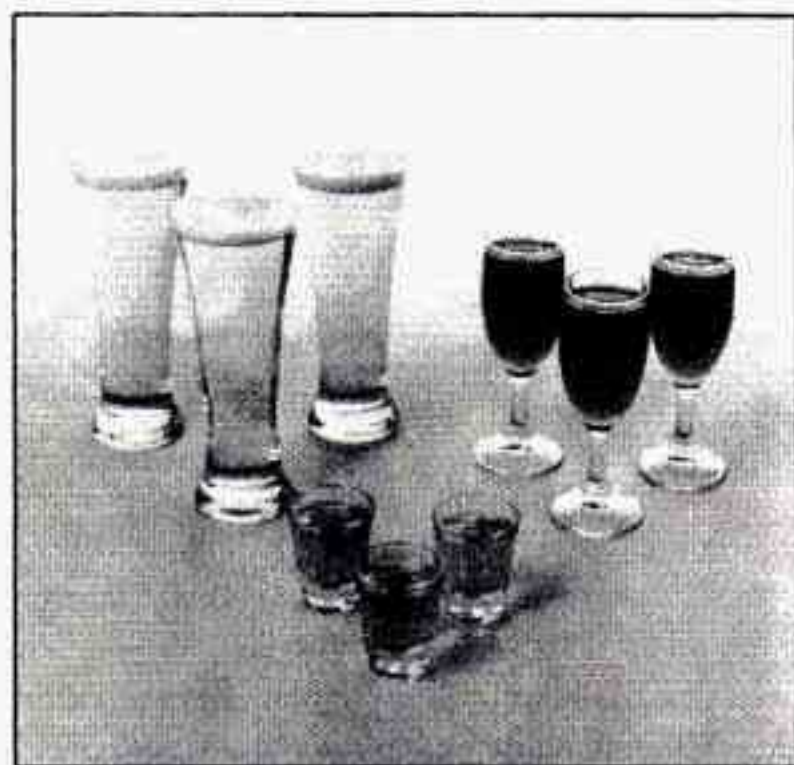

It's the amount of alcohol that counts. For example, if the same person drank three double martinis (3 ounces or 90 ml of liquor each) within an hour, the person's BAC would be close to 0.12 percent. A person who consumes food just before or during drinking will have a somewhat lower BAC level.

There is a gender difference, too. Women generally have a lower relative percentage of body water than men. Since alcohol is carried in body water, this means that a woman generally will reach a higher BAC level than a man of her same body weight when each has the same number of drinks.

The law in many U.S. states sets the legal limit at a BAC of 0.10 percent. In a growing number of U.S. states, and throughout Canada, the limit is 0.08 percent. In some other countries it's even lower. The BAC limit for all commercial drivers in the U.S. is 0.04 percent.

The BAC will be over 0.10 percent after three to six drinks (in one hour). Of course, as we've seen, it depends on how much alcohol is in the drinks, and how quickly the person drinks them.

But the ability to drive is affected well below a BAC of 0.10 percent. Research shows that the driving skills of many people are impaired at a BAC approaching 0.05 percent, and that the effects are worse at night. All drivers are impaired at BAC levels above 0.05 percent. Statistics show that the chance of being in a collision increases sharply for drivers who have a BAC of 0.05 percent or above. A driver with a BAC level of 0.06 percent has doubled his or her chance of having a collision. At a BAC level of 0.10 percent, the chance of this driver having a collision is twelve times greater; at a level of 0.15 percent, the chance is twenty-five times greater!

The body takes about an hour to rid itself of the alcohol in one drink. No amount of coffee or number of cold showers will speed that up. "I'll be careful" isn't the right answer. What if there's an emergency, a need to take sudden action, as when a child darts into the street? A person with even a moderate BAC might not be able to react quickly enough to avoid the collision.

There's something else about drinking and driving that many people don't know. Medical research shows that alcohol in a person's system can make crash injuries worse, especially injuries to the brain, spinal cord or heart. This means that when anyone who has been drinking -- driver or passenger -- is in a crash, that person's chance of being killed or permanently disabled is higher than if the person had not been drinking.

CAUTION:

Drinking and then driving is very dangerous. Your reflexes, perceptions, attentiveness and judgment can be affected by even a small amount of alcohol. You can have a serious -- or even fatal -- collision if you drive after drinking. Please don't drink and drive or ride with a driver who has been drinking. Ride home in a cab; or if you're with a group, designate a driver who will not drink.

CONTROL OF A VEHICLE

You have three systems that make your vehicle go where you want it to go. They are the brakes, the steering and the accelerator. All three systems have to do their work at the places where the tires meet the road.

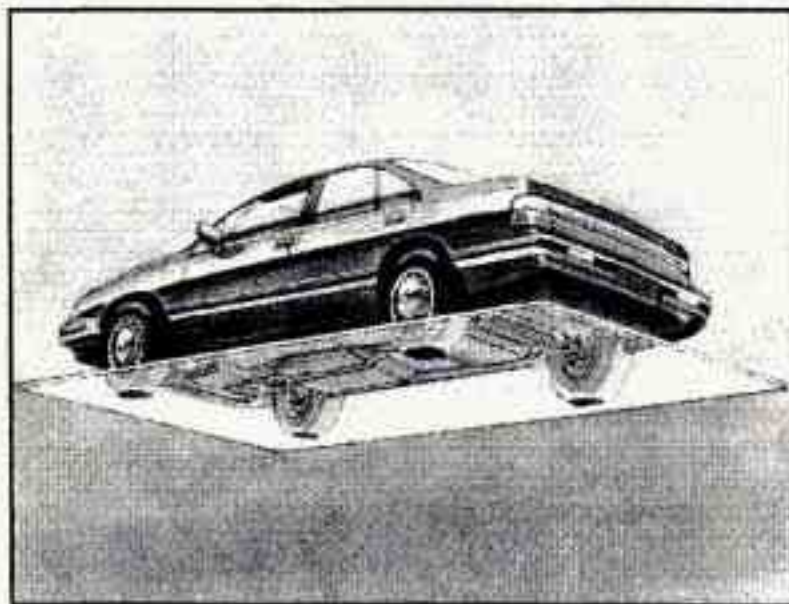

Sometimes, as when you're driving on snow or ice, it's easy to ask more of those control systems than the tires and road can provide. That means you can lose control of your vehicle.

BRAKING

Braking action involves *perception time* and *reaction time*.

First, you have to decide to push on the brake pedal. That's *perception time*. Then you have to bring up your foot and do it. That's *reaction time*.

Average *reaction time* is about 3/4 of a second. But that's only an average. It might be less with one driver and as long as two or three seconds or more with another. Age, physical condition, alertness, coordination, and eyesight all play a part. So do alcohol, drugs and frustration. But even in 3/4 of a second, a vehicle moving at 60 mph (100 km/h) travels 66 feet (20 m). That could be a lot of distance in an emergency, so keeping enough space between your vehicle and others is important.

And, of course, actual stopping distances vary greatly with the surface of the road (whether it's pavement or gravel); the condition of the road (wet, dry, icy); tire tread; and the condition of your brakes.

Avoid needless heavy braking. Some people drive in spurts -- heavy acceleration followed by heavy braking -- rather than keeping pace with traffic. This is a mistake. Your brakes may not have time to cool between hard stops. Your brakes will wear out much faster if you do a lot of heavy braking. If you keep pace with the traffic and allow realistic following distances, you will eliminate a lot of unnecessary braking. That means better braking and longer brake life.

If your engine ever stops while you're driving, brake normally but don't pump your brakes. If you do, the pedal may get harder to push down. If your engine stops, you will still have some power brake assist. But you will use it when you brake. Once the power assist is used up, it may take longer to stop and the brake pedal will be harder to push.

Anti-Lock Brakes (ABS)

Your Cadillac has an advanced electronic braking system that will help prevent a braking skid.



This light on the instrument panel will come on briefly when you start your vehicle.

When you start your vehicle and begin to drive away, you may hear a momentary motor or clicking noise. And you may even notice that your brake pedal moves a little while this is going on. This is the ABS system testing itself. If there's a problem with the anti-lock brake system, the anti-lock brake system warning light will stay on.

See "Anti-Lock Brake System Warning Light" in the Index.



Here's how anti-lock works. Let's say the road is wet. You're driving safely. Suddenly an animal jumps out in front of you.

You slam on the brakes. Here's what happens with ABS.

A computer senses that wheels are slowing down. If one of the wheels is about to stop rolling, the computer will separately work the brakes at each front wheel and at the rear wheels.

The anti-lock system can change the brake pressure faster than any driver could. The computer is programmed to make the most of available tire and road conditions.



You can steer around the obstacle while braking hard.

As you brake, your computer keeps receiving updates on wheel speed and controls braking pressure accordingly.

Remember: Anti-lock doesn't change the time you need to get your foot up to the brake pedal. If you get too close to the vehicle in front of you, you won't have time to apply your brakes if that vehicle suddenly slows or stops. Always leave enough room up ahead to stop, even though you have anti-lock brakes.

To Use Anti-Lock

Don't pump the brakes. Just hold the brake pedal down and let anti-lock work for you. You may hear the anti-lock pump or motor operate, and feel the brake pedal pulsate, but this is normal.

Traction Control System

Your vehicle has a traction control system that limits wheel spin. This is especially useful in slippery road conditions. The system operates only if it senses that one or both of the front wheels are spinning or beginning to lose traction. When this happens, the system works the front brakes and reduces engine power (by shutting off fuel injectors) to limit wheel spin.

The TRACTION ACTIVE message will display on the Driver Information Center when the traction control system is limiting wheel spin. See “Driver Information Center Messages” in the Index. You may feel the system working, or you may notice some noise, but this is normal. If your vehicle is in cruise control when the traction control system begins to limit wheel spin, the cruise control will automatically disengage. When road conditions allow you to safely use it again, you may re-engage the cruise control. (See “Cruise Control” in the Index.)

The TRACTION DISABLED message will display on the Driver Information Center to let you know if there’s a problem with your traction control system. See “Driver Information Center Messages” in the Index. When this message is displayed, the system will not limit wheel spin. Adjust your driving accordingly.

The traction control system automatically comes on whenever you start your vehicle. To limit wheel spin, especially in slippery road conditions, you should always leave the system on. But you can turn the traction control system off if you ever need to. (You should turn the system off if your vehicle ever gets stuck in sand, mud, ice or snow. See “Rocking Your Vehicle” in the Index.)



To turn the system off, press the button labeled TRAC OFF located inside of the glove box. The TRACTION OFF message will display on the Driver Information Center. If the system is limiting wheel spin when you press the button, the system won't turn off right away. It will wait until there's no longer a current need to limit wheel spin.

You can turn the system back on at any time by pressing the button again. The TRACTION ON message will display briefly on the Driver Information Center.

Braking in Emergencies

Use your anti-lock braking system when you need to. With anti-lock, you can steer and brake at the same time. In many emergencies, steering can help you more than even the very best braking.

STEERING

Power Steering

If you lose power steering assist because the engine stops or the system is not functioning, you can steer but it will take much more effort.

Steering Tips

Driving on Curves

It's important to take curves at a reasonable speed.

A lot of the "driver lost control" accidents mentioned on the news happen on curves. Here's why:

Experienced driver or beginner, each of us is subject to the same laws of physics when driving on curves. The traction of the tires against the road surface makes it possible for the vehicle to change its path when you turn the front wheels. If there's no traction, inertia will keep the vehicle going in the same direction. If you've ever tried to steer a vehicle on wet ice, you'll understand this.

The traction you can get in a curve depends on the condition of your tires and the road surface, the angle at which the curve is banked, and your speed. While you're in a curve, speed is the one factor you can control.

Suppose you're steering through a sharp curve. Then you suddenly accelerate. Both control systems -- steering and acceleration -- have to do their work where the tires meet the road. Unless you have traction control and the system is on, adding the sudden acceleration can demand too much of those places. You can lose control.

What should you do if this ever happens? Ease up on the accelerator pedal, steer the vehicle the way you want it to go, and slow down.

Speed limit signs near curves warn that you should adjust your speed. Of course, the posted speeds are based on good weather and road conditions. Under less favorable conditions you'll want to go slower.

If you need to reduce your speed as you approach a curve, do it before you enter the curve, while your front wheels are straight ahead.

Try to adjust your speed so you can "drive" through the curve. Maintain a reasonable, steady speed. Wait to accelerate until you are out of the curve, and then accelerate gently into the straightaway.

Steering in Emergencies

There are times when steering can be more effective than braking. For example, you come over a hill and find a truck stopped in your lane, or a car suddenly pulls out from nowhere, or a child darts out from between parked cars and stops right in front of you. You can avoid these problems by braking -- if you can stop in time. But sometimes you can't; there isn't room. That's the time for evasive action -- steering around the problem.

Your Cadillac can perform very well in emergencies like these. First apply your brakes. It is better to remove as much speed as you can from a possible collision. Then steer around the problem, to the left or right depending on the space available.

An emergency like this requires close attention and a quick decision. If you are holding the steering wheel at the recommended 9 and 3 o'clock positions, you can turn it a full 180 degrees very quickly without removing either hand. But you have to act fast, steer quickly, and just as quickly straighten the wheel once you have avoided the object.



The fact that such emergency situations are always possible is a good reason to practice defensive driving at all times and wear safety belts properly.

OFF-ROAD RECOVERY

You may find sometime that your right wheels have dropped off the edge of a road onto the shoulder while you're driving.

If the level of the shoulder is only slightly below the pavement, recovery should be fairly easy. Ease off the accelerator and then, if there is nothing in the way, steer so that your vehicle straddles the edge of the pavement. You can turn the steering wheel up to 1/4 turn until the right front tire contacts the pavement edge. Then turn your steering wheel to go straight down the roadway.

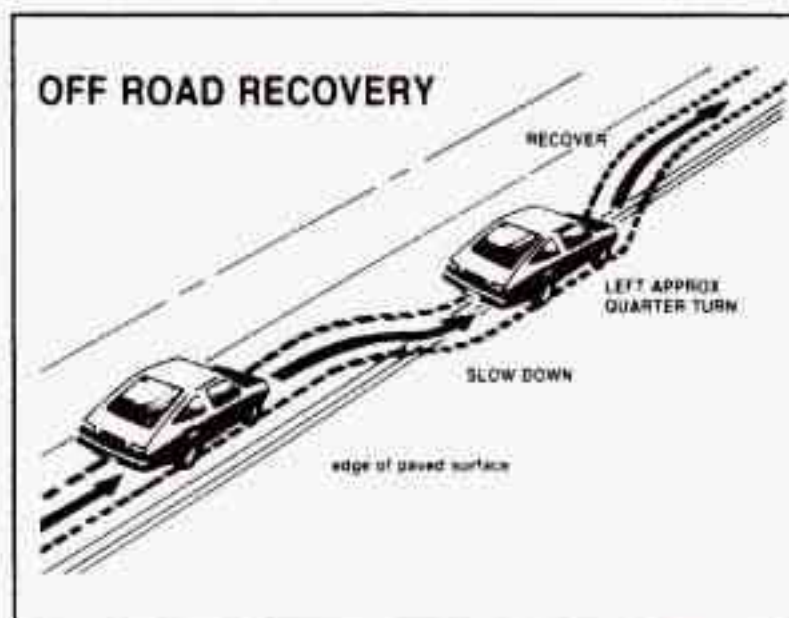

PASSING

The driver of a vehicle about to pass another on a two-lane highway waits for just the right moment, accelerates, moves around the vehicle ahead, then goes back into the right lane again. A simple maneuver?

Not necessarily! Passing another vehicle on a two-lane highway is a potentially dangerous move, since the passing vehicle occupies the same lane as oncoming traffic for several seconds. A miscalculation, an error in judgment, or a brief surrender to frustration or anger can suddenly put the passing driver face to face with the worst of all traffic accidents -- the head-on collision.

So here are some tips for passing:

- “Drive ahead.” Look down the road, to the sides, and to crossroads for situations that might affect your passing patterns. If you have any doubt whatsoever about making a successful pass, wait for a better time.
- Watch for traffic signs, pavement markings, and lines. If you can see a sign up ahead that might indicate a turn or an intersection, delay your pass. A broken center line usually indicates it’s all right to pass (providing the road ahead is clear). Never cross a solid line on your side of the lane or a double solid line, even if the road seems empty of approaching traffic.
- Do not get too close to the vehicle you want to pass while you’re awaiting an opportunity. For one thing, following too closely reduces your area of vision, especially if you’re following a larger vehicle. Also, you won’t have adequate space if the vehicle ahead suddenly slows or stops. Keep back a reasonable distance.
- When it looks like a chance to pass is coming up, start to accelerate but stay in the right lane and don’t get too close. Time your move so you will be increasing speed as the time comes to move into the other lane. If the way is clear to pass, you will have a “running start” that more than makes up for the distance you would lose by dropping back. And if something happens to cause you to cancel your pass, you need only slow down and drop back again and wait for another opportunity.
- If other cars are lined up to pass a slow vehicle, wait your turn. But take care that someone isn’t trying to pass you as you pull out to pass the slow vehicle. Remember to glance over your shoulder and check the blind spot.
- Check your mirrors, glance over your shoulder, and start your left lane change signal before moving out of the right lane to pass. When you are far enough ahead of the passed vehicle to see its front in your inside mirror, activate your right lane change signal and move back into the right lane. (Remember that your right outside mirror is convex. The vehicle you just passed may seem to be farther away from you than it really is.)
- Try not to pass more than one vehicle at a time on two-lane roads. Reconsider before passing the next vehicle.

- Don't overtake a slowly moving vehicle too rapidly. Even though the brake lamps are not flashing, it may be slowing down or starting to turn.
- If you're being passed, make it easy for the following driver to get ahead of you. Perhaps you can ease a little to the right.

LOSS OF CONTROL

Let's review what driving experts say about what happens when the three control systems (brakes, steering and acceleration) don't have enough friction where the tires meet the road to do what the driver has asked.

In any emergency, don't give up. Keep trying to steer and constantly seek an escape route or area of less danger.

Skidding

In a skid, a driver can lose control of the vehicle. Defensive drivers avoid most skids by taking reasonable care suited to existing conditions, and by not "overdriving" those conditions. But skids are always possible.

The three types of skids correspond to your Cadillac's three control systems. In the braking skid your wheels aren't rolling. In the steering or cornering skid, too much speed or steering in a curve causes tires to slip and lose cornering force. And in the acceleration skid too much throttle causes the driving wheels to spin.

A cornering skid is best handled by easing your foot off the accelerator pedal.

Remember: Any traction control system helps avoid only the acceleration skid.

If your traction control system is off, then an acceleration skid is also best handled by easing your foot off the accelerator pedal.

If your vehicle starts to slide, ease your foot off the accelerator pedal and quickly steer the way you want the vehicle to go. If you start steering quickly enough, your vehicle may straighten out. Always be ready for a second skid if it occurs.

Of course, traction is reduced when water, snow, ice, gravel, or other material is on the road. For safety, you'll want to slow down and adjust your driving to these conditions. It is important to slow down on slippery surfaces because stopping distance will be longer and vehicle control more limited.

While driving on a surface with reduced traction, try your best to avoid sudden steering, acceleration, or braking (including engine braking by shifting to a lower gear). Any sudden changes could cause the tires to slide. You may not realize the surface is slippery until your vehicle is skidding. Learn to recognize warning clues -- such as enough water, ice or packed snow on the road to make a "mirrored surface" -- and slow down when you have any doubt.

Remember: Any anti-lock brake system (ABS) helps avoid only the braking skid.

DRIVING AT NIGHT

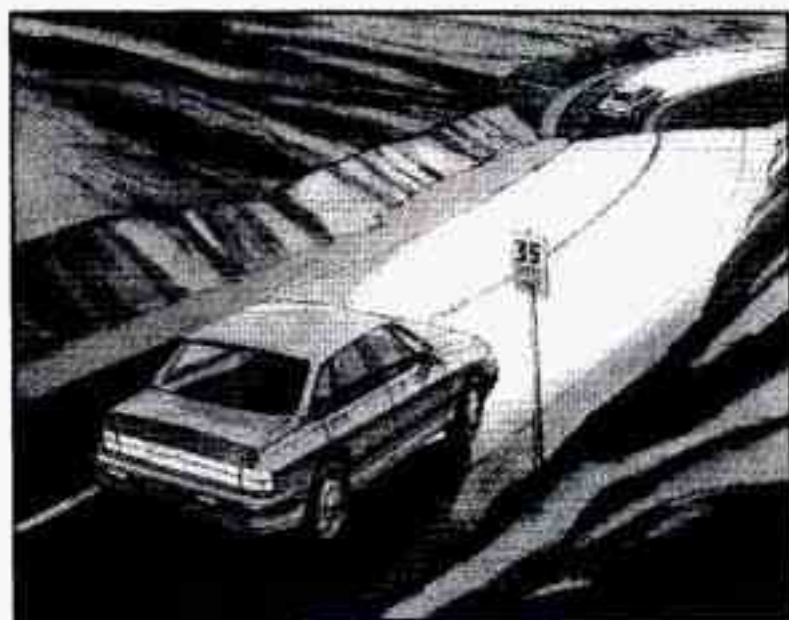

Night driving is more dangerous than day driving. One reason is that some drivers are likely to be impaired -- by alcohol or drugs, with night vision problems, or by fatigue.

Here are some tips on night driving.

- Drive defensively.
- Don't drink and drive.

- Adjust your inside rearview mirror to reduce the glare from headlamps behind you.
- Since you can't see as well, you may need to slow down and keep more space between you and other vehicles.
- Slow down, especially on higher speed roads. Your headlamps can light up only so much road ahead.
- In remote areas, watch for animals.
- If you're tired, pull off the road in a safe place and rest.

Night Vision

No one can see as well at night as in the daytime. But as we get older these differences increase. A 50-year-old driver may require at least twice as much light to see the same thing at night as a 20-year-old.

What you do in the daytime can also affect your night vision. For example, if you spend the day in bright sunshine you are wise to wear sunglasses. Your eyes will have less trouble adjusting to night. But if you're driving, don't wear sunglasses at night. They may cut down on glare from headlamps, but they also make a lot of things invisible.

You can be temporarily blinded by approaching lights. It can take a second or two, or even several seconds, for your eyes to readjust to the dark. When you are faced with severe glare (as from a driver who doesn't lower the high beams, or a vehicle with misaimed headlamps), slow down a little. Avoid staring directly into the approaching lights.

Keep your windshield and all the glass on your vehicle clean -- inside and out. Glare at night is made much worse by dirt on the glass. Even the inside of the glass can build up a film caused by dust. Dirty glass makes lights dazzle and flash more than clean glass would, making the pupils of your eyes contract repeatedly.

Remember that your headlamps light up far less of a roadway when you are in a turn or curve. Keep your eyes moving; that way, it's easier to pick out dimly lighted objects. Just as your headlamps should be checked regularly for proper aim, so should your eyes be examined regularly. Some drivers suffer from night blindness -- the inability to see in dim light -- and aren't even aware of it.

DRIVING IN THE RAIN



Rain and wet roads can mean driving trouble. On a wet road you can't stop, accelerate or turn as well because your tire-to-road traction isn't as good as on dry roads. And, if your tires don't have much tread left, you'll get even less traction. It's always wise to go slower and be cautious if rain starts to fall while you are driving. The surface may get wet suddenly when your reflexes are tuned for driving on dry pavement.

The heavier the rain, the harder it is to see. Even if your windshield wiper blades are in good shape, a heavy rain can make it harder to see road signs and traffic signals, pavement markings, the edge of the road, and even people walking.

It's wise to keep your wiping equipment in good shape and keep your windshield washer tank filled. Replace your windshield wiper inserts when they show signs of streaking or missing areas on the windshield, or when strips of rubber start to separate from the inserts.



Driving too fast through large water puddles or even going through some car washes can cause problems, too. The water may affect your brakes. Try to avoid puddles. But if you can't, try to slow down before you hit them.

 **CAUTION:**

Wet brakes can cause accidents. They won't work well in a quick stop and may cause pulling to one side. You could lose control of the vehicle.

After driving through a large puddle of water or a car wash, apply your brake pedal lightly until your brakes work normally.

Hydroplaning

Hydroplaning is dangerous. So much water can build up under your tires that they can actually ride on the water. This can happen if the road is wet enough and you're going fast enough. When your vehicle is hydroplaning, it has little or no contact with the road.

Hydroplaning doesn't happen often. But it can if your tires haven't much tread or if the pressure in one or more is low. It can happen if a lot of water is standing on the road. If you can see reflections from trees, telephone poles, or other vehicles, and raindrops "dimple" the water's surface, there could be hydroplaning.

Hydroplaning usually happens at higher speeds. There just isn't a hard and fast rule about hydroplaning. The best advice is to slow down when it is raining.

Some Other Rainy Weather Tips

- Turn on your low beam headlamps -- not just your parking lamps -- to help make you more visible to others.
- Besides slowing down, allow some extra following distance. And be especially careful when you pass another vehicle. Allow yourself more clear room ahead, and be prepared to have your view restricted by road spray.
- Have good tires with proper tread depth. (See "Tires" in the Index.)

CITY DRIVING



One of the biggest problems with city streets is the amount of traffic on them. You'll want to watch out for what the other drivers are doing and pay attention to traffic signals.

Here are ways to increase your safety in city driving:

- Know the best way to get to where you are going. Get a city map and plan your trip into an unknown part of the city just as you would for a cross-country trip.
- Try to use the freeways that rim and crisscross most large cities. You'll save time and energy. (See the next part, "Freeway Driving.")
- Treat a green light as a warning signal. A traffic light is there because the corner is busy enough to need it. When a light turns green, and just before you start to move, check both ways for vehicles that have not cleared the intersection or may be running the red light.

FREEWAY DRIVING

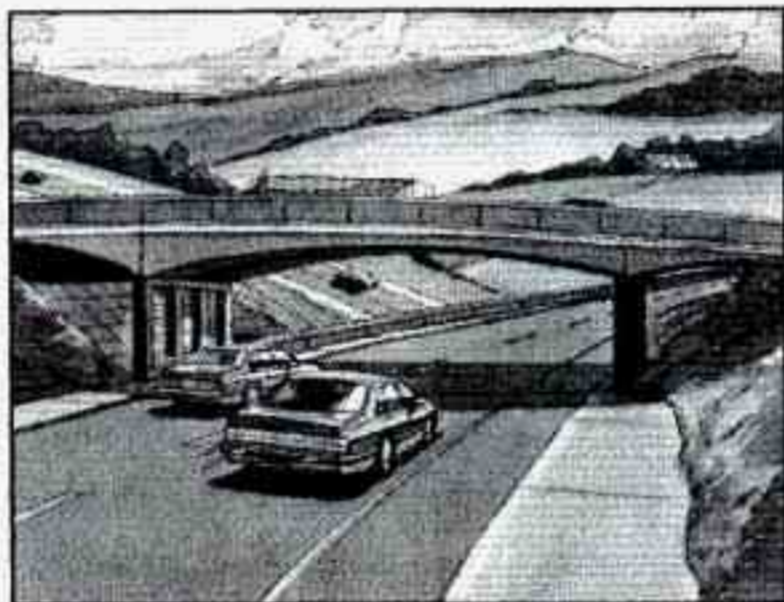

Mile for mile, freeways (also called thruways, parkways, expressways, turnpikes, or superhighways) are the safest of all roads. But they have their own special rules.

The most important advice on freeway driving is: Keep up with traffic and keep to the right. Drive at the same speed most of the other drivers are driving. Too-fast or too-slow driving breaks a smooth traffic flow. Treat the left lane on a freeway as a passing lane.

At the entrance there is usually a ramp that leads to the freeway. If you have a clear view of the freeway as you drive along the entrance ramp, you should begin to check traffic. Try to determine where you expect to blend with the flow. Try to merge into the gap at close to the prevailing speed. Switch on your turn signal, check your mirrors and glance over your shoulder as often as necessary. Try to blend smoothly with the traffic flow.

Once you are on the freeway, adjust your speed to the posted limit or to the prevailing rate if it's slower. Stay in the right lane unless you want to pass.

Before changing lanes, check your mirrors. Then use your turn signal.

Just before you leave the lane, glance quickly over your shoulder to make sure there isn't another vehicle in your "blind" spot.

Once you are moving on the freeway, make certain you allow a reasonable following distance. Expect to move slightly slower at night.

When you want to leave the freeway, move to the proper lane well in advance. If you miss your exit do not, under any circumstances, stop and back up. Drive on to the next exit.

The exit ramp can be curved, sometimes quite sharply.

The exit speed is usually posted.

Reduce your speed according to your speedometer, not to your sense of motion. After driving for any distance at higher speeds, you may tend to think you are going slower than you actually are.

BEFORE LEAVING ON A LONG TRIP

Make sure you're ready. Try to be well rested. If you must start when you're not fresh -- such as after a day's work -- don't plan to make too many miles that first part of the journey. Wear comfortable clothing and shoes you can easily drive in.

Is your vehicle ready for a long trip? If you keep it serviced and maintained, it's ready to go. If it needs service, have it done before starting out. Of course, you'll find experienced and able service experts in Cadillac dealerships all across North America. They'll be ready and willing to help if you need it.

Here are some things you can check before a trip:

- *Windshield Washer Fluid:* Is the reservoir full? Are all windows clean inside and outside?
- *Wiper Blades:* Are they in good shape?
- *Fuel, Engine Oil, Other Fluids:* Have you checked all levels?
- *Lamps:* Are they all working? Are the lenses clean?
- *Tires:* They are vitally important to a safe, trouble-free trip. Is the tread good enough for long-distance driving? Are the tires all inflated to the recommended pressure?
- *Weather Forecasts:* What's the weather outlook along your route? Should you delay your trip a short time to avoid a major storm system?
- *Maps:* Do you have up-to-date maps?

HIGHWAY HYPNOSIS

Is there actually such a condition as “highway hypnosis”? Or is it just plain falling asleep at the wheel? Call it highway hypnosis, lack of awareness, or whatever.

There is something about an easy stretch of road with the same scenery, along with the hum of the tires on the road, the drone of the engine, and the rush of the wind against the vehicle that can make you sleepy. Don't let it happen to you! If it does, your vehicle can leave the road in *less than a second*, and you could crash and be injured.

What can you do about highway hypnosis? First, be aware that it can happen.

Then here are some tips:

- Make sure your vehicle is well ventilated, with a comfortably cool interior.
- Keep your eyes moving. Scan the road ahead and to the sides. Check your rearview mirrors and your instruments frequently.
- If you get sleepy, pull off the road into a rest, service, or parking area and take a nap, get some exercise, or both. For safety, treat drowsiness on the highway as an emergency.

HILL AND MOUNTAIN ROADS



Driving on steep hills or mountains is different from driving in flat or rolling terrain.

If you drive regularly in steep country, or if you're planning to visit there, here are some tips that can make your trips safer and more enjoyable.

- Keep your vehicle in good shape. Check all fluid levels and also the brakes, tires, cooling system and transaxle. These parts can work hard on mountain roads.
- Know how to go down hills. The most important thing to know is this: let your engine do some of the slowing down. Shift to a lower gear when you go down a steep or long hill.

 **CAUTION:**

If you don't shift down, your brakes could get so hot that they wouldn't work well. You would then have poor braking or even none going down a hill. You could crash. Shift down to let your engine assist your brakes on a steep downhill slope.

 **CAUTION:**

Coasting downhill in NEUTRAL (N) or with the ignition off is dangerous. Your brakes will have to do all the work of slowing down. They could get so hot that they wouldn't work well. You could crash. Always have your engine running and your vehicle in gear when you go downhill.

- Know how to go uphill. You may want to shift down to a lower gear. The lower gears help cool your engine and transaxle, and you can climb the hill better.
- Stay in your own lane when driving on two-lane roads in hills or mountains. Don't swing wide or cut across the center of the road. Drive at speeds that let you stay in your own lane.
- As you go over the top of a hill, be alert. There could be something in your lane, like a stalled car or an accident.
- You may see highway signs on mountains that warn of special problems. Examples are long grades, passing or no-passing zones, a falling rocks area, or winding roads. Be alert to these and take appropriate action.

WINTER DRIVING

Here are some tips for winter driving:

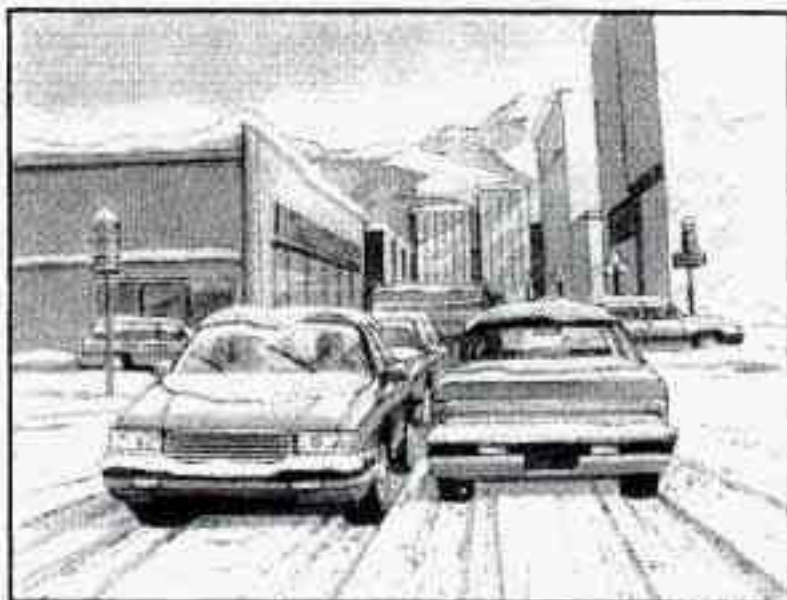

- Have your Cadillac in good shape for winter. Be sure your engine coolant mix is correct.

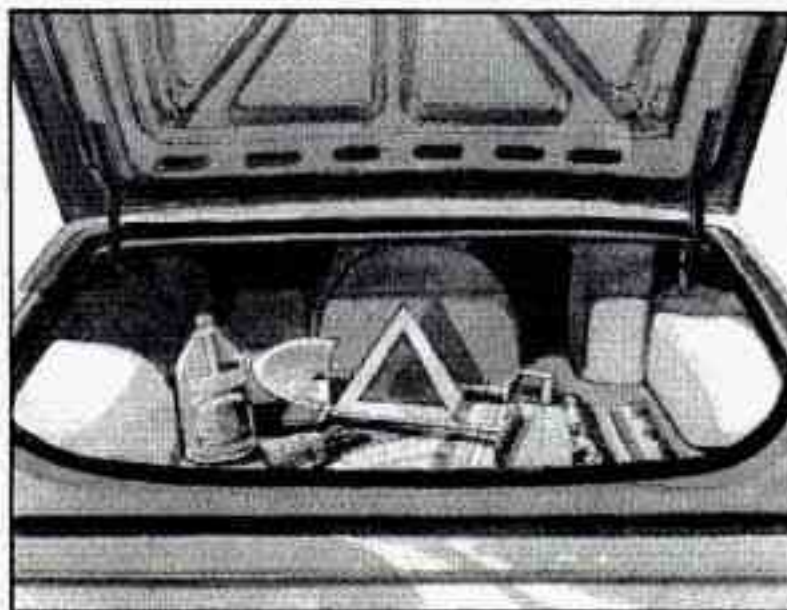

- You may want to put winter emergency supplies in your trunk.

Include an ice scraper, a small brush or broom, a supply of windshield washer fluid, a rag, some winter outer clothing, a small shovel, a flashlight, a red cloth, and a couple of reflective warning triangles. And, if you will be driving under severe conditions, include a small bag of sand, a piece of old carpet or a couple of burlap bags to help provide traction. Be sure you properly secure these items in your vehicle.

Driving on Snow or Ice

Most of the time, those places where your tires meet the road probably have good traction.

However, if there is snow or ice between your tires and the road, you can have a very slippery situation. You'll have a lot less traction or "grip" and will need to be very careful.



What's the worst time for this? "Wet ice." Very cold snow or ice can be slick and hard to drive on. But wet ice can be even more trouble because it may offer the least traction of all. You can get "wet ice" when it's about freezing (32° F; 0° C) and freezing rain begins to fall. Try to avoid driving on wet ice until salt and sand crews can get there.

Whatever the condition -- smooth ice, packed, blowing or loose snow -- drive with caution.

Keep your traction control system on. It improves your ability to accelerate when driving on a slippery road. Even though your vehicle has a traction control system, you'll want to slow down and adjust your driving to the road conditions. See "Traction Control System" in the Index.

Your anti-lock brakes improve your ability to make a hard stop on a slippery road. Even though you have the anti-lock braking system, you'll want to begin stopping sooner than you would on dry pavement. See "Anti-Lock" in the Index.

- Allow greater following distance on any slippery road.
- Watch for slippery spots. The road might be fine until you hit a spot that's covered with ice. On an otherwise clear road, ice patches may appear in shaded areas where the sun can't reach: around clumps of trees, behind buildings, or under bridges. Sometimes the surface of a curve or an overpass may remain icy when the surrounding roads are clear. If you see a patch of ice ahead of you, brake before you are on it. Try not to brake while you're actually on the ice, and avoid sudden steering maneuvers.

If You're Caught in a Blizzard



If you are stopped by heavy snow, you could be in a serious situation. You should probably stay with your vehicle unless you know for sure that you are near help and you can hike through the snow. Here are some things to do to summon help and keep yourself and your passengers safe: Turn on your hazard flashers. Tie a red cloth to your vehicle to alert police that you've been stopped by the snow. Put on extra clothing or wrap a blanket around you. If you have no blankets or extra clothing, make body insulators from newspapers, burlap bags, rags, floor mats -- anything you can wrap around yourself or tuck under your clothing to keep warm.

You can run the engine to keep warm, but be careful.



⚠ CAUTION:

Snow can trap exhaust gases under your vehicle. This can cause deadly CO (carbon monoxide) gas to get inside. CO could overcome you and kill you. You can't see it or smell it, so you might not know it is in your vehicle. Clear away snow from around the base of your vehicle, especially any that is blocking your exhaust pipe. And check around again from time to time to be sure snow doesn't collect there.

Open a window just a little on the side of the vehicle that's away from the wind. This will help keep CO out.

Run your engine only as long as you must. This saves fuel. When you run the engine, make it go a little faster than just idle. That is, push the accelerator slightly. This uses less fuel for the heat that you get and it keeps the battery charged. You will need a well-charged battery to restart the vehicle, and possibly for signaling later on with your headlamps. Let the heater run for awhile.

Then, shut the engine off and close the window almost all the way to preserve the heat. Start the engine again and repeat this only when you feel really uncomfortable from the cold. But do it as little as possible. Preserve the fuel as long as you can. To help keep warm, you can get out of the vehicle and do some fairly vigorous exercises every half hour or so until help comes.

LOADING YOUR VEHICLE



TIRE-LOADING INFORMATION

OCCUPANTS		VEHICLE CAP. WT.			
FRT.	CTR.	RR.	TOTAL	LBS.	KG

MAX. LOADING & GVWR SAME AS VEHICLE			
CAPACITY WEIGHT	XXX	COLD TIRE	
TIRE SIZE	SPEED	PRESSURE	
	RTG	PSI/KPa	

FRT.

RR.

SPA.

IF TIRES ARE HOT, ADD 4PSI/28KPa SEE
OWNER'S MANUAL FOR ADDITIONAL
INFORMATION

GEN GME

Two labels on your vehicle show how much weight it may properly carry. The Tire-Loading Information label found on the driver's door tells you the proper size, speed rating and recommended inflation pressures for the tires on your vehicle. It also gives you important information about the number of people that can be in your vehicle and the total weight that you can carry. This weight is called the Vehicle Capacity Weight and includes the weight of all occupants, cargo and all non-factory installed options.



MFD BY GENERAL MOTORS CORP
DATE GVWR GAWR FRT GAWR RR

THIS VEHICLE CONFORMS TO ALL APPLICABLE U.S. FEDERAL MOTOR VEHICLE SAFETY, BUMPER, AND THEFT PREVENTION STANDARDS IN EFFECT ON THE DATE OF MANUFACTURE SHOWN ABOVE.

GEN GME

The other label is the Certification label, found on the rear edge of the driver's door. It tells you the gross weight capacity of your vehicle, called the GVWR (Gross Vehicle Weight Rating). The GVWR includes the weight of the vehicle, all occupants, fuel and cargo. Never exceed the GVWR for your vehicle or the Gross Axle Weight Rating (GAWR) for either the front or rear axle.

And, if you do have a heavy load, you should spread it out. Don't carry more than 203 pounds (92 kg) in the trunk.



CAUTION:

Do not load your vehicle any heavier than the GVWR, or either the maximum front or rear GAWR. If you do, parts on your vehicle can break, or it can change the way your vehicle handles. These could cause you to lose control. Also, overloading can shorten the life of your vehicle.

If you put things inside your vehicle -- like suitcases, tools, packages or anything else -- they will go as fast as the vehicle goes. If you have to stop or turn quickly, or if there is a crash, they'll keep going.



CAUTION:

Things you put inside your vehicle can strike and injure people in a sudden stop or turn, or in a crash.

- Put things in the trunk of your vehicle. In a trunk, put them as far forward as you can. Try to spread the weight evenly.
- Never stack heavier things, like suitcases, inside the vehicle so that some of them are above the tops of the seats.
- Don't leave an unsecured child restraint in your vehicle.
- When you carry something inside the vehicle, secure it whenever you can.

TOWING A TRAILER



CAUTION:

If you don't use the correct equipment and drive properly, you can lose control when you pull a trailer. For example, if the trailer is too heavy, the brakes may not work well -- or even at all. You and your passengers could be seriously injured. Pull a trailer only if you have followed all the steps in this section. Ask your Cadillac dealer for advice and information about towing a trailer with your vehicle.

NOTICE:

Pulling a trailer improperly can damage your vehicle and result in costly repairs not covered by your warranty. To pull a trailer correctly, follow the advice in this part, and see your Cadillac dealer for important information about towing a trailer with your vehicle.

Your vehicle can tow a trailer if it is equipped with the 4.9L engine and proper trailer towing equipment. To identify what the vehicle trailering capacity is for your vehicle, you should read the information in "Weight of the Trailer" that appears later in this section. But trailering is different than just driving your vehicle by itself. Trailering means changes in handling, durability, and fuel economy. Successful, safe trailering takes correct equipment, and it has to be used properly.

That's the reason for this part. In it are many time-tested, important trailering tips and safety rules. Many of these are important for your safety and that of your passengers. So please read this section carefully before you pull a trailer.

Load-pulling components such as the engine, transaxle, wheel assemblies, and tires are forced to work harder against the drag of the added weight. The engine is required to operate at relatively higher speeds and under greater loads, generating extra heat. What's more, the trailer adds considerably to wind resistance, increasing the pulling requirements.

If You Do Decide To Pull A Trailer

If you do, here are some important points.

- There are many different laws, including speed limit restrictions, having to do with trailering. Make sure your rig will be legal, not only where you live but also where you'll be driving. A good source for this information can be state or provincial police.
- Consider using a sway control.

You can ask a hitch dealer about sway controls.

- Don't tow a trailer at all during the first 1,000 miles (1 600 km) your new vehicle is driven. Your engine, axle or other parts could be damaged.
- Then, during the first 500 miles (800 km) that you tow a trailer, don't drive over 50 mph (80 km/h) and don't make starts at full throttle. This helps your engine and other parts of your vehicle wear in at the heavier loads.
- Obey speed limit restrictions when towing a trailer. Don't drive faster than the maximum posted speed for trailers (or no more than 55 mph (90 km/h)) to save wear on your vehicle's parts.

Three important considerations have to do with weight:

Weight of the Trailer

How heavy can a trailer safely be?

It should never weigh more than 1,000 pounds (450 kg) total, including the load. But even that can be too heavy.

It depends on how you plan to use your rig. For example, speed, altitude, road grades, outside temperature and how much your vehicle is used to pull a trailer are all important. And, it can also depend on any special equipment that you have on your vehicle.

You can ask your dealer for our trailering information or advice, or you can write us at Cadillac Consumer Relations Center, Cadillac Motor Car Division, 30009 Van Dyke, P.O. Box 9025, Warren, MI 48090-9025.

In Canada, write to General Motors of Canada Limited, Customer Assistance Center, 1908 Colonel Sam Drive, Oshawa, Ontario L1H 8P7.

Weight of the Trailer Tongue

The tongue load (A) of any trailer is an important weight to measure because it affects the total capacity weight of your vehicle. The capacity weight includes the curb weight of the vehicle, any cargo you may carry in it, and the people who will be riding in the vehicle. And if you will tow a trailer, you must subtract the tongue load from your vehicle's capacity weight because your vehicle will be carrying that weight, too. See "Loading Your Vehicle" in the Index for more information about your vehicle's maximum load capacity.

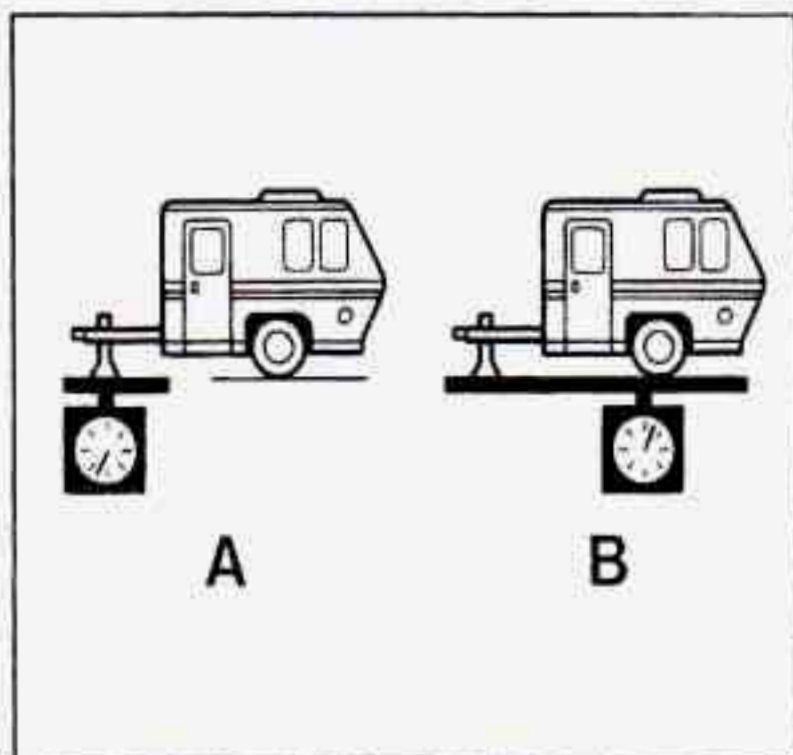

If you're using a "dead-weight" hitch, the trailer tongue (A) should weigh 10% of the total loaded trailer weight (B). If you have a "weight-distributing" hitch, the trailer tongue (A) should weigh 12% of the total loaded trailer weight (B).

After you've loaded your trailer, weigh the trailer and then the tongue, separately, to see if the weights are proper. If they aren't, you may be able to get them right simply by moving some items around in the trailer.

Total Weight on Your Vehicle's Tires

Be sure your vehicle's tires are inflated to the recommended pressure for cold tires. You'll find these numbers on the Certification label at the rear edge of the driver's door or see "Loading Your Vehicle" in the Index. Then be sure you don't go over the GVW limit for your vehicle, including the weight of the trailer tongue.

The gross combined vehicle weight (GCVW) = curb weight + passenger's weight + cargo + trailer weight, should never weigh more than 6,100 pounds (2 772 kg) total loaded vehicle and trailer.

Hitches

It's important to have the correct hitch equipment. Crosswinds, large trucks going by, and rough roads are a few reasons why you'll need the right hitch. Here are some rules to follow:

- Will you have to make any holes in the body of your vehicle when you install a trailer hitch? If you do, then be sure to seal the holes later when you remove the hitch. If you don't seal them, deadly carbon monoxide (CO) from your exhaust can get into your vehicle (see "Carbon Monoxide" in the Index). Dirt and water can, too.
- The bumpers on your vehicle are not intended for hitches. Do not attach rental hitches or other bumper-type hitches to them. Use only a frame-mounted hitch that does not attach to the bumper.

Safety Chains

You should always attach chains between your vehicle and your trailer. Cross the safety chains under the tongue of the trailer so that the tongue will not drop to the road if it becomes separated from the hitch. Instructions about safety chains may be provided by the hitch manufacturer or by the trailer manufacturer. Follow the manufacturer's recommendation for attaching safety chains and do not attach them to the bumper. Always leave just enough slack so you can turn with your rig. And, never allow safety chains to drag on the ground.

Trailer Brakes

Because you have anti-lock brakes, don't try to tap into your vehicle's hydraulic brake system. If you do both brake systems won't work well, or at all.

Be sure to read and follow the instructions for the trailer brakes so you'll be able to maintain them properly.

Driving with a Trailer

Towing a trailer requires a certain amount of experience. Before setting out for the open road, you'll want to get to know your rig. Acquaint yourself with the feel of handling and braking with the added weight of the trailer. And always keep in mind that the vehicle you are driving is now a good deal longer and not nearly as responsive as your vehicle is by itself.

Before you start, check the trailer hitch and platform (and attachments), safety chains, electrical connector, lamps, tires and mirror adjustment. If the trailer has electric brakes, start your vehicle and trailer moving and then apply the trailer brake controller by hand to be sure the brakes are working. This lets you check your electrical connection at the same time.

During your trip, check occasionally to be sure that the load is secure, and that the lights and any trailer brakes are still working.

Following Distance

Stay at least twice as far behind the vehicle ahead as you would when driving your vehicle without a trailer. This can help you avoid situations that require heavy braking and sudden turns.

Passing

You'll need more passing distance up ahead when you're towing a trailer. And, because you're a good deal longer, you'll need to go much farther beyond the passed vehicle before you can return to your lane.

Backing Up

Hold the bottom of the steering wheel with one hand. Then, to move the trailer to the left, just move that hand to the left. To move the trailer to the right, move your hand to the right. Always back up slowly and, if possible, have someone guide you.

Making Turns

NOTICE:

Making very sharp turns while trailering could cause the trailer to come in contact with the vehicle. Your vehicle could be damaged. Avoid making very sharp turns while trailering.

When you're turning with a trailer, make wider turns than normal. Do this so your trailer won't strike soft shoulders, curbs, road signs, trees, or other objects. Avoid jerky or sudden maneuvers. Signal well in advance.

Turn Signals When Towing a Trailer

When you tow a trailer, your vehicle has to have a different turn signal flasher and extra wiring. The green arrows on your instrument panel will flash whenever you signal a turn or lane change. Properly hooked up, the trailer lamps will also flash, telling other drivers you're about to turn, change lanes or stop.

When towing a trailer, the green arrows on your instrument panel will flash for turns even if the bulbs on the trailer are burned out. Thus, you may think drivers behind you are seeing your signal when they are not. It's important to check occasionally to be sure the trailer bulbs are still working.

Driving On Grades

Reduce speed and shift to a lower gear *before* you start down a long or steep downgrade. If you don't shift down, you might have to use your brakes so much that they would get hot and no longer work well.

On a long uphill grade, shift down and reduce your speed to around 45 mph (70 km/h) or less to reduce the possibility of engine and transaxle overheating.

Parking on Hills

You really should not park your vehicle, with a trailer attached, on a hill. If something goes wrong, your rig could start to move. People can be injured, and both your vehicle and the trailer can be damaged.

But if you ever have to park your rig on a hill, here's how to do it:

1. Apply your regular brakes, but do not shift into PARK (P).
2. Have someone place chocks under the trailer wheels.
3. When the wheel chocks are in place, release the regular brakes until the chocks absorb the load.
4. Reapply the regular brakes. Then shift into PARK (P) firmly and apply your parking brakes.
5. Release the regular brakes.

When You Are Ready to Leave After Parking on a Hill

1. Apply your regular brakes and hold the pedal down while you:
 - Start your engine;
 - Shift into a gear; and
 - Be sure the parking brake has released.
2. Let up on the brake pedal.
3. Drive slowly until the trailer is clear of the chocks.
4. Stop and have someone pick up and store the chocks.

Maintenance When Trailer Towing

Your vehicle will need service more often when you're pulling a trailer. See the Maintenance Schedule for more on this. Things that are especially important in trailer operation are automatic transaxle fluid (don't overfill), engine oil, belt, cooling system, and brake adjustment. Each of these is covered in this manual, and the Index will help you find them quickly. If you're trailering, it's a good idea to review these sections before you start your trip.

Check periodically to see that all hitch nuts and bolts are tight.

Engine Cooling When Trailering

Your cooling system may temporarily overheat during severe operating conditions such as:

- Climbing grades steeper than 4% at ambient temperatures above 90° F (32° C) with a loaded vehicle and trailer.
- Stopping after high-speed driving.
- Idling for long periods in stop and go traffic.

If the ENGINE HOT-A/C COMPRESSOR OFF message appears on the Driver Information Center, do not be alarmed. This is a normal function designed to reduce the load on the engine and cooling system. You can continue to drive your vehicle.

If the ENGINE COOLANT HOT-IDLE ENGINE message appears on the Driver Information Center, pull off to the side of the road as soon as it is safe to do so. When the vehicle is at a complete stop, shift the transaxle selector to PARK (P) and allow the engine to idle. Do not turn off the engine or increase engine speed above a normal idle. After several minutes resume driving at a reduced speed. Return to normal driving after 10 minutes if the ENGINE COOLANT HOT-IDLE ENGINE message is not displayed.



SECTION 5

PROBLEMS ON THE ROAD

Here you'll find what to do about some problems that can occur on the road.

HAZARD WARNING FLASHERS

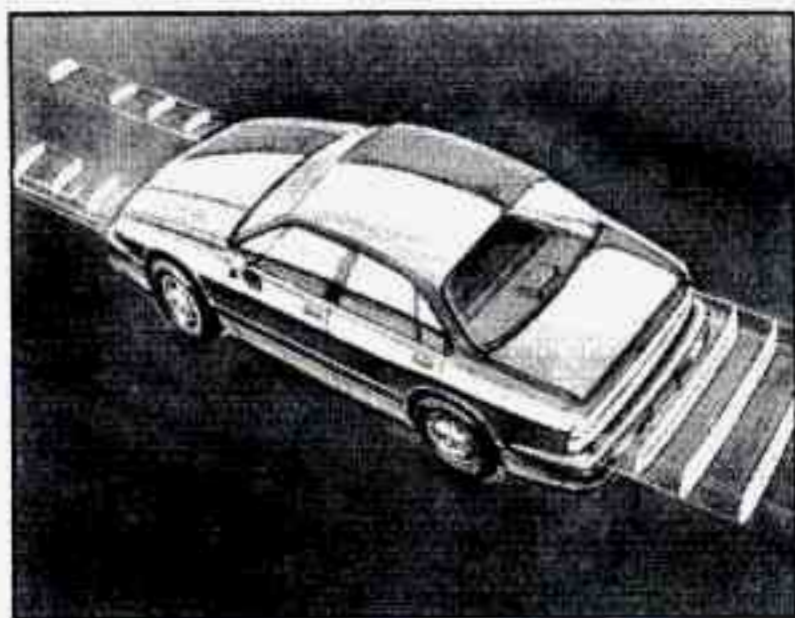

Your hazard warning flashers let you warn others. They also let police know you have a problem. Your front and rear turn signal lamps will flash on and off.



Press the button in to make your front and rear turn signal lamps flash on and off.



The light on your instrument panel will flash indicating that the hazard warning flashers are on.

Your hazard warning flashers will work once the button is pressed in regardless of the key position.



To turn off the flashers, pull out on the collar. When the hazard warning flashers are on, your turn signals won't work since they are already flashing.

OTHER WARNING DEVICES

If you carry reflective triangles, you can set one up at the side of the road about 300 feet (100 m) behind your vehicle.

JUMP STARTING

If your battery has run down, you may want to use another vehicle and some jumper cables to start your Cadillac. Please follow the steps below to do it safely.

CAUTION:

Batteries can hurt you. They can be dangerous because:

- They contain acid that can burn you.
- They contain gas that can explode or ignite.
- They contain enough electricity to burn you.

If you don't follow these steps exactly, some or all of these things can hurt you.

NOTICE:

Ignoring these steps could result in costly damage to your vehicle that wouldn't be covered by your warranty.

Trying to start your Cadillac by pushing or pulling it won't work and it could damage your vehicle.

TO JUMP START YOUR CADILLAC:

1. Check the other vehicle. It must have a 12-volt battery with a negative ground system.

NOTICE:

If the other system isn't a 12-volt system with a negative ground, both vehicles can be damaged.

2. Get the vehicles close enough so the jumper cables can reach, but be sure the vehicles aren't touching each other. If they are, it could cause a ground connection you don't want. You wouldn't be able to start your Cadillac and the bad grounding could damage the electrical systems.
3. Turn off the ignition on both vehicles. Turn off all lamps, radio or any accessories that are in use on both vehicles. This will avoid sparks and help save both batteries as well as avoid damage to any of the accessories.
4. Open the hoods and locate the batteries.



CAUTION:

An electric fan can start up even when the engine is not running and can injure you. Keep hands, clothing and tools away from any underhood electric fan.

Find the positive (+) and negative (-) terminals on each battery.

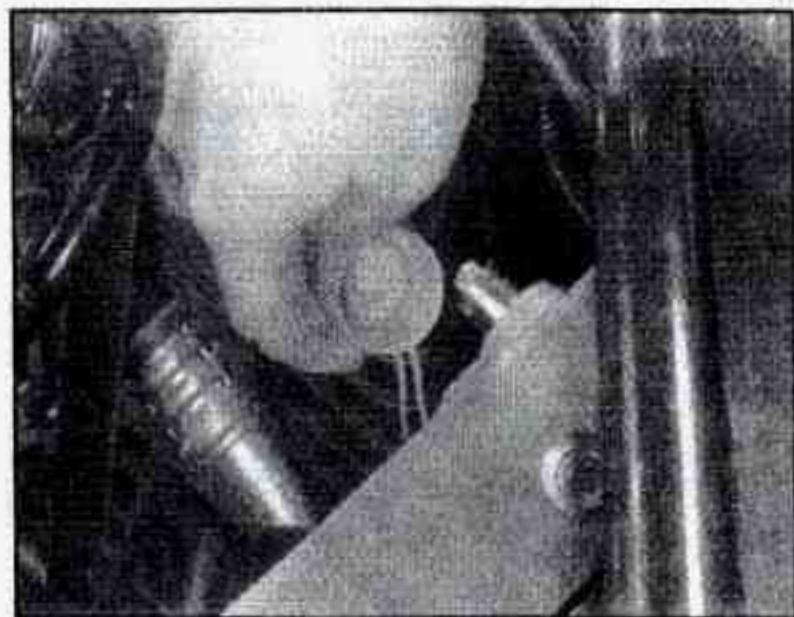

5. Start by removing the red positive (+) terminal cover.

⚠ CAUTION:

Using a match near a battery can cause battery gas to explode. People have been hurt doing this, and some have been blinded. Use a flashlight if you need more light.

Be sure the battery has enough water. You don't need to add water to the Delco Freedom[®] battery installed in every new GM vehicle. But if a battery has filler caps, be sure the right amount of fluid is there. If it is low, add water to take care of that first. If you don't, explosive gas could be present.

Battery fluid contains acid that can burn you. Don't get it on you. If you accidentally get it in your eyes or on your skin, flush the place with water and get medical help immediately.

6. Check that the jumper cables don't have loose or missing insulation. If they do, you could get a shock. The vehicles could be damaged too.

Before you connect the cables, here are some things you should know. Positive (+) will go to positive (+) and negative (-) will go to negative (-) or a metal engine part. Don't connect positive (+) to negative (-) or you'll get a short that could damage the battery and maybe other parts too.

 **CAUTION:**

Fans or other moving engine parts can injure you badly. Keep your hands away from moving parts once the engines are running.



7. Connect the red positive (+) cable to the positive (+) terminal of the vehicle with the dead battery.
8. Don't let the other end of the positive cable touch metal. Connect it to the positive (+) terminal of the good battery.

9. Now connect the black negative (-) cable to the good battery's negative (-) terminal.
10. Don't let the other end of the negative cable touch anything until the next step. The other end of the negative cable *doesn't* go to the dead battery. It goes to a heavy unpainted metal part on the engine of the vehicle with the dead battery.

Attach the cable at least 18 inches (45 cm) away from the dead battery, but not near engine parts that move. The electrical connection is just as good there, but the chance of sparks getting back to the battery is much less.



11. Now start the vehicle with the good battery and run the engine for awhile.
12. Try to start the vehicle with the dead battery.
If it won't start after a few tries, it probably needs service.

13. Remove the cables in reverse order to prevent electrical shorting. Take care that they don't touch each other or any other metal.

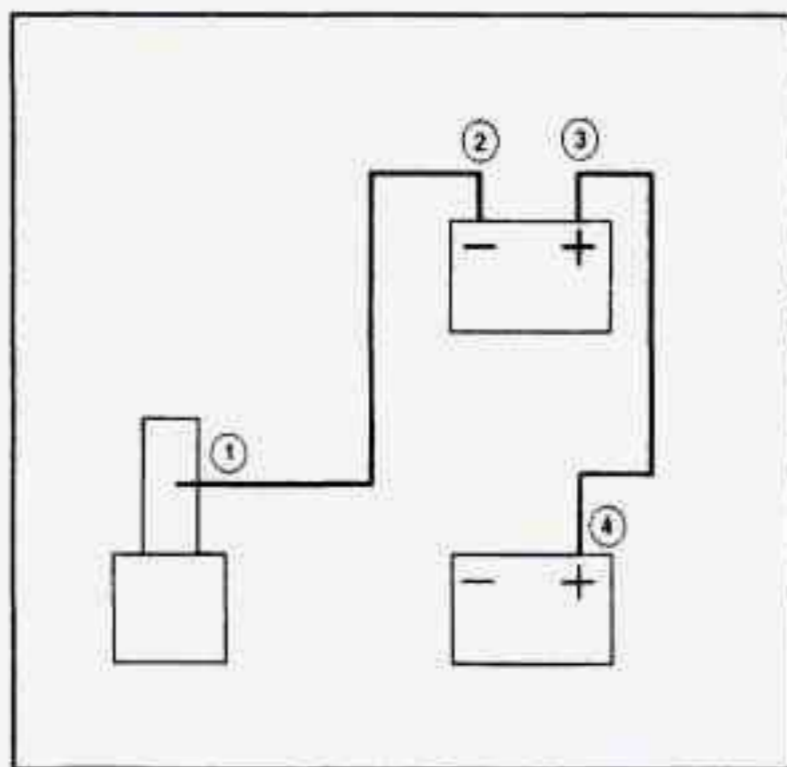

TOWING YOUR VEHICLE

Try to have a GM dealer or a professional towing service tow your Cadillac. The usual towing equipment is :

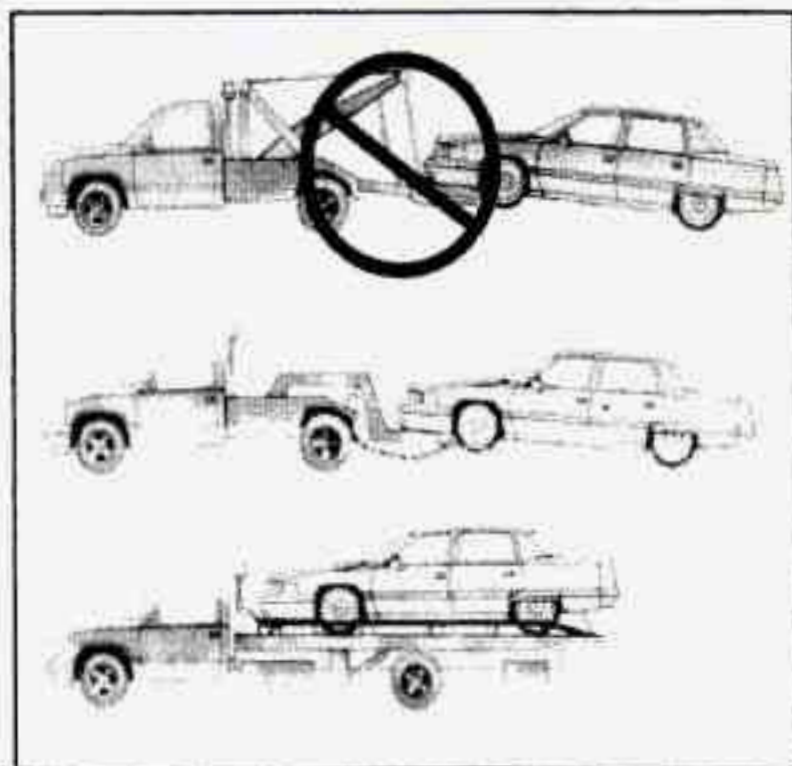

- Sling Type
- Wheel Lift
- Car Carrier

If your vehicle has been changed or modified since it was factory-new by adding aftermarket items like fog lamps, aero skirting or special tires and wheels, these instructions and illustrations may not be correct.

Before you do anything, turn on the hazard warning flashers.

When you call, tell the towing service:

- That your vehicle cannot be towed from the front or rear with sling-type equipment.
- That your vehicle has front-wheel drive.
- The make, model and year of your vehicle.
- Whether you can still move the shift lever.
- If there was an accident, what was damaged.

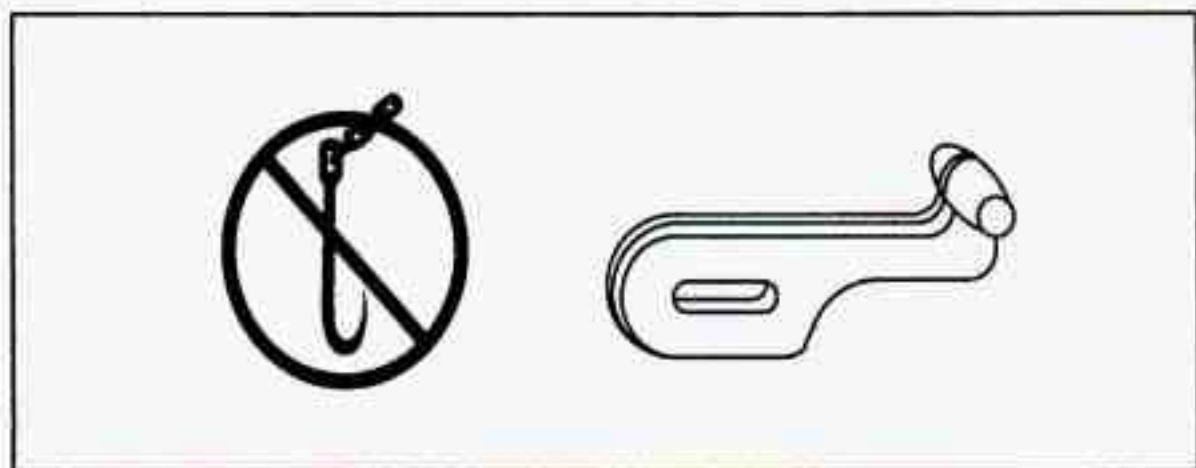

When the towing service arrives, let the tow operator know that this manual contains detailed towing instructions and illustrations. The operator may want to see them.

 **CAUTION:**

To help avoid injury to you or others:

- Never let passengers ride in a vehicle that is being towed.
- Never tow faster than safe or posted speeds.
- Never tow with damaged parts not fully secured.
- Never get under your vehicle after it has been lifted by the tow truck.
- Always secure the vehicle on each side with separate safety chains when towing it.
- Never use J-hooks. Use T-hooks instead.

When your vehicle is being towed, have the ignition key off. The steering wheel should be clamped in a straight-ahead position with a clamping device designed for towing service. Do not use the vehicle's steering column lock for this. The transaxle should be in NEUTRAL (N) and the parking brake released.

Don't have your vehicle towed on the front wheels, unless you must. If the vehicle must be towed on the front wheels, don't go more than 35 mph (56 km/h) or farther than 25 miles (40 km) or your transaxle will be damaged. If these limits must be exceeded, then the front wheels have to be supported on a dolly.

 **CAUTION:**

A vehicle can fall from a car carrier if it isn't adequately secured. This can cause a collision, serious personal injury and vehicle damage. The vehicle should be tightly secured with chains or steel cables before it is transported.

Don't use substitutes (ropes, leather straps, canvas webbing, etc.) that can be cut by sharp edges underneath the towed vehicle. Always use T-hooks inserted in the T-hook slots. Never use J-hooks. They will damage drivetrain and suspension components.

ENGINE OVERHEATING

The Driver Information Center will display either ENGINE COOLANT HOT-IDLE ENGINE or STOP ENGINE ENGINE OVERHEATING. In addition you will find the warning light about a hot engine on your instrument panel on Canadian vehicles.

If Steam Is Coming From Your Engine



⚠ CAUTION:

Steam from an overheated engine can burn you badly, even if you just open the hood. Stay away from the engine if you see or hear steam coming from it. Just turn it off and get everyone away from the vehicle until it cools down. Wait until there is no sign of steam or coolant before opening the hood.

If you keep driving when your engine is overheated, the liquids in it can catch fire. You or others could be badly burned. Stop your engine if it overheats, and get out of the vehicle until the engine is cool.

NOTICE:

If your engine catches fire because you keep driving with no coolant, your vehicle can be badly damaged. The costly repairs would not be covered by your warranty.

If No Steam Is Coming From Your Engine

If you get the overheat warning but see or hear no steam, the problem may not be too serious. Sometimes the engine can get a little too hot when you:

- Climb a long hill on a hot day.
- Stop after high speed driving.
- Idle for long periods in traffic.
- Tow a trailer.

If you get the overheat warning with no sign of steam, try this for a minute or so:

1. Turn off your air conditioner.
2. Dial temperature control to the highest heat setting and open the window, as necessary.
3. If you're in a traffic jam, shift to NEUTRAL (N); otherwise, shift to the highest gear while driving -- AUTOMATIC OVERDRIVE (Ⓢ) or THIRD (3).

If you no longer have the overheat warning, you can drive. Just to be safe, drive slower for about 10 minutes. If the warning doesn't come back on, you can drive normally.

If the warning continues, pull over, stop, and park your vehicle right away.

If there's still no sign of steam, you can idle the engine for two or three minutes while you're parked, to see if the warning stops. But then, if you still have the warning, *turn off the engine and get everyone out of the vehicle until it cools down.*

You may decide not to lift the hood but to get service help right away.

COOLING SYSTEM

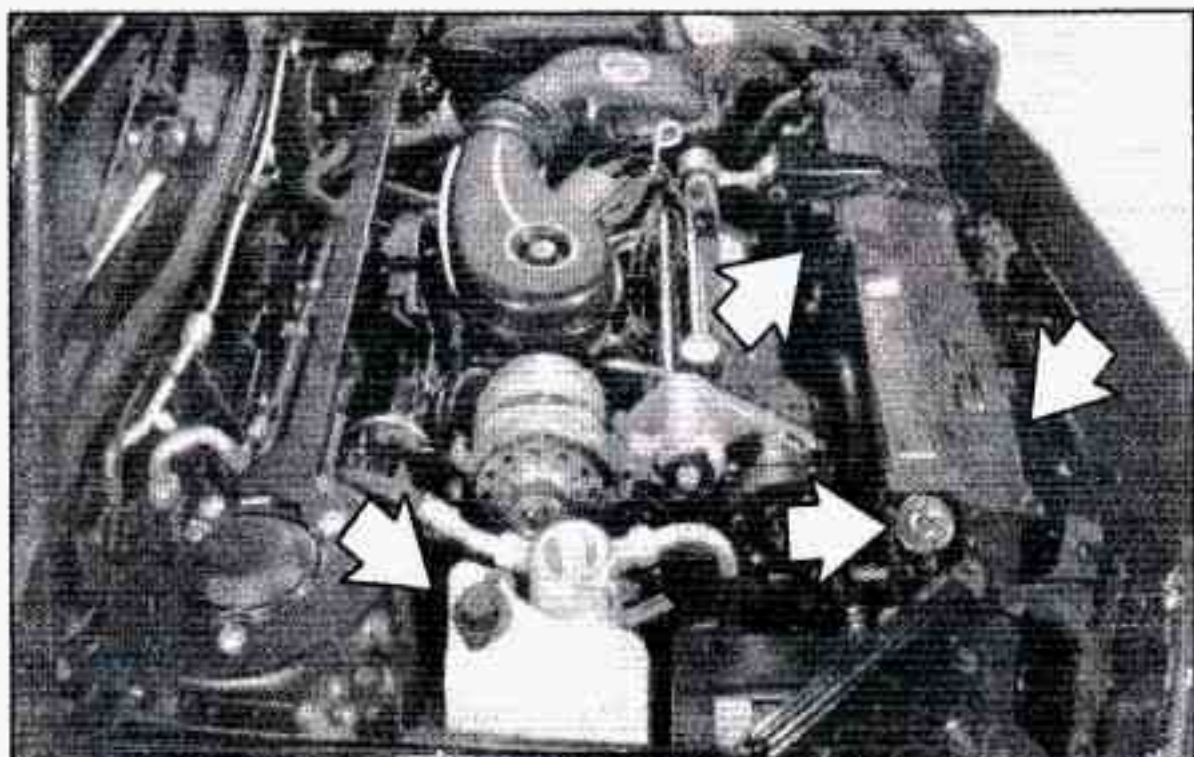

When you decide it's safe to lift the hood, here's what you will see.

- Coolant recovery tank.
- Radiator pressure cap.
- Electric engine fans.



CAUTION:

An electric fan under the hood can start up even when the engine is not running and can injure you. Keep hands, clothing and tools away from any underhood electric fan.

If the coolant inside the coolant recovery tank is boiling, don't do anything else until it cools down.

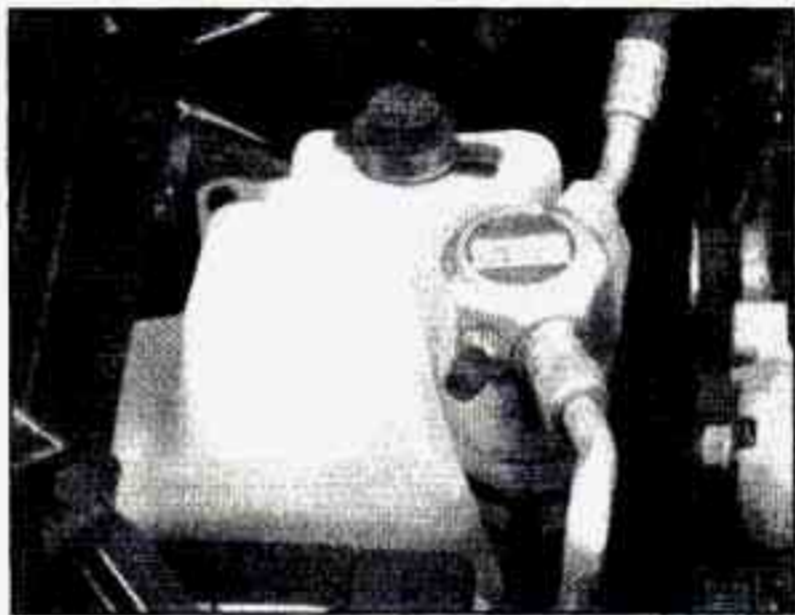

The coolant level should be at or above the **FULL COLD** marking on the coolant recovery tank. If it isn't, you may have a leak in the radiator hoses, heater hoses, radiator, water pump or somewhere else in the cooling system.

⚠ CAUTION:

Heater and radiator hoses, and other engine parts, can be very hot. Don't touch them. If you do, you can be burned.

Don't run the engine if there is a leak. If you run the engine, it could lose all coolant. That could cause an engine fire, and you could be burned. Get any leak fixed before you drive the vehicle.

NOTICE:

Engine damage from running your engine without coolant isn't covered by your warranty.

If there seems to be no leak, with the engine on check to see if the electric engine fans are running. If the engine is overheating, both fans should be running. If they aren't, your vehicle needs service.

How to Add Coolant to the Coolant Recovery Tank

If you haven't found a problem yet, but the coolant level isn't at or near the FULL COLD mark on the coolant recovery tank, add a 50/50 mixture of *clean water* (preferably distilled) and a proper antifreeze at the coolant recovery tank. (See "Engine Coolant" in the Index for more information about the proper coolant mix.)



CAUTION:

Adding only plain water to your cooling system can be dangerous. Plain water, or some other liquid like alcohol, can boil before the proper coolant mix will. Your vehicle's coolant warning system is set for the proper coolant mix. With plain water or the wrong mix, your engine could get too hot but you wouldn't get the overheat warning. Your engine could catch fire and you or others could be burned. Use a 50/50 mix of clean water and a proper antifreeze.

NOTICE:

In cold weather, water can freeze and crack the engine, radiator, heater core and other parts. Use the recommended coolant.

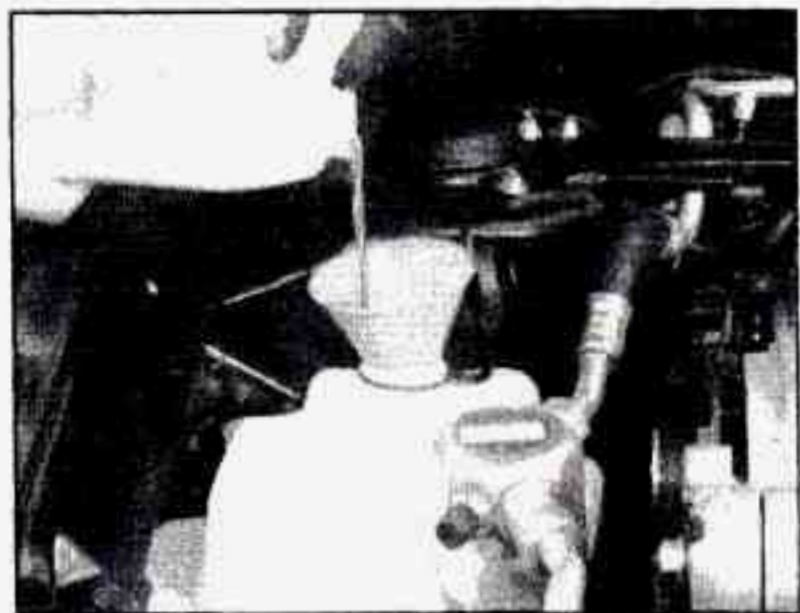

⚠ CAUTION:

You can be burned if you spill coolant on hot engine parts. Coolant contains ethylene glycol and it will burn if the engine parts are hot enough. Don't spill coolant on a hot engine.

When the coolant in the coolant recovery tank is at the FULL COLD mark, start your engine.

If the overheat warning continues, there's one more thing you can try. You can add the proper coolant mix directly to the coolant recovery tank, but be sure the cooling system is cool before you do it.

 **CAUTION:**

Steam and scalding liquids from a hot cooling system can blow out and burn you badly. They are under pressure, and if you turn the radiator pressure cap -- even a little -- they can come out at high speed. Never turn the cap when the cooling system, including the radiator pressure cap, is hot. Wait for the cooling system and radiator pressure cap to cool if you ever have to turn the pressure cap.



How to Add Coolant to the Radiator



1. You can remove the radiator pressure cap when the cooling system, including the coolant recovery tank pressure cap and upper radiator hose, is no longer hot. Turn the pressure cap slowly to the left until it first stops.

(Don't press down while turning the pressure cap.)

If you hear a hiss, wait for that to stop. A hiss means there is still some pressure left.



2. Then keep turning the pressure cap, but now push down as you turn it. Remove the pressure cap.

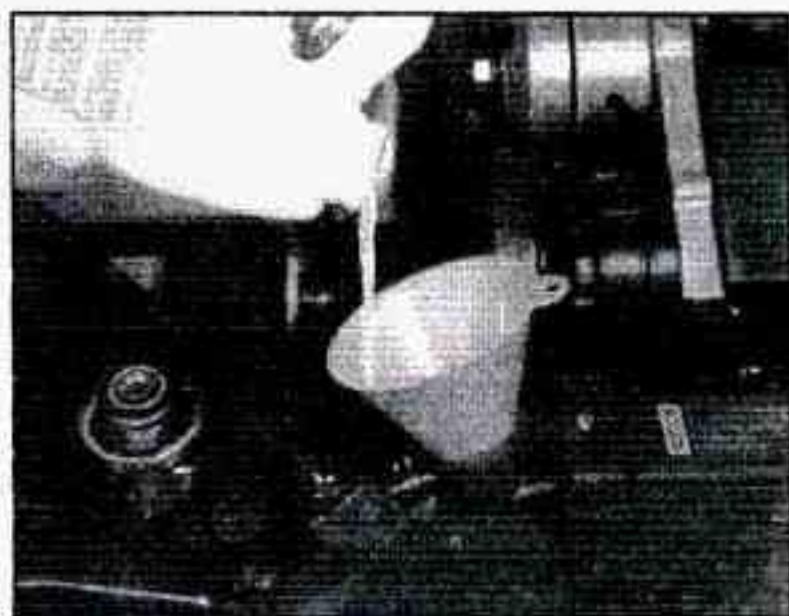

3. Fill the radiator with the proper mix, up to the base of the filler neck.



4. Then fill the coolant recovery tank to the FULL COLD mark.



5. Put the cap back on the coolant recovery tank, but leave the radiator pressure cap off.



6. Start the engine and let it run until you can feel the upper radiator hose getting hot. Watch out for the engine fans.

7. By this time the coolant level inside the radiator filler neck may be lower. If the level is lower, add more of the proper mix through the filler neck until the level reaches the base of the filler neck.



8. Then replace the pressure cap. At any time during this procedure if coolant begins to flow out of the filler neck, reinstall the pressure cap. Be sure the arrows on the pressure cap line up like this

IF A TIRE GOES FLAT

It's unusual for a tire to "blow out" while you're driving, especially if you maintain your tires properly. If air goes out of a tire, it's much more likely to leak out slowly. But if you should ever have a "blowout," here are a few tips about what to expect and what to do:

If a front tire fails, the flat tire will create a drag that pulls the vehicle toward that side. Take your foot off the accelerator pedal and grip the steering wheel firmly. Steer to maintain lane position, then gently brake to a stop well out of the traffic lane.

A rear blowout, particularly on a curve, acts much like a skid and may require the same correction you'd use in a skid. In any rear blowout, remove your foot from the accelerator pedal. Get the vehicle under control by steering the way you want the vehicle to go. It may be very bumpy and noisy, but you can still steer. Gently brake to a stop well off the road if possible.

If a tire goes flat, the next part shows how to use your jacking equipment to change a flat tire safely.

CHANGING A FLAT TIRE

If a tire goes flat, avoid further tire and wheel damage by driving slowly to a level place. Turn on your hazard warning flashers.

⚠ CAUTION:

Changing a tire can cause an injury. The vehicle can slip off the jack and roll over you or other people. You and they could be badly injured. Find a level place to change your tire. To help prevent the vehicle from moving:

1. Put the shift lever in **PARK (P)**.
2. Set the parking brake firmly.
3. Turn off the engine.

To be even more certain the vehicle won't move, you can put blocks at the front and rear of the tire farthest away from the one being changed. That would be the tire on the other side of the vehicle, at the opposite end.



The following steps will tell you how to use the jack and change a tire.

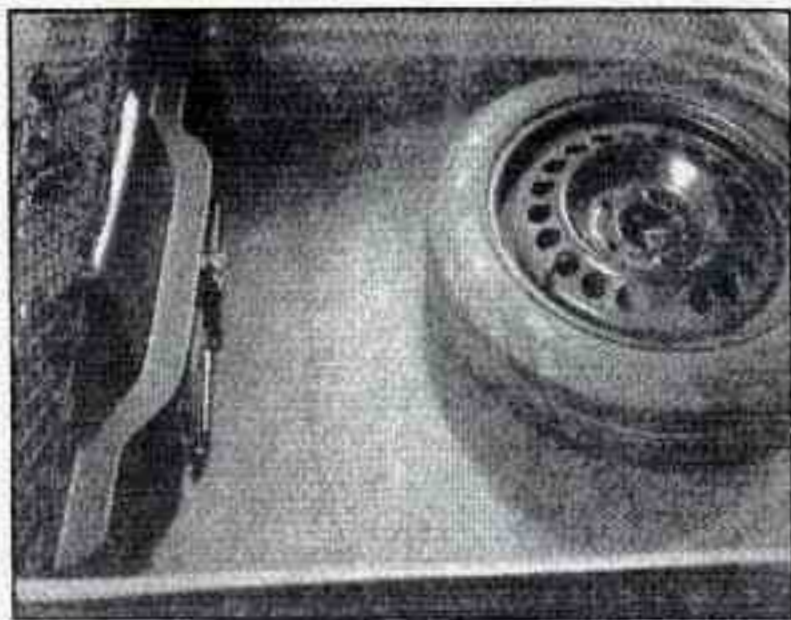

1. The equipment you'll need is in the trunk under the spare tire cover.

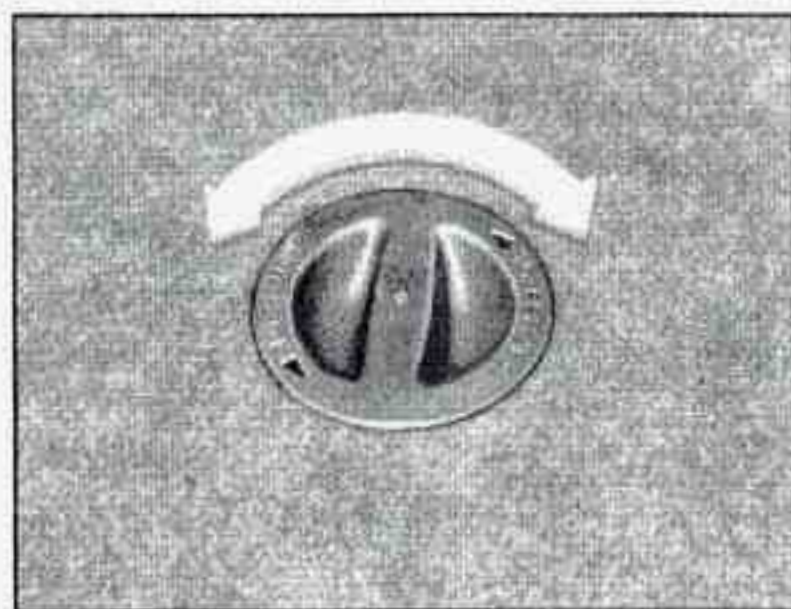

2. Rotate the plastic wing nut and remove the cover.

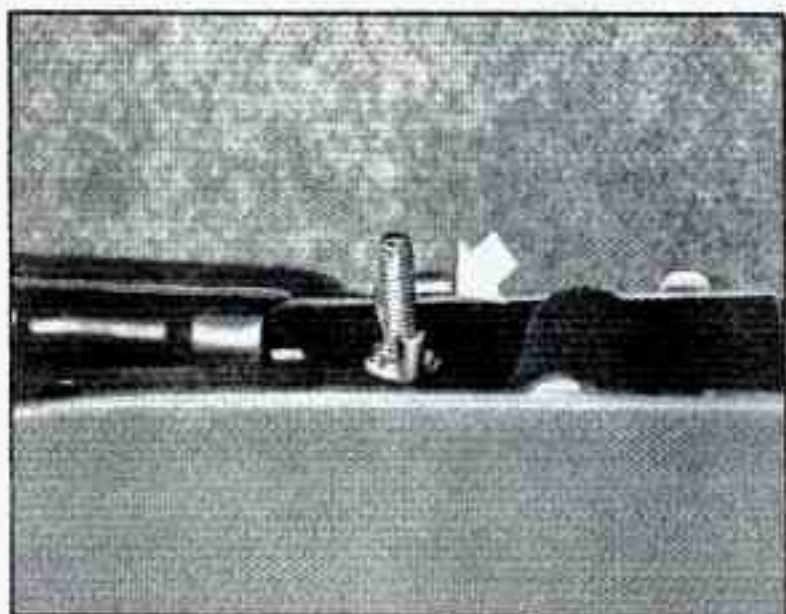

3. Then remove the wing nut that secures the jack and wheel wrench and remove them from the trunk.

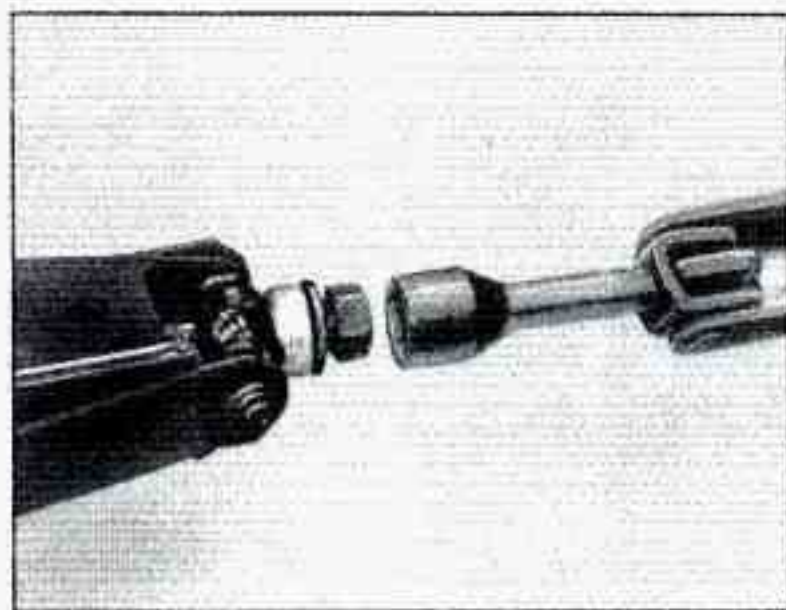

4. Attach the wheel wrench to the jack bolt and rotate it clockwise. That will raise the lift head a little.

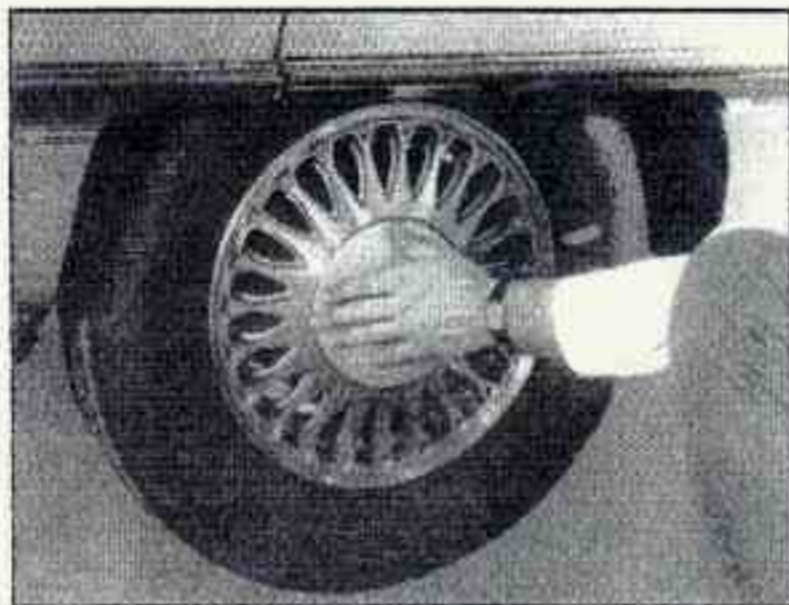

5. Use the flat end of the wheel wrench, gently prying along the edge of the cover until it comes off.

NOTICE:

Be careful not to scratch the aluminum wheel edge. Don't try to remove it with your hands.



6. Using the wheel wrench, loosen all the wheel nuts. Do not remove them yet.

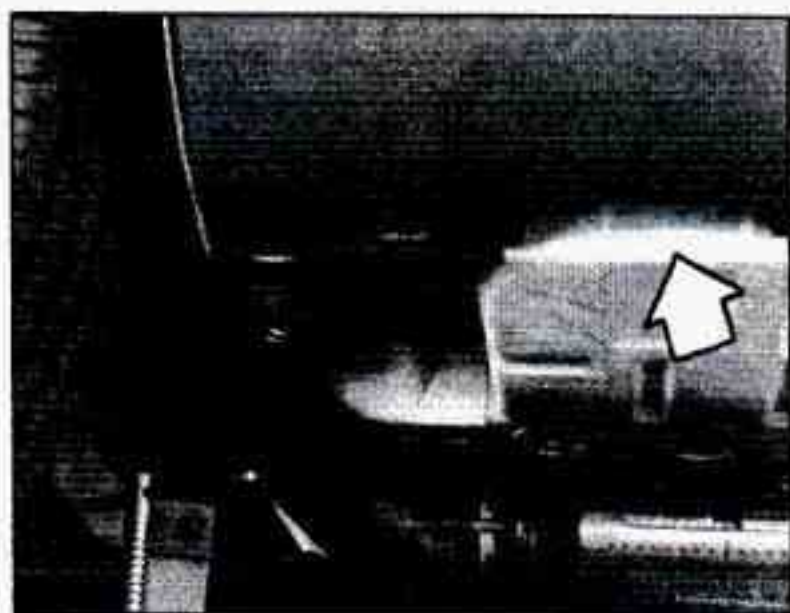

Front

7. Position the jack under the vehicle. Your vehicle has a notch on the frame near each of the wheels. Fit the lift head into the notch nearest the wheel with the flat tire.

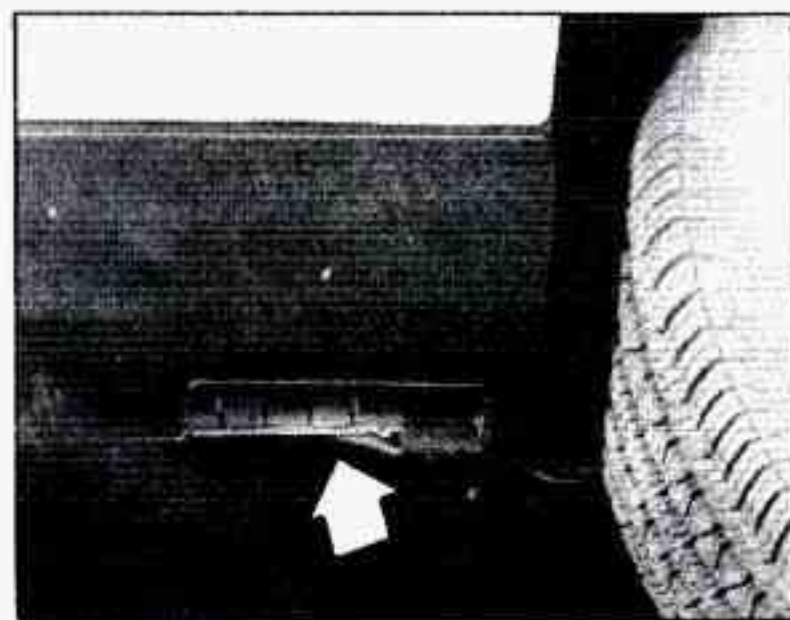

Rear

 **CAUTION:**

Getting under a vehicle when it is jacked up is dangerous. If the vehicle slips off the jack, you could be badly injured or killed. Never get under a vehicle when it is supported only by a jack.

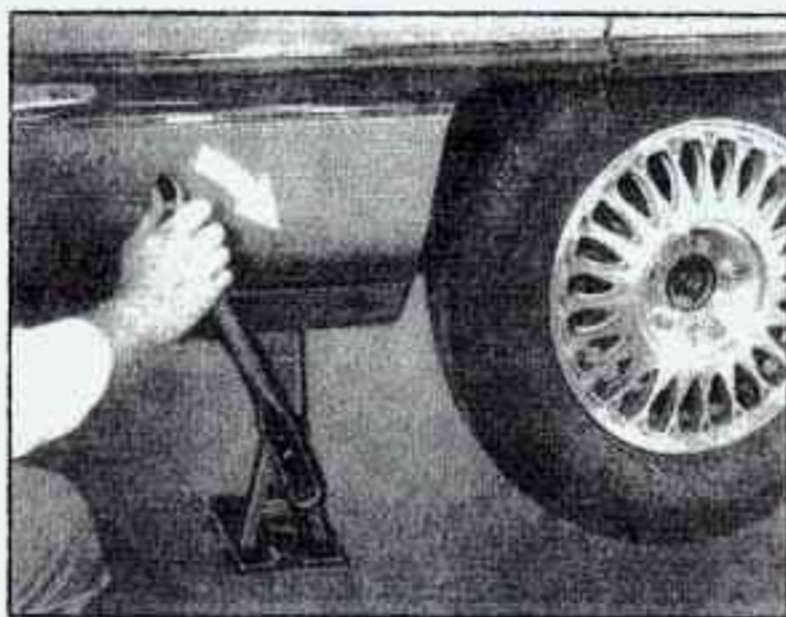

8. Raise the vehicle by rotating the wheel wrench clockwise. Raise the vehicle high enough off the ground so the tire can be removed.

9. Remove all of the wheel nuts and take off the flat tire.



10. Remove any rust or dirt from the wheel bolts, mounting surfaces and spare wheel. Place the spare on the wheel mounting surface.

⚠ CAUTION:

Rust or dirt on the wheel, or on the parts to which it is fastened, can make the wheel nuts become loose after a time. The wheel could come off and cause an accident. When you change a wheel, remove any rust or dirt from the places where the wheel attaches to the vehicle. In an emergency, you can use a cloth or a paper towel to do this; but be sure to use a scraper or wire brush later, if you need to, to get all the rust or dirt off.

⚠ CAUTION:

Never use oil or grease on studs or nuts. If you do, the nuts might come loose. Your wheel could fall off, causing a serious accident.



11. Replace the wheel nuts with the rounded end of the nuts toward the wheel. Tighten each nut by hand until the wheel is held against the hub.

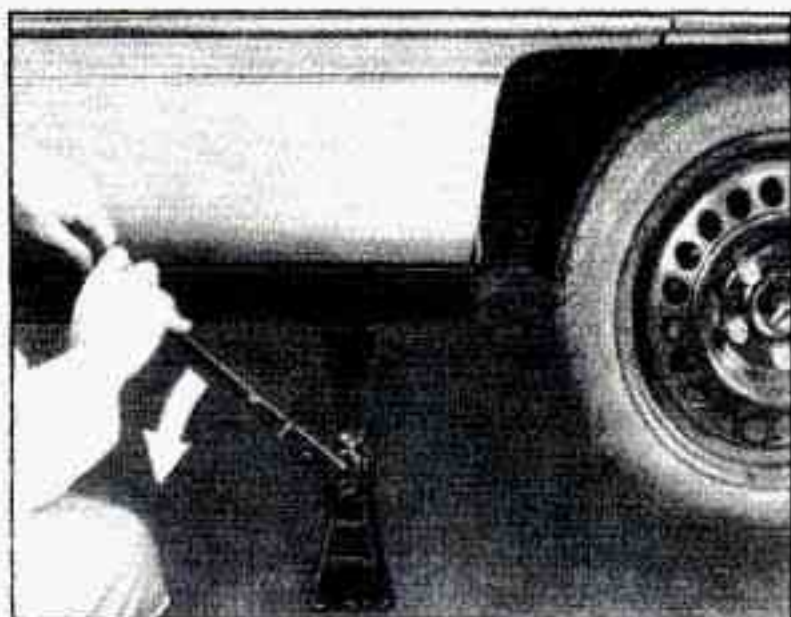

12. Lower the vehicle by rotating the wheel wrench counterclockwise. Lower the jack completely.

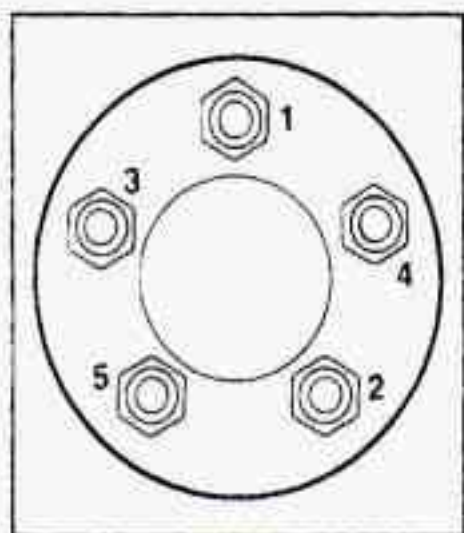

13. Tighten the wheel nuts firmly in a criss-cross sequence as shown.

 **CAUTION:**

Incorrect wheel nuts or improperly tightened wheel nuts can cause the wheel to become loose and even come off. This could lead to an accident. Be sure to use the correct wheel nuts. If you have to replace them, be sure to get the right kind.

Stop somewhere as soon as you can and have the nuts tightened with a torque wrench to 100 lb. ft. (140 N·m).

Don't try to put a wheel cover on your compact spare tire. It won't fit. Store the wheel cover in the trunk until you have the flat tire repaired or replaced.

NOTICE:

Wheel covers won't fit on your compact spare. If you try to put a wheel cover on your compact spare, you could damage the cover or the spare.

 **CAUTION:**

Storing a jack, a tire or other equipment in the passenger compartment of the vehicle could cause injury. In a sudden stop or collision, loose equipment could strike someone. Store all these in the proper place.

COMPACT SPARE TIRE

Although the compact spare was fully inflated when your vehicle was new, it can lose air after a time. Check the inflation pressure regularly. It should be 60 psi (420 kPa). After installing the compact spare on your vehicle, you should stop as soon as possible and make sure your spare tire is correctly inflated. The compact spare is made to perform well at posted speed limits for distances up to 3,000 miles (5,000 km), so you can finish your trip and have your full-size tire repaired or replaced where you want. Of course, it's best to replace your spare with a full-size tire as soon as you can. Your spare will last longer and be in good shape in case you need it again.

NOTICE:

Don't take your compact spare through an automatic car wash with guide rails. The compact spare can get caught on the rails. That can damage the tire and wheel, and maybe other parts of your vehicle.

Don't use your compact spare on some other vehicle.

And don't mix your compact spare or wheel with other wheels or tires. They won't fit. Keep your spare and its wheel together.

NOTICE:

Tire chains won't fit your compact spare. Using them will damage your vehicle and destroy the chains too. Don't use tire chains on your compact spare.

IF YOU'RE STUCK: IN SAND, MUD, ICE OR SNOW

What you don't want to do when your vehicle is stuck is to spin your wheels too fast. The method known as "rocking" can help you get out when you're stuck, but you must use caution.

CAUTION:

If you let your tires spin at high speed, they can explode and you or others could be injured. And, the transaxle or other parts of the vehicle can overheat. That could cause an engine compartment fire or other damage. When you're stuck, spin the wheels as little as possible. Don't spin the wheels above 35 mph (55 km/h) as shown on the speedometer.

NOTICE:

Spinning your wheels can destroy parts of your vehicle as well as the tires. If you spin the wheels too fast while shifting your transaxle back and forth, you can destroy your transaxle.

For information about using tire chains on your vehicle, see "Tire Chains" in the Index.

Rocking your vehicle to get it out:

First, turn your steering wheel left and right. That will clear the area around your front wheels. You should turn your traction control system off. (See "Traction Control System" in the Index.) Then shift back and forth between REVERSE (R) and a forward gear, spinning the wheels as little as possible. Release the accelerator pedal while you shift, and press lightly on the accelerator pedal when the transaxle is in gear. If that doesn't get you out after a few tries, you may need to be towed out. If you do need to be towed out, see "Towing Your Vehicle" in the Index.



SECTION 6

SERVICE AND APPEARANCE CARE

Here you will find information about the care of your Cadillac. This section begins with service and fuel information, and then it shows how to check important fluid and lubricant levels. There is also technical information about your vehicle, and a part devoted to its appearance care.

SERVICE

Your Cadillac dealer knows your vehicle best and wants you to be happy with it. We hope you'll go to your dealer for all your service needs. You'll get genuine GM parts and GM-trained and supported service people.

We hope you'll want to keep your GM vehicle all GM. Genuine GM parts have one of these marks:



Doing Your Own Service Work

If you want to do some of your own service work, you'll want to get the proper Cadillac Service Manual. It tells you much more about how to service your Cadillac than this manual can. To order the proper service manual, see "Service and Owner Publications" in the Index.

Your vehicle has an air bag system. Before attempting to do your own service work, see "Servicing Your Air Bag-Equipped Cadillac" in the Index.

You should keep a record with all parts receipts and list the mileage and the date of any service work you perform. See "Maintenance Record" in your Maintenance booklet.



CAUTION:

You can be injured if you try to do service work on a vehicle without knowing enough about it.

- Be sure you have sufficient knowledge, experience, and the proper replacement parts and tools before you attempt any vehicle maintenance task.
- Be sure to use the proper nuts, bolts and other fasteners. “English” and “metric” fasteners can be easily confused. If you use the wrong fasteners, parts can later break or fall off. You could be hurt.

NOTICE:

If you try to do your own service work without knowing enough about it, your vehicle could be damaged.

FUEL

Use premium unleaded gasoline rated at 91 octane or higher. It should meet specifications ASTM D4814 in the United States and CGSB 3.5-92 in Canada. These fuels should have the proper additives, so you should not have to add anything to the fuel.

In the United States and Canada, it's easy to be sure you get the right kind of gasoline (unleaded). You'll see UNLEADED right on the pump. And only unleaded nozzles will fit into your vehicle's filler neck.

Be sure the posted octane is at least 91. If the octane is less than 91, you may get a heavy knocking noise when you drive. (In an emergency, you may be able to use lower octane -- as low as 87 -- if heavy knocking does not occur.) If you're using 91 or higher octane unleaded gas and you still get heavy knocking, your engine needs service.

What about gasoline with blending materials that contain oxygen (oxygenates), such as MTBE or alcohol?

MTBE is "methyl tertiary-butyl ether." Fuel that is no more than 15% MTBE is fine for your vehicle.

Ethanol is ethyl or grain alcohol. Properly-blended fuel that is no more than 10% *ethanol* is fine for your vehicle.

Methanol is methyl or wood alcohol.

NOTICE:

Fuel that is more than 5% methanol is bad for your vehicle. Don't use it. It can corrode metal parts in your fuel system and also damage plastic and rubber parts. That damage wouldn't be covered under your warranty. And even at 5% or less, there must be "cosolvents" and corrosion preventers in this fuel to help avoid these problems.

Gasolines for Cleaner Air

Your use of gasoline with deposit control additives will help prevent deposits from forming in your engine and fuel system. That helps keep your engine in tune and your emission control system working properly. It's good for your vehicle, and you'll be doing your part for cleaner air.

Many gasolines are now blended with oxygenates. General Motors recommends that you use gasolines with these blending materials, such as MTBE and ethanol. By doing so, you can help clean the air, especially in those parts of the country that have high carbon monoxide levels.

In addition, some gasoline suppliers are now producing reformulated gasolines. These gasolines are specially designed to reduce vehicle emissions. General Motors recommends that you use reformulated gasoline. By doing so, you can help clean the air, especially in those parts of the country that have high ozone levels.

You should ask your service station operators if their gasolines contain deposit control additives and oxygenates, and if they have been reformulated to reduce vehicle emissions.

FUELS IN FOREIGN COUNTRIES

If you plan on driving in another country outside the U.S. or Canada, unleaded fuel may be hard to find. Do not use leaded gasoline. If you use even one tankful, your emission controls won't work well or at all. With continuous use, spark plugs can get fouled, the exhaust system can corrode, and your engine oil can deteriorate quickly. Your vehicle's oxygen sensor will be damaged. All of that means costly repairs that wouldn't be covered by your warranty.

To check on fuel availability, ask an informant or contact a major oil company that does business in the country where you'll be driving.

You can also write us at the following address for advice. Just tell us where you're going and give your Vehicle Identification Number (VIN).

General Motors Overseas Distribution Corporation,
North American Export Sales (NAES)
1908 Colonel Sam Drive
Oshawa, Ontario L1H 8P7

FILLING YOUR TANK



The cap is behind ainged door on the driver's side of your vehicle.

⚠ CAUTION:

Gasoline vapor is highly flammable. It burns violently, and that can cause very bad injuries. Don't smoke if you're near gasoline or refueling your vehicle. Keep sparks, flames, and smoking materials away from gasoline.



The release button is located to the left of the steering wheel next to the headlamp switch. The switch only works in PARK (P) with the ignition key in the RUN position or when in the Retained Accessory Power mode.

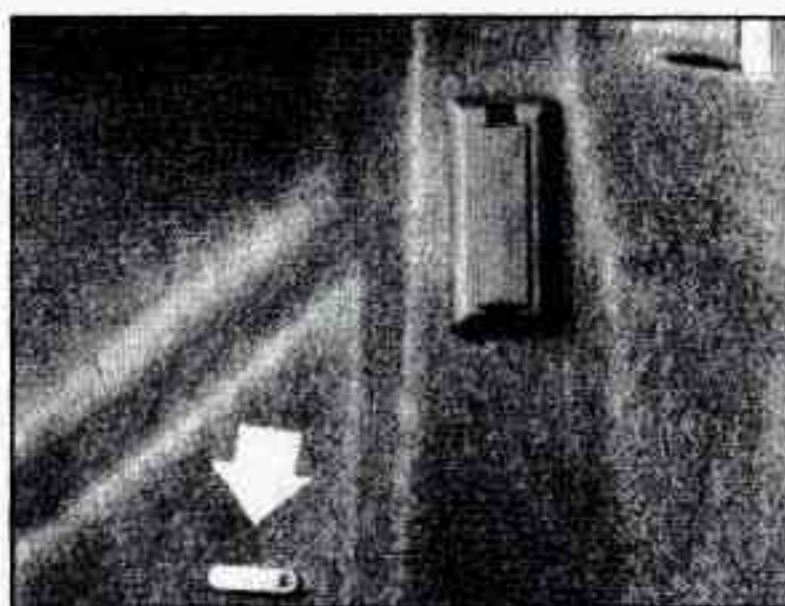

Or you can use the manual door release override on the left side of the trunk.



While refueling, hang the cap inside the fuel door.

To take off the cap, turn it slowly to the left (counterclockwise).

⚠ CAUTION:

If you get gasoline on yourself and then something ignites it, you could be badly burned. Gasoline can spray out on you if you open the fuel filler cap too quickly. This spray can happen if your tank is nearly full, and is more likely in hot weather. Open the fuel filler cap slowly and wait for any "hiss" noise to stop. Then unscrew the cap all the way.

Be careful not to spill gasoline. Clean gasoline from painted surfaces as soon as possible. See "Cleaning the Outside of Your Cadillac" in the Index.

When you put the cap back on, turn it to the right until you hear at least three clicks.

NOTICE:

If you need a new cap, be sure to get the right type. Your dealer can get one for you. If you get the wrong type, it may not fit or have proper venting, and your fuel tank and emissions system might be damaged.

CHECKING THINGS UNDER THE HOOD

 **CAUTION:**

An electric fan under the hood can start up and injure you even when the engine is not running. Keep hands, clothing and tools away from any underhood electric fan.

 **CAUTION:**

Things that burn can get on hot engine parts and start a fire. These include liquids like gasoline, oil, coolant, brake fluid, windshield washer and other fluids, and plastic or rubber. You or others could be burned. Be careful not to drop or spill things that will burn onto a hot engine.

Hood Release

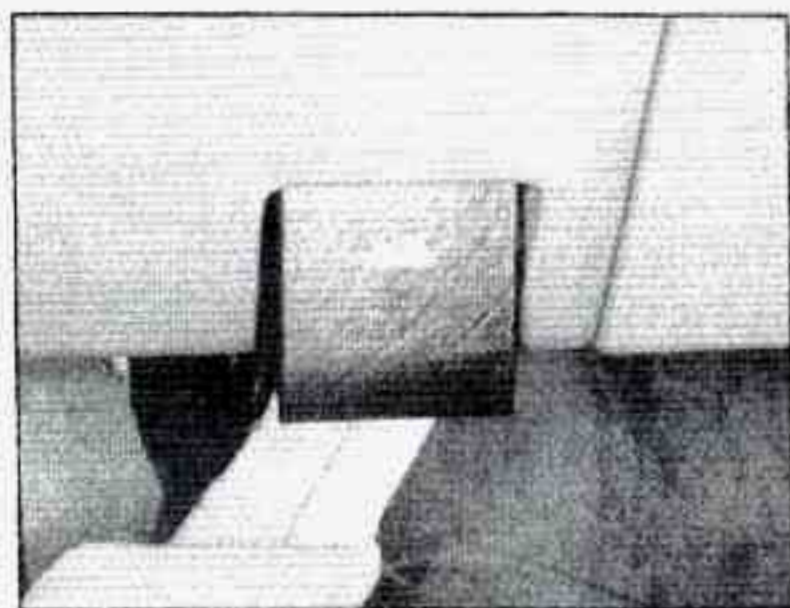

To open the hood, first pull the lever inside the vehicle, located at the lower left side of the instrument panel.

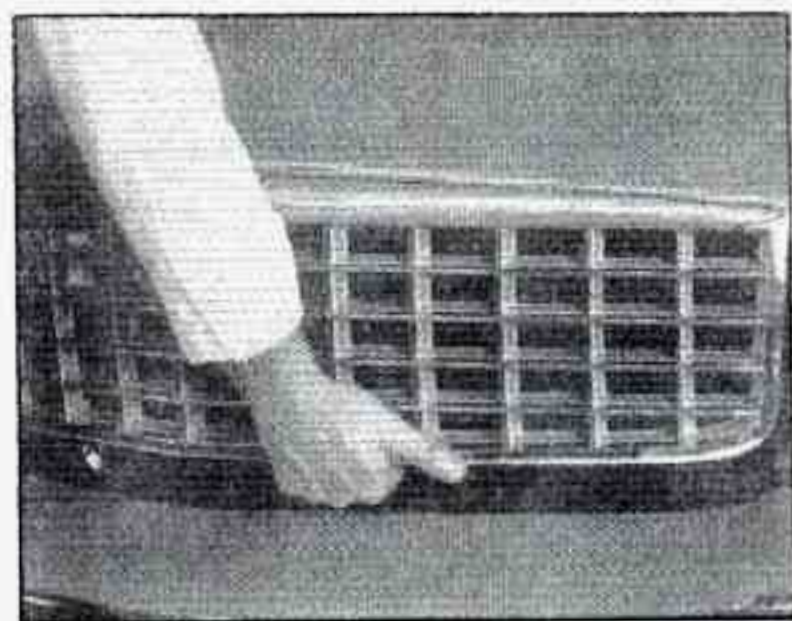

Then go to the front of the vehicle and lift the secondary hood release to open the hood.

Fluid Usage Label

The fluid usage label is a color coded label identifying the various fluids used in your vehicle.

Colors represented on the label match the lettering or handle color of the fluid you want to check.

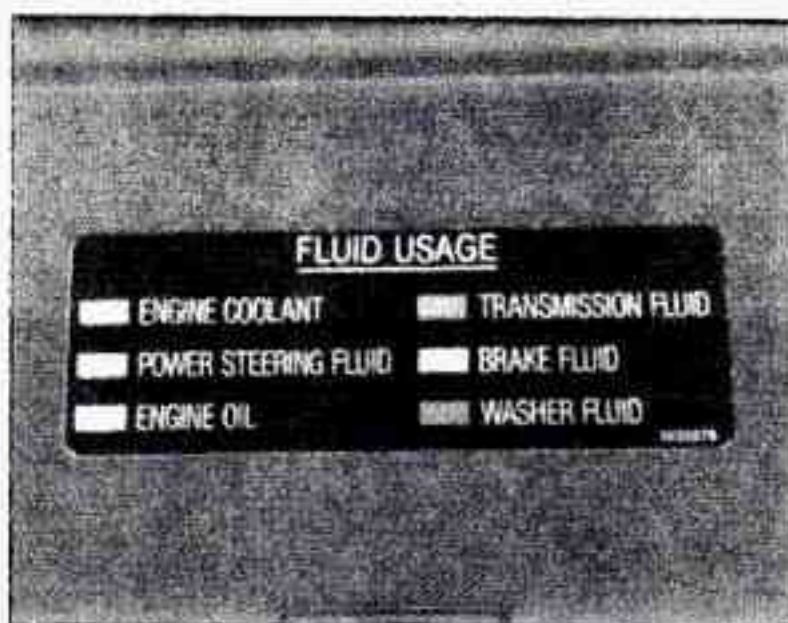

- GREEN: Engine Coolant
- ORANGE: Power Steering Fluid
- YELLOW: Engine Oil
- RED: Transmission Fluid
- WHITE: Brake Fluid
- BLUE: Washer Fluid

ENGINE OIL

If the CHECK OIL light on the instrument panel comes on, it means you need to check your engine oil level right away. For more information, see "Check Oil Light" in the Index. You should check your engine oil level regularly; this is an added reminder.

It's a good idea to check your engine oil every time you get fuel. In order to get an accurate reading, the oil must be warm and the vehicle must be on level ground.



Turn off the engine and give the oil a few minutes to drain back into the oil pan. If you don't, the oil dipstick might not show the actual level.

To Check Engine Oil

Pull out the dipstick and clean it with a paper towel or cloth, then push it back in all the way. Remove it again, keeping the tip down, and check the level.

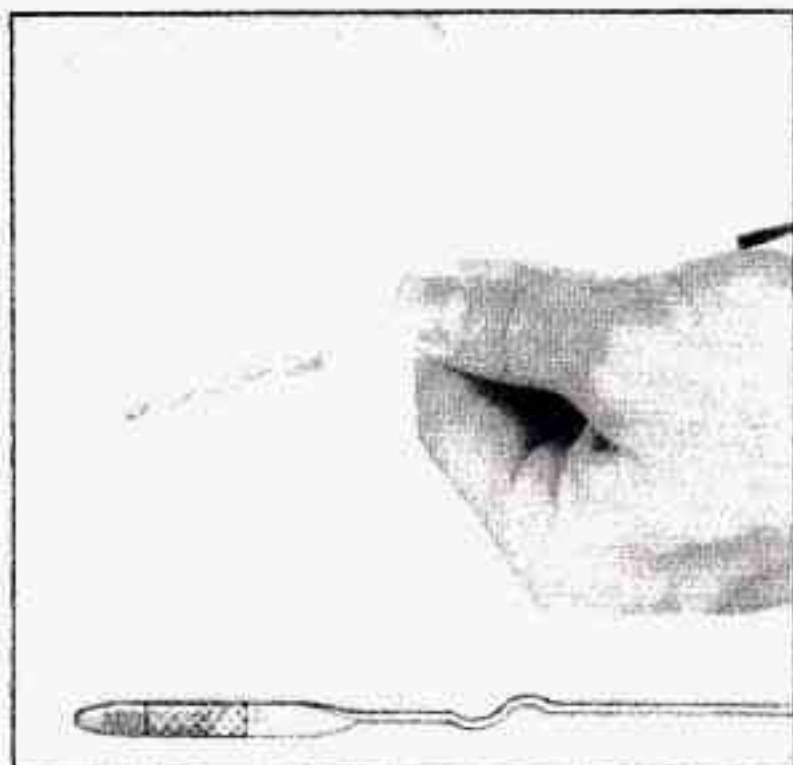

When to Add Oil

If the oil is at or below the ADD line, then you'll need to add some oil. But you must use the right kind. This part explains what kind of oil to use. For crankcase capacity, see "Capacities and Specifications" in the Index.

NOTICE:

Don't add too much oil. If your engine has so much oil that the oil level gets above the cross-hatched area that shows the proper operating range, your engine could be damaged.

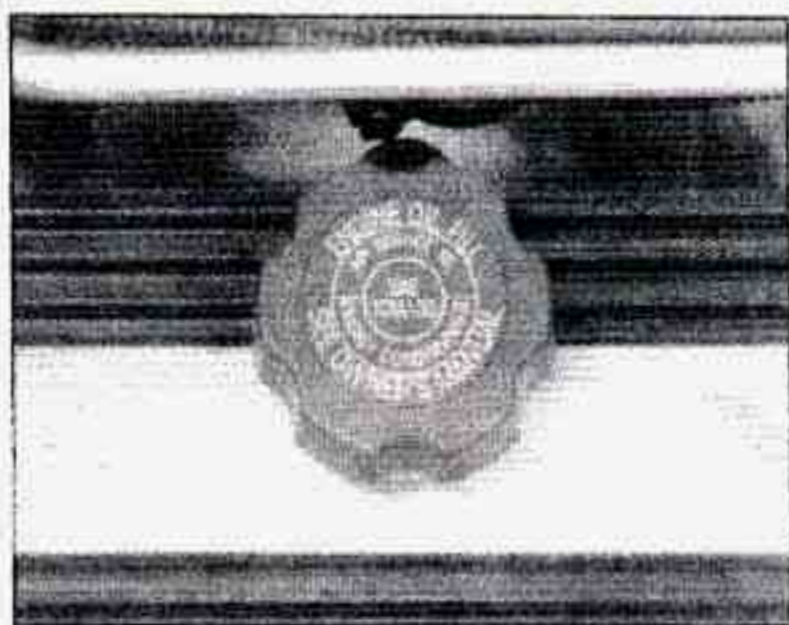

To remove the oil fill cap, turn it counterclockwise.

Just fill it enough to put the level somewhere in the proper operating range. Push the dipstick all the way back in when you're through.

What Kind of Oil to Use

Oils of the proper quality for your vehicle can be identified by looking for the "Starburst" symbol. The "Starburst" symbol indicates that the oil has been certified by the American Petroleum Institute (API) and is preferred for use in your gasoline engine.



If you change your own oil, be sure you use oil that has the “Starburst” symbol on the front of the oil container. If you have your oil changed for you, be sure the oil put into your engine is American Petroleum Institute certified for gasoline engines.

You should also use the proper viscosity oil for your vehicle, as shown in the following chart:

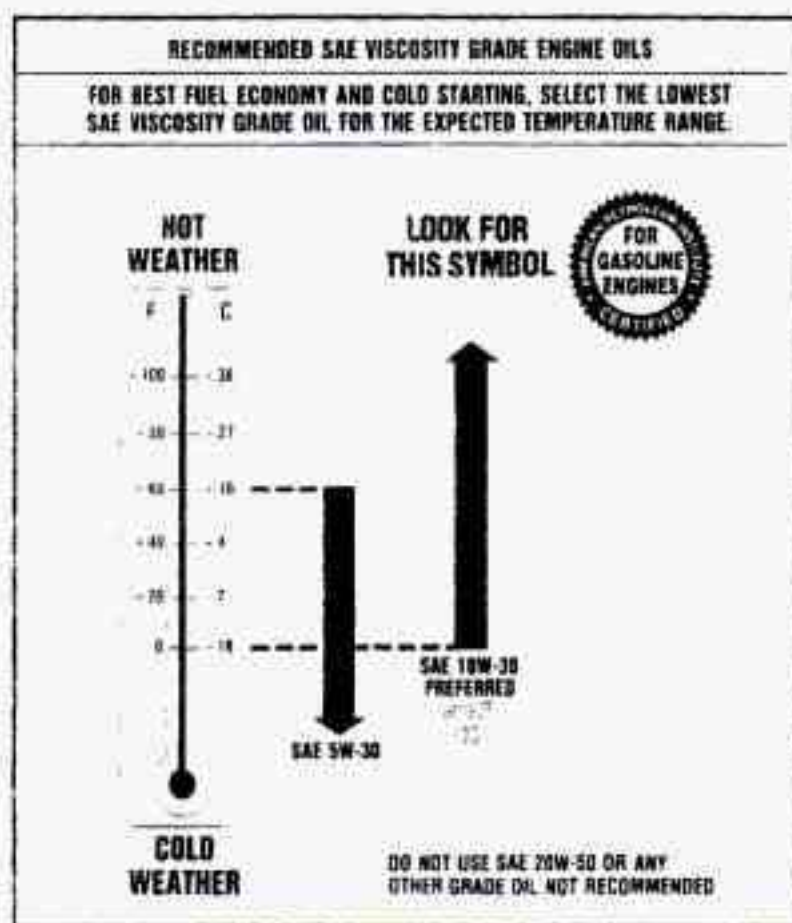

As shown in the chart, SAE 10W-30 is best for your vehicle. However, you can use SAE 5W-30 if it's going to be colder than 60° F (16° C) before your next oil change. When it's very cold, you should use SAE 5W-30. These numbers on an oil container show its viscosity, or thickness. Do not use other viscosity oils, such as SAE 20W-50.

NOTICE:

Use only engine oil with the American Petroleum Institute Certified For Gasoline Engines "Starburst" symbol. Failure to use the proper oil can result in engine damage not covered by your warranty.

GM Goodwrench[®] oil (in Canada, GM Engine Oil) meets all the requirements for your vehicle.

Engine Oil Additives

Don't add anything to your oil. Your Cadillac dealer is ready to advise if you think something should be added.

When to Change Engine Oil

Your Cadillac has an "Oil Life Indicator." This feature will let you know when to change your oil and filter -- usually between 3,000 miles (5 000 km) and 7,500 miles (12 500 km) since your last oil change. Under severe conditions, the indicator may come on before 3,000 miles (5 000 km). Never drive your vehicle more than 7,500 miles (12 500 km) or 12 months without an oil change.

The system won't detect dust in the oil. So, if you drive in a dusty area, be sure to change your oil every 3,000 miles (5 000 km) or sooner if the CHANGE OIL SOON light comes on. Remember to reset the Oil Life Indicator when the oil has been changed. For more information, see "Oil Life Indicator" in the Index.

How to Reset the Oil Life Indicator

After the oil has been changed, display the OIL LIFE LEFT message by pressing the INFORMATION button. Then press and hold the RESET button until the display shows "100." This resets the oil life index. The message will remain off until the next oil change is needed. The percentage of oil life remaining may be checked at any time by pressing the INFORMATION button several times until the OIL LIFE LEFT message appears. For more information on the Oil Life Index feature, see "Oil Life Index" in the Index.

Engine Coolant Heater

An engine coolant heater can be a big help if you have to park outside in very cold weather, 0° F (-18° C) or colder. If your vehicle has this option, see "Engine Coolant Heater" in the Index.

What to Do with Used Oil

Did you know that used engine oil contains certain elements that may be unhealthy for your skin and could even cause cancer? Don't let used oil stay on your skin for very long. Clean your skin and nails with soap and water, or a good hand cleaner. Wash or properly throw away clothing or rags containing used engine oil. (See the manufacturer's warnings about the use and disposal of oil products.)

Used oil can be a real threat to the environment. If you change your own oil, be sure to drain all free-flowing oil from the filter before disposal. Don't ever dispose of oil by putting it in the trash, pouring it on the ground, into sewers, or into streams or bodies of water. Instead, recycle it by taking it to a place that collects used oil. If you have a problem properly disposing of your used oil, ask your dealer, a service station or a local recycling center for help.

AIR CLEANER

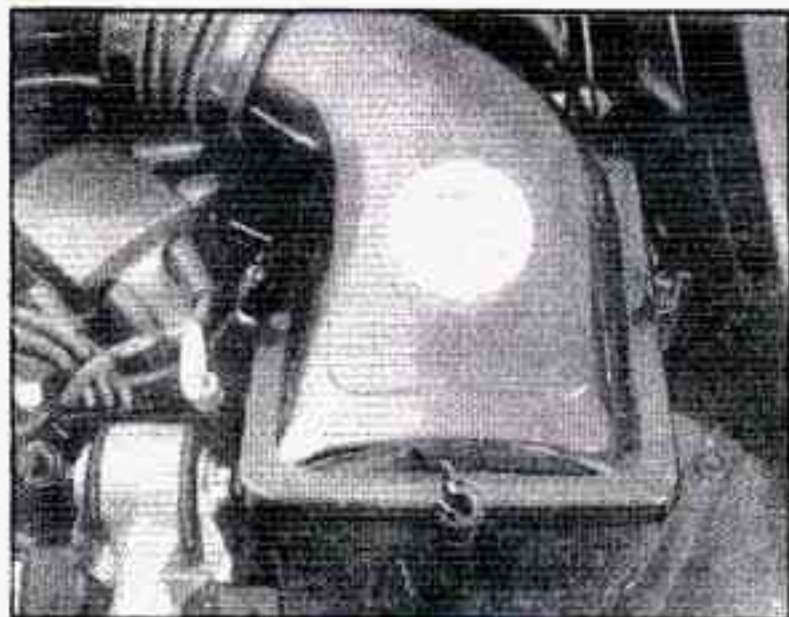

To gain access to the air filter loosen the four screws and lift the top half of the air cleaner assembly.

Refer to the Maintenance Schedule to determine when to replace the air filter.

CAUTION:

Operating the engine with the air cleaner off can cause you or others to be burned. The air cleaner not only cleans the air, it stops flame if the engine backfires. If it isn't there, and the engine backfires, you could be burned. Don't drive with it off, and be careful working on the engine with the air cleaner off.

NOTICE:

If the air cleaner is off, a backfire can cause a damaging engine fire. And, dirt can easily get into your engine, which will damage it. Always have the air cleaner in place when you're driving.

AUTOMATIC TRANSAXLE FLUID

When to Check and Change

A good time to check your automatic transaxle fluid level is when the engine oil is changed. Refer to the Maintenance Schedule to determine when to change your fluid.

How to Check

Because this operation can be a little difficult, you may choose to have this done at your Cadillac dealership Service Department.

If you do it yourself, be sure to follow all the instructions here, or you could get a false reading on the dipstick.

NOTICE:

Too much or too little fluid can damage your transaxle. Too much can mean that some of the fluid could come out and fall on hot engine parts or exhaust system parts, starting a fire. Be sure to get an accurate reading if you check your transaxle fluid.

Wait at least 30 minutes before checking the transaxle fluid level if you have been driving:

- When outside temperatures are above 90° F (32° C).
- At high speed for quite a while.
- In heavy traffic -- especially in hot weather.
- While pulling a trailer.

To get the right reading, the fluid should be at normal operating temperature, which is 180° F to 200° F (82° C to 93° C).

Get the vehicle warmed up by driving about 15 miles (24 km) when outside temperatures are above 50° F (10° C). If it's colder than 50° F (10° C), you may have to drive longer.

To check the fluid level

- Park your vehicle on a level place. Keep the engine running.
- With the parking brake applied, place the shift lever in PARK (P).
- With your foot on the brake pedal, move the shift lever through each gear range, pausing for about three seconds in each range. Then, position the shift lever in PARK (P).
- Let the engine run at idle for three to five minutes.

Then, without shutting off the engine, follow these steps:

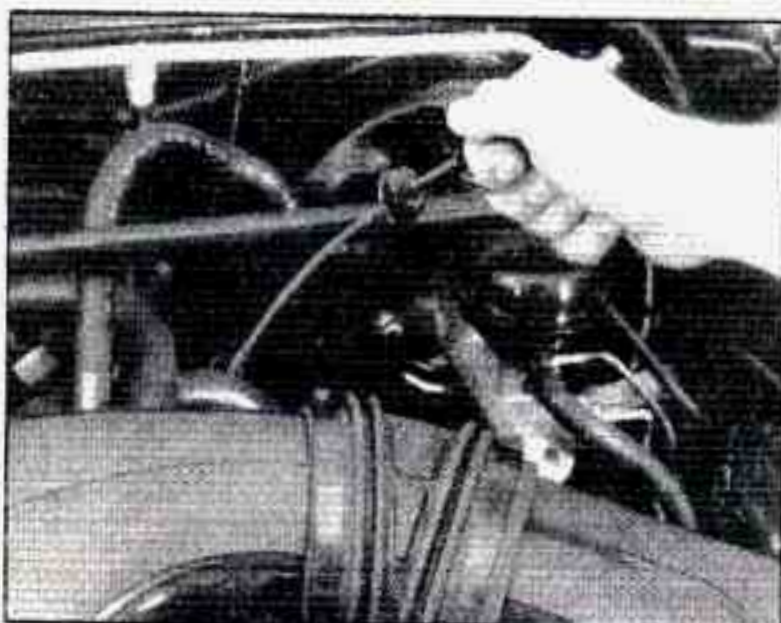

1. Pull out the dipstick and wipe it with a clean rag or paper towel.

2. Push it back in all the way, wait three seconds and then pull it back out again.

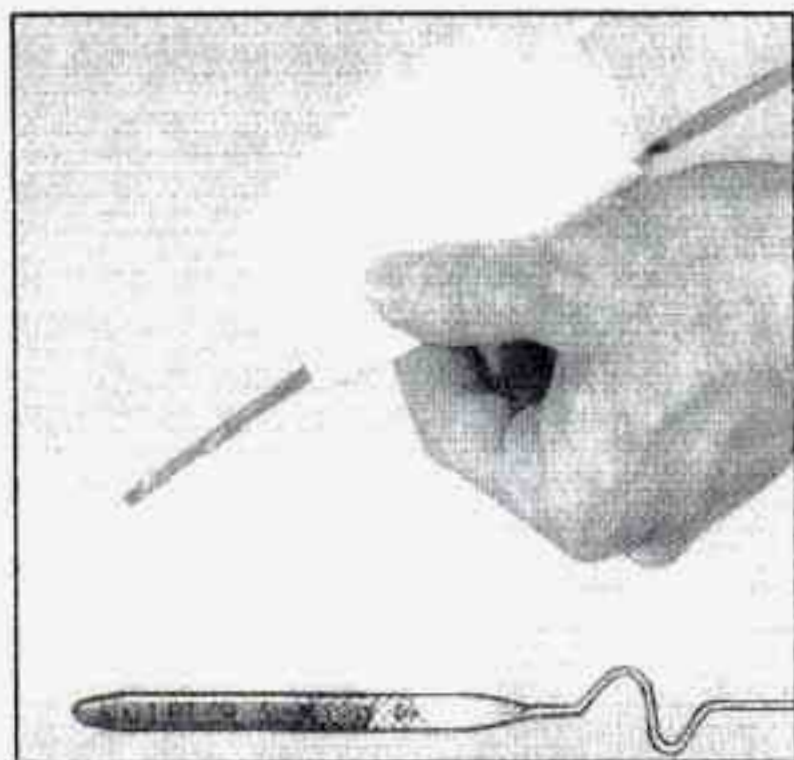

3. Check both sides of the dipstick, and read the lower level. The fluid level must be in the cross-hatched area.
4. If the fluid level is in the acceptable range, push the dipstick back in all the way.

How to Add Fluid

Refer to the Maintenance Schedule to determine what kind of transaxle fluid to use.

If the fluid level is low, add only enough of the proper fluid to bring the level into the cross-hatched area on the dipstick.

1. Pull out the dipstick.
 2. Using a long-neck funnel, add enough fluid at the dipstick hole to bring it to the proper level. It doesn't take much fluid, generally less than a pint (0.5L). *Don't overfill.* We recommend you use only fluid labeled DEXRON[®]-III, because fluid with that label is made especially for your automatic transaxle. Damage caused by fluid other than DEXRON[®]-III is not covered by your new vehicle warranty.
- After adding fluid, recheck the fluid level as described under "How to Check."
 - When the correct fluid level is obtained, push the dipstick back in all the way.

How to Reset Transaxle Fluid Change Indicator

Your vehicle is equipped with a Transaxle Fluid Change Indicator. A CHANGE TRANS FLUID message will display on the Information Center when the powertrain computer determines that the transaxle fluid needs to be changed, or at each 100,000 mile (160 000 km) interval, whichever comes first. When this message appears, change the transaxle fluid and reset the transaxle fluid indicator as follows:

- Turn the key ON but do not start the engine.
- Press and hold the OFF and REAR DEFROG buttons on the climate control simultaneously until the TRANS FLUID RESET message appears in the Information Center (between five and 20 seconds).

ENGINE COOLANT

The following explains your cooling system and how to add coolant when it is low. If you have a problem with engine overheating, see "Engine Overheating" in the Index.

The proper coolant for your Cadillac will:

- Give freezing protection down to -34°F (-37°C).
- Give boiling protection up to 262°F (128°C).
- Protect against rust and corrosion.
- Help keep the proper engine temperature.
- Let the warning lights work as they should.

What to Use

Use a mixture of one-half *clean water* (preferably distilled) and one-half antifreeze that meets "GM Specification 1825-M," which won't damage aluminum parts. You can also use a recycled coolant conforming to GM Specification 1825-M with a complete coolant flush and refill. Use GM Engine Coolant Supplement (sealer) with any complete coolant flush and refill. If you use this mixture, you don't need to add anything else.

 **CAUTION:**

Adding only plain water to your cooling system can be dangerous. Plain water, or some other liquid like alcohol, can boil before the proper coolant mix will. Your vehicle's coolant warning system is set for the proper coolant mix. With plain water or the wrong mix, your engine could get too hot but you wouldn't get the overheat warning. Your engine could catch fire and you or others could be burned. Use a 50:50 mix of clean water and a proper antifreeze.

NOTICE:

If you use an improper coolant mix, your engine could overheat and be badly damaged. The repair cost wouldn't be covered by your warranty. Too much water in the mix can freeze and crack the engine, radiator, heater core and other parts.

Adding Coolant

The coolant recovery tank is located under the hood on the right side of your vehicle.

To Check Coolant

When your engine is cold, the coolant level should be at the FULL COLD mark or a little higher. When your engine is warm, the level should be up to the FULL HOT mark or a little higher.

To Add Coolant

If you need more coolant, add the proper mix *at the coolant recovery tank*.

 **CAUTION:**

Turning the radiator pressure cap when the engine and radiator are hot can allow steam and scalding liquids to blow out and burn you badly. With the coolant recovery tank, you will almost never have to add coolant at the radiator. Never turn the radiator pressure cap -- even a little -- when the engine and radiator are hot.

Add coolant mix at the recovery tank, but be careful not to spill it.

 **CAUTION:**

You can be burned if you spill coolant on hot engine parts. Coolant contains ethylene glycol, and it will burn if the engine parts are hot enough. Don't spill coolant on a hot engine.

RADIATOR PRESSURE CAP

NOTICE:

Your radiator pressure cap is a 15 psi (105 kPa) pressure-type cap and must be tightly installed to prevent coolant loss and possible engine damage from overheating. Be sure the arrows on the cap line up with the overflow tube on the radiator filler neck.

If your radiator pressure cap needs to be replaced an AC[®] cap is recommended.

THERMOSTAT

Engine coolant temperature is controlled by a thermostat in the engine coolant system. The thermostat stops the flow of coolant through the radiator until the coolant reaches a preset temperature.

If your thermostat needs to be replaced an AC[®] thermostat is recommended.

POWER STEERING FLUID

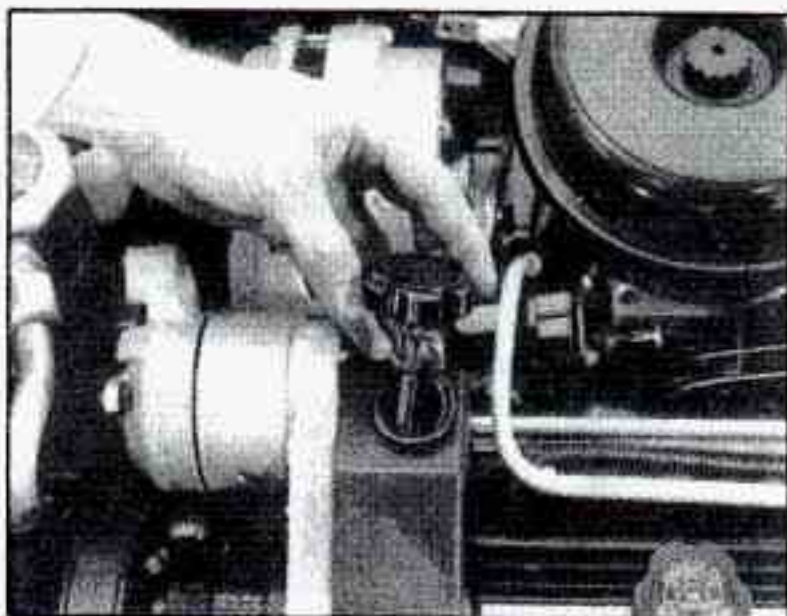

How to Check Power Steering Fluid

When the engine compartment is cool, unscrew the cap and wipe the dipstick with a clean rag. Replace the cap and completely tighten it. Then remove the cap again and look at the fluid level on the dipstick.

The level should be at the FULL COLD mark. Add enough fluid to bring the level up to the mark.

A fluid loss in this system could indicate a problem. Have the system inspected and repaired.

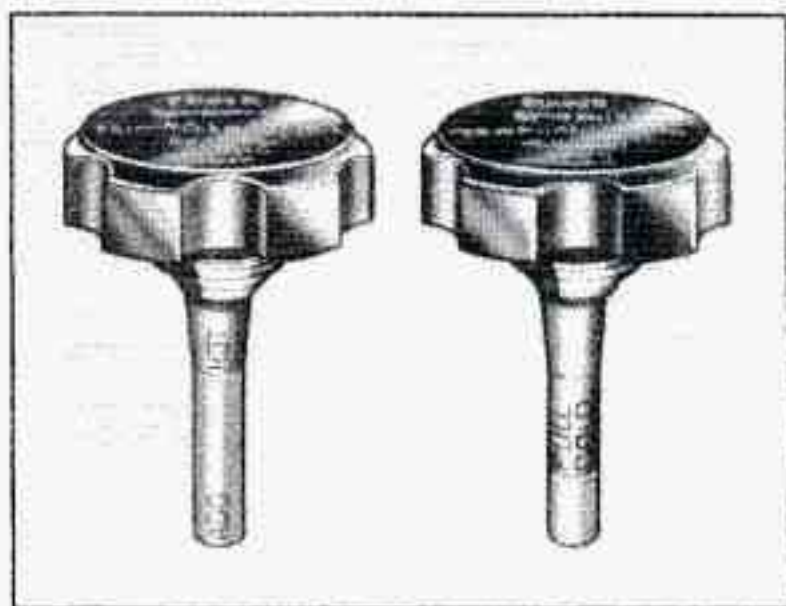

What to Add

Refer to the Maintenance Schedule to determine what kind of fluid to use.

NOTICE:

When adding power steering fluid or making a complete fluid change, always use the proper fluid. Failure to use the proper fluid can cause leaks and damage hoses and seals.

WINDSHIELD WASHER FLUID

What to Use

When you need windshield washer fluid, be sure to read the manufacturer's instructions before use. If you will be operating your vehicle in an area where the temperature may fall below freezing, use a fluid that has sufficient protection against freezing.

To Add



Open the cap labeled **WASHER FLUID ONLY**. Add washer fluid until the tank is full.

NOTICE:

- When using concentrated washer fluid, follow the manufacturer's instructions for adding water.
- Don't mix water with ready-to-use washer fluid. Water can cause the solution to freeze and damage your washer fluid tank and other parts of the washer system. Also, water doesn't clean as well as washer fluid.
- Fill your washer fluid tank only 3/4 full when it's very cold. This allows for expansion, which could damage the tank if it is completely full.
- Don't use radiator antifreeze in your windshield washer. It can damage your washer system and paint.

BRAKES

Brake Master Cylinder

Your brake master cylinder is here. It is filled with DOT-3 brake fluid.



There are only two reasons why the brake fluid level in your master cylinder might go down. The first is that the brake fluid goes down to an acceptable level during normal brake lining wear. When new linings are put in, the fluid level goes back up. The other reason is that fluid is leaking out of the brake system. If it is, you should have your brake system fixed, since a leak means that sooner or later your brakes won't work well, or won't work at all. So, it isn't a good idea to "top off" your brake fluid. Adding brake fluid won't correct a leak. If you add fluid when your linings are worn, then you'll have too much fluid when you get new brake linings. You should add (or remove) brake fluid, as necessary, only when work is done on the brake hydraulic system.



CAUTION:

If you have too much brake fluid, it can spill on the engine. The fluid will burn if the engine is hot enough. You or others could be burned, and your vehicle could be damaged. Add brake fluid only when work is done on the brake hydraulic system.

To Check Brake Fluid

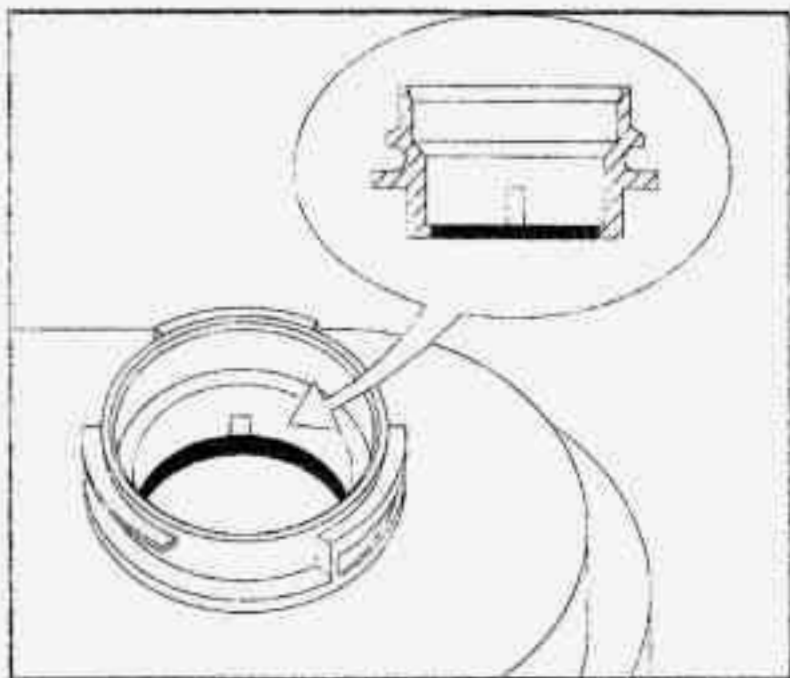

Remove the cap.

The fluid level must be to the maximum fill line at the base of the neck as shown.

When your brake fluid falls to a low level, your brake warning light will come on. See "Brake System Warning Light" in the Index.

What to Add

When you do need brake fluid, use only DOT-3 brake fluid -- such as Delco Supreme 11[®] (GM Part No. 1052535). Use new brake fluid from a sealed container only, and always clean the brake fluid reservoir cap before removing it.

NOTICE:

- Don't let someone put in the wrong kind of fluid. For example, just a few drops of mineral-based oil, such as engine oil, in your brake system can damage brake system parts so badly that they'll have to be replaced.
- Brake fluid can damage paint, so be careful not to spill brake fluid on your vehicle. If you do, wash it off immediately. See "Appearance Care" in the Index.

Brake Wear

Your Cadillac has four-wheel disc brakes.

Disc brake pads have built-in wear indicators that make a high-pitched warning sound when the brake pads are worn and new pads are needed. The sound may come and go or be heard all the time your vehicle is moving (except when you are pushing on the brake pedal firmly).

CAUTION:

The brake wear warning sound means that sooner or later your brakes won't work well. That could lead to an accident. When you hear the brake wear warning sound, have your vehicle serviced.

NOTICE:

Continuing to drive with worn-out brake pads could result in costly brake repair.

Some driving conditions or climates may cause a brake squeal when the brakes are first applied or lightly applied. This does not mean something is wrong with your brakes.

Brake linings should always be replaced as complete axle sets.

Brake Pedal Travel

See your dealer if the brake pedal does not return to normal height, or if there is a rapid increase in pedal travel. This could be a sign of brake trouble.

Brake Adjustment

Every time you apply the brakes, with or without the vehicle moving, your brakes adjust for wear.

Replacing Brake System Parts

The braking system on a modern vehicle is complex. Its many parts have to be of top quality and work well together if the vehicle is to have really good braking. Vehicles we design and test have top-quality GM brake parts in them, as your Cadillac does when it is new. When you replace parts of your braking system -- for example, when your brake linings wear down and you have to have new ones put in -- be sure you get new genuine GM replacement parts. If you don't, your brakes may no longer work properly. For example, if someone puts in brake linings that are wrong for your vehicle, the balance between your front and rear brakes can change -- for the worse. The braking performance you've come to expect can change in many other ways if someone puts in the wrong replacement brake parts.

BATTERY

Every new Cadillac has a Delco Freedom[®] battery. You never have to add water to one of these. When it's time for a new battery, we recommend a Delco Freedom[®] battery. Get one that has the replacement number shown on the original battery's label.

Vehicle Storage

If you're not going to drive your vehicle for 25 days or more, take off the black, negative (-) cable from the battery. This will help keep your battery from running down.



CAUTION:

Batteries have acid that can burn you and gas that can explode. You can be badly hurt if you aren't careful. See "Jump Starting" in the Index for tips on working around a battery without getting hurt.

Contact your dealer to learn how to prepare your vehicle for longer storage periods.

Battery Power Loss

If you lose battery power or the battery is disconnected, your car's computer must be programmed. It takes just over 20 minutes to do it. If you want to do it yourself, here's how:

1. Apply the parking brake.
2. Make sure the front wheels are straight.
3. Turn off the Electronic Climate Control.

4. Start the engine in PARK (P) and let it idle for *15 minutes*. Then:
5. Put your foot on the brake pedal, shift the transaxle to OVERDRIVE (Ⓢ) and let it idle for *three minutes or more*.
6. With the car in OVERDRIVE (Ⓢ), turn the Electronic Climate Control to AUTO and let the engine idle for *three minutes or more*.
7. Turn your engine off.

Now your computer is programmed.

HALOGEN BULBS



CAUTION:

Halogen bulbs have pressurized gas inside and can burst if you drop or scratch the bulb. You or others could be injured. Take special care when handling and disposing of halogen bulbs.

EXTERIOR LAMP HOUSINGS

Your Cadillac's lamp housings are designed with small vents so moisture will be removed when the lamps are on or after driving for a short time. If an excessive amount of moisture is present which does not clear, see your Cadillac dealer for service.

HEADLAMP BULB REMOVAL

Here is how to change the halogen headlamp bulb. Begin by lifting up on the access cover.



1. Rotate the headlamp housing socket one quarter-turn and gently remove the headlamp housing socket and bulb.

2. Disconnect the socket from the harness by separating the locking clip.

NOTICE:

Do not touch the glass portion of the new halogen bulb! The oil from your fingers will shorten the life of your new halogen bulb.

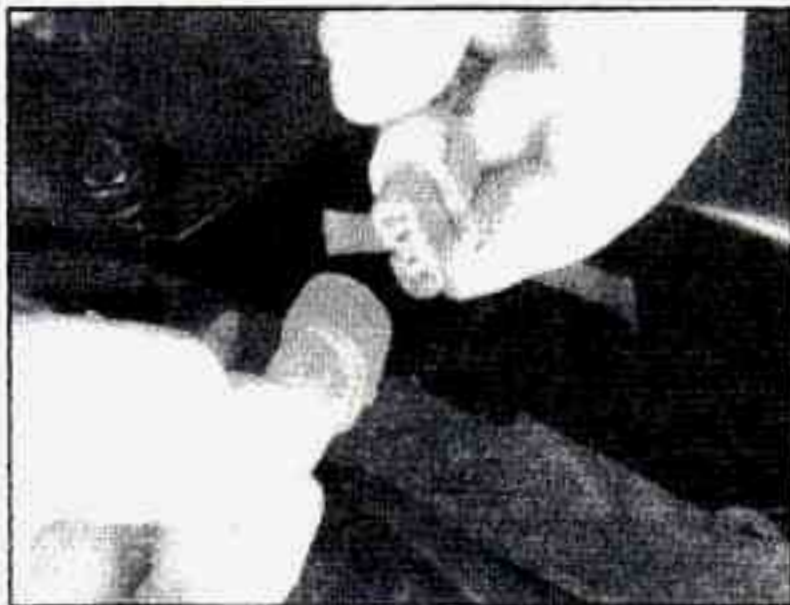

3. Install the new bulb and socket to the wiring harness connector. Make sure that the harness is locked to the bulb socket.

4. Now reinstall into the lamp assembly

CORNERING LAMP BULB REPLACEMENT

1. Open the hood to gain access to the mounting screw.



2. Remove the screw securing the cornering lamp housing.



3. Gently pull out the cornering lamp assembly.

4. Remove the socket by rotating it counterclockwise slightly, then replace the bulb and reinstall.



5. When installing the cornering lamp housing be sure that the two guide pins are aligned with the holes.

TAILLAMP BULB REPLACEMENT

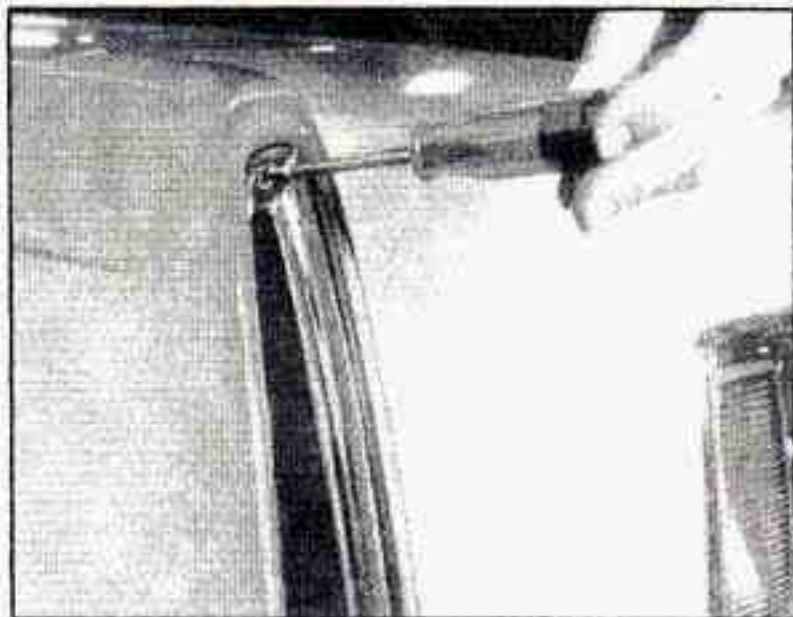

1. Loosen the upper Torx[®] screw, but don't remove it.

2. Gently tilt the top portion of the taillamp housing to access the bulb sockets. If you can't access the lower bulb socket, remove the taillamp housing completely.



3. Press the bulb socket housing lever and rotate the socket counterclockwise to remove it.

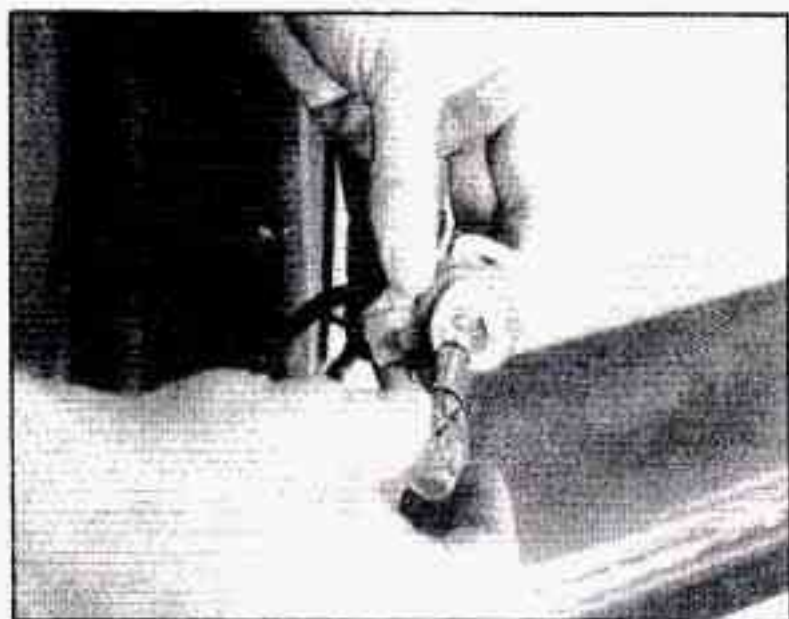

4. Replace the bulb by pressing and twisting it counterclockwise.

5. Once you have installed the new bulb and socket into the taillamp housing, insert the tab on the lower portion of the taillamp housing first, then gently fit the rest of the housing in place.

Center High Mounted Stop Lamp Bulb Replacement

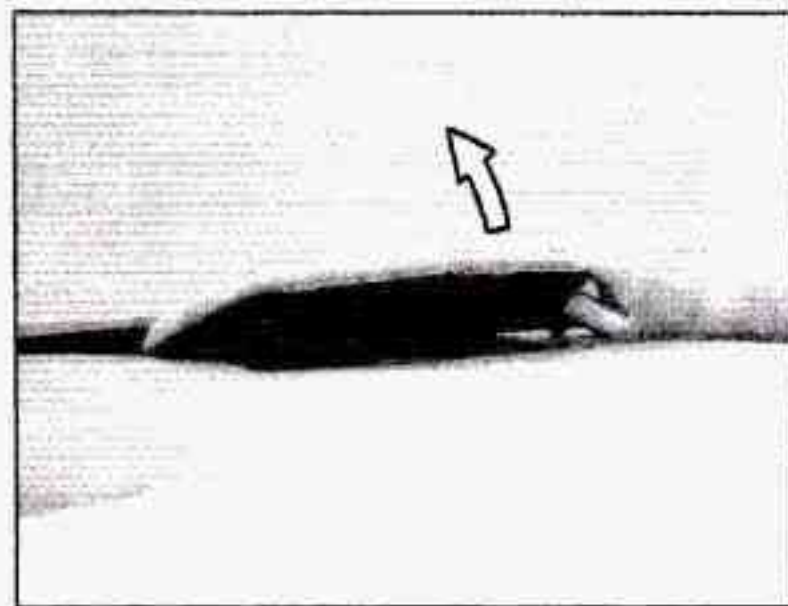

1. Gently pry up on the trim cover.

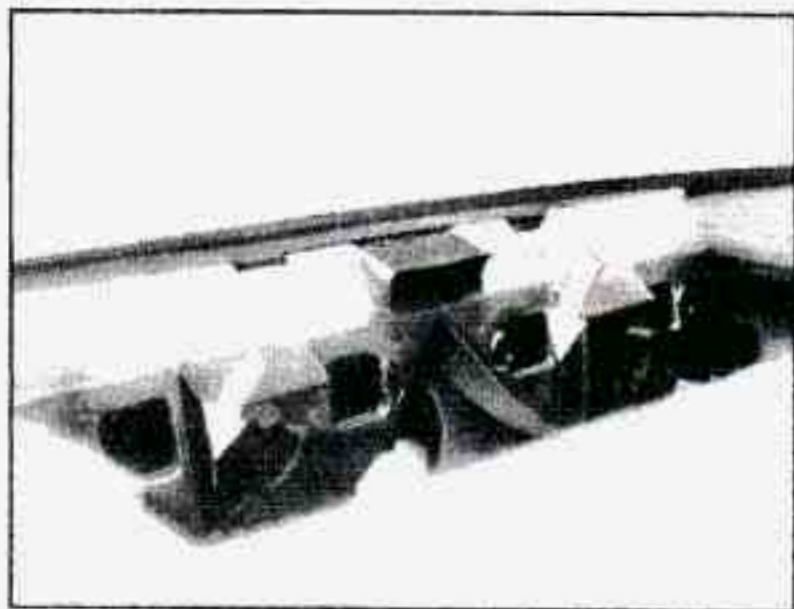

2. Twist the socket counterclockwise and remove the socket and bulb from the housing.
3. Replace the bulb and reinstall.

WIPER BLADE REPLACEMENT

To replace the entire wiper blade, follow these steps:

1. Position the windshield wipers on the windshield in the "mid" wipe position. To do this, turn the ignition key to **ACCESSORY** and turn the wipers on. Then with the door open, turn the ignition key to **OFF**.



2. Insert the tip of a small screwdriver into the slot as shown and gently press down to release the wiper blade from the arm.

3. To install the wiper blade, align the wiper arm pin with the hole on the wiper blade assembly and snap it into place. Return the wipers to their normal position.

If you only want to replace the wiper insert, follow these steps:

1. Position the windshield wipers on the windshield in the "mid" wipe position. To do this, turn the ignition key to **ACCESSORY** and turn the wipers on. Then with the door open, turn the ignition key to **OFF**.
2. Insert the tip of a small screwdriver into the slot as shown and gently press down to release the wiper blade from the arm.
3. Insert a small coin between the edge of the blade housing and the rubber blade insert
4. Carefully apply pressure until the insert clears one side of the housing tabs.
5. Now pull the insert from the blade housing.
6. Reinstall the new insert by aligning the blade housing tabs and the edge of the insert, starting with the second set from the outer edge. Make sure that the insert is connected to all of the housing tabs and that it moves freely back and forth.
7. To install the wiper blade, align the wiper arm pin with the hole on the wiper blade assembly and snap it into place. Return the wipers to their normal position.

TIRES

We don't make tires. Your Cadillac comes with high-quality tires made by a leading tire manufacturer. If you ever have questions about your tire warranty and where to obtain service, see your Cadillac Warranty booklet for details.

 **CAUTION:**

Poorly maintained and improperly used tires are dangerous.

- **Overloading your tires can cause overheating as a result of too much friction. You could have an air-out and a serious accident. See "Loading Your Vehicle" in the Index.**
- **Underinflated tires pose the same danger as overloaded tires. The resulting accident could cause serious injury. Check all tires frequently to maintain the recommended pressure. Tire pressure should be checked when your tires are cold.**
- **Overinflated tires are more likely to be cut, punctured, or broken by a sudden impact, such as when you hit a pothole. Keep tires at the recommended pressure.**
- **Worn, old tires can cause accidents. If your tread is badly worn, or if your tires have been damaged, replace them.**

See "Inflation - Tire Pressure" in this section for inflation pressure adjustment for higher speed driving.

Inflation - Tire Pressure

The Tire-Loading Information label which is located on the driver's door shows the correct inflation pressures for your tires, when they're cold. "Cold" means your vehicle has been sitting for at least three hours or driven no more than a mile.

If you'll be driving at speeds higher than 100 mph (160 km/h) where it is legal, raise the "cold" inflation pressure of each tire to 35 psi (240 kPa). When you end this very high speed driving, reduce the "cold" inflation pressures to those listed on the Tire-Loading Information label.

NOTICE:

Don't let anyone tell you that underinflation or overinflation is all right. It's not. If your tires don't have enough air (underinflation) you can get:

- Too much flexing
- Too much heat
- Tire overloading
- Bad wear
- Bad handling
- Bad fuel economy.

If your tires have too much air (overinflation), you can get:

- Unusual wear
- Bad handling
- Rough ride
- Needless damage from road hazards.

When to Check

Check your tires once a month or more.

Don't forget your compact spare tire. It should be at 60 psi (420 kPa).

How to Check

Use a good quality pocket-type gage to check tire pressure. Simply looking at the tires will not tell you the pressure, especially if you have radial tires -- which may look properly inflated even if they're underinflated.

If your tires have valve caps, be sure to put them back on. They help prevent leaks by keeping out dirt and moisture.

Tire Inspection and Rotation

Tires should be inspected every 6,000 to 8,000 miles (10,000 to 13,000 km) for any signs of unusual wear. If unusual wear is present, rotate your tires as soon as possible and check wheel alignment. Also check for damaged tires or wheels. See "When it's Time for New Tires" and "Wheel Replacement" later in this section for more information.

The purpose of regular rotation is to achieve more uniform wear for all tires on the vehicle. The first rotation is the most important. See "Scheduled Maintenance Services" in the Maintenance booklet for scheduled rotation intervals.

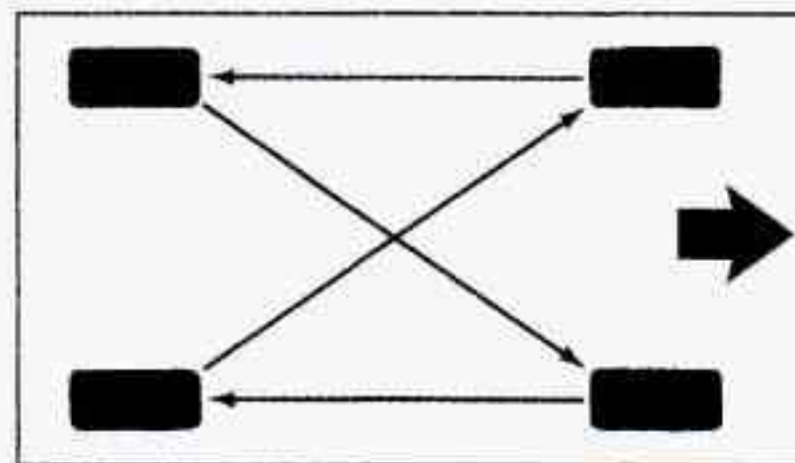

When rotating your tires, always use the correct rotation pattern shown here.

After the tires have been rotated, adjust the front and rear inflation pressures as shown on the Tire-Loading Information label. Make certain that all wheel nuts are properly tightened. See "Wheel Nut Torque" in the Index.

⚠ CAUTION:

Rust or dirt on a wheel, or on the parts to which it is fastened, can make wheel nuts become loose after a time. The wheel could come off and cause an accident. When you change a wheel, remove any rust or dirt from places where the wheel attaches to the vehicle. In an emergency, you can use a cloth or a paper towel to do this; but be sure to use a scraper or wire brush later, if you need to, to get all the rust or dirt off. (See "Changing a Flat Tire" in the Index.)

When it's Time for New Tires



One way to tell when it's time for new tires is to check the treadwear indicators, which will appear when your tires have only 1/16 inch (1.6 mm) or less of tread remaining.

You need a new tire if:

- You can see the indicators at three or more places around the tire.
- You can see cord or fabric showing through the tire's rubber.

- The tread or sidewall is cracked, cut or snagged deep enough to show cord or fabric.
- The tire has a bump, bulge or split.
- The tire has a puncture, cut, or other damage that can't be repaired well because of the size or location of the damage.

Buying New Tires

To find out what kind and size of tires you need, look at the Tire-Loading Information label.

The tires installed on your vehicle when it was new had a Tire Performance Criteria Specification (TPC Spec) number on each tire's sidewall. When you get new tires, get ones with that same TPC Spec number. That way, your vehicle will continue to have tires that are designed to give proper endurance, handling, speed rating, traction, ride and other things during normal service on your vehicle. If your tires have an all-season tread design, the TPC number will be followed by an "MS" (for mud and snow).

If you ever replace your tires with those not having a TPC Spec number, make sure they are the same size, load range, speed rating and construction type (bias, bias-belted or radial) as your original tires.



CAUTION:

Mixing tires could cause you to lose control while driving. If you mix tires of different sizes or types (radial and bias-belted tires), the vehicle may not handle properly, and you could have a crash. Be sure to use the same size and type tires on all four wheels.

It's all right to drive with your compact spare, though. It was developed for use on your vehicle.

Uniform Tire Quality Grading

The following information relates to the system developed by the United States National Highway Traffic Safety Administration which grades tires by treadwear, traction and temperature performance. (This applies only to vehicles sold in the United States.)

Treadwear

The treadwear grade is a comparative rating based on the wear rate of the tire when tested under controlled conditions on a specified government test course. For example, a tire graded 150 would wear one and a half (1 1/2) times as well on the government course as a tire graded 100. The relative performance of tires depends upon the actual conditions of their use, however, and may depart significantly from the norm due to variations in driving habits, service practices and differences in road characteristics and climate.

Traction - A, B, C

The traction grades, from highest to lowest are: A, B, and C. They represent the tire's ability to stop on wet pavement as measured under controlled conditions on specified government test surfaces of asphalt and concrete. A tire marked C may have poor traction performance.

Warning: The traction grade assigned to this tire is based on braking (straight-ahead) traction tests and does not include cornering (turning) traction.

Temperature - A, B, C

The temperature grades are A (the highest), B, and C, representing the tire's resistance to the generation of heat and its ability to dissipate heat when tested under controlled conditions on a specified indoor laboratory test wheel. Sustained high temperature can cause the material of the tire to degenerate and reduce tire life, and excessive temperature can lead to sudden tire failure. The grade C corresponds to a level of performance which all passenger car tires must meet under the Federal Motor Vehicle Safety Standard No. 109. Grades B and A represent higher levels of performance on the laboratory test wheel than the minimum required by law.

Warning: The temperature grade for this tire is established for a tire that is properly inflated and not overloaded. Excessive speed, underinflation, or excessive loading, either separately or in combination, can cause heat buildup and possible tire failure.

These grades are molded on the sidewalls of passenger car tires.

While the tires available as standard or optional equipment on General Motors vehicles may vary with respect to these grades, all such tires meet General Motors performance standards and have been approved for use on General Motors vehicles. All passenger type (P Metric) tires must conform to Federal safety requirements in addition to these grades.

Wheel Alignment and Tire Balance

The wheels on your vehicle were aligned and balanced carefully at the factory to give you the longest tire life and best overall performance.

In most cases, you will not need to have your wheels aligned again. However, if you notice unusual tire wear or your vehicle pulling one way or the other, the alignment may need to be reset. If you notice your vehicle vibrating when driving on a smooth road, your wheels may need to be rebalanced.

Wheel Replacement

Replace any wheel that is bent, cracked, or badly rusted or corroded. If wheel nuts keep coming loose, the wheel, wheel bolts, and wheel nuts should be replaced. If the wheel leaks air, replace it (except some aluminum wheels, which can sometimes be repaired). See your Cadillac dealer if any of these conditions exist.

Your dealer will know the kind of wheel you need.

Each new wheel should have the same load carrying capacity, diameter, width, offset, and be mounted the same way as the one it replaces.

If you need to replace any of your wheels, wheel bolts, or wheel nuts, replace them only with new GM original equipment parts. This way, you will be sure to have the right wheel, wheel bolts, and wheel nuts for your Cadillac model.



CAUTION:

Using the wrong replacement wheels, wheel bolts, or wheel nuts on your vehicle can be dangerous. It could affect the braking and handling of your vehicle, make your tires lose air and make you lose control. You could have a collision in which you or others could be injured. Always use the correct wheel, wheel bolts, and wheel nuts for replacement.

NOTICE:

The wrong wheel can also cause problems with bearing life, brake cooling, speedometer/odometer calibration, headlamp aim, bumper height, vehicle ground clearance, and tire or tire chain clearance to the body and chassis.

Used Replacement Wheels



CAUTION:

Putting a used wheel on your vehicle is dangerous. You can't know how it's been used or how many miles it's been driven. It could fail suddenly and cause an accident. If you have to replace a wheel use a new GM original equipment wheel.

Tire Chains

NOTICE:

Use tire chains only where legal and only when you must. Use only SAE Class "S" type chains that are the proper size for your tires. Install them on the front tires and tighten them as tightly as possible with the ends securely fastened. Drive slowly and follow the chain manufacturer's instructions. If you can hear the chains contacting your vehicle, stop and retighten them. If the contact continues, slow down until it stops. Driving too fast or spinning the wheels with chains on will damage your vehicle.

APPEARANCE CARE

Remember, cleaning products can be hazardous. Some are toxic. Others can burst into flame if you strike a match or get them on a hot part of the vehicle. Some are dangerous if you breathe their fumes in a closed space. When you use anything from a container to clean your Cadillac, be sure to follow the manufacturer's warnings and instructions. And always open your doors or windows when you're cleaning the inside.

Never use these to clean your vehicle:

- Gasoline
- Benzene
- Naphtha
- Carbon Tetrachloride
- Acetone
- Paint Thinner
- Turpentine
- Lacquer Thinner
- Nail Polish Remover

They can all be hazardous -- some more than others -- and they can all damage your vehicle, too.

Don't use any of these unless this manual says you can. In many uses, these will damage your vehicle:

- Alcohol
- Laundry Soap
- Bleach
- Reducing Agents

CLEANING THE INSIDE OF YOUR CADILLAC

Use a vacuum cleaner often to get rid of dust and loose dirt. Wipe vinyl or leather with a clean, damp cloth.

Your Cadillac dealer has two GM cleaners, a solvent-type spot lifter and a foam-type powdered cleaner. They will clean normal spots and stains very well. Do not use them on vinyl or leather.

Here are some cleaning tips:

- Always read the instructions on the cleaner label.
- Clean up stains as soon as you can -- before they set.
- Use a clean cloth or sponge, and change to a clean area often. A soft brush may be used if stains are stubborn.
- Use solvent-type cleaners in a well-ventilated area only. If you use them, don't saturate the stained area.
- If a ring forms after spot cleaning, clean the entire area immediately or it will set.

Using Foam-Type Cleaner on Fabric

- Vacuum and brush the area to remove any loose dirt.
- Always clean a whole trim panel or section. Mask surrounding trim along stitch or welt lines.
- Mix Multi-Purpose Powdered Cleaner following the directions on the container label.
- Use suds only and apply with a clean sponge.
- Don't saturate the material.
- Don't rub it roughly.
- As soon as you've cleaned the section, use a sponge to remove the suds.
- Rinse the section with a clean, wet sponge.

- Wipe off what's left with a slightly damp paper towel or cloth.
- Then dry it immediately with a blow dryer or a heat lamp.

NOTICE:

Be careful. A blow dryer may scorch the fabric.

- Wipe with a clean cloth.

Using Solvent-Type Cleaner on Fabric

First, see if you have to use solvent-type cleaner at all. Some spots and stains will clean off better with just water and mild soap.

If you need to use a solvent:

- Gently scrape excess soil from the trim material with a clean, dull knife or scraper. Use very little cleaner, light pressure and clean cloths (preferably cheesecloth). Cleaning should start at the outside of the stain, "feathering" toward the center. Keep changing to a clean section of the cloth.
- When you clean a stain from fabric, immediately dry the area with a blow dryer to help prevent a cleaning ring. (See the previous NOTICE.)

Special Cleaning Problems

Greasy or Oily Stains

Such as grease, oil, butter, margarine, shoe polish, coffee with cream, chewing gum, cosmetic creams, vegetable oils, wax crayon, tar and asphalt.

- Carefully scrape off excess stain.
- Follow the solvent-type instructions described earlier.
- Shoe polish, wax crayon, tar and asphalt will stain if left on a vehicle seat fabric. They should be removed as soon as possible. Be careful, because the cleaner will dissolve them and may cause them to spread.

Non-Greasy Stains

Such as catsup, coffee (black), egg, fruit, fruit juice, milk, soft drinks, wine, vomit, urine and blood.

- Carefully scrape off excess stain, then sponge the soiled area with cool water.
- If a stain remains, follow the foam-type instructions described earlier.
- If an odor lingers after cleaning vomit or urine, treat the area with a water/baking soda solution: 1 teaspoon (5 ml) of baking soda to 1 cup (250 ml) of lukewarm water.
- If needed, clean lightly with solvent-type cleaner.

Combination Stains

Such as candy, ice cream, mayonnaise, chili sauce and unknown stains.

- Carefully scrape off excess stain, then clean with cool water and allow to dry.
- If a stain remains, clean it with solvent-type cleaner.

Cleaning Vinyl

Use warm water and a clean cloth.

- Rub with a clean, damp cloth to remove dirt. You may have to do it more than once.
- Things like tar, asphalt and shoe polish will stain if you don't get them off quickly. Use a clean cloth and a solvent-type vinyl cleaner.

Cleaning Leather

Use a soft cloth with lukewarm water and a mild soap or saddle soap.

- For stubborn stains, use a mild solution of 10% isopropyl alcohol (rubbing alcohol) and 90% water.
- *Never* use oils, varnishes, solvent-based or abrasive cleaners, furniture polish or shoe polish on leather.
- Soiled leather should be cleaned immediately. If dirt is allowed to work into the finish, it can harm the leather.

Cleaning the Top of the Instrument Panel

Use only mild soap and water to clean the top surfaces of the instrument panel. Sprays containing silicones or waxes may cause annoying reflections in the windshield and even make it difficult to see through the windshield under certain conditions.

Cleaning Speaker Covers

Vacuum around a speaker cover gently, so that the speaker won't be damaged. If something gets on one of them, follow the steps earlier under "Using Solvent-Type Cleaner on Fabric." Use as little solvent as you can.

Care of Wood Panels

Use a clean cloth moistened in warm soapy water (use mild dish washing soap). Dry the wood immediately with a clean cloth.

CARE OF SAFETY BELTS

Keep belts clean and dry.



CAUTION:

Do not bleach or dye safety belts. If you do, it may severely weaken them. In a crash they might not be able to provide adequate protection. Clean safety belts only with mild soap and lukewarm water.

GLASS

Glass should be cleaned often. GM Glass Cleaner (GM Part No. 1050427) or a liquid household glass cleaner will remove normal tobacco smoke and dust films.

Don't use abrasive cleaners on glass, because they may cause scratches. Avoid placing decals on the inside rear window, since they may have to be scraped off later. If abrasive cleaners are used on the inside of the rear window, an electric defogger element may be damaged. Any temporary license should not be attached across the defogger grid.

CLEANING THE OUTSIDE OF THE WINDSHIELD AND WIPER BLADES

If the windshield is not clear after using the windshield washer, or if the wiper blade chatters when running, wax or other material may be on the blade or windshield.

Clean the outside of the windshield with GM Windshield Cleaner, Bon-Ami Powder[®] (GM Part No. 1050011). The windshield is clean if beads do not form when you rinse it with water.

Clean the blade by wiping vigorously with a cloth soaked in full strength windshield washer solvent. Then rinse the blade with water.

Wiper blades should be checked on a regular basis and replaced when worn.

WEATHERSTRIPS

Silicone grease on weatherstrips will make them last longer, seal better, and not stick or squeak. Apply silicone grease with a clean cloth at least every six months. During very cold, damp weather more frequent application may be required.

CLEANING THE OUTSIDE OF YOUR CADILLAC

The paint finish on your vehicle provides beauty, depth of color, gloss retention and durability.

Washing Your Vehicle

The best way to preserve your vehicle's finish is to keep it clean by washing it often with lukewarm or cold water.

Don't wash your vehicle in the direct rays of the sun. Don't use strong soaps or chemical detergents. Use liquid hand, dish or car washing (mild detergent) soaps. Don't use cleaning agents that are petroleum based, or that contain acid or abrasives. All cleaning agents should be flushed promptly and not allowed to dry on the surface, or they could stain. Dry the finish with a soft, clean chamois or a 100% cotton towel to avoid surface scratches and water spotting.

High pressure car washes may cause water to enter your vehicle.

Finish Care

Occasional waxing or mild polishing of your Cadillac by hand may be necessary to remove residue from the paint finish. You can get GM approved cleaning products from your dealer. (See "Appearance Care and Materials" in the Index.)

Your Cadillac has a "basecoat/clearcoat" paint finish. The clearcoat gives more depth and gloss to the colored basecoat. Always use waxes and polishes that are non-abrasive and made for a basecoat/clearcoat paint finish.

NOTICE:

Machine compounding or aggressive polishing on a basecoat/clearcoat paint finish may dull the finish or leave swirl marks.

Foreign materials such as calcium chloride and other salts, ice melting agents, road oil and tar, tree sap, bird droppings, chemicals from industrial chimneys, etc. can damage your vehicle's finish if they remain on painted surfaces. Wash the vehicle as soon as possible. If necessary, use non-abrasive cleaners that are marked safe for painted surfaces to remove foreign matter.

Exterior painted surfaces are subject to aging, weather and chemical fallout that can take their toll over a period of years. You can help to keep the paint finish looking new by keeping your Cadillac garaged or covered whenever possible.

ALUMINUM WHEELS

Your aluminum wheels have a protective coating similar to the painted surface of your vehicle. Don't use strong soaps, chemicals, chrome polish, abrasive cleaners or abrasive cleaning brushes on them because you could damage this coating. After rinsing thoroughly, a wax may be applied.

NOTICE:

Don't use an automatic car wash that has hard silicon carbide cleaning brushes. These brushes can take the protective coating off your aluminum wheels.

TIRES

To clean your tires, use a stiff brush with a tire cleaner.

When applying a tire dressing always take care to wipe off any overspray or splash from painted surfaces. Petroleum-based products may damage the paint finish.

SHEET METAL DAMAGE

If your vehicle is damaged and requires sheet metal repair or replacement, make sure the body repair shop applies anti-corrosion material to the parts repaired or replaced to restore corrosion protection.

FINISH DAMAGE

Any stone chips, fractures or deep scratches in the finish should be repaired right away. Bare metal will corrode quickly and may develop into a major repair expense.

Minor chips and scratches can be repaired with touch-up materials available from your dealer or other service outlets. Larger areas of finish damage can be corrected in your dealer's body and paint shop.

UNDERBODY MAINTENANCE

Chemicals used for ice and snow removal and dust control can collect on the underbody. If these are not removed, accelerated corrosion (rust) can occur on the underbody parts such as fuel lines, frame, floor pan, and exhaust system even though they have corrosion protection.

At least every spring, flush these materials from the underbody with plain water. Clean any areas where mud and other debris can collect. Dirt packed in closed areas of the frame should be loosened before being flushed. Your dealer or an underbody car washing system can do this for you.

CHEMICAL PAINT SPOTTING

Some weather and atmospheric conditions can create a chemical fallout. Airborne pollutants can fall upon and attack painted surfaces on your vehicle. This damage can take two forms: blotchy, ringlet-shaped discolorations, and small irregular dark spots etched into the paint surface.

Although no defect in the paint job causes this, Cadillac will repair, at no charge to the owner, the surfaces of new vehicles damaged by this fallout condition within 12 months or 12,000 miles (20 000 km) of purchase, whichever comes first.

APPEARANCE CARE MATERIALS CHART

GM PART NUMBER	SIZE	DESCRIPTION	USAGE
1050172	16 Oz. (0.473 L)	Tar and Road Oil Remover	Removes Old Waxes, Polishes, Tar and Road Oil
1050173	16 Oz. (0.473 L)	Chrome Cleaner and Polish	Removes Rust and Corrosion on Chrome and Stainless Steel
1050174	16 Oz. (0.473 L)	White Sidewall Tire Cleaner	Cleans White and Black Tires
1050214	32 Oz. (0.946 L)	Vinyl/Leather Cleaner	Spot and Stain Removal on Leather or Vinyl
1050427	23 Oz. (0.680 L)	Glass Cleaner	Glass Cleaning and Spot Cleaning on Vinyls
1050429	6 Lbs. (2.72 Kg)	Multi-Purpose Powdered	Cleans Vinyl and Cloth on Door Trim, Seats, and Carpet-Also, Tires and Mats
1052349	12 Oz. (0.354 L)	Lubriplate	Grease for Hood, Trunk and Door Hinges and Latches
1052870	16 Oz. (0.473 L)	Wash-Wax (Conc.)	Exterior Wash
1051398	8 Oz. (0.237 L)	Spot Lifter	Spot and Stain Removal on Cloth and Fabric
1051515	32 Oz. (0.946 L)	GM Optikleem	Windshield Washer Solvent and Anti-Freeze
1050201	16 Oz. (0.473 L)	Magic Mirror Cleaner Polish	Exterior Cleaner and Polish

VEHICLE IDENTIFICATION NUMBER (VIN)

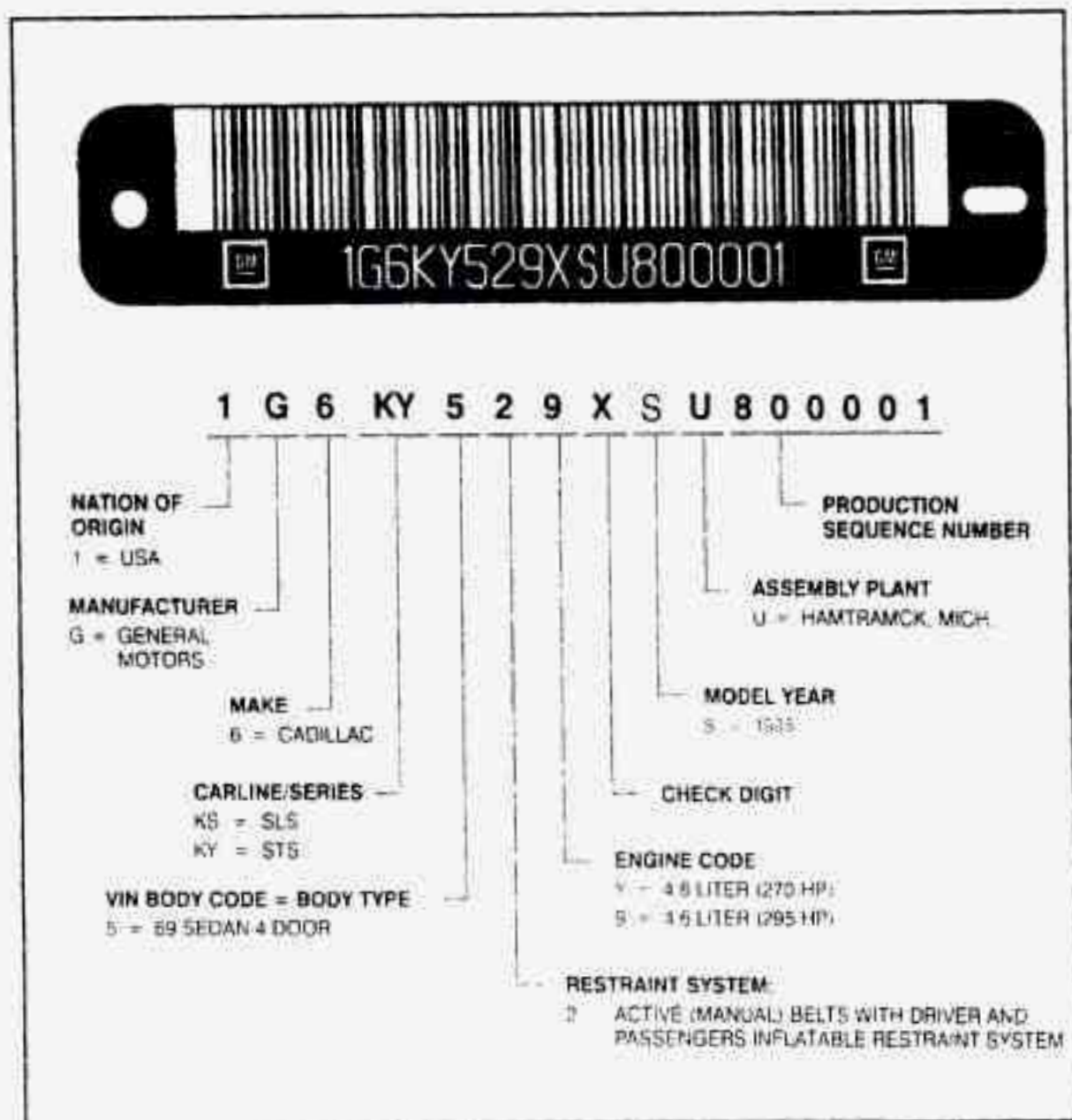

This is the legal identifier for your Cadillac. It appears on a plate in the front corner of the instrument panel, on the driver's side. You can see it if you look through the windshield from outside your vehicle. The VIN also appears on the Vehicle Certification and Service Parts labels and the certificates of title and registration.

Engine Identification

The eighth character in your VIN is the engine code. This code will help you identify your engine, specifications, and replacement parts.

SERVICE PARTS IDENTIFICATION LABEL

You'll find this label on the spare tire cover. It's very helpful if you ever need to order parts. On this label is:

- your VIN,
- the model designation,
- paint information, and
- a list of all production options and special equipment.

Be sure that this label is not removed from the vehicle.

ADD-ON ELECTRICAL EQUIPMENT

NOTICE:

Don't add anything electrical to your Cadillac unless you check with your dealer first. Some electrical equipment can damage your vehicle and the damage wouldn't be covered by your warranty. Some add-on electrical equipment can keep other components from working as they should.

Your vehicle has an air bag system. Before attempting to add anything electrical to your Cadillac, see "Servicing Your Air Bag-Equipped Cadillac" in the Index.

Retained Accessory Power

When you stop your Cadillac and turn the key to OFF, you can use these accessories for 10 more minutes:

- Radio
- Power Windows
- Astrorooftop
- Windshield Wipers
- Fuel Door Release
- Trunk Release

Everything will go off after 10 minutes or if you open a door.

If you want power for another 10 minutes, just turn the key to RUN and then back to OFF.

FUSES AND CIRCUIT BREAKERS

The wiring circuits in your vehicle are protected from short circuits by a combination of Mini Fuses, Circuit Breakers and MAXI[®] fuses. This greatly reduces the chance of fires caused by electrical problems.

If you have a problem on the road and don't have a spare fuse, you can "borrow" one of the same value. Select a feature that you can get along without that is the same value you need -- like the radio or cigarette lighter -- and use its fuse. Be sure to use a fuse with the same amperage rating number on it (ie. 10A, 20A, etc.). Replace it as soon as you can.

There is a fuse removal tool and some spare mini fuses in the glove box door, just lift the cover up.

Engine Compartment Fuse Block



To gain access, lift the cover.

MAXI[®] Fuses/Relay Center

The MAXI[®] fuses and relays are located next to the engine compartment fuse block. If a MAXI[®] fuse should blow, have your vehicle serviced by your Cadillac dealer immediately.

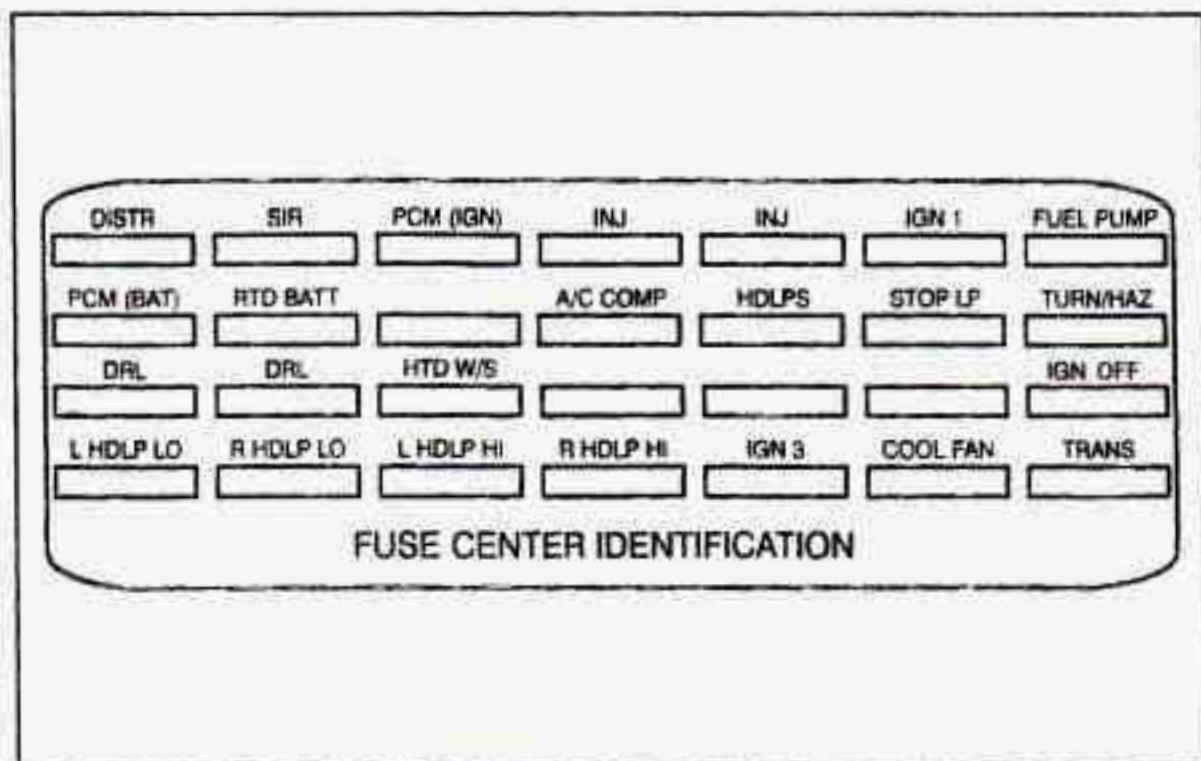

Engine Compartment Fuse Block

FUSE	USAGE
DISTR	Ignition Control Module
SIR	Sensing and Diagnostic Module
PCM (IGN)	Powertrain Control Module (PCM); PASS-Key [®] II Decoder Module
INJ	1, 4, 6 and 7 Fuel Injectors
INJ	2, 3, 5 and 8 Fuel Injectors
IGN 1	A/C Refrigerant Pressure Switch; Transaxle Range Switch; Stop/BTST/Cruise Brake Switch; Instrument Panel Cluster; Keyless Entry Module; Diagnostic/Energy Reserve Module (Derm); Cornering Lamps; Turn/Hazard Switch Assy; Chime Module; Headlamp Switch; Twilight Sentinel/DRL Module
FUEL PUMP	Fuel Pump; Oil Pressure Switch; Powertrain Control Module (PCM)

Engine Compartment Fuse Block (Continued)	
FUSE	USAGE
PCM (BAT)	Powertrain Control Module (PCM)
RTD (BAT)	Road Sensing Suspension (RSS) Module
A/C COMP	A/C Compressor Clutch
HDLPS	Headlamp Dimmer Switch; Headlamp Relay "D" (Engine Comp. Micro Relay Center); DRL Headlamp Relay "E" (with Daytime Running Lamps); Powers C13
STOP LP	Stop/BTSL/Cruise Switch; Stoplamp Switch Capacitor; Anti-Slip Regulation (ASR) 5 Traction Control
TURN/HAZ	Hazard Flasher; Turn Flasher Relay; Turn Flasher Module
DRL	Daytime Running Lamps (Canada)
DRL	Left and Right Lo-Beam Headlamp (Canada)
HTD W/S	Heated Windshield Control Module
IGN OFF	Instrument Panel Cluster
L HDLP LO	Left Lo-Beam Headlamp
R HDLP LO	Right Lo-Beam Headlamp
L HDLP HI	Left Hi-Beam Headlamp
R HDLP HI	Right Hi-Beam Headlamp
IGN 3	Rear Defogger Relay; Electronic Level Control (ELC); Heated Windshield; Heater and A/C Programmer; Cruise Control
COOLING FAN	Extended Travel Brake Switch; Powertrain Control Module (PCM); Cooling Fan Relays 1, 2 and 3; Front and Rear Heated Oxygen Sensor
TRANS/ECS	Power Steering Pressure Switch; Exhaust Gas Recirculation (EGR) Valve; Transaxle Shift Solenoids A & B; Evaporative Emission Control Solenoid; Powertrain Control Module (PCM); Torque Converter Clutch Solenoid; TCC Brake Switch

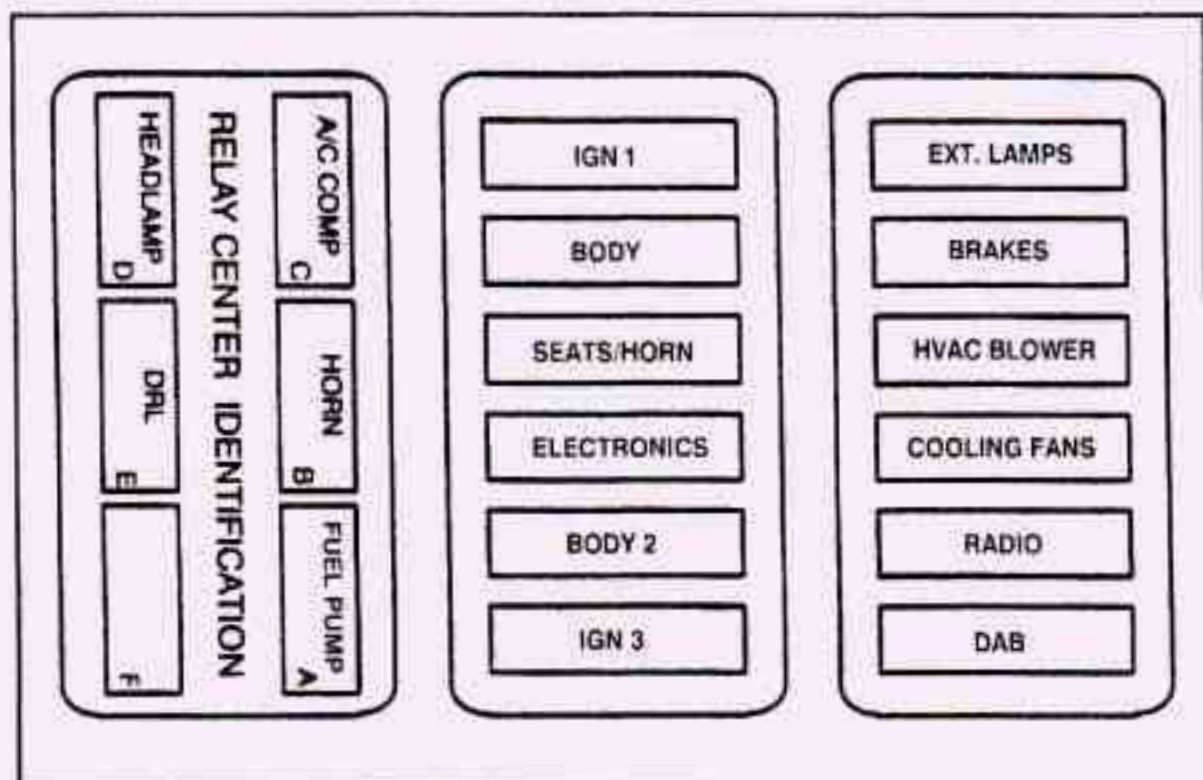

LH MAXI™ FUSE BLOCK

FUSE/CIRCUIT BREAKER (C.B.)	CIRCUITRY
IGN 1 (Fuse)	Retained Accessory Power (Radio Wipers); Starter; Trunk Comp. Fuses B11 and B13
BODY 1 (Fuse)	Engine Comp. B11; Road Sensing Suspension; Fog Lamps; Trunk Comp. Fuses C1, C3, C5, C7, C9 and C11; Trunk Comp. Fuse C13 (Export); Rear Fog Lamp (Export)
SEATS/HORN (C.B.)	Left and Right Power Seat Switches; Left and Right Lumbar Relays; Power Door Locks; Keyless Entry Module; Horns; Fuel Door Release Switch; Trunk Release Switch
ELECTRONICS (Fuse)	Powertrain Control Module (PCM); Electronic Climate Control; RAP/Illuminated Entry Module; Instrument Panel Cluster; PASS-Key®II Decoder Module; Theft Deterrent
BODY 2 (Fuse)	Left and Right Heated Seats; Electronic Level Control (ELC); Trunk Lid Pull-Down; Power Antenna; Rear Defogger; Left and Right Mirror Defoggers
IGN 3 (Fuse)	Retained Accessory Power (Astrorooft/Power Windows); Engine Comp. Fuses D1, D3 and D5; Trunk Comp. Fuses A1, A3, A5, A7 and A9

RH MAXI™ FUSE BLOCK

FUSE/CIRCUIT BREAKER (C.B.)	CIRCUITRY
DAB (C.B.)	Retained Accessory Power (RAP) (AstrorooF Power Windows)
RADIO (Fuse)	DeLco-Bose™ Speakers; Radio Control Head; Remote Radio Receiver
COOLING FANS (Fuse)	Cooling Fans
HVAC BLOWER (Fuse)	HVAC Power Motor; A/C Compressor
BRAKES (Fuse)	Brake Pressure Modulator Valve
EXT LAMPS (Fuse)	Turn Flasher Module; Hazard Flasher; Stop/BTSl/Cruise Brake Switch; Parking Lamps; Daytime Running Lamps (Canada); Engine Comp. Fuses B1, B3 and B5; Trunk Comp. Fuses D11 and D13
IGN 3 (Fuse)	Retained Accessory Power (AstrorooF/Power Windows); Engine Comp. Fuses D1, D3 and D5; Trunk Comp. Fuses A1, A3, A5, A7 and A9

Rear Compartment Fuse Block

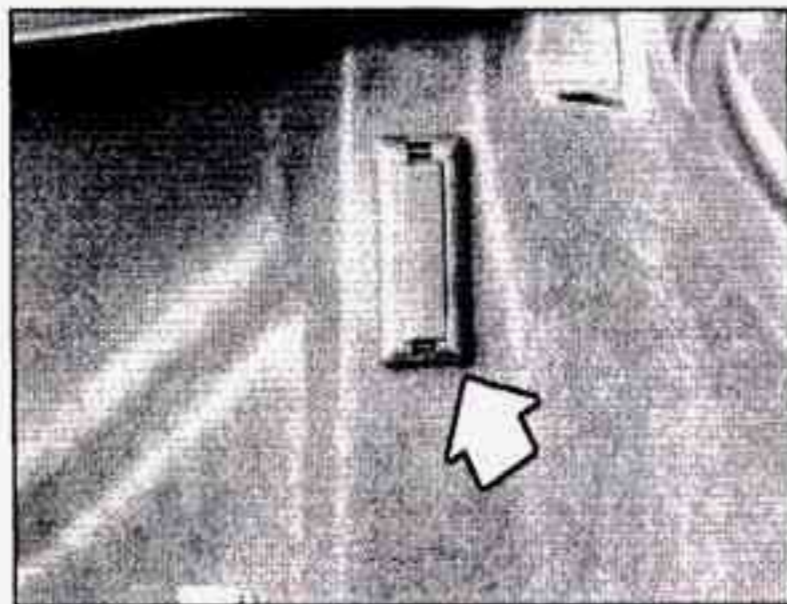

Pull the cover off to gain access.

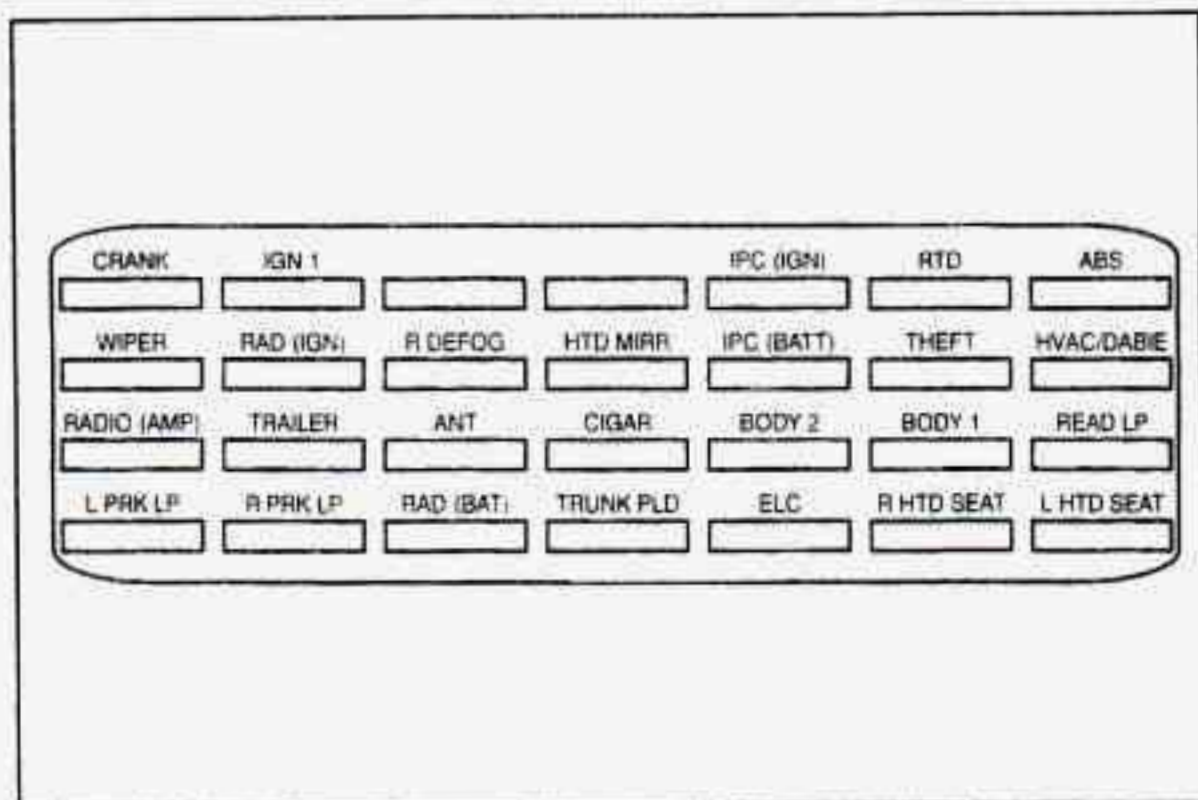

Rear Compartment Fuse Block

FUSE	USAGE
CRANK	RAP/Illuminated Entry Module; Sensing and Diagnostic Module; Transaxle Range Switch (NSSS)
IGN 1	Trunk; Fuel Door Release Inhibit Relay "E"; Fuel Lever Sensor; Electrochromic Mirror; RAP/Illuminated Entry Module; Theft Deterrent Module; Keyless Entry Module; Turn Flasher Relay "F"; Trunk Comp. Micro Relay Center
IPC (IGN)	Instrument Panel Cluster
RTD SUSP	Speed Sensitive Suspension
ABS	Electronic Brake and Traction Control Module (EBTCM)
WIPER	Wiper/Washer Switch
RAD (IGN)	Remote Radio Receiver
R DEFOG	Rear Defogger
HTD MIRR	Left and Right Outside Mirror Defoggers
IPC (BATT)	Instrument Panel Cluster
THEFT	PASS-Key [®] II Decoder Module; Theft Deterrent Relay "D" (Trunk Comp. Relay Center); Theft Deterrent Module

Rear Compartment Fuse Block (Continued)

FUSE	USAGE
HVAC/DABIE	Heater and A/C Programmer; RAP/Illuminated Entry Module
RADIO	Active Audio Amplifier
TRAILER	Not Equipped
ANT	Antenna Motor
CIGAR	Left and Right Cigarette Lighters; Front Cigarette Lighter; Chime Module
BODY 2	Power Mirror Switch; RAP Relay; Lock-Out Inhibit Relay "A" (Trunk Comp. 1 Micro Relay Center); Courtesy Lamps Relay "C" (Trunk Comp. 2 Micro Relay Center); RAP Relay "E" (Trunk Comp. 2 Micro Relay Center); Keyless Entry Module; Trunk Lamp
BODY 1	Front Door Lock Switches; Front Door Courtesy Lamp; Glove Box Lamp; Headlamp Switch
READ LP	Left and Right Front Header Lamp; Garage Door Opener; Left and Right Rear Header Lamps
L PRK LP	Left Rear Tail/Stop/Turn Lamps; Left Front Park/Turn Lamps; Front and Rear Left Sidemarkers Lamps; Right Rear Marker Lamp; Headlamp Switch; Instrument Panel Cluster
R PRK LP	Radio Control Head; Right Tail/Stop/Turn Lamps; Right Front and Rear Sidemarkers Lamps; Right Front Park and Turn Lamps; Engine Comp. Lamp; License Plate Lamps
RAD (BAT)	Radio
TRUNK PLD	Trunk Lid Pull Down Motor
ELC	Electronic Level Control (ELC)
R HTD SEAT	Passenger's Heated Seat
L HTD SEAT	Driver's Heated Seat

Headlamps

The headlamp wiring has an individual fuse which is powered by a MAXI[®] fuse. An electrical overload in the headlamp wiring may cause your headlamps to go off and remain off. You will need to have your Cadillac serviced immediately.

Windshield Wipers

The windshield wiper motor is powered by a MAXI[®] fuse. An electrical overload in the motor wiring may cause your wipers to stop working. If this happens you will need to have your Cadillac serviced.

Power Windows and Other Power Options

Circuit breakers in the fuse panel protect the power windows and other power accessories. When the current load is too heavy (such as a switch being held on with the window completely up), the circuit breaker opens and closes, protecting the circuit until the problem is fixed or the load is removed.

BULB CHART

Description	Bulb No.
Ashtray Illumination	1445
Backup Lamps	2057
Cornering Lamp	3156
Courtesy Reading Lamp	168
Glove Compartment Lamp	194
Headlamps, Composite	
Inner High Beam	9005
Outer Low Beam	9006
License Plate Lamp	194
Park and Turn Signal	3157 NA
Sidemarkers Lamps	194
Stop/Tail/Turn Signal	2057
Trunk Lamp	1003
Underhood Lamp	561
Vanity Mirror Illumination	124

SPECIFICATIONS

4.9 LITER ENGINE

Displacement	4.9L (299 cu. in.)
No. of Cylinders	8 - 90 Degree V
Power (Acc. to SAE J1349)	200 (bhp) @ 4100 rpm 150 (kW) @ 4100 rpm
Torque (Acc. to SAE J1349)	275 (lb. ft.) @ 3000 rpm 373 (N·m) @ 3000 rpm
Bore	92 mm (3.62 in.)
Stroke	92 mm (3.62 in.)
Compression Ratio	9.5:1
Cylinder Block	Die Cast Aluminum with Iron Cylinder Liners
Cylinder Heads	Cast Iron
Intake Manifold	Cast Aluminum
Valve System	Roller Hydraulic Lifters
Intake Valve	45mm (1.772 in.)
Exhaust Valve	38mm (1.496 in.)
Pistons	Cast Aluminum
Firing Order	1-8-4-3-6-5-7-2
Left Bank	1-3-5-7
Right Bank	2-4-6-8
Camshaft	Steel
Camshaft Drive	Chain
Camshaft material	Pearlitic Nodular Iron
Main Bearings	Five

ENGINE LUBRICATION SYSTEM

Type of Intake	Stationary
Filter System	Full-Flow
Oil Pump	Geroto

ENGINE COOLING SYSTEM

Radiator Cap Relief Pressure	15.0 psi (103 kPa)
Thermostat Starts To Open	192-199° F (89-93° C)
Water Pump Type	Centrifugal
Drive Belt	Serpentine
Radiator Core	Aluminum
Radiator Cooling Fans (2)	Electric

FUEL SYSTEM

Induction Type	Sequential Port Fuel Injection (SPFI)
System Pressure	33.4-43.5 psi (230-300 kPa)
Idle Speed	PCM Controlled
Filter Type	Paper Type Element
Fuel Pump	Electric (In Tank)
Fuel Required	Premium Unleaded (91 Octane or Higher)

AUTOMATIC TRANSAXLE

Trade Name	Hydra-Matic 4T60E
Type	4-Speed Automatic Viscous Converter Clutch
Fluid Required	DEXRON [®] -III
Axle Ratio	2.73:1

EMISSION CONTROL SYSTEMS

Exhaust Gas Recirculation	Controlled Flow
Catalytic Converter	Ceramic Monolith
Evaporative Emission Control	Charcoal Canister
Crankcase Emission Control	PCV Valve
Electronic System	Open and Closed Loop

EXHAUST SYSTEM

Type	Single with Crossover Pipe
Muffler	One-Reverse Flow
Resonator	None
Exhaust Pipe	Stainless Steel
Intermediate Pipe	Stainless Steel
Tail Pipe	Stainless Steel

ELECTRICAL SYSTEM

Voltage	12
Ground	Negative
Alternator	140 Amp

AIR CONDITIONING SYSTEM

Refrigerant-R134a	2.0 lbs. (.91 kg)
-------------------------	-------------------

FLUID CAPACITIES

Transaxle (4T60E)	20 pts. (9.5 L)
Engine Oil	5.0 qts. (4.73 L)
With Filter Change	5.5 qts. (5.2 L)
Engine Cooling System	10.68 qts. (10.11 L)
Fuel Tank	20 gal. (75.76 L)
Power Steering	1.3 qts (1.2 L)
Windshield Washer Reservoir	4.2 qts (4.1 L)

TIGHTEN TORQUE

Spark Plugs	20 N·m (15 lb. ft.)
Oil Pan Drain Plug	30 N·m (22 lb. ft.)

VEHICLE DIMENSIONS

Shipping Weight	3757.7 lbs. (1704.5 kg)
Wheel Base	113.8 in. (2890.5 mm)
Length	209.7 in. (5326 mm)
Height	56.3 in. (1431 mm)
Width	76.6 in. (1946 mm)
Front Track	60.9 in. (1546 mm)
Rear Track	60.9 in. (1546 mm)

AIR CONDITIONING REFRIGERANTS

Not all air conditioning refrigerants are the same. If the air conditioning system in your vehicle needs refrigerant, be sure the proper refrigerant is used. If you're not sure, ask your Cadillac dealer. For additional information, see your "Warranty and Owner Assistance Information" booklet.

NORMAL MAINTENANCE REPLACEMENT PARTS

Air Cleaner Element	AC Type A1096C 25096932
Battery	78A-72
Fuel Filter Element	AC Type GF-624 25121801
Engine Oil Filter	AC Type PF-58 25014377
PCV Valve	AC Type CV-774C 06487779
Spark Plugs	AC Type 41-902 5614236
Serpentine Drive Belt	3538853
Surge Tank Cap	AC Type RC 33 6410665
Thermostat	3528974
Upper Radiator Hose	3521235
Lower Radiator Hose	3521237
Transaxle Filter	8651909
Transaxle Pan Gasket	8676250

NOTES

NOTES



We employ technicians certified by the
National Institute for

**AUTOMOTIVE
SERVICE
EXCELLENCE**

Let us show you their credentials.



Part Number 3547065 B

1956 SEDAN DE VILLE

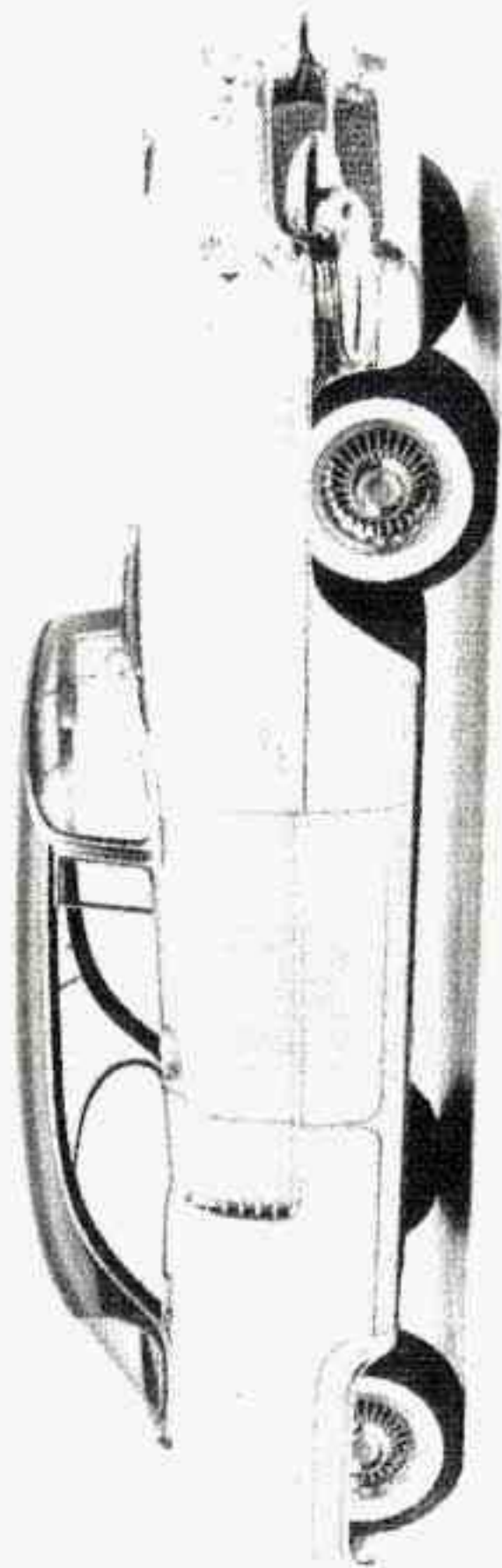

ROADSIDE SERVICE

ROADSIDE SERVICE

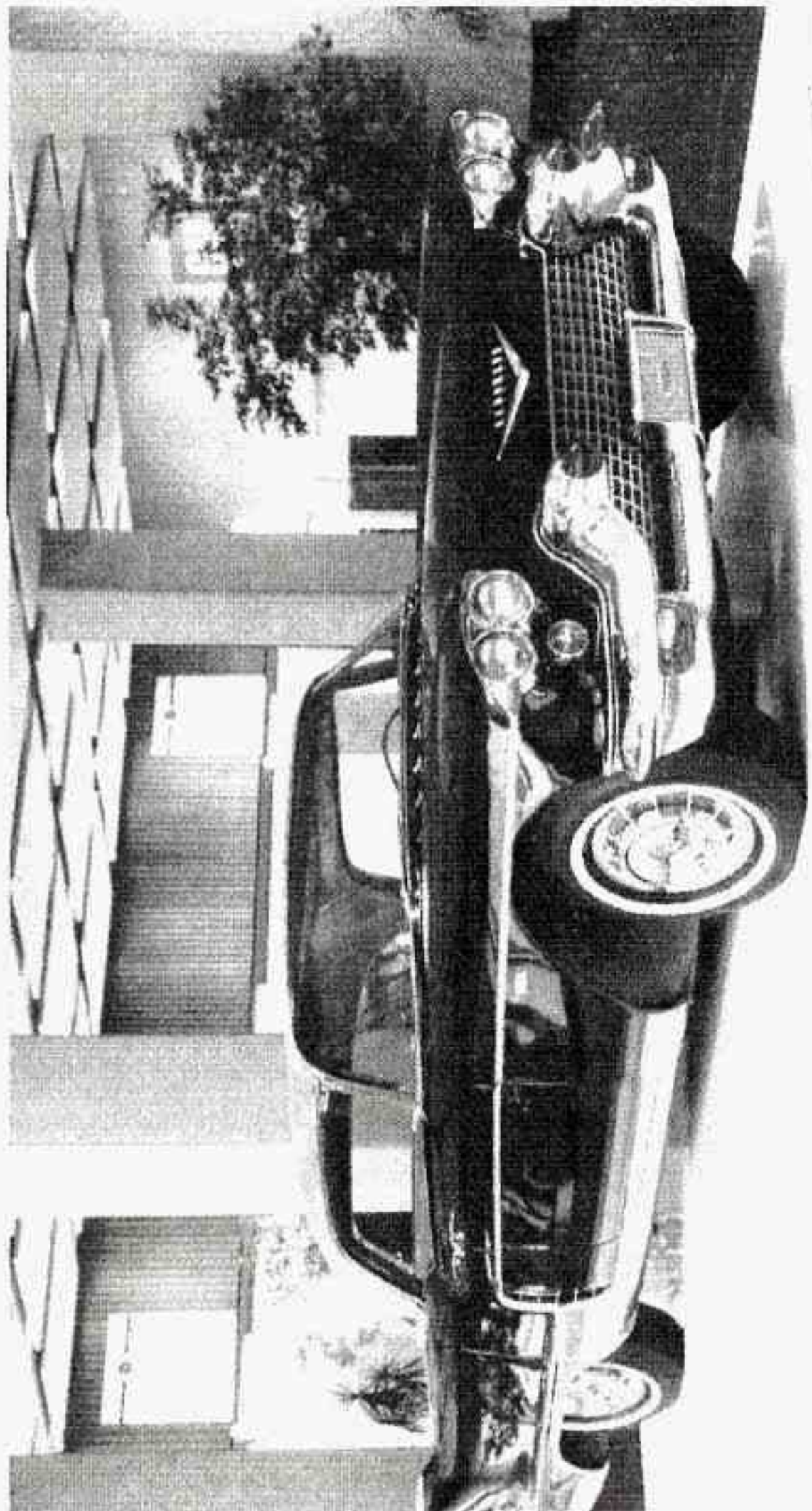

1957 FORDADO BROUGHTHAM



TOLL-FREE HOTLINE
1-800-882-1112

Roadside Service represents the spirit of luxury leadership at Cadillac Motor Car Division. We hope the need never arises, but if it does, Roadside Service is there for you!! Roadside Service covers you on the road, far from home, all day and night, weekends and holidays. **THERE ARE NO MEMBERSHIP OR ENROLLMENT CHARGES.** Any Cadillac is eligible under this program.

- ROADSIDE SERVICE AVAILABILITY -

TYPE OF ASSISTANCE	DAILY INCLUDING HOLIDAYS
Phone Advisor	24 Hours
Dealer Technician	8 a.m. - 12 midnight
Towing Battery Jump Start Lockout Assistance Fuel Delivery Tire Change	24 Hours

Cadillac Roadside Service is just one of your Cadillac Owner PrivilegesSM that leads to peace of mind.

- Cadillac Owner Privilegessm -

Roadside Service provides several Cadillac Owner Privilegessm at "no charge", throughout your 1995 Cadillac Warranty Period - 48 Months, or 50,000 Miles/80,000 Kilometers.

- **EMERGENCY ROAD SERVICE** - is performed on site for the following situations:
 - **TOWING SERVICE**
 - **BATTERY JUMP START**
 - **LOCK OUT ASSISTANCE**
 - **FUEL DELIVERY**
 - **FLAT TIRE CHANGE (* Covers change only)**
 - * Tire replacement/warranty coverage must be determined by a Cadillac dealer or appropriate tire manufacturer.



- Cadillac Owner Privilegessm -

- **TRIP INTERRUPTION** – If your trip is interrupted due to a warranty failure, incidental expenses may be reimbursed during the 48 months or 50,000 miles/80,000 kilometers warranty period. Items covered are hotel, meals and rental car.
- **TRIP ROUTING** – Free trip routing assistance is available during the 48 months or 50,000 miles/80,000 kilometers warranty period. Within a week of contacting Roadside Service with your travel plans, Cadillac will provide a detailed trip routing. Along with your first trip routing, you will receive a Rand McNally North American Road Atlas.

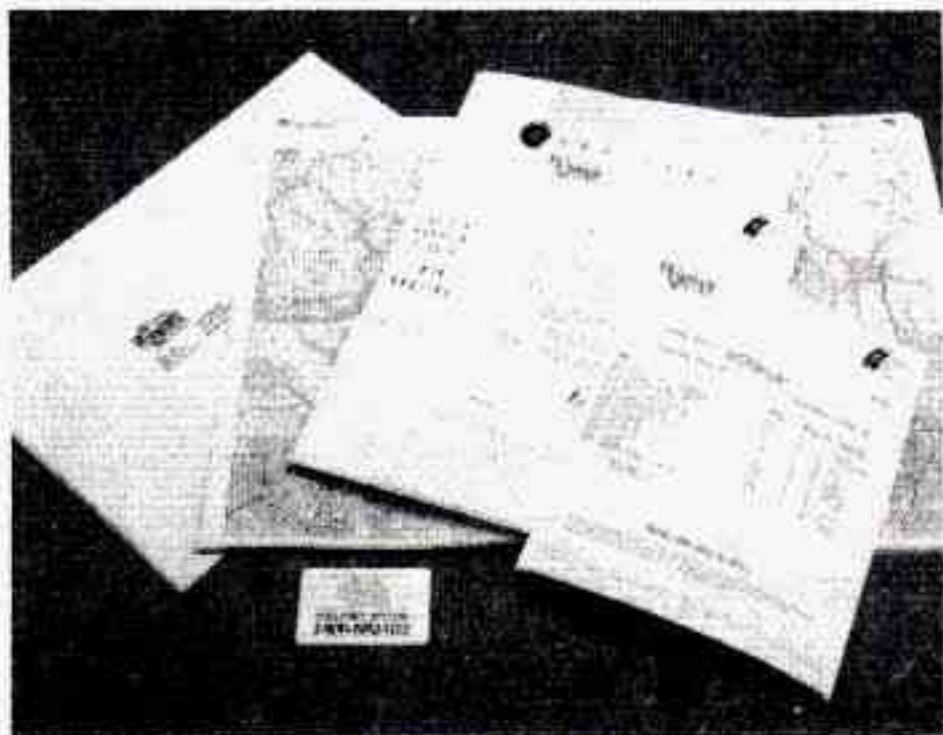

What Will Roadside Service Cost You ? ? ?

There is no cost to call the toll-free Roadside Service number. Many times Roadside Advisors can assist you over the phone.

There is no cost for Roadside Service if the repair is under warranty or the provided service is one of the covered Emergency Road Services.

If a dealership Service Technician travels to your location, and the repair is not covered under warranty, there is a nominal service fee to cover the technician's travel to and from your location. Labor is charged at one and one half times the Cadillac dealership retail labor rate, with a 30 minute minimum. There is also a charge for any parts used and a mileage fee if the technician travels beyond 30 miles.

How Do You Pay For Roadside Service ? ? ?

Payment is due at the time services are performed if it is determined they are non-warranty related. Payment may be made by cash, personal check or any major credit card honored by the participating Cadillac dealership, tow service or locksmith.

In some instances where warranty determination cannot be made, the charges must still be paid. Retain the bill and submit it to an authorized Cadillac dealership Service Department for review. If the repair is determined to be covered by warranty the dealer will expedite reimbursement directly to you.

Where Is Roadside Service Available ? ? ?

Wherever you drive in the United States or Canada, an advisor is available to assist you over the phone. If needed, a dealer technician will travel to your location within a 30 miles/50 kilometers radius, of a participating Cadillac dealership. If beyond this radius, we will arrange to have your car towed to the nearest Cadillac dealership.

How Do You Reach Roadside Service ? ? ?

Dial the toll-free Roadside Service number: 1-800-882-1112. An experienced Roadside Service Advisor will assist you and request the following information:

- *A description of the problem*
- *Name, home address, home telephone number*
- *Location of your Cadillac, and number you are calling from*
- *The model year, vehicle identification number, and date of delivery*



Who Will Repair Your Cadillac At Roadside ???

In many cases, the advisor at the Roadside Service Center can provide instructions to get you back on the road.

To resolve more complex problems, the advisor will page an experienced Cadillac dealership Service Technician. The technician will call you and evaluate the possible cause. If a roadside repair is possible, the technician will come to your location and provide a permanent or temporary repair.

What If Your Cadillac Is In An Unsafe Location Or On A Limited Access Highway ???

If your car is located in an area that is determined to be unsafe (by you, the advisor or the technician) or if the vehicle is on a limited access freeway or regulated highway, the advisor will arrange to tow your Cadillac to a safe location, where service can be performed. Additional assistance will be provided if necessary.

What If Your Cadillac Cannot Be Repaired At Roadside ???

If your car cannot be repaired at roadside within a reasonable period of time (approximately 45 minutes) or requires the resources of a Cadillac dealership service facility, the advisor will arrange a tow service for you. Towing may also be necessary after the technician has attempted a repair, but determines that your car cannot be repaired at roadside.

Tow services are provided by independent companies, so therefore, Cadillac is not responsible for the tow company. During the 48 months, or 50,000 miles/80,000 kilometers warranty period, towing services are covered for any disablement.

What If You Have Difficulty Hearing Or Speaking And Need Roadside Service ???

Roadside Service is prepared to assist owners who have hearing difficulties or are speech impaired. Cadillac has installed special Telecommunication Devices for the Deaf (TDD) in the Roadside Service Center.

Any customer who has access to a TDD or a conventional teletypewriter can communicate with Cadillac by dialing from the United States or Canada: 1-800-TDD-CMCC or 1-800-833-2622 - daily, 24 hours.

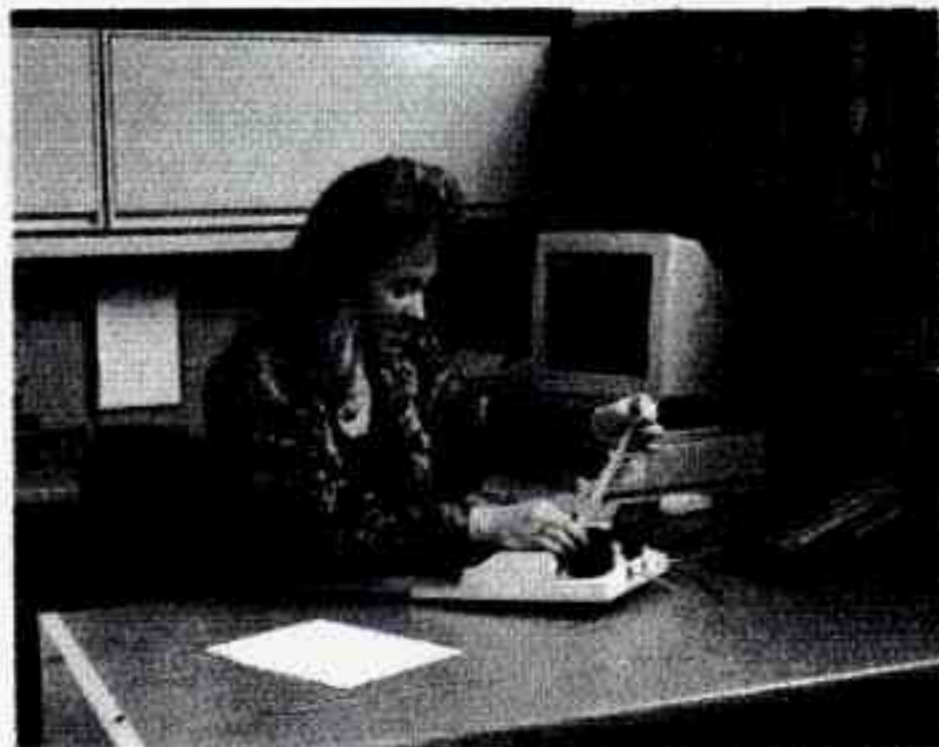

What If You Do Not Speak English Fluently ???

Cadillac offers a multi-lingual approach in assisting you. Roadside Advisors are conversant in a number of languages and utilize the AT&T Language Line Interpreter available 24-hours a day. Just another way Cadillac says "we care".



*Our Cadillac Dealer Technician network is ready
and able to assist Cadillac customers at roadside.*



TOLL-FREE HOTLINE
1-800-882-1112

1959 DE VILLE CONVERTIBLE



COURTESY TRANSPORTATION

COURTSEY TRANSPORTATION

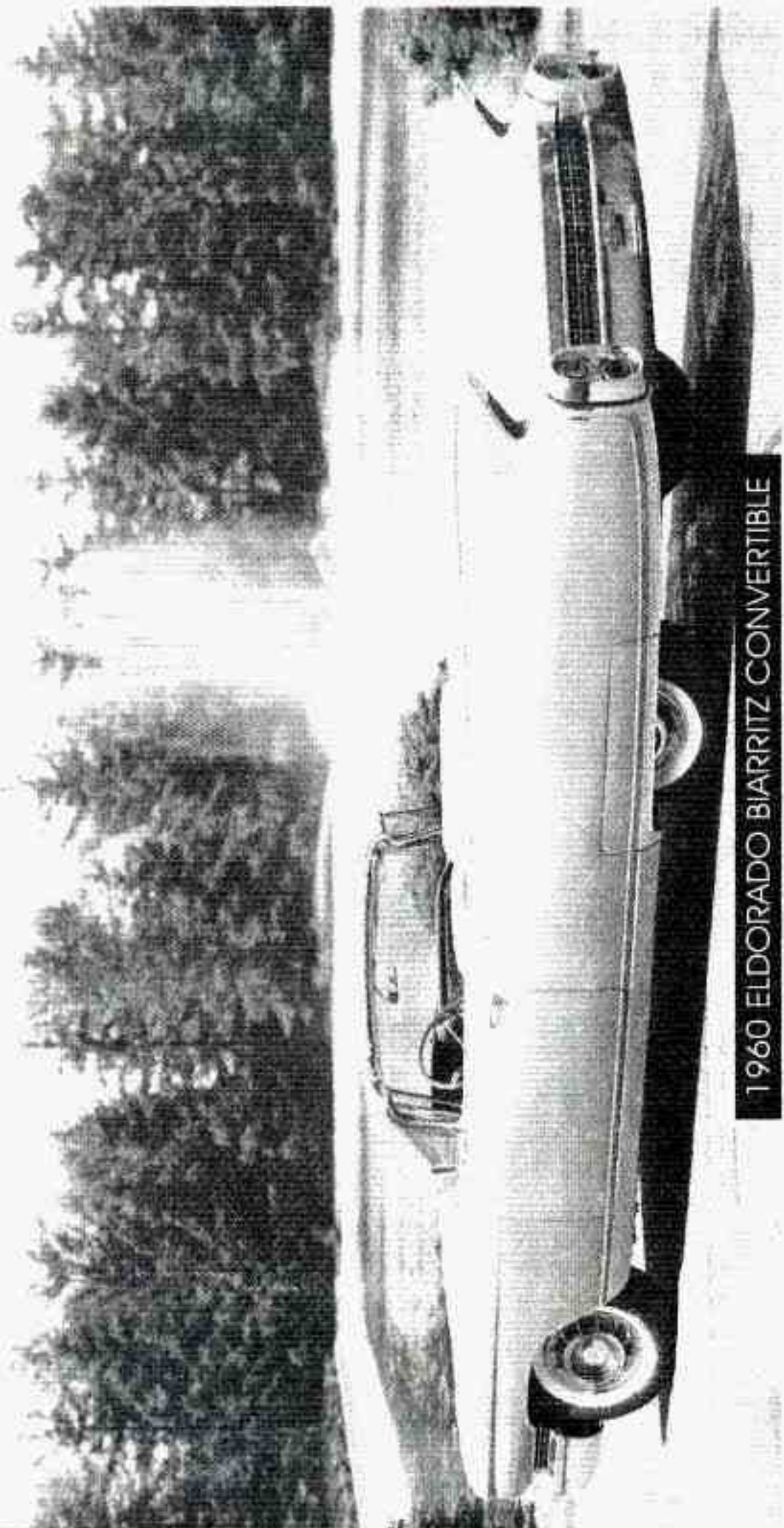

1960 ELDORADO BIARRITZ CONVERTIBLE



Gold Key Courtesy Transportation

One of your Cadillac Owner Privileges is Gold Key Courtesy Transportation. It's one more example of Cadillac's commitment to provide the services you expect and deserve as a Cadillac owner.

Gold Key Courtesy Transportation helps you get where you need to be when your Cadillac is in the dealership for warranty service.[®]

[®]Please ask about the specific Gold Key Courtesy Transportation benefits offered by your Cadillac Dealer.



Courtesy Vehicle

Gold Key Courtesy Transportation provides you with a Cadillac if your car requires warranty repairs.

Your dealer will provide you with a courtesy vehicle if one is available.

Shuttle Service

Warranty work can frequently be handled in one day, but there is no reason for you to wait around. Cadillac helps eliminate inconvenience to you with transportation alternatives.

Gold Key Courtesy Transportation provides shuttle service for same day warranty work. Your Cadillac Dealer can get you where you need to be with minimal interruption of your daily schedule.





Plan Ahead When Possible

Whenever possible, schedule an appointment for your vehicle's warranty work. Your Cadillac Dealer can then prepare to meet your alternative transportation needs and minimize inconveniences typically associated with warranty repairs.

Owner Responsibilities

There are only two things which you will be responsible for during the use of your courtesy vehicle. You are required to provide insurance coverage and replenish the fuel used.

In many cases your own auto insurance policy may provide primary coverage for the courtesy vehicle, similar to rental car agreements. Please, check with your insurance company to be certain what's covered.



Gold Key Courtesy Transportation -- Just one more way your Cadillac Dealer is committed to you.

1963 FLEETWOOD 60 SPECIAL

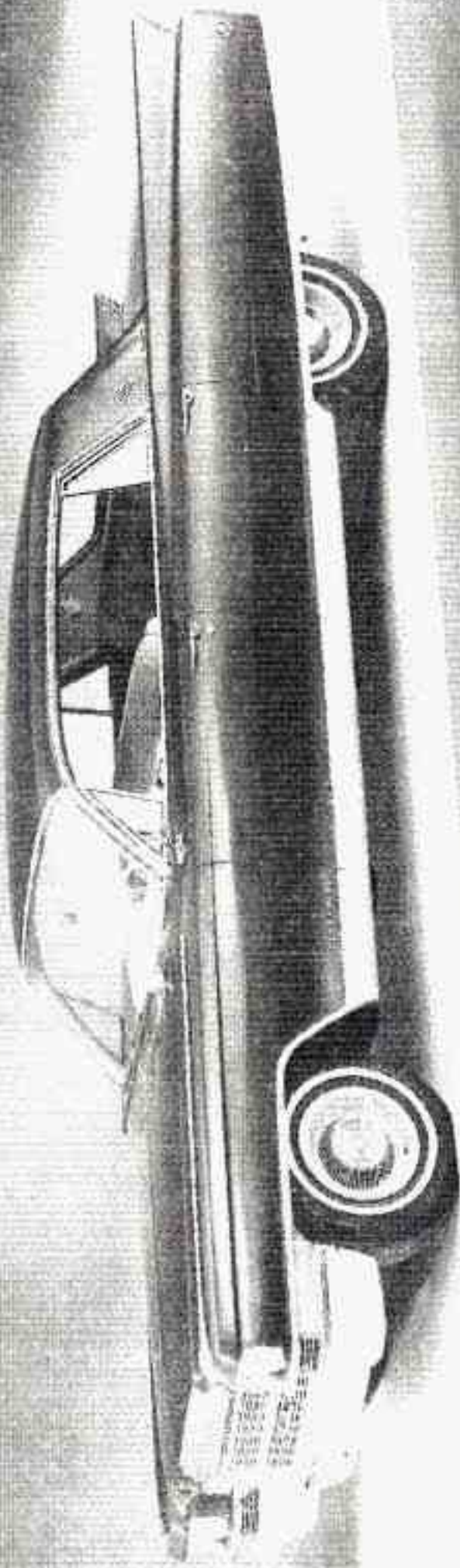

OWNER ASSISTANCE

OWNER ASSISTANCE

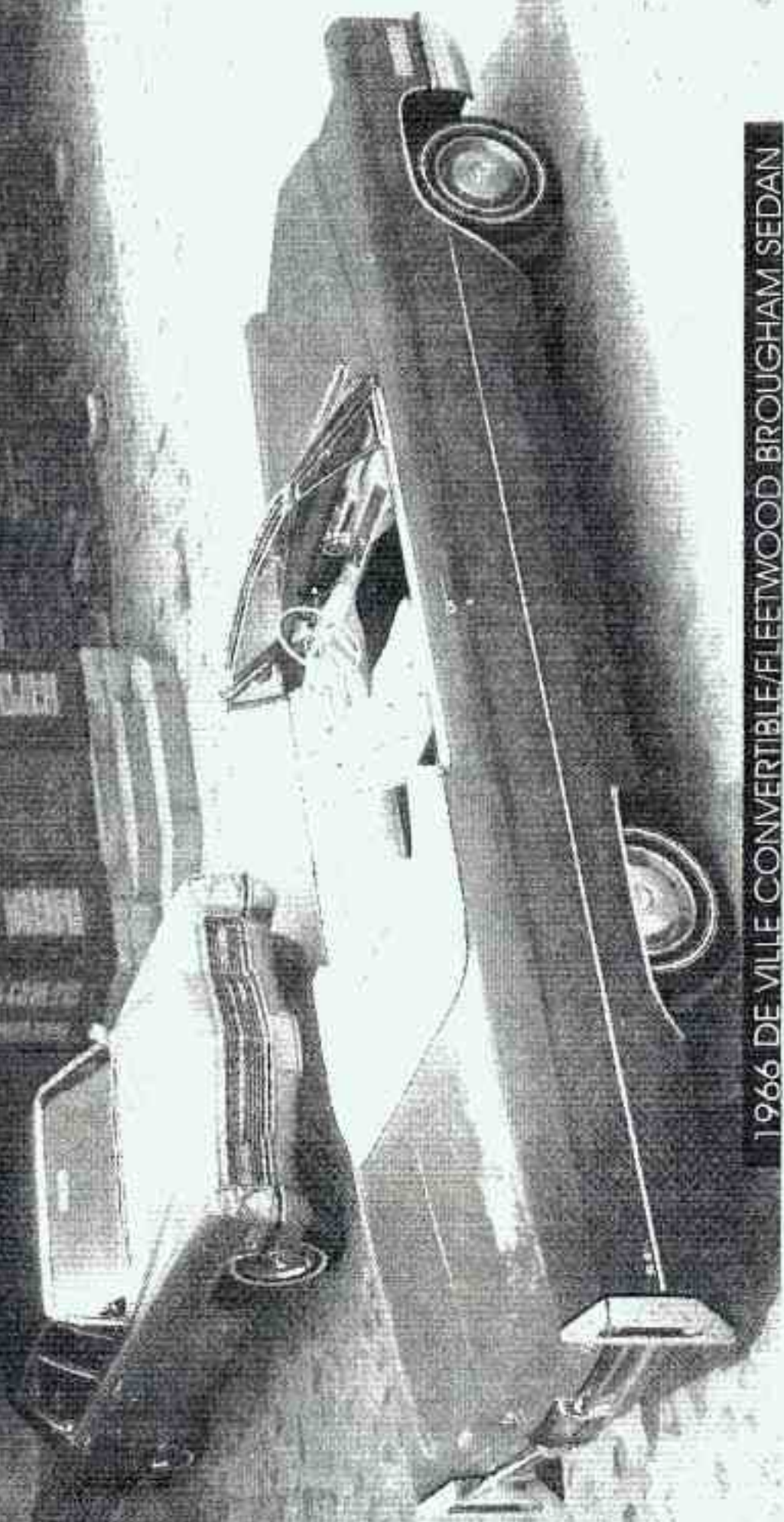

1966 DE VILLE CONVERTIBLE/FLEETWOOD BROUGHAM SEDAN



OWNER ASSISTANCE

CUSTOMER ASSISTANCE INFORMATION

Here you will find out how to contact Cadillac if you need assistance. This section also tells you how to obtain service publications and how to report any safety defects.

This section includes information on: The Customer Satisfaction Procedure, Customer Assistance for Hearing or Speech Impaired, BBB Auto Line - Alternative Dispute Resolution Program, Reporting Safety Defects, Roadside Assistance, and Service and Owner Publications.

CUSTOMER SATISFACTION PROCEDURE

Your satisfaction and goodwill are important to your dealer and Cadillac. Normally, any concern with the sales transaction or the operation of your vehicle will be resolved by your dealer's Sales or Service Departments. Sometimes, however, despite the best intentions of all concerned, misunderstandings can occur. If your concern has not been resolved to your satisfaction, the following steps should be taken:

STEP ONE -- Discuss your concern with a member of dealer management. Normally, concerns can be quickly resolved at that level. If the matter has already been reviewed with the Sales, Service, or Parts Manager, contact the owner of the dealer or the General Manager.

STEP TWO -- If after contacting a member of dealer management, it appears your concern cannot be resolved by the dealer without further help, contact the Cadillac Consumer Relations Center 24 hours a day by calling 1-800-458-8006. In Canada, contact GM of Canada Customer Assistance Center in Oshawa by calling 1-800-263-3777 (English) or 1-800-263-7854 (French).

In Mexico, call (525) 254-3777. In Puerto Rico, call 1-800-496-9992 (English) or 1-800-496-9993 (Spanish). In the U.S. Virgin Islands, call 1-800-496-9994. In other overseas locations, contact GM North American Export Sales in Canada by calling 1-905-644-4112.

For prompt assistance, please have the following information available to give the Customer Assistance Representative:

- Your name, address, home and business telephone numbers
- Vehicle Identification Number (This is available from the vehicle registration or title, or the plate at the left top of the instrument panel and visible through the windshield.)
- Dealer name and location
- Vehicle delivery date and present mileage
- Nature of concern

We encourage you to call the toll-free number listed previously in order to give your inquiry prompt attention. However, if you wish to write Cadillac, write to:

Cadillac Consumer Relations Center
Cadillac Motor Car Division
30009 Van Dyke
P.O. Box 9025
Warren, MI 48090-9025

Refer to your Warranty and Owner Assistance Information booklet for addresses of Canadian and GM Overseas offices.

When contacting Cadillac, please remember that your concern will likely be resolved in the dealership, using the dealer's facilities, equipment and personnel. That is why we suggest you follow Step One first if you have a concern.

CUSTOMER ASSISTANCE FOR THE HEARING OR SPEECH IMPAIRED (TDD)

To assist customers who have hearing difficulties, Cadillac has installed special TDD (Telecommunication Devices for the Deaf) equipment at its Customer Assistance Center. Any hearing or speech impaired customer who has access to a TDD or a conventional teletypewriter (TTY) can communicate with Cadillac by dialing: 1-800-TDD-CMCC. (TDD users in Canada can dial 1-800-263-3830.)

GM PARTICIPATION IN BBB AUTO LINE - ALTERNATIVE DISPUTE RESOLUTION PROGRAM*

*This program may not be available in all states, depending on state law. Canadian owners refer to your Warranty and Owner Assistance Information booklet. General Motors reserves the right to change eligibility limitations and/or to discontinue its participation in this program.

Both Cadillac and your Cadillac dealer are committed to making sure you are completely satisfied with your new vehicle. Our experience has shown that, if a situation arises where you feel your concern has not been adequately addressed, the Customer Satisfaction Procedure described earlier in this section is very successful.

There may be instances where an impartial third-party can assist in arriving at a solution to a disagreement regarding vehicle repairs or interpretation of the New Vehicle Limited Warranty. To assist in resolving these disagreements, Cadillac voluntarily participates in BBB AUTO LINE.

BBB AUTO LINE is an out-of-court program administered by the Better Business Bureau system to settle disputes between customers and automobile manufacturers. This program is available free of charge to customers who currently own or lease a GM vehicle.

If you are not satisfied after following the Customer Satisfaction Procedure, you may contact the BBB using the toll-free telephone number, or write them at the following address:

BBB AUTO LINE
Council of Better Business Bureaus
4200 Wilson Boulevard
Suite 800
Arlington, VA 22203
Telephone: 1-800-955-5100

To file a claim, you will be asked to provide your name and address, your Vehicle Identification Number (VIN), and a statement of the nature of your complaint. Eligibility is limited by vehicle age and mileage, and other factors.

We prefer you utilize the Customer Satisfaction Procedure before you resort to AUTO LINE, but you may contact the BBB at any time. The BBB will attempt to resolve the complaint serving as an intermediary between you and Cadillac. If this mediation is unsuccessful, an informal hearing will be scheduled where eligible customers may present their case to an impartial third-party arbitrator.

The arbitrator will make a decision which you may accept or reject. If you accept the decision, GM will be bound by that decision. The entire dispute resolution procedure should ordinarily take about forty days from the time you file a claim until a decision is made.

Some state laws may require you to use this program before filing a claim with a state-run arbitration program or in the courts. For further information, contact the BBB at 1-800-955-5100 or the Cadillac Customer Assistance Center at 1-800-458-8006.

REPORTING SAFETY DEFECTS TO THE UNITED STATES GOVERNMENT

If you believe that your vehicle has a defect which could cause a crash or could cause injury or death, you should immediately inform the National Highway Traffic Safety Administration (NHTSA), in addition to notifying General Motors.

If NHTSA receives similar complaints, it may open an investigation, and if it finds that a safety defect exists in a group of vehicles, it may order a recall and remedy campaign. However, NHTSA cannot become involved in individual problems between you, your dealer, or General Motors.

To contact NHTSA, you may either call the Auto Safety Hotline toll-free at 1-800-424-9393 (or 366-0123 in the Washington, D.C. area) or write to:

NHTSA, U.S. Department of Transportation
Washington, D.C. 20590

You can also obtain other information about motor vehicle safety from the Hotline.

REPORTING SAFETY DEFECTS TO THE CANADIAN GOVERNMENT

If you live in Canada, and you believe that your vehicle has a safety defect, you should immediately notify Transport Canada, in addition to notifying General Motors of Canada Limited. You may write to:

Transport Canada
Box 8880
Ottawa, Ontario K1G 3J2

REPORTING SAFETY DEFECTS TO GENERAL MOTORS

In addition to notifying NHTSA (or Transport Canada) in a situation like this, we certainly hope you'll notify us. Please call us at our Consumer Relations Center, 1-800-458-8006, or write:

Cadillac Consumer Relations Center
Cadillac Motor Car Division
30009 Van Dyke
P.O. Box 9025
Warren, MI 48090-9025

In Canada, please call us at 1-800-263-3777 (English) or 1-800-263-7854 (French). Or, write:

General Motors of Canada Limited
Customer Assistance Center
1908 Colonel Sam Drive
Oshawa, Ontario L1H 8P7

SERVICE AND OWNER PUBLICATIONS

Service manuals, service bulletins, owner's manuals and other service literature are available for purchase for all current and many past model General Motors vehicles.

Toll-free telephone numbers for ordering information:

United States 1-800-551-4123
Canada 1-800-668-5539

SERVICE MANUALS

Service manuals contain diagnosis and repair information for all chassis and body systems. They may be useful for owners who wish to get a greater understanding of their vehicle. They are also useful for owners with the appropriate skill level or training who wish to perform “do-it-yourself” service. These are authentic General Motors service manuals meant for professional, qualified technicians.

SERVICE BULLETINS

Service bulletins covering various subjects are regularly sent to all General Motors dealerships. GM monitors product performance in the field. When service methods are found which promote better service on GM vehicles, bulletins are created to help the technician perform better service. Service bulletins may involve any number of vehicles. Some will describe inexpensive service; others will describe expensive service. Some will advise new or unexpected conditions, and others may help avoid future costly repairs. Service Bulletins are meant for qualified technicians. In some cases they refer to service manuals, specialized tools, equipment and safety procedures necessary to service the vehicle. Since these bulletins are issued throughout the model year and beyond, an index is required and published quarterly to help identify specific bulletins. Subscriptions are available. You can order an index at the toll-free numbers listed previously, or ask a GM dealer to see an index or individual bulletin.

OWNER PUBLICATIONS

Owner's manuals, warranty folders and various owner assistance booklets provide owners with general operation and maintenance information.

SERVICE MANUALS

MODEL YEAR	FORM NO.	DESCRIPTION	PRICE EACH
1995	GMP/95EK	Deville/Concours/Eldorado/Seville Service Information Manual (Includes Book 1 & 2) (Available 5/95)	\$90.00
1995	GMP/95D	Fleetwood Service Information Manual (Includes Book 1 & 2) (Available 4/95)	90.00
1995 and Prior	CPCH-095	Order Form for Past Model Service Manuals	FREE

OWNER'S LITERATURE

MODEL YEAR	FORM NO.	DESCRIPTION	PRICE EACH
1995	3547054	Fleetwood Owner Information	\$15.00
1995	3547065	Deville Owner Information	15.00
1995	3547068	Concours Owner Information	15.00
1995	3547060	Seville Owner Information	15.00
1995	3547057	Eldorado Owner Information	15.00
1995	3547081	Maintenance Coupon Booklet	4.00
1995	3547051	Warranty Booklet (All Models)	2.00
1995 and Prior	CPCH-095	Order Form for Past Model Owner's Literature	FREE

NOTE: Owner Literature Portfolios, Vehicle and Owner Information Labels and Gold Keys are available by contacting your Cadillac dealership.

SERVICE BULLETIN INFORMATION			
MODEL YEAR	FORM NO.	DESCRIPTION	PRICE EACH
1994	GMSB-ORD-94	Pricing and ordering information for GM Service Bulletin Subscriptions	FREE
1991	H-2855	Service Bulletin Index: A listing of all Service Bulletins released by Cadillac during the model year listed. For 1994, the index contains a listing of all Service Bulletins released by General Motors.	\$4.00
1992	H-2955		4.00
1993	H-30055		4.00
1994	GM-SBI-94		4.00
1991	H-2852B	Bound PSP Edition – includes Index plus complete PSPs	20.00
1992	H-2952B	Bound PSP Edition – includes Index plus complete PSPs	20.00
1993	H-3052B	Bound PSP Edition – includes Index plus complete PSPs	20.00

SERVICE BULLETIN SUBSCRIPTION INFORMATION			
MODEL YEAR	FORM NO.	DESCRIPTION	PRICE EACH
1994	94-CAD-SB	Four quarterly mailings containing all Service Bulletins produced by Cadillac. Also, includes a copy of the Bulletin Index	\$75.00
1994	94-CAD-SB()	First, Second, Third and Fourth Quarter packages can be purchased for Cadillac (use appropriate Item/Model #). Indicate Quarter # in (). Also, includes a copy of the Bulletin Index.	25.00
	GM-BB	GM Corporate Bulletin Binder for Product Service Publications. Includes a set of Index Tabs.	20.00

NOTE: Please fill in order form and MAIL TO:

Cadillac Service Publications

Post Office Box 07130, Detroit, Michigan 48207

ORDER TOLL FREE: 1-800-782-4356

Monday-Friday 8:00 A.M.-6:00 P.M. EST

If further information is needed, write to the address shown above or call 1-800-782-4356. Orders cannot be returned without prior authorization. A re-stocking fee may apply.

1 9 9 5 C P C O	PUBLICATION FORM NUMBER	VEHICLE MODEL		QTY.	PRICE EACH*	TOTAL PRICE
		NAME	YEAR			
* Prices are subject to change without notice and without incurring obligation. Please allow adequate time for postal service.					TOTAL MATERIAL	
					Michigan Purchasers add 6% sales tax	
					Handling Charge \$4.00	
					GRAND TOTAL	

S H I P T O	NOTE: Dealers and Companies please provide dealer or company name, and also the name of the person whose attention the shipment should be sent. For purchases outside U.S.A., please write to the above address for quotation.		
	(CUSTOMER NAME)	(ATTENTION)	
	(STREET ADDRESS - NO P.O. BOX NUMBERS)	(APT. NO.)	
	(CITY)	(STATE)	(ZIP CODE)
	DAYTIME TELEPHONE NO.	AREA CODE ()	_____

P A Y M E N T	<input type="checkbox"/> Check or MoneyOrder payable to Helm, Inc. (USA funds only - do not send cash.)
	<input type="checkbox"/> MasterCard <input type="checkbox"/> VISA <input type="checkbox"/> Discover Card
	Account Number <input type="text"/> <input type="text"/> <input type="text"/> <input type="text"/> <input type="text"/> <input type="text"/> <input type="text"/> <input type="text"/> <input type="text"/> <input type="text"/> <input type="text"/> <input type="text"/> <input type="text"/> <input type="text"/> <input type="text"/> <input type="text"/> <input type="text"/> <input type="text"/> <input type="text"/> <input type="text"/> <input type="text"/>
	Expiration Date mo/yr <input type="text"/> <input type="text"/> <input type="text"/> <input type="text"/> <input type="text"/>
	(CUSTOMER SIGNATURE) _____

NOTES

NOTES

NOTES

NOTES

NOTES

NOTES

1970 DE VILLE CONVERTIBLE

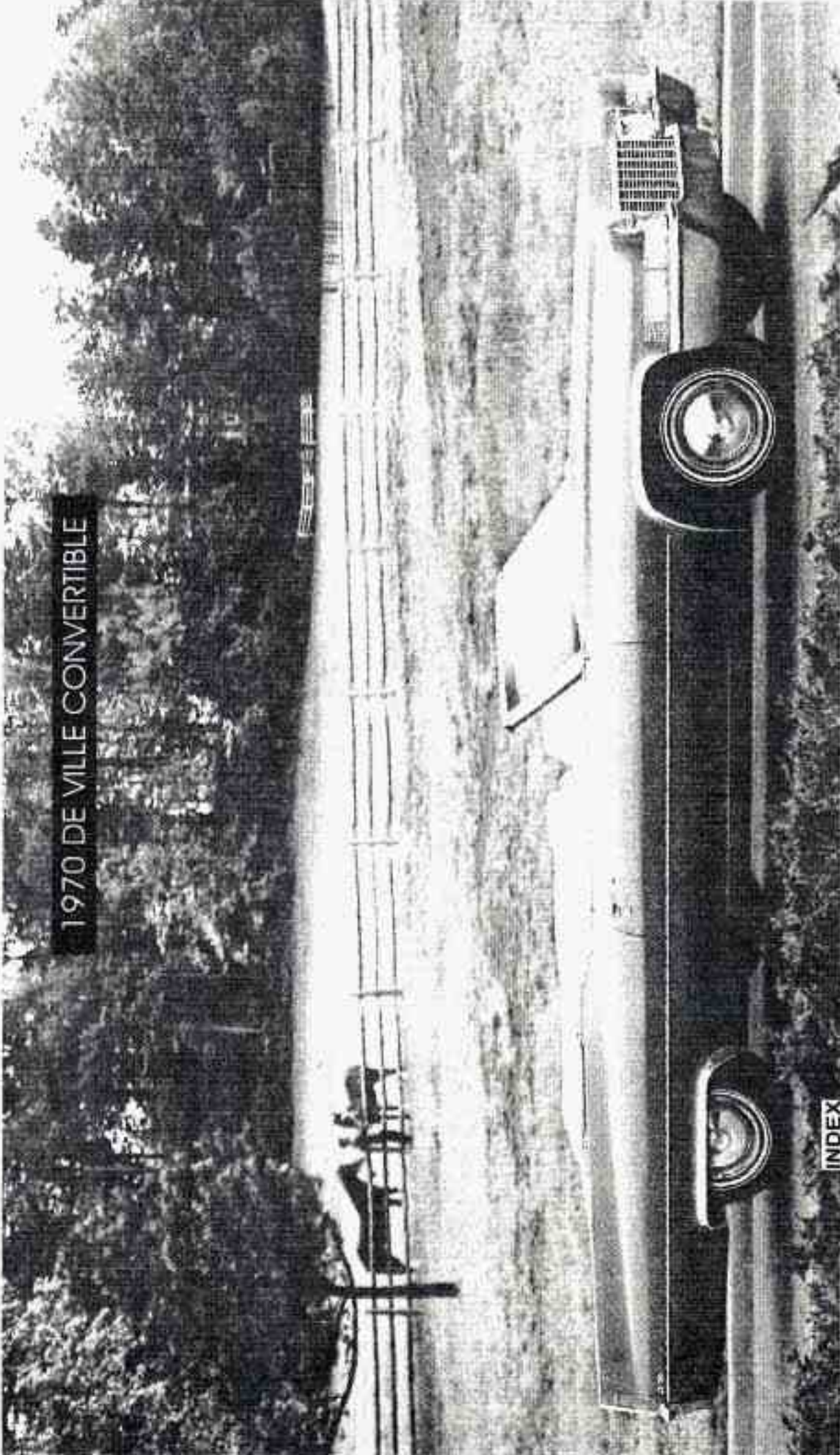

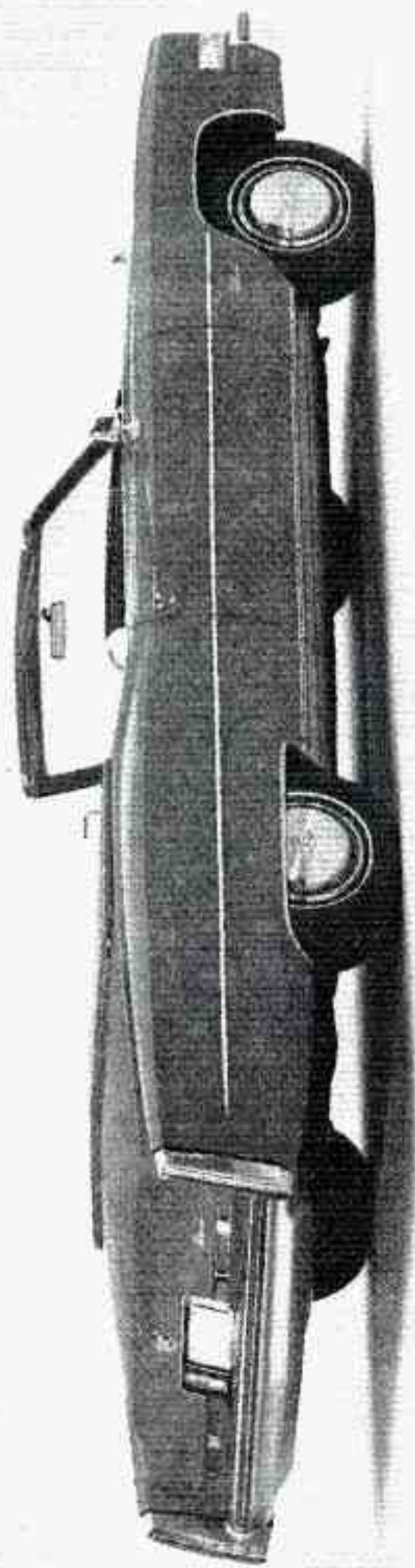

1974 FLEETWOOD ELDORADO CONVERTIBLE



DEVILLE INDEX

A

A/C Overheat-A/C Off Message	2-87
Accessory Power, Retained	6-61
Adding	
Automatic Transaxle Fluid	6-19
Brake Fluid	6-26, 6-27
Electrical Equipment	2-23, 3-22, 6-61
Engine Coolant	6-21
Engine Oil	6-11
Power Steering Fluid	6-24
Sound Equipment	3-22
Windshield Washer Fluid	2-43, 6-25
Adjuster, Seat	1-2
Air Bag	1-21
How Does It Restrain	1-26
How It Works	1-24
Location	1-25
Readiness Light	1-23, 2-76
Servicing	1-28
What Makes It Inflate	1-26
What Will You See After It Inflates	1-26
When Should It Inflate	1-25
Air Cleaner	6-16
Air Conditioning	3-4
Air Conditioning Refrigerants	6-74
Air Outlets	3-1
Alarm, Theft Deterrent System	2-17
Alignment and Balance, Tires	6-45
Aluminum Wheels, Cleaning	6-55
AM Radio	3-8
Antenna, Care	3-24
Antifreeze	6-20
Anti-Lock Brakes	4-7
Anti-Lock Brake System Warning Light	2-78, 4-7
Anti-Lockout Feature	2-7
Appearance Care	6-48
Appearance Care Materials Chart	6-58
Apply Brake to Shift Message	2-87

Armrest, Storage	2-15
Ashtrays	2-71
Astrorooft-Express Open	2-67
Audio Systems	3-8
Auto-Dimming Rearview Mirror	2-62
Automatic Door Locks	2-5
Automatic Rearview Mirror	2-57
Automatic Pull-Down Feature	2-12
Automatic Transaxle	2-25
Chart	6-72
Fluid	6-17
Average Fuel Economy Display	2-83
Avg Mph Reset, Driver Information Center	2-86

B

Battery	6-30
Charge Light	2-76
No Charge Message	2-87
Power Loss	6-30
Replacement, Keyless Entry	2-10
Volts High Message	2-87
Volts Low Message	2-88
Warnings	5-3, 5-5
BBB Auto Line	See Owner Assistance
Blizzard	4-30
Brakes	
Adjustment	6-29
Anti-Lock	4-7
Fluid, Adding	6-26
Master Cylinder	6-26
Parking	2-29
Pedal Travel	6-29
System Parts, Replacing	6-29
System Warning Light	2-77
Trailer	4-38
Transaxle Shift Interlock (BTSI)	2-33
Wear	6-28
Braking	4-6
Braking, In Emergencies	4-10
Break-Away Outside Mirror	2-63
"Break-In," New Vehicle	2-20
Bulb Replacement Chart	6-70
Center High-Mounted Stop Lamp	6-36
Headlamps	6-32
Taillamps	6-35

C

Capacities and Specifications	6-71
Carbon Monoxide	2-34, 4-31, 4-38
Cassette Tape Player Care	3-23
Center High-Mounted Stop Lamp Bulb Replacement	6-36
Center Passenger Position	1-30
Certification/Tire Label	4-32
Chains, Safety	4-38
Chains, Tire	6-47
Change Engine Oil Message	2-89
Change Oil Soon Message	2-89
Change Trans Fluid Message	2-88
Changing a Flat Tire	5-24
Check Brake Fluid Message	2-88
Check Coolant Level Message	2-88
Check Fuel Gage Message	2-88
Check Washer Fluid Message	2-89
Checking	
Automatic Transaxle Fluid	6-17
Brake Fluid	6-27
Engine Coolant	6-21
Engine Oil	6-10
Power Steering Fluid	6-23
Restraint Systems	1-54
Things Under the Hood	6-7
Chemical Paint Spotting	6-57
Child Restraints	1-40
Securing in a Rear Outside Seat Position	1-43
Securing in the Center Rear Seat Position	1-45
Securing in the Right Front Seat Position	1-48
Top Strap	1-42
Where to Put	1-40
Cigarette Lighter	2-72
Circuit Breaker, Power Windows and Other	
Power Options	6-69
Cleaner, Air	6-16
Cleaning	
Aluminum Wheels	6-55
Fabric	6-49
Glass	6-53
Leather	6-51
Outside of the Windshield and Wiper Blades	6-53
Speaker Covers	6-52
Special Problems, Stains	6-50
The Inside of Your Cadillac	6-49

The Outside of Your Cadillac	6-54
Tires	6-55
Top of the Instrument Panel	6-52
Vinyl	6-51
Climate Control	3-2
Clock, Setting the	3-9
Comfort Controls	3-1
Compact Disc Care	3-23
Compact Spare Tire	5-33
Compass, Electrochromic Rearview Mirror	2-59
Control, Loss of	4-15
Control of a Vehicle	4-5
Convenience Net	2-64
Convex Outside Mirror	2-63
Coolant	6-20
Heater, Engine	2-24, 6-15
Recovery Tank	5-16
Cooling System	5-14
Cornering Lamp Bulb Replacement	6-33
Cruise Control	2-45
Erasing Speed Memory	2-50
Getting Out of	2-50
Passing Another Vehicle While Using	2-49
To Increase Speed	2-49
To Reduce Speed	2-49
To Resume a Set Speed	2-48
To Set	2-46
Traction Control Activated	2-45
Use on Hills	2-49
Cruise Engaged Message	2-89
Customer Assistance Information	See Owner Assistance

D

Damage, Finish	6-56
Damage, Sheet Metal	6-56
Daytime Running Lamps	2-54
Dead Battery	5-4
Defects, Reporting	See Owner Assistance
Defensive Driving	4-1
Defog	3-4
Defogger, Rear	3-6
Defroster	3-5
De-Ice, Front	3-7
Delco Music System	3-14, 3-17
Display On/Off Button, Driver Information Center	2-86

Door	
Central Unlocking System	2-7
Locks	2-3
Driver Information Center	2-84, 2-85, 2-87
Driver Position	1-11
Driving On Grades, with a Trailer	4-40
Driving	
At Night	4-16
City	4-21
Defensive	4-1
Drunken	4-2
Freeway	4-22
In a Blizzard	4-30
In the Rain	4-18
On Curves	4-11
On Hill and Mountain Roads	4-25
On Snow and Ice	4-28
Through Deep Standing Water	2-23
Winter	4-27
With a Trailer	4-39

E

Electrical Equipment, Adding	2-23, 3-22, 6-61
Electrical Systems Chart	6-73
Electrochromic Rearview Mirror	2-59
Electronic Climate Control (ECC)	3-2
Electronic Solar Sensor	3-6
Features	3-4
Electronic Level Control	2-95
Emission Control Systems Chart	6-73
Eng/Met Button, Driver Information Center	2-86
Engine Compartment Fuse Block	6-62
Engine Coolant	6-20
Heater	2-24, 6-15
Hot Message	2-89
Engine	
Cooling System Chart	6-72
Exhaust	2-34
Hot-A/C Compressor Off Message	2-90
Identification	6-60
Lubrication System Chart	6-72
Overheating	5-11
Running It While You're Parked	2-35
Specifications	6-71
Starting	2-22
Temperature Warning Light	2-79

Engine Oil	6-10
Adding	6-11
Additives	6-14
Checking	6-10
Life Indicator	2-94
Warning Light	2-81
What Kind to Use	6-12
What to Do with Used Oil	6-15
When to Change	6-14
English/Metric Button	2-74
Ethanol (In Fuel)	6-3
Exhaust, Engine	2-34
Exhaust Systems Chart	6-73
Expectant Mothers, Use of Safety Belts	1-29
Express Down Window	2-37
Extender, Safety Belt	1-54
Exterior Lamp Housings	6-31

F

Fabric Cleaning	6-49
Filling Your Tank	6-4
Filter	
Air Cleaner	6-16
Engine Oil	6-14
Finish Care	6-54
Finish Damage	6-56
First (1) Position, Automatic Transaxle	2-28
Flash-To-Pass Feature	2-42
Flashers, Hazard Warning	5-1
Flat Tire, Changing	5-24
Floor Mats	2-63
Fluid Capacities Chart	6-73
Fluid Usage Label	6-9
FM Stereo	3-8
French Language Manual	ii
Front De-Ice	3-7
Fuel	6-2
Data Panel	2-83
Door Release, Remote	6-5
Filling Your Tank	6-4
Gage	2-82
In Foreign Countries	6-4
Level Very Low Message	2-90
System Chart	6-72
Used Reset, Driver Information Center	2-86

Fuse Block, Engine Compartment	6-62
Fuse Block, Rear Compartment	6-66
Fuse Panel	6-65, 6-66
Fuses and Circuit Breakers	6-62

G

Gage, Fuel	2-82
Gasolines for Cleaner Air	6-3
GAWR (Gross Axle Weight Rating)	4-33
Glass, Cleaning	6-53
Glove Box	2-15
GVWR (Gross Vehicle Weight Rating)	4-33

H

Halogen Bulbs	6-31
Hazard Warning Flashers	5-1
Head Restraints	1-5
Headlamps	2-51
Bulb Replacement	6-32
High-Low Beam Changer	2-41
Wiper Activated	2-41
Wiring	6-69
Hearing or Speech Impaired	See Owner Assistance
Heated Front Seat Feature	1-4
Heated Outside Rearview Mirror	2-62, 3-6
Heated Windshield	3-7
Heating	3-4
High Beam Lamps, How to Change	2-41
Highway Hypnosis	4-24
Hill and Mountain Roads	4-25
Hitches, Trailer	4-38
HomeLink Universal Transmitter	2-68
Hood Release	6-8
Horn	2-38
Hydroplaning	4-20

I

If You're Stuck: In Sand, Mud, Ice or Snow	5-34
Ignition Key Positions	2-20
Illuminated Entry System	2-7
Information Button, Driver Information Center	2-85
Instrument Panel	2-73

Instrument Panel, Cleaning	6-52
Interior Lamps	2-52

J

Jack, Tire	5-25
Jump Starting	5-3

K

Keyless Entry System	2-8
Battery Replacement	2-10
Matching Transmitters	2-10
Operation	2-9
Keys	2-1

L

Lamp, Malfunction Indicator	2-80
Lamps	2-51
Cornering	2-53
Daytime Running	2-54
Housings, Exterior	6-31
On Reminder	2-52
Underhood	2-53
Lane Change Indicator	2-40
Larger Children, Safety Belt Use	1-51
Leaving Your Vehicle	2-7
Leaving Your Vehicle with the Engine Running	2-32
Level Control, Electronic	2-95
Light Sensor, Twilight Sentinel	2-53
Lights	
Air Bag Readiness	1-23, 2-76
Anti-Lock Brake System Warning	2-78, 4-7
Battery Charge	2-76
Brake System Warning	2-77
Engine Oil Warning	2-81
Engine Temperature Warning	2-79
Safety Belt Reminder	1-6, 2-75
Service Engine Soon	2-80
Warning	2-75
Lighter	2-71
Loading Your Vehicle	4-32
Locks	2-3, 2-5, 2-6
Lockout, Anti-	2-7

Loss of Control	4-15
Low Oil Level Message	2-89

M

Maintenance	
Normal Replacement Parts	6-75
Underbody	6-56
When Trailer Towing	4-41
Malfunction Indicator Lamp (Service Engine Soon Light) .	2-80
Manual Seatback Recliner	1-2
Mats, Floor	2-63
MaxiFuse™ /Relay Center	6-63
Methanol (In Fuel)	6-3
Mirrors	2-57
Automatic Rearview	2-57
Break-Away Outside	2-63
Convex Outside	2-63
Electrochromic Rearview with Compass	2-59
Heated Outside Rearview	2-62, 3-6
Power	2-62
Vanity	2-66
Mpg Avg Reset, Driver Information Center	2-86
MTBE (In Fuel)	6-3

N

Net, Convenience	2-64
Neutral (N) Position, Automatic Transaxle	2-26
New Vehicle "Break-In"	2-20
Night Vision	4-17

O

Odometer	2-74
Off-Road Recovery	4-13
Oil	
Engine	6-10
Life Indicator	2-94
Life Left Reset, Driver Information Center	2-86, 6-15
Ordering, Owner Publications	See Owner Assistance
Outlets, Rear	3-7
Outside Air	3-1
Overdrive (Ⓞ) Position, Automatic Transaxle	2-27
Overheated Engine	5-11

P

Paint Spotting, Chemical	6-57
Park (P) Position, Automatic Transaxle	2-25
Shifting Into	2-30
Shifting Out of	2-33
Parking	
At Night	2-16
Lots	2-16
On Hills While Towing a Trailer	4-41
Over Things That Burn	2-33
Parking Brake	2-29
PASS-Key II	2-18
Passing	4-13
Power	
Antenna Mast Care	3-24
Door Locks	2-5
Folding Mirror	2-63
Remote Control Mirrors	2-62
Seat Controls	1-1
Seatback Recliner	1-3
Steering	4-10
Steering Fluid	6-23, 6-24
Windows	2-36
Pregnancy, Use of Safety Belts	1-29
Problems on the Road	5-1
Publications, Service and Owner	See Owner Assistance
Pull-Down Feature, Automatic	2-12

R

Radiator Pressure Cap	6-22
Radiator, Adding Coolant	5-19
Radios	3-10, 3-14, 3-17
Rain, Driving In	4-18
Reading Lamps	2-55
Rear	
Compartment Fuse Block	6-66
Defogger	3-6
Door Security Locks	2-6
Seat Air Outlet	3-7
Seat Outside Position	1-33
Seat Passengers	1-33
Storage Armrest	2-15
Taillamp Monitor	2-56

Rearview Mirror	
Automatic	2-57
Electrochromic with Compass	2-59
On/Off Switch	2-58
Reclining Front Seatbacks	1-2
Remote Fuel Door Release	6-5
Remote Trunk Release	2-14
Replacement	
Bulbs	6-70
Parts	6-75
Wheels	6-45
Replacing Seat and Restraint System Parts After a Crash	1-54
Reset Button, Driver Information Center	2-85
Restraints	
Checking Your	1-54
Child	1-40
Head	1-5
Replacing Parts After a Crash	1-54
Retained Accessory Power	6-61
Reverse Gear Day Mode	2-58
Reverse (R) Position, Automatic Transaxle	2-26
Right Front Passenger Position	1-30
Rocking Your Vehicle	5-34
Rotation, Tire	6-41

S

Safety Belts	1-5
Adults	1-11
Care of	6-52
Center Passenger Position	1-30
Driver Position	1-11
Extender	1-54
How to Wear Properly	1-11
Incorrect Usage	1-17, 1-52, 1-53
Lap Belt	1-30
Lap-Shoulder	1-11, 1-34
Questions People Ask	1-10
Rear Seat Outside Passenger Positions	1-33
Rear Seat Passengers	1-33
Reminder Light	1-6, 2-75
Replacing After a Crash	1-54
Right Front Passenger Position	1-30
Shoulder Belt Height Adjuster	1-14
Shoulder Belt Tightness Adjustment	1-15
Use by Children	1-38

Use by Larger Children	1-51
Use by Smaller Children and Babies	1-38
Use During Pregnancy	1-29
Why They Work	1-7
Safety Chains	4-38
Safety Defects, Reporting	See Owner Assistance
Safety Warnings and Symbols	iii
Seatback, Power Recliner	1-3
Seats	1-1
Adjuster	1-2
Heated Front	1-4
Reclining Front	1-2
Securing a Child Restraint	1-43
Seats and Restraint Systems	1-1
Seats and Seat Controls	1-1
Second (2) Position, Automatic Transaxle	2-28
Security System (PASS-Key II)	2-18
Service	6-1
A/C System A/C Compressor Off	2-90
Air Bag System Message	2-91
Appearance Care	6-1
Engine Soon Light	2-80
Now-Refer to Owners Manual Message	2-90
Parts Identification Label	6-60
Publications	See Owner Assistance
Ride Control Message	2-90
Vehicle Soon Message	2-91
Work, Doing Your Own	6-1
Your Air Bag-Equipped Cadillac	1-28
Shifting	
Automatic Transaxle	2-25
Into Park (P)	2-30
Out of Park (P)	2-33
Shoulder Belt	1-14, 1-15
Signaling Turns	2-40
Skidding	4-15
Sound Equipment, Adding	3-22
Spare Tire, Compact	5-33
Speaker Covers, Cleaning	6-52
Specifications Chart	6-71
Speed Sensitive Steering (SSS)	2-93
Speed Sensitive Suspension	2-93
Speedometer	2-74
Stains, Cleaning	6-50, 6-51

Starting Disabled Message	2-90
Starting Your Engine	2-22
Steam, If Coming From Your Engine	5-12
Steering	4-10
Column Shift Lever	2-31
In Emergencies	4-12
Power	4-10
Speed Sensitive	2-93
Tips	4-11
Wheel, Tilts	2-38
Stop Engine Engine Overheated Message	2-91
Stop Engine Low Oil Pressure Message	2-91
Storage, Of Your Vehicle	6-30
Stuck, If You Are	5-34
Supplemental Inflatable Restraint (SIR)	1-21
Suspension, Speed Sensitive	2-93
Symbols, Vehicle	v

T

Taillamps, Bulb Replacement	6-35
Taillamps Monitor, Rear	2-56
Tape Player Care	3-23
Temperature	3-3
Theft	2-16
Theft Deterrent Alarm System	2-17
Theft System Problem/Car May Not Restart Message	2-91
Thermostat	6-23
Third (3) Position, Automatic Transaxle	2-28
Tighten Torque Chart	6-74
Tilt Steering Wheel	2-38
Time, Setting the	3-9
Timer Button, Driver Information Center	2-85
Tire Chains	6-47
Tire Loading	4-32
Tires	6-38
Alignment and Balance	6-45
Buying New	6-43
Changing a Flat	5-24
Inflation	6-39
Inspection and Rotation	6-41
Spare, Compact	5-33
Temperature	6-44
Traction	6-44
Treadwear	6-44

Uniform Quality Grading	6-44
Wear Indicators	6-42
Wheel Replacement	6-45
When It's Time for New	6-42
Top Strap	1-42
Torque Lock	2-32
Torque, Wheel Nut	5-32
Towing a Trailer	4-34
Towing Your Vehicle	5-9
Traction Active Message	2-91, 4-9
Traction Control System	4-9
Traction Control System Active Message	2-79
Traction Disabled Message	2-78, 2-91, 4-9
Trailer	
Brakes	4-38
Driving on Grades	4-40
Driving with a	4-39
Engine Cooling When Towing	4-42
Hitches	4-38
Maintenance	4-41
Parking on Hills	4-41
Safety Chains	4-38
Tongue, Weight of	4-36
Total Weight on Your Vehicle's Tires	4-37
Towing a	4-34
Turn Signals	4-40
Weight of a Trailer	4-36
Transaxle Fluid	
Automatic	6-17
Change Indicator, Reset	6-20
Reset Message	2-92
Transmitter, HomeLink Universal	2-68
Transmitters, Matching to Your Vehicle	2-10
Trip Odometer	2-74
Trip Set Button, Driver Information Center	2-86
Trunk	
Open Message	2-92
Release, Remote	2-14
Security Override	2-13
Turn Signal and Lane Change Indicator	2-40
Turn Signal On Message	2-92
Turn Signal/Multifunction Lever	2-39
Turn Signals When Towing a Trailer	4-40
Twilight Sentinel	2-52

U

Underbody Maintenance	6-56
Underhood Lamp	2-53

V

Vanity Mirrors	2-66
Vehicle	
Control of a	4-5
Damage Warnings	iv
Dimensions Chart	6-74
Identification Number (VIN)	6-59
Leaving Your	2-7
Loading	4-32
Storage	6-30
Symbols	v
Very Low Refrigerant A/C Compressor Off Message	2-92
Vision, Night	4-17
Visor, Front and Auxiliary System	2-65

W

Warning	
Devices	5-3
Flashers, Hazard	5-1
Lights	2-75
Washing Your Vehicle	6-54
Weatherstrips	6-53
Wheel Nut Torque	5-32
Wheel Replacement	6-45, 6-47
Windows	2-36, 2-37
Windshield	
Heated	3-7
Washer Fluid	2-44, 6-25
Washers	2-43
Wiper, Blade Replacement	6-37
Wipers	2-42
Winter Driving	4-27
Wiring, Headlamp	6-69
Wood Panels, Care of	6-52
Wrecker Towing	5-9

NOTES

1978 SEVILLE ELEGANTE

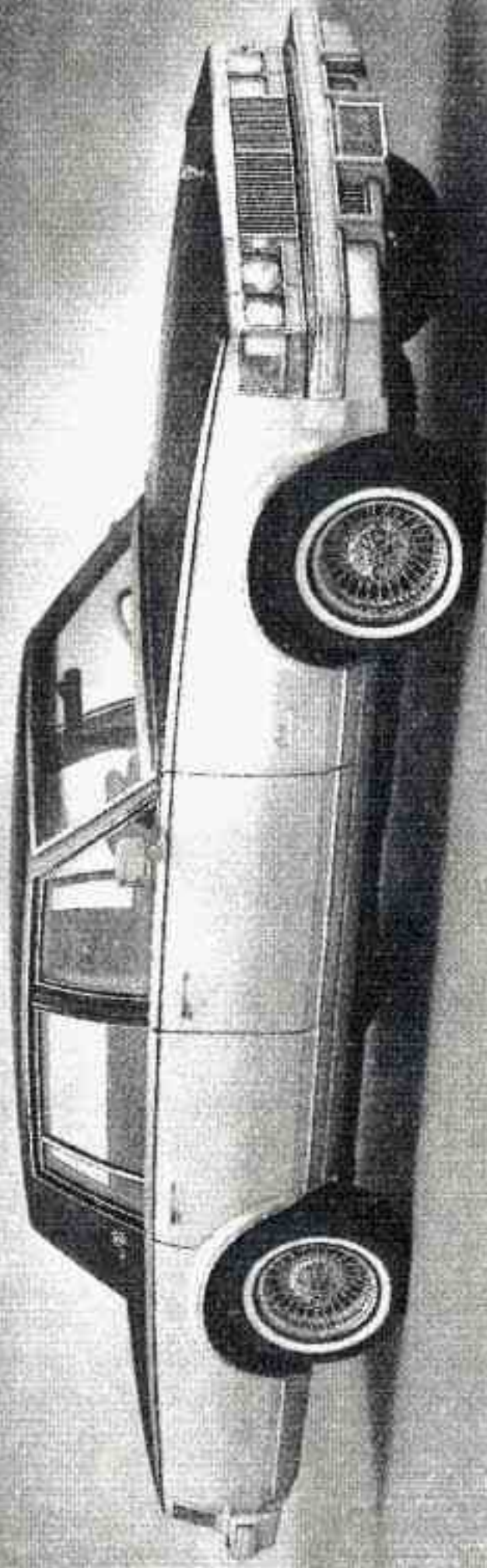

WARRANTY

WARRANTY



1984 ELDORADO BIARRITZ CONVERTIBLE