

2012 Buick Enclave Owner Manual

In Brief	1-1	Storage	4-1	Rear Seat Infotainment	7-40
Instrument Panel	1-2	Storage Compartments	4-1	Phone	7-52
Initial Drive Information	1-4	Additional Storage Features	4-4	Trademarks and License	
Vehicle Features	1-15	Roof Rack System	4-5	Agreements	7-60
Performance and		Instruments and Controls	5-1	Climate Controls	8-1
Maintenance	1-20	Controls	5-2	Climate Control Systems	8-1
Keys, Doors, and		Warning Lights, Gauges, and		Air Vents	8-9
Windows	2-1	Indicators	5-12	Maintenance	8-10
Keys and Locks	2-2	Information Displays	5-27	Driving and Operating	9-1
Doors	2-10	Vehicle Messages	5-31	Driving Information	9-2
Vehicle Security	2-14	Vehicle Personalization	5-41	Starting and Operating	9-17
Exterior Mirrors	2-17	Universal Remote System	5-49	Engine Exhaust	9-24
Interior Mirrors	2-19	Lighting	6-1	Automatic Transmission	9-26
Windows	2-20	Exterior Lighting	6-1	Drive Systems	9-29
Roof	2-22	Interior Lighting	6-6	Brakes	9-30
Seats and Restraints	3-1	Lighting Features	6-7	Ride Control Systems	9-32
Head Restraints	3-2	Infotainment System	7-1	Cruise Control	9-34
Front Seats	3-3	Introduction	7-1	Object Detection Systems	9-37
Rear Seats	3-9	Radio	7-7	Fuel	9-44
Safety Belts	3-14	Audio Players	7-14	Towing	9-48
Airbag System	3-23			Conversions and Add-Ons	9-58
Child Restraints	3-38				

2012 Buick Enclave Owner Manual

Vehicle Care	10-1	Technical Data	12-1
General Information	10-2	Vehicle Identification	12-1
Vehicle Checks	10-4	Vehicle Data	12-2
Headlamp Aiming	10-28	Customer Information	13-1
Bulb Replacement	10-29	Customer Information	13-1
Electrical System	10-31	Reporting Safety Defects	13-19
Wheels and Tires	10-38	Vehicle Data Recording and	
Jump Starting	10-79	Privacy	13-21
Towing	10-83	OnStar	14-1
Appearance Care	10-86	OnStar Overview	14-1
Service and Maintenance ...	11-1	OnStar Services	14-2
General Information	11-1	OnStar Additional	
Maintenance Schedule	11-2	Information	14-5
Special Application		Index	i-1
Services	11-8		
Additional Maintenance			
and Care	11-9		
Recommended Fluids,			
Lubricants, and Parts	11-12		
Maintenance Records	11-15		



The names, logos, emblems, slogans, vehicle model names, and vehicle body designs appearing in this manual including, but not limited to, GM, the GM logo, BUICK, the BUICK Emblem, and ENCLAVE are trademarks and/or service marks of General Motors LLC, its subsidiaries, affiliates, or licensors.

This manual describes features that may or may not be on your specific vehicle either because they are options that you did not purchase or due to changes subsequent to the printing of this owner manual. Please refer to the purchase documentation relating to your specific vehicle to confirm each of the features found on your vehicle. For vehicles first sold in Canada, substitute the name "General Motors of Canada Limited" for Buick Motor Division wherever it appears in this manual.

Keep this manual in the vehicle for quick reference.

Canadian Vehicle Owners

Propriétaires Canadiens

A French language copy of this manual can be obtained from your dealer or from:

On peut obtenir un exemplaire de ce guide en français auprès du concessionnaire ou à l'adresse suivante:

Helm, Incorporated
P.O. Box 07130
Detroit, MI 48207

1-800-551-4123
Numéro de poste 6438 de langue française
www.helminc.com

Using this Manual

To quickly locate information about the vehicle, use the Index in the back of the manual. It is an alphabetical list of what is in the manual and the page number where it can be found.

Danger, Warnings, and Cautions

Warning messages found on vehicle labels and in this manual describe hazards and what to do to avoid or reduce them.

Danger indicates a hazard with a high level of risk which will result in serious injury or death.

Warning or **Caution** indicates a hazard that could result in injury or death.

WARNING

These mean there is something that could hurt you or other people.

Notice: This means there is something that could result in property or vehicle damage. This would not be covered by the vehicle's warranty.



A circle with a slash through it is a safety symbol which means "Do Not," "Do not do this," or "Do not let this happen."

Symbols

The vehicle has components and labels that use symbols instead of text. Symbols are shown along with the text describing the operation or information relating to a specific component, control, message, gauge, or indicator.

 : This symbol is shown when you need to see your owner manual for additional instructions or information.

 : This symbol is shown when you need to see a service manual for additional instructions or information.

Vehicle Symbol Chart

Here are some additional symbols that may be found on the vehicle and what they mean. For more information on the symbol, refer to the Index.

 : Airbag Readiness Light

 : Air Conditioning

 : Antilock Brake System (ABS)

 : Audio Steering Wheel Controls or OnStar®

 : Brake System Warning Light

 : Charging System

 : Cruise Control

 : Engine Coolant Temperature

 : Exterior Lamps

 : Fog Lamps

 : Fuel Gauge

 : Fuses

 : Headlamp High/Low-Beam Changer

 : LATCH System Child Restraints

 : Malfunction Indicator Lamp

 : Oil Pressure

 : Outside Power Foldaway Mirrors

 : Power

 : Remote Vehicle Start

 : Safety Belt Reminders

 : Tire Pressure Monitor

 : Tow/Haul Mode

 : Traction Control/StabiliTrak

 : Windshield Washer Fluid

In Brief

Instrument Panel

Instrument Panel 1-2

Initial Drive Information

Initial Drive Information 1-4

Remote Keyless Entry (RKE)

System 1-4

Remote Vehicle Start 1-5

Door Locks 1-5

Liftgate 1-6

Windows 1-6

Seat Adjustment 1-7

Memory Features 1-7

Second Row Seats 1-8

Third Row Seats 1-9

Heated and Ventilated

Seats 1-9

Head Restraint

Adjustment 1-10

Safety Belts 1-10

Passenger Sensing

System 1-10

Mirror Adjustment 1-11

Steering Wheel

Adjustment 1-11

Interior Lighting 1-12

Exterior Lighting 1-13

Windshield Wiper/Washer 1-13

Climate Controls 1-14

Transmission 1-15

Vehicle Features

Radio(s) 1-15

Satellite Radio 1-16

Portable Audio Devices 1-17

Bluetooth® 1-17

Steering Wheel Controls 1-17

Cruise Control 1-18

Navigation System 1-18

Ultrasonic Parking Assist 1-19

Storage Compartments 1-19

Power Outlets 1-19

Sunroof 1-20

Performance and Maintenance

StabiliTrak® System 1-20

Tire Pressure Monitor 1-21

Tire Sealant and

Compressor Kit 1-21

Engine Oil Life System 1-22

Driving for Better Fuel

Economy 1-22

Roadside Assistance

Program 1-23

OnStar® 1-23

Instrument Panel

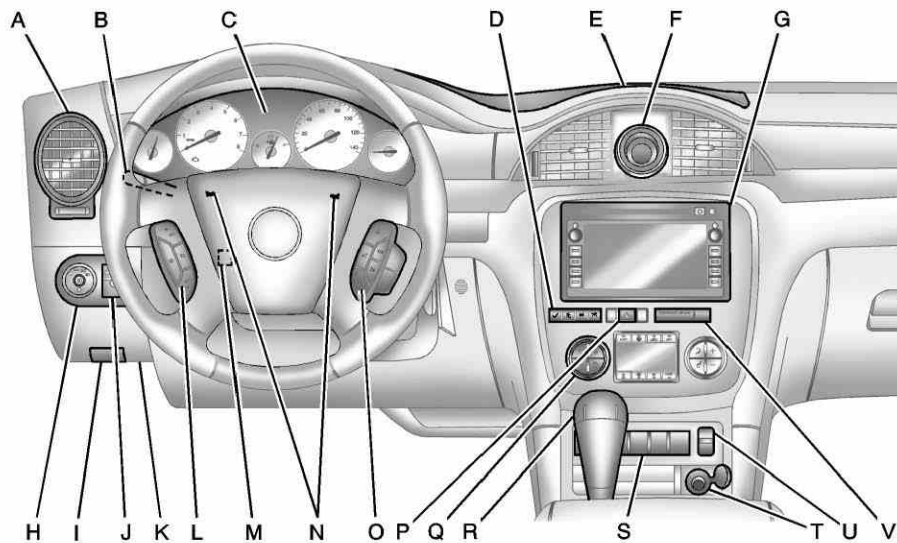

- A. *Air Vents on page 8-9.*
- B. *Turn and Lane-Change Lever. See Turn and Lane-Change Signals on page 6-5.*
Windshield Wiper/Washer on page 5-5.
- C. *Instrument Cluster on page 5-13.*
- D. *Driver Information Center (DIC) Buttons. See Driver Information Center (DIC) on page 5-27.*
- E. *Instrument Panel Storage on page 4-1.*
USB Port (Inside IP Storage). Auxiliary Devices on page 7-38
- F. *Clock on page 5-9.*
- G. *Infotainment on page 7-1.*
Navigation/Radio System (If Equipped). See the separate navigation manual.
- H. *Exterior Lamp Controls on page 6-1.*
- I. *Hood Release. See Hood on page 10-5.*
- J. *Instrument Panel Illumination Control on page 6-6.*
- K. *Data Link Connector (DLC) (Out of View). See Malfunction Indicator Lamp on page 5-20.*
- L. *Cruise Control on page 9-34.*
- M. *Steering Wheel Adjustment on page 5-2.*
- N. *Horn on page 5-5.*
- O. *Steering Wheel Controls on page 5-3.*
- P. *Hazard Warning Flashers on page 6-4.*
- Q. *Dual Automatic Climate Control System on page 8-1.*
- R. *Console Shift Lever. See "Console Shift Lever" under Shifting Into Park on page 9-22.*
- S. *Rear Window Wiper/Washer on page 5-6.*
Traction Control System (TCS) Disable Button. See StabiliTrak® System on page 9-32.
Tow/Haul Button (If Equipped). See Tow/Haul Mode on page 9-29.
Power Liftgate Button (If Equipped). See Liftgate on page 2-10.
- T. *Power Outlets on page 5-10.*
- U. *Heated and Ventilated Front Seats on page 3-8 (If Equipped).*
- V. *Passenger Air Bag Status Indicator. See Passenger Sensing System on page 3-31.*

Initial Drive Information



This section provides a brief overview about some of the important features that may or may not be on your specific vehicle.

For more detailed information, refer to each of the features which can be found later in this owner manual.

Remote Keyless Entry (RKE) System

The RKE transmitter is used to remotely lock and unlock the doors from up to 60 m (195 ft) away from the vehicle.





Press  to unlock the driver door.
Press  again within five seconds to unlock all remaining doors.

Press  to lock all doors.

Lock and unlock feedback can be personalized.

To open or close the liftgate, press and hold  until the liftgate begins to move.

Press  and release to locate the vehicle.

Press  and hold for more than two seconds to sound the panic alarm.



Press  again to cancel the panic alarm.

See *Remote Keyless Entry (RKE) System Operation* on page 2-3.

Remote Vehicle Start

Starting the Vehicle

With this feature the engine can be started from outside of the vehicle.

1. Aim the RKE transmitter at the vehicle.
2. Press and release .
3. Immediately after completing Step 2, press and hold  until the parking lamps flash.

When the vehicle starts, the parking lamps will turn on and remain on as long as the engine is running. The doors will be locked and the climate control system may come on.

The engine will continue to run for 10 minutes. Repeat the steps for a 10-minute time extension. Remote start can be extended only once.

Canceling a Remote Start



To cancel a remote start:

- Aim the RKE transmitter at the vehicle and press and hold  until the parking lamps turn off.
- Turn on the hazard warning flashers.
- Turn the ignition switch on and then off.

See *Remote Vehicle Start* on page 2-5.

Door Locks

To lock or unlock a door manually:

- From the inside, use the door lock knob on the window sill.
- From the outside, turn the key toward the front or rear of the vehicle, or press the  or  button on the Remote Keyless Entry (RKE) transmitter.

Power Door Locks

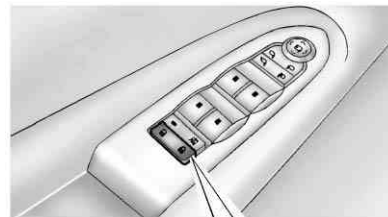

 : Press to unlock the doors.

 : Press to lock the doors.

See *Power Door Locks* on page 2-8.

Liftgate

To open the liftgate the vehicle must be in P (Park). Press the touch pad under the liftgate handle. To close the liftgate, use the pull cup or pull strap as an aid.

Power Liftgate

On vehicles with a power liftgate, the vehicle must be in P (Park) to operate it.

- Press and hold  on the Remote Keyless Entry (RKE) transmitter.

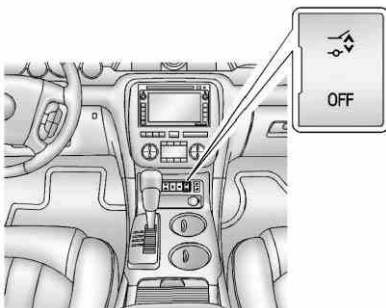

- Press the liftgate button on the center console.
- Press the touch pad switch on the outside liftgate handle.

For more information see *Liftgate on page 2-10*.

Windows

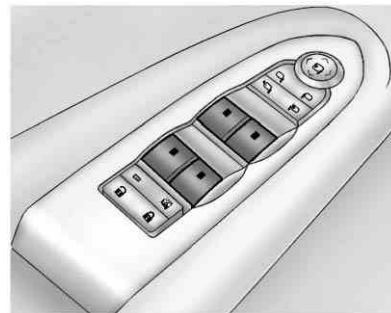

Press the switch to lower the window. Pull the switch up to raise it.

For more information, see *Power Windows on page 2-20*.

Seat Adjustment

Power Seats

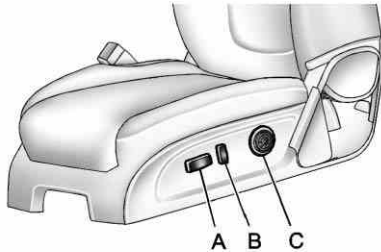

- A. Seat Adjustment Control
 - B. Reclining Seatback Control
 - C. Lumbar Adjustment Control
- Move the seat forward or rearward by moving the control (A) forward or rearward.

- Raise or lower the front or rear part of the seat cushion by moving the front or rear of the control (A) up or down.
- Raise or lower the entire seat by moving the control (A) up or down.

See *Power Seat Adjustment* on page 3-3.

To raise or recline the seatback, tilt the top of the control (B) forward or rearward. See *Reclining Seatbacks* on page 3-4.

Press the front or rear of the control (C) to increase or decrease lumbar support. See *Lumbar Adjustment* on page 3-4.

Memory Features

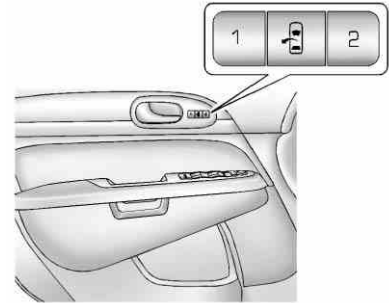

On vehicles with the memory feature, the controls on the driver door are used to program and recall memory settings for the driver seat, outside mirrors, and power steering column, if available.

1-8 In Brief

Storing Memory Positions

To save into memory:

1. Adjust the driver seat and seatback recliner, both outside mirrors, and the power steering column, if available.

See *Power Mirrors on page 2-17* and *Steering Wheel Adjustment on page 5-2* for more information.

Not all vehicles will have the ability to save and recall the mirror positions.

2. Press and hold "1" until two beeps sound.
3. Repeat for a second driver position using "2."

To recall, press and release "1" or "2." The vehicle must be in P (Park). A single beep will sound. The seat and outside mirrors will move to the position previously stored for the identified driver.

See *Memory Seats on page 3-6* and *Vehicle Personalization on page 5-41* for more information.

Easy Exit Positions

The easy exit feature can move the driver seat rearward and the power steering column, if available, up and forward to allow extra room to exit the vehicle.

: Press to recall the easy exit positions. The vehicle must be in P (Park).

See *Memory Seats on page 3-6* and *Vehicle Personalization on page 5-41* for more information.

Second Row Seats

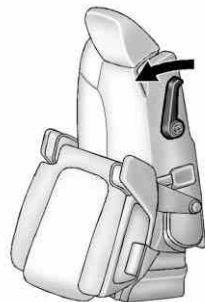

The second row seat can be folded to access the third row. Pull the sliding seat lever forward; the seat cushion folds, and the seat slides forward.

See *Rear Seats on page 3-9*.

Third Row Seats

The third row seatbacks can be folded forward, and the seats can be removed.

To fold the third row seatback:

1. Remove anything on or under the seat.

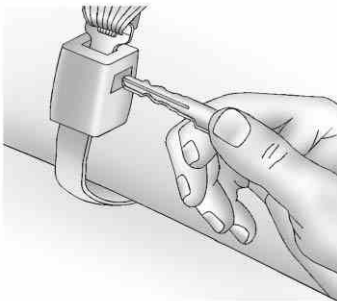

2. Disconnect the rear safety belt mini-latch using a key in the slot on the mini-buckle, and let the belt retract into the headliner. Stow the mini-latch in the holder in the headliner.

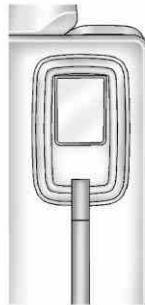

3. Pull up on the release lever on the back of the seat.
4. Push the seatback forward to lay flat.

See *Third Row Seats* on page 3-11 for more information.

Heated and Ventilated Seats

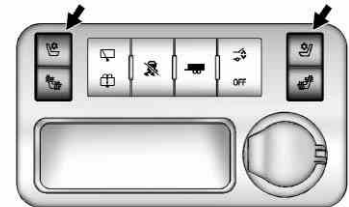

Heated and Cooled Seat Buttons Shown, Heated Seat Buttons Similar

If available, the buttons are on the center console. To operate, the engine must be running.

: If available, press to heat the seatback only.

: If available, press to cool the entire seat.

: Press to heat the seat and seatback.

Press the button once for the highest setting. With each press of the button, the seat will change to the next lower setting, and then to the off setting. The lights indicate three for the highest setting and one for the lowest.

See *Heated and Ventilated Front Seats* on page 3-8 for more information.

Head Restraint Adjustment

Do not drive until the head restraints for all occupants are installed and adjusted properly.

To achieve a comfortable seating position, change the seatback recline angle as little as necessary while keeping the seat and the head restraint height in the proper position.

For more information see *Head Restraints* on page 3-2 and *Power Seat Adjustment* on page 3-3.

Safety Belts



Refer to the following sections for important information on how to use safety belts properly:

- *Safety Belts* on page 3-14.
- *How to Wear Safety Belts Properly* on page 3-15.
- *Lap-Shoulder Belt* on page 3-16.
- *Lower Anchors and Tethers for Children (LATCH System)* on page 3-47.

Passenger Sensing System



United States



Canada and Mexico

The passenger sensing system will turn off the right front passenger frontal airbag under certain conditions. The driver airbag, seat-mounted side impact airbags, and roof-rail airbags are not affected by the passenger sensing system.

The passenger airbag status indicator will be visible on the instrument panel when the vehicle

is started. See *Passenger Sensing System* on page 3-31 for more information.

Mirror Adjustment

Exterior Mirrors

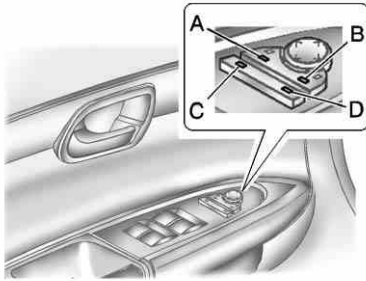

To adjust each mirror:

1. Press (A) or (B) to select the mirror.
2. Press the control pad to adjust the mirror.
3. Press (A) or (B) again to deselect the mirror.

Folding Mirrors

For vehicles with power folding mirrors:

1. Press (C) to fold the mirrors out to the driving position.
2. Press (D) to fold the mirrors in to the folded position.

For vehicles with manual folding mirrors, push the mirror toward the vehicle. Pull the mirror out to return to its original position.

Interior Mirror

The automatic dimming rearview mirror reduces the glare from other vehicle headlamps. Each time the vehicle is started, the dimming feature comes on.

See *Automatic Dimming Rearview Mirror* on page 2-19.

Steering Wheel Adjustment



1. Pull the lever (A) down.
2. Move the steering wheel up or down.
3. Pull or push the steering wheel closer or away from you.
4. Push the lever (A) up to lock the steering wheel in place.

Power Tilt Wheel



For vehicles with the power tilt and telescope wheel, the control is on the outboard side of the steering column.

Push the control up or down to tilt the steering wheel up or down.

Push the control forward or rearward to move the steering wheel toward the front or rear of the vehicle. To set the memory position, see *Vehicle Personalization* on page 5-41.

Do not adjust the steering wheel while driving.

Interior Lighting

Dome Lamps

The dome lamps are located in the overhead console and above the rear seat passengers.

The dome lamps come on when a door is opened, unless the dome lamp override button is pressed in.

To manually turn them on, turn the instrument panel brightness control clockwise to the farthest position.

Dome Lamp Override

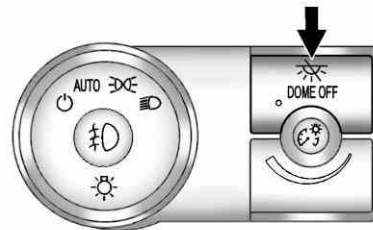

The dome lamp override button is next to the exterior lamps control.

⌘ DOME OFF: Press the top of the button in and the dome lamps remain off when a door is opened. An indicator light on the button comes on to show that the dome lamps are off. Press near the bottom of the button so the dome lamps come on when a door is opened.

Reading Lamps

Press the button near each lamp to turn them on or off.

For more information, see:

- *Dome Lamps on page 6-6.*
- *Instrument Panel Illumination Control on page 6-6.*

Exterior Lighting

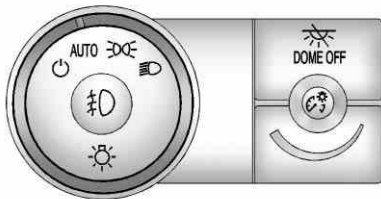



The exterior lamps control is located on the instrument panel, to the left of the steering wheel.

 : Turns the automatic light control on or off.

AUTO: Automatic operation of the headlamps at normal brightness and other exterior lamps.

 : Manual operation of the parking lamps and other exterior lamps.

 : Manual operation of the headlamps and other exterior lamps.

 : Use to turn on or off the fog lamps (if equipped).

For more information, see:

- *Exterior Lamp Controls on page 6-1.*
- *Daytime Running Lamps (DRL)/ Automatic Headlamp System on page 6-3.*
- *Fog Lamps on page 6-5.*

Windshield Wiper/Washer

The windshield wiper/washer lever is located on the left side of the steering column.



Turn the band with the wiper symbol to control the windshield wipers.

 : Use for a single wiping cycle.

 : Use to turn the wipers off.

 : Delays wiping cycle. Turn the band up for more frequent wipes or down for less frequent wipes.

1 : Slow wipes.

2 : Fast wipes.

Windshield Washer

 : Press the button at the end of the turn signal/lane change lever to spray washer fluid on the windshield.

Rear Window Wiper/Washer

The rear wiper and rear wash button is located on the instrument panel below the climate control system.

 : Press to turn the rear wiper on and off. The wiper speed cannot be changed.

 : Press to spray washer fluid on the rear window. The window wiper will also come on.

See *Windshield Wiper/Washer* on page 5-5 and *Rear Window Wiper/Washer* on page 5-6.

Climate Controls

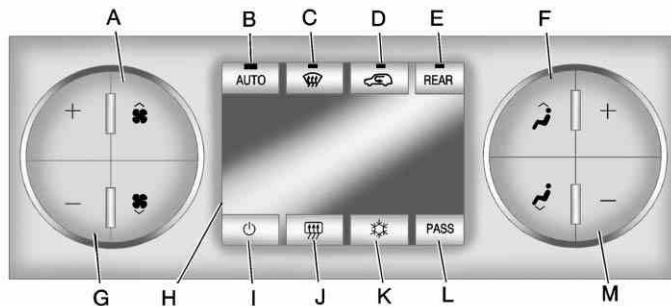

- A. Fan Control
- B. AUTO (Auto Operation)
- C. Defrost
- D. Air Recirculation
- E. REAR (Rear Climate Control)
- F. Air Delivery Mode Control
- G. Driver Side Temperature Control
- H. Display
- I. Power (On/Off)

- J. Rear Window Defogger
- K. Air Conditioning
- L. PASS (Passenger)
- M. Passenger Side Temperature Control

See *Dual Automatic Climate Control System* on page 8-1. For more information about the rear climate control, see *Rear Climate Control System (Rear Climate Control Only)*

on page 8-7 or *Rear Climate Control System (Rear Climate with Rear Seat Audio)* on page 8-8.

Transmission

Electronic Range Select (ERS) Mode

ERS mode allows you to choose the top-gear limit of the transmission and the vehicle's speed while driving downhill or towing a trailer. The vehicle has an electronic shift position indicator within the instrument panel cluster. When using the ERS mode a number will display next to the L, indicating the current gear that has been selected.

To use this feature:

1. Move the shift lever to L (Low).
2. Press the plus/minus button located on the shift lever, to increase or decrease the gear range available.

See *Manual Mode* on page 9-28.

Vehicle Features

Radio(s)





Radio with CD, DVD, and USB Port

 : Press to turn the system on and off. Turn to increase or decrease the volume.

BAND: Press to choose between FM, AM, or XM™, if equipped.

 : Select radio stations.

 or : Seek or scan stations.

: Change the display between the radio station frequency and the time, if equipped. While the ignition is off, press  to display the time.

For more information about these and other radio features, see *Operation on page 7-2*.

For vehicles with a Rear Seat Entertainment (RSE) System and Rear Seat Audio (RSA) System, see *Rear Seat Entertainment (RSE) System on page 7-40* and *Rear Seat Audio (RSA) System on page 7-50* for more information.

Storing a Favorite Station



A maximum of 36 stations can be stored as favorites using the six softkeys located below the radio station frequency tabs and by using the radio FAV button. Press FAV to go through up to six pages of favorites, each having six favorite stations available per page.

Each page of favorites can contain any combination of AM, FM, or XM stations.

See *AM-FM Radio on page 7-7*.

Setting the Clock

To set the time and date for the radio with CD, DVD, and USB Port:

1. Turn the ignition key to ACC/ACCESSORY or ON/RUN, then press  to turn the radio on.
2. Press  to display HR, MIN, MM, DD, YYYY (hour, minute, month, day, and year).
3. Press the pushbutton located under any one of the labels to be changed.
4. To increase or decrease the time or date, turn  clockwise or counterclockwise.

For detailed instructions on setting the clock for the vehicle's specific audio system, see *Clock on page 5-9*.

Satellite Radio

Vehicles with an XM™ satellite radio tuner and a valid XM satellite radio subscription can receive XM programming.

XM Satellite Radio Service

XM is a satellite radio service based in the 48 contiguous United States and 10 Canadian provinces. XM satellite radio has a wide variety of programming and commercial-free music, coast to coast, and in digital-quality sound. A fee is required to receive the XM service.

For more information refer to:

- www.xmradio.com or call 1-800-929-2100 (U.S.).
- www.xmradio.ca or call 1-877-438-9677 (Canada).

For more information, see *Satellite Radio on page 7-9*.

Portable Audio Devices

This vehicle may have an auxiliary input located on the radio faceplate and a USB port located in the instrument panel storage area. External devices such as iPods™, laptop computers, MP3 players, CD changers, USB storage devices, etc. can be connected to the auxiliary port using a 3.5 mm (1/8 in) input jack or the USB port depending on the audio system.

See *Auxiliary Devices* on page 7-38.

Bluetooth®

The Bluetooth system allows users with a Bluetooth-enabled cell phone to make and receive hands-free calls using the vehicle audio system, microphone, and controls.

The Bluetooth-enabled cell phone must be paired with the in-vehicle Bluetooth system before it can be used in the vehicle. Not all phones will support all functions.

See *Bluetooth* on page 7-52.

Steering Wheel Controls

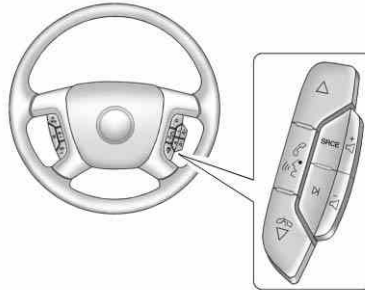

Vehicles with audio steering wheel controls could differ depending on the vehicle's options. Some audio controls can be adjusted at the steering wheel.

△ and ☎ / ▽ : Press to select preset or favorite radio stations, select tracks on a CD/DVD, or select tracks and navigate folders on an iPod® or USB device.

☎ / ☎ : Press to silence the vehicle speakers only. Press again to turn the sound on.

For vehicles with Bluetooth or OnStar® systems, press and hold for longer than two seconds to interact with those systems. See *Bluetooth* on page 7-52 and *OnStar Overview* on page 14-1 for more information.

☎ / ▽ : Press to reject an incoming call, or end a current call.

SRCE: Press to switch between the radio, CD, and for equipped vehicles, DVD, front auxiliary, and rear auxiliary.

For vehicles with the navigation system, press and hold this button for longer than one second to initiate voice recognition. See “Voice Recognition” in the navigation manual for more information.

▷: Press to go to the next radio station while in AM, FM, or XM™.

Press **▷** to go to the next track or chapter while sourced to the CD or DVD slot.

Press **▷** to select a track or a folder when navigating folders on an iPod or USB device.

+ ◀ and - ▶: Press to increase or to decrease the volume.

See *Steering Wheel Controls on page 5-3* for more information.

Cruise Control

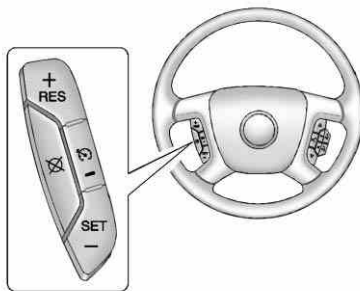

⊗: Press to turn cruise control on and off. The indicator comes on when cruise control is on.

+ RES: Press briefly to make the vehicle resume to a previously set speed, or press and hold to accelerate.

SET-: Press to set the speed and activate cruise control or to make the vehicle decelerate.

⊗: Press to disengage cruise control without erasing the set speed from memory.

See *Cruise Control on page 9-34*.

Navigation System

If the vehicle has a navigation system, there is a separate navigation system manual that includes information on the radio, audio players, and navigation system.

The navigation system provides detailed maps of most major freeways and roads. After a destination has been set, the system provides turn-by-turn instructions for reaching the destination. In addition, the system can help locate a variety of points of interest (POIs), such as banks, airports, restaurants, and more.

See the navigation system manual for more information.

Ultrasonic Parking Assist

If available, Ultrasonic Rear Parking Assist (URPA) uses sensors on the rear bumper to detect objects while parking the vehicle. It operates at speeds less than 8 km/h (5 mph). URPA uses audible beeps to provide distance and system information.

Keep the sensors on the vehicle's rear bumper clean to ensure proper operation.

See *Ultrasonic Parking Assist* on page 9-37 for more information.

Storage Compartments



For vehicles with a second row center console, press the buttons (B) or (C) to access storage areas.

Lift up on (A) for additional storage area.

See *Floor Console Storage* on page 4-3.

Power Outlets

The vehicle has 12-volt accessory power outlets which can be used to plug in electrical equipment, such as a cell phone or MP3 player.

The power outlets are located:

- On the instrument panel below the climate controls.
- Inside the center floor console.
- At the rear of the center floor console.
- In the rear cargo area.

To use the outlets, remove the cover.

See *Power Outlets* on page 5-10.

Sunroof

The ignition must be in ON/RUN or ACC/ACCESSORY to operate the sunroof and power sunshade. See *Retained Accessory Power (RAP)* on page 9-21.

The vehicle may have a sunroof over the front seats and a rear sunroof over the second row seats. The rear sunroof does not open.

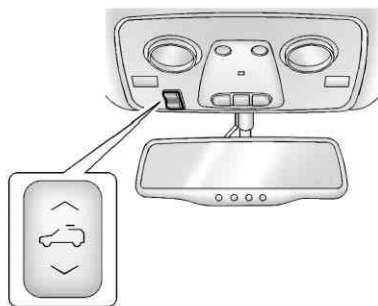

The switch to operate the front sunroof is on the headliner above the rearview mirror.

Vent: Press the front or rear of the switch to vent or close the sunroof.

Express-open/Express-close:

From the closed position, press and release the rear or front of the switch to express-open or express-close the sunroof.

Manual Sunshade

The front sunshade must be opened and closed manually.



To open the sunshade, press the button on the sunshade handle to release it and guide it back. To close the sunshade, pull the sunshade forward until it latches.

For more information see *Sunroof* on page 2-22.

Performance and Maintenance

StabiliTrak[®] System

The vehicle has a traction control system that limits wheel spin, and the StabiliTrak system that assists with directional control of the vehicle in difficult driving conditions. Both systems turn on automatically every time the vehicle is started.

- To turn off traction control, press and release  located on the instrument panel, and the appropriate DIC message displays. See *Ride Control System Messages* on page 5-37.
- Press and release  again to turn on the traction control system. The StabiliTrak system remains on.

For more information, see *StabiliTrak[®] System* on page 9-32.

Tire Pressure Monitor

This vehicle may have a Tire Pressure Monitor System (TPMS).



The TPMS warning light alerts you to a significant loss in pressure of one of the vehicle's tires. If the warning light comes on, stop as soon as possible and inflate the tires to the recommended pressure shown on the Tire and Loading Information label. See *Vehicle Load Limits* on page 9-12. The warning light will remain on until the tire pressure is corrected.

During cooler conditions, the low tire pressure warning light may appear when the vehicle is first started and then turn off. This may be an early indicator that the tire pressures are getting low and the tires need to be inflated to the proper pressure.

The TPMS does not replace normal monthly tire maintenance. It is the driver's responsibility to maintain correct tire pressures.

See *Tire Pressure Monitor System* on page 10-46.

Tire Sealant and Compressor Kit

This vehicle may come with a spare tire and tire changing equipment or a tire sealant and compressor kit. The kit can be used to temporarily seal small punctures in the tread area of the tire.

See *Tire Sealant and Compressor Kit* on page 10-62 for complete operating information.

If the vehicle came with a spare tire and tire changing equipment, see *If a Tire Goes Flat* on page 10-60.

Engine Oil Life System

The engine oil life system calculates engine oil life based on vehicle use and displays the CHANGE ENGINE OIL SOON message when it is time to change the engine oil and filter. The oil life system should be reset to 100% only following an oil change.

Resetting the Oil Life System

1. Turn the ignition to ON/RUN, with the engine off.
2. Press the vehicle information button until OIL LIFE REMAINING displays.
3. Press and hold the set/reset button until "100%" is displayed. Three chimes sound and the CHANGE ENGINE OIL SOON message goes off.
4. Turn the key to LOCK/OFF.

See *Engine Oil Life System* on page 10-10.

Driving for Better Fuel Economy

Driving habits can affect fuel mileage. Here are some driving tips to get the best fuel economy possible.

- Avoid fast starts and accelerate smoothly.
 - Brake gradually and avoid abrupt stops.
 - Avoid idling the engine for long periods of time.
 - When road and weather conditions are appropriate, use cruise control.
- Always follow posted speed limits or drive more slowly when conditions require.
 - Keep vehicle tires properly inflated.
 - Combine several trips into a single trip.
 - Replace the vehicle's tires with the same TPC Spec number molded into the tire's sidewall near the size.
 - Follow recommended scheduled maintenance.

Roadside Assistance Program

U.S.: **1-800-252-1112**

TTY Users (U.S.): **1-888-889-2438**

Canada: **1-800-268-6800**

Mexico: **01-800-466-0818**

As the owner of a new Buick, you are automatically enrolled in the Roadside Assistance program.

See *Roadside Assistance Program (U.S. and Canada)* on page 13-8 or *Roadside Assistance Program (Mexico)* on page 13-10 for more information.

Roadside Service and OnStar (U.S. and Canada)

If you have an active OnStar subscription, press the  button and the current GPS location will be sent to an OnStar Advisor who will assess your problem, contact Roadside Assistance, and relay your exact location to get the help you need.

Online Owner Center (U.S. and Canada)

The Online Owner Center is a complimentary service that includes online service reminders, vehicle maintenance tips, online owner manual, special privileges, and more.

Sign up today at:

www.buickownercenter.com
(U.S.) or **www.gm.ca** (Canada).

OnStar®

If equipped, this vehicle has a comprehensive, in-vehicle system that can connect to a live Advisor for Emergency, Security, Navigation, Connection, and Diagnostic Services. See *OnStar Overview on page 14-1* for more information.

Keys, Doors, and Windows

Keys and Locks

Keys	2-2
Remote Keyless Entry (RKE) System	2-3
Remote Keyless Entry (RKE) System Operation	2-3
Remote Vehicle Start	2-5
Door Locks	2-8
Power Door Locks	2-8
Delayed Locking	2-9
Automatic Door Locks	2-9
Lockout Protection	2-9
Safety Locks	2-9

Doors

Liftgate	2-10
----------------	------

Vehicle Security

Vehicle Security	2-14
Anti-theft Alarm System	2-14
Immobilizer	2-15
Immobilizer Operation	2-15

Exterior Mirrors

Convex Mirrors	2-17
Power Mirrors	2-17
Folding Mirrors	2-18
Heated Mirrors	2-18
Automatic Dimming Mirror ...	2-18
Park Tilt Mirrors	2-19

Interior Mirrors

Automatic Dimming Rearview Mirror	2-19
--	------

Windows

Windows	2-20
Power Windows	2-20
Sun Visors	2-22

Roof

Sunroof	2-22
---------------	------

Keys and Locks

Keys

WARNING

Leaving children in a vehicle with the ignition key is dangerous for many reasons. Children or others could be badly injured or even killed. They could operate the power windows or other controls or even make the vehicle move. The windows will function with the keys in the ignition and children could be seriously injured or killed if caught in the path of a closing window. Do not leave the keys in a vehicle with children.



The key is used for the ignition and all door locks.

The key has a bar-coded key tag that the dealer or qualified locksmith can use to make new keys. Store this information in a safe place, not in the vehicle.

See your dealer if a replacement key or additional key is needed.

Notice: If the keys get locked in the vehicle, it may have to be damaged to get them out. Always carry a spare key.

If locked out of the vehicle, call Roadside Assistance. See *Roadside Assistance Program (U.S. and Canada)* on page 13-8 or *Roadside Assistance Program (Mexico)* on page 13-10.

With an active OnStar subscription, an OnStar Advisor may remotely unlock the vehicle. See *OnStar Overview* on page 14-1.

Remote Keyless Entry (RKE) System

See *Radio Frequency Statement* on page 13-23 for information regarding Part 15 of the Federal Communications Commission (FCC) rules and Industry Canada Standards RSS-GEN/210/220/310.

If there is a decrease in the RKE operating range:

- Check the distance. The transmitter may be too far from the vehicle.
- Check the location. Other vehicles or objects may be blocking the signal.

- Check the transmitter's battery. See "Battery Replacement" later in this section.
- If the transmitter is still not working correctly, see your dealer or a qualified technician for service.

Remote Keyless Entry (RKE) System Operation

The Remote Keyless Entry (RKE) transmitter functions work up to 60 m (195 ft) away from the vehicle.

There are other conditions which can affect the performance of the transmitter. See *Remote Keyless Entry (RKE) System* on page 2-3.





With Remote Start and Power Liftgate Shown, Without Similar



⌚ (Remote Vehicle Start): For vehicles with this feature, see *Remote Vehicle Start* on page 2-5 for additional information.

2-4 Keys, Doors, and Windows

 **(Lock):** Press to lock all the doors.

If enabled through the Driver Information Center (DIC), the parking lamps flash once to indicate locking has occurred. If enabled through the DIC, the horn sounds when  is pressed again within five seconds. See *Vehicle Personalization* on page 5-41 for additional information.

Pressing  may arm the content theft-deterrent system. See *Anti-theft Alarm System* on page 2-14.



 **(Unlock):** Press once to unlock only the driver door. If  is pressed again within five seconds, all remaining doors unlock. The interior lamps come on and stay on for 20 seconds or until the ignition is turned on.

If enabled through the DIC, the parking lamps flash twice to indicate unlocking has occurred. See *Vehicle Personalization* on page 5-41.

Pressing  on the RKE transmitter disarms the content theft-deterrent system. See *Anti-theft Alarm System* on page 2-14.

 **(Power Liftgate):** Press and hold until the liftgate begins to move to open or close the liftgate. The taillamps flash and a chime sounds to indicate when the liftgate is opening or closing.

 **(Vehicle Locator/Panic Alarm):** Press and release to locate the vehicle. The parking lamps flash and the horn sounds three times.

Press and hold  for more than two seconds to activate the panic alarm. The parking lamps flash and the horn sounds repeatedly for 30 seconds. The alarm turns off when the ignition is moved to ON/RUN or  is pressed again. The ignition must be in LOCK/OFF for the panic alarm to work.

Programming Transmitters to the Vehicle

Only RKE transmitters programmed to this vehicle will work. If a transmitter is lost or stolen, a replacement can be purchased and programmed through your dealer. When the replacement transmitter is programmed to this vehicle, all remaining transmitters must also be reprogrammed.

Any lost or stolen transmitters will no longer work once the new transmitter is programmed. Each vehicle can have up to eight transmitters programmed to it. See your dealer to program transmitters to this vehicle.

Battery Replacement

Replace the battery if the REPLACE BATTERY IN REMOTE KEY message displays in the DIC.

Notice: When replacing the battery, do not touch any of the circuitry on the transmitter. Static from your body could damage the transmitter.

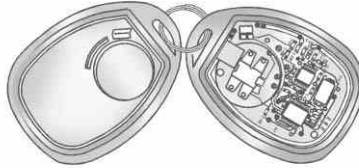

1. Separate the transmitter with a flat, thin object, such as a flat head screwdriver.
 - Carefully insert the tool into the notch located along the parting line of the transmitter. Do not insert the tool too far. Stop as soon as resistance is felt.
 - Twist the tool until the transmitter is separated.

2. Remove the old battery. Do not use a metal object.
3. Insert the new battery, positive side facing down. Replace with a CR2032 or equivalent battery.
4. Snap the transmitter back together.

Remote Vehicle Start

This vehicle may have a remote starting feature that starts the engine from outside of the vehicle.

Q (Remote Start): This button is located on the RKE transmitter if the vehicle has remote start.

Laws in some communities may restrict the use of remote starters. For example, some laws may require a person using the remote start to have the vehicle in view when doing so. Check local regulations for any requirements on remote starting of vehicles.

2-6 Keys, Doors, and Windows



Do not use the remote start feature if the vehicle is low on fuel. The vehicle could run out of fuel.

If the vehicle has the remote start feature, the RKE transmitter functions have an increased range of operation. However, the range may be less while the vehicle is running.

There are other conditions that can affect the performance of the transmitter. See *Remote Keyless Entry (RKE) System on page 2-3* for additional information.

Starting the Engine Using Remote Start

To start the vehicle:

1. Aim the RKE transmitter at the vehicle.
2. Press and release  on the RKE transmitter.
3. Immediately after completing Step 2, press and hold  until the parking lamps flash. If the vehicle's lights cannot be seen, press and hold  for at least four seconds.

When the vehicle starts, the parking lamps will turn on and remain on as long as the engine is running. The doors will be locked and the climate control system will operate automatically if the vehicle has the automatic system, or at the same setting as when the vehicle was last turned off.

If the vehicle has an automatic climate control system and heated seats, the heated seats turn on during colder outside temperatures and shut off when the key is turned to ON/RUN. See *Heated and Ventilated Front Seats on page 3-8* for more information.

The rear window defogger and heated mirrors, if the vehicle has them, turn on during colder outside temperatures and turn off when the key is turned to ON/RUN.



After entering the vehicle during a remote start, insert and turn the key to the ON/RUN position to drive the vehicle.

If the vehicle is left running it automatically shuts off after 10 minutes unless a time extension has been done.

Extending Engine Run Time

To extend the engine run time by 10 minutes, repeat Steps 1 through 3 while the engine is still running. The engine run time can only be extended if it is the first remote start since the vehicle has been driven. Remote start can be extended one time.

If the remote start procedure is used again before the first 10-minute time frame has ended, the first 10 minutes will immediately expire and the second 10-minute time frame will start.

For example, if  and then  are pressed again after the vehicle has been running for five minutes, 10 minutes are added, allowing the engine to run for a total of 15 minutes.

A maximum of two remote starts or remote start attempts are allowed between ignition cycles.

After the vehicle's engine has been started two times using the remote start button, the ignition must be turned on and then back off before the remote start procedure can be used again.

Shutting the Engine Off After a Remote Start

To manually shut off a remote start:

- Aim the RKE transmitter at the vehicle and press  until the parking lamps turn off.
- Turn on the hazard warning flashers.
- Turn the ignition switch on and then off.

Conditions in Which the Remote Start Will Not Work

The vehicle cannot be started using the remote start feature if the key is in the ignition, the hood is open, or if there is an emission control system malfunction.

The engine turns off during a remote start if the coolant temperature gets too high or if the oil pressure gets low.

Door Locks

WARNING

Unlocked doors can be dangerous.



- Passengers, especially children, can easily open the doors and fall out of a moving vehicle. When a door is locked, the handle will not open it. The chance of being thrown out of the vehicle in a crash is increased if the doors are not locked. So, all passengers should wear safety belts properly and the doors should be locked whenever the vehicle is driven.

(Continued)

WARNING (Continued)

- Young children who get into unlocked vehicles may be unable to get out. A child can be overcome by extreme heat and can suffer permanent injuries or even death from heat stroke. Always lock the vehicle whenever leaving it.
- Outsiders can easily enter through an unlocked door when you slow down or stop the vehicle. Locking the doors can help prevent this from happening.

To lock or unlock a door manually:

- From the inside, use the door lock knob on the window sill.
- From the outside, turn the key toward the front or rear of the vehicle, or press the  or  button on the Remote Keyless Entry (RKE) transmitter.

Power Door Locks

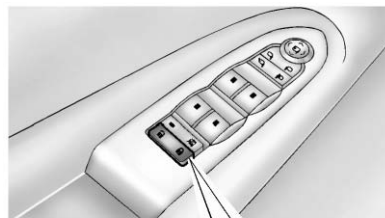

 (Unlock): Press to unlock the doors.

 (Lock): Press to lock the doors.

Delayed Locking

When locking the doors with the power lock switch and a door or the liftgate is open, the doors will lock five seconds after the last door is closed. You will hear three chimes to signal that the delayed locking feature is in use.

Pressing the power lock switch twice or the lock button on the RKE transmitter twice will override the delayed locking feature and immediately lock all the doors.

This feature will not operate if the key is in the ignition.

This feature can be programmed by using the Driver Information Center (DIC). See “DELAY DOOR LOCK” under *Vehicle Personalization on page 5-41*.

Automatic Door Locks

Vehicles with an automatic lock/unlock feature enable you to program the vehicle’s power door locks. This feature can be programmed through the Driver Information Center (DIC). See *Vehicle Personalization on page 5-41* for more information.

Lockout Protection

This feature protects you from locking the key in the vehicle when the key is in the ignition and a front door is open.

If the driver side power door lock switch is pressed when the driver door is open and the key is in the ignition, all of the doors will lock and then the driver door will unlock.

If the passenger side power door lock switch is pressed when the front passenger door is open and the key is in the ignition, all of the doors will lock and then the front passenger door will unlock.

Safety Locks

The vehicle has rear door security locks to prevent passengers from opening the rear doors from the inside.

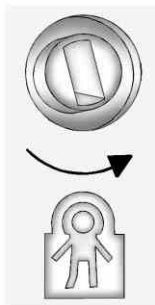

Open the rear doors to access the security locks on the inside edge of each door.

To set the locks, insert a key into the slot and turn it to the horizontal position. The door can only be opened from the outside with the door unlocked. To return the door to normal operation, turn the slot to the vertical position.

Doors

Liftgate

Manual Liftgate Operation

WARNING

Exhaust gases can enter the vehicle if it is driven with the liftgate or trunk/hatch open, or with any objects that pass through the seal between the body and the trunk/hatch or liftgate. Engine exhaust contains carbon monoxide (CO) which cannot be seen or smelled. It can cause unconsciousness and even death.

If the vehicle must be driven with the liftgate or trunk/hatch open:

- Close all of the windows.
- Fully open the air outlets on or under the instrument panel.

(Continued)

WARNING (Continued)

- Adjust the Climate Control system to a setting that brings in only outside air and set the fan speed to the highest setting. See “Climate Control Systems” in the Index.
- If the vehicle is equipped with a power liftgate, disable the power liftgate function.

For more information about carbon monoxide, see *Engine Exhaust* on page 9-24.

To unlock the liftgate, use the power door lock switch or press the door unlock button on the RKE transmitter twice. See *Remote Keyless Entry (RKE) System Operation* on page 2-3.

To open the liftgate, press the touchpad under the liftgate handle. The vehicle must be in P (Park) to open the liftgate. To close the liftgate, use the pull cup or pull strap as an aid.

The liftgate will not open if the battery is disconnected or has low voltage. The liftgate will resume operation when the battery is reconnected and charged.

If the battery is properly connected and has adequate voltage, and the liftgate still will not function, the vehicle should be taken to a dealer for service.

Power Liftgate Operation

The vehicle may have a power liftgate. The vehicle must be in P (Park) to use this feature.

The taillamps will flash and a chime will sound when the power liftgate is used.

WARNING

You or others could be injured if caught in the path of the power liftgate. Make sure there is no one in the way of the liftgate as it is opening and closing.

Notice: If you open the liftgate without checking for overhead obstructions such as a garage door, you could damage the liftgate or the liftgate glass. Always check to make sure the area above and behind the liftgate is clear before opening it.

The power liftgate can be power opened and closed in the following ways:

- Press and hold the power liftgate button on the RKE transmitter. See *Remote Keyless Entry (RKE) System Operation* on page 2-3 for more information.

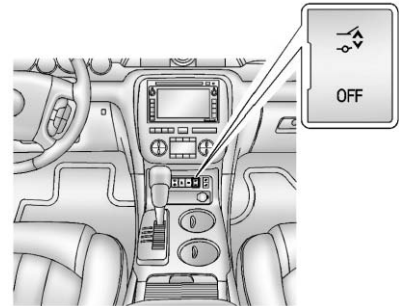

- Press the liftgate button on the center console.
- Press the touchpad on the outside liftgate handle.

2-12 Keys, Doors, and Windows

Pressing the buttons or touchpad a second time while the liftgate is moving reverses the direction.

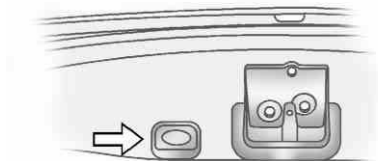

Power Liftgate Button near Liftgate Latch

The liftgate can also be closed by pressing the power liftgate button next to the liftgate latch. Press the button a second time during liftgate operation to reverse that operation.

The power liftgate may be temporarily disabled under extreme temperatures or under low battery conditions. If this occurs, the liftgate can still be operated manually.

If the transmission is shifted out of P (Park) while the power function is in progress, the liftgate power function will continue to completion. If the transmission is shifted out of P (Park) and the vehicle accelerates before the power liftgate latches closed, the liftgate may reverse to the open position. Cargo could fall out of the vehicle. Always make sure the power liftgate is closed and latched before you drive away.

If you power open the liftgate and the liftgate support struts have lost pressure, the lights will flash and a chime will sound. The liftgate will stay open temporarily, then slowly close. See your dealer for service before using the liftgate if this occurs.

Obstacle Detection Features

A warning chime will sound and the liftgate will automatically reverse direction to the full closed or open position if the liftgate encounters an obstacle during a power open or close cycle. After removing the obstruction, the power liftgate operation can be used again.

If the liftgate comes across more obstacles on the same power cycle, the power function deactivates, and you must manually open or close the liftgate. A message displays, LIFTGATE OPEN, to indicate that the liftgate is open. See *Driver Information Center (DIC)* on page 5-27 for more information.

After removing the obstructions, manually open the liftgate to the full open position or close the liftgate to the fully closed and latched position. The liftgate resumes normal power operation.

The vehicle has pinch sensors located on the side edges of the liftgate. If an object is caught between the liftgate and the body and presses against this sensor, the liftgate will reverse direction and open fully. The liftgate will remain open until it is activated again or closed manually. Do not force the liftgate open or closed during a power cycle.

Manual Operation of Power Liftgate

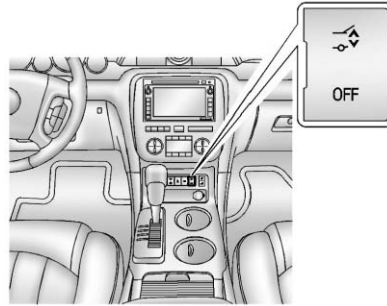

To change the liftgate to manual operation, press the switch on the center console to the OFF position. A message displays, POWER LIFTGATE OFF, to indicate that the liftgate is manual operation mode. See *Driver Information Center (DIC)* on page 5-27 for more information.

With the power liftgate disabled and all of the doors unlocked, the liftgate can be manually opened and closed.

To open the liftgate, press the touchpad on the handle on the outside of the liftgate and lift the gate open. To close the liftgate, use the pull cup to lower the liftgate and close. The liftgate latch will power close. Always close the liftgate before driving.

If the RKE button or the power close button on the liftgate is pressed while power operation is disabled, the lights will flash three times, but the liftgate will not move.

It is not recommended that you drive with the liftgate open. However, if you must drive with the liftgate open, the liftgate should be set to manual operation by pressing the OFF switch on the center console.

Vehicle Security

This vehicle has theft-deterrent features; however, they do not make it impossible to steal.

Anti-theft Alarm System

On vehicles with an anti-theft alarm system, to activate the system:

- Press  on the Remote Keyless Entry (RKE) transmitter or the power door lock switch when any door is open.



The security light flashes.

When the door is closed, the security light stops flashing and stays on solid for approximately 30 seconds.

The content theft-deterrent alarm is not armed until the security light goes off.

If the delayed locking feature is active, the alarm is not activated until all doors are closed and the security light goes off.

- Press  when the driver door is closed. The security light comes on solid for approximately 30 seconds and then goes off. The content theft-deterrent alarm is not armed until the security light goes off.

The theft-deterrent system will not activate if the doors are locked with the vehicle's key or the manual door lock.

If a locked door is opened without using the RKE transmitter, a 10-second pre-alarm occurs. The horn chirps and the lights flash.

If the key is not placed in the ignition and turned to START or the door is not unlocked by pressing  during the 10-second pre-alarm, the alarm goes off. The headlamps flash and the horn sounds for about 30 seconds, then turns off to save the battery power.

The vehicle can be started with the correct ignition key if the alarm has been set off.

To avoid setting off the alarm by accident:

- Lock the vehicle with the door key after the doors are closed.
- Unlock the door with the RKE transmitter. Unlocking a door any other way sets off the alarm if the system has been armed.

Press  or place the key in the ignition and turn it to START to turn off the alarm.

Testing the Alarm

To test the alarm:

1. From inside the vehicle, lower the driver side window, and open the driver door.
2. Press .
3. Get out of the vehicle, close the door, and wait for the security light to go out.
4. Reach in through the window, unlock the door with the manual door lock, and open the door. This should set off the alarm.

If the alarm does not sound when it should, but the headlamps flash, check to see if the horn works.

The horn fuse may be blown.

To replace the fuse, see *Fuses and Circuit Breakers on page 10-32*.

If the alarm does not sound or the headlamps do not flash, see your dealer for service.

Immobilizer

See *Radio Frequency Statement on page 13-23* for information regarding Part 15 of the Federal Communications Commission (FCC) rules and Industry Canada Standards RSS-GEN/210/220/310.

Immobilizer Operation

This vehicle has PASS-Key® III+ (Personalized Automotive Security System) theft-deterrent system. PASS-Key III+ is a passive theft-deterrent system.

The system is automatically armed when the key is removed from the ignition.

The system is automatically disarmed when the key is turned to ON/RUN, ACC/ACCESSORY, or START from the LOCK/OFF position.

You do not have to manually arm or disarm the system.

The security light comes on if there is a problem with arming or disarming the theft-deterrent system.

When the PASS-Key III+ system senses an incorrect key, the vehicle does not start. Anyone using a trial-and-error method to start the vehicle will be discouraged because of the high number of electrical key codes.

If the engine does not start and the security light on the instrument panel comes on when trying to start the vehicle, there may be a problem with the theft-deterrent system. Turn the ignition off and try again.

2-16 Keys, Doors, and Windows

If the engine still does not start, and the key appears to be undamaged, try another ignition key and check the fuses. See *Fuses and Circuit Breakers on page 10-32* for additional information. If the engine still does not start with the other key, the vehicle needs service. If the vehicle does start, the first key may be faulty. See your dealer who can service the PASS-Key III+ to have a new key made. In an emergency, contact Roadside Assistance. See *Roadside Assistance Program (U.S. and Canada) on page 13-8* or *Roadside Assistance Program (Mexico) on page 13-10*.

It is possible for the PASS-Key III+ decoder to learn the transponder value of a new or replacement key. Up to 10 keys may be programmed to the vehicle. The following procedure is for programming additional keys only. If all currently programmed keys are lost or do not operate, you must see your dealer or a locksmith who can service PASS-Key III+ to have keys made and programmed to the system.

See your dealer or a locksmith who can service PASS-Key III+ to get a new key blank that is cut exactly as the ignition key that operates the system.

To program the new additional key:

1. Verify that the new key has a ⊕ stamped on it.
2. Insert the already programmed key in the ignition and start the engine. If the engine does not start, see your dealer for service.
3. After the engine has started, turn the key to LOCK/OFF, and remove the key.

4. Insert the key to be programmed and turn it to the ON/RUN position within five seconds of the original key being turned to the LOCK/OFF position.

The security light turns off once the key has been programmed.

5. Repeat Steps 1 through 4 if additional keys are to be programmed.

If the PASS-Key III+ key is lost or damaged, see your dealer or a locksmith to have a new key made.

The SERVICE THEFT DETERRENT SYSTEM message displays on the Driver Information Center (DIC) when there is a problem with the theft-deterrent system. See *Anti-theft Alarm System Messages on page 5-37* for additional information.

Do not leave the key or device that disarms or deactivates the theft-deterrent system in the vehicle.

Exterior Mirrors

Convex Mirrors

WARNING

A convex mirror can make things, like other vehicles, look farther away than they really are. If you cut too sharply into the right lane, you could hit a vehicle on the right. Check the inside mirror or glance over your shoulder before changing lanes.

The passenger side mirror is convex shaped. A convex mirror's surface is curved so more can be seen from the driver seat.

Power Mirrors

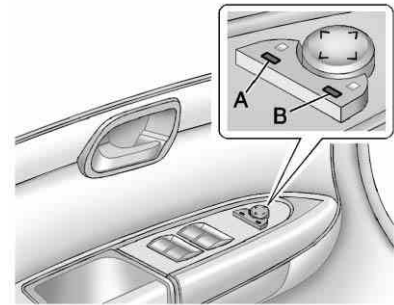

Controls for the outside power mirrors are located on the driver door.

To adjust each mirror:

1. Press (A) or (B) to select the mirror.
2. Press on the control pad to adjust the mirror.
3. Press (A) or (B) again to deselect the mirror.

Folding Mirrors

For vehicles with manual folding mirrors, push the mirror toward the vehicle. Pull the mirror out to return to its original position.

For vehicles with outside power foldaway mirrors:

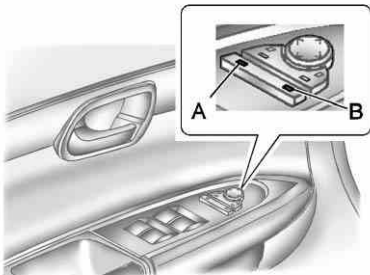

1. Press (A) to fold the mirrors out to the driving position.
2. Press (B) to fold the mirrors in to the folded position.

Resetting the Power Foldaway Mirrors

Reset the power foldaway mirrors if:

- The mirrors are accidentally obstructed while folding.
- They are accidentally manually folded/unfolded.
- The mirrors vibrate at normal driving speeds.

Fold and unfold the mirrors one time using the mirror controls to reset them to their normal position.

A popping noise may be heard during the resetting of the power foldaway mirrors. This sound is normal after a manual folding operation.

Heated Mirrors

For vehicles with heated mirrors:

 **(Rear Window Defogger):**
Press to heat the mirrors.

See "Rear Window Defogger" under *Dual Automatic Climate Control System* on page 8-1 for more information.

Automatic Dimming Mirror

If the vehicle has the automatic dimming mirror, the driver outside mirror automatically adjusts for the glare of headlamps behind you. This feature is controlled by the on and off setting on the inside rearview mirror. See *Automatic Dimming Rearview Mirror* on page 2-19 for more information.

Park Tilt Mirrors

If the vehicle has the memory package, the outside mirrors have a park tilt feature. This feature tilts the outside mirrors to a preselected position when the vehicle is in R (Reverse). This allows the driver to view the curb for parallel parking.

The passenger and/or driver mirror returns to its original position when the vehicle is shifted out of R (Reverse), or the ignition is turned off or to OFF/LOCK.

This feature can be turned on or off through the Driver Information Center (DIC). See *Vehicle Personalization on page 5-41* for more information.

Interior Mirrors

Automatic Dimming Rearview Mirror

The vehicle may have an automatic dimming inside rearview mirror.

Automatic dimming reduces the glare from the headlamps of the vehicle behind you. The dimming feature comes on and the indicator light illuminates each time the ignition is turned to start.

 **(On/Off):** Press to turn the dimming feature on or off.

The vehicle may also have a Rear Vision Camera (RVC). See *Rear Vision Camera (RVC) on page 9-38* for more information.

If the vehicle has a RVC, the  button for turning the dimming feature on or off will not be available.

Vehicles with OnStar have three additional control buttons for the OnStar system. See *OnStar Overview on page 14-1*.

Cleaning the Mirror

Do not spray glass cleaner directly on the mirror. Use a soft towel dampened with water.

Windows

WARNING

Leaving children, helpless adults, or pets in a vehicle with the windows closed is dangerous. They can be overcome by the extreme heat and suffer permanent injuries or even death from heat stroke. Never leave a child, a helpless adult, or a pet alone in a vehicle, especially with the windows closed in warm or hot weather.



The vehicle aerodynamics are designed to improve fuel economy performance. This may result in a pulsing sound when either rear window is down and the front windows are up. To reduce the sound, open either a front window or the sunroof (if equipped).

Power Windows

WARNING

Leaving children in a vehicle with the keys is dangerous for many reasons. Children or others could be badly injured or even killed. They could operate the power windows or other controls or even make the vehicle move. The windows will function and they could be seriously injured or killed if caught in the path of a closing window. Do not leave keys in a vehicle with children. When there are children in the rear seat use the window lockout button to prevent unintentional operation of the windows.

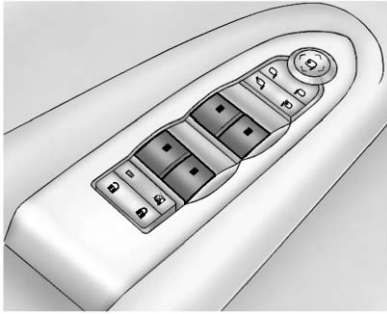

Uplevel Shown, Base Similar

The driver door also has switches that control the passenger and rear windows. The power windows work with the ignition in ACC/ACCESSORY, ON/RUN or when Retained Accessory Power (RAP) is active. See *Retained Accessory Power (RAP)* on page 9-21.

Press the switch to lower the window. Pull up on the front edge of the switch to raise the window.

Express-Up/Express-Down Windows

A window with the express-up/down feature allows it to be raised or lowered without holding the switch. Press or pull the window switch fully and release it to activate the express feature. The express mode can be canceled by pressing or pulling the switch.

Programming the Power Windows

If the battery on the vehicle has been recharged, disconnected, or replaced, windows with the express-up feature need to be reprogrammed for this feature to work. To program the window:

1. Close all doors with the ignition in the ACC/ACCESSORY, ON/RUN position, or when Retained Accessory Power (RAP) is active. See *Retained Accessory Power (RAP)* on page 9-21.

2. Press and continue to hold the window switch until the window is fully open.
3. Pull up and hold the window switch to close the window. Continue to hold it briefly after the window is fully closed.
4. Repeat for each window that has the express-up feature.

Anti-Pinch Feature

The anti-pinch feature is on windows with the express-up feature. If an object is in the way of the window as it is express-closing, or in certain weather conditions like severe icing, the window will stop and open to a factory preset position. The window functions normally once the obstruction is removed.

Rear Window Lockout

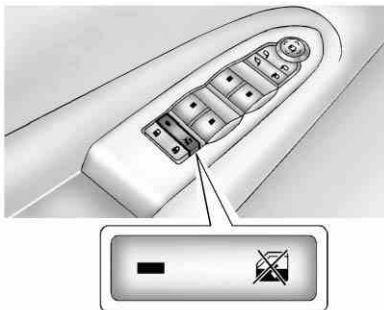

The rear window lockout feature prevents the rear passenger windows from operating, except from the driver position.

Press  to activate the rear window lockout switch. The LED light comes on when activated.

Press  again to deactivate the lockout switch.

Sun Visors

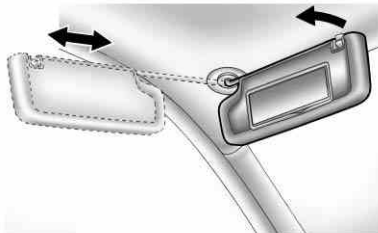

Pull the sun visor down to block glare. Detach the sun visor from the center mount to pivot to the side window, or to extend along the rod, if available.

Roof

Sunroof

The ignition must be in ON/RUN or ACC/ACCESSORY to operate the sunroof and power sunshade. See *Retained Accessory Power (RAP)* on page 9-21.

The vehicle may have a sunroof over the front seats and a rear sunroof over the second row seats. The rear sunroof does not open.

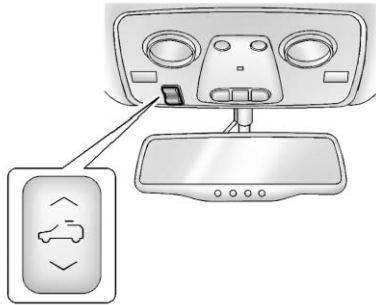

The switch to operate the front sunroof is on the headliner above the rearview mirror.

Vent: From the closed position, press and hold the front of the switch to vent the sunroof. Press and hold the rear of the switch to close the sunroof.

Express-open/Express-close:

From the closed position, press and release the rear of the switch to express-open the sunroof. Press and release the front of the switch to express-close the sunroof.

Manual Sunshade

The front sunshade must be opened and closed manually. To open the sunshade, press the button on the sunshade handle to release it and guide it back. To close the sunshade, pull the sunshade forward until it latches.

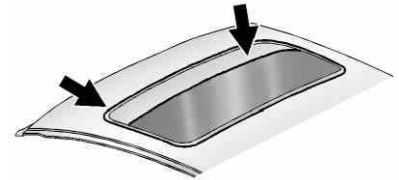

Do not keep the sunroof open for long periods of time while the vehicle is not in use. Dirt and debris may collect on the sunroof seal or in the track. This could cause an issue with sunroof operation, noise, or plugging the water drainage system. Periodically open the sunroof and remove any obstacles or loose debris. Wipe the sunroof seal and roof sealing area using a clean cloth, mild soap, and water. Do not remove grease from the sunroof.

Seats and Restraints

Head Restraints

Head Restraints 3-2

Front Seats

Power Seat Adjustment 3-3

Lumbar Adjustment 3-4

Reclining Seatbacks 3-4

Memory Seats 3-6

Heated and Ventilated Front Seats 3-8

Rear Seats

Rear Seats 3-9

Third Row Seats 3-11

Safety Belts

Safety Belts 3-14

How to Wear Safety Belts

Properly 3-15

Lap-Shoulder Belt 3-16

Safety Belt Use During Pregnancy 3-21

Safety Belt Extender 3-22

Safety System Check 3-22

Safety Belt Care 3-22

Replacing Safety Belt System
Parts after a Crash 3-23

Airbag System

Airbag System 3-23

Where Are the Airbags? 3-25

When Should an Airbag
Inflate? 3-27

What Makes an Airbag
Inflate? 3-28

How Does an Airbag
Restrain? 3-28

What Will You See after an
Airbag Inflates? 3-29

Passenger Sensing
System 3-31

Servicing the Airbag-Equipped
Vehicle 3-36

Adding Equipment to the
Airbag-Equipped Vehicle ... 3-36

Airbag System Check 3-37

Replacing Airbag System
Parts after a Crash 3-38

Child Restraints

Older Children 3-38

Infants and Young
Children 3-41

Child Restraint Systems 3-43

Where to Put the Restraint ... 3-45

Lower Anchors and Tethers
for Children (LATCH
System) 3-47

Replacing LATCH System
Parts After a Crash 3-54

Securing Child Restraints
(Rear Seat) 3-55

Securing Child Restraints
(Right Front
Passenger Seat) 3-57

3-2 Seats and Restraints

Head Restraints

The vehicle's front seats have adjustable head restraints in the outboard seating positions.

WARNING

With head restraints that are not installed and adjusted properly, there is a greater chance that occupants will suffer a neck/spinal injury in a crash. Do not drive until the head restraints for all occupants are installed and adjusted properly.



Adjust the head restraint so that the top of the restraint is at the same height as the top of the occupant's head. This position reduces the chance of a neck injury in a crash.

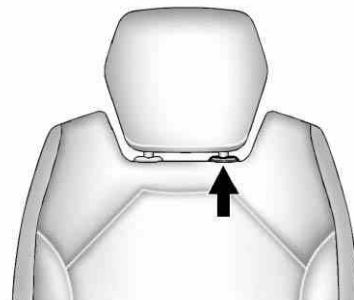

1. Pull the head restraint up to raise it. To lower the head restraint, press the release button, located on the head restraint post on the top of the seatback, while you push the head restraint down.
2. Push down on the head restraint after the button is released to make sure that it is locked in place.

The vehicle's second-row seats have head restraints in the outboard seating positions that cannot be adjusted.

The vehicle's third-row seats have headrests in the outboard seating positions that cannot be adjusted.

The vehicle's head restraints and headrests are not designed to be removed.

Front Seats

Power Seat Adjustment

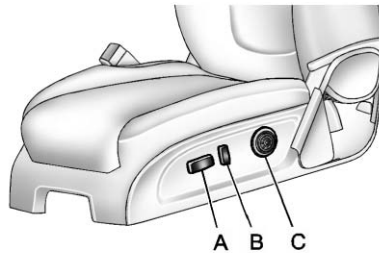

- A. Seat Adjustment Control
- B. Reclining Seatback Control
- C. Lumbar Adjustment Control

- Move the seat forward or rearward by moving the control (A) forward or rearward.

- Raise or lower the front or rear part of the seat cushion by moving the front or rear of the control (A) up or down.
- Raise or lower the entire seat by moving the control (A) up or down.

To raise or recline the seatback, tilt the top of the control (B) forward or rearward. See *Reclining Seatbacks* on page 3-4.

Press the front or rear of the control (C) to increase or decrease lumbar support. See *Lumbar Adjustment* on page 3-4.

3-4 Seats and Restraints

Lumbar Adjustment

Manual Lumbar

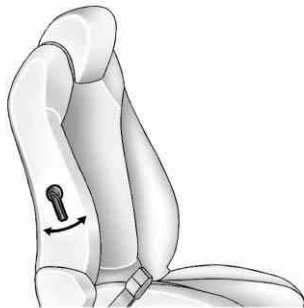

If available, move the handle forward or rearward to increase or decrease lumbar support.

Power Lumbar

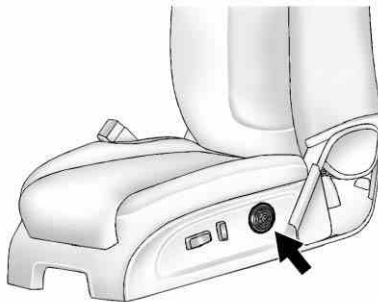

If available, press and hold the front or rear of control to increase or decrease lumbar support. Release the control when the seatback reaches the desired level of lumbar support.

Reclining Seatbacks

Power Reclining Seatbacks

WARNING

You can lose control of the vehicle if you try to adjust the seat while the vehicle is moving. The sudden movement could startle and confuse you, or make you push a pedal when you do not want to. Adjust the driver seat only when the vehicle is not moving.

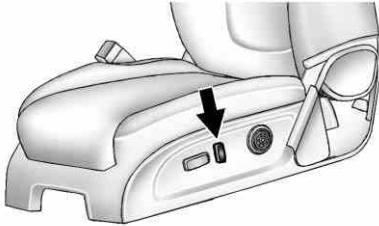

To adjust the seatback:

- Tilt the top of the control rearward to recline.
- Tilt the top of the control forward to raise.

⚠ WARNING

Sitting in a reclined position when the vehicle is in motion can be dangerous. Even when buckled up, the safety belts cannot do their job when reclined like this.

The shoulder belt cannot do its job because it will not be against your body. Instead, it will be in front of you. In a crash, you could go into it, receiving neck or other injuries.

The lap belt cannot do its job either. In a crash, the belt could go up over your abdomen. The belt forces would be there, not at your pelvic bones. This could cause serious internal injuries.

For proper protection when the vehicle is in motion, have the seatback upright. Then sit well back in the seat and wear the safety belt properly.



Do not have a seatback reclined if the vehicle is moving.

Memory Seats

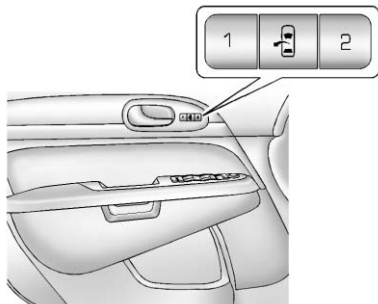

On vehicles with the memory feature, the controls on the driver door are used to program and recall memory settings for the driver seat, outside mirrors, and power steering column, if available.

Storing Memory Positions

To save into memory:

1. Adjust the driver seat and seatback recliner, both outside mirrors, and the power steering column, if available.

See *Power Mirrors* on page 2-17 and *Steering Wheel Adjustment* on page 5-2 for more information.

Not all vehicles will have the ability to save and recall the mirror positions.

2. Press and hold “1” until two beeps sound.
3. Repeat for a second driver position using “2.”

To recall, press and release “1” or “2.” The vehicle must be in P (Park). A single beep will sound. The seat, outside mirrors, and power steering column, if available, will move to the positions previously stored for the identified driver.

Memory Remote Recall

The memory feature can recall the driver seat, outside mirrors, and power steering column, if available, to stored positions when entering the vehicle.

To activate, unlock the driver door with the Remote Keyless Entry (RKE) transmitter. The driver seat, outside mirrors, and power steering column will move to the memory positions associated with the transmitter used to unlock the vehicle.

This feature is turned on or off using the vehicle personalization menu. See “Memory Seat Recall” under *Vehicle Personalization* on page 5-41 for more information.

To stop recall movement, press one of the power seat controls, memory buttons, power mirror buttons, or the power steering column control, if available.

If something has blocked the driver seat and/or steering column while recalling a memory position, the recall may stop. Remove the obstruction; then press and hold the appropriate manual control for the memory item that is not recalling for two seconds. Try recalling the memory position again by pressing the appropriate memory button. If the memory position is still not recalling, see your dealer for service.

Easy Exit Positions

The easy exit feature can move the driver seat rearward and the power steering column, if available, up and forward to allow extra room to exit the vehicle.

 **(Easy Exit Positions):** Press to recall the easy exit positions. The vehicle must be in P (Park).

If the easy exit feature is programmed on in the vehicle personalization menu, automatic driver seat and power steering column movement occur when the ignition key is removed.

A single beep sounds. The driver seat moves back approximately 8 cm (3 in) and the power steering

column, if available, moves up and forward. To move the seat back farther, press the easy exit seat button again until the seat is all the way back.

If something has blocked the driver seat while recalling the exit position, the recall may stop. Remove the obstruction; then press and hold the power seat control rearward for two seconds. Try recalling the exit position again. If the exit position is still not recalling, see your dealer for service.

See “Easy Exit Seat” under *Vehicle Personalization* on page 5-41 for more information.

Heated and Ventilated Front Seats

WARNING

If you cannot feel temperature change or pain to the skin, the seat heater may cause burns even at low temperatures.

To reduce the risk of burns, people with such a condition should use care when using the seat heater, especially for long periods of time. Do not place anything on the seat that insulates against heat, such as a blanket, cushion, cover, or similar item. This may cause the seat heater to overheat. An overheated seat heater may cause a burn or may damage the seat.

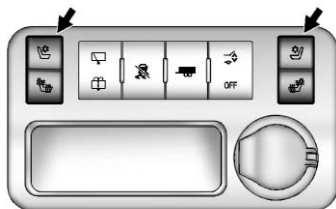

Heated and Cooled Seat Buttons Shown, Heated Seat Buttons Similar

If available, the buttons are on the center console. To operate, the engine must be running.

 **(Heated Seatback):** If available, press to heat the seatback only.

 **(Cooled Seat):** If available, press to cool the entire seat.

 **(Heated Seat and Seatback):** Press to heat the seat and seatback.

Press the button once for the highest setting. With each press of the button, the seat will change to the next lower setting, and then

to the off setting. The lights indicate three for the highest setting and one for the lowest.

The passenger heated seat may take longer to heat up.

The heated and/or cooled seats are canceled after the ignition is turned off.

Remote Start Heated Seats

When it is cold outside, the heated seats may turn on automatically during a remote vehicle start. The heated seats will be canceled when the ignition is turned on. Press the desired heated seat button to use the heated seats after the vehicle is started.

The heated seat button lights will not turn on during a remote start.

The temperature of an unoccupied seat may be reduced.

See *Remote Vehicle Start on page 2-5* for more information.

Rear Seats



- A. Seat Adjustment Handle
- B. Reclining Seatback Strap
- C. Sliding Seat Lever

Entering and Exiting the Third Row

WARNING

Using the third row seating position while the second row is folded, or folded and tumbled, could cause injury in a sudden stop or crash. Be sure to return the seat to the passenger seating position. Push and pull on the seat to make sure it is locked into place.

Notice: Folding a rear seat with the safety belts still fastened may cause damage to the seat or the safety belts. Always unbuckle the safety belts and return them to their normal stowed position before folding a rear seat.

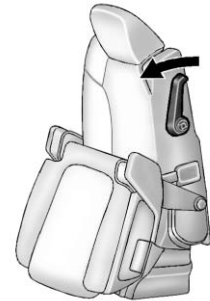

To access the third row:

1. Remove objects on the floor in front of or on the second row seat, or in the seat tracks on the floor.
2. Move the front center console armrest completely forward. See *Center Console Storage* on page 4-2.
3. Place the folding armrests in the upright position.

3-10 Seats and Restraints

4. Make sure that the safety belt is unfastened and in the stowed position.
5. Pull the sliding seat lever (C) forward and move the seatback forward. The seat cushion will fold, and the entire seat will slide forward. The head restraints will fold out of the way automatically.

Returning the Seat to the Seating Position

To return the second row seat to its normal seating position:

1. Remove objects on the floor behind the second row seat or in the seat tracks on the floor.
2. Pull the seatback rearward until it is locked in place.

3. Slide the seat rearward by pushing on the seatback until it is locked into place.
4. Return the head restraint to the upright position by reaching behind the seat and pulling the head restraint forward until it locks into place.

Push and pull on the head restraint to make sure that it is locked.

5. Push down on the rear of the seat cushion until it is locked in place.
6. Push and pull on the seatback and seat cushion to make sure they are locked in place.
7. Check that the safety belt is not under the seat cushion.

Reclining the Seatbacks

To recline the seatback:

1. Leaning forward in the seat, pull the reclining seatback strap (B).
2. Move the seatback to the desired position, and then release the strap to lock the seatback in place.
3. Push and pull on the seatback to make sure it is locked.

Folding the Seatback

To fold the second row seatbacks:

1. Remove anything on or under the seat.
2. Place the armrest in the upright position, and unfasten the safety belt.
3. Pull forward on the reclining seatback strap (B) and push down on the seatback.

The head restraint will fold down automatically.

To return the seatback to the seating position, lift the upper corner of the seatback and push it rearward until it locks into place. Push and pull on the seatback to make sure it is locked. Pull up on the head restraint to return it to the upright, locked position.

Adjusting the Seats

To adjust the second row seats, pull outward on the seat adjustment handle (A). Slide the seat forward or rearward to the desired position. Release the handle, and push and pull on the seat to make sure it is locked.

Third Row Seats

WARNING

Using the third row seating position while the second row is folded, or pushed forward in the entry position, could cause injury in a sudden stop or crash. Be sure to return the seat to the passenger seating position. Push and pull on the seat to make sure it is locked into place.

Folding the Seatback

Notice: Folding a rear seat with the safety belts still fastened may cause damage to the seat or the safety belts. Always unbuckle the safety belts and return them to their normal stowed position before folding a rear seat.

To fold the third row seatback:

1. Remove anything on or under the seat.

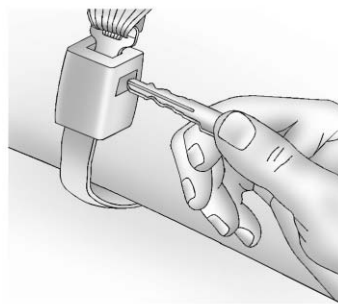

2. Disconnect the rear safety belt mini-latch using a key in the slot on the mini-buckle, and let the belt retract into the headliner. Stow the mini-latch in the holder in the headliner.

3-12 Seats and Restraints

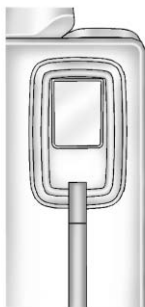

3. Pull up on the release lever on the back of the seat.
4. Push the seatback forward to lay flat.

Returning the Seat to the Seating Position

To return the seatback to the seating position:

1. From the rear of the vehicle, raise the seatback to the upright position using the pullstrap on the back of the third row seat, or lift the seatback and push it into place from inside the vehicle.

WARNING

If either seatback is not locked, it could move forward in a sudden stop or crash. That could cause injury to the person sitting there. Always push and pull on the seatbacks to be sure they are locked.

2. Push and pull on the seatback to make sure it is locked in place.

WARNING

A safety belt that is improperly routed, not properly attached, or twisted will not provide the protection needed in a crash. The person wearing the belt could be seriously injured. After raising the rear seatback, always check to be sure that the safety belts are properly routed and attached, and are not twisted.

3. Reconnect the center safety belt mini-latch to the mini-buckle. Do not let it twist.
4. Pull on the safety belt to be sure the mini-latch is secure.

Removing the Third Row Seats

To remove a third row seat:

1. Remove the cargo management system, if available and installed. See *Cargo Management System on page 4-4*.
2. Remove anything on or under the seat.

Notice: Folding a rear seat with the safety belts still fastened may cause damage to the seat or the safety belts. Always unbuckle the safety belts and return them to their normal stowed position before folding a rear seat.

3. Fold the seatback down. See “Folding the Seatback” earlier in this section.
4. Remove the rear bolts on the floor on each side of the seat.

5. Remove the seat by tilting it slightly upward, and then pulling it out of the rear of the vehicle in one motion.
6. Replace the bolts in the floor holes for storage.

Installing the Third Row Seats

To reinstall a third row seat:

1. Before installing the seat the seatback must be folded forward. See “Folding the Seatback” earlier in this section.

The seats must be placed in the proper locations to attach correctly. The wider seat must be installed on the driver side and the narrower seat on the passenger side. Remove the bolts from the holes in the floor before installing the seats.

2. Place the seat on the vehicle floor so that the front seat hooks are on the vehicle bars.
3. Reinstall the bolts, and torque to 55 N•m (41 lb ft). Pull up on the seat to make sure it is locked in place.
4. Raise the seatback to the upright position. Push and pull on the seatback to make sure it is locked into place.
5. Reconnect the center safety belt mini-latch to the mini-buckle. Do not let it twist.

Safety Belts

This section of the manual describes how to use safety belts properly. It also describes some things not to do with safety belts.

WARNING

Do not let anyone ride where a safety belt cannot be worn properly. In a crash, if you or your passenger(s) are not wearing safety belts, injuries can be much worse than if you are wearing safety belts. You can be seriously injured or killed by hitting things inside the vehicle harder or by being ejected from the vehicle. In addition, anyone who is not buckled up can strike other passengers in the vehicle.

(Continued)

WARNING (Continued)

It is extremely dangerous to ride in a cargo area, inside or outside of a vehicle. In a collision, passengers riding in these areas are more likely to be seriously injured or killed. Do not allow passengers to ride in any area of the vehicle that is not equipped with seats and safety belts.

Always wear a safety belt, and check that all passenger(s) are restrained properly too.

This vehicle has indicators as a reminder to buckle the safety belts. See *Safety Belt Reminders* on page 5-16 for additional information.

Why Safety Belts Work



When riding in a vehicle, you travel as fast as the vehicle does. If the vehicle stops suddenly, you keep going until something stops you. It could be the windshield, the instrument panel, or the safety belts!

When you wear a safety belt, you and the vehicle slow down together. There is more time to stop because you stop over a longer distance and, when worn properly, your strongest bones take the forces from the safety belts. That is why wearing safety belts makes such good sense.

Questions and Answers About Safety Belts

Q: Will I be trapped in the vehicle after a crash if I am wearing a safety belt?

A: You *could* be — whether you are wearing a safety belt or not. Your chance of being conscious during and after a crash, so you *can* unbuckle and get out, is *much* greater if you are belted.

Q: If my vehicle has airbags, why should I have to wear safety belts?

A: Airbags are supplemental systems only; so they work *with* safety belts — not instead of them. Whether or not an airbag is provided, all occupants still have to buckle up to get the most protection.

Also, in nearly all states and in all Canadian provinces, the law requires wearing safety belts.

How to Wear Safety Belts Properly

This section is only for people of adult size.

There are special things to know about safety belts and children. And there are different rules for smaller children and infants. If a child will be riding in the vehicle, see *Older Children on page 3-38* or *Infants and Young Children on page 3-41*. Follow those rules for everyone's protection.

It is very important for all occupants to buckle up. Statistics show that unbelted people are hurt more often in crashes than those who are wearing safety belts.

There are important things to know about wearing a safety belt properly.

3-16 Seats and Restraints

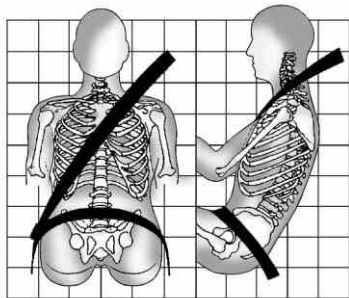

- Sit up straight and always keep your feet on the floor in front of you.
- Always use the correct buckle for your seating position.
- Wear the lap part of the belt low and snug on the hips, just touching the thighs. In a crash, this applies force to the strong pelvic bones and you would be less likely to slide under the lap belt. If you slid under it, the belt would apply force on your abdomen. This could cause serious or even fatal injuries.

- Wear the shoulder belt over the shoulder and across the chest. These parts of the body are best able to take belt restraining forces. The shoulder belt locks if there is a sudden stop or crash.

WARNING

You can be seriously injured, or even killed, by not wearing your safety belt properly.

- Never allow the lap or shoulder belt to become loose or twisted.
- Never wear the shoulder belt under both arms or behind your back.
- Never route the lap or shoulder belt over an armrest.

Lap-Shoulder Belt

All seating positions in the vehicle have a lap-shoulder belt.

If you are using a rear seating position with a detachable safety belt and the safety belt is not attached, see “Returning the Seat to the Seating Position” under *Third Row Seats on page 3-11* for instruction on reconnecting the safety belt to the mini-buckle.

The following instructions explain how to wear a lap-shoulder belt properly.

1. Adjust the seat, if the seat is adjustable, so you can sit up straight. To see how, see “Seats” in the Index.

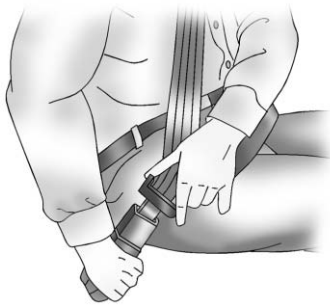

2. Pick up the latch plate and pull the belt across you. Do not let it get twisted.

The lap-shoulder belt may lock if you pull the belt across you very quickly. If this happens, let the belt go back slightly to unlock it. Then pull the belt across you more slowly.

If the shoulder portion of a passenger belt is pulled out all the way, the child restraint locking feature may be engaged. If this happens, let the belt go back all the way and start again.

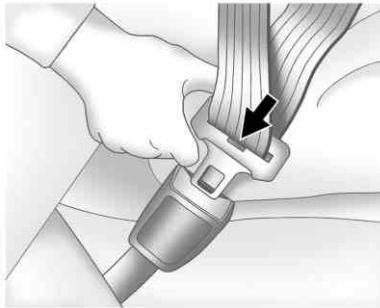

3. Push the latch plate into the buckle until it clicks.
4. Pull up on the latch plate to make sure it is secure. If the belt is not long enough, see *Safety Belt Extender* on page 3-22.

Position the release button on the buckle so that the safety belt could be quickly unbuckled if necessary.

5. If equipped with a shoulder belt height adjuster, move it to the height that is right for you. See "Shoulder Belt Height Adjuster" later in this section for instructions on use and important safety information.

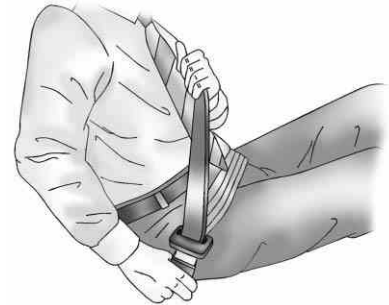

6. To make the lap part tight, pull up on the shoulder belt.

It may be necessary to pull the stitching on the safety belt through the latch plate to fully tighten the lap belt on smaller occupants.

3-18 Seats and Restraints



To unlatch the belt, push the button on the buckle. The belt should return to its stowed position. Slide the latch plate up the safety belt webbing when the safety belt is not in use. The latch plate should rest on the stitching on the safety belt, near the guide loop on the side wall.

Before a door is closed, be sure the safety belt is out of the way. If a door is slammed against a safety belt, damage can occur to both the safety belt and the vehicle.

Shoulder Belt Height Adjuster

The vehicle has a shoulder belt height adjuster for the driver and right front passenger seating positions.

Adjust the height so the shoulder portion of the belt is on the shoulder but not falling off of it. The belt should be close to but not contacting the neck. Improper shoulder belt height adjustment could reduce the effectiveness of the safety belt in a crash. See *How to Wear Safety Belts Properly* on page 3-15.

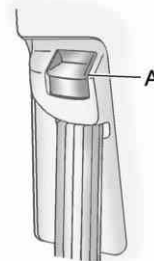

To move it down, push down on the release button (A) and move the height adjuster to the desired position. You can move the height adjuster up by pushing up on the shoulder belt guide.

After the adjuster is set to the desired position, try to move it down without pushing the release button to make sure it has locked into position.

Safety Belt Pretensioners

This vehicle has safety belt pretensioners for the front outboard occupants. Although the safety belt pretensioners cannot be seen, they are part of the safety belt assembly. They can help tighten the safety belts during the early stages of a moderate to severe frontal, near frontal, or rear crash if the threshold conditions for pretensioner activation are met. And, for vehicles with side impact airbags, safety belt pretensioners can help tighten the safety belts in a side crash or a rollover event.

Pretensioners work only once. If the pretensioners activate in a crash, they will need to be replaced, and probably other new parts for the vehicle's safety belt system. See *Replacing Safety Belt System Parts after a Crash* on page 3-23.

Rear Safety Belt Comfort Guides

This vehicle may have rear safety belt comfort guides. If not, they are available through your dealer. The guides may provide added safety belt comfort for older children who have outgrown booster seats and for some adults. When installed and properly adjusted, the comfort guide positions the shoulder belt away from the neck and head.

Here is how to install a comfort guide to the safety belt:



Outboard Positions

1. For the outboard positions, remove the guide from its storage clip on the interior body.

For the third row center position, locate the comfort guide which is located in a storage pocket, at the top of the seat, under the headrest on the driver's side of the vehicle.

3-20 Seats and Restraints

To access the comfort guide, you will first need to move the headrest forward by pulling on the handle behind the seatback. The comfort guide will now be accessible.

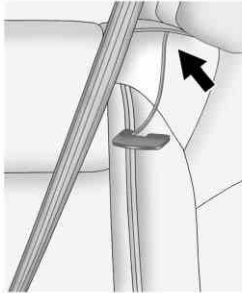

Third Row Center Position

Pull the comfort guide out of its storage location and then return the headrest to its upright position.

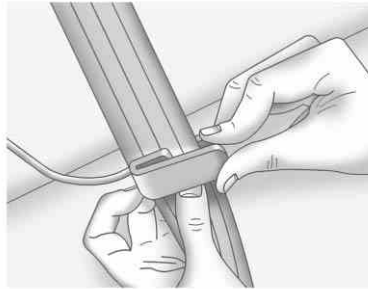

2. Place the guide over the belt and insert the two edges of the belt into the slots of the guide.

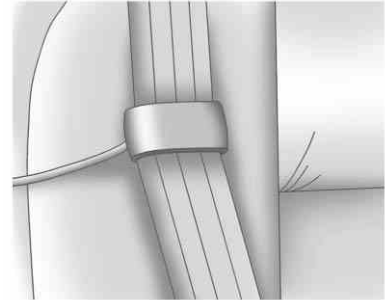

3. Be sure that the belt is not twisted and it lies flat. The elastic cord must be under the belt and the guide on top.

⚠ WARNING

A safety belt that is not properly worn may not provide the protection needed in a crash. The person wearing the belt could be seriously injured. The shoulder belt should go over the shoulder and across the chest. These parts of the body are best able to take belt restraining forces.



4. Buckle, position, and release the safety belt as described previously in this section. Make sure the shoulder portion of the belt is on the shoulder and not falling off of it. The belt should be close to, but not contacting, the neck.

To remove and store the comfort guide, squeeze the belt edges together so that the safety belt can be removed from the guide. Slide the guide into its storage location or on its storage clip.

Safety Belt Use During Pregnancy

Safety belts work for everyone, including pregnant women. Like all occupants, they are more likely to be seriously injured if they do not wear safety belts.



A pregnant woman should wear a lap-shoulder belt, and the lap portion should be worn as low as possible, below the rounding, throughout the pregnancy.

3-22 Seats and Restraints

The best way to protect the fetus is to protect the mother. When a safety belt is worn properly, it is more likely that the fetus will not be hurt in a crash. For pregnant women, as for anyone, the key to making safety belts effective is wearing them properly.

Safety Belt Extender

If the vehicle's safety belt will fasten around you, you should use it.

But if a safety belt is not long enough, your dealer will order you an extender. When you go in to order it, take the heaviest coat you will wear, so the extender will be long enough for you. To help avoid personal injury, do not let someone else use it, and use it only for the seat it is made to fit. The extender has been designed for adults. Never use it for securing child seats. To wear it, attach it to the regular safety belt. For more information, see the instruction sheet that comes with the extender.

Safety System Check

Now and then, check that the safety belt reminder light, safety belts, buckles, latch plates, retractors, and anchorages are all working properly. Look for any other loose or damaged safety belt system parts that might keep a safety belt system from doing its job. See your dealer to have it repaired. Torn or frayed safety belts may not protect you in a crash. They can rip apart under impact forces. If a belt is torn or frayed, get a new one right away.

Make sure the safety belt reminder light is working. See *Safety Belt Reminders on page 5-16* for more information.

Keep safety belts clean and dry. See *Safety Belt Care on page 3-22*.

Safety Belt Care

Keep belts clean and dry.



Do not bleach or dye safety belts. It may severely weaken them. In a crash, they might not be able to provide adequate protection. Clean safety belts only with mild soap and lukewarm water.

Replacing Safety Belt System Parts after a Crash

WARNING

A crash can damage the safety belt system in the vehicle. A damaged safety belt system may not properly protect the person using it, resulting in serious injury or even death in a crash. To help make sure the safety belt systems are working properly after a crash, have them inspected and any necessary replacements made as soon as possible.

After a minor crash, replacement of safety belts may not be necessary. But the safety belt assemblies that were used during any crash may have been stressed or damaged. See your dealer to have the safety belt assemblies inspected or replaced.

New parts and repairs may be necessary even if the safety belt system was not being used at the time of the crash.

Have the safety belt pretensioners checked if the vehicle has been in a crash, or if the airbag readiness light stays on after you start the vehicle or while you are driving. See *Airbag Readiness Light* on page 5-17.

Airbag System

The vehicle has the following airbags:

- A frontal airbag for the driver.
- A frontal airbag for the front outboard passenger.
- A seat-mounted side impact airbag for the driver.
- A seat-mounted side impact airbag for the front outboard passenger.
- A roof-rail airbag for the driver and for the second and third row passengers seated directly behind the driver.
- A roof-rail airbag for the front outboard passenger and the second and third row passengers seated directly behind the front outboard passenger.

3-24 Seats and Restraints

All vehicle airbags have the word AIRBAG on the trim or on an attached label near the deployment opening.

For frontal airbags, the word AIRBAG is on the center of the steering wheel for the driver and on the instrument panel for the front outboard passenger.

For seat-mounted side impact airbags, the word AIRBAG is on the side of the seatback closest to the door.

For roof-rail airbags, the word AIRBAG is on the ceiling or trim.

Airbags are designed to supplement the protection provided by safety belts. Even though today's airbags are also designed to help reduce the risk of injury from the force of an inflating bag, all airbags must inflate very quickly to do their job.

Here are the most important things to know about the airbag system:

WARNING

You can be severely injured or killed in a crash if you are not wearing your safety belt, even with airbags. Airbags are designed to work with safety belts, not replace them. Also, airbags are not designed to inflate in every crash. In some crashes safety belts are the only restraint. See *When Should an Airbag Inflate?* on page 3-27.

Wearing your safety belt during a crash helps reduce the chance of hitting things inside the vehicle or being ejected from it. Airbags are “supplemental restraints” to the safety belts. Everyone in the vehicle should wear a safety belt properly, whether or not there is an airbag for that person.

WARNING

Because airbags inflate with great force and faster than the blink of an eye, anyone who is up against, or very close to any airbag when it inflates can be seriously injured or killed. Do not sit unnecessarily close to any airbag, as you would be if sitting on the edge of the seat or leaning forward. Safety belts help keep you in position before and during a crash. Always wear a safety belt, even with airbags. The driver should sit as far back as possible while still maintaining control of the vehicle.

Occupants should not lean on or sleep against the door or side windows in seating positions with seat-mounted side impact airbags and/or roof-rail airbags.

⚠ WARNING

Children who are up against, or very close to, any airbag when it inflates can be seriously injured or killed. Airbags plus lap-shoulder belts offer protection for adults and older children, but not for young children and infants. Neither the vehicle's safety belt system nor its airbag system is designed for them. Young children and infants need the protection that a child restraint system can provide. Always secure children properly in the vehicle. To read how, see *Older Children on page 3-38* or *Infants and Young Children on page 3-41*.



There is an airbag readiness light on the instrument panel cluster, which shows the airbag symbol.

The system checks the airbag electrical system for malfunctions. The light tells you if there is an electrical problem. See *Airbag Readiness Light on page 5-17* for more information.

Where Are the Airbags?

The driver frontal airbag is in the center of the steering wheel.



The front outboard passenger frontal airbag is in the passenger side instrument panel.



**Driver Side Shown,
Passenger Side Similar**

The driver and front outboard passenger seat-mounted side impact airbags are in the side of the seatbacks closest to the door.



**Driver Side Shown,
Passenger Side Similar**

The roof-rail airbags for the driver, front outboard passenger, and second and third row outboard passengers are in the ceiling above the side windows.

 **WARNING**

If something is between an occupant and an airbag, the airbag might not inflate properly or it might force the object into that person causing severe injury or even death. The path of an inflating airbag must be kept clear. Do not put anything between an occupant and an airbag, and do not attach or put anything on the steering wheel hub or on or near any other airbag covering.

Do not use seat accessories that block the inflation path of a seat-mounted side impact airbag.

Never secure anything to the roof of a vehicle with roof-rail airbags by routing a rope or tie-down through any door or window opening. If you do, the path of an inflating roof-rail airbag will be blocked.

When Should an Airbag Inflate?

Frontal airbags are designed to inflate in moderate to severe frontal or near frontal crashes to help reduce the potential for severe injuries, mainly to the driver's or front outboard passenger's head and chest. However, they are only designed to inflate if the impact exceeds a predetermined deployment threshold. Deployment thresholds are used to predict how severe a crash is likely to be in time for the airbags to inflate and help restrain the occupants.

Whether the frontal airbags will or should inflate is not based primarily on how fast the vehicle is traveling. It depends on what is hit, the direction of the impact, and how quickly the vehicle slows down.

Frontal airbags may inflate at different crash speeds depending on whether the vehicle hits an object straight on or at an angle, and whether the object is fixed or moving, rigid or deformable, narrow or wide.

Thresholds can also vary with specific vehicle design.

Frontal airbags are not intended to inflate during vehicle rollovers, rear impacts, or many side impacts.

In addition, the vehicle has dual-stage frontal airbags. Dual-stage airbags adjust the restraint according to crash severity. The vehicle has electronic frontal sensors, which help the sensing system distinguish between a moderate frontal impact and a more severe frontal impact. For moderate frontal impacts, dual-stage airbags inflate at a level less than full deployment. For more severe frontal impacts, full deployment occurs.

3-28 Seats and Restraints

The vehicle has seat-mounted side impact and roof-rail airbags. See *Airbag System on page 3-23*. Seat-mounted side impact and roof-rail airbags are intended to inflate in moderate to severe side crashes depending on the location of the impact. In addition, these roof-rail airbags are intended to inflate during a rollover or in a severe frontal impact. Seat-mounted side impact and roof-rail airbags will inflate if the crash severity is above the system's designed threshold level. The threshold level can vary with specific vehicle design.

Seat-mounted side impact airbags are not intended to inflate in frontal impacts, near frontal impacts, rollovers, or rear impacts. Roof-rail airbags are not intended to inflate in rear impacts. A seat-mounted side impact airbag is intended to inflate

on the side of the vehicle that is struck. Both roof-rail airbags will inflate when either side of the vehicle is struck, or the sensing system predicts that the vehicle is about to roll over on its side, or in a severe frontal impact.

In any particular crash, no one can say whether an airbag should have inflated simply because of the vehicle damage or the repair costs. For frontal airbags, inflation is determined by what the vehicle hits, the angle of the impact, and how quickly the vehicle slows down. For seat-mounted side impact and roof-rail airbags, deployment is determined by the location and severity of the side impact. In a rollover event, roof-rail airbag deployment is determined by the direction of the roll.

What Makes an Airbag Inflate?

In a deployment event, the sensing system sends an electrical signal triggering a release of gas from the inflator. Gas from the inflator fills the airbag causing the bag to break out of the cover. The inflator, the airbag, and related hardware are all part of the airbag module.

For airbag location, see *Where Are the Airbags? on page 3-25*.

How Does an Airbag Restrain?

In moderate to severe frontal or near frontal collisions, even belted occupants can contact the steering wheel or the instrument panel. In moderate to severe side collisions, even belted occupants can contact the inside of the vehicle.

Airbags supplement the protection provided by safety belts by distributing the force of the impact more evenly over the occupant's body.

Rollover capable roof-rail airbags are designed to help contain the head and chest of occupants in the outboard seating positions in the first, second and third rows. The rollover capable roof-rail airbags are designed to help reduce the risk of full or partial ejection in rollover events, although no system can prevent all such ejections.

But airbags would not help in many types of collisions, primarily because the occupant's motion is not toward those airbags. See *When Should an Airbag Inflate?* on page 3-27 for more information.

Airbags should never be regarded as anything more than a supplement to safety belts.

What Will You See after an Airbag Inflates?

After the frontal airbags and seat-mounted side impact airbags inflate, they quickly deflate, so quickly that some people may not even realize an airbag inflated. Roof-rail airbags may still be at least partially inflated for some time after they inflate. Some components of the airbag module may be hot for several minutes. For location of the airbags, see *Where Are the Airbags?* on page 3-25.

The parts of the airbag that come into contact with you may be warm, but not too hot to touch. There may be some smoke and dust coming from the vents in the deflated airbags. Airbag inflation does not prevent the driver from seeing out of the windshield or being able to steer the vehicle, nor does it prevent people from leaving the vehicle.

WARNING

When an airbag inflates, there may be dust in the air. This dust could cause breathing problems for people with a history of asthma or other breathing trouble. To avoid this, everyone in the vehicle should get out as soon as it is safe to do so. If you have breathing problems but cannot get out of the vehicle after an airbag inflates, then get fresh air by opening a window or a door. If you experience breathing problems following an airbag deployment, you should seek medical attention.

The vehicle has a feature that may automatically unlock the doors, turn on the interior lamps and hazard warning flashers, and shut off the fuel system after the airbags inflate.

3-30 Seats and Restraints

You can lock the doors, and turn off the interior lamps and hazard warning flashers by using the controls for those features.

WARNING

A crash severe enough to inflate the airbags may have also damaged important functions in the vehicle, such as the fuel system, brake and steering systems, etc. Even if the vehicle appears to be drivable after a moderate crash, there may be concealed damage that could make it difficult to safely operate the vehicle.

Use caution if you should attempt to restart the engine after a crash has occurred.

In many crashes severe enough to inflate the airbag, windshields are broken by vehicle deformation. Additional windshield breakage may also occur from the front outboard passenger airbag.

- Airbags are designed to inflate only once. After an airbag inflates, you will need some new parts for the airbag system. If you do not get them, the airbag system will not be there to help protect you in another crash. A new system will include airbag modules and possibly other parts. The service manual for the vehicle covers the need to replace other parts.
- The vehicle has a crash sensing and diagnostic module which records information after a crash. See *Vehicle Data Recording and Privacy* on page 13-21 and *Event Data Recorders* on page 13-21.
- Let only qualified technicians work on the airbag systems. Improper service can mean that an airbag system will not work properly. See your dealer for service.

Passenger Sensing System

The vehicle has a passenger sensing system for the front outboard passenger position. The passenger airbag status indicator will light on the instrument panel when the vehicle is started.



United States



Canada and Mexico

The words ON and OFF, or the symbol for on and off, are visible during the system check. If you use remote start, if equipped, to start the vehicle, you may not see the system check. When the system check is complete, either the word ON or OFF, or the symbol for on or off, will be visible. See *Passenger Airbag Status Indicator* on page 5-18.

The passenger sensing system turns off the front outboard passenger frontal airbag under certain conditions. No other airbag is affected by the passenger sensing system.

The passenger sensing system works with sensors that are part of the front outboard passenger seat. The sensors are designed to detect the presence of a properly-seated occupant and determine if the front outboard passenger frontal airbag should be allowed to inflate or not.

According to accident statistics, children are safer when properly secured in a rear seat in the correct child restraint for their weight and size.

We recommend that children be secured in a rear seat, including: an infant or a child riding in a rear-facing child restraint; a child riding in a forward-facing child seat; an older child riding in a booster seat; and children, who are large enough, using safety belts.

3-32 Seats and Restraints

Never put a rear-facing child seat in the front. This is because the risk to the rear-facing child is so great, if the airbag inflates.

WARNING

A child in a rear-facing child restraint can be seriously injured or killed if the passenger frontal airbag inflates. This is because the back of the rear-facing child restraint would be very close to the inflating airbag. A child in a forward-facing child restraint can be seriously injured or killed if the passenger frontal airbag inflates and the passenger seat is in a forward position.

Even if the passenger sensing system has turned off the passenger frontal airbag, no system is fail-safe. No one can guarantee that an airbag will not

(Continued)

WARNING (Continued)

inflate under some unusual circumstance, even though the airbag is off.

Secure rear-facing child restraints in a rear seat, even if the airbag is off. If you secure a forward-facing child restraint in the front outboard passenger seat, always move the seat as far back as it will go. It is better to secure the child restraint in a rear seat.

The passenger sensing system is designed to turn off the front outboard passenger frontal airbag if:

- The front outboard passenger seat is unoccupied.
- The system determines that an infant is present in a child restraint.

- A front outboard passenger takes his/her weight off of the seat for a period of time.
- There is a critical problem with the airbag system or the passenger sensing system.

When the passenger sensing system has turned off the front outboard passenger frontal airbag, the off indicator will light and stay lit as a reminder that the airbag is off. See *Passenger Airbag Status Indicator on page 5-18*.

The passenger sensing system is designed to turn on the front outboard passenger frontal airbag anytime the system senses that a person of adult size is sitting properly in the front outboard passenger seat.

When the passenger sensing system has allowed the airbag to be enabled, the on indicator will light and stay lit as a reminder that the airbag is active.

For some children, including children in child restraints, and for very small adults, the passenger sensing system may or may not turn off the front outboard passenger frontal airbag, depending upon the person's seating posture and body build. Everyone in the vehicle who has outgrown child restraints should wear a safety belt properly — whether or not there is an airbag for that person.

 **WARNING**

If the airbag readiness light ever comes on and stays on, it means that something may be wrong with the airbag system. To help avoid injury to yourself or others, have the vehicle serviced right away. See *Airbag Readiness Light* on page 5-17 for more information, including important safety information.

If the On Indicator Is Lit for a Child Restraint

If a child restraint has been installed and the on indicator is lit:

1. Turn the vehicle off.
2. Remove the child restraint from the vehicle.
3. Remove any additional items from the seat such as blankets, cushions, seat covers, seat heaters, or seat massagers.
4. Reinstall the child restraint following the directions provided by the child restraint manufacturer and refer to *Securing Child Restraints (Rear Seat)* on page 3-55 or *Securing Child Restraints (Right Front Passenger Seat)* on page 3-57.
5. If, after reinstalling the child restraint and restarting the vehicle, the on indicator is still lit, turn the vehicle off. Then slightly recline the vehicle seatback and adjust the seat cushion, if adjustable, to make sure that the vehicle seatback is not pushing the child restraint into the seat cushion.

Also make sure the child restraint is not trapped under the vehicle head restraint. If this happens, adjust the head restraint. See *Head Restraints* on page 3-2.
6. Restart the vehicle.

The passenger sensing system may or may not turn off the airbag for a child in a child restraint depending upon the child's seating posture and body build. It is better to secure the child restraint in a rear seat.

3-34 Seats and Restraints

If the Off Indicator Is Lit for an Adult-Size Occupant



If a person of adult-size is sitting in the front outboard passenger seat, but the off indicator is lit, it could be because that person is not sitting properly in the seat.

Use the following steps to allow the system to detect that person and enable the front outboard passenger frontal airbag:

1. Turn the vehicle off.
2. Remove any additional material from the seat, such as blankets, cushions, seat covers, seat heaters, or seat massagers.
3. Place the seatback in the fully upright position.
4. Have the person sit upright in the seat, centered on the seat cushion, with legs comfortably extended.
5. Restart the vehicle and have the person remain in this position for two to three minutes after the on indicator is lit.

Additional Factors Affecting System Operation

Safety belts help keep the passenger in position on the seat during vehicle maneuvers and braking, which helps the passenger sensing system maintain the passenger airbag status. See “Safety Belts” and “Child Restraints” in the Index for additional information about the importance of proper restraint use.

A thick layer of additional material, such as a blanket or cushion, or aftermarket equipment such as seat covers, seat heaters, and seat massagers can affect how well the passenger sensing system operates.

We recommend that you not use seat covers or other aftermarket equipment except when approved by GM for your specific vehicle. See *Adding Equipment to the Airbag-Equipped Vehicle* on page 3-36 for more information about modifications that can affect how the system operates.

A wet seat can affect the performance of the passenger sensing system. Here is how:

- The passenger sensing system may turn off the passenger airbag when liquid is soaked into the seat. If this happens, the off indicator will be lit, and the airbag readiness light on the instrument panel will also be lit.

- Liquid pooled on the seat that has not soaked in may make it more likely that the passenger sensing system will turn on the passenger airbag while a child restraint or child occupant is on the seat. If the passenger airbag is turned on, the on indicator will be lit.

If the passenger seat gets wet, dry the seat immediately. If the airbag readiness light is lit, do not install a child restraint or allow anyone to occupy the seat. See *Airbag Readiness Light* on page 5-17 for important safety information.

The on indicator may be lit if an object, such as a briefcase, handbag, grocery bag, laptop or other electronic device, is put on an unoccupied seat. If this is not desired remove the object from the seat.

WARNING

Stowing of articles under the passenger seat or between the passenger seat cushion and seatback may interfere with the proper operation of the passenger sensing system.

Servicing the Airbag-Equipped Vehicle

Airbags affect how the vehicle should be serviced. There are parts of the airbag system in several places around the vehicle. Your dealer and the service manual have information about servicing the vehicle and the airbag system. To purchase a service manual, see *Service Publications Ordering Information* on page 13-18.

WARNING

For up to 10 seconds after the vehicle is turned off and the battery is disconnected, an airbag can still inflate during improper service. You can be injured if you are close to an airbag when it inflates. Avoid yellow connectors. They are probably part of the airbag system. Be sure to follow proper service procedures, and make sure the person performing work for you is qualified to do so.

Adding Equipment to the Airbag-Equipped Vehicle

Adding accessories that change the vehicle's frame, bumper system, height, front end, or side sheet metal may keep the airbag system from working properly.

The operation of the airbag system can also be affected by changing or moving any parts of the front seats, safety belts, airbag sensing and diagnostic module, steering wheel, instrument panel, roof-rail airbag modules, ceiling or pillar garnish trim, overhead console, front sensors, side impact sensors, or airbag wiring.

Your dealer and the service manual have information about the location of the airbag sensors, sensing and diagnostic module, and airbag wiring.

In addition, the vehicle has a passenger sensing system that includes sensors as part of the front outboard passenger seat. The passenger sensing system may not operate properly if the original seat trim is replaced with non-GM covers, upholstery or trim, or with GM covers, upholstery or trim designed for a different vehicle. Any object, such as an aftermarket seat heater or a comfort enhancing pad or device, installed under or on top of the seat fabric, could also interfere with the operation of the passenger sensing system.

This could either prevent proper deployment of the passenger airbag(s) or prevent the passenger sensing system from properly turning off the passenger airbag(s). See *Passenger Sensing System* on page 3-31.

If the vehicle has roof-rail airbags, see *Different Size Tires and Wheels* on page 10-56 for additional information.

If your vehicle needs to be modified because you have a disability and you have questions about whether the modifications will affect the vehicle's airbag system, or if you have questions about whether the airbag system will be affected if the vehicle is modified for any other reason, call Customer Assistance. See *Customer Assistance Offices (U.S. and Canada)* on page 13-5 or *Customer Assistance Offices (Mexico)* on page 13-6.

Airbag System Check

The airbag system does not need regularly scheduled maintenance or replacement. Make sure the airbag readiness light is working. See *Airbag Readiness Light* on page 5-17 for more information.

Notice: If an airbag covering is damaged, opened, or broken, the airbag may not work properly. Do not open or break the airbag coverings. If there are any opened or broken airbag covers, have the airbag covering and/or airbag module replaced. For the location of the airbags, see *Where Are the Airbags?* on page 3-25. See your dealer for service.

Replacing Airbag System Parts after a Crash

WARNING

A crash can damage the airbag systems in the vehicle. A damaged airbag system may not work properly and may not protect you and your passenger(s) in a crash, resulting in serious injury or even death. To help make sure the airbag systems are working properly after a crash, have them inspected and any necessary replacements made as soon as possible.

If an airbag inflates, you will need to replace airbag system parts. See your dealer for service.

If the airbag readiness light stays on after the vehicle is started or comes on when you are driving, the airbag system may not work properly. Have the vehicle serviced right away. See *Airbag Readiness Light* on page 5-17 for more information.

Child Restraints

Older Children



Older children who have outgrown booster seats should wear the vehicle safety belts.

The manufacturer's instructions that come with the booster seat state the weight and height limitations for that booster. Use a booster seat with a lap-shoulder belt until the child passes the fit test below:

- Sit all the way back on the seat. Do the knees bend at the seat edge? If yes, continue. If no, return to the booster seat.
- Buckle the lap-shoulder belt. Does the shoulder belt rest on the shoulder? If yes, continue. If no, try using the rear safety belt comfort guide. See “Rear Safety Belt Comfort Guides” under *Lap-Shoulder Belt on page 3-16* for more information. If the shoulder belt still does not rest on the shoulder, then return to the booster seat.

- Does the lap belt fit low and snug on the hips, touching the thighs? If yes, continue. If no, return to the booster seat.
- Can proper safety belt fit be maintained for the length of the trip? If yes, continue. If no, return to the booster seat.

Q: What is the proper way to wear safety belts?

A: An older child should wear a lap-shoulder belt and get the additional restraint a shoulder belt can provide. The shoulder belt should not cross the face or neck. The lap belt should fit snugly below the hips, just touching the top of the thighs. This applies belt force to the child's pelvic bones in a crash. It should never be worn over the abdomen, which could cause severe or even fatal internal injuries in a crash.

Also see “Rear Safety Belt Comfort Guides” under *Lap-Shoulder Belt on page 3-16*.

According to accident statistics, children and infants are safer when properly restrained in a child restraint system or infant restraint system secured in a rear seating position.

In a crash, children who are not buckled up can strike other people who are buckled up, or can be thrown out of the vehicle. Older children need to use safety belts properly.

3-40 Seats and Restraints

WARNING

Never do this.

Never allow two children to wear the same safety belt. The safety belt cannot properly spread the impact forces. In a crash, the two children can be crushed together and seriously injured. A safety belt must be used by only one person at a time.



WARNING

Never do this.

Never allow a child to wear the safety belt with the shoulder belt behind their back. A child can be seriously injured by not wearing the lap-shoulder belt properly. In a crash, the child would not be restrained by the shoulder belt.

(Continued)

WARNING (Continued)

The child could move too far forward increasing the chance of head and neck injury. The child might also slide under the lap belt. The belt force would then be applied right on the abdomen. That could cause serious or fatal injuries. The shoulder belt should go over the shoulder and across the chest.



Infants and Young Children

Everyone in a vehicle needs protection! This includes infants and all other children. Neither the distance traveled nor the age and size of the traveler changes the need, for everyone, to use safety restraints. In fact, the law in every state in the United States and in every Canadian province says children up to some age must be restrained while in a vehicle.

WARNING

Children can be seriously injured or strangled if a shoulder belt is wrapped around their neck and the safety belt continues to tighten. Never leave children unattended in a vehicle and never allow children to play with the safety belts.

Airbags plus lap-shoulder belts offer protection for adults and older children, but not for young children and infants. Neither the vehicle's safety belt system nor its airbag system is designed for them. Every time infants and young children ride in vehicles, they should have the protection provided by appropriate child restraints.

Children who are not restrained properly can strike other people, or can be thrown out of the vehicle.

WARNING

Never do this.

Never hold an infant or a child while riding in a vehicle. Due to crash forces, an infant or a child will become so heavy it is not possible to hold it during a crash.

(Continued)

WARNING (Continued)

For example, in a crash at only 40 km/h (25 mph), a 5.5 kg (12 lb) infant will suddenly become a 110 kg (240 lb) force on a person's arms. An infant should be secured in an appropriate restraint.



WARNING

Never do this.

Children who are up against, or very close to, any airbag when it inflates can be seriously injured or killed. Never put a rear-facing child restraint in the right front seat. Secure a rear-facing child restraint in a rear seat. It is also better to secure a forward-facing child restraint in a rear seat. If you must secure a forward-facing child restraint in the right front seat, always move the front passenger seat as far back as it will go.



Q: What are the different types of add-on child restraints?

A: Add-on child restraints, which are purchased by the vehicle owner, are available in four basic types. Selection of a particular restraint should take into consideration not only the child's weight, height, and age but also whether or not the restraint will be compatible with the motor vehicle in which it will be used.

For most basic types of child restraints, there are many different models available. When purchasing a child restraint, be sure it is designed to be used in a motor vehicle. If it is, the restraint will have a label saying that it meets federal motor vehicle safety standards.

The restraint manufacturer's instructions that come with the restraint state the weight and height limitations for a particular child restraint. In addition, there are many kinds of restraints available for children with special needs.

⚠ WARNING

To reduce the risk of neck and head injury during a crash, infants need complete support. This is because an infant's neck is not fully developed and its head weighs so much compared with the rest of its body. In a crash, an infant in a rear-facing child restraint settles into the restraint, so the crash forces can be distributed across the strongest part of an infant's body, the back and shoulders. Infants should always be secured in rear-facing child restraints.

⚠ WARNING

A young child's hip bones are still so small that the vehicle's regular safety belt may not remain low on the hip bones, as it should. Instead, it may settle up around the child's abdomen. In a crash, the belt would apply force on a body area that is unprotected by any bony structure. This alone could cause serious or fatal injuries. To reduce the risk of serious or fatal injuries during a crash, young children should always be secured in appropriate child restraints.

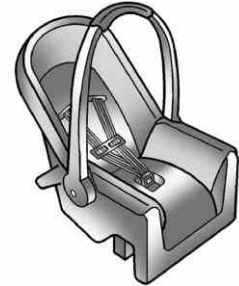
Child Restraint Systems**(A) Rear-Facing Infant Seat**

A rear-facing infant seat (A) provides restraint with the seating surface against the back of the infant.

The harness system holds the infant in place and, in a crash, acts to keep the infant positioned in the restraint.



(B) Forward-Facing Child Seat

A forward-facing child seat (B) provides restraint for the child's body with the harness.



(C) Booster Seats

A booster seat (C) is a child restraint designed to improve the fit of the vehicle's safety belt system. A booster seat can also help a child to see out the window.

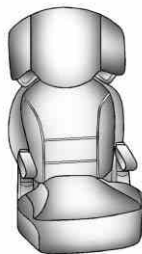

Securing an Add-On Child Restraint in the Vehicle

WARNING

A child can be seriously injured or killed in a crash if the child restraint is not properly secured in the vehicle. Secure the child restraint properly in the vehicle using the vehicle safety belt or LATCH system, following the instructions that came with that child restraint and the instructions in this manual.

To help reduce the chance of injury, the child restraint must be secured in the vehicle. Child restraint systems must be secured in vehicle seats by lap belts or the lap belt portion of a lap-shoulder belt, or by the LATCH system.

See *Lower Anchors and Tethers for Children (LATCH System)* on page 3-47 for more information. Children can be endangered in a crash if the child restraint is not properly secured in the vehicle.

When securing an add-on child restraint, refer to the instructions that come with the restraint which may be on the restraint itself or in a booklet, or both, and to this manual. The child restraint instructions are important, so if they are not available, obtain a replacement copy from the manufacturer.

Keep in mind that an unsecured child restraint can move around in a collision or sudden stop and injure people in the vehicle. Be sure to properly secure any child restraint in the vehicle — even when no child is in it.

In some areas, Certified Child Passenger Safety Technicians (CPSTs) are available to inspect and demonstrate how to correctly use and install child restraints. In the U.S., refer to the National Highway Traffic Safety Administration (NHTSA) website to locate the nearest child safety seat inspection station. For CPST availability in Canada, check with Transport Canada or the Provincial Ministry of Transportation office.

Securing the Child within the Child Restraint

 **WARNING**

A child can be seriously injured or killed in a crash if the child is not properly secured in the child restraint. Secure the child properly following the instructions that came with that child restraint.

Where to Put the Restraint

According to accident statistics, children and infants are safer when properly restrained in a child restraint system or infant restraint system secured in a rear seating position.

We recommend that children and child restraints be secured in a rear seat, including: an infant or a child riding in a rear-facing child restraint; a child riding in a forward-facing child seat; an older child riding in a booster seat; and children, who are large enough, using safety belts.

3-46 Seats and Restraints

A label on the sun visor says, “Never put a rear-facing child restraint in the front.” This is because the risk to the rear-facing child is so great if the airbag deploys.

WARNING

A child in a rear-facing child restraint can be seriously injured or killed if the right front passenger airbag inflates. This is because the back of the rear-facing child restraint would be very close to the inflating airbag. A child in a forward-facing child restraint can be seriously injured or killed if the right front passenger airbag inflates and the passenger seat is in a forward position.

Even if the passenger sensing system has turned off the right front passenger frontal airbag, no system is fail-safe. No one

(Continued)

WARNING (Continued)

can guarantee that an airbag will not deploy under some unusual circumstance, even though it is turned off.

Secure rear-facing child restraints in a rear seat, even if the airbag is off. If you secure a forward-facing child restraint in the right front seat, always move the front passenger seat as far back as it will go. It is better to secure the child restraint in a rear seat.

See *Passenger Sensing System* on page 3-31 for additional information.

When securing a child restraint in a rear seating position, study the instructions that came with the child restraint to make sure it is compatible with this vehicle.

Child restraints and booster seats vary considerably in size, and some may fit in certain seating positions better than others. Always make sure the child restraint is properly secured.

Depending on where you place the child restraint and the size of the child restraint you may not be able to access adjacent safety belt assemblies or LATCH anchors for additional passengers or child restraints. Adjacent seating positions should not be used if the child restraint prevents access to or interferes with the routing of the safety belt.

Wherever a child restraint is installed, be sure to secure the child restraint properly.

Keep in mind that an unsecured child restraint can move around in a collision or sudden stop and injure people in the vehicle. Be sure to properly secure any child restraint in the vehicle — even when no child is in it.

Lower Anchors and Tethers for Children (LATCH System)

The LATCH system holds a child restraint during driving or in a crash. This system is designed to make installation of a child restraint easier. The LATCH system uses anchors in the vehicle and attachments on the child restraint that are made for use with the LATCH system.

Make sure that a LATCH-compatible child restraint is properly installed using the anchors, or use the vehicle's safety belts to secure the restraint, following the instructions that came with that restraint, and also the instructions in this manual. When installing a child restraint with

a top tether, you must also use either the lower anchors or the safety belts to properly secure the child restraint. A child restraint must never be attached using only the top tether and anchor.

In order to use the LATCH system in your vehicle, you need a child restraint that has LATCH attachments. The child restraint manufacturer will provide you with instructions on how to use the child restraint and its attachments. The following explains how to attach a child restraint with these attachments in your vehicle.

Not all vehicle seating positions or child restraints have lower anchors and attachments or top tether anchors and attachments.

Lower Anchors

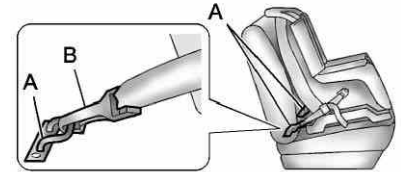

Lower anchors (A) are metal bars built into the vehicle. There are two lower anchors for each LATCH seating position that will accommodate a child restraint with lower attachments (B).

Top Tether Anchor

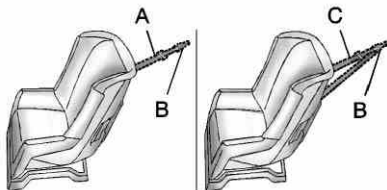

A top tether (A, C) anchors the top of the child restraint to the vehicle. A top tether anchor is built into the vehicle. The top tether attachment (B) on the child restraint connects to the top tether anchor in the vehicle in order to reduce the forward movement and rotation of the child restraint during driving or in a crash.

Your child restraint may have a single tether (A) or a dual tether (C). Either will have a single attachment (B) to secure the top tether to the anchor.

Some child restraints with top tethers are designed for use with or without the top tether being attached. Others require the top tether always to be attached. In Canada, the law requires that forward-facing child restraints have a top tether, and that the tether be attached. Be sure to read and follow the instructions for your child restraint.

Lower Anchor and Top Tether Anchor Locations

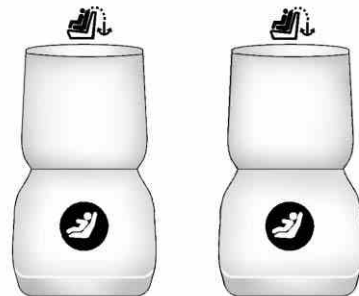

Second Row — Bucket

 **(Top Tether Anchor):** Seating positions with top tether anchors.

 **(Lower Anchor):** Seating positions with two lower anchors.

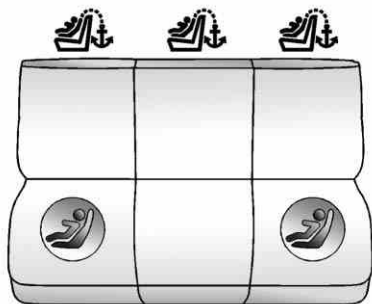

Second Row — 60/40 Bench

 **(Top Tether Anchor):** Seating positions with top tether anchors.

 **(Lower Anchor):** Seating positions with two lower anchors.

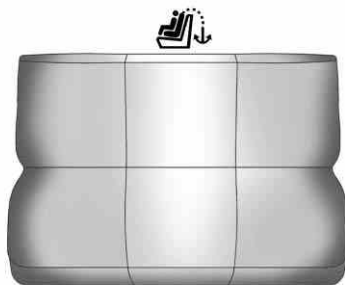

Third Row

 **(Top Tether Anchor):** Seating positions with top tether anchors.



To assist you in locating the lower anchors, each second row anchor position has a label, near the crease between the seatback and the seat cushion.



To assist you in locating the top tether anchors, the top tether anchor symbol is located on the cover, if equipped, or near the anchor.

The top tether anchors are located at the bottom rear of the seatback for each seating position in the second row.

3-50 Seats and Restraints

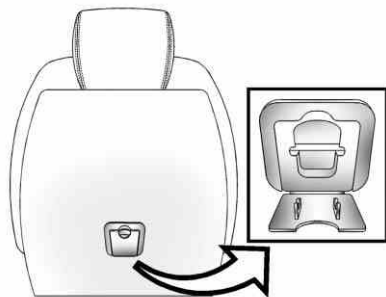

Second Row — Bucket Shown, Bench Similar

Some vehicles have top tether anchors with a cover. Open the cover to access the anchors.

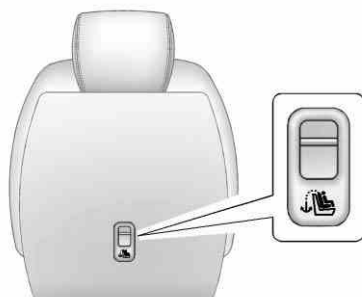

Second Row — Bucket Shown, Bench Similar

Some vehicles have exposed top tether anchors.

Be sure to use an anchor located on the same side of the vehicle as the seating position where the child restraint will be placed.

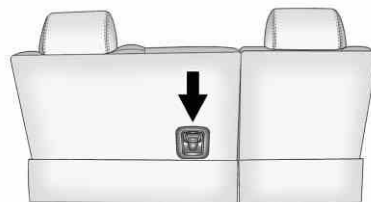

Third Row

The third row has one top tether anchor located at the bottom rear of the center seatback. This anchor should be used for the center seating position only. Never install two top tethers using the same top tether anchor.

Do not secure a child restraint in a position without a top tether anchor if a national or local law requires that the top tether be attached, or if the instructions that come with the child restraint say that the top tether must be attached.

According to accident statistics, children and infants are safer when properly restrained in a child restraint system or infant restraint system secured in a rear seating position. See *Where to Put the Restraint* on page 3-45 for additional information.

Securing a Child Restraint Designed for the LATCH System

WARNING

If a LATCH-type child restraint is not attached to anchors, the child restraint will not be able to protect the child correctly. In a crash, the child could be seriously injured or killed. Install a LATCH-type child restraint properly using the anchors, or use the vehicle safety belts to secure the restraint, following the instructions that came with the child restraint and the instructions in this manual.

WARNING

Do not attach more than one child restraint to a single anchor. Attaching more than one child restraint to a single anchor could cause the anchor or attachment to come loose or even break during a crash. A child or others could be injured. To reduce the risk of serious or fatal injuries during a crash, attach only one child restraint per anchor.

 **WARNING**

Children can be seriously injured or strangled if a shoulder belt is wrapped around their neck and the safety belt continues to tighten. Buckle any unused safety belts behind the child restraint so children cannot reach them. Pull the shoulder belt all the way out of the retractor to set the lock, if the vehicle has one, after the child restraint has been installed.

Notice: Do not let the LATCH attachments rub against the vehicle's safety belts. This may damage these parts. If necessary, move buckled safety belts to avoid rubbing the LATCH attachments.

Do not fold the empty rear seat with a safety belt buckled. This could damage the safety belt or the seat. Unbuckle and return the safety belt to its stowed position, before folding the seat.

1. Attach and tighten the lower attachments to the lower anchors. If the child restraint does not have lower attachments or the desired seating position does not have lower anchors, secure the child restraint with the top tether and the safety belts. Refer to your child restraint manufacturer instructions and the instructions in this manual.
 - 1.1. Find the lower anchors for the desired seating position.
 - 1.2. Recline the seatback to the full reclined position.

Make sure the second row bench seatbacks are aligned at the same angle before placing the child restraint on the seat. Make sure the third row bench seatbacks are both upright before placing the child restraint on the seat.
 - 1.3. Put the child restraint on the seat.
 - 1.4. Attach and tighten the lower attachments on the child restraint to the lower anchors.

2. If the child restraint manufacturer recommends that the top tether be attached, attach and tighten the top tether to the top tether anchor, if the vehicle has one. Refer to the child restraint instructions and the following steps:

- 2.1. Find the top tether anchor.
- 2.2. If the anchor is covered, flip open the cover to expose the anchor.

2.3. Route, attach, and tighten the top tether according to your child restraint instructions and the following instructions:

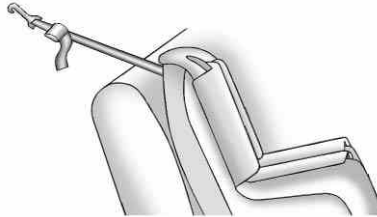

If the position you are using does not have a headrest or head restraint and you are using a single tether, route the tether over the seatback.

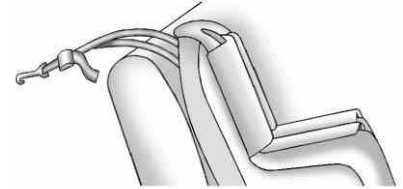

If the position you are using does not have a headrest or head restraint and you are using a dual tether, route the tether over the seatback.

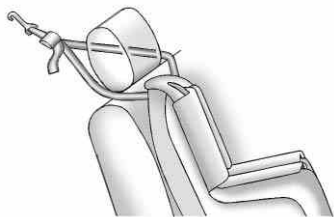

If the position you are using has a fixed headrest or head restraint and you are using a dual tether, route the tether around the headrest or head restraint.

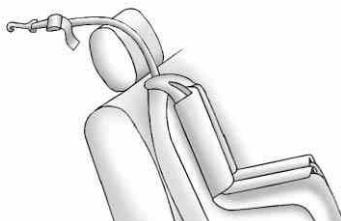

If the position you are using has a fixed headrest or head restraint and you are using a single tether, route the tether over the headrest or head restraint.

3. Before placing a child in the child restraint, make sure it is securely held in place. To check, grasp the child restraint at the LATCH path and attempt to move it side to side and back and forth. There should be no more than 2.5 cm (1 in) of movement, for proper installation.

Replacing LATCH System Parts After a Crash

WARNING

A crash can damage the LATCH system in the vehicle. A damaged LATCH system may not properly secure the child restraint, resulting in serious injury or even death in a crash. To help make sure the LATCH system is working properly after a crash, see your dealer to have the system inspected and any necessary replacements made as soon as possible.

If the vehicle has the LATCH system and it was being used during a crash, new LATCH system parts may be needed.

New parts and repairs may be necessary even if the LATCH system was not being used at the time of the crash.

Securing Child Restraints (Rear Seat)

When securing a child restraint in a rear seating position, study the instructions that came with the child restraint to make sure it is compatible with this vehicle.

If the child restraint has the LATCH system, see *Lower Anchors and Tethers for Children (LATCH System)* on page 3-47 for how and where to install the child restraint using LATCH. If a child restraint is secured in the vehicle using a safety belt and it uses a top tether, see *Lower Anchors and Tethers for Children (LATCH System)* on page 3-47 for top tether anchor locations.

Do not secure a child seat in a position without a top tether anchor if a national or local law requires that the top tether be anchored, or if the instructions that come with the child restraint say that the top strap must be anchored.

In Canada, the law requires that forward-facing child restraints have a top tether, and that the tether be attached.

If the child restraint does not have the LATCH system, you will be using the safety belt to secure the child restraint in this position. Be sure to follow the instructions that came with the child restraint. Secure the child in the child restraint when and as the instructions say.

If more than one child restraint needs to be installed in the rear seat, be sure to read *Where to Put the Restraint* on page 3-45.

1. Put the child restraint on the seat.
2. Pick up the latch plate, and run the lap and shoulder portions of the vehicle's safety belt through or around the restraint. The child restraint instructions will show you how.

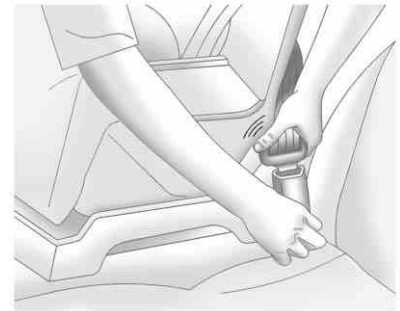

3. Push the latch plate into the buckle until it clicks.

Position the release button on the buckle so that the safety belt could be quickly unbuckled if necessary.

3-56 Seats and Restraints



4. Pull the shoulder belt all the way out of the retractor to set the lock. When the retractor lock is set, the shoulder belt can be tightened but not pulled out of the retractor.

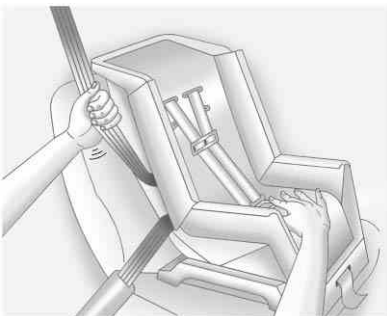

5. To tighten the belt, push down on the child restraint, pull the shoulder portion of the belt to tighten the lap portion of the belt, and feed the shoulder belt back into the retractor. When installing a forward-facing child restraint, it may be helpful to use your knee to push down on the child restraint as you tighten the belt.

Try to pull the belt out of the retractor to make sure the retractor is locked. If the retractor is not locked, repeat Steps 4 and 5.

6. If the child restraint has a top tether, follow the child restraint manufacturer's instructions regarding the use of the top tether. See *Lower Anchors and Tethers for Children (LATCH System)* on page 3-47 for more information.
7. Before placing a child in the child restraint, make sure it is securely held in place. To check, grasp the child restraint at the safety belt path and attempt to move it side to side and back and forth. When the child restraint is properly installed, there should be no more than 2.5 cm (1 in) of movement.

To remove the child restraint, unbuckle the vehicle safety belt and let it return to the stowed position. If the top tether is attached to a top tether anchor, disconnect it.

Securing Child Restraints (Right Front Passenger Seat)

The vehicle has airbags. A rear seat is a safer place to secure a forward-facing child restraint. See *Where to Put the Restraint* on page 3-45.

In addition, the vehicle has a passenger sensing system which is designed to turn off the right front passenger frontal airbag under certain conditions. See *Passenger Sensing System* on page 3-31 and *Passenger Airbag Status Indicator* on page 5-18 for more information, including important safety information.

A label on the sun visor says, "Never put a rear-facing child seat in the front." This is because the risk to the rear-facing child is so great, if the airbag deploys.

WARNING

A child in a rear-facing child restraint can be seriously injured or killed if the right front passenger airbag inflates. This is because the back of the rear-facing child restraint would be very close to the inflating airbag. A child in a forward-facing child restraint can be seriously injured or killed if the right front passenger airbag inflates and the passenger seat is in a forward position.

Even if the passenger sensing system has turned off the right front passenger frontal airbag, no system is fail-safe. No one can guarantee that an airbag will not deploy under some unusual circumstance, even though it is turned off.

(Continued)

WARNING (Continued)

Secure rear-facing child restraints in a rear seat, even if the airbag is off. If you secure a forward-facing child restraint in the right front seat, always move the front passenger seat as far back as it will go. It is better to secure the child restraint in a rear seat.

See *Passenger Sensing System* on page 3-31 for additional information.

If the child restraint has the LATCH system, see *Lower Anchors and Tethers for Children (LATCH System)* on page 3-47 for how and where to install the child restraint using LATCH. If a child restraint is secured using a safety belt and it uses a top tether, see *Lower Anchors and Tethers for Children (LATCH System)* on page 3-47 for top tether anchor locations.

3-58 Seats and Restraints

Do not secure a child seat in a position without a top tether anchor if a national or local law requires that the top tether be anchored, or if the instructions that come with the child restraint say that the top strap must be anchored.

In Canada, the law requires that forward-facing child restraints have a top tether, and that the tether be attached.

You will be using the lap-shoulder belt to secure the child restraint in this position. Follow the instructions that came with the child restraint.

1. Move the seat as far back as it will go before securing the forward-facing child restraint.

When the passenger sensing system has turned off the right front passenger frontal airbag, the off indicator on the passenger airbag status indicator should light and stay lit when the vehicle is started. See *Passenger Airbag Status Indicator* on page 5-18.

2. Put the child restraint on the seat.
3. Pick up the latch plate, and run the lap and shoulder portions of the vehicle's safety belt through or around the restraint. The child restraint instructions will show you how.

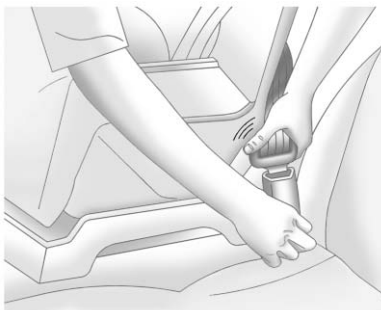

4. Push the latch plate into the buckle until it clicks.
Position the release button on the buckle so that the safety belt could be quickly unbuckled if necessary.



5. Pull the shoulder belt all the way out of the retractor to set the lock. When the retractor lock is set, the belt can be tightened but not pulled out of the retractor.

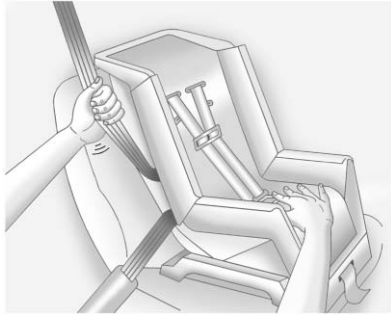

6. To tighten the belt, push down on the child restraint, pull the shoulder portion of the belt to tighten the lap portion of the belt, and feed the shoulder belt back into the retractor. When installing a forward-facing child restraint, it may be helpful to use your knee to push down on the child restraint as you tighten the belt. Try to pull the belt out of the retractor to make sure the retractor is locked. If the retractor is not locked repeat Steps 5 and 6.
7. Before placing a child in the child restraint, make sure it is securely held in place. To check, grasp the child restraint at the safety belt path and attempt to move it side to side and back and forth. When the child restraint is properly installed, there should be no more than 2.5 cm (1 in) of movement.

If the airbags are off, the off indicator in the passenger airbag status indicator will come on and stay on when the vehicle is started.

If a child restraint has been installed and the on indicator is lit, see "If the On Indicator Is Lit for a Child Restraint" under *Passenger Sensing System* on page 3-31 for more information.

To remove the child restraint, unbuckle the vehicle safety belt and let it return to the stowed position.

Storage

Storage Compartments

Instrument Panel Storage	4-1
Glove Box	4-1
Cupholders	4-1
Armrest Storage	4-2
Center Console Storage	4-2
Floor Console Storage	4-3

Additional Storage Features

Cargo Cover	4-4
Cargo Tie-Downs	4-4
Cargo Management System	4-4
Convenience Net	4-4

Roof Rack System

Roof Rack System	4-5
------------------	-----

Storage Compartments

Instrument Panel Storage

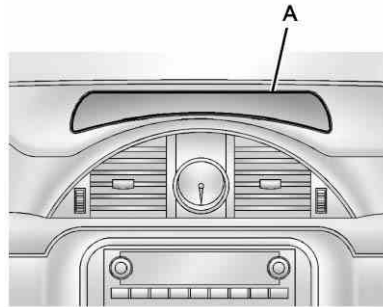

This vehicle has an instrument panel storage area (A). To open the cover, press the button.

The vehicle may have an auxiliary input jack located on the lower right side of the faceplate and for vehicles with a USB port, it is

located in the instrument panel storage. See *Auxiliary Devices on page 7-38* for more information.

Glove Box

Lift the glove box handle to open it. Use the key to lock and unlock the glove box.

Cupholders

There are two cupholders, with removable liners, located in front of the center console. There may be cupholders located in the second row seat armrest. To access, pull the armrest down. There are additional cupholders located on each side of the third row seat and in each door. There may be cupholders located at the rear of the center console. To access, pull the handle down.

4-2 Storage

Armrest Storage



Vehicles with a rear seat armrest have two cupholders. Pull the armrest down to access the cupholders.

Center Console Storage

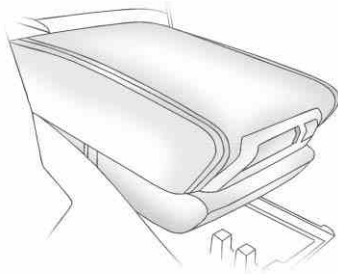

Pull up on the lever, located on the front of the center console armrest, to slide it forward and backward. To open the armrest storage area, press the button located on the front of the armrest.

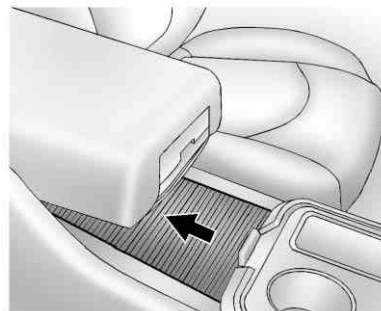

There is additional storage under the armrest. Move the armrest all the way to the rear position then slide the storage cover back to access.

Floor Console Storage

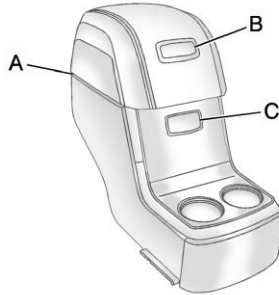

For vehicles with a second row center console, open each area to access the storage compartment inside.

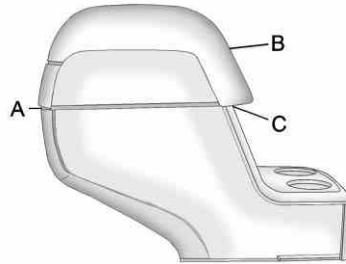

To access the upper storage area, press the upper button (B) and lift up. To access the lower storage area, press the lower button (C) and lift up. The top of the console can be folded forward for increased storage area. Lift up on the handle on the rear of the console (A) and pull forward.

WARNING

Never open more than one of the three latches at a time to help avoid personal injury and damage to the console.

Notice: Slide the front console as far forward as it will go before folding the second row console forward to help prevent damage to the consoles.

Additional Storage Features

Cargo Cover

For vehicles with a cargo cover, it can be used to cover items in the rear of the vehicle. To install the cover, place the loops on each corner of the cover on the four hooks in the rear of the vehicle. The cover should be stored securely when not in use.

Cargo Tie-Downs

Four cargo tie-downs are located in the rear compartment of the vehicle. The tie-downs can be used to secure small loads.

Cargo Management System

This vehicle has a cargo management system located in the rear.

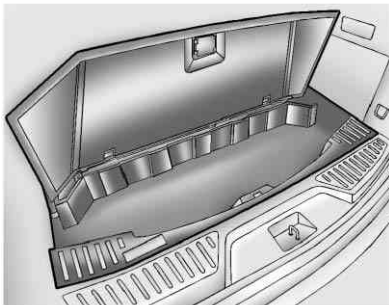

To remove the cargo management cover:

1. Open the cover. It remains open when lifted.
2. Pull the cover up making sure to unhook the hinges at the rear of the cover.

WARNING

An improperly latched and closed cargo cover, or cargo cover left in the open position, could be thrown about the vehicle during a crash or sudden maneuver. Someone could be injured. Be sure to return the cover to the closed position and latch before driving. If the cover is removed, always store it outside of the vehicle. When it is replaced, always be sure that it is securely reattached.

3. Remove the cover from the vehicle and store outside of the vehicle.

Convenience Net

For vehicles with a convenience net in the rear, use it to store small loads as far forward as possible. The net should not be used to store heavy loads.

Roof Rack System

 **WARNING**

If something is carried on top of the vehicle that is longer or wider than the roof rack — like paneling, plywood, or a mattress — the wind can catch it while the vehicle is being driven. The item being carried could be violently torn off, and this could cause a collision and damage the vehicle. Never carry something longer or wider than the roof rack on top of the vehicle unless using a GM certified accessory carrier.

For vehicles with a roof rack, the rack can be used to load items. For roof racks that do not have crossrails included, GM Certified crossrails can be purchased as an accessory. See your dealer for additional information.

Notice: Loading cargo on the roof rack that weighs more than 91 kg (200 lbs) or hangs over the rear or sides of the vehicle may damage the vehicle. Load cargo so that it rests evenly between the crossrails, making sure to fasten cargo securely.

To prevent damage or loss of cargo when driving, check to make sure crossrails and cargo are securely fastened. Loading cargo on the roof rack will make the vehicle's center of gravity higher. Avoid high speeds, sudden starts, sharp turns, sudden braking or abrupt maneuvers; otherwise it may result in loss of control. If driving for a long distance, on rough roads, or at high speeds, occasionally stop the vehicle to make sure the cargo remains in its place. Do not exceed the maximum vehicle capacity when loading the vehicle.

For more information on vehicle capacity and loading, see *Vehicle Load Limits* on page 9-12.

Instruments and Controls

Controls

Steering Wheel Adjustment ...	5-2
Steering Wheel Controls	5-3
Horn	5-5
Windshield Wiper/Washer	5-5
Rear Window Wiper/ Washer	5-6
Compass	5-7
Clock	5-9
Power Outlets	5-10

Warning Lights, Gauges, and Indicators

Warning Lights, Gauges, and Indicators	5-12
Instrument Cluster	5-13
Speedometer	5-14
Odometer	5-14
Tachometer	5-14
Fuel Gauge	5-14

Engine Coolant Temperature Gauge	5-15
Voltmeter Gauge	5-16
Safety Belt Reminders	5-16
Airbag Readiness Light	5-17
Passenger Airbag Status Indicator	5-18
Charging System Light	5-19
Malfunction Indicator Lamp	5-20
Brake System Warning Light	5-22
Antilock Brake System (ABS) Warning Light	5-23
Tow/Haul Mode Light	5-23
StabiliTrak® Indicator Light ...	5-24
Engine Coolant Temperature Warning Light	5-24
Tire Pressure Light	5-24
Engine Oil Pressure Light ...	5-25
Security Light	5-25
High-Beam On Light	5-26
Front Fog Lamp Light	5-26
Cruise Control Light	5-26

Information Displays

Driver Information Center (DIC)	5-27
--	------

Vehicle Messages

Vehicle Messages	5-31
Battery Voltage and Charging Messages	5-32
Brake System Messages ...	5-32
Cruise Control Messages ...	5-32
Door Ajar Messages	5-32
Engine Cooling System Messages	5-33
Engine Oil Messages	5-34
Engine Power Messages ...	5-35
Fuel System Messages	5-35
Key and Lock Messages ...	5-36
Lamp Messages	5-36
Object Detection System Messages	5-36
Ride Control System Messages	5-37
Airbag System Messages ...	5-37

5-2 Instruments and Controls

Anti-theft Alarm System Messages	5-37
Service Vehicle Messages ...	5-38
Tire Messages	5-38
Transmission Messages	5-39
Vehicle Reminder Messages	5-40
Vehicle Speed Messages ...	5-40
Washer Fluid Messages	5-40

Vehicle Personalization

Vehicle Personalization	5-41
-------------------------------	------

Universal Remote System

Universal Remote System ...	5-49
Universal Remote System Programming	5-49
Universal Remote System Operation	5-52

Controls

Steering Wheel Adjustment



1. Pull the lever (A) down.
2. Move the steering wheel up or down.
3. Pull or push the steering wheel closer or away from you.
4. Push the lever (A) up to lock the steering wheel in place.

Power Tilt Wheel



For vehicles with the power tilt and telescope wheel, the control is on the outboard side of the steering column.

Push the control up or down to tilt the steering wheel up or down.

Push the control forward or rearward to move the steering wheel toward the front or rear of the vehicle. To set the memory position, see *Vehicle Personalization on page 5-41*.

Do not adjust the steering wheel while driving.

Steering Wheel Controls

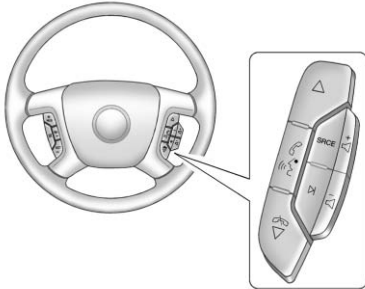

Vehicles with audio steering wheel controls could differ depending on the vehicle's options. Some audio controls can be adjusted at the steering wheel.

△ and ↶ / ↷ (Next/Previous):
Press to select preset or favorite radio stations, select tracks on a CD/DVD, or select tracks and navigate folders on an iPod® or USB device.

To select preset or favorite radio stations:

- Press and release △ and ↶ / ↷ to go to the next or previous radio station stored as a preset or favorite.

To select tracks on a CD/DVD (if equipped):

Press and release △ and ↶ / ↷ to go to the next or previous track.

To select tracks on an iPod or USB device for vehicles without a navigation system:













1. Press and hold △ and ↶ / ↷ while listening to a song until the contents of the current folder display on the radio display.
2. Press and release △ and ↶ / ↷ to scroll up or down the list, then press and hold , or press to play the highlighted track.

To select tracks on an iPod or USB device for vehicles with a navigation system:





1. Press and hold △ and ↶ / ↷ while listening to a song listed in the main audio page, to quickly move forward or in reverse through the tracks. See the separate navigation manual for more information.
Track information is displayed on the screen. Release △ and ↶ / ↷ when the desired track is reached.
2. Press and release △ and ↶ / ↷ to begin playing the track shown in the display.



5-4 Instruments and Controls

To navigate folders on an iPod or USB device for vehicles without a navigation system:



1. Press and hold  and  /  while listening to a song until the contents of the current folder display on the radio display.
2. Press and release  and  /  to go back to the previous folder list.
3. Press and release  and  /  to scroll up or down the list
 - To select a folder, press and hold , or press  when the folder is highlighted.
 - To go back further in the folder list, press and hold  / .

To navigate folders on an iPod or USB device for vehicles with a navigation system:

1. Go to the Music Navigator by first touching the center touch screen folder button in the main audio page.
2. While in Music Navigator, select the folder/artist/genre/category, etc. using the touch screen.
3. Press and release  /  to scroll through the selected music list. Touch the track label on the touch screen to highlight and begin playing the track from that list.
4. Press and hold  /  to quickly scroll through the selected music list.

 /  (**Mute/Push to Talk**): Press to silence the vehicle speakers only. Press again to turn the sound on.

For vehicles with Bluetooth or OnStar® systems, press and hold for longer than two seconds to interact with those systems. See *Bluetooth* on page 7-52 and *OnStar Overview* on page 14-1 for more information.

 /  (**End**): Press to reject an incoming call, or end a current call.

SRCE (Source/Voice Recognition): Press to switch between the radio, CD, and for equipped vehicles, DVD, front auxiliary, and rear auxiliary.

For vehicles with the navigation system, press and hold this button for longer than one second to initiate voice recognition. See “Voice Recognition” in the navigation manual for more information.

↻ (Seek): Press to go to the next radio station while in AM, FM, or XM™.

For vehicles with or without a navigation system:

Press **↻** to go to the next track or chapter while sourced to the CD or DVD slot.

Press **↻** to select a track or a folder when navigating folders on an iPod or USB device.

For vehicles with a navigation system:

1. Press and hold **↻** until a beep is heard to place the radio into SCAN mode. A station will play for five seconds before moving to the next station.
2. To stop the SCAN function, press **↻** again.
3. In CD/DVD, iPod, or AUX USB, press and hold to quickly move forward through the tracks. Release to stop on the desired track.

+ 🔊 and - 🔊 (Volume): Press to increase or to decrease the volume.

Horn

Press **🔊** on the steering wheel pad to sound the horn.

Windshield Wiper/Washer

The windshield wiper/washer lever is located on the left side of the steering column.

Turn the band with the wiper symbol to control the windshield wipers.



🔊 (Mist): Use for a single wiping cycle.

5-6 Instruments and Controls

○ (Off): Use to turn the wipers off.

⏸ (Adjustable Interval Wipes):

Delays wiping cycle. Turn the band up for more frequent wipes or down for less frequent wipes.

1 : Slow wipes.

2 : Fast wipes.

Clear ice and snow from the wiper blades before using them. If frozen to the windshield, carefully loosen or thaw them. Damaged wiper blades should be replaced. See *Wiper Blade Replacement on page 10-27*.

Heavy snow or ice can overload the wipers. A circuit breaker stops them until the motor cools.

Windshield Washer



(Washer Fluid): Press the button at the end of the turn signal/lane change lever, to spray washer fluid on the windshield. The wipers clear the windshield and either stop or return to the preset speed. The ignition key must be in ACC/ACCESSORY or ON/RUN for this to work. See *Washer Fluid on page 10-22*.



WARNING

In freezing weather, do not use the washer until the windshield is warmed. Otherwise the washer fluid can form ice on the windshield, blocking your vision.

WASHER FLUID LOW ADD FLUID is displayed on the Driver Information Center (DIC) when the washer fluid is low. See *Washer Fluid Messages on page 5-40*.

Rear Window Wiper/Washer

The rear wiper and rear wash button is located on the instrument panel below the climate control system.

⏸ (Rear Wiper): Press to turn the rear wiper on and off. The wiper speed cannot be changed.

🚿 (Wash): Press to spray washer fluid on the rear window. The window wiper will also come on. Release the button when enough fluid has been sprayed on the window. The rear wiper will run a few more cycles after it is released. If the rear wiper function was already on prior to pressing the wash button, it stays on until the wiper button is pressed again.

The rear window washer uses the same fluid that is in the windshield washer reservoir. See *Washer Fluid on page 10-22*.

Compass

Your vehicle may have a compass in the Driver Information Center (DIC). See *Driver Information Center (DIC) on page 5-27* for more information about the DIC.

Compass Zone

The zone is set to zone eight upon leaving the factory. Your dealer will set the correct zone for your location.

Under certain circumstances, such as during a long distance cross-country trip or moving to a new state or province, it will be necessary to compensate for compass variance by resetting the zone through the DIC if the zone is not set correctly.

Compass variance is the difference between the earth's magnetic north and true geographic north. If the compass is not set to the zone where you live, the compass may give false readings. The compass must be set to the variance zone in which the vehicle is traveling.

To adjust for compass variance, use the following procedure:

Compass Variance (Zone) Procedure

1. Do not set the compass zone when the vehicle is moving. Only set it when the vehicle is in P (Park).

Press the vehicle information button until **PRESS ✓ TO CHANGE COMPASS ZONE** displays.

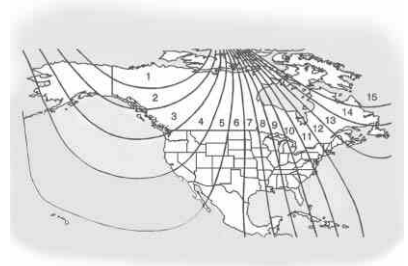

2. Find the vehicle's current location and variance zone number on the map. Zones 1 through 15 are available.

5-8 Instruments and Controls

3. Press the set/reset button to scroll through and select the appropriate variance zone.
4. Press the trip/fuel button until the vehicle heading, for example, N for North, is displayed in the DIC.
5. If calibration is necessary, calibrate the compass. See "Compass Calibration Procedure" following.

Compass Calibration

The compass can be manually calibrated. Only calibrate the compass in a magnetically clean and safe location, such as an open parking lot, where driving the vehicle in circles is not a danger. It is suggested to calibrate away from tall buildings, utility wires, manhole covers, or other industrial structures, if possible.

If CAL should ever appear in the DIC display, the compass should be calibrated.

If the DIC display does not show a heading, for example, N for North, or the heading does not change after making turns, there may be a strong magnetic field interfering with the compass. Such interference may be caused by a magnetic CB or cell phone antenna mount, a magnetic emergency light, magnetic note pad holder, or any other magnetic item. Turn off the vehicle, move the magnetic item, then turn on the vehicle and calibrate the compass.

To calibrate the compass, use the following procedure:

Compass Calibration Procedure



1. Before calibrating the compass, make sure the compass zone is set to the variance zone in which the vehicle is located. See "Compass Variance (Zone) Procedure" earlier in this section.







Do not operate any switches such as window, sunroof, climate controls, seats, etc. during the calibration procedure.
2. Press the vehicle information button until PRESS ✓ TO CALIBRATE COMPASS displays.

3. Press the set/reset button to start the compass calibration.
4. The DIC will display CALIBRATING: DRIVE IN CIRCLES. Drive the vehicle in tight circles at less than 8 km/h (5 mph) to complete the calibration. The DIC will display CALIBRATION COMPLETE for a few seconds when the calibration is complete. The DIC display will then return to the previous menu.



Clock

To adjust the time and date:

1. Turn the ignition key to ACC/ACCESSORY or ON/RUN, then press  to turn the radio on.
2. Press  to display HR, MIN, MM, DD, YYYY (hour, minute, month, day, and year).

3. Press the pushbutton located under any one of the labels to be changed.
4. To increase the time or date, do one of the following:
 - Press the pushbutton below the selected label.
 - Press  SEEK.
 - Press  FWD.
 - Turn  clockwise.
5. To decrease the time or date, do one of the following:
 - Press  SEEK.
 - Press  REV.
 - Turn  counterclockwise.

To change the time default setting from 12 hour to 24 hour or to change the date default setting from month/day/year to day/month/year:

1. Press  and then the pushbutton located under the forward arrow that displays on the radio screen until the time 12H (hour) and 24H (hour), and the date MM/DD (month and day) and DD/MM (day and month) display.
2. Press the pushbutton located under the desired option.
3. Press  again to apply the selected default, or let the screen time out.

Power Outlets

The vehicle has 12-volt outlets that can be used to plug in electrical equipment, such as a cell phone or MP3 player.

The power outlets are located on the instrument panel below the climate controls, inside the center floor console, at the rear of the center console, and in the rear cargo area. Lift the cover to access the outlet and replace when not in use.

 **WARNING**

Power is always supplied to the outlets. Do not leave electrical equipment plugged in when the vehicle is not in use because the vehicle could catch fire and cause injury or death.

Notice: Leaving electrical equipment plugged in for an extended period of time while the vehicle is off will drain the battery. Always unplug electrical equipment when not in use and do not plug in equipment that exceeds the maximum 20 ampere rating.

Certain accessory plugs may not be compatible with the accessory power outlet and could overload vehicle and adapter fuses. If a problem is experienced, see your dealer.

When adding electrical equipment, be sure to follow the proper installation instructions included with the equipment. See *Add-On Electrical Equipment* on page 9-58.

Notice: Hanging heavy equipment from the power outlet can cause damage not covered by the vehicle warranty. The power outlets are designed for accessory power plugs only, such as cell phone charge cords.

Power Outlet 110 Volt Alternative Current

The vehicle may have a power outlet that can be used to plug in electrical equipment that uses a maximum limit of 150 watts.



The power outlet is located on the rear of the center console.

An indicator light on the outlet turns on to show it is in use. The light comes on when the ignition is in ON/RUN and equipment requiring less than 150 watts is plugged into the outlet, and no system fault is detected.

If equipment is connected using more than 150 watts or a system fault is detected, a protection circuit shuts off the power supply and the indicator light turns off. To reset the circuit, unplug the item and plug it back in or turn the Retained Accessory Power (RAP) off and then back on. See *Retained Accessory Power (RAP)* on page 9-21. The power restarts when equipment using 150 watts or less is plugged into the outlet and a system fault is not detected.

The power outlet is not designed for and may not work properly, if the following are plugged in:

- Equipment with high initial peak wattage such as: compressor-driven refrigerators and electric power tools.
- Other equipment requiring an extremely stable power supply such as: microcomputer-controlled electric blankets, touch sensor lamps, etc.

See *High Voltage Devices and Wiring* on page 10-31.

Warning Lights, Gauges, and Indicators

Warning lights and gauges can signal that something is wrong before it becomes serious enough to cause an expensive repair or replacement. Paying attention to the warning lights and gauges could prevent injury.

Warning lights come on when there could be a problem with a vehicle function. Some warning lights come on briefly when the engine is started to indicate they are working.

Gauges can indicate when there could be a problem with a vehicle function. Often gauges and warning lights work together to indicate a problem with the vehicle.

When one of the warning lights comes on and stays on while driving, or when one of the gauges shows there may be a problem, check the section that explains what to do. Follow this manual's advice. Waiting to do repairs can be costly and even dangerous.

Instrument Cluster

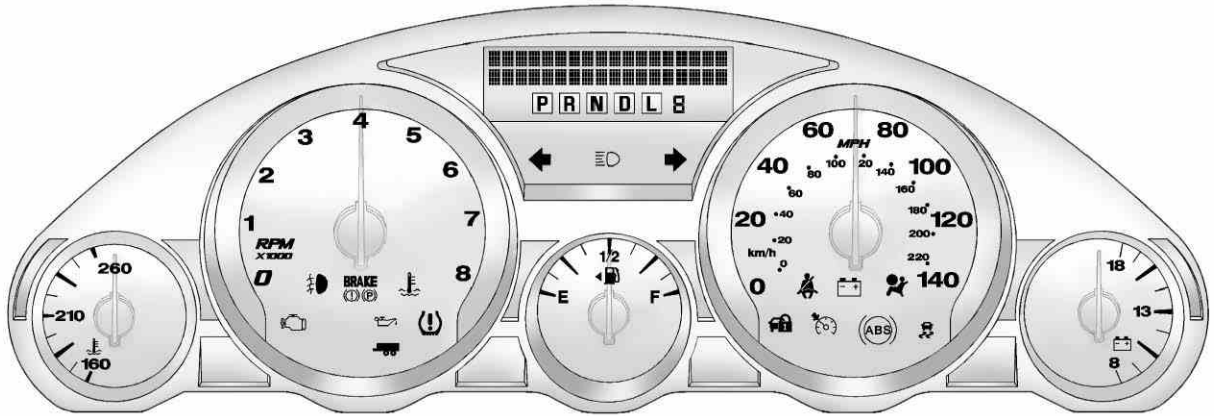

English Shown, Metric Similar

5-14 Instruments and Controls

Speedometer

The speedometer shows the vehicle's speed in either kilometers per hour (km/h) or miles per hour (mph).

Odometer

The odometer shows how far the vehicle has been driven, in either kilometers or miles.

This vehicle has a tamper-resistant odometer. If the vehicle needs a new odometer installed, the new one is set to the mileage of the old odometer. If this is not possible, it is set at zero and a label is put on the driver door to show the old mileage reading.

Tachometer

The tachometer displays the engine speed in revolutions per minute (rpm).

Fuel Gauge

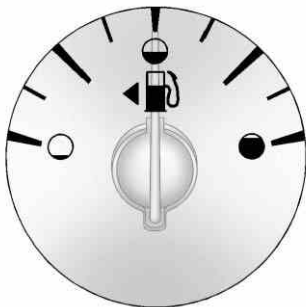

Metric

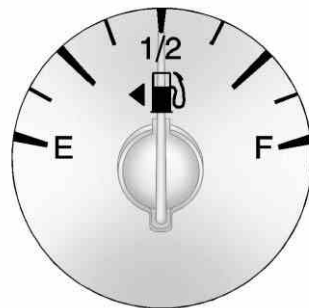

English

When the ignition is on, the fuel gauge shows about how much fuel the vehicle has left in the fuel tank.

An arrow on the fuel gauge indicates the side of the vehicle the fuel door is on.

The gauge will first indicate empty before the vehicle is out of fuel, but the vehicle's fuel tank should be filled soon.

When the fuel tank is low on fuel, the FUEL LEVEL LOW message appears on the Driver Information Center (DIC). For more information see *Fuel System Messages on page 5-35*.

Here are some situations that can occur with the fuel gauge. None of these indicate a problem with the fuel gauge.

- At the gas station, the fuel pump shuts off before the gauge reads full.
- It takes a little more or less fuel to fill up than the fuel gauge indicated. For example, the gauge may have indicated the tank was half full, but it actually took a little more or less than half the tank's capacity to fill the tank.

- The gauge moves a little while turning a corner or speeding up.
- The gauge goes back to empty when the ignition is turned off.

Engine Coolant Temperature Gauge

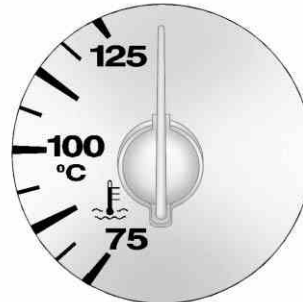

Metric

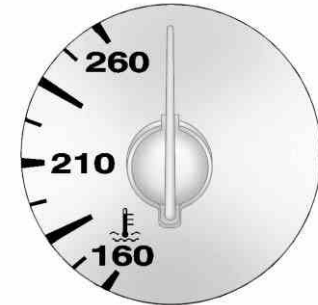

English

This gauge shows the engine coolant temperature. Under normal driving conditions the gauge will read 100°C (210°F) or less. If the gauge pointer is near 125°C (260°F), the engine is too hot.

It means that the engine coolant has overheated. If the vehicle has been operating under normal driving conditions, pull off the road, stop the vehicle, and turn off the engine as soon as possible.

See *Engine Overheating on page 10-18* for more information.

Voltmeter Gauge

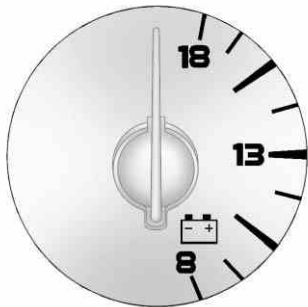

When the engine is not running, but the ignition is on, this gauge shows the battery's state of charge in DC volts.

When the engine is running, this gauge shows the condition of the charging system. The vehicle's charging system regulates voltage based on the state of charge of the battery. The voltmeter may fluctuate.

This is normal. Readings between the low and high warning zones indicate the normal operating range.

Readings in the low warning zone may occur when a large number of electrical accessories are operating in the vehicle and the engine is left idling for an extended period.

If there is a problem with the battery charging system, a SERVICE BATTERY CHARGING SYSTEM message appears in the Driver Information Center (DIC) and/or the charging system light comes on. See *Battery Voltage and Charging Messages* on page 5-32 for more information.

However, readings in either warning zone can indicate a possible problem in the electrical system. Have the vehicle serviced as soon as possible.

Safety Belt Reminders

Driver Safety Belt Reminder Light

There is a driver safety belt reminder light on the instrument panel cluster.



When the vehicle is started, this light flashes and a chime may come on to remind the driver to fasten their safety belt. Then the light stays on solid until the belt is buckled.

This cycle may continue several times if the driver remains or becomes unbuckled while the vehicle is moving.

If the driver safety belt is buckled, neither the light nor the chime comes on.

Passenger Safety Belt Reminder Light



When the vehicle is started, this light flashes and a chime may come on to remind front passengers to fasten their safety belt. Then the light stays on solid until the belt is buckled.

This cycle continues several times if the front passenger remains or becomes unbuckled while the vehicle is moving.

If the front passenger safety belt is buckled, neither the chime nor the light comes on.

The front passenger safety belt reminder light and chime may turn on if an object is put on the seat such as a briefcase, handbag, grocery bag, laptop, or other electronic device. To turn off the reminder light and/or chime, remove the object from the seat or buckle the safety belt.

Airbag Readiness Light

This light shows if there is an electrical problem. The system check includes the airbag sensor(s), passenger sensing system, the pretensioners, the airbag modules, the wiring, and the crash sensing and diagnostic module. For more information on the airbag system, see *Airbag System on page 3-23*.



The airbag readiness light comes on and stays on for several seconds when the vehicle is started. Then the light goes out.

WARNING

If the airbag readiness light stays on after the vehicle is started or comes on while driving, it means the airbag system might not be working properly. The airbags in the vehicle might not inflate in a crash, or they could even inflate without a crash. To help avoid injury, have the vehicle serviced right away.

Passenger Airbag Status Indicator

The vehicle has a passenger sensing system. See *Passenger Sensing System* on page 3-31 for important safety information. The instrument panel has a passenger airbag status indicator.



United States



Canada and Mexico

When the vehicle is started, the passenger airbag status indicator will light ON and OFF, or the symbol for on and off, for several seconds as a system check. If you use remote start, if equipped, to start the vehicle, you may not see the system check. Then, after several more seconds, the status indicator will light either ON or OFF, or either the on or off symbol to let you know the status of the front outboard passenger frontal airbag.

If the word ON or the on symbol is lit on the passenger airbag status indicator, it means that the front outboard passenger frontal airbag is allowed to inflate.

If the word OFF or the off symbol is lit on the passenger airbag status indicator, it means that the passenger sensing system has turned off the front outboard passenger frontal airbag.

If, after several seconds, both status indicator lights remain on, or if there are no lights at all, there may be a problem with the lights or the passenger sensing system. See your dealer for service.

 **WARNING**

If the airbag readiness light ever comes on and stays on, it means that something may be wrong with the airbag system. To help avoid injury to yourself or others, have the vehicle serviced right away. See *Airbag Readiness Light* on page 5-17 for more information, including important safety information.

Charging System Light

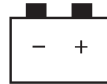

The charging system light comes on briefly when the ignition is turned on, but the engine is not running, as a check to show the light is working. It should go out when the engine is started.

If the light stays on, or comes on while driving, there may be a problem with the electrical charging system. Have it checked by your dealer. Driving while this light is on could drain the battery.

When this light comes on, the Driver Information Center (DIC) also displays the SERVICE BATTERY CHARGING SYSTEM message.

See *Vehicle Messages* on page 5-31 for more information.

If a short distance must be driven with the light on, be sure to turn off all accessories, such as the radio and air conditioner.

Malfunction Indicator Lamp

A computer system called OBD II (On-Board Diagnostics-Second Generation) monitors the operation of the vehicle to ensure emissions are at acceptable levels, to produce a cleaner environment. This light comes on when the vehicle is placed in ON/RUN, as a check to show it is working. If it does not, have the vehicle serviced by your dealer. See *Ignition Positions* on page 9-18 for more information.



If the malfunction indicator lamp comes on and stays on while the engine is running, this indicates that there is an OBD II problem and service is required.

Malfunctions often are indicated by the system before any problem is apparent. Being aware of the light can prevent more serious damage to the vehicle. This system assists the service technician in correctly diagnosing any malfunction.

Notice: If the vehicle is continually driven with this light on, the emission controls might not work as well, the vehicle fuel economy might not be as good, and the engine might not run as smoothly. This could lead to costly repairs that might not be covered by the vehicle warranty.

Notice: Modifications made to the engine, transmission, exhaust, intake, or fuel system of the vehicle or the replacement of the original tires with other than those of the same Tire Performance Criteria (TPC) can affect the vehicle's emission controls and can cause this light to come on. Modifications to these systems could lead to

costly repairs not covered by the vehicle warranty. This could also result in a failure to pass a required Emission Inspection/Maintenance test. See *Accessories and Modifications* on page 10-3.

This light comes on during a malfunction in one of two ways:

Light Flashing: A misfire condition has been detected. A misfire increases vehicle emissions and could damage the emission control system on the vehicle. Diagnosis and service might be required.

To prevent more serious damage to the vehicle:

- Reduce vehicle speed.
- Avoid hard accelerations.
- Avoid steep uphill grades.
- If towing a trailer, reduce the amount of cargo being hauled as soon as it is possible.

If the light continues to flash, stop and park the vehicle. Turn the vehicle off, wait at least 10 seconds, and restart the engine. If the light is still flashing, follow the previous steps and see your dealer for service as soon as possible.

Light On Steady: An emission control system malfunction has been detected on the vehicle. Diagnosis and service might be required.

The following may correct an emission system malfunction:

- Check that the fuel cap is fully installed. See *Filling the Tank on page 9-46*. The diagnostic system can determine if the fuel cap has been left off or improperly installed. A loose or missing fuel cap allows fuel to evaporate into the atmosphere. A few driving trips with the cap properly installed should turn the light off.

- Check that good quality fuel is used. Poor fuel quality causes the engine not to run as efficiently as designed and may cause stalling after start-up, stalling when the vehicle is changed into gear, misfiring, hesitation on acceleration, or stumbling on acceleration. These conditions might go away once the engine is warmed up.

If one or more of these conditions occurs, change the fuel brand used. It will require at least one full tank of the proper fuel to turn the light off.

See *Recommended Fuel on page 9-44*.

If none of the above have made the light turn off, your dealer can check the vehicle. The dealer has the proper test equipment and diagnostic tools to fix any mechanical or electrical problems that might have developed.

Emissions Inspection and Maintenance Programs

Some local governments may have programs to inspect the on-vehicle emission control equipment. For the inspection, the emission system test equipment is connected to the vehicle's Data Link Connector (DLC).



The DLC is under the instrument panel to the left of the steering wheel. See your dealer if assistance is needed.

5-22 Instruments and Controls

The vehicle may not pass inspection if:

- The malfunction indicator lamp is on with the engine running, or if the light does not come on when the ignition is turned to ON/RUN while the engine is off.
- The OBD II (On-Board Diagnostics) system determines that critical emission control systems have not been completely diagnosed. The vehicle would be considered not ready for inspection. This can happen if the 12-volt battery has recently been replaced or run down. The diagnostic system is designed to evaluate critical emission control systems during normal driving. This can take several days of routine driving. If this has been done and the vehicle still does not pass the inspection for lack of OBD II system readiness, your dealer can prepare the vehicle for inspection.

Brake System Warning Light

The vehicle brake system consists of two hydraulic circuits. If one circuit is not working, the remaining circuit can still work to stop the vehicle. For normal braking performance, both circuits need to be working.

If the warning light comes on, there is a brake problem. Have the brake system inspected right away.



Metric



English

This light should come on briefly when the ignition key is turned to ON/RUN. If it does not come on then, have it fixed so it will be ready to warn if there is a problem.

This light may also come on due to low brake fluid. See *Brakes on page 10-23* for more information.

When the ignition is on, the brake system warning light will also come on when the parking brake is set. The light will stay on if the parking brake does not release fully. If it stays on after the parking brake is fully released, it means there is a brake problem.

If the light comes on while driving, pull off the road and stop carefully. Make sure the parking brake is fully released. The pedal may be harder to push or, the pedal may go closer to the floor.

It may take longer to stop. If the light is still on, have the vehicle towed for service. See *Towing the Vehicle* on page 10-83.

 **WARNING**

The brake system might not be working properly if the brake system warning light is on. Driving with the brake system warning light on can lead to a crash. If the light is still on after the vehicle has been pulled off the road and carefully stopped, have the vehicle towed for service.

The brake message remains on until any DIC button is pressed. The brake light remains on until the problem is fixed. See *Brake System Messages* on page 5-32 for more information.

Antilock Brake System (ABS) Warning Light



The ABS warning light comes on briefly when the ignition key is turned to ON/RUN. This is normal. If the light does not come on then, have it fixed so it will be ready to warn you if there is a problem.

If the light stays on, turn the ignition to LOCK/OFF. If the light comes on while driving, stop as soon as possible and turn the ignition off. Then start the engine again to reset the system. If the light still stays on, or comes on again while driving, the

vehicle needs service. If the regular brake system warning light is not on, there are still brakes, but no antilock brakes. If the regular brake system warning light is also on, there are no antilock brakes and there is a problem with the regular brakes. See *Brake System Warning Light* on page 5-22.

Tow/Haul Mode Light



This light comes on when the Tow/Haul mode has been activated. For more information, see *Tow/Haul Mode* on page 9-29.

StabiliTrak[®] Indicator Light



This light comes on briefly while starting the engine. If it does not, have the vehicle serviced by your dealer. If the system is working normally, the indicator light goes off.

If it stays on, or comes on while driving, there could be a problem with the StabiliTrak system and the vehicle might need service. When this warning light is on, the system is off and will not limit wheel spin.

This light flashes when the StabiliTrak system is active.

See *StabiliTrak[®] System* on page 9-32 for more information.

Engine Coolant Temperature Warning Light



The engine coolant temperature warning light comes on briefly when the vehicle is started.

If it does not, have the vehicle serviced by your dealer. If the system is working normally, the indicator light then goes off.

If the light comes on and stays on while driving, the vehicle may have a problem with the cooling system. Stop and turn off the vehicle to avoid damage to the engine. A warning chime sounds when this light is on.

See *Engine Overheating* on page 10-18 for more information.

Tire Pressure Light



For vehicles with the Tire Pressure Monitor System (TPMS), this light comes on briefly when the engine is started. It provides information about tire pressures and the TPMS.

When the Light Is On Steady

This indicates that one or more of the tires are significantly underinflated.

A Driver Information Center (DIC) tire pressure message may also display. See *Vehicle Messages* on page 5-31 for more information. Stop as soon as possible, and inflate the tires to the pressure value shown on the Tire and Loading Information label. See *Tire Pressure* on page 10-45 for more information.

When the Light Flashes First and Then Is On Steady

If the light flashes for about a minute and then stays on, there may be a problem with the TPMS. If the problem is not corrected, the light will come on at every ignition cycle. See *Tire Pressure Monitor Operation on page 10-48* for more information.

Engine Oil Pressure Light

WARNING

Do not keep driving if the oil pressure is low. The engine can become so hot that it catches fire. Someone could be burned. Check the oil as soon as possible and have the vehicle serviced.

Notice: Lack of proper engine oil maintenance can damage the engine. The repairs would not be covered by the vehicle warranty. Always follow the maintenance schedule for changing engine oil.



The oil pressure light should come on briefly as the engine is started. If it does not come on have the vehicle serviced by your dealer. If the light comes on and stays on, it means that oil is not flowing through the engine properly. The vehicle could be low on oil and might have some other system problem.

Security Light



The security light should come on briefly as the engine is started. If the system is working normally, the indicator light turns off. If it does not come on, have the vehicle serviced by your dealer.

If the light stays on and the engine does not start, there could be a problem with the theft-deterrent system.

This light is also used to indicate the status of the anti-theft alarm system when the ignition is turned off.

The light will flash rapidly if the alarm system is arming and one or more of the monitored entry points is not closed. The light will stay on if the alarm is arming and all entry points are closed.

For information regarding this light and the vehicle's security system, see *Anti-theft Alarm System* on page 2-14.

High-Beam On Light



The high-beam on light comes on when the high-beam headlamps are in use.

See *Headlamp High/Low-Beam Changer* on page 6-2 for more information.

Front Fog Lamp Light



The fog lamp light comes on when the fog lamps are in use.

The light goes out when the fog lamps are turned off. See *Fog Lamps* on page 6-5 for more information.

Cruise Control Light



This light comes on whenever the cruise control is set.

The light goes out when the cruise control is turned off. See *Cruise Control* on page 9-34 for more information.

Information Displays

Driver Information Center (DIC)

Your vehicle has a Driver Information Center (DIC).

The DIC displays information about your vehicle. It also displays warning messages if a system problem is detected.

All messages will appear in the DIC display located at the top of the instrument panel cluster.

The DIC comes on when the ignition is on. After a short delay, the DIC will display the information that was last displayed before the engine was turned off.

The DIC also displays a shift lever position indicator on the bottom line of the display. See *Automatic Transmission* on page 9-26 for more information.

The outside air temperature and compass, if equipped, also display on the DIC when viewing the trip and fuel information. The outside air temperature automatically appears in the top right corner of the DIC display. If there is a problem with the system that controls the temperature display, the numbers will be replaced with dashes. If this occurs, have the vehicle serviced. The compass will be shown in the bottom right corner of the DIC display. See *Compass* on page 5-7 for more information.

The DIC has different displays which can be accessed by pressing the DIC buttons located on the instrument panel.

The DIC displays trip, fuel, and vehicle system information, and warning messages if a system problem is detected.

The DIC also allows some features to be customized. See *Vehicle Personalization* on page 5-41 for more information.

DIC Buttons



The buttons are the set/reset, customization, vehicle information, and trip/fuel buttons. The button functions are detailed in the following pages.

✓ (Set/Reset): Press this button to set or reset certain functions and to turn off or acknowledge messages on the DIC.

⊞ (Customization): Press this button to customize the feature settings on your vehicle. See *Vehicle Personalization* on page 5-41 for more information.

 **(Vehicle Information):** Press this button to display the oil life, park assist on vehicles with this feature, units, tire pressure readings on vehicles with this feature, and compass calibration and zone setting on vehicles with this feature.

 **(Trip/Fuel):** Press this button to display the odometer, trip odometers, fuel range, average economy, timer, fuel used, and average speed.

Vehicle Information Menu Items

 **(Vehicle Information):** Press this button to scroll through the following menu items:

OIL LIFE

Press the vehicle information button until OIL LIFE REMAINING displays. This display shows an estimate of the oil's remaining useful life. If you see 99% OIL LIFE REMAINING on the display, that means 99% of the current oil life remains. The engine oil life system

will alert you to change the oil on a schedule consistent with your driving conditions.

When the remaining oil life is low, the CHANGE ENGINE OIL SOON message will appear on the display. See "CHANGE ENGINE OIL SOON" under *Engine Oil Messages on page 5-34*. You should change the oil as soon as you can. See *Engine Oil on page 10-8*. In addition to the engine oil life system monitoring the oil life, additional maintenance is recommended in the Maintenance Schedule in this manual. See *Maintenance Schedule on page 11-2* for more information.

Remember, you must reset the OIL LIFE display yourself after each oil change. It will not reset itself. Also, be careful not to reset the OIL LIFE display accidentally at any time other than when the oil has just been changed. It cannot be reset accurately until the next oil change. To reset the engine oil life system, see *Engine Oil Life System on page 10-10*.

PARK ASSIST

If your vehicle has the Ultrasonic Rear Parking Assist (URPA) system, press the vehicle information button until PARK ASSIST displays. This display allows the system to be turned on or off. Once in this display, press the set/reset button to select between ON or OFF. If you choose ON, the system will be turned on. If you choose OFF, the system will be turned off. The URPA system automatically turns back on after each vehicle start. When the URPA system is turned off and the vehicle is shifted out of P (Park), the DIC will display the PARK ASSIST OFF message as a reminder that the system has been turned off. See *Object Detection System Messages on page 5-36* and *Ultrasonic Parking Assist on page 9-37* for more information.

UNITS

Press the vehicle information button until UNITS displays. This display allows you to select between English or metric units of measurement. Once in this display, press the set/reset button to select between ENGLISH or METRIC units. All of the vehicle information will then be displayed in the unit of measurement selected.

FRONT TIRES or REAR TIRES

On vehicles with the Tire Pressure Monitor System (TPMS), the pressure for each tire can be viewed in the DIC. The tire pressure will be shown in either kilopascals (kPa) or pounds per square inch (psi). Press the vehicle information button until the DIC displays FRONT TIRES kPa (PSI) LEFT ## RIGHT ##. Press the vehicle information button again until the DIC displays REAR TIRES kPa (PSI) LEFT ## RIGHT ##.

If a low tire pressure condition is detected by the system while driving, a message advising you add air to a specific tire will appear in the display. See *Tire Pressure on page 10-45* and *Tire Messages on page 5-38* for more information.

If the tire pressure display shows dashes instead of a value, there may be a problem with your vehicle. If this consistently occurs, see your dealer for service.

COMPASS ZONE SETTING

This display will be available if the vehicle has a compass. See *Compass on page 5-7* for more information.

COMPASS RECALIBRATION

This display will be available if the vehicle has a compass. See *Compass on page 5-7* for more information.

Blank Display

This display shows no information.

Trip/Fuel Menu Items

 (Trip/Fuel): Press this button to scroll through the following menu items:

ODOMETER

Press the trip/fuel button until ODOMETER displays. This display shows the distance the vehicle has been driven in either kilometers (km) or miles (mi).

To switch between English and metric measurements, see “UNITS” earlier in this section.

TRIP A and TRIP B

Press the trip/fuel button until TRIP A or TRIP B displays. This display shows the current distance traveled in either kilometers (km) or miles (mi) since the last reset for each trip odometer. Both trip odometers can be used at the same time.

5-30 Instruments and Controls

Each trip odometer can be reset to zero separately by pressing the set/reset button while the desired trip odometer is displayed.

The trip odometer has a feature called retroactive reset. This can be used to set the trip odometer to the number of kilometers (miles) driven since the ignition was last turned on. This can be used if the trip odometer is not reset at the beginning of the trip.

To use the retroactive reset feature, press and hold the set/reset button for at least four seconds. The trip odometer will display the number of kilometers (km) or miles (mi) driven since the ignition was last turned on and the vehicle was moving. Once the vehicle begins moving, the trip odometer will accumulate mileage. For example, if the vehicle was driven 8 km (5 mi) before it is started again, and then the retroactive reset feature is activated, the display will show 8 km (5 mi). As the vehicle

begins moving, the display will then increase to 8.2 km (5.1 mi), 8.4 km (5.2 mi), etc.

If the retroactive reset feature is activated after the vehicle is started, but before it begins moving, the display will show the number of kilometers (km) or miles (mi) driven during the last ignition cycle.

RANGE

Press the trip/fuel button until RANGE displays. This display shows the approximate number of remaining kilometers (km) or miles (mi) the vehicle can be driven without refueling. The display will show LOW if the fuel level is low.

The fuel range estimate is based on an average of the vehicle's fuel economy over recent driving history and the amount of fuel remaining in the fuel tank. This estimate will change if driving conditions change.

For example, if driving in traffic and making frequent stops, this display may read one number, but if the vehicle is driven on a freeway, the number may change even though the same amount of fuel is in the fuel tank. This is because different driving conditions produce different fuel economies. Generally, freeway driving produces better fuel economy than city driving. Fuel range cannot be reset.

AVG (Average) ECONOMY

Press the trip/fuel button until AVG ECONOMY displays. This display shows the approximate average liters per 100 kilometers (L/100 km) or miles per gallon (mpg). This number is calculated based on the number of L/100 km (mpg) recorded since the last time this menu item was reset. To reset AVG ECONOMY, press and hold the set/reset button.

TIMER

Press the trip/fuel button until TIMER displays. This display can be used as a timer.

To start the timer, press the set/reset button while TIMER is displayed. The display will show the amount of time that has passed since the timer was last reset, not including time the ignition is off. Time will continue to be counted as long as the ignition is on, even if another display is being shown on the DIC. The timer will record up to 99 hours, 59 minutes and 59 seconds (99:59:59) after which the display will return to zero.

To stop the timer, press the set/reset button briefly while TIMER is displayed.

To reset the timer to zero, press and hold the set/reset button while TIMER is displayed.

FUEL USED

Press the trip/fuel button until FUEL USED displays. This display shows the number of liters (L) or gallons (gal) of fuel used since the last reset of this menu item. To reset the fuel used information, press and hold the set/reset button while FUEL USED is displayed.

AVG (Average) SPEED

Press the trip/fuel button until AVG SPEED displays. This display shows the average speed of the vehicle in kilometers per hour (km/h) or miles per hour (mph). This average is calculated based on the various vehicle speeds recorded since the last reset of this value. To reset the value to zero, press and hold the set/reset button.

Blank Display

This display shows no information.

Vehicle Messages

Messages are displayed on the DIC to notify the driver that the status of the vehicle has changed and that some action may be needed by the driver to correct the condition. Multiple messages may appear one after another.

Some messages may not require immediate action, but you can press any of the DIC buttons on the instrument panel to acknowledge that you received the messages and to clear them from the display.

Some messages cannot be cleared from the DIC display because they are more urgent. These messages require action before they can be cleared. You should take any messages that appear on the display seriously and remember that clearing the messages will only make the messages disappear, not correct the problem.

The following are the possible messages that can be displayed and some information about them.

Battery Voltage and Charging Messages

BATTERY SAVER ACTIVE

This message displays when the system detects that the battery voltage is dropping below expected levels. The battery saver system starts reducing certain features of the vehicle that you may be able to notice. At the point that the features are disabled, this message is displayed. It means that the vehicle is trying to save the charge in the battery.

Turn off all unnecessary accessories to allow the battery to recharge.

The normal battery voltage range is 11.5 to 15.5 volts.

SERVICE BATTERY CHARGING SYSTEM

On some vehicles, this message displays if there is a problem with the battery charging system. Under certain conditions, the charging system light may also turn on in the instrument panel cluster. See *Charging System Light on page 5-19*. Driving with this problem could drain the battery. Turn off all unnecessary accessories. Have the electrical system checked as soon as possible. See your dealer.

Brake System Messages

SERVICE BRAKE SYSTEM

This message displays along with the brake system warning light if there is a problem with the brake system. See *Brake System Warning Light on page 5-22*. If this message appears, stop as soon as possible and turn off the vehicle. Restart the vehicle and check for the message

on the DIC display. If the message is still displayed or appears again when you begin driving, the brake system needs service as soon as possible. See your dealer.

Cruise Control Messages

CRUISE SET TO XXX

This message displays whenever the cruise control is set. See *Cruise Control on page 9-34* for more information.

Door Ajar Messages

DRIVER DOOR OPEN

This message displays and a chime sounds if the driver door is not fully closed and the vehicle is shifted out of P (Park). Stop and turn off the vehicle, check the door for obstructions, and close the door again. Check to see if the message still appears on the DIC.

HOOD OPEN

On some models, this message displays and a chime sounds if the hood is not fully closed. Stop and turn off the vehicle, check the hood for obstructions, and close the hood again. Check to see if the message still appears on the DIC.

LEFT REAR DOOR OPEN

This message displays and a chime sounds if the driver side rear door is not fully closed and the vehicle is shifted out of P (Park). Stop and turn off the vehicle, check the door for obstructions, and close the door again. Check to see if the message still appears on the DIC.

LIFTGATE OPEN

This message displays and a chime sounds if the liftgate is open while the ignition is in ON/RUN. Turn off the vehicle and check the liftgate. Restart the vehicle and check for the message on the DIC display.

PASSENGER DOOR OPEN

This message displays and a chime sounds if the passenger door is not fully closed and the vehicle is shifted out of P (Park). Stop and turn off the vehicle, check the door for obstructions, and close the door again. Check to see if the message still appears on the DIC.

POWER LIFTGATE OFF

This message displays when the power liftgate has been turned off by pressing the power liftgate button on the center console.

RIGHT REAR DOOR OPEN

This message displays and a chime sounds if the passenger side rear door is not fully closed and the vehicle is shifted out of P (Park). Stop and turn off the vehicle, check the door for obstructions, and close the door again. Check to see if the message still appears on the DIC.

Engine Cooling System Messages

ENGINE HOT A/C (Air Conditioning) OFF

This message displays when the engine coolant becomes hotter than the normal operating temperature. See *Engine Coolant Temperature Gauge on page 5-15*. To avoid added strain on a hot engine, the air conditioning compressor automatically turns off. When the coolant temperature returns to normal, the air conditioning compressor turns back on. You can continue to drive your vehicle.

If this message continues to appear, have the system repaired by your dealer as soon as possible to avoid damage to the engine.

ENGINE OVERHEATED IDLE ENGINE

Notice: If you drive the vehicle while the engine is overheating, severe engine damage may occur. If an overheat warning appears on the instrument panel cluster and/or DIC, stop the vehicle as soon as possible. Do not increase the engine speed above normal idling speed. See *Engine Overheating on page 10-18* for more information.

This message displays when the engine coolant temperature is too hot. Stop and allow the vehicle to idle until it cools down. See *Engine Coolant Temperature Gauge on page 5-15*.

See *Overheated Engine Protection Operating Mode on page 10-20* for information on driving to a safe place in an emergency.

ENGINE OVERHEATED STOP ENGINE

Notice: If you drive the vehicle while the engine is overheating, severe engine damage may occur. If an overheat warning appears on the instrument panel cluster and/or DIC, stop the vehicle as soon as possible. Do not increase the engine speed above normal idling speed. See *Engine Overheating on page 10-18* for more information.

This message displays and a continuous chime sounds if the engine cooling system reaches unsafe temperatures for operation. Stop and turn off the vehicle as soon as it is safe to do so to avoid severe damage. This message clears when the engine has cooled to a safe operating temperature.

Engine Oil Messages

CHANGE ENGINE OIL SOON

This message displays when the engine oil needs to be changed. When you change the engine oil, be sure to reset the CHANGE ENGINE OIL SOON message. See *Engine Oil Life System on page 10-10* for information on how to reset the message. See *Engine Oil on page 10-8* and *Maintenance Schedule on page 11-2* for more information.

OIL PRESSURE LOW STOP ENGINE

Notice: If you drive the vehicle while the engine oil pressure is low, severe engine damage may occur. If a low oil pressure warning appears on the instrument panel cluster and/or DIC, stop the vehicle as soon as possible. Do not drive the vehicle until the cause of the low oil pressure is corrected. See *Engine Oil* on page 10-8 for more information.

This message displays if low oil pressure levels occur. Stop the vehicle as soon as safely possible and do not operate it until the cause of the low oil pressure has been corrected. Check the oil as soon as possible and have your vehicle serviced by your dealer. See *Engine Oil* on page 10-8.

Engine Power Messages ENGINE POWER IS REDUCED

This message displays and a chime sounds when the cooling system temperature gets too hot and the engine further enters the engine coolant protection mode. See *Engine Overheating* on page 10-18 for further information.

This message also displays when the vehicle's engine power is reduced. Reduced engine power can affect the vehicle's ability to accelerate. If this message is on, but there is no reduction in performance, proceed to your destination. The performance may be reduced the next time the vehicle is driven. The vehicle may be driven at a reduced speed while this message is on, but acceleration and speed may be reduced. Anytime this message stays on, the vehicle should be taken to your dealer for service as soon as possible.

Fuel System Messages FUEL LEVEL LOW

This message displays and a chime sounds if the fuel level is low. Refuel as soon as possible. See *Fuel Gauge* on page 5-14 and *Fuel* on page 9-44 for more information.

TIGHTEN GAS CAP

This message may display along with the check engine light on the instrument panel cluster if the vehicle's fuel cap is not tightened properly. See *Malfunction Indicator Lamp* on page 5-20. Reinstall the fuel cap fully. See *Filling the Tank* on page 9-46. The diagnostic system can determine if the fuel cap has been left off or improperly installed. A loose or missing fuel cap allows fuel to evaporate into the atmosphere. A few driving trips with the cap properly installed should turn this light and message off.

Key and Lock Messages

REPLACE BATTERY IN REMOTE KEY

This message displays if a Remote Keyless Entry (RKE) transmitter battery is low. The battery needs to be replaced in the transmitter. See “Battery Replacement” under *Remote Keyless Entry (RKE) System Operation on page 2-3*.

Lamp Messages

AUTOMATIC LIGHT CONTROL OFF

This message displays when the automatic headlamps are turned off. This message clears itself after 10 seconds.

AUTOMATIC LIGHT CONTROL ON

This message displays when the automatic headlamps are turned on. This message clears itself after 10 seconds.

TURN SIGNAL ON

This message displays and a chime sounds if a turn signal is left on for 1.2 km (0.75 mi). Move the turn signal/multifunction lever to the off position.

Object Detection System Messages

PARK ASST (Assist) BLOCKED SEE OWNERS MANUAL

This message displays if there is something interfering with the park assist system. See *Ultrasonic Parking Assist on page 9-37* for more information.

PARK ASSIST OFF

After the vehicle has been started, this message displays to remind the driver that the URPA system has been turned off. Press the set/reset button or the trip odometer reset stem to acknowledge this message and clear it from the DIC display. For more information see *Ultrasonic Parking Assist on page 9-37*.

SERVICE PARK ASSIST

This message displays if there is a problem with the Ultrasonic Rear Parking Assist (URPA) system. Do not use this system to help you park. See *Ultrasonic Parking Assist on page 9-37* for more information. See your dealer for service.

Ride Control System Messages

SERVICE STABILITRAK

This message displays if there is a problem with the StabiliTrak[®] system. If this message appears, try to reset the system. Stop; turn off the engine for at least 15 seconds; then start the engine again. If this message still comes on, it means there is a problem. See your dealer for service. The vehicle is safe to drive, however, you do not have the benefit of StabiliTrak, so reduce your speed and drive accordingly.

SERVICE TRACTION CONTROL

This message displays when there is a problem with the Traction Control System (TCS). When this message is displayed, the system will not limit wheel spin. Adjust your driving accordingly. See your dealer for service. See *StabiliTrak[®] System on page 9-32* for more information.

TRACTION CONTROL OFF

This message displays when the Traction Control System (TCS) is turned off. Adjust your driving accordingly. See *StabiliTrak[®] System on page 9-32* for more information. This message clears itself after 10 seconds.

TRACTION CONTROL ON

This message displays when the Traction Control System (TCS) is turned on. See *StabiliTrak[®] System on page 9-32* for more information. This message clears itself after 10 seconds.

Airbag System Messages

SERVICE AIR BAG

This message displays if there is a problem with the airbag system. Have your dealer inspect the system for problems. See *Airbag Readiness Light on page 5-17* and *Airbag System on page 3-23* for more information.

Anti-theft Alarm System Messages

SERVICE THEFT DETERRENT SYSTEM

This message displays when there is a problem with the theft-deterrent system. The vehicle may or may not restart so you may want to take the vehicle to your dealer before turning off the engine. See *Immobilizer Operation on page 2-15* for more information.

THEFT ATTEMPTED

This message displays if the content theft-deterrent system has detected a break-in attempt while you were away from your vehicle. See *Anti-theft Alarm System on page 2-14* for more information.

Service Vehicle Messages

SERVICE A/C (Air Conditioning) SYSTEM

This message displays when the electronic sensors that control the air conditioning and heating systems are no longer working. Have the climate control system serviced by your dealer if you notice a drop in heating and air conditioning efficiency.

SERVICE POWER STEERING

This message displays when a problem is detected with the power steering system. When this message is displayed, you may notice that the effort required to steer the vehicle increases or feels heavier, but you will still be able to steer the vehicle. Have your vehicle serviced by your dealer immediately.

SERVICE VEHICLE SOON

This message displays when a non-emissions related malfunction occurs. Have the vehicle serviced by your dealer as soon as possible.

STARTING DISABLED SERVICE THROTTLE

This message displays when your vehicle's throttle system is not functioning properly. Have your vehicle serviced by your dealer.

Tire Messages

TIRE LOW ADD AIR TO TIRE

On vehicles with the Tire Pressure Monitor System (TPMS), this message displays when the pressure in one or more of the vehicle's tires is low.

This message also displays LEFT FRT (left front), RIGHT FRT (right front), LEFT RR (left rear), or RIGHT RR (right rear) to indicate the location of the low tire.

The low tire pressure warning light will also come on. See *Tire Pressure Light* on page 5-24.

If a tire pressure message appears on the DIC, stop as soon as you can. Inflate the tires by adding air until the tire pressure is equal to the values shown on the Tire and Loading Information label. See *Tires* on page 10-38, *Vehicle Load Limits* on page 9-12, and *Tire Pressure* on page 10-45.

You can receive more than one tire pressure message at a time. To read the other messages that may have been sent at the same time, press the set/reset button or the trip odometer reset stem. The DIC also shows the tire pressure values. See *Driver Information Center (DIC)* on page 5-27.

SERVICE TIRE MONITOR SYSTEM

On vehicles with the Tire Pressure Monitor System (TPMS), this message displays if a part on the TPMS is not working properly. The tire pressure light also flashes and then remains on during the same ignition cycle. See *Tire Pressure Light on page 5-24*. Several conditions may cause this message to appear. See *Tire Pressure Monitor Operation on page 10-48* for more information. If the warning comes on and stays on, there may be a problem with the TPMS. See your dealer.

TIRE LEARNING ACTIVE

This message displays when the Tire Pressure Monitor System (TPMS) is re-learning the tire positions on your vehicle. The tire positions must be re-learned after rotating the tires or after replacing a tire or sensor. See *Tire Rotation on page 10-52*, *Tire Pressure Monitor*

System on page 10-45, and *Tire Pressure on page 10-45* for more information.

Transmission Messages

ALL WHEEL DRIVE OFF

If your vehicle has the All-Wheel Drive (AWD) system, this message displays when there is a compact spare tire on the vehicle, when the Antilock Brake System (ABS) warning light comes on, or when the rear differential fluid is overheating. This message turns off when the differential fluid cools.

The AWD system is disabled until the compact spare tire is replaced by a full-size tire. If the warning message is still on after putting on the full-size tire, you need to reset the warning message. To reset the warning message, turn the ignition off and then back on again after 30 seconds. If the message stays on, see your dealer right away. See *All-Wheel Drive on page 9-29* for more information.

SERVICE ALL WHEEL DRIVE

If your vehicle has the All-Wheel Drive (AWD) system, this message displays if there is a problem with this system. If this message appears, stop as soon as possible and turn off the vehicle. Restart the vehicle after 30 seconds and check for the message on the DIC display. If the message is still displayed or appears again when you begin driving, the AWD system needs service. See your dealer.

SERVICE TRANSMISSION

This message displays when there is a problem with the transmission. See your dealer for service.

TRANSMISSION HOT IDLE ENGINE

Notice: If you drive the vehicle while the transmission fluid is overheating and the transmission temperature warning is displayed on the instrument panel cluster and/or DIC, you can damage the transmission. This could lead to costly repairs that would not be covered by the warranty. Do not drive the vehicle with overheated transmission fluid or while the transmission temperature warning is displayed.

This message displays and a chime sounds if the transmission fluid in the vehicle gets hot. Driving with the transmission fluid temperature high can cause damage to the vehicle. Stop the vehicle and let it idle to allow the transmission to cool. This message clears when the fluid temperature reaches a safe level.

Vehicle Reminder Messages

ICE POSSIBLE DRIVE WITH CARE

This message displays when the outside air temperature is cold enough to create icy road conditions. Adjust your driving accordingly.

Vehicle Speed Messages

SPEED LIMITED TO XXX MPH (KM/H)

This message displays when your vehicle speed is limited to 128 km/h (80 mph) because the vehicle detects a problem in the speed variable assist steering system. Have your vehicle serviced by your dealer.

Washer Fluid Messages

WASHER FLUID LOW ADD FLUID

This message displays when the windshield washer fluid is low. Fill the windshield washer fluid reservoir as soon as possible. See *Engine Compartment Overview on page 10-6* for the location of the windshield washer fluid reservoir. Also, see *Washer Fluid on page 10-22* for more information.

Vehicle Personalization

Your vehicle may have customization capabilities that allow you to program certain features to one preferred setting. Customization features can only be programmed to one setting on the vehicle and cannot be programmed to a preferred setting for two different drivers.

All of the customization options may not be available on your vehicle. Only the options available will be displayed on the DIC.

The default settings for the customization features were set when your vehicle left the factory, but may have been changed from their default state since then.

The customization preferences are automatically recalled.

To change customization preferences, use the following procedure.

Entering the Feature Settings Menu

1. Turn the ignition on and place the vehicle in P (Park).

To avoid excessive drain on the battery, it is recommended that the headlamps are turned off.

2. Press the customization button to enter the feature settings menu. If the menu is not available, FEATURE SETTINGS AVAILABLE IN PARK will display. Before entering the menu, make sure the vehicle is in P (Park).

Feature Settings Menu Items

The following are customization features that allow you to program settings to the vehicle:

DISPLAY IN ENGLISH

This feature will only display if a language other than English has been set. This feature allows you to change the language in which the DIC messages appear to English.

Press the customization button until the PRESS ✓ TO DISPLAY IN ENGLISH screen appears on the DIC display. Press the set/reset button once to display all DIC messages in English.

DISPLAY LANGUAGE

This feature allows you to select the language in which the DIC messages will appear.

Press the customization button until the DISPLAY LANGUAGE screen appears on the DIC display. Press the set/reset button once to access the settings for this feature. Then press the customization button to scroll through the following settings:

ENGLISH (default): All messages will appear in English.

FRANCAIS: All messages will appear in French.

ESPAÑOL: All messages will appear in Spanish.

5-42 Instruments and Controls

NO CHANGE: No change will be made to this feature. The current setting will remain.

To select a setting, press the set/reset button while the desired setting is displayed on the DIC.

AUTO DOOR LOCK

This feature allows you to select when the vehicle's doors will automatically lock. See *Automatic Door Locks on page 2-9* for more information.

Press the customization button until AUTO DOOR LOCK appears on the DIC display. Press the set/reset button once to access the settings for this feature. Then press the customization button to scroll through the following settings:

SHIFT OUT OF PARK (default):

The doors will automatically lock when the vehicle is shifted out of P (Park).

AT VEHICLE SPEED: The doors will automatically lock when the vehicle speed is above 13 km/h (8 mph) for three seconds.

NO CHANGE: No change will be made to this feature. The current setting will remain.

To select a setting, press the set/reset button while the desired setting is displayed on the DIC.

AUTO DOOR UNLOCK

This feature allows you to select whether or not to turn off the automatic door unlocking feature. It also allows you to select which doors and when the doors will automatically unlock. See *Automatic Door Locks on page 2-9* for more information.

Press the customization button until AUTO DOOR UNLOCK appears on the DIC display. Press the set/reset button once to access the settings

for this feature. Then press the customization button to scroll through the following settings:

OFF: None of the doors will automatically unlock.

DRIVER AT KEY OUT: Only the driver door will unlock when the key is taken out of the ignition.

DRIVER IN PARK: Only the driver door will unlock when the vehicle is shifted into P (Park).

ALL AT KEY OUT: All of the doors will unlock when the key is taken out of the ignition.

ALL IN PARK (default): All of the doors will unlock when the vehicle is shifted into P (Park).

NO CHANGE: No change will be made to this feature. The current setting will remain.

To select a setting, press the set/reset button while the desired setting is displayed on the DIC.

REMOTE DOOR LOCK

This feature allows you to select the type of feedback you will receive when locking the vehicle with the Remote Keyless Entry (RKE) transmitter. You will not receive feedback when locking the vehicle with the RKE transmitter if the doors are open. See *Remote Keyless Entry (RKE) System Operation on page 2-3* for more information.

Press the customization button until REMOTE DOOR LOCK appears on the DIC display. Press the set/reset button once to access the settings for this feature. Then press the customization button to scroll through the following settings:

OFF: There will be no feedback when you press the lock button on the RKE transmitter.

LIGHTS ONLY: The exterior lamps will flash when you press the lock button on the RKE transmitter.

HORN ONLY: The horn will sound on the second press of the lock button on the RKE transmitter.

HORN & LIGHTS (default): The exterior lamps will flash when you press the lock button on the RKE transmitter, and the horn will sound when the lock button is pressed again within five seconds of the previous command.

NO CHANGE: No change will be made to this feature. The current setting will remain.

To select a setting, press the set/reset button while the desired setting is displayed on the DIC.

REMOTE DOOR UNLOCK

This feature allows you to select the type of feedback you will receive when unlocking the vehicle with the Remote Keyless Entry (RKE) transmitter. You will not receive feedback when unlocking the vehicle with the RKE transmitter if the doors are open. See *Remote Keyless Entry (RKE) System Operation on page 2-3* for more information.

Press the customization button until REMOTE DOOR UNLOCK appears on the DIC display. Press the set/reset button once to access the settings for this feature. Then press the customization button to scroll through the following settings:

LIGHTS OFF: The exterior lamps will not flash when you press the unlock button on the RKE transmitter.

5-44 Instruments and Controls

LIGHTS ON (default): The exterior lamps will flash when you press the unlock button on the RKE transmitter.

NO CHANGE: No change will be made to this feature. The current setting will remain.

To select a setting, press the set/reset button while the desired setting is displayed on the DIC.

DELAY DOOR LOCK

This feature allows you to select whether or not the locking of the vehicle's doors and liftgate will be delayed. When locking the doors and liftgate with the power door lock switch and a door or the liftgate is open, this feature will delay locking the doors and liftgate until five seconds after the last door is closed. You will hear three chimes to signal that the delayed locking feature is in use. The key must be out of the ignition for this feature to work. You can temporarily override

delayed locking by pressing the power door lock switch twice or the lock button on the RKE transmitter twice. See *Delayed Locking on page 2-9* for more information.

Press the customization button until DELAY DOOR LOCK appears on the DIC display. Press the set/reset button once to access the settings for this feature. Then press the customization button to scroll through the following settings:

OFF: There will be no delayed locking of the vehicle's doors.

ON (default): The doors will not lock until five seconds after the last door or the liftgate is closed.

NO CHANGE: No change will be made to this feature. The current setting will remain.

To select a setting, press the set/reset button while the desired setting is displayed on the DIC.

EXIT LIGHTING

This feature allows you to select the amount of time you want the exterior lamps to remain on when it is dark enough outside. This happens after the key is turned from ON/RUN to LOCK/OFF.

Press the customization button until EXIT LIGHTING appears on the DIC display. Press the set/reset button once to access the settings for this feature. Then press the customization button to scroll through the following settings:

OFF: The exterior lamps will not turn on.

30 SECONDS (default): The exterior lamps will stay on for 30 seconds.

1 MINUTE: The exterior lamps will stay on for one minute.

2 MINUTES: The exterior lamps will stay on for two minutes.

NO CHANGE: No change will be made to this feature. The current setting will remain.

To select a setting, press the set/reset button while the desired setting is displayed on the DIC.

APPROACH LIGHTING

This feature allows you to select whether or not to have the exterior lights turn on briefly during low light periods after unlocking the vehicle using the Remote Keyless Entry (RKE) transmitter.

Press the customization button until APPROACH LIGHTING appears on the DIC display. Press the set/reset button once to access the settings for this feature. Then press the customization button to scroll through the following settings:

OFF: The exterior lights will not turn on when you unlock the vehicle with the RKE transmitter.

ON (default): If it is dark enough outside, the exterior lights will turn on briefly when you unlock the vehicle with the RKE transmitter.

The lights will remain on for 20 seconds or until the lock button on the RKE transmitter is pressed, or the vehicle is no longer off. See *Remote Keyless Entry (RKE) System Operation on page 2-3* for more information.

NO CHANGE: No change will be made to this feature. The current setting will remain.

To select a setting, press the set/reset button while the desired setting is displayed on the DIC.

CHIME VOLUME

This feature allows you to select the volume level of the chime.

Press the customization button until CHIME VOLUME appears on the DIC display. Press the set/reset

button once to access the settings for this feature. Then press the customization button to scroll through the following settings:

NORMAL: The chime volume will be set to a normal level.

LOUD: The chime volume will be set to a loud level.

NO CHANGE: No change will be made to this feature. The current setting will remain.

There is no default for chime volume. The volume will stay at the last known setting.

To select a setting, press the set/reset button while the desired setting is displayed on the DIC.

PARK TILT MIRRORS

If your vehicle has this feature, it allows you to select whether or not the outside mirror(s) will automatically tilt down when the vehicle is shifted into R (Reverse). See *Park Tilt Mirrors on page 2-19* for more information.

Press the customization button until PARK TILT MIRRORS appears on the DIC display. Press the set/reset button once to access the settings for this feature. Then press the customization button to scroll through the following settings:

OFF (default): Neither outside mirror will be tilted down when the vehicle is shifted into R (Reverse).

DRIVER MIRROR: The driver's outside mirror will be tilted down when the vehicle is shifted into R (Reverse).

PASSENGER MIRROR: The passenger's outside mirror will be tilted down when the vehicle is shifted into R (Reverse).

BOTH MIRRORS: The driver's and passenger's outside mirrors will be tilted down when the vehicle is shifted into R (Reverse).

NO CHANGE: No change will be made to this feature. The current setting will remain.

To select a setting, press the set/reset button while the desired setting is displayed on the DIC.

EASY EXIT SEAT

If your vehicle has this feature, it allows you to select your preference for the automatic easy exit seat feature. See *Memory Seats on page 3-6* for more information.

Press the customization button until EASY EXIT SEAT appears on the DIC display. Press the set/reset button once to access the settings for this feature. Then press the customization button to scroll through the following settings:

OFF (default): No automatic seat exit recall will occur.

ON: The driver seat will move back when the key is removed from the ignition. The steering column will also move up and forward on vehicles with the power tilt and telescopic steering feature. See *Steering Wheel Adjustment on page 5-2* for more information.

The automatic easy exit seat movement will only occur one time after the key is removed from the ignition. If the automatic movement has already occurred, and you put the key back in the ignition and remove it again, the seat and steering column will stay in the original exit position, unless a memory recall took place prior to removing the key again.

NO CHANGE: No change will be made to this feature. The current setting will remain.

To select a setting, press the set/reset button while the desired setting is displayed on the DIC.

MEMORY SEAT RECALL

If your vehicle has this feature, it allows you to select your preference for the remote memory seat recall feature. See *Memory Seats on page 3-6* for more information.

Press the customization button until MEMORY SEAT RECALL appears on the DIC display. Press the set/reset button once to access the settings for this feature. Then press the customization button to scroll through the following settings:

OFF (default): No remote memory seat recall will occur.

ON: The driver seat and outside mirrors will automatically move to the stored driving position when the unlock button on the Remote Keyless Entry (RKE) transmitter is pressed. The steering column will also move on vehicles with the power tilt and telescopic steering

feature. See *Steering Wheel Adjustment on page 5-2* for more information. See “Memory Remote Recall” under *Memory Seats on page 3-6* for more information on matching transmitters to driver positions.

NO CHANGE: No change will be made to this feature. The current setting will remain.

To select a setting, press the set/reset button while the desired setting is displayed on the DIC.

REMOTE START

If your vehicle has this feature, it allows you to turn the remote start off or on. The remote start feature allows you to start the engine from outside of the vehicle using the Remote Keyless Entry (RKE) transmitter. See *Remote Vehicle Start on page 2-5* for more information.

Press the customization button until REMOTE START appears on the DIC display. Press the set/reset button once to access the settings for this feature. Then press the customization button to scroll through the following settings:

OFF: The remote start feature will be disabled.

ON (default): The remote start feature will be enabled.

NO CHANGE: No change will be made to this feature. The current setting will remain.

To select a setting, press the set/reset button while the desired setting is displayed on the DIC.

FACTORY SETTINGS

This feature allows you to set all of the customization features back to their factory default settings.

Press the customization button until **FACTORY SETTINGS** appears on the DIC display. Press the set/reset button once to access the settings for this feature. Then press the customization button to scroll through the following settings:

RESTORE ALL (default): The customization features will be set to their factory default settings.

DO NOT RESTORE: The customization features will not be set to their factory default settings.

To select a setting, press the set/reset button while the desired setting is displayed on the DIC.

EXIT FEATURE SETTINGS

This feature allows you to exit the feature settings menu.

Press the customization button until **FEATURE SETTINGS** **PRESS ✓ TO EXIT** appears in the DIC display. Press the set/reset button once to exit the menu.

If you do not exit, pressing the customization button again will return you to the beginning of the feature settings menu.

Exiting the Feature Settings Menu

The feature settings menu will be exited when any of the following occurs:

- The vehicle is shifted out of P (Park).
- The vehicle is no longer in ON/RUN.
- The trip/fuel or vehicle information DIC buttons are pressed.
- The end of the feature settings menu is reached and exited.
- A 40-second time period has elapsed with no selection made.

Universal Remote System

See *Radio Frequency Statement on page 13-23* for information regarding Part 15 of the Federal Communications Commission (FCC) rules and Industry Canada Standards RSS-GEN/210/220/310.

Universal Remote System Programming



This system provides a way to replace up to three remote control transmitters used to activate devices such as garage door openers, security systems, and home automation devices.

Do not use the Universal Home Remote with any garage door opener that does not have the stop and reverse feature. This includes any garage door opener model manufactured before April 1, 1982.

Read the instructions completely before attempting to program the Universal Home Remote. Because of the steps involved, it may be helpful to have another person available to assist you with programming the Universal Home Remote.

Keep the original hand-held transmitter for use in other vehicles as well as for future Universal Home Remote programming. It is also recommended that upon the sale of the vehicle, the programmed Universal Home Remote buttons should be erased for security purposes. See “Erasing Universal Home Remote Buttons” later in this section.

When programming a garage door, park outside of the garage. Park directly in line with and facing the garage door opener motor-head or gate motor-head. Be sure that people and objects are clear of the garage door or gate that is being programmed.

It is recommended that a new battery be installed in your hand-held transmitter for quicker and more accurate transmission of the radio-frequency signal.

Programming the Universal Home Remote System

For questions or help programming the Universal Home Remote System, call 1-800-355-3515 or go to www.homelink.com.

Programming a garage door opener involves time-sensitive actions, so read the entire procedure before starting. Otherwise, the device will time out and the procedure will have to be repeated.

5-50 Instruments and Controls

To program up to three devices:

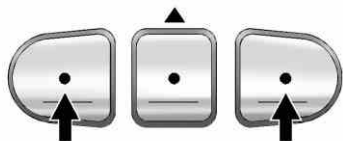

1. From inside the vehicle, press and hold down the two outside buttons at the same time, releasing only when the Universal Home Remote indicator light begins to flash, after 20 seconds. This step will erase the factory settings or all previously programmed buttons.
Do not hold down the buttons for longer than 30 seconds and do not repeat this step to program the remaining two Universal Home Remote buttons.

2. Hold the end of your hand-held transmitter about 3 to 8 cm (1 to 3 inches) away from the Universal Home Remote buttons while keeping the indicator light in view. The hand-held transmitter was supplied by the manufacturer of your garage door opener receiver (motor head unit).
3. At the same time, press and hold both the Universal Home Remote button to be used to control the garage door and the hand-held transmitter button. Do not release the Universal Home Remote button or the hand-held transmitter button until Step 4 has been completed.
4. The indicator light on the Universal Home Remote will flash slowly at first and then rapidly after Universal Home Remote successfully receives the frequency signal from the hand-held transmitter. Release both buttons.

Some entry gates and garage door openers may require substitution of Step 3 with the procedure noted in "Gate Operator and Canadian Programming" later in this section.

5. Press and hold the newly-trained Universal Home Remote button and observe the indicator light.

- If the indicator light stays on continuously, the programming is complete and the garage door should move when the Universal Home Remote button is pressed and released.
- If the Universal Home Remote indicator light blinks rapidly for two seconds and then turns to a constant light, continue with the programming Steps 6 through 8.

It may be helpful to have another person assist with the remaining steps.

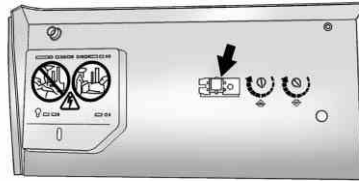

6. After Steps 1 through 5 have been completed, locate inside the garage the garage door opener receiver (motor-head unit). Locate the “Learn” or “Smart” button. The name and color of the button may vary by manufacturer.
7. Firmly press and release the “Learn” or “Smart” button. After you press this button, you will have 30 seconds to complete Step 8.

8. Immediately return to the vehicle. Firmly press and hold the Universal Home Remote button, selected in Step 3 to control the garage door, for two seconds, and then release it. If the garage door does not move, press and hold the same button a second time for two seconds, and then release it. Again, if the door does not move, press and hold the same button a third time for two seconds, and then release.

The Universal Home Remote should now activate the garage door.

To program the remaining two Universal Home Remote buttons, begin with Step 2 of “Programming the Universal Home Remote System.” Do not repeat Step 1, as this will erase all previous programming from the Universal Home Remote buttons.

Gate Operator and Canadian Programming

If you have questions or need help programming the Universal Home Remote System, call 1-800-355-3515 or go to www.homelink.com.

Canadian radio-frequency laws require transmitter signals to time out or quit after several seconds of transmission. This may not be long enough for Universal Home Remote to pick up the signal during programming. Similarly, some U.S. gate operators are manufactured to time out in the same manner.

If you live in Canada, or you are having difficulty programming a gate operator or garage door opener by using the “Programming Universal Home Remote” procedures, regardless of where you live, replace Step 3 under “Programming Universal Home Remote” with the following:

Continue to press and hold the Universal Home Remote button while you press and release every two seconds (cycle) the hand-held transmitter button until the frequency signal has been successfully accepted by the Universal Home Remote.

The Universal Home Remote indicator light will flash slowly at first and then rapidly. Proceed with Step 4 under “Programming Universal Home Remote” to complete the training procedure.

Universal Remote System Operation

Using Universal Remote

Press and hold the appropriate Universal Remote button for at least half of a second. The indicator light will come on while the signal is being transmitted.

Erasing Universal Remote Buttons

All programmed buttons should be erased when the vehicle is sold or the lease ends.

To erase all programmed buttons on the Universal Remote device:

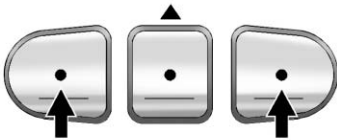

1. Press and hold down the two outside buttons until the indicator light begins to flash, after 20 seconds.
2. Release both buttons.

Reprogramming a Single Universal Remote Button

To reprogram any of the three Universal Remote buttons, repeat the programming instructions earlier in this section, beginning with Step 2.

For help or information on the Universal Home Remote System, call the customer assistance phone number under *Customer Assistance Offices (U.S. and Canada)* on page 13-5 or *Customer Assistance Offices (Mexico)* on page 13-6.

Lighting

Exterior Lighting

Exterior Lamp Controls	6-1
Headlamp High/Low-Beam Changer	6-2
Flash-to-Pass	6-3
Daytime Running Lamps (DRL)/Automatic Headlamp System	6-3
Delayed Headlamps	6-4
Adaptive Forward Lighting (AFL)	6-4
Hazard Warning Flashers	6-4
Turn and Lane-Change Signals	6-5
Fog Lamps	6-5

Interior Lighting

Instrument Panel Illumination Control	6-6
Courtesy Lamps	6-6
Dome Lamps	6-6
Reading Lamps	6-6

Lighting Features

Entry Lighting	6-7
Delayed Entry Lighting	6-7
Delayed Exit Lighting	6-7
Parade Dimming	6-8
Battery Load Management	6-8
Battery Power Protection	6-9

Exterior Lighting

Exterior Lamp Controls

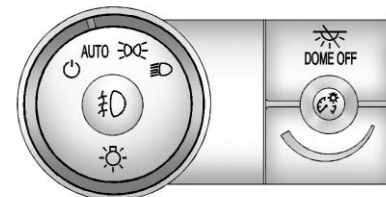

The exterior lamps control is located on the instrument panel to the left of the steering wheel.

6-2 Lighting

It controls the following systems:

- Headlamps
- Taillamps
- Parking Lamps
- License Plate Lamps
- Instrument Panel Lights
- Fog Lamps (If equipped)

The exterior lamps control has four positions:

 (**Off**): Briefly turn to this position to turn the automatic light control off or on again.

AUTO (Automatic): Turns the headlamps on automatically at normal brightness, together with the following:

- Parking Lamps
- Taillamps
- License Plate Lamps
- Instrument Panel Lights

 (**Parking Lamps**): Turns the parking lamps on together with the following:

- Taillamps
- License Plate Lamps
- Instrument Panel Lights

 (**Headlamps**): Turns the headlamps on together with the following lamps. A warning chime sounds if the driver door is opened when the ignition switch is off and the headlamps are on.

- Parking Lamps
- Taillamps
- License Plate Lamps
- Instrument Panel Lights

 (**Fog Lamps**): Turns on the fog lamps (if equipped).

See *Fog Lamps* on page 6-5.

Headlamp High/Low-Beam Changer

 **Headlamp High/Low-Beam Changer**: Push the turn signal/lane change lever away from you to turn the high beams on.

Pull the lever toward you to return to low beams.



This indicator light turns on in the instrument panel cluster when the high-beam headlamps are on.

Flash-to-Pass

This feature is used to signal to the vehicle ahead that you want to pass.

If the headlamps are off or in the low-beam position, pull the turn signal lever toward you to momentarily switch to high beams.

Release the lever to turn the high-beam headlamps off.

Daytime Running Lamps (DRL)/Automatic Headlamp System

Daytime Running Lamps (DRL) can make it easier for others to see the front of your vehicle during the day. Fully functional daytime running lamps are required on all vehicles first sold in Canada.

The DRL system makes the low-beam headlamps come on at a reduced brightness when the following conditions are met:

- The ignition is in the ON/RUN position.
- The exterior lamps control is in AUTO.
- The engine is running.

When the DRL are on, the regular headlamps, taillamps, sidemarker, and other lamps will not be on. The instrument panel and cluster will also not be lit.

The headlamps automatically change from DRL to the regular headlamps depending on the darkness of the surroundings. The other lamps that come on with the headlamps will also come on.

When it is bright enough outside, the headlamps will go off and the DRL will come on.

The regular headlamp system should be turned on when needed.

Do not cover the light sensor on top of the instrument panel because it works with the DRL.

6-4 Lighting

Delayed Headlamps

Delayed headlamps provide a period of exterior lighting as you leave the area around the vehicle. This feature is activated when the headlamps are on due to the automatic headlamps control feature, and when the ignition is turned off. The headlamps remain on until the exterior lamps control is moved to the parking lamps position or until the pre-selected delayed headlamp lighting period has ended.

If the ignition is turned off with the exterior lamp control in the parking lamps or headlamps position, the delayed headlamps cycle will not occur.

To disable the delayed headlamps feature or change the time of delay, see *Vehicle Personalization* on page 5-41.

Adaptive Forward Lighting (AFL)

Vehicles with the Adaptive Forward Lighting System (AFL) have headlamps that swivel to the left or right when making a turn to provide better lighting. To enable AFL, set the exterior lamp switch to the AUTO position. Move the switch out of the AUTO position to turn off the system. See *Exterior Lamp Controls* on page 6-1.

AFL operates when the vehicle speed is greater than 3 km/h (2 mph). AFL does not operate when the transmission is in R (Reverse). AFL is not immediately operable after starting the vehicle; driving a short distance is required to calibrate the AFL.

Hazard Warning Flashers

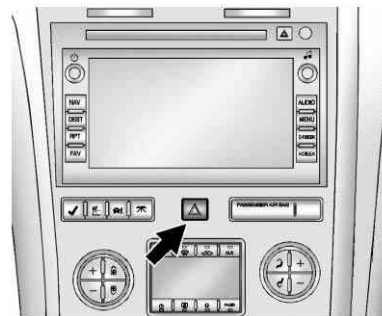

⚠ Hazard Warning Flasher: Press this button located on the instrument panel below the audio system, to make the front and rear turn signal lamps flash on and off. This warns others that you are having trouble. Press again to turn the flashers off.

The turn signals do not work while the hazard warning flashers are on.

Turn and Lane-Change Signals



An arrow on the instrument panel cluster flashes in the direction of the turn or lane change.

Move the lever all the way up or down to signal a turn.

Raise or lower the lever until the arrow starts to flash to signal a lane change. Hold it there until the lane change is completed. If the lever is briefly pressed and released, the turn signal flashes three times.

The lever returns to its starting position whenever it is released.

If after signaling a turn or lane change the arrow flashes rapidly or does not come on, a signal bulb might be burned out.

Have the bulbs replaced. If the bulb is not burned out, check the fuse. See *Fuses and Circuit Breakers* on page 10-32.

Turn Signal On Chime

If either one of the turn signals is left on and the vehicle has been driven more than 1.2 km (0.75 mi), a chime will sound.

Fog Lamps

Use the fog lamps for better vision in foggy or misty conditions.

The fog lamps button is on the exterior lamps control to the left of the steering column.

Fog Lamps: Press the exterior lamps button to turn the fog lamps on or off. A light comes on in the instrument panel cluster when the fog lamps are in use. The ignition must be on for the fog lamps to work.

When the headlamps are changed to high beam, the fog lamps turn off. The fog lamps come back on again when the high-beam headlamps are turned off.

Some localities have laws that require the headlamps to be on along with the fog lamps.

Interior Lighting

Instrument Panel Illumination Control

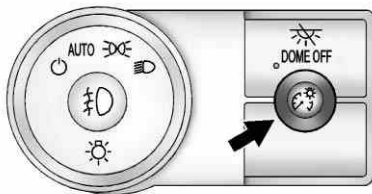

The instrument panel brightness knob is located on the instrument panel to the left of the steering column.

 **(Instrument Panel Brightness):** Push the knob in all the way until it extends out and then turn the knob clockwise or counterclockwise to brighten or dim the lights. Push the knob back in when finished.

Courtesy Lamps

The courtesy lamps automatically come on when a door is opened. The lamps can also be turned on manually by fully turning the instrument panel brightness control clockwise.

The reading lamps, located on the headliner above the rearview mirror, can be turned on or off independently of the automatic courtesy lamps, when the doors are closed.

Dome Lamps

The dome lamps are located in the overhead console and above the rear seat passengers.

The dome lamps come on when a door is opened, unless the dome lamp override button is pressed in.

The lamps can also be turned on and off by turning the instrument panel brightness control clockwise to the farthest position.

Dome Lamp Override

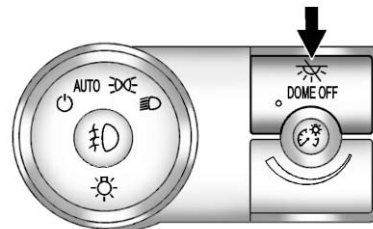

The dome lamp override button is next to the exterior lamps control.

 **DOME OFF (Dome Lamp Override):** Press the top of the button in and the dome lamps remain off when a door is opened. An indicator light on the button comes on to show that the dome lamps are off. Press near the bottom of the button so the dome lamps come on when a door is opened.

Reading Lamps

Press the button near each lamp to turn them on or off.

Lighting Features

Entry Lighting

For vehicles with courtesy lamps, they come on and stay on for a set time whenever  is pressed on the Remote Keyless Entry (RKE) transmitter.

If a door is opened, the lamps stay on while it is open and then turn off automatically about 20 seconds after the door is closed. If  is pressed and no door is opened, the lamps turn off after about 20 seconds.

Entry lighting includes a feature called theater dimming. With theater dimming, the lamps do not turn off at the end of the delay time. Instead, they slowly dim and then go out. The delay time is canceled if the ignition key is turned to ON/RUN or the power door lock switch is pressed. The lamps will dim right away.

When the ignition is on, illuminated entry is inactive, which means the courtesy lamps will not come on unless a door is opened.

Delayed Entry Lighting

Delayed entry lighting illuminates the interior for a period of time after all the doors have been closed.

The ignition must be off for delayed entry lighting to work. Immediately after all the doors have been closed, the delayed entry lighting feature continues to work until one of the following occurs:

- The ignition is in ON/RUN.
- The doors are locked.
- An illumination period of about 25 seconds has elapsed.

If during the illumination period a door is opened, the timed illumination period is canceled and the interior lamps remain on.

Delayed Exit Lighting

Delayed exit lighting illuminates the interior for a period of time after the key is removed from the ignition.

The ignition must be off for delayed exit lighting to work. When the key is removed, interior illumination activates and remains on until one of the following occurs:

- The ignition is in ON/RUN.
- The power door locks are activated.
- An illumination period of 20 seconds has elapsed.

If during the illumination period a door is opened, the timed illumination period will be canceled and the interior lamps will remain on because a door is open.

Parade Dimming

This feature automatically prohibits the dimming of the instrument panel displays in daylight while the headlamps are on so that the displays are still able to be seen.

Battery Load Management

The vehicle has Electric Power Management (EPM) that estimates the battery's temperature and state of charge. It then adjusts the voltage for best performance and extended life of the battery.

When the battery's state of charge is low, the voltage is raised slightly to quickly bring the charge back up. When the state of charge is high, the voltage is lowered slightly to prevent overcharging. If the vehicle has a voltmeter gauge or a voltage

display on the Driver Information Center (DIC), you may see the voltage move up or down. This is normal. If there is a problem, an alert will be displayed.

The battery can be discharged at idle if the electrical loads are very high. This is true for all vehicles. This is because the generator (alternator) may not be spinning fast enough at idle to produce all of the power needed for very high electrical loads.

A high electrical load occurs when several of the following are on, such as: headlamps, high beams, fog lamps, rear window defogger, climate control fan at high speed, heated seats, engine cooling fans, trailer loads, and loads plugged into accessory power outlets.

EPM works to prevent excessive discharge of the battery. It does this by balancing the generator's output and the vehicle's electrical needs. It can increase engine idle speed to generate more power whenever needed. It can temporarily reduce the power demands of some accessories.

Normally, these actions occur in steps or levels, without being noticeable. In rare cases at the highest levels of corrective action, this action may be noticeable to the driver. If so, a DIC message might be displayed, such as BATTERY SAVER ACTIVE, BATTERY VOLTAGE LOW, or LOW BATTERY. If one of these messages displays, it is recommended that the driver reduce the electrical loads as much as possible. See *Driver Information Center (DIC)* on page 5-27.

Battery Power Protection

This feature helps prevent the battery from being drained, if the interior courtesy lamps or reading lamps are accidentally left on.

If any of these lamps are left on, they automatically turn off after 10 minutes, if the ignition is off.

The lamps will not come back on again until one of the following occurs:

- The ignition is turned on.
- The exterior lamps control is turned off, then on again.

The headlamps will time out after 10 minutes, if they are manually turned on while the ignition is on or off.

Infotainment System

Introduction

Infotainment	7-1
Theft-Deterrent Feature	7-2
Operation	7-2

Radio

AM-FM Radio	7-7
Satellite Radio	7-9
Radio Reception	7-13
Multi-Band Antenna	7-14

Audio Players

CD Player	7-14
CD/DVD Player	7-16
MP3 (Radio with CD/USB) ...	7-24
MP3 (Radio with CD/DVD) ...	7-31
Auxiliary Devices	7-38

Rear Seat Infotainment

Rear Seat Entertainment (RSE) System	7-40
Rear Seat Audio (RSA) System	7-50

Phone

Bluetooth	7-52
-----------------	------

Trademarks and License Agreements

Trademarks and License Agreements	7-60
---	------

Introduction Infotainment

Read the following pages to become familiar with the audio system's features.

⚠ WARNING

Taking your eyes off the road for extended periods could cause a crash resulting in injury or death to you or others. Do not give extended attention to entertainment tasks while driving.

This system provides access to many audio and non-audio listings.

To minimize taking your eyes off the road while driving, do the following while the vehicle is parked:

- Become familiar with the operation and controls of the audio system.
- Set up the tone, speaker adjustments, and preset radio stations.

7-2 Infotainment System

For more information, see *Defensive Driving* on page 9-3.

The vehicle has Retained Accessory Power (RAP). With RAP, the audio system can be played even after the ignition is turned off. See *Retained Accessory Power (RAP)* on page 9-21 for more information.

Navigation/Radio System

For vehicles with a navigation radio system, see the separate navigation manual.

Theft-Deterrent Feature

TheftLock[®] is designed to discourage theft of the vehicle's radio by learning a portion of the Vehicle Identification Number (VIN). The radio does not operate if it is stolen or moved to a different vehicle.

Operation



Radio with CD, Radio with CD/USB Similar



Radio with CD, DVD, and USB Port

The vehicle may have one of these radios as its audio system.

Radios with CD, DVD, and USB

Radios with CD, DVD, and USB have a Bose® Surround Sound System. Some of the features are explained later in this section under “Adjusting the Speakers (Balance/Fade).”

If the vehicle has a Rear Seat Entertainment (RSE) system, it has a CD, DVD, and USB radio. See *Rear Seat Entertainment (RSE) System* on page 7-40 for more information on the RSE system.

The DVD player is the top slot on the radio faceplate. The player is capable of reading the DTS programmed DVD Audio or DVD Video media. DTS and DTS Digital Surround are registered trademarks of Digital Theater Systems, Inc.

Manufactured under license from Dolby Laboratories. Dolby and the double-D symbol are trademarks of Dolby Laboratories.

7-4 Infotainment System

Playing the Radio

⏻ (Power/Volume): Press to turn the system on and off. Turn to increase or decrease the volume.

For vehicles with a Rear Seat Entertainment (RSE) System, press and hold for more than two seconds to turn off the entire radio and RSE system and to start the parental control feature. Parental control prevents the rear seat occupant from operating the Rear Seat Audio (RSA) system or remote control.

A lock symbol displays next to the clock display while the parental control feature is being used.

The feature remains on until **⏻** is pressed and held for more than two seconds, or the driver turns the ignition off and exits the vehicle.

i (Information): Press to switch the display between the radio station frequency and the time. When the ignition is in the OFF position, press **i** to display the time. For vehicles with XM, MP3, WMA, or RDS features, press **i** to display additional text information related to the current FM-RDS or XM station; or CD, MP3, or WMA song. If information is available during XM, CD, MP3, or WMA playback, the song title information displays on the top line of the display and artist information displays on the bottom line. When information is not available, "NO INFO" displays.

Auto Text (Satellite Radio Service, CD, MP3, and WMA features):

If additional information is available for the current song being played, Auto Text will automatically page/scroll the information every five seconds above the FAV presets on the radio display.

To activate Auto Text:

1. Press MENU to display the radio setup menu.
2. Press the softkey under the AUTO TXT tab on the radio display.
3. Press the softkey under the ON tab on the radio display.

If **i** is pressed and the song title or artist information is longer than what can be displayed, the extra information will page every five seconds when Auto Text is activated.

Speed Compensated

Volume (SCV): The Speed Compensated Volume (SCV) feature automatically adjusts the radio volume to compensate for road and wind noise as the vehicle speeds up or slows down, so that the volume level is consistent.



To activate SCV:

1. Set the radio volume.
2. Press the MENU button to display the radio setup menu.
3. Press the softkey under the AUTO VOLUM (automatic volume) tab on the radio display.



4. Press the softkey under the Speed Compensated Volume setting (OFF, Low, Med, or High) to select the level of radio volume compensation. Press the softkey located below the BACK tab on the MENU SETUP display or let the display time out after approximately 10 seconds. Each higher setting allows for more radio volume compensation at faster vehicle speeds.

Setting the Tone (Bass/Midrange/Treble)

BASS/MID/TREB (Bass, Midrange, or Treble): To adjust bass, midrange, or treble:

1. Press  until the tone control tabs display.
2. Continue pressing  to highlight the tab, or press the softkey under the tab.

3. To adjust the highlighted setting, do one of the following until the levels are obtained:

- Turn  clockwise or counterclockwise.
- Press  FWD, or  REV.

If a station's frequency is weak or if there is static, decrease the treble.

To quickly adjust bass, midrange, or treble to the middle position, press the softkey under the BASS, MID, or TREB tab for more than two seconds. A beep sounds and the level adjusts to the middle position.

To quickly adjust all tone and speaker controls to the middle position, press  for more than two seconds until a beep sounds.

7-6 Infotainment System



EQ (Equalization): Press to choose bass and treble equalization settings designed for different types of music. The choices are pop, rock, country, talk, jazz, and classical. Selecting MANUAL or changing bass or treble, returns the EQ to the manual bass and treble settings.

Unique EQ settings can be saved for each source.



If the radio has a Bose® audio system, the EQ settings are either MANUAL or TALK.

Adjusting the Speakers (Balance/Fade)

BAL/FADE (Balance/Fade):
To adjust the balance or fade:

1. Press  until the speaker control tabs display.
2. Continue pressing  to highlight the tab, or press the softkey under the tab.

3. To adjust the highlighted setting, do one of the following until the levels are obtained:

- Turn  clockwise or counterclockwise.
- Press  FWD, or  REV.

To quickly adjust balance or fade to the middle position, press the softkey under the BAL or FADE tab for more than two seconds. A beep sounds and the level adjusts to the middle position.

To quickly adjust all speaker and tone controls to the middle position, press  for more than two seconds until a beep sounds.

Radios with CD and DVD fade differently depending on the DVD Media type:

- With DVD-A 5.1 Surround media, the left front and right front speakers fade rearward, leaving the center front speakers unaffected until the last fade step, then all front speakers mute.
- With DVD-V 5.1 Surround media, surround sound is maintained until Step 4 of the Fade control is reached while fading rearward. At that point the audio system output changes to Stereo to prevent the loss of Center channel output when the full rearward fade position is reached.

If the Rear Seat Audio (RSA) is turned on, the radio disables FADE and mutes the rear speakers.

Radio Messages

Calibration Error: The audio system has been calibrated for the vehicle from the factory. If Calibration Error displays, it means that the radio has not been configured properly for the vehicle and it must be returned to your dealer for service.

Locked: This message displays when the TheftLock[®] system has locked up the radio. Take the vehicle to your dealer for service.

If any error occurs repeatedly or if an error cannot be corrected, contact your dealer.

Radio

AM-FM Radio

Radio Data System (RDS)

The Radio Data System (RDS) feature is available for use only on FM stations that broadcast RDS information. This system relies upon receiving specific information from these stations and only works when the information is available. While the radio is tuned to an FM-RDS station, the station name or call letters display. In rare cases, a radio station could broadcast incorrect information that causes the radio features to work improperly. If this happens, contact the radio station.

Finding a Station

BAND: Press to switch between AM, FM, or XM. The selection displays.

🎵 (Tune): Turn to select radio stations.

⏪ SEEK and ⏩ SEEK : Press to go to the previous or next station and stay there.

To scan stations, press and hold ⏪ or ⏩ until a beep sounds. The radio goes to a station, plays for a few seconds, then goes to the next station. Press either arrow again to stop scanning.

The radio only seeks and scans stations with a strong signal that are in the selected band.

7-8 Infotainment System

Storing a Radio Station as a Favorite

Drivers are encouraged to set up their radio station favorites while the vehicle is in P (Park). Tune to favorite stations using the presets, favorites button, and steering wheel controls. See *Steering Wheel Controls* on page 5-3.

FAV (Favorites): A maximum of 36 stations can be programmed as favorites using the six softkeys below the radio station frequency tabs and by using the radio favorites page button (FAV button). Press to go through up to six pages of favorites, each having six favorite stations available per page. Each page of favorites can contain any combination of AM, FM, or XM stations.

The balance/fade and tone settings that were previously adjusted are stored with the favorite stations.

To store a station as a favorite:

1. Tune to the desired radio station.
2. Press FAV to display the page to store the station.
3. Press and hold one of the six softkeys until a beep sounds. When that softkey is pressed and released, the station that was set returns.
4. Repeat the steps for each radio station to be stored as a favorite.

To set up the number of favorites pages:

1. Press MENU to display the radio setup menu.
2. Press the softkey below the FAV 1-6 tab.
3. Select the desired number of favorites pages by pressing the softkey below the displayed page numbers.
4. Press FAV, or let the menu time out, to return to the original main radio screen showing the radio station frequency tabs and to begin the process of programming favorites for the chosen number of favorites pages.

Satellite Radio

XM™ Satellite Radio Service

XM is a satellite radio service based in the 48 contiguous United States and 10 Canadian provinces. XM Satellite Radio has a wide variety of programming and commercial-free music, coast to coast, and in digital-quality sound. A service fee is required to receive the XM service. If XM Service needs to be reactivated, the radio will display “No Subscription Please Renew” on channel XM1. For more information, contact XM at www.xmradio.com or 1-800-929-2100 in the U.S. and www.xmradio.ca or 1-877-438-9677 in Canada.

Finding a Station

BAND: Press to switch between AM, FM, or XM. The selection displays.

♪ (Tune): Turn to select radio stations.

◀ SEEK and ▶ SEEK : Press to go to the previous or next station and stay there.

To scan stations, press and hold **◀** or **▶** until a beep sounds. The radio goes to a station, plays for a few seconds, then goes to the next station. Press either arrow again to stop scanning.

The radio only seeks and scans stations with a strong signal that are in the selected band.

Finding a Category (CAT) Station

CAT (Category): The CAT button is used to find XM stations when the radio is in the XM mode. To find XM channels within a desired category:

1. Press BAND until the XM frequency displays.
2. Press CAT to display the category tabs.
3. Continue pressing CAT until the desired category name displays.
 - Radios with CD and DVD can also navigate the category list by pressing **◀◀ REV** or **▶▶ FWD**.
4. Press either of the two buttons below the desired category tab to immediately tune to the first XM station associated with that category.

7-10 Infotainment System

- To go to the next or previous XM station within the selected category, do one of the following:
 - Turn .
 - Press the buttons below the right or left arrows on the display.
 - Press either SEEK arrow.
- To exit the category search mode, press the FAV button or BAND button to display the favorites again.

Undesired XM categories can be removed through the setup menu. To remove an undesired category, perform the following:

- Press MENU to display the radio setup menu.
- Press the softkey below the XM CAT tab.

- Turn  to display the category to be removed.
- Press the softkey under the Remove tab until the category name along with the word Removed displays.
- Repeat the steps to remove more categories.

Removed categories can be restored by pressing the softkey under the Add tab when a removed category is displayed or by pressing the softkey under the Restore All tab.

Categories cannot be removed or added while the vehicle is moving faster than 8 km/h (5 mph).

Storing a Radio Station as a Favorite

Drivers are encouraged to set up their radio station favorites while the vehicle is in P (Park). Tune to favorite stations using the presets, favorites button, and steering wheel controls. See *Steering Wheel Controls* on page 5-3.

FAV (Favorites): A maximum of 36 stations can be programmed as favorites using the six softkeys below the radio station frequency tabs and by using the radio favorites page button (FAV button). Press to go through up to six pages of favorites, each having six favorite stations available per page. Each page of favorites can contain any combination of AM, FM, or XM stations.

The balance/fade and tone settings that were previously adjusted are stored with the favorite stations.

To store a station as a favorite:

1. Tune to the desired radio station.
2. Press FAV to display the page to store the station.
3. Press and hold one of the six softkeys until a beep sounds. When that softkey is pressed and released, the station that was set returns.
4. Repeat the steps for each radio station to be stored as a favorite.

To set up the number of favorites pages:

1. Press MENU to display the radio setup menu.
2. Press the softkey below the FAV 1-6 tab.
3. Select the desired number of favorites pages by pressing the softkey below the displayed page numbers.
4. Press FAV, or let the menu time out, to return to the original main radio screen showing the radio station frequency tabs and to begin the process of programming favorites for the chosen number of favorites pages.

XM™ Radio Messages

XL (Explicit Language

Channels): These channels, or any others, can be blocked at a customer's request, by calling 1-800-929-2100 in the U.S. and 1-877-438-9677 in Canada.

XM Updating: The encryption code in the receiver is being updated, and no action is required. This process should take no longer than 30 seconds.

No XM Signal: The system is functioning correctly, but the vehicle is in a location that is blocking the XM signal. When the vehicle is moved into an open area, the signal should return.

Loading XM: The audio system is acquiring and processing audio and text data. No action is needed. This message should disappear shortly.

7-12 Infotainment System

Channel Off Air: This channel is not currently in service. Tune in to another channel.

Channel Unauth: This channel is blocked or cannot be received with your XM Subscription package.

Channel Unavail: This previously assigned channel is no longer assigned. Tune to another station. If this station was one of the presets, choose another station for that preset button.

No Artist Info: No artist information is available at this time on this channel. The system is working properly.

No Title Info: No song title information is available at this time on this channel. The system is working properly.

No CAT Info: No category information is available at this time on this channel. The system is working properly.

No Information: No text or informational messages are available at this time on this channel. The system is working properly.

No Subscription Please

Renew: XM subscription needs to be reactivated. Contact XM at www.xmradio.com or 1-800-929-2100 in the U.S., and www.xmradio.ca or 1-877-438-9677 in Canada.

CAT Not Found: There are no channels available for the selected category. The system is working properly.

XM Theftlocked: The XM receiver in the vehicle could have previously been in another vehicle. For security purposes, XM receivers cannot be swapped between vehicles. If this message is received after having the vehicle serviced, check with your dealer.

XM Radio ID: If tuned to channel 0, this message alternates with the XM Radio eight-digit radio ID label. This label is needed to activate the service.

Unknown: If this message is received when tuned to channel 0, there could be a receiver fault. Consult with your dealer.

Check XM Receiver: If this message does not clear within a short period of time, the receiver could have a fault. Consult with your dealer.

XM Not Available: If this message does not clear within a short period of time, the receiver could have a fault. Consult with your dealer.

Radio Reception

Frequency interference and static can occur during normal radio reception if items such as cell phone chargers, vehicle convenience accessories, and external electronic devices are plugged into the accessory power outlet. If there is interference or static, unplug the item from the accessory power outlet.

FM

FM signals only reach about 16 to 65 km (10 to 40 mi). Although the radio has a built-in electronic circuit that automatically works to reduce interference, some static can occur, especially around tall buildings or hills, causing the sound to fade in and out.

AM

The range for most AM stations is greater than for FM, especially at night. The longer range can cause station frequencies to interfere with each other. For better radio reception, most AM radio stations boost the power levels during the day, and then reduce these levels during the night. Static can also occur when things like storms and power lines interfere with radio reception. When this happens, try reducing the treble on the radio.

XM™ Satellite Radio Service

XM Satellite Radio Service gives digital radio reception from coast to coast in the 48 contiguous United States, and in Canada. Just as with FM, tall buildings or hills can

interfere with satellite radio signals, causing the sound to fade in and out. In addition, traveling or standing under heavy foliage, bridges, garages, or tunnels may cause loss of the XM signal for a period of time.

Cellular Phone Usage

Cellular phone usage may cause interference with the vehicle's radio. This interference may occur when making or receiving phone calls, charging the phone's battery, or simply having the phone on. This interference can cause an increased level of static while listening to the radio. If static is received while listening to the radio, unplug the cellular phone and turn it off.

Multi-Band Antenna

The multi-band antenna is located on the roof of the vehicle. This type of antenna is used with the AM/FM radio, as well as OnStar and the XM Satellite Radio Service System, if the vehicle has these features. Keep this antenna clear of snow and ice build up for clear radio reception. If the vehicle has a sunroof, the performance of the radio system may be affected if the sunroof is open. Loading items onto the roof of the vehicle can interfere with the performance of the radio system and, if the vehicle has this feature, OnStar. Make sure the multi-band antenna is not obstructed.

Audio Players





CD Player

Playing a CD

Insert a CD partway into the slot, label side up. The player pulls it in and the CD should begin playing.

 **EJECT:** Press and release to eject the disc that is currently playing. A beep sounds and Ejecting Disc displays. Once the disc is ejected, Remove Disc displays. The disc can be removed. If the disc is not removed, after several seconds, the disc automatically pulls back into the player.

 **(Tune):** Turn to select tracks on the CD that is currently playing.

 **SEEK** and  **SEEK:** Press  to go to the start of the current track, if more than 10 seconds on the CD have played. Press  SEEK to go to the next track.

If either arrow is held, or pressed multiple times, the player continues moving backward or forward through the tracks on the CD.

 **REV (Fast Reverse):** Press and hold to reverse playback quickly within a track. Sound will be heard at a reduced volume. Release to resume playing the track. The elapsed time of the track displays.

 **FWD (Fast Forward):** Press and hold to advance playback quickly within a track. Sound will be heard at a reduced volume. Release to resume playing the track. The elapsed time of the track displays.

RDM (Random): CD tracks can be listened to in random, rather than sequential order with the random setting. To use random, press the softkey under the RDM label until Random Current Disc displays. Press the softkey again to turn off random play.

BAND: Press to listen to the radio when a CD is playing. The CD remains inside the radio for future listening.

CD/AUX (CD/Auxiliary): Press to select between CD, or Auxiliary.

- When a CD is in the player, the CD icon and a message showing the disc and/or track number display.
- If an auxiliary input device is not connected, "No Input Device Found" displays.

Care of CDs

If playing a CD-R, the sound quality can be reduced due to CD-R or CD-RW quality, the method of recording, the quality of the music that has been recorded, and the way the CD-R or CD-RW has been handled. Handle them carefully. Store CD-R(s) or CD-RW(s) in their original cases or other protective cases and away from direct sunlight and dust. The CD player scans the bottom surface of the disc. If the surface of a CD is damaged, such as cracked, broken, or scratched, the CD does not play properly or not at all. Do not touch the bottom side of a CD while handling it; this could damage the surface. Pick up CDs by grasping the outer edges or the edge of the hole and the outer edge.

If the surface of a CD is soiled, take a soft, lint-free cloth or dampen a clean, soft cloth in a mild, neutral detergent solution mixed with water, and clean it. Make sure the wiping process starts from the center to the edge.

Care of the CD Player

Do not add any label to a CD; it could get caught in the CD player. If a CD is recorded on a personal computer and a description label is needed, try labeling the top of the recorded CD with a marking pen.

The use of CD lens cleaners for CDs is not advised.

Notice: If a label is added to a CD, more than one CD is inserted into the slot at a time, or an attempt is made to play scratched or damaged CDs, the CD player could be damaged. While using the CD player, use only CDs in good condition without any label, load one CD at a time, and keep the CD player and the loading slot free of foreign materials, liquids, and debris.

If an error displays, see "CD Messages" later in this section.

Playing an MP3/WMA CD-R or CD-RW Disc

The radio has the capability of playing an MP3/WMA CD-R or CD-RW disc. For more information on how to play an MP3/WMA CD-R or CD-RW disc, see *MP3 (Radio with CD/USB) on page 7-24* or *MP3 (Radio with CD/DVD) on page 7-31*.

CD Messages

Check Disc: Radios with a single CD player display Check Disc and/or eject the CD if an error occurs.

Optical Error: The disc was inserted upside down.

Disk Read Error: A disc was inserted with an invalid or unknown format.

Player Error: There are disc LOAD or disc EJECT problems.

- It is very hot. When the temperature returns to normal, the CD should play.

- The road is very rough. When the road becomes smoother, the CD should play.
- The CD is dirty, scratched, wet, or upside down.
- The air is very humid. If so, wait about an hour and try again.
- There was a problem while burning the CD.
- The label is caught in the CD player.

If the CD is not playing correctly for any other reason, try a known good CD.

If any error occurs repeatedly or if an error cannot be corrected, contact your dealer. If the radio displays an error message, write it down and provide it to your dealer when reporting the problem.

CD/DVD Player

Playing a CD (In Either the DVD or CD Slot)

Insert a CD partway into the slot, label side up. The player pulls it in and the CD should begin playing. (Loading a disc into the system, depending on media type and format, ranges from five to 20 seconds for a CD, and up to 30 seconds for a DVD to begin playing.)

If the ignition or radio is turned off while a CD is in the player, it stays in the player. When the ignition or radio is turned on, the CD starts playing where it stopped, if it was the last selected audio source. The CD is controlled by the buttons on the radio faceplate or by the RSA unit. See *Rear Seat Audio (RSA) System on page 7-50* for more information. The DVD/CD decks (the upper slot is the DVD deck and the lower slot is the CD deck) are compatible with most audio CDs, CD-Rs, CD-RWs, and MP3/WMAAs.

When a CD is inserted, the text label DVD or CD symbol displays on the left side of the radio display. As each new track starts to play, the track number displays.

△ CD (Eject): Press and release to eject the disc that is currently playing. The disc ejects from the bottom slot. A beep sounds and Ejecting Disc displays. Once the disc is ejected, Remove Disc displays. The disc can be removed. If the disc is not removed, after several seconds, the disc automatically pulls back into the player.

△ DVD (Eject): Press and release to eject the disc that is currently playing in the top slot. A beep sounds and Ejecting Disc displays.

If loading and reading of a disc cannot be completed, and the disc fails to eject, press and hold **△ DVD** for more than five seconds to force the disc to eject.

♪ (Tune): Turn to select tracks on the CD that is currently playing.

◀ and SEEK ▶ SEEK: Press **◀ SEEK** to go to the start of the current track if the track has played more than five seconds. If the track has played less than five seconds, the previous track will play.

Press **▶ SEEK** to go to the next track.

If either arrow is held, or pressed multiple times, the player continues moving backward or forward through the tracks on the CD.

◀◀ REV (Fast Reverse): Press and hold to reverse playback quickly within a track. Sound will be heard at a reduced volume. Release to resume playing the track. The elapsed time of the track displays.

▶▶ FWD (Fast Forward): Press and hold to advance playback quickly within a track. Sound will be heard at a reduced volume. Release to resume playing the track. The elapsed time of the track displays.

RDM (Random): CD tracks can be listened to in random, rather than sequential order with the random setting. To use random, press the softkey under the RDM tab until Random Current Disc displays. Press the softkey again to turn off random play.

BAND: Press to listen to the radio when a CD or DVD is playing. The CD or DVD remains inside the radio for future listening or viewing.

DVD/CD/AUX (Auxiliary): Press to select between DVD, CD, or Auxiliary.

- If an auxiliary input device is not connected, "No Aux Input Device" displays.
- When a disc is in either slot, the DVD/CD text tab and a message showing the track or chapter number displays.

7-18 Infotainment System

- If an auxiliary input device is not connected, and a disc is in both the DVD slot and the CD slot, the DVD/CD/AUX button only cycles between the two sources and does not indicate “No Aux Input Device.”
- If a front auxiliary input device is connected, the DVD/CD/AUX button cycles through all available options.

If a disc is inserted into the top DVD slot, the rear seat operator can turn on the video screen and use the remote control to only navigate the CD tracks through the remote control.

See *Auxiliary Devices* on page 7-38 or “Audio/Video (A/V) Jacks” under, *Rear Seat Entertainment (RSE) System* on page 7-40 for more information.

Care of CDs and DVDs

If playing a CD-R, the sound quality can be reduced due to CD-R or CD-RW quality, the method of recording, the quality of the music that has been recorded, and the way the CD-R or CD-RW has been handled. Handle them carefully. Store CD-R(s) or CD-RW(s) in their original cases or other protective cases and away from direct sunlight and dust. The CD or DVD player scans the bottom surface of the disc. If the surface of a CD is damaged, such as cracked, broken, or scratched, the CD does not play properly or not at all. Do not touch the bottom side of a CD while handling it; this could damage the surface. Pick up CDs by grasping the outer edges or the edge of the hole and the outer edge.

If the surface of a CD is soiled, take a soft, lint-free cloth or dampen a clean, soft cloth in a mild, neutral detergent solution mixed with water, and clean it. Make sure the wiping process starts from the center to the edge.

Care of the CD and DVD Player

Do not add any label to a CD; it could get caught in the CD or DVD player. If a CD is recorded on a personal computer and a description label is needed, try labeling the top of the recorded CD with a marking pen.

The use of CD lens cleaners for CDs is not advised.

Notice: If a label is added to a CD, more than one CD is inserted into the slot at a time, or an attempt is made to play scratched or damaged CDs, the CD player could be damaged. While using the CD player, use only CDs in good condition without any label, load one CD at a time, and keep the CD player and the loading slot free of foreign materials, liquids, and debris.

If an error displays, see “CD Messages” later in this section.

Radios with CD and DVD Audio Output

Only one audio source can be heard through the speakers at one time. An audio source is defined as DVD slot, CD slot, XM, FM/AM, Front Auxiliary Jack, or Rear Auxiliary Jack.

Press  to turn the radio on. The radio can be heard through all of the vehicle speakers.

Front seat passengers can listen to the radio (AM, FM, or XM) by pressing BAND or DVD/CD AUX to select the CD slot, DVD slot, front or rear auxiliary input (if available).

If a playback device is plugged into the radio's front auxiliary input jack or the rear auxiliary jack, the front seat passengers are able to listen to playback from this source through the vehicle speakers.

See *Auxiliary Devices* on page 7-38 or “Audio/Video (A/V) Jacks” under, *Rear Seat Entertainment (RSE) System* on page 7-40 for more information.

In some vehicles, depending on audio options, the rear speakers can be muted when the RSA power is turned on. See *Rear Seat Audio (RSA) System* on page 7-50 for more information.

Playing an MP3/WMA CD-R or CD-RW Disc

The radio has the capability of playing an MP3/WMA CD-R or CD-RW disc. For more information on how to play an MP3/WMA CD-R or CD-RW disc, see *MP3 (Radio with CD/USB)* on page 7-24 or *MP3 (Radio with CD/DVD)* on page 7-31.

CD Messages

Optical Error: The disc was inserted upside down.

Disk Read Error: A disc was inserted with an invalid or unknown format.

Player Error: There are disc LOAD or disc EJECT problems.

- It is very hot. When the temperature returns to normal, the CD should play.
- The road is very rough. When the road becomes smoother, the CD should play.
- The CD is dirty, scratched, wet, or upside down.
- The air is very humid. If so, wait about an hour and try again.
- There was a problem while burning the CD.
- The label is caught in the CD player.

If the CD is not playing correctly for any other reason, try a known good CD.

If any error occurs repeatedly or if an error cannot be corrected, contact your dealer. If the radio displays an error message, write it down and provide it to your dealer when reporting the problem.

Using the DVD Player

The DVD player can be controlled by the buttons on the remote control, the RSA system, or by the buttons on the radio faceplate. See “Remote Control” under *Rear Seat Entertainment (RSE) System on page 7-40* and *Rear Seat Audio (RSA) System on page 7-50* for more information.

The DVD player is only compatible with DVDs of the appropriate region code printed on the jacket of most DVDs.

The DVD slot of the radio is compatible with most audio CDs, CD-R, CD-RW, DVD-Video, DVD-Audio, DVD-R/RW, DVD+R/RW media along with MP3 and WMA formats.

If an error message displays on the video screen or the radio, see “DVD Display Error Messages” under *Rear Seat Entertainment (RSE) System on page 7-40* and “DVD Radio Error Messages” in this section for more information.

Playing a DVD

🎵 (Tune): Turn to change tracks on a CD or DVD, to manually tune a radio station, or to change clock or date settings, while in the clock or date setting mode. See the information earlier in this section specific to the radio, CD, and the DVD. Also, see *Clock on page 5-9* for information on setting the clock and date.

⏮ SEEK (Previous Track/Chapter): Press to return to the start of the current track or chapter. Press ⏮ SEEK again to go to the previous track or chapter. This button may not work when the DVD is playing the copyright information or the previews.

⏭ SEEK (Next Track/Chapter): Press to go to the next track or chapter. This button may not work when the DVD is playing the copyright information or the previews.

⏮ REV (Fast Reverse): Press to quickly reverse the DVD at five times the normal speed. The radio displays the elapsed time while in fast reverse. To stop fast reversing, press again. This button may not work when the DVD is playing the copyright information or the previews.

⏭ FWD (Fast Forward): Press to fast forward the DVD. The radio displays the elapsed time and fast forwards five times the normal speed. To stop fast forwarding, press again. This button may not work when the DVD is playing the copyright information or the previews.

⏏ (Eject): Press to eject a DVD. If the DVD is ejected, but not removed, the player automatically pulls it back in after 15 seconds.

If loading and reading of a DVD cannot be completed because of an unknown format, etc., and the disc fails to eject, press and hold for more than five seconds to force the disc to eject.

DVD-V (Video) Display Buttons

Once a DVD-V is inserted, the radio display menu shows several icons. Press the softkeys under any icon during DVD playback. See the icon list below for more information.

A rear seat passenger can navigate the DVD-V menus and controls through the remote control. See “Remote Control” under *Rear Seat Entertainment (RSE) System on page 7-40* for more information. The Video Screen automatically turns on when the DVD-V is inserted into the DVD slot.

▶ / || (Play/Pause): Press either the play or pause icon displayed on the radio system, to toggle between pausing or restarting playback of a DVD.

- If the forward arrow is showing, the system is in pause mode.
- If the pause icon is showing, the system is in playback mode.
- If the DVD screen is off, press the play button to turn the screen on.

Some DVDs begin playing after the previews have finished, although there could be a delay of up to 30 seconds. If the DVD does not begin playing the movie automatically, press the softkey under the play/pause icon displayed on the radio. If the DVD still does not play, refer to the on-screen instructions, if available.

■ (Stop): Press to stop playing, rewinding, or fast forwarding a DVD.

◀ (Enter): Press to select the choices that are highlighted in any menu.

☰ (Menu): Press to access the DVD menu. The DVD menu is different on every DVD. Use the softkeys under the navigation arrows to navigate the cursor through the DVD menu. After making a selection, press this button. This button only operates when using a DVD.

Nav (Navigate): Press to display directional arrows for navigating through the menus.

↶ (Return): Press to exit the current active menu and return to the previous menu. This button operates only when a DVD is playing and a menu is active.

DVD-A (Audio) Display Buttons

Once a DVD-A is inserted, the radio display menu shows several icons. Press the softkeys under any icon during DVD playback. See the icon list below for more information.

A rear seat passenger can navigate the DVD-A menus and controls through the remote control. See "Remote Control" under *Rear Seat Entertainment (RSE) System on page 7-40* for more information. The Video Screen does not automatically power on when the DVD-A is inserted into the DVD slot. It must be manually turned on by the rear seat passenger through the remote control power button.

▶ / || (Play/Pause): Press either the play or pause icon displayed on the radio system, to toggle between pausing or restarting playback of a DVD.

- If the forward arrow is showing, the system is in pause mode.
- If the pause icon is showing, the system is in playback mode.

◀ Group ▶ : Press to cycle through musical groupings on the DVD-A disc.

Nav (Navigate): Press to display directional arrows for navigating through the menus.

♪ (Audio Stream): Press to cycle through audio stream formats located on the DVD-A disc. The video screen shows the audio stream changing.

Inserting a Disc

To play a disc, gently insert the disc, with the label side up, into the loading slot. The DVD player might not accept some paper labeled media. The player starts loading the disc into the system and shows “Loading Disc” on the radio display. At the same time, the radio displays a softkey menu of option(s). Some discs automatically play the movie while others default to the softkey menu display, which requires the Play, Enter, or Navigation softkeys to be pressed; either by the softkey on the radio or by the rear seat passenger using the remote control.

It may take up to 30 seconds for a DVD to begin playing.

Stopping and Resuming Playback

To stop playing a DVD without turning off the system, do one of the following:



- Press ■ on the remote control.
- Press the softkey under the stop or the play/pause icons displayed on the radio.
- If the radio head is sourced to something other than DVD-V, press the DVD/CD AUX button to make DVD-V the active source.

To resume DVD playback, do one of the following:

- Press ▶ / || on the remote control.
- Press the softkey under the play/pause icon displayed on the radio.

The DVD should resume play from where it last stopped if the disc has not been ejected and the stop button has not been pressed twice on the remote control. If the disc has been ejected or the stop button has been pressed twice on the remote control, the disc resumes playing at the beginning of the disc.

Ejecting a Disc

Press  DVD on the radio to eject the disc. If a disc is ejected from the radio, but not removed, the radio reloads the disc after a short period of time. The disc is stored in the radio. The radio does not resume play of the disc automatically. If the movie is reloaded and the RSA system is sourced to the DVD, the player begins to play again. If loading and reading a DVD or CD cannot be completed, and the disc fails to eject, press and hold  DVD for more than five seconds to force the disc to eject.

DVD Error Messages

Player Error: This message displays when there are disc load or eject problems.

Disc Format Error: This message displays if the disc is inserted with the disc label wrong side up, or if the disc is damaged.

Disc Region Error: This message displays if the disc is not from a correct region.

No Disc Inserted: This message displays if no disc is present when  DVD or DVD/CD/AUX is pressed on the radio.

MP3 (Radio with CD/USB)

Format

Radios that have the capability of playing MP3s can play .mp3 or .wma files that were recorded onto a CD-R or CD-RW disc. The files can be recorded with the following fixed bit rates: 32 kbps, 40 kbps, 56 kbps, 64 kbps, 80 kbps, 96 kbps, 112 kbps, 128 kbps, 160 kbps, 192 kbps, 224 kbps, 256 kbps, and 320 kbps or a variable bit rate.

Radios that have a USB port can play .mp3 and .wma files stored on a USB storage device as well as AAC files stored on an iPod.

Compressed Audio or Mixed Mode Discs

The radio can play discs that contain both uncompressed CD audio and MP3/WMA files. If both formats are on the disc, the radio plays both file formats in the order in which they were recorded to the disc.

CD-R or CD-RW Supported File and Folder Structure

The radio supports:

- Up to 50 folders.
- Up to eight folders in depth.
- Up to 15 playlists.
- Up to 512 files and folders.
- Playlists with an .m3u or .wpl extension.
- Files with an .mp3, .wma, or .cda file extension.

USB Supported File and Folder Structure

The radio supports:

- Up to 700 folders.
- Up to eight folders in depth.
- Up to 65,535 files.
- Folder and file names up to 64 bytes.
- Files with an .mp3 or .wma file extension.
- AAC files stored on an iPod.
- FAT16
- FAT32

Root Directory

The root directory of the disc is treated as a folder. If the root directory has compressed audio files, the directory displays on the radio as the CD label.

If a disc contains both uncompressed CD audio and MP3/WMA files, a folder under the root directory called CD accesses all of the CD audio tracks on the disc.

Empty Folder

Folders that do not contain files are skipped, and the player advances to the next folder that contains files.

Order of Play

Compressed audio files are accessed in the following order:

- Playlists (Px).
- Files stored in the root directory.
- Files stored in folders in the root directory.

Tracks are played in the following order:

- Play begins from the first track in the first playlist and continues sequentially through all tracks in each playlist. When the last track of the last playlist has played, play continues from the first track of the first playlist.
- Play begins from the first track in the first folder and continues sequentially through all tracks in each folder. When the last track of the last folder has played, play continues from the first track of the first folder.

When play enters a new folder, the display does not automatically show the new folder name unless the folder mode has been chosen as the default display. The new track name displays.

File System and Naming

The song name that displays is the song name contained in the ID3 tag. If the song name is not present in the ID3 tag, the radio displays the file name without the extension (such as .mp3) as the track name.

Track names longer than 32 characters or four pages are shortened. Parts of words on the last page of text and the extension of the filename do not display.

Preprogrammed Playlists

Preprogrammed playlists that were created using WinAmp™, MusicMatch™, or Real Jukebox™ software can be accessed; however, they cannot be edited using the radio. These playlists are treated as special folders containing compressed audio song files.

Playlists that have an .m3u or .pls file extension and are stored on a USB device may be supported by the radio with a USB port.

Playing a CD-R or CD-RW MP3

🎵 (Tune): Turn to select MP3/WMA files.

⏮ (SEEK): Press to go to the start of the track, if more than 10 seconds have played. Press and hold or press multiple times to continue moving backward through tracks.

⏭ (SEEK): Press to go to the next track. Press and hold or press multiple times to continue moving forward through tracks.

⏪ (REV (Reverse)): Press and hold to reverse playback quickly. Sound is heard at a reduced volume and the elapsed time of the file displays. Release ⏪ REV to resume playing.

⏩ (FWD (Fast Forward)): Press and hold to advance playback quickly. Sound is heard at a reduced volume and the elapsed time of the file displays. Release ⏩ FWD to resume playing. The elapsed time of the file displays.

⏪ (Previous Folder): Press the softkey below ⏪ to go to the first track in the previous folder.

⏩ (Next Folder): Press the softkey below ⏩ to go to the first track in the next folder.

RDM (Random): Files on the disc can be listened to in random, rather than sequential order. To use random, press the softkey under the RDM tab until Random Current Disc displays to play songs in random order. Press the same softkey again to turn off random play.

🎵 (Music Navigator): Press the softkey below 🎵 to play files in order by artist or album.

The player scans the disc to sort the files by artist and album ID3 tag information. It can take several minutes to scan the disc depending on the number of files on the disc. The radio may begin playing while it is scanning in the background.

When the scan is finished, the disc begins playing files in order by artist. The current artist playing is shown on the second line of the display. Once all songs by that artist are played, the player moves to the next artist in alphabetical order and begins playing files by that artist.

To listen to files by another artist, press the softkey below either arrow tab. The disc goes to the next or previous artist in alphabetical order. Continue pressing either softkey below the arrow tab until the artist displays.

7-28 Infotainment System

To change from playback by artist to playback by album:

1. Press the softkey below the Sort By tab.
2. Press one of the softkeys below the Album tab from the sort screen.
3. Press the softkey below the Back tab to return to the main music navigator screen.

The album name displays on the second line between the arrows and songs from the current album begins to play. Once all songs from that album have played, the player moves to the next album in alphabetical order on the CD and begins playing MP3 files from that album.

To exit music navigator mode, press the softkey below the Back tab to return to normal MP3 playback.

Connecting a USB Storage Device or iPod®

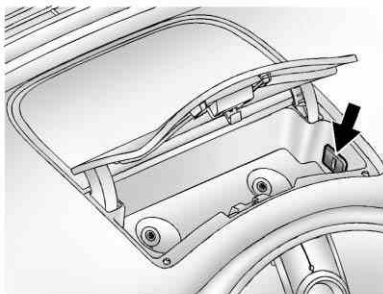

To connect a USB storage device, connect the device to the USB port located in the instrument panel storage area. See *Instrument Panel Storage on page 4-1* for more information.

The USB port can be used to control an iPod or a USB storage device.

To connect an iPod, connect one end of the USB cable that came with the iPod to the iPod's dock connector and connect the other end to the USB port located in the instrument panel storage area. If the vehicle is on and the USB connection works, "OK to disconnect" and a GM logo may appear on the iPod, and iPod appears on the radio's display. The iPod music appears on the radio's display and begins playing.

The iPod charges while it is connected to the vehicle if the vehicle is in the ACC/ACCESSORY or ON/RUN position. When the vehicle is turned off, the iPod automatically powers off and will not charge or draw power from the vehicle's battery.

If you have an older iPod model that is not supported, it can still be used by connecting it to the Auxiliary Input Jack using a standard 3.5 mm (1/8 in) stereo cable. See *Auxiliary Devices on page 7-38* for more information.

Using the Radio to Control a USB Storage Device or iPod

The radio can control a USB storage device or an iPod using the radio buttons and knobs and display song information on the radio's display.

🎵 (Tune): Turn to select files.

⏮ SEEK: Press to go to the start of the track, if more than 10 seconds have played. Press and hold or press multiple times to continue moving backward through tracks.

⏭ SEEK: Press to go to the next track. Press and hold or press multiple times to continue moving forward through tracks.

⏪ REV (Reverse): Press and hold to reverse playback quickly. Sound is heard at a reduced volume. Release ⏪ REV to resume playing. The elapsed time of the file displays.

⏩ FWD (Fast Forward): Press and hold to advance playback quickly. Sound is heard at a reduced volume. Release ⏩ FWD to resume playing. The elapsed time of the file displays.

i (Information): Press to display additional information about the selected track.

Using Softkeys to Control a USB Storage Device or iPod

The five softkeys below the radio display are used to control the functions listed below.

To use the softkeys:

1. Press the first or fifth softkey below the radio display to display the functions listed below, or press the softkey below the function if it is currently displayed.
2. Press the softkey below the tab with the function on it to use that function.



⏸ (Pause): Press the softkey below **⏸** to pause the track. The tab appears raised when pause is being used. Press the softkey below **⏸** again to resume playback.

Back: Press the softkey below the Back tab to go back to the main display screen on an iPod, or the root directory on a USB storage device.

📁 (Folder View): Press the softkey below **📁** to view the contents of the current folder on the USB drive. To browse and select files:



1. Press the softkey below **📁**.
2. Turn **🎵** to scroll through the list of folders.
3. Press **🎵** to select the folder. If there is more than one folder, repeat Steps 1 and 2 until the folder is reached.

7-30 Infotainment System

4. Turn  to scroll through the files in the selected folder.
5. Press  to select the file to be played.



To skip through large lists, the five softkeys can be used to navigate in the following order:

- First softkey, first item in the list.
- Second softkey, 1% through the list each time the softkey is pressed.
- Third softkey, 5% through the list each time the softkey is pressed.
- Fourth softkey, 10% through the list each time the softkey is pressed.
- Fifth softkey, end of the list.

 **(Music Navigator):** Press the softkey below  to view and select a file on an iPod, using the iPod's menu system. Files are sorted by:

- Playlists
- Artists
- Albums
- Genres
- Songs
- Composers

To select files:

1. Press the softkey below .
2. Turn  to scroll through the list of menus.
3. Press  to select the menu.

4. Turn  to scroll through the folders or files in the selected menu.



5. Press  to select the file to be played.



To skip through large lists, the five softkeys can be used to navigate in the following order:

- First softkey, first item in the list.
- Second softkey, 1% through the list each time the softkey is pressed.
- Third softkey, 5% through the list each time the softkey is pressed.
- Fourth softkey, 10% through the list each time the softkey is pressed.
- Fifth softkey, end of the list.



Repeat Functionality

To use Repeat:

Press the softkey below  or  to select between Repeat All and Repeat Track.





 **(Repeat All):** Press the softkey below  to repeat all tracks.

The tab appears lowered when Repeat All is being used. This is the default mode when a USB storage device or iPod is first connected.

 **(Repeat Track):** Press the softkey below  to repeat one track. The tab appears raised when Repeat Track is being used.

Shuffle Functionality

To use Shuffle:

Press the softkey below ,  S,  A or  F to select between Shuffle Off, Shuffle All Songs/ Shuffle Songs, Shuffle Album, or Shuffle Folder.

 **(Shuffle Off):** This is the default mode when a USB storage device or iPod is first connected.

 S **(Shuffle All Songs/Shuffle Songs):** Shuffles all songs on the USB storage device or iPod.

 A **(Shuffle Album):** Shuffles all songs in the current album on an iPod.

 F **(Shuffle Folder):** Shuffles all songs in the current folder on a USB storage device.

MP3 (Radio with CD/DVD)

Format

The radio can play .mp3 or .wma files recorded onto a CD-R or CD-RW disc.

The USB port can play .mp3 and .wma files that are stored on a USB storage device as well as AAC files stored on an iPod.

Compressed Audio or Mixed Mode Discs

The radio plays discs that contain both uncompressed CD audio and MP3/WMA files depending on which slot the disc is loaded into.

The DVD Player only reads uncompressed audio and ignores MP3/WMA files on a mixed mode disc.

The CD Player reads both uncompressed audio and MP3/WMA files on a mixed mode disc. Uncompressed audio is played before MP3/WMA files. Press the CAT (category) button to toggle between uncompressed audio and MP3/WMA files.

CD-R or CD-RW Supported File and Folder Structure

The DVD Player supports:

- Up to 255 folders.
- Up to eight folders in depth.
- Up to 15 playlists.
- Up to 40 sessions.
- Playlists with an .m3u or .wpl extension.
- Files with an .mp3, .wma, or .cda file extension.

The CD Player supports:

- Up to 512 files and folders.
- Up to eight folders in depth.
- Playlists with an .m3u or .wpl extension.
- Files with an .mp3, .wma, or .cda file extension.

USB Supported File and Folder Structure

The radio supports:

- Up to 700 folders.
- Up to eight folders in depth.
- Up to 65,535 files.
- Folder and file names up to 64 bytes.
- Files with an .mp3 or .wma file extension.
- AAC files stored on an iPod.
- FAT16
- FAT32

Root Directory

The root directory of the disc is treated as a folder. If the root directory has compressed audio files, the directory displays as F1 ROOT on the radio.

If a disc contains both uncompressed CD audio and MP3/WMA files, a folder under the root directory called CD accesses all of the CD audio tracks on the disc.

Empty Folder

Folders that do not contain files are skipped, and the player advances to the next folder that contains files.

No Folder

When the disc contains only compressed files, the files are located under the root folder. The next and previous folder function does not function on a disc that was recorded without folders or playlists. When displaying the name of the folder the radio displays ROOT.

When the disc contains only playlists and compressed audio files, but no folders, all files are located under the root folder. The folder down and the folder up buttons search playlists first and then go to the root folder. When the radio displays the name of the folder the radio displays ROOT.

Order of Play

Compressed audio files are accessed in the following order:

- Playlists.
- Files stored in the root directory.
- Files stored in folders in the root directory.

Tracks are played in the following order:

- Play begins from the first track in the first playlist and continues sequentially through all tracks in each playlist. When the last track of the last playlist has played, play continues from the first track of the first playlist.
- Play begins from the first track in the first folder and continues sequentially through all tracks in each folder. When the last track of the last folder has played, play continues from the first track of the first folder.

When play enters a new folder, the display does not automatically show the new folder name unless the folder mode has been chosen as the default display. The new track name displays.

File System and Naming

The song name that displays is the song name contained in the ID3 tag. If the song name is not present in the ID3 tag, then the radio displays the file name without the extension (such as .mp3) as the track name.

Track names longer than 32 characters or four pages are shortened. Parts of words on the last page of text and the extension of the filename do not display.

Preprogrammed Playlists

Preprogrammed playlists created using WinAmp™, MusicMatch™, or Real Jukebox™ software can be accessed; however, they cannot be edited using the radio. These playlists are treated as special folders containing compressed audio song files.

Playlists that have an .m3u or .pls file extension and are stored on a USB device may be supported by the radio with a USB port.



Playing an MP3/WMA File From a Disc (In Either the DVD or CD Slot)



If a disc is inserted into the top DVD slot, the rear seat operator can turn on the video screen and use the remote control to navigate the CD (tracks only).



 **(Tune):** Turn to select MP3/WMA files.

 **SEEK:** Press to go to the start of the track, if more than five seconds have played. Press to go to the previous track if less than five seconds have played. Press and hold or press multiple times to continue moving backward through tracks.

 **SEEK:** Press to go to the next track. Press and hold or press multiple times to continue moving forward through tracks.



 **REV (Reverse):** Press and hold to reverse playback quickly. Sound is heard at a reduced volume and the elapsed time of the file displays. Release  REV to resume playing.

 **FWD (Fast Forward):** Press and hold to advance playback quickly. Sound is heard at a reduced volume and the elapsed time of the file displays. Release  FWD to resume playing. The elapsed time of the file displays.

 **(Previous Folder):** Press the softkey below  to go to the first track in the previous folder.

 **(Next Folder):** Press the softkey below  to go to the first track in the next folder.

RDM (Random): Files on the disc can be listened to in random, rather than sequential order. To use random, press the softkey under the RDM tab until Random Current Disc displays to play songs in random order. Press the same softkey again to turn off random play.

 **(Music Navigator):** Press the softkey below  to play files in order by artist or album.

The player scans the disc to sort the files by artist and album ID3 tag information. It can take several minutes to scan the disc depending on the number of files on the disc. The radio may begin playing while it is scanning in the background.

When the scan is finished, the disc begins playing files in order by artist. The current artist playing is shown on the second line of the display. Once all songs by that artist are played, the player moves to the next artist in alphabetical order and begins playing files by that artist.

To listen to files by another artist, press the softkey located below either arrow tab. The disc goes to the next or previous artist in alphabetical order. Continue pressing either softkey below the arrow tab until the artist displays.

To change from playback by artist to playback by album:

1. Press the softkey located below the Sort By tab.
2. Press one of the softkeys below the Album tab from the sort screen.
3. Press the softkey below the Back tab to return to the main music navigator screen.

The album name displays on the second line between the arrows and songs from the current album begins to play. Once all songs from that album have played, the player moves to the next album in alphabetical order on the CD and begins playing MP3 files from that album.

To exit music navigator mode, press the softkey below the Back tab to return to normal MP3 playback.

Connecting a USB Storage Device or iPod®

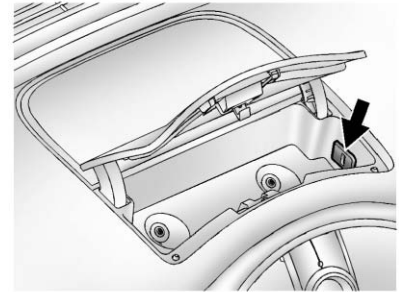

To connect a USB storage device, connect the device to the USB port located in the instrument panel storage area. See *Instrument Panel Storage on page 4-1* for more information.

The USB port can be used to control an iPod or a USB storage device.

To connect an iPod, connect one end of the USB cable that came with the iPod to the iPod's dock connector, and connect the other end to the USB port located in the instrument panel storage area. If the vehicle is on and the USB connection works, "OK to disconnect" and a GM logo may appear on the iPod, and iPod appears on the radio's display. The iPod music appears on the radio's display and begins playing.

The iPod charges while it is connected to the vehicle if the vehicle is in the ACC/ACCESSORY or ON/RUN position. When the vehicle is turned off, the iPod automatically powers off and will not charge or draw power from the vehicle's battery.

If you have an older iPod model that is not supported, it can still be used by connecting it to the auxiliary input jack using a standard 3.5 mm (1/8 in) stereo cable. See *Auxiliary Devices on page 7-38* for more information.

Using the Radio to Control a USB Storage Device or iPod

The radio can control a USB storage device or an iPod using the radio buttons and knobs and display song information on the radio's display.

🎵 (Tune): Turn to select files.

⏪ SEEK: Press to go to the start of the track, if more than 10 seconds have played. Press and hold or press multiple times to continue moving backward through tracks.

⏩ SEEK: Press to go to the next track. Press and hold or press multiple times to continue moving forward through tracks.

⏮ REV (Reverse): Press and hold to reverse playback quickly. Sound is heard at a reduced volume. Release ⏮ REV to resume playing. The elapsed time of the file displays.

⏭ FWD (Fast Forward): Press and hold to advance playback quickly. Sound is heard at a reduced volume. Release ⏭ FWD to resume playing. The elapsed time of the file displays.

i (Information): Press to display additional information about the selected track.

Using Softkeys to Control a USB Storage Device or iPod

The five softkeys below the radio display are used to control the functions listed below.



To use the softkeys:



1. Press the first or fifth softkey below the radio display to display the functions listed below, or press the softkey below the function if it is currently displayed.
2. Press the softkey below the tab with the function on it to use that function.

|| (Pause): Press the softkey below **||** to pause the track. The tab appears raised when pause is being used. Press the softkey below **||** again to resume playback.

Back: Press the softkey below the Back tab to go back to the main display screen on an iPod, or the root directory on a USB storage device.

Folder View: Press the softkey below  to view the contents of the current folder on the USB drive. To browse and select files:

1. Press the softkey below .
2. Turn  to scroll through the list of folders.
3. Press  to select the folder. If there is more than one folder, repeat Steps 1 and 2 until the folder is reached.

4. Turn  to scroll through the files in the selected folder.
5. Press  to select the file to be played.





To skip through large lists, the five softkeys can be used to navigate in the following order:

- First softkey, first item in the list.
- Second softkey, 1% through the list each time the softkey is pressed.
- Third softkey, 5% through the list each time the softkey is pressed.
- Fourth softkey, 10% through the list each time the softkey is pressed.
- Fifth softkey, end of the list.

Music Navigator: Press the softkey below  to view and select a file on an iPod, using the iPod's menu system. Files are sorted by:

- Playlists
- Artists
- Albums
- Genres
- Songs
- Composers

To select files:



1. Press the softkey below .
2. Turn  to scroll through the list of menus.
3. Press  to select the menu.
4. Turn  to scroll through the folders or files in the selected menu.
5. Press  to select the file to be played.



To skip through large lists, the five softkeys can be used to navigate in the following order:



- First softkey, first item in the list.
- Second softkey, 1% through the list each time the softkey is pressed.
- Third softkey, 5% through the list each time the softkey is pressed.
- Fourth softkey, 10% through the list each time the softkey is pressed.
- Fifth softkey, end of the list.

Repeat Functionality

To use Repeat:





Press the softkey below  or  to select between Repeat All and Repeat Track.

 **(Repeat All):** Press the softkey below  to repeat all tracks. The tab appears lowered when Repeat All is being used. This is the default mode when a USB storage device or iPod is first connected.

 **(Repeat Track):** Press the softkey below  to repeat one track. The tab appears raised when Repeat Track is being used.

Shuffle Functionality

To use Shuffle:

Press the softkey below , , , or  to select between Shuffle Off, Shuffle All Songs/ Shuffle Songs, Shuffle Album, or Shuffle Folder.

 **(Shuffle Off):** This is the default mode when a USB storage device or iPod is first connected.

 **(Shuffle All Songs/ Shuffle Songs):** Shuffles all songs on the USB storage device or iPod.

 **(Shuffle Album):** Shuffles all songs in the current album on an iPod.

 **(Shuffle Folder):** Shuffles all songs in the current folder on a USB storage device.

Auxiliary Devices

The vehicle may have a 3.5 mm (1/8 in) auxiliary input jack located on the lower right side of the faceplate and for vehicles with a USB port, it is located in the instrument panel storage area.

Using the 3.5 mm (1/8 in) Auxiliary Input Jack

The auxiliary input jack is located on the lower right side of the faceplate. This is not an audio output; do not plug a headphone set into the front auxiliary input jack. Connect an auxiliary input device such as an iPod, laptop computer, MP3 player, CD player, or cassette tape player to the auxiliary input jack for use as another source for audio listening.

Drivers are encouraged to set up any auxiliary device while the vehicle is in P (Park). See *Defensive Driving on page 9-3* for more information on driver distraction.

To use an auxiliary input device, connect a 3.5 mm (1/8 in) cable to the radio's front auxiliary input jack.

⏻ (Power/Volume): Turn clockwise or counterclockwise to increase or decrease the volume of the portable player. Additional volume adjustments might have to be made from the portable device if the volume is not loud or soft enough.

BAND: Press to listen to the radio when a portable audio device is playing. The portable audio device continues playing, so you might want to stop it or turn it off.

CD/AUX (CD/Auxiliary): Press to select between CD, or Auxiliary.

- When a CD is in the player the CD icon and a message showing the disc and/or track number displays.
- If an auxiliary input device is not connected, "No Input Device Found" displays.

DVD/CD/AUX (Auxiliary): Press to select between DVD, CD, or Auxiliary.

- If an auxiliary input device is not connected, "No Aux Input Device" displays.
- When a disc is in either slot, the DVD/CD text tab and a message showing the track or chapter number display.
- If an auxiliary input device is not connected, and a disc is in both the DVD slot and the CD slot, the DVD/CD/AUX button only cycles between the two sources and does not indicate "No Aux Input Device."
- If a front auxiliary input device is connected, the DVD/CD/AUX button cycles through all available options.

If a disc is inserted into the top DVD slot, the rear seat operator can turn on the video screen and use the remote control to only navigate the CD tracks through the remote control.

See *Clock* on page 5-9 or "Audio/Video (A/V) Jacks" under *Rear Seat Entertainment (RSE) System* on page 7-40 for more information.

Using the USB Port

For vehicles with a USB port, the connector is located in the instrument panel storage area. See *Instrument Panel Storage* on page 4-1 for more information.

Radios with a USB port can control a USB storage device or an iPod using the radio buttons and knobs. See *MP3 (Radio with CD/USB)* on page 7-24 or *MP3 (Radio with CD/DVD)* on page 7-31 for information about how to connect and control a USB storage device or an iPod.

USB Supported Devices

- USB Flash Drives
- Portable USB Hard Drives
- Fifth generation or later iPod
- iPod nano
- iPod touch
- iPod classic

Not all iPods and USB drives are compatible with the USB port.

Make sure the iPod has the latest firmware from Apple® for proper operation. iPod firmware can be updated using the latest iTunes® application. See www.apple.com/itunes.

For help identifying your iPod, go to www.apple.com/support.

Rear Seat Infotainment

Rear Seat Entertainment (RSE) System

The vehicle may have a DVD Rear Seat Entertainment (RSE) system. The RSE system works with the vehicle's audio system. The DVD player is part of the front radio.

The RSE system includes a radio with a DVD player, a video display screen, audio/video jacks, two wireless headphones, and a remote control. See *Operation on page 7-2* for more information on the vehicle's infotainment system.

Before Driving

The RSE is designed for rear seat passengers only. The driver cannot safely view the video screen while driving and should not try to do so.

In severe or extreme weather conditions, the RSE system might or might not work until the temperature is within the operating range. The operating range for the RSE system is above -20°C (-4°F) or below 60°C (140°F). If the temperature of the vehicle is outside of this range, heat or cool the vehicle until the temperature is within the operating range of the RSE system.

Parental Control

The RSE system may have a Parental Control feature, depending on the radio. To enable Parental Control, press and hold the radio power button for more than two seconds to stop all system features such as: radio, video screen, RSA, DVD and/or CD. While Parental Control is on,  displays.

When the radio is turned back on, Parental Control is unlocked.

Headphones

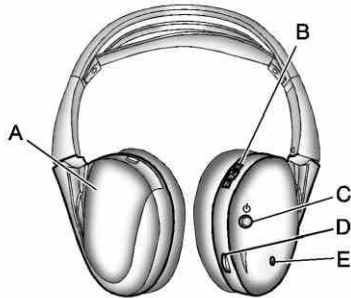

- A. Battery cover
- B. Channel 1 or 2 switch
- C. Power button
- D. Volume control
- E. Power indicator light

The RSE includes two 2-channel wireless headphones that are dedicated to this system. Channel 1 is dedicated to the video screen, while Channel 2 is dedicated to RSA selections. These headphones are used to listen to media such as CDs, DVDs, MP3/WMA, DVD-As, radio, any auxiliary source connected to A/V jacks, or the auxiliary input jack, if the vehicle has this feature. The wireless headphones have a power button, channel 1 or 2 switch, and a volume control. Switch the headphones off when not in use.

Push the power button to turn on the headphones. An indicator light located on the headphones comes on. If the light does not come on, the batteries might need to be

replaced. Intermittent sound or static on the headphones can also be an indication of weak batteries. See "Battery Replacement" later in this section for more information.

To adjust the volume on the headphones, use the volume control located on the right side.

Infrared transmitters are located at the rear of the RSE overhead console. The headphones shut off automatically to save the battery power if the RSE system and RSA are shut off or if the headphones are out of range of the transmitters for more than three minutes. Moving too far forward or stepping out of the vehicle, can cause the headphones to lose the audio signal.

For optimal audio performance, the headphones must be worn correctly. Headphones should be worn with the headband over the top of the head for best audio reception.

The symbol L (Left) appears on the outside bottom edge of the ear cup and should be positioned on the left ear. The symbol R (Right) appears on the outside bottom edge of the ear cup and should be positioned on the right ear.

Notice: Do not store the headphones in heat or direct sunlight. This could damage the headphones and repairs will not be covered by the warranty. Storage in extreme cold can weaken the batteries. Keep the headphones stored in a cool, dry place.

If the foam ear pads attached to the headphones become worn or damaged, the pads can be replaced separately from the headphone set. To purchase replacement ear pads, call 1-888-293-3332, then prompt zero (0), or contact your dealer.

Headphones should be stored in the front floor console and not in the front seat back pocket. Headphone damage can occur when the second row seats are folded forward.

Battery Replacement

To change the batteries on the headphones:

1. Turn the screw to loosen the battery door located on the left side of the headphones. Slide the battery door open.
2. Replace the two batteries in the compartment. Make sure that they are installed correctly, using the diagram on the inside of the battery compartment.
3. Replace the battery door and tighten the door screw.

If the headphones are to be stored for a long period of time, remove the batteries and keep them in a cool, dry place.

Audio/Video (A/V) Jacks

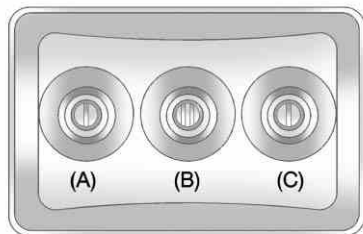

- A. Yellow: Video Input
- B. White: Left Audio Input
- C. Red: Right Audio Input

The A/V jacks are color coded to match typical home entertainment system equipment.

The A/V jacks, located on the rear of the floor console, allow audio or video signals to be connected from an auxiliary device such as a camcorder or a video game unit to the RSE system. Adapter connectors or cables (not supplied) might be required to connect the auxiliary device to the A/V jacks. Refer to the manufacturer's instructions for proper usage.

Power for auxiliary devices is not supplied by the radio system.

To use the auxiliary inputs of the RSE system, connect an external auxiliary device to the color-coded A/V jacks and turn both the auxiliary device and the video screen power on. If the video screen is in the DVD player mode, pressing the AUX (auxiliary) button on the remote control switches the video screen

from the DVD player mode to the auxiliary device. The radio can listen to the audio of the connected auxiliary device by sourcing to auxiliary. See *Auxiliary Devices on page 7-38* for more information.

How to Change the RSE Video Screen Settings

The screen display mode (normal, full, and zoom), screen brightness, and setup menu language can be changed from the on screen setup menu by using the remote control. To change a setting:

1. Press .
2. Use **▲**, **▼**, **◀**, **▶** and **↵** to navigate and use the setup menu.
3. Press again to remove the setup menu from the screen.

7-44 Infotainment System

Audio Output

Audio from the DVD player or auxiliary inputs can be heard through the following sources:

- Wireless headphones
- Vehicle speakers
- Vehicle-wired headphone jacks on the RSA system, if the vehicle has this feature.

The RSE system always transmits the audio signal to the wireless headphones, if there is audio available. See “Headphones” earlier in this section for more information.

The DVD player is capable of outputting audio to the wired headphone jacks on the RSA system, if the vehicle has this feature. The DVD player can be selected as an audio source on the RSA system. See *Rear Seat Audio (RSA) System on page 7-50* for more information.

When a device is connected to the A/V jacks, or the radio's auxiliary input jack, if the vehicle has this feature, the rear seat passengers are able to hear audio from the auxiliary device through the wireless or wired headphones. The front seat passengers are able to listen to playback from this device through the vehicle speakers by selecting AUX as the source on the radio.

Video Screen

The video screen is located in the overhead console. When the video screen is not in use, push it up into its locked position.

To use the video screen:

1. Push the release button located on the overhead console.
2. Move the screen to the desired position.

If a DVD is playing and the screen is raised to its locked position, the screen remains on; this is normal, and the DVD continues to play through the previous audio source. Press  on the remote control or eject the disc to turn off the screen.

The infrared receivers for the wireless headphones and the remote control are located at the rear of the overhead console.

Notice: Avoid directly touching the video screen, as damage may occur. See “Cleaning the Video Screen” later in this section for more information.

Remote Control



To use the remote control, aim it at the transmitter window at the rear of the overhead console and press the desired button. Direct sunlight or very bright light could affect the ability of the RSE transmitter to receive signals from the remote control. If the remote control does not seem to be working, the batteries might need to be replaced.

See “Battery Replacement” later in this section. Objects blocking the line of sight could also affect the function of the remote control.

If a CD or DVD is in the Radio DVD slot, the remote control  button can be used to turn on the video screen display and start the disc. The radio can also turn on the video screen display. See *Operation on page 7-2* for more information.

Notice: Storing the remote control in a hot area or in direct sunlight can damage it, and the repairs will not be covered by the warranty. Storage in extreme cold can weaken the batteries. Keep the remote control stored in a cool, dry place.

Remote Control Buttons

 **(Power):** Press to turn the video screen on and off.

 **(Illumination):** Press to turn the remote control backlight on. The backlight automatically times out after seven to 10 seconds if no other button is pressed while the backlight is on.

 **(Title):** Press to return the DVD to the main menu of the DVD. This function could vary for each disc.

 **(Main Menu):** Press to access the DVD menu. The DVD menu is different on every DVD. Use the navigation arrows to move the cursor around the DVD menu. After making a selection press the enter button. This button only operates when using a DVD.

▲, ▼, ◀, ▶ (Menu Navigation Arrows): Use the arrow buttons to navigate through a menu.

↵ (Enter): Press to select the choice that is highlighted in any menu.

□ (Display Menu): Press to adjust the brightness, screen display mode (normal, full, or zoom), and display the language menu.

↶ (Return): Press to exit the current active menu and return to the previous menu. This button operates only when the display menu or a DVD menu is active.

■ (Stop): Press to stop playing, rewinding, or fast forwarding a DVD. Press twice to return to the beginning of the DVD.

▶ || (Play/Pause): Press to start playing a DVD. Press while a DVD is playing to pause it. Press again to continue playing the DVD.

When the DVD is playing, depending on the radio, play may be slowed down by pressing ▶ || then ▶▶. The DVD continues playing in a slow play mode. Depending on the radio, perform reverse slow play by pressing ▶ || then ◀◀. To cancel slow play mode, press ▶ || again.

◀ (Previous Track/Chapter): Press to return to the start of the current track or chapter. Press again to go to the previous track or chapter. This button might not work when the DVD is playing the copyright information or the previews.

▶| (Next Track/Chapter): Press to go to the beginning of the next chapter or track. This button might not work when the DVD is playing the copyright information or the previews.

◀◀ (Fast Reverse): Press to quickly reverse the DVD or CD. To stop fast reversing a DVD video, press ▶ ||. To stop fast reversing a DVD audio or CD, release ◀◀. This button might not work when the DVD is playing the copyright information or the previews.

▶▶ (Fast Forward): Press to fast forward the DVD or CD. To stop fast forwarding a DVD video, press ▶ ||. To stop fast forwarding a DVD audio or CD, release ▶▶. This button might not work when the DVD is playing the copyright information or the previews.

 **(Audio):** Press to change audio tracks on DVDs that have this feature when the DVD is playing. The format and content of this function vary for each disc.

 **(Subtitles):** Press to turn ON/OFF subtitles and to move through subtitle options when a DVD is playing. The format and content of this function vary for each disc.

AUX (Auxiliary): Press to switch the system between the DVD player and an auxiliary source.

 **(Camera):** Press to change camera angles on DVDs that have this feature when a DVD is playing. The format and content of this function vary for each disc.

1 through 0 (Numeric Keypad): The numeric keypad provides the capability of direct chapter or track number selection.

 **(Clear):** Press within three seconds after entering a numeric selection, to clear all numerical inputs.

≥ 10 (Double Digit Entries): Press to select chapter or track numbers greater than nine. Press this button before entering the number.

If the remote control becomes lost or damaged, a new universal remote control can be purchased. If this happens, make sure the universal remote control uses a Toshiba® code set.

Battery Replacement

To change the remote control batteries:

1. Slide the rear cover back on the remote control.
2. Replace the two batteries in the compartment. Make sure that they are installed correctly, using the diagram on the inside of the battery compartment.
3. Replace the battery cover.

If the remote control is to be stored for a long period of time, remove the batteries and keep them in a cool, dry place.

Tips and Troubleshooting Chart

Problem	Recommended Action
There is no power.	The ignition might not be turned to ON/RUN or ACC/ACCESSORY.
The picture does not fill the screen. There are black borders on the top and bottom or on both sides, or the picture looks stretched out.	Check the display mode settings in the setup menu by pressing the display menu button on the remote control.
In auxiliary mode, the picture moves or scrolls.	Check the auxiliary input connections at both devices.
The remote control does not work.	Check to make sure there is no obstruction between the remote control and the transmitter window. Check the batteries to make sure they are not dead or installed incorrectly.
After stopping the player, and pushing Play, sometimes the DVD starts where it left off and sometimes at the beginning.	If the stop button was pressed one time, the DVD player resumes playing where the DVD was stopped. If the stop button was pressed two times, the DVD player begins to play from the beginning of the DVD.

Tips and Troubleshooting Chart (cont.)

Problem	Recommended Action
The auxiliary source is running, but there is no picture or sound.	Check that the RSE video screen is in the auxiliary source mode. Check the auxiliary input connections at both devices.
Sometimes the wireless headphone audio cuts out or buzzes.	Check for obstructions, low batteries, reception range, and interference from cellular telephone towers, or use a cellular telephone in the vehicle. Check that the headphones are on correctly using the L (left) and R (right) on the headphones.
The remote and/or the headphones are lost.	See your dealer for assistance.
The DVD is playing, but there is no picture or sound.	Check that the RSE video screen is sourced to the DVD player.

DVD Display Error Messages

The DVD display error message depends on which radio the vehicle has. The video screen might display one of the following:

Disc Load/Eject Error: This message displays when there are disc load or eject problems.

Disc Format Error: This message displays if the disc is inserted with the disc label wrong side up, or if the disc is damaged.

Disc Region Error: This message displays if the disc is not from a correct region.

No Disc Inserted: This message displays if no disc is present when the  EJECT button is pressed on the radio.

DVD Distortion

Video distortion can occur when operating cellular phones, scanners, CB radios, Global Position Systems (GPS)*, two-way radios, mobile faxes, or walkie talkies.

It might be necessary to turn off the DVD player when operating one of these devices in or near the vehicle.

*Excludes the OnStar[®] System.

Cleaning the RSE Overhead Console

When cleaning the RSE overhead console surface, use only a clean cloth dampened with clean water.

Cleaning the Video Screen

Use only a clean cloth dampened with clean water. Use care when directly touching or cleaning the screen, as damage could result.

Rear Seat Audio (RSA) System

For vehicles with Rear Seat Audio (RSA), rear seat passengers can listen to and control any of the music sources: radio, CDs, DVDs, or other auxiliary sources. The rear seat passengers can only control the music sources the front seat passengers are not listening to (except on some radios where dual control is allowed). For example, rear seat passengers can control a CD and listen to it through the headphones, while the driver listens to the radio through the front speakers. The rear seat passengers have control of the volume for each set of headphones.

The RSA functions operate even when the main radio is off. The front audio system displays  when the RSA is on, and disappears from the display when it is off.

Audio can be heard through wired headphones (not included) plugged into the jacks on the RSA. If the vehicle has this feature, audio can also be heard on Channel 2 of the wireless headphones.

The audio system mutes the rear speakers when the RSA audio is active through the headphones.

To listen to an iPod or portable audio device through the RSA, attach the iPod or portable audio device to the front auxiliary input (if available), located on the front audio system. Turn the iPod on, then choose the front auxiliary input with the RSA SRCE button.







 **(Power):** Press to turn the RSA on or off.

Volume: Turn to increase or to decrease the volume of the wired headphones. The left knob controls the left headphones and the right knob controls the right headphones.

SRCE (Source): Press to select between the radio (AM/FM), CD, and if the vehicle has these features, DVD, front auxiliary, and rear auxiliary.

 **(Seek):** Press to go to the previous or next station and stay there. This function is inactive, with some radios, if the front seat passengers are listening to the radio.

Press and hold  or  until the display flashes to tune to an individual station. The display stops flashing after the buttons have not been pushed for more than two seconds. This function is inactive, with some radios, if the front seat passengers are listening to the radio.

While listening to a disc, press  to go to the next track or chapter on the disc. Press  to go back to the start of the current track or chapter (if more than 10 seconds have played). This function is inactive, with some radios, if the front seat passengers are listening to the disc.

When a DVD video menu is being displayed, press \blacktriangleleft or \blacktriangleright to perform a cursor up or down on the menu. Hold \blacktriangleleft or \blacktriangleright to perform a cursor left or right on the menu.

PROG (Program): Press to go to the next preset radio station or channel set on the main radio. This function is inactive, with some radios, if the front seat passengers are listening to the radio.

When a CD or DVD audio disc is playing, press PROG to go to the beginning of the CD or DVD audio. This function is inactive, with some radios, if the front seat passengers are listening to the disc.

When a disc is playing in the CD or DVD changer, press PROG to select the next disc, if multiple discs are loaded. This function is inactive, with some radios, if the front seat passengers are listening to the disc.

When a DVD video menu is being displayed, press PROG to perform the ENTER menu function.

Phone

Bluetooth

For vehicles equipped with Bluetooth capability, the system can interact with many cell phones, allowing:

- Placement and receipt of calls in a hands-free mode.
- Sharing of the cell phone's address book or contact list with the vehicle.

To minimize driver distraction, before driving, and with the vehicle parked:

- Become familiar with the features of the cell phone. Organize the phone book and contact lists clearly and delete duplicate or rarely used entries. If possible, program speed dial or other shortcuts.

- Review the controls and operation of the infotainment system.
- Pair cell phone(s) to the vehicle. The system may not work with all cell phones. See "Pairing" in this section for more information.
- If the cell phone has voice dialing capability, learn to use that feature to access the address book or contact list. See "Voice Pass-Thru" in this section for more information.
- See "Storing and Deleting Phone Numbers" in this section for more information.

 **WARNING**

When using a cell phone, it can be distracting to look too long or too often at the screen of the phone or the infotainment (navigation) system. Taking your eyes off the road too long or too often could cause a crash resulting in injury or death. Focus your attention on driving.

A Bluetooth system can use a Bluetooth-capable cell phone with a Hands-Free Profile to make and receive phone calls. The system can be used while the key is in the ON/RUN or ACC/ACCESSORY position. The range of the Bluetooth system can be up to 9.1 m (30 ft). Not all phones support all functions, and not all phones work with the in-vehicle Bluetooth system. See www.gm.com/bluetooth for more information on compatible phones.

Voice Recognition

The Bluetooth system uses voice recognition to interpret voice commands to dial phone numbers and name tags.

For additional information, say “Help” while you are in a voice recognition menu.

Noise: Keep interior noise levels to a minimum. The system may not recognize voice commands if there is too much background noise.

When to Speak: A short tone sounds after the system responds indicating when it is waiting for a voice command. Wait until the tone and then speak.

How to Speak: Speak clearly in a calm and natural voice.

Audio System

When using the in-vehicle Bluetooth system, sound comes through the vehicle's front audio system speakers and overrides the audio system. Use the audio system volume knob, during a call, to change the volume level. The adjusted volume level remains in memory for later calls. To prevent missed calls, a minimum volume level is used if the volume is turned down too low.

Bluetooth Controls

Use the buttons located on the steering wheel to operate the in-vehicle Bluetooth system. See *Steering Wheel Controls* on page 5-3 for more information.

 **(Push To Talk):** Press to answer incoming calls, confirm system information, and start speech recognition.

 **(Phone On Hook):** Press to end a call, reject a call, or cancel an operation.

Pairing



A Bluetooth enabled cell phone must be paired to the Bluetooth system and then connected to the vehicle before it can be used. See the cell phone manufacturer's user guide for Bluetooth functions before pairing the cell phone. If a Bluetooth phone is not connected, calls will be made using OnStar Hands-Free Calling, if equipped. See *OnStar Overview on page 14-1* for more information.

Pairing Information

- A Bluetooth phone with MP3 capability cannot be paired to the vehicle as a phone and an MP3 player at the same time.
- Up to five cell phones can be paired to the Bluetooth system.
- The pairing process is disabled when the vehicle is moving.



- Pairing only needs to be completed once, unless the pairing information on the cell phone changes or the cell phone is deleted from the system.
- Only one paired cell phone can be connected to the Bluetooth system at a time.
- If multiple paired cell phones are within range of the system, the system connects to the first available paired cell phone in the order that they were first paired to the system. To connect to a different paired phone, see "Connecting to a Different Phone" later in this section.

Pairing a Phone

1. Press and hold  /  for two seconds.
2. Say "Bluetooth." This command can be skipped.
3. Say "Pair." The system responds with instructions and a four-digit Personal Identification Number (PIN). The PIN is used in Step 5.
4. Start the pairing process on the cell phone that you want to pair. For help with this process, see the cell phone manufacturer's user guide.
5. Locate the device named "Your Vehicle" in the list on the cell phone. Follow the instructions on the cell phone to enter the PIN that was provided in Step 3. After the PIN is successfully entered, the system prompts you to provide a name for the paired cell phone. This name will be used to indicate which phones are paired and connected to the vehicle. The system responds with "<phone name> has been successfully paired" after the pairing process is complete.
6. Repeat Steps 1 through 5 to pair additional phones.



Listing All Paired and Connected Phones

The system can list all cell phones paired to it. If a paired cell phone is also connected to the vehicle, the system responds with “is connected” after that phone name.

1. Press and hold  /  for two seconds.
2. Say “Bluetooth.”
3. Say “List.”



Deleting a Paired Phone

If the phone name you want to delete is unknown, see “Listing All Paired and Connected Phones.”

1. Press and hold  /  for two seconds.
2. Say “Bluetooth.”
3. Say “Delete.” The system asks which phone to delete.
4. Say the name of the phone you want to delete.

Connecting to a Different Phone

To connect to a different cell phone, the Bluetooth system looks for the next available cell phone in the order in which all the available cell phones were paired. Depending on which cell phone you want to connect to, you may have to use this command several times.

1. Press and hold  /  for two seconds.
2. Say “Bluetooth.”
3. Say “Change phone.”
 - If another cell phone is found, the response will be “<Phone name> is now connected.”
 - If another cell phone is not found, the original phone remains connected.

Storing and Deleting Phone Numbers

The system can store up to 30 phone numbers as name tags in the Hands-Free Directory that is shared between the Bluetooth and OnStar systems, if equipped.

The following commands are used to delete and store phone numbers.



Store: This command will store a phone number, or a group of numbers as a name tag.

Digit Store: This command allows a phone number to be stored as a name tag by entering the digits one at a time.

Delete: This command is used to delete individual name tags.

Delete All Name Tags: This command deletes all stored name tags in the Hands-Free Calling Directory and the OnStar Turn-by-Turn Destinations Directory, if equipped.



Using the “Store” Command

1. Press and hold  /  for two seconds.
2. Say “Store.”
3. Say the phone number or group of numbers you want to store all at once with no pauses, then follow the directions given by the system to save a name tag for this number.

Using the “Digit Store” Command



If an unwanted number is recognized by the system, say “Clear” at any time to clear the last number.

To hear all of the numbers recognized by the system, say “Verify” at any time.

1. Press and hold  /  for two seconds.
2. Say “Digit Store.”

3. Say each digit, one at a time, that you want to store. After each digit is entered, the system repeats back the digit it heard followed by a tone. After the last digit has been entered, say “Store,” and then follow the directions given by the system to save a name tag for this number.



Using the “Delete” Command

1. Press and hold  /  for two seconds.
2. Say “Delete.”
3. Say the name tag you want to delete.

Using the “Delete All Name Tags” Command

This command deletes all stored name tags in the Hands-Free Calling Directory and the OnStar Turn-by-Turn Destinations Directory, if equipped.



To delete all name tags:

1. Press and hold  /  for two seconds.
2. Say “Delete all name tags.”

Listing Stored Numbers

The list command will list all stored numbers and name tags.

Using the “List” Command

1. Press and hold  /  for two seconds.
2. Say “Directory.”
3. Say “Hands-Free Calling.”
4. Say “List.”

Making a Call



Calls can be made using the following commands.

Dial or Call: The dial or call command can be used interchangeably to dial a phone number or a stored name tag.

Digit Dial: This command allows a phone number to be dialed by entering the digits one at a time.

Re-dial: This command is used to dial the last number used on the cell phone.

Using the “Dial” or “Call” Command

1. Press and hold  /  for two seconds.
2. Say “Dial” or “Call.”
3. Say the entire number without pausing, or say the name tag.



Once connected, the person called will be heard through the audio speakers.

Using the “Digit Dial” Command

The digit dial command allows a phone number to be dialed by entering the digits one at a time. After each digit is entered, the system repeats back the digit it heard followed by a tone.



If an unwanted number is recognized by the system, say “Clear” at any time to clear the last number.

To hear all of the numbers recognized by the system, say “Verify” at any time.

1. Press and hold  /  for two seconds.
2. Say “Digit Dial.”
3. Say each digit, one at a time, that you want to dial. After each digit is entered, the system repeats back the digit it heard followed by a tone. After the last digit has been entered, say “Dial.”

Once connected, the person called will be heard through the audio speakers.





Using the “Re-dial” Command

1. Press and hold  /  for two seconds.
2. After the tone, say “Re-dial.”

Once connected, the person called will be heard through the audio speakers.







Receiving a Call

When an incoming call is received, the audio system mutes and a ring tone is heard in the vehicle.

- Press  /  to answer the call.
- Press  /  to ignore a call.



Call Waiting



Call waiting must be supported on the cell phone and enabled by the wireless service carrier.

- Press  /  to answer an incoming call when another call is active. The original call is placed on hold.
- Press  /  again to return to the original call.
- To ignore the incoming call, no action is required.
- Press  /  to disconnect the current call and switch to the call on hold.

Three-Way Calling

Three-way calling must be supported on the cell phone and enabled by the wireless service carrier.

1. While on a call, press  / .
2. Say "Three-way call."





3. Use the dial or call command to dial the number of the third party to be called.
4. Once the call is connected, press  /  to link all callers together.

Ending a Call

Press  /  to end a call.

Muting a Call

During a call, all sounds from inside the vehicle can be muted so that the person on the other end of the call cannot hear them.

- To mute a call, press  / , and then say "Mute call."
- To cancel mute, press  / , and then say "Un-mute call."



Transferring a Call

Audio can be transferred between the Bluetooth system and the cell phone.



The cell phone must be paired and connected with the Bluetooth system before a call can be transferred. The connection process can take up to two minutes after the ignition is turned to ON/RUN.

Transferring Audio from the Bluetooth System to a Cell Phone

During a call with the audio in the vehicle:

1. Press  / .
2. Say "Transfer Call."



Transferring Audio to the Bluetooth System from a Cell Phone

During a call with the audio on the cell phone, press  / . The audio transfers to the vehicle. If the audio does not transfer to the vehicle, use the audio transfer feature on the cell phone. See your cell phone manufacturer's user guide for more information.

Voice Pass-Thru

Voice pass-thru allows access to the voice recognition commands on the cell phone. See your cell phone manufacturer's user guide to see if the cell phone supports this feature.

To access contacts stored in the cell phone:

1. Press and hold  /  for two seconds.
2. Say "Bluetooth." This command can be skipped.



3. Say "Voice." The system responds "OK, accessing <phone name>."

The cell phone's normal prompt messages will go through their cycle according to the phone's operating instructions.

Dual Tone Multi-Frequency (DTMF) Tones

The Bluetooth system can send numbers and the numbers stored as name tags during a call. You can use this feature when calling a menu-driven phone system. Account numbers can also be stored for use.

Sending a Number or Name Tag During a Call

1. Press  / . The system responds "Ready," followed by a tone.
2. Say "Dial."
3. Say the number or name tag to send.

Clearing the System

Unless information is deleted out of the in-vehicle Bluetooth system, it will be retained indefinitely. This includes all saved name tags in the phone book and phone pairing information. For information on how to delete this information, see the previous section "Deleting a Paired Phone" and the previous sections on deleting name tags.

Other Information

The Bluetooth® word mark and logos are owned by the Bluetooth® SIG, Inc. and any use of such marks by General Motors is under license. Other trademarks and trade names are those of their respective owners.

See *Radio Frequency Statement on page 13-23* for information regarding Part 15 of the Federal Communications Commission (FCC) rules and Industry Canada Standards RSS-GEN/210/220/310.

Trademarks and License Agreements



Manufactured under license under U.S. Patent #'s: 5,451,942; 5,956,674; 5,974,380; 5,978,762; 6,487,535 & other U.S. and worldwide patents issued & pending. DTS and DTS Digital Surround are registered trademarks and the DTS logos and Symbol are trademarks of DTS, Inc. © 1996-2010 DTS, Inc. All Rights Reserved.



Manufactured under license from Dolby Laboratories. Dolby and the double-D symbol are trademarks of Dolby Laboratories. Copyright 1992-2010 Dolby Laboratories. All rights reserved.

Climate Controls

Climate Control Systems

Dual Automatic Climate Control System 8-1

Rear Climate Control System (Rear Climate Control Only) 8-7

Rear Climate Control System (Rear Climate with Rear Seat Audio) 8-8

Air Vents

Air Vents 8-9

Maintenance

Passenger Compartment Air Filter 8-10

Climate Control Systems

Dual Automatic Climate Control System

The heating, cooling, and ventilation in the vehicle can be controlled with this system.

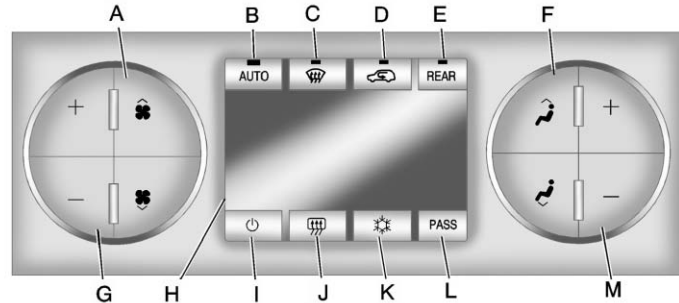

- | | |
|------------------------------------|---------------------------------------|
| A. Fan Control | H. Display |
| B. AUTO (Automatic Operation) | I. Power (On/Off) |
| C. Defrost | J. Rear Window Defogger |
| D. Recirculation | K. Air Conditioning |
| E. REAR (Rear Climate Control) | L. PASS (Passenger) |
| F. Air Delivery Mode Control | M. Passenger Side Temperature Control |
| G. Driver Side Temperature Control | |

8-2 Climate Controls

Display Function

Each time the temperature, mode, or fan control buttons are pressed, the climate control display shows that function along with the inside temperature setting. The outside temperature is displayed on the instrument panel cluster.

 **(On/Off):** Press to turn the climate control system on or off. While the system is off, outside air still enters through the floor outlets, but the air delivery mode can be adjusted.

The climate control system will also turn on if either the fan control, defrost, AUTO, or air conditioning buttons are pressed.

Automatic Operation

AUTO (Automatic): The system automatically controls the inside temperature, the air delivery, and the fan speed.

To use automatic mode:

1. Press the AUTO button.

When AUTO is selected, the current temperature(s) selected and AUTO is shown on the display. The current air delivery mode and fan speed also appear for approximately five seconds.

When AUTO is selected, the air conditioning and air inlet are automatically controlled. The air conditioning runs when the outside temperature is over 4°C (40°F). The system is automatically set to outside air, unless it is hot outside and then the air inlet changes to recirculation mode to help

quickly cool the vehicle. The recirculation indicator light will come on.

2. Set the temperature for the driver and passenger.

To find a comfortable setting, start with a 22°C (73°F) temperature setting and allow about 20 minutes for the system to regulate. Use the driver side or passenger side temperature buttons to adjust the temperature setting as necessary. The system will remain at the selected setting. Choosing the warmest or coolest temperatures does not cause the vehicle to heat or cool more quickly.

To avoid blowing cold air in cold weather, the system delays turning on the fan until warm air is available. Press the fan control to override this delay and select the fan speed.

Temperature Control

The driver and passenger side temperature buttons are used to adjust the temperature of the air coming through the system. The temperature can be adjusted even if the system is turned off since outside air still enters the vehicle, unless the recirculation mode is selected. See "Recirculation" later in this section.

Driver Side Temperature

Control: Press the + or – buttons to increase or decrease the driver side temperature. The driver side temperature display will show the temperature setting.



Passenger Side Temperature



Control: Press the + or – buttons to increase or decrease the passenger side temperature. The passenger side display will show the temperature setting.

PASS (Passenger): Press to set the passenger temperature to match the driver temperature setting. The PASS indicator will turn off. When the passenger temperature setting is different than the driver setting, the PASS indicator comes on.





Manual Operation

The air delivery mode or fan speed can be manually adjusted.

 /  (**Fan Control**): Press to increase or decrease the fan speed.

Pressing  or  while in automatic control places the fan speed under manual control.

The air delivery mode remains in automatic control. The fan setting still displays, but the word AUTO no longer displays, and the AUTO button indicator light turns off.

 /  (**Air Delivery Mode Control**): Press to change the direction of the airflow in the vehicle. Repeatedly press  or  until the desired mode appears on the display. Pressing a mode button while the system is off changes the air delivery mode without turning the system on. Press a mode button while in automatic control to place the system into manual control.

The air delivery mode setting still displays, but the word AUTO no longer displays, and the AUTO button indicator light turns off.

 (**Vent**): Air is directed to the instrument panel outlets.

 (**Bi-Level**): Air is divided between the instrument panel and floor outlets. Some air is directed towards the windshield and side window outlets. Cooler air is directed to the upper outlets and warmer air to the floor outlets.

8-4 Climate Controls

 **(Floor):** Air is directed to the floor outlets, with some of the air directed to the windshield, side window, and second row floor outlets. In this mode, the system uses outside air.

 **(Defog):** This mode clears the windows of fog or moisture. Air is directed to the windshield, floor outlets, and side window vents. When this mode is selected, the system turns off recirculation and runs the air conditioning compressor unless the outside temperature is less than 4°C (40°F). Do not drive the vehicle until all the windows are clear.

 **(Defrost):** Press to turn the defrost on or off. This mode quickly clears the windshield of fog or frost. Air is directed to the windshield, side window, and floor vents.

In this mode, outside air is pulled inside the vehicle. The air conditioning system runs automatically in this setting, unless the outside temperature is less than 4°C (40°F).

Do not drive the vehicle until all the windows are clear.

While in defrost mode, if the PASS button is pressed, the PASS button indicator flashes three times to show that the passenger climate control system cannot be activated. If the passenger temperature buttons are adjusted while in defrost mode, the driver temperature indicator will change. The passenger temperature will not be displayed.

When returning to bi-level, vent, or floor mode, the previous temperature settings displays in place of any change made while in defrost mode.

Air Conditioning

 **(Air Conditioning):** Press to turn the air conditioning (A/C) on and off. An indicator light comes on when A/C is on.

The A/C does not work when the outside temperature is below 4°C (40°F). If  is pressed the indicator flashes three times and turns off to show that the A/C mode is not available. If the A/C is on and the outside temperature drops below a temperature which is too cool for air conditioning to be effective, the A/C indicator turns off to show that the A/C mode has been canceled.

On hot days, open the windows briefly to let hot inside air escape. This helps reduce the time it takes for the interior of the vehicle to cool down.

The air conditioning system removes moisture from the air, so water might drip under the vehicle while idling or after turning off the engine. This is normal.

 **(Recirculation):** Press to turn the recirculation mode on or off. An indicator light comes on when recirculation is on. When the engine is turned off, the recirculation mode automatically turns off and must be re-selected when the engine is turned on again.

This mode recirculates and helps to quickly cool the air inside the vehicle. It can be used to prevent outside air and odors from entering the vehicle.

The recirculation mode cannot be used with floor, defog, or defrosting modes. If recirculation is selected in these modes, the indicator flashes three times and turns off.

The air conditioning compressor also comes on when this mode is activated. While in recirculation mode the windows can fog when the weather is cold and damp. To clear the fog, select either the defog or defrost mode and increase the fan speed.

REAR: Press to turn the rear heating and air conditioning on or off. See *Rear Climate Control System (Rear Climate Control Only)* on page 8-7 or *Rear Climate Control System (Rear Climate with Rear Seat Audio)* on page 8-8.

Rear Window Defogger

The rear window defogger uses a warming grid to remove fog from the rear window.

 **(Rear Window Defogger):** Press to turn the rear window defogger on or off. The rear window defogger stays on for about 10 minutes, before turning off.

The defogger also turns off when the engine is turned off. Do not drive the vehicle until all the windows are clear.

For vehicles with heated outside rearview mirrors, fog or frost is cleared from the surface of the mirror when the rear window defog button is pressed.

Notice: Do not use a razor blade or sharp object to clear the inside rear window. Do not adhere anything to the defogger grid lines in the rear glass. These actions may damage the rear defogger. Repairs would not be covered by your warranty.

8-6 Climate Controls

Sensors

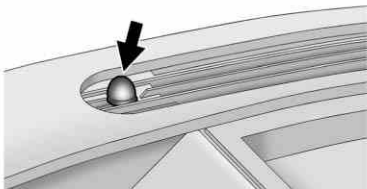

The solar sensor, located in the defrost grille in the middle of the instrument panel, monitors the solar heat. Do not cover the solar sensor or the system will not work properly.

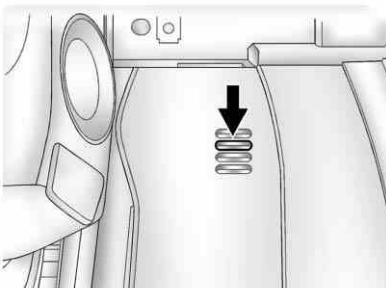

The interior temperature sensor located on the instrument panel to the right of the steering column, measures the temperature of the air inside the vehicle.

There is also an exterior temperature sensor located behind the front grille. This sensor reads the outside air temperature and helps maintain the temperature inside the vehicle. Any cover on the front of the vehicle could cause a false reading in the displayed temperature.

The climate control system uses the information from these sensors to maintain comfort settings by adjusting the temperature, fan speed, and air delivery mode. The system may also supply cooler air to the side of the vehicle facing the sun. The recirculation mode will also be used as needed to maintain cool outlet temperatures.

Rear Climate Control System (Rear Climate Control Only)

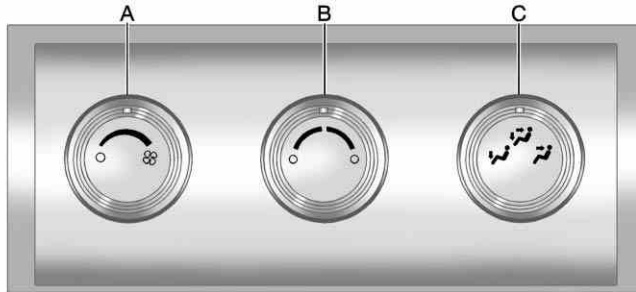

- A. Fan Control
- B. Temperature Control
- C. Air Delivery Mode Control

For vehicles with the rear climate control system, the controls are located on the rear of the center console. The system can also be controlled with the front controls.

Press the REAR button on the front climate control system to turn the rear climate control system on or off. An indicator comes on when the rear system is on. The system also turns on if any of the rear controls are adjusted.

Mimic Mode: This mode matches the rear climate control to the front climate control settings. It comes on when REAR is pressed.

Independent Mode: This mode directs rear seating airflow according to the settings of the rear controls. It comes on when any rear control is adjusted.

Fan Control: Turn clockwise or counterclockwise to increase or decrease the fan speed. Turn the knob to  to turn the fan off.

Temperature Control: Turn clockwise or counterclockwise to increase or decrease the airflow temperature.

Air Delivery Mode Control: Turn to the desired mode to change the airflow direction.

 **(Vent):** Air is directed through the overhead outlets.

 **(Bi-Level):** Air is directed through the rear floor outlets, as well as the overhead outlets.

 **(Floor):** Air is directed through the floor outlets. The rear system floor outlets are located under the third row seats.

8-8 Climate Controls

Rear Climate Control System (Rear Climate with Rear Seat Audio)

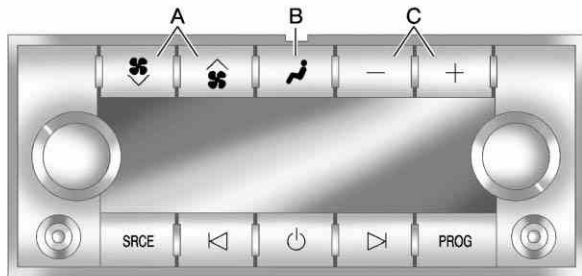

- A. Fan Control
- B. Air Delivery Mode Control
- C. Temperature Control



For vehicles with the rear climate control system, the controls are located on the rear of the center console.

Press the REAR button on the front climate control system to turn the rear climate control system on or off. The system also turns on if any of the rear controls, except , are pressed. An indicator comes on when the rear system is on.

The system can also be turned off, by pressing and holding .

Mimic Mode: This mode matches the rear climate control to the front climate control settings. It comes on when REAR is pressed.

Independent Mode: This mode directs rear seating airflow according to the settings of the rear controls. It comes on when any rear control is adjusted.

 and  (Fan Control): Press the fan up or down buttons to increase or decrease the fan speed.

Temperature Control:

Press + or - to increase or decrease the air temperature. The temperature settings will display in 0-12 increments, going from the coolest (0) to the warmest (12) setting.

 **(Air Delivery Mode Control):** Press to manually change the direction of the airflow. Repeatedly press the button until the desired mode appears on the display.

 **(Vent):** Air is directed through the overhead outlets.

 **(Bi-Level):** Air is directed through the rear floor outlets, as well as the overhead outlets.

 **(Floor):** Air is directed through the floor outlets. The rear system floor outlets are located under the third row seats.

Air Vents

Use the slider switch in the center of the outlet, to change the direction of the airflow. Use the thumbwheel near the outlet to control the amount of airflow or to shut off the airflow.

Keep all outlets open whenever possible for best system performance.

Operation Tips

- Clear away any ice, snow, or leaves from the air inlets at the base of the windshield that can block the flow of air into the vehicle.

- Use of non-GM approved hood deflectors can adversely affect the performance of the system.
- Keep the path under all seats clear of objects to help circulate the air inside the vehicle more effectively.
- If fogging reoccurs while in vent or bi-level modes with mild temperature throughout the vehicle, turn on the air conditioner to reduce windshield fogging.

Maintenance

Passenger Compartment Air Filter

The filter removes dust, pollen, and other airborne irritants from outside air and inside air when in recirculation mode.

To find out what type of replacement filter to use, see *Maintenance Replacement Parts* on page 11-14.

1. Open the glove box.

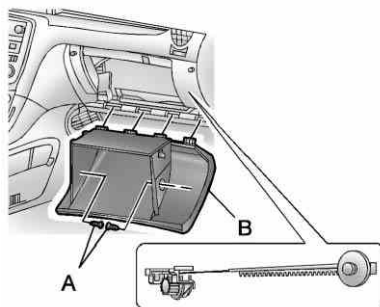

2. Twist the compartment retainers (A) and pull outward to remove.
3. Lower the instrument panel compartment assembly (B) beyond the stops.
4. If needed, unsnap the instrument panel compartment assembly (B) from the instrument panel. When reinstalling, be sure the instrument panel compartment dampener arm is aligned properly to the dampener gear assembly.

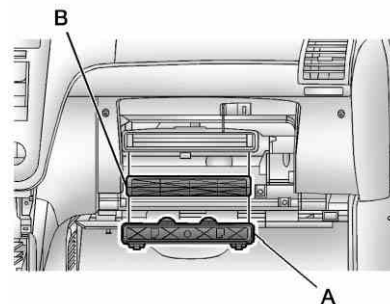

5. Squeeze the housing cover (A) tabs to remove.
6. Remove the old air filter from the passenger compartment air filter housing (B).
7. Install the new air filter.
8. Replace the housing cover.
9. If removed, reinstall the instrument panel compartment assembly.
10. Reinstall the compartment retainers.

See your dealer if additional assistance is needed.

Driving and Operating

Driving Information

Distracted Driving	9-2
Defensive Driving	9-3
Drunk Driving	9-3
Control of a Vehicle	9-3
Braking	9-3
Steering	9-4
Off-Road Recovery	9-5
Loss of Control	9-5
Driving on Wet Roads	9-6
Highway Hypnosis	9-7
Hill and Mountain Roads	9-8
Winter Driving	9-9
If the Vehicle Is Stuck	9-11
Vehicle Load Limits	9-12

Starting and Operating

New Vehicle Break-In	9-17
Ignition Positions	9-18
Starting the Engine	9-19
Engine Heater	9-21
Retained Accessory Power (RAP)	9-21

Shifting Into Park	9-22
Shifting out of Park	9-23
Parking over Things That Burn	9-24

Engine Exhaust

Engine Exhaust	9-24
Running the Vehicle While Parked	9-25

Automatic Transmission

Automatic Transmission	9-26
Manual Mode	9-28
Tow/Haul Mode	9-29

Drive Systems

All-Wheel Drive	9-29
-----------------------	------

Brakes

Antilock Brake System (ABS)	9-30
Parking Brake	9-31
Brake Assist	9-31
Hill Start Assist (HSA)	9-32

Ride Control Systems

StabiliTrak® System	9-32
---------------------------	------

Cruise Control

Cruise Control	9-34
----------------------	------

Object Detection Systems

Ultrasonic Parking Assist	9-37
Rear Vision Camera (RVC)	9-38

Fuel

Fuel	9-44
Recommended Fuel	9-44
Gasoline Specifications (U.S. and Canada Only)	9-44
California Fuel Requirements	9-45
Fuels in Foreign Countries ...	9-45
Fuel Additives	9-45
Filling the Tank	9-46
Filling a Portable Fuel Container	9-48

Towing

General Towing Information	9-48
Driving Characteristics and Towing Tips	9-49
Trailer Towing	9-54
Towing Equipment	9-56

Conversions and Add-Ons

Add-On Electrical Equipment	9-58
--------------------------------------	------

Driving Information

Distracted Driving

Distraction comes in many forms and can take your focus from the task of driving. Exercise good judgment and do not let other activities divert your attention away from the road. Many local governments have enacted laws regarding driver distraction. Become familiar with the local laws in your area.

To avoid distracted driving, always keep your eyes on the road, hands on the wheel, and mind on the drive.

- Do not use a phone in demanding driving situations. Use a hands-free method to place or receive necessary phone calls.

- Watch the road. Do not read, take notes, or look up information on phones or other electronic devices.
- Designate a front seat passenger to handle potential distractions.
- Become familiar with vehicle features before driving, such as programming favorite radio stations and adjusting climate control and seat settings. Program all trip information into any navigation device prior to driving.
- Wait until the vehicle is parked to retrieve items that have fallen to the floor.
- Stop or park the vehicle to tend to children.

- Keep pets in an appropriate carrier or restraint.
- Avoid stressful conversations while driving, whether with a passenger or on a cell phone.

WARNING

Taking your eyes off the road too long or too often could cause a crash resulting in injury or death. Focus your attention on driving.

Refer to the Infotainment section for more information on using that system, including pairing and using a cell phone.

If equipped, refer to the navigation manual for information on that system, including pairing and using a cell phone.

Defensive Driving

Defensive driving means “always expect the unexpected.” The first step in driving defensively is to wear the safety belt. See *Safety Belts* on page 3-14.

- Assume that other road users (pedestrians, bicyclists, and other drivers) are going to be careless and make mistakes. Anticipate what they might do and be ready.
- Allow enough following distance between you and the driver in front of you.
- Focus on the task of driving.

Drunk Driving

Death and injury associated with drinking and driving is a global tragedy.

WARNING

Drinking and then driving is very dangerous. Your reflexes, perceptions, attentiveness, and judgment can be affected by even a small amount of alcohol. You can have a serious — or even fatal — collision if you drive after drinking.

Do not drink and drive or ride with a driver who has been drinking. Ride home in a cab; or if you are with a group, designate a driver who will not drink.

Control of a Vehicle

Braking, steering, and accelerating are important factors in helping to control a vehicle while driving.

Braking

Braking action involves perception time and reaction time. Deciding to push the brake pedal is perception time. Actually doing it is reaction time.

Average driver reaction time is about three-fourths of a second. In that time, a vehicle moving at 100 km/h (60 mph) travels 20 m (66 ft), which could be a lot of distance in an emergency.

9-4 Driving and Operating

Helpful braking tips to keep in mind include:

- Keep enough distance between you and the vehicle in front of you.
- Avoid needless heavy braking.
- Keep pace with traffic.

If the engine ever stops while the vehicle is being driven, brake normally but do not pump the brakes. Doing so could make the pedal harder to push down. If the engine stops, there will be some power brake assist but it will be used when the brake is applied. Once the power assist is used up, it can take longer to stop and the brake pedal will be harder to push.

Steering

Hydraulic Power Steering

Your vehicle has hydraulic power steering. It may require maintenance. See *Power Steering Fluid* on page 10-21.

If power steering assist is lost due to a system malfunction, the vehicle can be steered, but may require increased effort.

Variable Effort Steering

Some vehicles have a steering system that varies the amount of effort required to steer the vehicle in relation to the speed of the vehicle.

The amount of steering effort required is less at slower speeds to make the vehicle more maneuverable and easier to park. At faster speeds, the steering effort increases to provide a sport-like feel to the steering. This provides maximum control and stability.

If the vehicle seems harder to steer than normal when parking or driving slowly, there may be a problem with the system. You will still have power steering, but steering will be stiffer than normal at slow speeds. See your dealer for service.

Curve Tips

- Take curves at a reasonable speed.
- Reduce speed before entering a curve.
- Maintain a reasonable steady speed through the curve.
- Wait until the vehicle is out of the curve before accelerating gently into the straightaway.

Steering in Emergencies

- There are some situations when steering around a problem may be more effective than braking.
- Holding both sides of the steering wheel allows you to turn 180 degrees without removing a hand.
- Antilock Brake System (ABS) allows steering while braking.

Off-Road Recovery

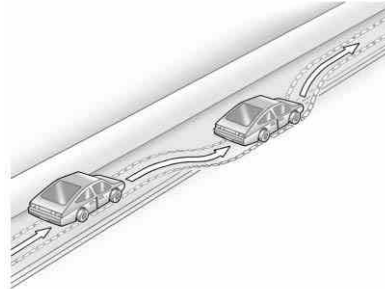

The vehicle's right wheels can drop off the edge of a road onto the shoulder while driving. Follow these tips:

1. Ease off the accelerator and then, if there is nothing in the way, steer the vehicle so that it straddles the edge of the pavement.

2. Turn the steering wheel about one-eighth of a turn, until the right front tire contacts the pavement edge.
3. Then turn the steering wheel to go straight down the roadway.

Loss of Control

Skidding

There are three types of skids that correspond to the vehicle's three control systems:

- Braking Skid — wheels are not rolling.
- Steering or Cornering Skid — too much speed or steering in a curve causes tires to slip and lose cornering force.
- Acceleration Skid — too much throttle causes the driving wheels to spin.

9-6 Driving and Operating

Defensive drivers avoid most skids by taking reasonable care suited to existing conditions, and by not overdriving those conditions.

But skids are always possible.

If the vehicle starts to slide, follow these suggestions:

- Ease your foot off the accelerator pedal and quickly steer the way you want the vehicle to go. The vehicle may straighten out. Be ready for a second skid if it occurs.
- Slow down and adjust your driving according to weather conditions. Stopping distance can be longer and vehicle

control can be affected when traction is reduced by water, snow, ice, gravel, or other material on the road. Learn to recognize warning clues — such as enough water, ice, or packed snow on the road to make a mirrored surface — and slow down when you have any doubt.

- Try to avoid sudden steering, acceleration, or braking, including reducing vehicle speed by shifting to a lower gear. Any sudden changes could cause the tires to slide.

Remember: Antilock brakes help avoid only the braking skid.

Driving on Wet Roads

Rain and wet roads can reduce vehicle traction and affect your ability to stop and accelerate. Always drive slower in these types of driving conditions and avoid driving through large puddles and deep-standing or flowing water.

WARNING

Wet brakes can cause crashes. They might not work as well in a quick stop and could cause pulling to one side. You could lose control of the vehicle.

After driving through a large puddle of water or a car/vehicle wash, lightly apply the brake pedal until the brakes work normally.

(Continued)

WARNING (Continued)

Flowing or rushing water creates strong forces. Driving through flowing water could cause the vehicle to be carried away. If this happens, you and other vehicle occupants could drown. Do not ignore police warnings and be very cautious about trying to drive through flowing water.

Hydroplaning

Hydroplaning is dangerous. Water can build up under the vehicle's tires so they actually ride on the water. This can happen if the road is wet enough and you are going fast enough. When the vehicle is hydroplaning, it has little or no contact with the road.

There is no hard and fast rule about hydroplaning. The best advice is to slow down when the road is wet.

Other Rainy Weather Tips

Besides slowing down, other wet weather driving tips include:

- Allow extra following distance.
- Pass with caution.
- Keep windshield wiping equipment in good shape.
- Keep the windshield washer fluid reservoir filled.
- Have good tires with proper tread depth. See *Tires on page 10-38*.
- Turn off cruise control.

Highway Hypnosis

Always be alert and pay attention to your surroundings while driving. If you become tired or sleepy, find a safe place to park the vehicle and rest.

Other driving tips include:

- Keep the vehicle well ventilated.
- Keep the interior temperature cool.
- Keep your eyes moving — scan the road ahead and to the sides.
- Check the rearview mirror and vehicle instruments often.

9-8 Driving and Operating

Hill and Mountain Roads

Driving on steep hills or through mountains is different than driving on flat or rolling terrain. Tips for driving in these conditions include:

- Keep the vehicle serviced and in good shape.
- Check all fluid levels and brakes, tires, cooling system, and transmission.
- Shift to a lower gear when going down steep or long hills.

WARNING

If you do not shift down, the brakes could get so hot that they would not work well. You would then have poor braking or even none going down a hill. You could crash. Shift down to let the engine assist the brakes on a steep downhill slope.

WARNING

Coasting downhill in N (Neutral) or with the ignition off is dangerous. The brakes will have to do all the work of slowing down and they could get so hot
(Continued)

WARNING (Continued)

that they would not work well. You would then have poor braking or even none going down a hill. You could crash. Always have the engine running and the vehicle in gear when going downhill.

- Stay in your own lane. Do not swing wide or cut across the center of the road. Drive at speeds that let you stay in your own lane.
- Be alert on top of hills, something could be in your lane (stalled car, accident).
- Pay attention to special road signs (falling rocks area, winding roads, long grades, passing or no-passing zones) and take appropriate action.

Winter Driving

Driving on Snow or Ice

Drive carefully when there is snow or ice between the tires and the road, creating less traction or grip. Wet ice can occur at about 0°C (32°F) when freezing rain begins to fall, resulting in even less traction. Avoid driving on wet ice or in freezing rain until roads can be treated with salt or sand.

Drive with caution, whatever the condition. Accelerate gently so traction is not lost. Accelerating too

quickly causes the wheels to spin and makes the surface under the tires slick, so there is even less traction.

Try not to break the fragile traction. If you accelerate too fast, the drive wheels will spin and polish the surface under the tires even more.

The *Antilock Brake System (ABS)* on page 9-30 improves vehicle stability during hard stops on slippery roads, but apply the brakes sooner than when on dry pavement.

Allow greater following distance on any slippery road and watch for slippery spots. Icy patches can occur on otherwise clear roads in shaded areas. The surface of a curve or an overpass can remain icy when the surrounding roads are clear. Avoid sudden steering maneuvers and braking while on ice.

Turn off cruise control on slippery surfaces.

9-10 Driving and Operating

Blizzard Conditions

Being stuck in snow can be a serious situation. Stay with the vehicle unless there is help nearby. If possible, use the *Roadside Assistance Program (U.S. and Canada)* on page 13-8 or *Roadside Assistance Program (Mexico)* on page 13-10. To get help and keep everyone in the vehicle safe:

- Turn on the hazard warning flashers.
- Tie a red cloth to an outside mirror.



WARNING

Snow can trap engine exhaust under the vehicle. This may cause exhaust gases to get inside. Engine exhaust contains

(Continued)

WARNING (Continued)

carbon monoxide (CO) which cannot be seen or smelled. It can cause unconsciousness and even death.

If the vehicle is stuck in the snow:

- Clear away snow from around the base of your vehicle, especially any that is blocking the exhaust pipe.
- Check again from time to time to be sure snow does not collect there.
- Open a window about 5 cm (2 in) on the side of the vehicle that is away from the wind to bring in fresh air.

(Continued)

WARNING (Continued)

- Fully open the air outlets on or under the instrument panel.
- Adjust the climate control system to a setting that circulates the air inside the vehicle and set the fan speed to the highest setting. See “Climate Control System” in the Index.

For more information about carbon monoxide, see *Engine Exhaust* on page 9-24.

Run the engine for short periods only as needed to keep warm, but be careful.

To save fuel, run the engine for only short periods as needed to warm the vehicle and then shut the engine off and close the window most of the way to save heat. Repeat this until help arrives but only when you feel really uncomfortable from the cold. Moving about to keep warm also helps.

If it takes some time for help to arrive, now and then when you run the engine, push the accelerator pedal slightly so the engine runs faster than the idle speed. This keeps the battery charged to restart the vehicle and to signal for help with the headlamps. Do this as little as possible to save fuel.

If the Vehicle Is Stuck

Slowly and cautiously spin the wheels to free the vehicle when stuck in sand, mud, ice, or snow.

If the vehicle has a traction system, it can often help to free a stuck vehicle. Refer to the vehicle's traction system in the Index. If stuck too severely for the traction system to free the vehicle, turn the traction system off and use the rocking method.

WARNING

If the vehicle's tires spin at high speed, they can explode, and you or others could be injured. The vehicle can overheat, causing an engine compartment fire or other damage. Spin the wheels as little as possible and avoid going above 55 km/h (35 mph).

For information about using tire chains on the vehicle, see *Tire Chains* on page 10-59.

Rocking the Vehicle to Get it Out

Turn the steering wheel left and right to clear the area around the front wheels. Turn off any traction or stability system. Shift back and forth between R (Reverse) and a forward gear, spinning the wheels as little as possible. To prevent transmission wear, wait until the wheels stop spinning before shifting gears. Release the accelerator pedal while shifting, and press lightly on the accelerator pedal when the transmission is in gear. Slowly spinning the wheels in the forward and reverse directions causes a rocking motion that could free the vehicle. If that does not get the vehicle out after a few tries, it might need to be towed out. If the vehicle does need to be towed out, see *Towing the Vehicle on page 10-83*.

Vehicle Load Limits

It is very important to know how much weight your vehicle can carry. This weight is called the vehicle capacity weight and includes the weight of all occupants, cargo, and all nonfactory-installed options. Two labels on your vehicle show how much weight it may properly carry, the Tire and Loading Information label and the Certification/Tire label.

WARNING

Do not load the vehicle any heavier than the Gross Vehicle Weight Rating (GVWR), or either the maximum front or rear Gross Axle Weight Rating (GAWR). This can cause systems to break and change the way the vehicle handles. This could cause loss of control and a crash. Overloading can also shorten the life of the vehicle.

Tire and Loading Information Label

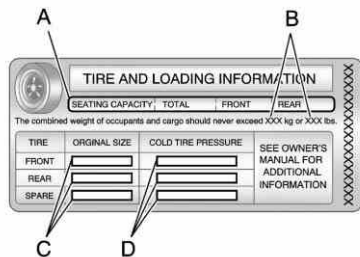

Example Label

A vehicle specific Tire and Loading Information label is attached to the center pillar (B-pillar) of your vehicle. With the driver's door open, you will find the label attached below the door lock post (striker). The tire and loading information label shows the number of occupant

seating positions (A), and the maximum vehicle capacity weight (B) in kilograms and pounds.

The Tire and Loading Information label also shows the size of the original equipment tires (C) and the recommended cold tire inflation pressures (D). For more information on tires and inflation see *Tires on page 10-38* and *Tire Pressure on page 10-45*.

There is also important loading information on the vehicle Certification/Tire label. It tells you the Gross Vehicle Weight Rating (GVWR) and the Gross Axle Weight Rating (GAWR) for the front and rear axle. See "Certification/Tire Label" later in this section.

Steps for Determining Correct Load Limit

1. Locate the statement "The combined weight of occupants and cargo should never exceed XXX kg or XXX lbs" on your vehicle's placard.
2. Determine the combined weight of the driver and passengers that will be riding in your vehicle.
3. Subtract the combined weight of the driver and passengers from XXX kg or XXX lbs.

9-14 Driving and Operating

- The resulting figure equals the available amount of cargo and luggage load capacity. For example, if the “XXX” amount equals 1400 lbs and there will be five 150 lb passengers in your vehicle, the amount of available cargo and luggage load capacity is 650 lbs (1400 – 750 (5 x 150) = 650 lbs).
- Determine the combined weight of luggage and cargo being loaded on the vehicle. That weight may not safely exceed the available cargo and luggage load capacity calculated in Step 4.

- If your vehicle will be towing a trailer, the load from your trailer will be transferred to your vehicle. Consult this manual to determine how this reduces the available cargo and luggage load capacity for your vehicle.

See *Trailer Towing on page 9-54* for important information on towing a trailer, towing safety rules and trailering tips.

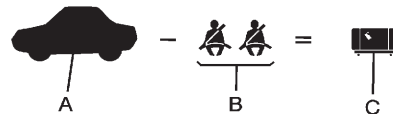

Example 1

- Vehicle Capacity Weight for Example 1 = 453 kg (1,000 lbs).
- Subtract Occupant Weight @ 68 kg (150 lbs) × 2 = 136 kg (300 lbs).
- Available Occupant and Cargo Weight = 317 kg (700 lbs).

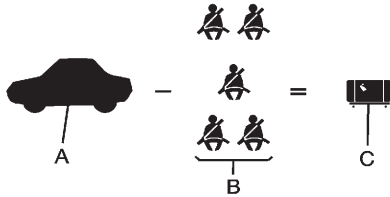

Example 2

- A. Vehicle Capacity Weight for Example 2 = 453 kg (1,000 lbs).
- B. Subtract Occupant Weight @ 68 kg (150 lbs) × 5 = 340 kg (750 lbs).
- C. Available Cargo Weight = 113 kg (250 lbs).

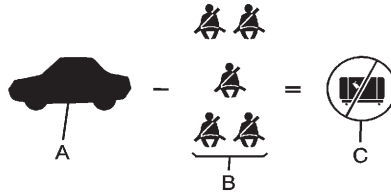

Example 3

- A. Vehicle Capacity Weight for Example 3 = 453 kg (1,000 lbs).
- B. Subtract Occupant Weight @ 91 kg (200 lbs) × 5 = 453 kg (1,000 lbs).
- C. Available Cargo Weight = 0 kg (0 lbs).

Refer to your vehicle's tire and loading information label for specific information about your vehicle's capacity weight and seating positions. The combined weight of the driver, passengers, and cargo should never exceed your vehicle's capacity weight.

Certification/Tire Label

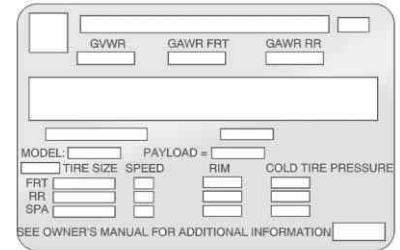

Label Example

A vehicle specific Certification/ Tire label is attached to the rear edge of the driver's door.

The label shows the gross weight capacity of your vehicle. This is called the Gross Vehicle Weight Rating (GVWR).

The GVWR includes the weight of the vehicle, all occupants, fuel, and cargo.

The Certification/Tire label also tells you the maximum weights for the front and rear axles, called the Gross Axle Weight Rating (GAWR). To find out the actual loads on your front and rear axles, you need to go to a weigh station and weigh your vehicle. Your dealer can help you with this. Be sure to spread out your load equally on both sides of the centerline.

Never exceed the GVWR for your vehicle or the GAWR for either the front or rear axle.

WARNING

Do not load the vehicle any heavier than the Gross Vehicle Weight Rating (GVWR), or either the maximum front or rear Gross Axle Weight Rating (GAWR). This can cause systems to break and change the way the vehicle handles. This could cause loss of control and a crash. Overloading can also shorten the life of the vehicle.

Notice : Overloading the vehicle may cause damage. Repairs would not be covered by the vehicle warranty. Do not overload the vehicle.

If you put things inside your vehicle — like suitcases, tools, packages, or anything else, they will go as fast as the vehicle goes. If you have to stop or turn quickly, or if there is a crash, they will keep going.

WARNING

Things you put inside the vehicle can strike and injure people in a sudden stop or turn, or in a crash.

- Put things in the cargo area of the vehicle. Try to spread the weight evenly.
- Never stack heavier things, like suitcases, inside the vehicle so that some of them are above the tops of the seats.

(Continued)

WARNING (Continued)

- Do not leave an unsecured child restraint in the vehicle.
- When you carry something inside the vehicle, secure it whenever you can.
- Do not leave a seat folded down unless you need to.

Starting and Operating

New Vehicle Break-In

Notice: The vehicle does not need an elaborate break-in. But it will perform better in the long run if you follow these guidelines:

- If you have all-wheel drive, keep your speed at 88 km/h (55 mph) or less for the first 805 km (500 mi).
- Do not drive at any one constant speed, fast or slow, for the first 805 km (500 mi). Do not make full-throttle starts. Avoid downshifting to brake or slow the vehicle.

- Avoid making hard stops for the first 322 km (200 mi) or so. During this time the new brake linings are not yet broken in. Hard stops with new linings can mean premature wear and earlier replacement. Follow this breaking-in guideline every time you get new brake linings.
- Do not tow a trailer during break-in. See *Driving Characteristics and Towing Tips on page 9-49* for the trailer towing capabilities of your vehicle and more information.

Following break-in, engine speed and load can be gradually increased.

Ignition Positions

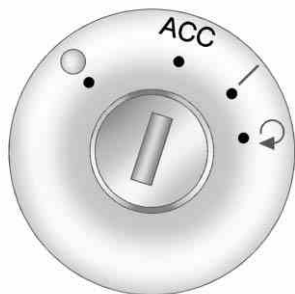

The ignition switch has four different positions.

In order to shift out of P (Park), the ignition must be in ON/RUN or ACC/ACCESSORY and the brake pedal must be applied.

Notice: Using a tool to force the key to turn in the ignition could cause damage to the switch or break the key. Use the correct key, make sure it is all the way in, and turn it only with your hand. If the key cannot be turned by hand, see your dealer.

○ (STOPPING THE ENGINE/ LOCK/OFF): When the vehicle is stopped, turn the ignition switch to LOCK/OFF to turn the engine off. Retained Accessory Power (RAP) will remain active. See *Retained Accessory Power (RAP)* on page 9-21.

This position locks the ignition and transmission. The key can be removed in LOCK/OFF.

Do not turn the engine off when the vehicle is moving. This will cause a loss of power assist in the brake and steering systems and disable the airbags.

If the vehicle must be shut off in an emergency:

1. Brake using a firm and steady pressure. Do not pump the brakes repeatedly. This may deplete power assist, requiring increased brake pedal force.
2. Shift the vehicle to N (Neutral). This can be done while the vehicle is moving. After shifting to N (Neutral), firmly apply the brakes and steer the vehicle to a safe location.
3. Come to a complete stop, shift to P (Park), and turn the ignition to LOCK/OFF. On vehicles with an automatic transmission, the shift lever must be in P (Park) to turn the ignition switch to the LOCK/OFF position.
4. Set the parking brake. See *Parking Brake* on page 9-31.

 **WARNING**

Turning off the vehicle while moving may cause loss of power assist in the brake and steering systems and disable the airbags. While driving, only shut the vehicle off in an emergency.

If the vehicle cannot be pulled over, and must be shut off while driving, turn the ignition to ACC/ACCESSORY.

The steering can bind with the wheels turned off center. If this happens, move the steering wheel from right to left while turning the key to ACC/ACCESSORY. If this does not work, then the vehicle needs service.

ACC (ACC/ACCESSORY): This is the position in which you can operate the electrical accessories or items plugged into the accessory power outlets. This position unlocks the ignition and steering wheel. Use this position if the vehicle must be pushed or towed.

I (ON/RUN): This position can be used to operate the electrical accessories and to display some instrument panel warning and indicator lights. This position can also be used for service and diagnostics, and to verify the proper operation of the malfunction indicator lamp as may be required for emission inspection purposes. The switch stays in this position when the engine is running. The transmission is also unlocked in this position. If you leave the key in the ACC/ACCESSORY or ON/RUN

position with the engine off, the battery could be drained. You may not be able to start the vehicle if the battery is allowed to drain for an extended period of time.

Q (START): This is the position that starts the engine. When the engine starts, release the key. The ignition switch will return to ON/RUN for driving.

Starting the Engine

Move the shift lever to P (Park) or N (Neutral). The engine will not start in any other position. To restart the engine when the vehicle is already moving, use N (Neutral) only.

Notice: Do not try to shift to P (Park) if the vehicle is moving. If you do, you could damage the transmission. Shift to P (Park) only when the vehicle is stopped.

Starting Procedure

1. With your foot off the accelerator pedal, turn the ignition to START. When the engine starts, let go of the key. The idle speed will slow down as the engine warms. Do not race the engine immediately after starting it. Operate the engine and transmission gently to allow the oil to warm up and lubricate all moving parts.

The vehicle has a Computer-Controlled Cranking System. This feature assists in starting the engine and protects components. If the ignition key is turned to the START position, and then released when the engine begins cranking, the engine will continue cranking for a few seconds or until the vehicle starts. If the engine does not start and the key is held in START, cranking will be stopped after 15 seconds to prevent cranking motor damage.

To prevent gear damage, this system also prevents cranking if the engine is already running. Engine cranking can be stopped by turning the ignition switch to the ACC/ACCESSORY or LOCK/OFF position.

Notice: Cranking the engine for long periods of time, by returning the key to the START position immediately after cranking has ended, can overheat and damage the cranking motor, and drain the battery. Wait at least 15 seconds between each try, to let the cranking motor cool down.

2. If the engine does not start after five to 10 seconds, especially in very cold weather (below 0°F or -18°C), it could be flooded with too much gasoline. Try pushing the accelerator pedal all the way to the floor and holding it there as you hold the key in START for up to a maximum of 15 seconds. Wait at least

15 seconds between each try, to allow the cranking motor to cool down. When the engine starts, let go of the key and accelerator. If the vehicle starts briefly but then stops again, repeat these steps. This clears the extra gasoline from the engine. Do not race the engine immediately after starting it. Operate the engine and transmission gently until the oil warms up and lubricates all moving parts.

Notice: The engine is designed to work with the electronics in the vehicle. If you add electrical parts or accessories, you could change the way the engine operates. Before adding electrical equipment, check with your dealer. If you do not, the engine might not perform properly. Any resulting damage would not be covered by the vehicle warranty.

Engine Heater

The engine coolant heater can provide easier starting and better fuel economy during engine warm-up in cold weather conditions at or below 0°F (-18°C). Vehicles with an engine coolant heater should be plugged in at least four hours before starting. Some models may have an internal thermostat in the cord which will prevent engine coolant heater operation at temperatures above 0°F (-18°C).

To Use the Engine Coolant Heater

1. Turn off the engine.
2. Open the hood and unwrap the electrical cord. The cord is located on the driver side of the engine compartment. It is routed around the windshield washer fluid reservoir.
3. Plug the cord into a normal, grounded 110-volt AC outlet.

WARNING

Plugging the cord into an ungrounded outlet could cause an electrical shock. Also, the wrong kind of extension cord could overheat and cause a fire. You could be seriously injured. Plug the cord into a properly grounded three-prong AC outlet. If the cord will not reach, use a heavy-duty three-prong extension cord rated for at least 15 amps.

4. Before starting the engine, be sure to unplug and store the cord as it was before to keep it away from moving engine parts. If you do not, it could be damaged.

The length of time the heater should remain plugged in depends on several factors. Ask a dealer in the area where you will be parking the vehicle for the best advice on this.

Retained Accessory Power (RAP)

These vehicle accessories can be used for up to 10 minutes after the ignition key is turned off:

- Audio System
- Power Windows
- Sunroof (if equipped)

Power to the windows and sunroof will work up to 10 minutes or until a door is opened.

The radio continues to work for 10 minutes or until the driver door is opened.

For an additional 10 minutes of operation, close all the doors and turn the key to ON/RUN and then back to LOCK/OFF.

All these features will work when the key is in the ON/RUN or ACC/ACCESSORY positions.

Shifting Into Park

 **WARNING**

It can be dangerous to get out of the vehicle if the shift lever is not fully in P (Park) with the parking brake firmly set. The vehicle can roll. If you have left the engine running, the vehicle can move suddenly. You or others could be injured. To be sure the vehicle will not move, even when you are on fairly level ground, use the steps that follow. If you are pulling a trailer, see *Driving Characteristics and Towing Tips on page 9-49*.

1. Hold the brake pedal down and set the parking brake. See *Parking Brake on page 9-31* for more information.

2. Move the shift lever into P (Park) by holding in the button on the shift lever and pushing the shift lever all the way toward the front of the vehicle.
3. Turn the ignition key to LOCK/OFF.
4. Remove the key and take it with you. If you can leave the vehicle with the ignition key in your hand, the vehicle is in P (Park).

Leaving the Vehicle with the Engine Running

 **WARNING**

It can be dangerous to leave the vehicle with the engine running. The vehicle could move suddenly if the shift lever is not fully in P (Park) with the parking brake firmly set. And, if you leave the vehicle with the engine running, it could overheat and even catch fire. You or others could be injured. Do not leave the vehicle with the engine running.

If you have to leave the vehicle with the engine running, be sure the vehicle is in P (Park) and the parking brake is firmly set before you leave it. After you have moved the shift lever into P (Park), hold the regular brake pedal down. Then, see if you can move the shift lever away from P (Park) without first pushing the button.

If you can, it means that the shift lever was not fully locked in P (Park).

Torque Lock

Torque lock is when the weight of the vehicle puts too much force on the parking pawl in the transmission. This happens when parking on a hill and shifting the transmission into P (Park) is not done properly and then it is difficult to shift out of P (Park). To prevent torque lock, set the parking brake and then shift into P (Park). To find out how, see “Shifting Into Park” listed previously.

If torque lock does occur, your vehicle may need to be pushed uphill by another vehicle to relieve the parking pawl pressure, so you can shift out of P (Park).

Shifting out of Park

The vehicle is equipped with an electronic shift lock release system. The shift lock release is designed to:

- Prevent ignition key removal unless the shift lever is in P (Park) with the shift lever button fully released, and
- Prevent movement of the shift lever out of P (Park), unless the ignition is in ON/RUN or ACC/ACCESSORY and the regular brake pedal is applied.

The shift lock release is always functional except in the case of an uncharged or low voltage (less than 9-volt) battery.

9-24 Driving and Operating

If the vehicle has an uncharged battery or a battery with low voltage, try charging or jump starting the battery. See *Jump Starting on page 10-79* for more information.

To shift out of P (Park):

1. Apply the brake pedal.
2. Press the shift lever button.
3. Move the shift lever to the desired position.

If you still are unable to shift out of P (Park):

1. Fully release the shift lever button.
2. While holding down the brake pedal, press the shift lever button again.
3. Move the shift lever to the desired position.

If you still cannot move the shift lever from P (Park), see your dealer.

Parking over Things That Burn

WARNING

Things that can burn could touch hot exhaust parts under the vehicle and ignite. Do not park over papers, leaves, dry grass, or other things that can burn.

Engine Exhaust

WARNING

Engine exhaust contains carbon monoxide (CO) which cannot be seen or smelled. Exposure to CO can cause unconsciousness and even death.

Exhaust may enter the vehicle if:

- The vehicle idles in areas with poor ventilation (parking garages, tunnels, deep snow that may block underbody airflow or tail pipes).
- The exhaust smells or sounds strange or different.
- The exhaust system leaks due to corrosion or damage.
- The vehicle exhaust system has been modified, damaged or improperly repaired.

(Continued)

WARNING (Continued)

- There are holes or openings in the vehicle body from damage or aftermarket modifications that are not completely sealed.

If unusual fumes are detected or if it is suspected that exhaust is coming into the vehicle:

- Drive it only with the windows completely down.
- Have the vehicle repaired immediately.

Never park the vehicle with the engine running in an enclosed area such as a garage or a building that has no fresh air ventilation.

Running the Vehicle While Parked

It is better not to park with the engine running. But if you ever have to, here are some things to know.

 WARNING

Idling a vehicle in an enclosed area with poor ventilation is dangerous. Engine exhaust may enter the vehicle. Engine exhaust contains Carbon Monoxide (CO) which cannot be seen or smelled. It can cause unconsciousness and even death. Never run the engine in an enclosed area that has no fresh air ventilation. For more information, see *Engine Exhaust* on page 9-24.

 WARNING

It can be dangerous to get out of the vehicle if the automatic transmission shift lever is not fully in P (Park) with the parking brake firmly set. The vehicle can roll. Do not leave the vehicle when the engine is running unless you have to. If you have left the engine running, the vehicle can move suddenly. You or others could be injured. To be sure the vehicle will not move, even when you are on fairly level ground, always set the parking brake and move the shift lever to P (Park).

Follow the proper steps to be sure the vehicle will not move. See *Shifting Into Park* on page 9-22.

If parking on a hill and pulling a trailer, see *Driving Characteristics and Towing Tips* on page 9-49.

Automatic Transmission

The automatic transmission has a shift lever located on the console between the seats.

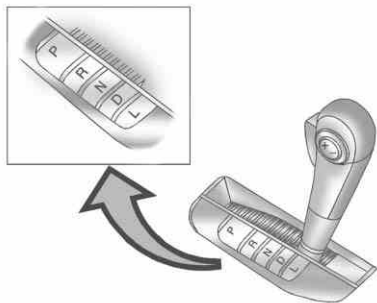

P (Park): This position locks the front wheels. It is the best position to use when starting the engine because the vehicle cannot move easily.

WARNING

It is dangerous to get out of the vehicle if the shift lever is not fully in P (Park) with the parking brake firmly set. The vehicle can roll.

Do not leave the vehicle when the engine is running unless you have to. If you have left the engine running, the vehicle can move suddenly. You or others could be injured. To be sure the vehicle will not move, even when you are on fairly level ground, always set the parking brake and move the shift lever to P (Park). See *Shifting Into Park on page 9-22*. If you are pulling a trailer, see *Driving Characteristics and Towing Tips on page 9-49*.

Make sure the shift lever is fully in P (Park) before starting the engine. The vehicle has an automatic transmission shift lock control system. You must fully apply the

regular brake first and then press the shift lever button before shifting from P (Park) when the ignition key is in ON/RUN. If you cannot shift out of P (Park), ease pressure on the shift lever, then push the shift lever all the way into P (Park) as you maintain brake application. Then press the shift lever button and move the shift lever into another gear. See *Shifting out of Park on page 9-23*.

R (Reverse): Use this gear to back up.

Notice: Shifting to R (Reverse) while the vehicle is moving forward could damage the transmission. The repairs would not be covered by the vehicle warranty. Shift to R (Reverse) only after the vehicle is stopped.

To rock the vehicle back and forth to get out of snow, ice, or sand without damaging the transmission, see *If the Vehicle Is Stuck on page 9-11*.

N (Neutral): In this position, the engine does not connect with the wheels. To restart the engine when the vehicle is already moving, use N (Neutral) only. Also, use N (Neutral) when the vehicle is being towed.

 **WARNING**

Shifting into a drive gear while the engine is running at high speed is dangerous. Unless your foot is firmly on the brake pedal, the vehicle could move very rapidly. You could lose control and hit people or objects. Do not shift into a drive gear while the engine is running at high speed.

Notice: Shifting out of P (Park) or N (Neutral) with the engine running at high speed may damage the transmission. The repairs would not be covered by the vehicle warranty. Be sure the engine is not running at high speed when shifting the vehicle.

D (Drive): This position is for normal driving. It provides the best fuel economy. If you need more power for passing, and you are:

- Going less than 56 km/h (35 mph), push the accelerator pedal about halfway down.
- Going about 56 km/h (35 mph) or more, push the accelerator all the way down.

Notice: If the vehicle seems to accelerate slowly or not shift gears when you go faster, and you continue to drive the vehicle

that way, you could damage the transmission. Have the vehicle serviced right away. You can drive in L (Low) when you are driving less than 56 km/h (35 mph) and D (Drive) for higher speeds until then.

If the vehicle is stopped on a hill, with your foot off the brake pedal, the vehicle may roll. This is normal and is due to the torque converter designed to improve fuel economy and performance. Use the brake to hold the vehicle on a hill. Do not use the accelerator pedal.

L (Low): This position gives you access to gear ranges. This provides more engine braking but lower fuel economy than D (Drive). You can use it on very steep hills, or in deep snow or mud.

Manual Mode

Electronic Range Select (ERS) Mode

ERS mode allows you to choose the top-gear limit of the transmission and the vehicle's speed while driving downhill or towing a trailer. The vehicle has an electronic shift position indicator within the instrument panel cluster. When using the ERS mode a number will display next to the L, indicating the current gear that has been selected.

To use this feature:

1. Move the shift lever to L (Low).
2. Press the plus/minus button located on the shift lever, to increase or decrease the gear range available.

When you shift from D (Drive) to L (Low), the transmission will shift to a pre-determined lower gear range. The highest gear available for this pre-determined range is displayed next to the L in the DIC. See *Driver Information Center (DIC) on page 5-27* for more information. The number displayed in the DIC is the highest gear that the transmission will be allowed to operate in. This means that all gears below that number are available. For example, when 4 (Fourth) is shown next to the L, 1 (First) through 4 (Fourth) gears are automatically shifted by the vehicle. The transmission will not shift into 5 (Fifth) until the + (Plus) button is used or you shift back into D (Drive).

While in L (Low), the transmission will prevent shifting to a lower gear range if the engine speed is too high. You have a brief period of time to slow the vehicle. If vehicle speed is not reduced within the time allowed, the lower gear range shift will not be completed. You must further slow the vehicle, then press the - (Minus) button to the desired lower gear range.

Automatic Engine Grade Braking is not available when the ERS is active. It is available in D (Drive) for both normal and Tow/Haul mode. While using the ERS, cruise control and the Tow/Haul mode can be used. See Tow/Haul Mode following.

Tow/Haul Mode

 (Tow/Haul): The vehicle may have a Tow/Haul mode.

The button is located on the instrument panel under the climate controls.

Push the button to activate the system. Push it again to deactivate the system. You can use this feature to assist when towing or hauling a heavy load.

When Tow/Haul is activated the Tow/Haul symbol will come on the instrument panel cluster. See "Tow/Haul Mode" under *Driving Characteristics and Towing Tips* on page 9-49 for more information.

Automatic Engine Grade Braking

Automatic Engine Grade Braking assists when driving on a downhill grade. It maintains vehicle speed by automatically implementing a shift schedule that uses the engine and the transmission to slow the vehicle. The system will automatically command downshifts to reduce vehicle speed, until the brake pedal is no longer being pressed.

While in the Electronic Range Select (ERS) mode, grade braking is deactivated, allowing the driver to select a range and limiting the highest gear available. Grade braking is available for normal driving and in Tow/Haul mode.

See *Automatic Transmission* on page 9-26.

Drive Systems

All-Wheel Drive

Vehicles with this feature always send engine power to all four wheels. It is fully automatic, and adjusts itself as needed for road conditions.

When using a compact spare tire on an AWD vehicle, the system automatically detects the compact spare and disables AWD. To restore AWD operation and prevent excessive wear on the system, replace the compact spare with a full-size tire as soon as possible. See *Compact Spare Tire* on page 10-78 for more information.

Brakes

Antilock Brake System (ABS)

This vehicle has the Antilock Brake System (ABS), an advanced electronic braking system that helps prevent a braking skid.

When the engine is started and the vehicle begins to drive away, ABS checks itself. A momentary motor or clicking noise might be heard while this test is going on, and it might even be noticed that the brake pedal moves a little. This is normal.



If there is a problem with ABS, this warning light stays on. See *Antilock Brake System (ABS) Warning Light* on page 5-23.

If driving safely on a wet road and it becomes necessary to slam on the brakes and continue braking to avoid a sudden obstacle, a computer senses that the wheels are slowing down. If one of the wheels is about to stop rolling, the computer will separately work the brakes at each wheel.

ABS can change the brake pressure to each wheel, as required, faster than any driver could. This can help the driver steer around the obstacle while braking hard.

As the brakes are applied, the computer keeps receiving updates on wheel speed and controls braking pressure accordingly.

Remember: ABS does not change the time needed to get a foot up to the brake pedal or always decrease

stopping distance. If you get too close to the vehicle in front of you, there will not be enough time to apply the brakes if that vehicle suddenly slows or stops. Always leave enough room up ahead to stop, even with ABS.

Using ABS

Do not pump the brakes. Just hold the brake pedal down firmly and let ABS work. You might hear the ABS pump or motor operating and feel the brake pedal pulsate, but this is normal.

Braking in Emergencies

ABS allows the driver to steer and brake at the same time. In many emergencies, steering can help more than even the very best braking.

Parking Brake

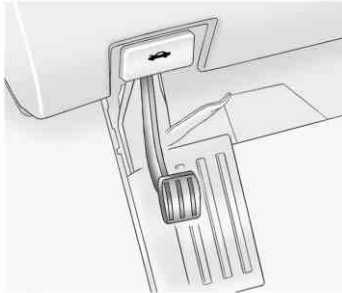

To set the parking brake, hold the regular brake pedal down, then push the parking brake pedal down.

If the ignition is on, the brake system warning light will come on. See *Brake System Warning Light* on page 5-22.

Notice: Driving with the parking brake on can overheat the brake system and cause premature wear or damage to brake system parts. Make sure that the parking brake is fully released and the brake warning light is off before driving.

To release the parking brake, hold the regular brake pedal down, then push down momentarily on the parking brake pedal until you feel the pedal release. Slowly pull your foot up off the park brake pedal.

If the parking brake is not released when you begin to drive, the brake system warning light will be on and a chime will sound warning you that the parking brake is still on.

If you are towing a trailer and are parking on a hill, see *Driving Characteristics and Towing Tips* on page 9-49.

Brake Assist

This vehicle has a brake assist feature designed to assist the driver in stopping or decreasing vehicle speed in emergency driving conditions. This feature uses the stability system hydraulic brake control module to supplement the power brake system under conditions where the driver has quickly and forcefully applied the brake pedal in an attempt to quickly stop or slow down the vehicle. The stability system hydraulic brake control module increases brake pressure at each corner of the vehicle until the ABS activates. Minor brake pedal pulsation or pedal movement during this time is normal and the driver should continue to apply the brake pedal as the driving situation dictates. The brake assist feature will automatically disengage when the brake pedal is released or brake pedal pressure is quickly decreased.

Hill Start Assist (HSA)

This vehicle has a Hill Start Assist (HSA) feature, which may be useful when the vehicle is stopped on a grade. This feature is designed to prevent the vehicle from rolling, either forward or rearward, during vehicle drive off. After the driver completely stops and holds the vehicle in a complete standstill on a grade, HSA will be automatically activated. During the transition period between when the driver releases the brake pedal and starts to accelerate to drive off on a grade, HSA holds the braking pressure to ensure that there is no rolling. The brakes will automatically release when the accelerator pedal is applied within the two-second window. It will not activate if the vehicle is in a drive gear and facing downhill or if the vehicle is facing uphill and in R (Reverse).

Ride Control Systems

StabiliTrak® System

The vehicle has the StabiliTrak system which combines antilock brake, traction, and stability control systems and helps the driver maintain directional control of the vehicle in most driving conditions.

When you first start the vehicle and begin to drive away, the system performs several diagnostic checks to ensure there are no problems. The system may be heard or felt while it is working. This is normal and does not mean there is a problem with the vehicle. The system should initialize before the vehicle reaches 32 km/h (20 mph). In some cases, it may take approximately 3.2 km (2 mi) of driving before the system initializes.

If the system fails to turn on or activate, one of the following messages will be displayed on the Driver Information Center (DIC): SERVICE TRACTION CONTROL, SERVICE STABILITRAK, the StabiliTrak light will come on and stay and four chimes are heard. If these conditions are observed, turn the vehicle off, wait 15 seconds, and then turn it back on again to reset the system. If any of these messages still appear on the Driver Information Center (DIC), the vehicle should be taken in for service. For more information on the DIC messages, see *Ride Control System Messages on page 5-37*.



The StabiliTrak light will flash on the instrument panel cluster when the system is both on and activated.

The system may be heard or felt while it is working; this is normal.



The traction control button is located on the instrument panel.

The traction control part of StabiliTrak can be turned off by pressing and releasing the traction control button.

Traction control can be turned on by pressing and releasing the traction control button and the appropriate TRACTION CONTROL ON message will be displayed, if not automatically shut off for any other reason.

When the traction control system is turned off, the appropriate TRACTION CONTROL OFF message will be displayed on the DIC. The vehicle will still have brake-traction control when traction control is off, but will not be able to use the engine speed management system. See “Traction Control Operation” following for more information.

When the traction control system has been turned off, system noises may be heard and felt as a result of the brake-traction control working.

It is recommended to leave the system on for normal driving conditions, but it may be necessary to turn the system off if the vehicle is stuck in sand, mud, ice, or snow, and you want to “rock” the vehicle to attempt to free it. It may also be necessary to turn off the system when driving in extreme off-road conditions where high wheel spin is required. See *If the Vehicle Is Stuck* on page 9-11.

Traction Control Operation

The traction control system is part of the StabiliTrak system. Traction control limits wheel spin by reducing engine power to the wheels (engine speed management) and by applying the brakes as necessary.

The traction control system is enabled automatically when the vehicle is started. It will activate and the StabiliTrak light will flash if it senses that any of the wheels are spinning or beginning to lose traction while driving. If traction control is turned off, only the brake-traction control portion of traction control will work.

The engine speed management will be disabled. In this mode, engine power is not reduced automatically and the driven wheels can spin more freely. This can cause the brake-traction control to activate constantly.

Notice: If the wheel(s) of one axle is allowed to spin excessively while the StabiliTrak[®], ABS, brake warning lights, and any relevant DIC messages are displayed, the transfer case could be damaged. The repairs would not be covered by the vehicle warranty. Reduce engine power and do not spin the wheel(s) excessively while these lights and messages are displayed.

The traction control system may activate on dry or rough roads or under conditions such as heavy acceleration while turning or abrupt upshifts/downshifts of the transmission. When this happens, a reduction in acceleration may be noticed, or a noise or vibration may be heard. This is normal.

If cruise control is being used when the system activates, the StabiliTrak light will flash and cruise control will automatically disengage. Cruise control may be reengaged when road conditions allow. See *Cruise Control* on page 9-34.

StabiliTrak may also turn off automatically if it determines that a problem exists with the system. If the problem does not clear itself after restarting the vehicle, see your dealer for service.

Cruise Control

With cruise control, a speed of about 40 km/h (25 mph) or more can be maintained without keeping your foot on the accelerator. Cruise control does not work at speeds below about 40 km/h (25 mph).

When the brakes are applied, the cruise control is disengaged.

WARNING

Cruise control can be dangerous where you cannot drive safely at a steady speed. So, do not use the cruise control on winding roads or in heavy traffic.

Cruise control can be dangerous on slippery roads. On such roads, fast changes in tire traction can cause excessive wheel slip, and you could lose control. Do not use cruise control on slippery roads.

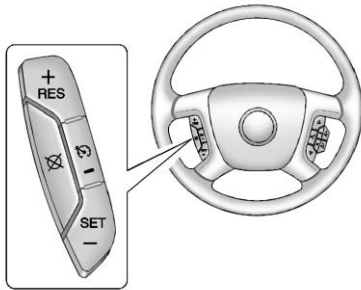

The cruise control buttons are located on left side of the steering wheel.

⊗ (On/Off): Press to turn cruise control on and off. The indicator comes on when cruise control is on.

+ RES (Resume/Accelerate): Press briefly to make the vehicle resume to a previously set speed, or press and hold to accelerate.

SET- : Press to set the speed and activate cruise control or to make the vehicle decelerate.

⊗ (Cancel): Press to disengage cruise control without erasing the set speed from memory.

Setting Cruise Control

If the cruise button is on when not in use, it could get bumped and go into cruise when not desired. Keep the cruise control switch off when cruise is not being used.

The cruise control light on the instrument panel cluster comes on after the cruise control has been set to the desired speed.

1. Press the **⊗** button to turn the cruise control system on.
2. Get up to the speed desired.

3. Press and release the SET- button located on the steering wheel.
4. Take your foot off the accelerator.

Resuming a Set Speed

If the cruise control is set at a desired speed and then the brakes are applied, the cruise control is disengaged without erasing the set speed from memory.

Once the vehicle speed is 40 km/h (25 mph) or greater, press the +RES button on the steering wheel. The vehicle returns to the previously set speed and stays there.

Increasing Speed While Using Cruise Control

If the cruise control system is already activated:

- Press and hold the +RES button on the steering wheel until the desired speed is reached, then release it.
- To increase vehicle speed in small increments, press the +RES button briefly. Each time this is done, the vehicle goes about 1.6 km/h (1 mph) faster.

Reducing Speed While Using Cruise Control

If the cruise control system is already activated:

- Press and hold the SET- button on the steering wheel until the lower speed desired is reached, then release it.

- To slow down in small amounts, press the SET- button briefly. Each time this is done, the vehicle goes about 1.6 km/h (1 mph) slower.

Passing Another Vehicle While Using Cruise Control



Use the accelerator pedal to increase vehicle speed. When you take your foot off the pedal, the vehicle will slow down to the previously set cruise speed.

Using Cruise Control on Hills

How well the cruise control will work on hills depends upon the vehicle speed, load, and the steepness of the hills. When going up steep hills, you might have to step on the accelerator pedal to maintain the vehicle speed. When going downhill, you might have to brake or shift to a lower gear to keep the vehicle speed down. When the brakes are applied the cruise control is disengaged.

Ending Cruise Control

There are three ways to end cruise control:

- Step lightly on the brake pedal.
- Press the  button.
- To turn off the cruise control, press  on the steering wheel.

Erasing Speed Memory

The cruise control set speed is erased from memory by pressing  or if the ignition is turned off.

Object Detection Systems

Ultrasonic Parking Assist

If available, the Ultrasonic Rear Parking Assist (URPA) system assists the driver with parking and avoiding objects while in R (Reverse). URPA operates at speeds less than 8 km/h (5 mph). The sensors on the rear bumper are used to detect objects up to 2.5 m (8 ft) behind the vehicle, and at least 25 cm (10 in) off the ground.

WARNING

The URPA system does not detect pedestrians, bicyclists, animals, or any other objects located below the bumper or that are too close or too far from the vehicle. To prevent injury, death, or vehicle damage, even with URPA, always check behind the vehicle and check all mirrors before backing.

How the System Works

URPA comes on automatically when the shift lever is moved into R (Reverse). A single tone sounds to indicate the system is working.

URPA operates only at speeds less than 8 km/h (5 mph).

An obstacle is indicated by audible beeps. The interval between the beeps becomes shorter as the vehicle gets closer to the obstacle. When the distance is less than 30 cm (12 in) the beeping is a continuous tone for five seconds.

To be detected, objects must be at least 25 cm (10 in) off the ground and below liftgate level. Objects must also be within 2.5 m (8 ft) from the rear bumper. This distance may be less during warmer or humid weather.

Turning the System On and Off

The system can be disabled through the Driver Information Center (DIC). See "Park Assist" under *Vehicle Personalization on page 5-41* for more information.

URPA defaults to the on setting each time the vehicle is started.

When the System Does Not Seem to Work Properly

The following messages may be displayed on the DIC:

SERVICE PARK ASSIST: If this message occurs, take the vehicle to your dealer to repair the system.

PARK ASST BLOCKED SEE OWNERS MANUAL: This message can occur under the following conditions:

- The ultrasonic sensors are not clean. Keep the vehicle's rear bumper free of mud, dirt, snow, ice, and slush. For cleaning instructions, see *Exterior Care on page 10-86*.

- The park assist sensors are covered by frost or ice. Frost or ice can form around and behind the sensors and may not always be seen; this can occur after washing the vehicle in cold weather. The message may not clear until the frost or ice has melted.
- A trailer was attached to the vehicle, or an object was hanging out of the liftgate during the last drive cycle. Once the object is removed, URPA will return to normal operation.
- A tow bar is attached to the vehicle.
- The bumper is damaged. Take the vehicle to your dealer to repair the system.
- Other conditions, such as vibrations from a jackhammer or the compression of air brakes on a very large truck, are affecting system performance.

Rear Vision Camera (RVC)

The vehicle may have a rear vision camera system. Read this entire section before using it.

WARNING

The RVC system does not display pedestrians, bicyclists, animals, or any other object located outside the camera's field of view, below the bumper, or under the vehicle.

Do not back the vehicle using only the RVC screen or by using the screen during longer, higher speed backing maneuvers, or where there could be cross-traffic. Perceived distances may be different from actual distances.

(Continued)

WARNING (Continued)

Failure to use proper care before backing may result in injury, death, or vehicle damage. Always check before backing by checking behind and around the vehicle.

Vehicles without Navigation System

The rear vision camera system is designed to help the driver when backing up by displaying a view of the area behind the vehicle. When the key is in the ON/RUN position and the driver shifts the vehicle into R (Reverse), the video image automatically appears on the inside rear view mirror. Once the driver shifts out of R (Reverse), the video image automatically disappears from the inside rear view mirror.

Turning the Rear Vision Camera System Off or On

To turn off the rear vision camera system, press and hold , located on the inside rearview mirror, until the left indicator light turns off. The rear vision camera display is now disabled.

To turn the rear vision camera system on again, press and hold  until the left indicator light illuminates. The rear vision camera system display is now enabled and the display will appear in the mirror normally.

Vehicles with Navigation System

The rear vision camera system is designed to help the driver when backing up by displaying a view of the area behind the vehicle. When the driver shifts the vehicle into R (Reverse), the video image automatically appears on the navigation screen. Once the driver shifts out of R (Reverse), the navigation screen will go back to the last screen that had been displayed, after a delay.

Turning the Rear Vision Camera System On or Off

To turn the rear vision camera system on or off:

1. Shift into P (Park).
2. Press the MENU button to enter the configure menu options, then press the MENU hard key to select Display or touch the Display screen button.

9-40 Driving and Operating

3. Select the Rear Camera Options screen button. The Rear Camera Options screen displays.

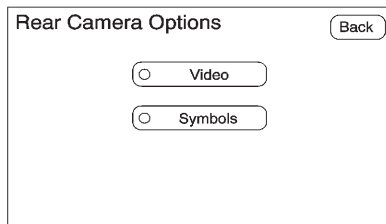

4. Select the Video screen button. When the Video screen button is highlighted the RVC system is on.

The delay received after shifting out of R (Reverse) is approximately 10 seconds. The delay can be canceled by performing one of the following:

- Pressing a hard key on the navigation system.
- Shifting into P (Park).
- Reach a vehicle speed of 8 km/h (5 mph).

There is a message on the rear vision camera screen that states “Check Surroundings for Safety.”

Adjusting the Brightness and Contrast of the Screen

To adjust the brightness and contrast of the screen, press the MENU button while the rear vision camera image is on the display. Any adjustments made will only affect the rear vision camera screen.

☀️ **(Brightness):** Touch the + (plus) or – (minus) screen buttons to increase or decrease the brightness of the screen.

🗨️ **(Contrast):** Touch the + (plus) or – (minus) screen buttons to increase or decrease the contrast of the screen.

Symbols

The navigation system may have a feature that lets the driver view symbols on the navigation screen while using the rear vision camera. The Ultrasonic Rear Park Assist (URPA) system must not be disabled to use the caution symbols. If URPA has been disabled and the symbols have been turned on, the Rear Parking Assist Symbols Unavailable error message may display. See *Ultrasonic Parking Assist* on page 9-37.

The symbols appear when an object has been detected by the URPA system. The symbol may cover the object when viewing the navigation screen.

To turn the symbols on or off:

1. Make sure that URPA has not been disabled.
2. Shift into P (Park).

3. Press the MENU hard key to enter the configure menu options, then press the MENU hard key repeatedly until Display is selected or touch the Display screen button.
4. Select the Rear Camera Options screen button. The Rear Camera Options screen will display.
5. Touch the Symbols screen button. The screen button will be highlighted when on.

Rear Vision Camera Error Messages

Service Rear Vision Camera

System: This message can display when the system is not receiving information it requires from other vehicle systems.

If any other problem occurs or if a problem persists, see your dealer.

Rear Vision Camera Location

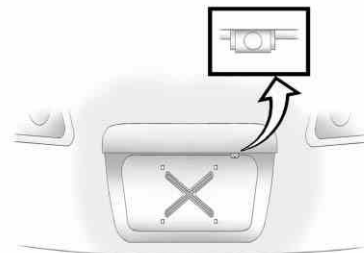

The camera is located above the license plate.

9-42 Driving and Operating

The area displayed by the camera is limited and does not display objects that are close to either corner or under the bumper.

The area displayed can vary depending on vehicle orientation or road conditions. The distance of the image that appears on the screen differs from the actual distance.

The following illustration shows the field of view that the camera provides.

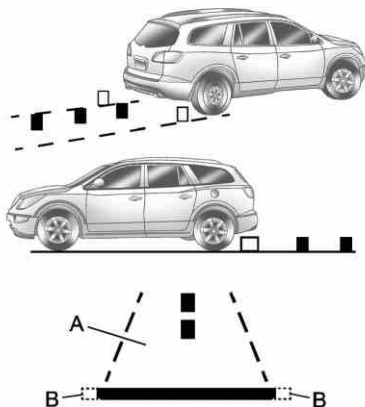

- A. View displayed by the camera.
B. Corner of the rear bumper.

When the System Does Not Seem To Work Properly

The rear vision camera system might not work properly or display a clear image if:

- The RVC is turned off. See "Turning the Rear Camera System On or Off" earlier in this section.
- It is dark.
- The sun or the beam of headlights is shining directly into the camera lens.
- Ice, snow, mud, or anything else builds up on the camera lens. Clean the lens, rinse it with water, and wipe it with a soft cloth.

- The back of the vehicle is in an accident. The position and mounting angle of the camera can change or the camera can be affected. Be sure to have the camera and its position and mounting angle checked at your dealer.
- There are extreme temperature changes.

The rear vision camera system display in the rearview mirror may turn off or not appear as expected due to one of the following conditions. If this occurs the left indicator light on the mirror will flash.

- A slow flash may indicate a loss of video signal, or no video signal present during the reverse cycle.

- A fast flash may indicate that the display has been on for the maximum allowable time during a reverse cycle, or the display has reached an Over Temperature limit.

The fast flash conditions are used to protect the video device from high temperature conditions. Once conditions return to normal the device will reset and the green indicator will stop flashing.

During any of these fault conditions, the display will be blank and the indicator will continue to flash as long as the vehicle is in R (Reverse) or until the conditions return to normal.

Pressing and holding  when the left indicator light is flashing will turn off the video display along with the left indicator light.

Fuel

Use of the recommended fuel is an important part of the proper maintenance of this vehicle. To help keep the engine clean and maintain optimum vehicle performance, we recommend the use of gasoline advertised as TOP TIER Detergent Gasoline.

Look for the TOP TIER label on the fuel pump to ensure gasoline meets enhanced detergency standards developed by auto companies. A list of marketers providing TOP TIER Detergent Gasoline can be found at www.toptiergas.com.



Recommended Fuel

Use regular unleaded gasoline with a posted octane rating of 87 or higher. If the octane rating is less than 87, an audible knocking noise, commonly referred to as spark knock, might be heard when driving. If this occurs, use a gasoline rated at 87 octane or higher as soon as possible. If heavy knocking is heard when using gasoline rated at 87 octane or higher, the engine needs service.

Gasoline Specifications (U.S. and Canada Only)

At a minimum, gasoline should meet ASTM specification D 4814 in the United States or CAN/CGSB-3.5 or 3.511 in Canada. Some gasolines contain an octane-enhancing additive called methylcyclopentadienyl manganese tricarbonyl (MMT). We recommend against the use of gasolines containing MMT. See *Fuel Additives* on page 9-45 for additional information.

California Fuel Requirements

If the vehicle is certified to meet California Emissions Standards, it is designed to operate on fuels that meet California specifications. See the underhood emission control label. If this fuel is not available in states adopting California Emissions Standards, the vehicle will operate satisfactorily on fuels meeting federal specifications, but emission control system performance might be affected. The malfunction indicator lamp could turn on and the vehicle might fail a smog-check test. See *Malfunction Indicator Lamp on page 5-20*. If this occurs, return to your authorized dealer for diagnosis. If it is determined that the condition is caused by the type of fuel used, repairs might not be covered by the vehicle warranty.

Fuels in Foreign Countries

Never use leaded gasoline or any other fuel not recommended in the previous text on fuel. Costly repairs caused by use of improper fuel would not be covered by the vehicle warranty.

To check the fuel availability, ask an auto club, or contact a major oil company that does business in the country where you will be driving.

Fuel Additives

To provide cleaner air, all gasolines in the United States are now required to contain additives that help prevent engine and fuel system deposits from forming, allowing the emission control system to work properly. In most cases, nothing should have to be added to the fuel. However, some gasolines contain only the minimum amount of additive required to meet U.S.

Environmental Protection Agency regulations. To help keep fuel injectors and intake valves clean and avoid problems due to dirty injectors or valves, look for gasoline that is advertised as TOP TIER Detergent Gasoline. Look for the TOP TIER label on the fuel pump to ensure gasoline meets enhanced detergency standards developed by the auto companies. A list of marketers providing TOP TIER Detergent Gasoline can be found at www.toptiergas.com.

For customers who do not use TOP TIER Detergent Gasoline regularly, one bottle of GM Fuel System Treatment PLUS, added to the fuel tank at every engine oil change, can help clean deposits from fuel injectors and intake valves. GM Fuel System Treatment PLUS is the only gasoline additive recommended by General Motors. It is available at your dealer.

Gasolines containing oxygenates, such as ethers and ethanol, and reformulated gasolines might be available in your area. We recommend that you use these gasolines, if they comply with the specifications described earlier. However, E85 (85% ethanol) and other fuels containing more than 15% ethanol must not be used in vehicles that were not designed for those fuels.

Notice: This vehicle was not designed for fuel that contains methanol. Do not use fuel containing methanol. It can corrode metal parts in the fuel system and also damage plastic and rubber parts. That damage would not be covered under the vehicle warranty.

Some gasolines that are not reformulated for low emissions can contain an octane-enhancing additive called methylcyclopentadienyl manganese tricarbonyl (MMT); ask the attendant where you buy gasoline whether the fuel contains MMT. We recommend against the use of such gasolines. Fuels containing MMT can reduce spark plug life and affect emission control system performance. The malfunction indicator lamp might turn on. If this occurs, return to your dealer for service.

Filling the Tank

WARNING

Fuel vapor burns violently and a fuel fire can cause bad injuries. To help avoid injuries to you and others, read and follow all the instructions on the fuel pump island. Turn off the engine when refueling. Do not smoke near fuel or when refueling the vehicle. Do not use cellular phones. Keep sparks, flames, and smoking materials away from fuel. Do not leave the fuel pump unattended when refueling the vehicle. This is against the law in some places. Do not re-enter the vehicle while pumping fuel. Keep children away from the fuel pump; never let children pump fuel.

The tethered fuel cap is located behind a hinged fuel door on the driver side of the vehicle.

To open the fuel door, push the rearward center edge in and release and it will open.

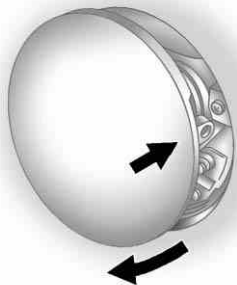

To remove the fuel cap, turn it slowly counterclockwise. The fuel cap has a spring in it; if the cap is released too soon, it will spring back to the right.

While refueling, hang the tethered fuel cap from the hook on the fuel door.

⚠ WARNING

Fuel can spray out on you if you open the fuel cap too quickly. If you spill fuel and then something ignites it, you could be badly burned. This spray can happen if the tank is nearly full, and is more likely in hot weather. Open the fuel cap slowly and wait for any hiss noise to stop. Then unscrew the cap all the way.

Be careful not to spill fuel. Do not top off or overfill the tank and wait a few seconds after you have finished pumping before removing the nozzle. Clean fuel from painted surfaces as soon as possible. See *Exterior Care* on page 10-86.

When replacing the fuel cap, turn it clockwise until it clicks. Make sure the cap is fully installed. The diagnostic system can

determine if the fuel cap has been left off or improperly installed. This would allow fuel to evaporate into the atmosphere. See *Malfunction Indicator Lamp* on page 5-20.

⚠ WARNING

If a fire starts while you are refueling, do not remove the nozzle. Shut off the flow of fuel by shutting off the pump or by notifying the station attendant. Leave the area immediately.

Notice: If a new fuel cap is needed, be sure to get the right type of cap from your dealer. The wrong type of fuel cap might not fit properly, might cause the malfunction indicator lamp to light, and could damage the fuel tank and emissions system. See *Malfunction Indicator Lamp* on page 5-20.

Filling a Portable Fuel Container

 **WARNING**

Never fill a portable fuel container while it is in the vehicle. Static electricity discharge from the container can ignite the fuel vapor. You can be badly burned and the vehicle damaged if this occurs. To help avoid injury to you and others:

- Dispense fuel only into approved containers.
- Do not fill a container while it is inside a vehicle, in a vehicle's trunk, pickup bed, or on any surface other than the ground.

(Continued)

WARNING (Continued)

- Bring the fill nozzle in contact with the inside of the fill opening before operating the nozzle. Contact should be maintained until the filling is complete.
- Do not smoke while pumping fuel.
- Do not use a cellular phone while pumping fuel.

Towing

General Towing Information

Only use towing equipment that has been designed for the vehicle. Contact your dealer or trailering dealer for assistance with preparing the vehicle for towing a trailer.

See the following trailer towing information in this section:

- For information on driving while towing a trailer, see "Driving Characteristics and Towing Tips."
- For maximum vehicle and trailer weights, see "Trailer Towing."
- For information on equipment to tow a trailer, see "Towing Equipment."

For information on towing a disabled vehicle, see *Towing the Vehicle* on page 10-83. For information on towing the vehicle behind another vehicle such as a motor home, see *Recreational Vehicle Towing* on page 10-83.

Driving Characteristics and Towing Tips

WARNING

The driver can lose control when pulling a trailer if the correct equipment is not used or the vehicle is not driven properly. For example, if the trailer is too heavy, the brakes may not work well — or even at all. The driver and passengers could be seriously injured. The vehicle may also be damaged; the resulting repairs would not be covered by the vehicle warranty. Pull a trailer only if all the steps in this section

(Continued)

WARNING (Continued)

have been followed. Ask your dealer for advice and information about towing a trailer with the vehicle.

The vehicle can tow a trailer when equipped with the proper trailer towing equipment. For trailering capacity, see *Trailer Towing* on page 9-54. Trailering changes handling, acceleration, braking, durability and fuel economy. With the added weight, the engine, transmission, wheel assemblies and tires are forced to work harder and under greater loads. The trailer also adds wind resistance, increasing the pulling requirements. For safe trailering, correctly use the proper trailering equipment.

The following information has important trailering tips and rules for your safety and that of your passengers. Read this section carefully before pulling a trailer.

Pulling a Trailer

Here are some important points:

- There are many laws, including speed limit restrictions that apply to trailering. Check for legal requirements.
- Consider using sway control. See *Towing Equipment* on page 9-56.
- Do not tow a trailer at all during the first 800 km (500 miles) the new vehicle is driven. The engine, axle, or other parts could be damaged.
- During the first 800 km (500 miles) that a trailer is towed, do not drive over 80 km/h (50 mph) and do not make starts at full throttle. This reduces wear on the vehicle.
- The vehicle can tow in D (Drive). Use a lower gear if the transmission shifts too often. See "Tow/Haul Mode" later in this section.

9-50 Driving and Operating

- Obey speed limit restrictions when towing a trailer.
- The vehicle is designed primarily as a passenger and load carrying vehicle. If a trailer is towed, the vehicle will require more frequent maintenance due to the additional load.

Driving with a Trailer

Towing a trailer requires experience. Get familiar with handling and braking with the added trailer weight. The vehicle is now longer and not as responsive as the vehicle is by itself.

Check all trailer hitch parts and attachments, safety chains, electrical connectors, lamps, tires and mirror adjustments. If the trailer

has electric brakes, start the vehicle and trailer moving and then apply the trailer brake controller by hand to be sure the brakes are working.

During the trip, check regularly to be sure that the load is secure, and the lamps and trailer brakes are working properly.

Towing with a Stability Control System

When towing, the sound of the stability control system might be heard. The system is reacting to the vehicle movement caused by the trailer, which mainly occurs during cornering. This is normal when towing heavier trailers.

Tow/Haul Mode

Tow/Haul assists when pulling a heavy trailer or a large or heavy load. The purpose of the Tow/Haul mode is to:

- Reduce the frequency and improve the predictability of transmission shifts.
- Provide the same solid shift feel as when the vehicle is unloaded.
- Improve control of vehicle speed while requiring less throttle pedal activity.
- Increase the charging system voltage to assist in recharging a battery installed in a trailer.



Press this button located on the console to turn on and turn off the Tow/Haul mode. See *Tow/Haul Mode on page 9-29*.

The Tow/Haul light on the instrument panel comes on to indicate that Tow/Haul mode has been selected.

Tow/Haul may be turned off by pressing the button again, at which time the indicator light on the instrument panel will turn off. The vehicle will automatically turn off Tow/Haul every time it is started.

Tow/Haul is designed to be most effective when the vehicle and trailer combined weight is at least 75 percent of the vehicle's Gross Combined Weight Rating (GCWR). See *Trailer Towing on page 9-54*. Tow/Haul is most useful when pulling a heavy trailer or a large or heavy load under the following driving conditions:

- Traveling through rolling terrain.
- Traveling in stop and go traffic.
- Traveling in busy parking lots where improved low speed control of the vehicle is desired.

Operating the vehicle in Tow/Haul when lightly loaded or with no trailer will not cause damage but there is no benefit. Such a selection when unloaded may result in unpleasant engine and transmission driving characteristics and reduced fuel economy.

Following Distance

Stay at least twice as far behind the vehicle ahead as you would when driving the vehicle without a trailer. This can help to avoid situations that require heavy braking and sudden turns.

Passing

More passing distance is needed when towing a trailer. Because the rig is longer, it is necessary to go farther beyond the passed vehicle before returning to the lane.

Backing Up

Hold the bottom of the steering wheel with one hand. To move the trailer to the left, move that hand to the left. To move the trailer to the right, move your hand to the right. Always back up slowly and, if possible, have someone guide you.

Making Turns

Notice: Making very sharp turns while trailering could cause the trailer to come in contact with the vehicle. The vehicle could be damaged. Avoid making very sharp turns while trailering.

When turning with a trailer, make wider turns than normal so the trailer will not strike soft shoulders, curbs, road signs, trees or other objects. Use the turn signal well in advance and avoid jerky or sudden maneuvers.

Turn Signals When Towing a Trailer

The turn signal indicators on the instrument panel flash whenever signaling a turn or lane change. Properly hooked up, the trailer lamps also flash, telling other drivers the vehicle is turning, changing lanes or stopping.

When towing a trailer, the arrows on the instrument panel flash for turns even if the bulbs on the trailer are burned out. Check occasionally to be sure the trailer bulbs are still working.

Driving on Grades

Reduce speed and shift to a lower gear before starting down a long or steep downgrade. If the transmission is not shifted down, the brakes might have to be used so much that they would get hot and no longer work well. See “Automatic Engine Grade Braking” within *Tow/Haul Mode on page 9-29*.

The vehicle can tow in D (Drive). Use a lower gear if the transmission shifts too often.

When towing at high altitude on steep uphill grades, engine coolant will boil at a lower temperature than at normal altitudes. If the engine is turned off immediately after towing at high altitude on steep uphill grades, the vehicle may show signs similar to engine overheating. To avoid this, let the engine run while parked, preferably on level ground, with the transmission in P (Park) for a few minutes before turning the engine off. If the overheat warning comes on, see *Engine Overheating on page 10-18*.

On a long uphill grade, shift down and reduce the vehicle speed to around 88 km/h (55 mph) to reduce the possibility of the engine and the transmission overheating.

Parking on Hills



WARNING

Parking the vehicle on a hill with the trailer attached can be dangerous. If something goes wrong, the rig could start to move. People can be injured, and both the vehicle and the trailer can be damaged. When possible, always park the rig on a flat surface.

If parking the rig on a hill:

1. Press the brake pedal, but do not shift into P (Park) yet. Turn the wheels into the curb if facing downhill or into traffic if facing uphill.
2. Have someone place chocks under the trailer wheels.

3. When the wheel chocks are in place, release the brake pedal until the chocks absorb the load.
4. Reapply the brake pedal. Then apply the parking brake and shift into P (Park).
5. Release the brake pedal.

Leaving After Parking on a Hill

1. Apply and hold the brake pedal while you:
 - 1.1. Start the engine.
 - 1.2. Shift into a gear.
 - 1.3. Release the parking brake.
2. Let up on the brake pedal.
3. Drive slowly until the trailer is clear of the chocks.
4. Stop and have someone pick up and store the chocks.

Maintenance When Trailer Towing

The vehicle needs service more often when pulling a trailer. See *Maintenance Schedule on page 11-2*. Things that are especially important in trailer operation are automatic transmission fluid, engine oil, axle lubricant, belts, cooling system and brake system. Inspect these before and during the trip.

Check periodically to see that all hitch nuts and bolts are tight.

Engine Cooling When Trailer Towing

The cooling system may temporarily overheat during severe operating conditions. See *Engine Overheating on page 10-18*.

Trailer Towing

Three important considerations have to do with weight:

- The weight of the trailer
- The weight of the trailer tongue
- The total weight on the vehicle's tires

Weight of the Trailer

How heavy can a trailer safely be?

Speed, altitude, road grades, outside temperature, special equipment, and the amount of tongue weight the vehicle can carry must be considered. See "Weight of the Trailer Tongue" later in this section for more information.

Maximum trailer weight is calculated assuming only the driver is in the tow vehicle and it has all the required trailering equipment.

The weight of additional optional equipment, passengers and cargo in the tow vehicle must be subtracted from the maximum trailer weight.

Use the following chart to determine how much the vehicle can weigh, based upon the vehicle model and options.

Vehicle	Maximum Trailer Weight	*GCWR
Front-Wheel Drive	2,000 lbs (907 kg)	7,500 lbs (3 402 kg)
Front-Wheel Drive, V92 Trailer Towing Package	4,500 lbs (2 041 kg)	9,500 lbs (4 309 kg)
All-Wheel Drive	2,000 lbs (907 kg)	7,700 lbs (3 493 kg)
All-Wheel Drive, V92 Trailer Towing Package	4,500 lbs (2 041 kg)	9,700 lbs (4 400 kg)

*The Gross Combination Weight Rating (GCWR) is the total allowable weight of the completely loaded vehicle and trailer including any passengers, cargo, equipment and conversions. The GCWR for the vehicle should not be exceeded.

Ask your dealer for our trailering information or advice. See *Customer Assistance Offices (U.S. and Canada)* on page 13-5 or *Customer Assistance Offices (Mexico)* on page 13-6 for more information.

Weight of the Trailer Tongue

The tongue load (A) of any trailer is an important weight to measure because it affects the total gross weight of the vehicle. The Gross Vehicle Weight (GVW) includes the curb weight of the vehicle, any cargo carried in it, and the people who will be riding in the vehicle.

If there are a lot of options, equipment, passengers or cargo in the vehicle, it will reduce the tongue weight the vehicle can carry, which will also reduce the trailer weight the vehicle can tow. If towing a trailer, the tongue load must be added to the GVW because the vehicle will be carrying that weight, too. See *Vehicle Load Limits* on page 9-12

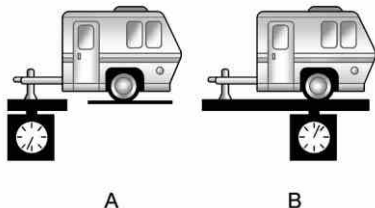

If a weight-carrying hitch or a weight-distributing hitch is being used, the trailer tongue (A) should weigh 10-15 percent of the total loaded trailer weight (B).

After loading the trailer, weigh the trailer and then the tongue, separately, to see if the weights are proper. If they are not, adjustments might be made by moving some items around in the trailer.

Trailer weight may be limited by the vehicle's ability to carry tongue weight. Tongue weight cannot cause the vehicle to exceed the GVWR

(Gross Vehicle Weight Rating) or the RGAWR (Rear Gross Axle Weight Rating). The effect of additional weight may reduce the trailering capacity more than the total of the additional weight.

It is important that the vehicle does not exceed any of its ratings — GCWR, GVWR, RGAWR, Maximum Trailer Rating or Tongue Weight. The only way to be sure it is not exceeding any of these ratings is to weigh the vehicle and trailer.

Total Weight on the Vehicle's Tires

Inflate the vehicle's tires to the upper limit for cold tires. These numbers can be found on the Certification label or see *Vehicle Load Limits* on page 9-12 for more information. Do not go over the GVW limit for the vehicle, or the GAWR, including the weight of the trailer tongue. If using a weight distributing hitch, do not go over the rear axle limit before applying the weight distribution spring bars.

Towing Equipment

Hitches

It is important to have the correct hitch equipment. Crosswinds, large trucks going by, and rough roads are a few reasons why the right hitch is needed.

- The rear bumper on the vehicle is not intended for hitches. Do not attach rental hitches or other bumper-type hitches to it. Use only a frame-mounted hitch that does not attach to the bumper.
- Will any holes be made in the body of the vehicle when the trailer hitch is installed? If so, then be sure to seal the holes when the hitch is removed. If the holes are not sealed, dirt, water, and deadly carbon monoxide (CO) from the exhaust may get into the vehicle. See *Engine Exhaust* on page 9-24.

Weight-Distributing Hitches and Weight Carrying Hitches

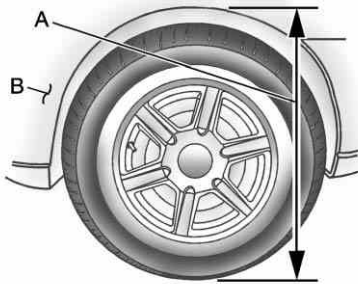

- A. Body-to-Ground Distance
 B. Front of Vehicle

When using a weight-distributing hitch, the hitch must be adjusted so that the distance (A) remains the same both before and after coupling the trailer to the tow vehicle.

Safety Chains

Always attach chains between the vehicle and the trailer. Cross the safety chains under the tongue of the trailer to help prevent the tongue from contacting the road if it becomes separated from the hitch. Always leave just enough slack so the rig can turn. Never allow safety chains to drag on the ground.

Trailer Brakes

A loaded trailer that weighs more than 450 kg (1,000 lbs) needs to have its own brake system that is adequate for the weight of the trailer. Be sure to read and follow the instructions for the trailer brakes so they are installed, adjusted, and maintained properly.

Because the vehicle has antilock brakes, do not try to tap into the vehicle's hydraulic brake system. If you do, both brake systems will not work well, or at all.

Trailer Wiring Harness

Basic Trailer Wiring

The trailer wiring harness, with a seven-pin connector, is located at the rear of the vehicle and is tied to the vehicle's frame. The harness connector can be plugged into a seven-pin universal heavy-duty trailer connector available through your dealer.

The seven-wire harness contains the following trailer circuits:

- Yellow: Left Stop/Turn Signal
- Dark Green: Right Stop/Turn Signal
- Brown: Taillamps
- Black: Ground
- Light Green: Back-up Lamps
- Red/Black: Battery Feed
- Dark Blue: Trailer Brake*

*The fuse for this circuit is installed in the underhood electrical center, but the wires are not connected. They should be connected by your dealer or a qualified service center.

If the back-up lamp circuit is not functional, contact your dealer.

If a remote (non-vehicle) battery is being charged, press the Tow/Haul mode switch located on the center console near the climate controls. This will boost the vehicle system voltage and properly charge the battery. If the trailer is too light for Tow/Haul mode, turn on the headlamps (non-HID only) as a second way to boost the vehicle system and charge the battery.

Electric Trailer Brake Control Wiring Provisions

These wiring provisions for an electric trailer brake controller are included with the vehicle as part of the trailer wiring package. The instrument panel contains blunt cut wires behind the steering column for the electric trailer brake controller. The harness contains the following wires:

- Red/Black: Power Supply
- White: Brake Switch Signal
- Gray: Illumination
- Dark Blue: Trailer Brake Signal
- Black: Ground

The electric trailer brake controller should be installed by your dealer or a qualified service center.

Conversions and Add-Ons

Add-On Electrical Equipment

Notice: Do not add anything electrical to the vehicle unless you check with your dealer first. Some electrical equipment can damage the vehicle and the damage would not be covered by the vehicle's warranty. Some add-on electrical equipment can keep other components from working as they should.

Add-on equipment can drain the vehicle's 12-volt battery, even if the vehicle is not operating.

The vehicle has an airbag system. Before attempting to add anything electrical to the vehicle, see *Servicing the Airbag-Equipped Vehicle* on page 3-36 and *Adding Equipment to the Airbag-Equipped Vehicle* on page 3-36.

Vehicle Care

General Information

General Information	10-2
California Proposition 65 Warning	10-3
California Perchlorate Materials Requirements	10-3
Accessories and Modifications	10-3

Vehicle Checks

Doing Your Own Service Work	10-4
Hood	10-5
Engine Compartment Overview	10-6
Engine Cover	10-7
Engine Oil	10-8
Engine Oil Life System	10-10
Automatic Transmission Fluid	10-12
Engine Air Cleaner/Filter	10-12
Cooling System	10-14
Engine Coolant	10-14
Engine Overheating	10-18

Overheated Engine Protection Operating Mode	10-20
Power Steering Fluid	10-21
Washer Fluid	10-22
Brakes	10-23
Brake Fluid	10-24
Battery	10-25
All-Wheel Drive	10-25
Starter Switch Check	10-26
Automatic Transmission Shift Lock Control Function Check	10-26
Ignition Transmission Lock Check	10-27
Park Brake and P (Park) Mechanism Check	10-27
Wiper Blade Replacement	10-27
Windshield Replacement ...	10-28

Headlamp Aiming

Headlamp Aiming	10-28
-----------------------	-------

Bulb Replacement

Bulb Replacement	10-29
Halogen Bulbs	10-29
High Intensity Discharge (HID) Lighting	10-29

Taillamps, Turn Signal, Sidemarker, and Stoplamps	10-29
License Plate Lamp	10-30
Replacement Bulbs	10-30

Electrical System

High Voltage Devices and Wiring	10-31
Electrical System Overload	10-31
Fuses and Circuit Breakers	10-32
Engine Compartment Fuse Block	10-32
Instrument Panel Fuse Block	10-35

Wheels and Tires

Tires	10-38
Tire Sidewall Labeling	10-39
Tire Designations	10-41
Tire Terminology and Definitions	10-42
Tire Pressure	10-45
Tire Pressure Monitor System	10-46
Tire Pressure Monitor Operation	10-48

10-2 Vehicle Care

Tire Inspection	10-52
Tire Rotation	10-52
When It Is Time for New Tires	10-53
Buying New Tires	10-54
Different Size Tires and Wheels	10-56
Uniform Tire Quality Grading	10-56
Wheel Alignment and Tire Balance	10-58
Wheel Replacement	10-58
Tire Chains	10-59
If a Tire Goes Flat	10-60
Tire Sealant and Compressor Kit	10-62
Storing the Tire Sealant and Compressor Kit	10-69
Tire Changing	10-69
Compact Spare Tire	10-78

Jump Starting

Jump Starting	10-79
---------------------	-------

Towing

Towing the Vehicle	10-83
Recreational Vehicle Towing	10-83

Appearance Care

Exterior Care	10-86
Interior Care	10-90
Floor Mats	10-93

General Information

For service and parts needs, visit your dealer. You will receive genuine GM parts and GM-trained and supported service people.

Genuine GM parts have one of these marks:

ACDelco[®]

Genuine **GM** | **Parts**[®]

GM | **Accessories**[®]

California Proposition 65 Warning

Most motor vehicles, including this one, contain and/or emit chemicals known to the State of California to cause cancer and birth defects or other reproductive harm. Engine exhaust, many parts and systems, many fluids, and some component wear by-products contain and/or emit these chemicals.

California Perchlorate Materials Requirements

Certain types of automotive applications, such as airbag initiators, seat belt pretensioners, and lithium batteries contained in Remote Keyless Entry transmitters, may contain perchlorate materials. Special handling may be necessary. For additional information, see www.dtsc.ca.gov/hazardouswaste/perchlorate.

Accessories and Modifications

Adding non-dealer accessories or making modifications to the vehicle can affect vehicle performance and safety, including such things as airbags, braking, stability, ride and handling, emissions systems, aerodynamics, durability, and electronic systems like antilock brakes, traction control, and stability control. These accessories or modifications could even cause malfunction or damage not covered by the vehicle warranty.

Damage to vehicle components resulting from modifications or the installation or use of non-GM certified parts, including control module or software modifications, is not covered under the terms of the vehicle warranty and may affect remaining warranty coverage for affected parts.

GM Accessories are designed to complement and function with other systems on the vehicle. See your dealer to accessorize the vehicle using genuine GM Accessories installed by a dealer technician.

Also, see [Adding Equipment to the Airbag-Equipped Vehicle](#) on page 3-36.

Vehicle Checks

Doing Your Own Service Work

 **WARNING**

You can be injured and the vehicle could be damaged if you try to do service work on a vehicle without knowing enough about it.

- Be sure you have sufficient knowledge, experience, the proper replacement parts, and tools before attempting any vehicle maintenance task.

(Continued)

WARNING (Continued)

- Be sure to use the proper nuts, bolts, and other fasteners. Metric and English fasteners can be easily confused. If the wrong fasteners are used, parts can later break or fall off. You could be hurt.

If doing some of your own service work, use the proper service manual. It tells you much more about how to service the vehicle than this manual can. To order the proper service manual, see *Service Publications Ordering Information on page 13-18*.

This vehicle has an airbag system. Before attempting to do your own service work, see *Servicing the Airbag-Equipped Vehicle on page 3-36*.

Keep a record with all parts receipts and list the mileage and the date of any service work performed. See *Maintenance Records on page 11-15*.

Hood

To open the hood:



1. Pull the hood release handle with this symbol on it. It is located under the instrument panel on the driver side of the vehicle.

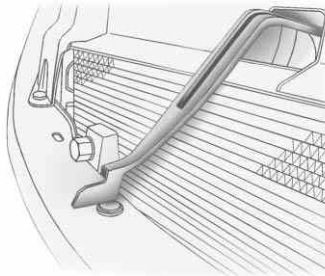

2. At the front of the vehicle, pull up on the bottom center of the grille, and push the secondary hood release to the left.

3. After the lid has been partially lifted, a gas strut automatically lifts and holds the hood in the fully open position.

Before closing the hood, be sure all filler caps are on properly.

Pull the hood down to close. Lower the hood until the lifting pressure of the strut is reduced. Then allow the hood to fall and latch into place under its own weight. Check to make sure the hood is closed. If the hood does not fully latch, gently push the hood down at the front and center until it is completely latched.

Engine Compartment Overview

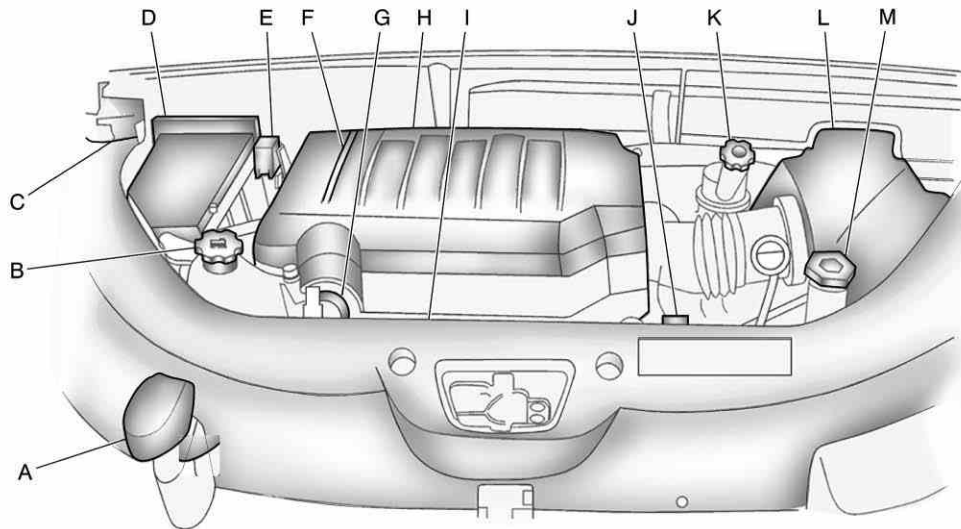

- A. Radiator Pressure Cap. See *Cooling System on page 10-14.*
- B. Engine Coolant Recovery Cap. See *Cooling System on page 10-14.*
- C. Remote Negative (-) Terminal. See *Jump Starting on page 10-79.*
- D. *Engine Compartment Fuse Block on page 10-32.*
- E. Remote Positive (+) Terminal. See *Jump Starting on page 10-79.*
- F. Power Steering Reservoir and Cap (under engine cover). See *Power Steering Fluid on page 10-21.*
- G. Engine Oil Fill Cap. See "When to Add Engine Oil" under *Engine Oil on page 10-8.*
- H. *Engine Cover on page 10-7.*
- I. Engine Oil Dipstick (out of view). See "Checking Engine Oil" under *Engine Oil on page 10-8.*
- J. Automatic Transmission Fluid Dipstick. See "Checking the Fluid Level" under *Automatic Transmission Fluid on page 10-12.*
- K. Brake Master Cylinder Reservoir. See "Brake Fluid" under *Brakes on page 10-23.*
- L. *Engine Air Cleaner/Filter on page 10-12.*
- M. Windshield Washer Fluid Reservoir. See "Adding Washer Fluid" under *Washer Fluid on page 10-22.*

Engine Cover

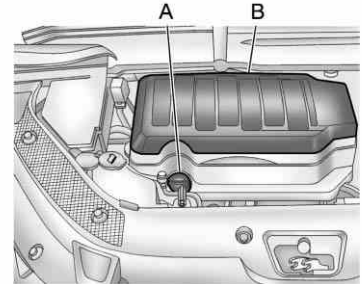

- A. Oil Fill Cap
- B. Engine Cover

To remove:

1. Remove the oil fill cap (A).
2. Raise the engine cover (B) to release it from the retainers.
3. Lift and remove the engine cover.
4. Reverse Steps 1 through 3 to reinstall engine cover.

Engine Oil

To ensure proper engine performance and long life, careful attention must be paid to engine oil. Following these simple, but important steps will help protect your investment:

- Always use engine oil approved to the proper specification and of the proper viscosity grade. See “Selecting the Right Engine Oil” in this section.
- Check the engine oil level regularly and maintain the proper oil level. See “Checking Engine Oil” and “When to Add Engine Oil” in this section.
- Change the engine oil at the appropriate time. See *Engine Oil Life System on page 10-10*.
- Always dispose of engine oil properly. See “What to Do with Used Oil” in this section.

Checking Engine Oil

It is a good idea to check the engine oil level at each fuel fill. In order to get an accurate reading, the vehicle must be on level ground. The engine oil dipstick handle is a yellow loop. See *Engine Compartment Overview on page 10-6* for the location of the engine oil dipstick.

Obtaining an accurate oil level reading is essential:

1. If the engine has been running recently, turn off the engine and allow several minutes for the oil to drain back into the oil pan. Checking the oil level too soon after engine shutoff will not provide an accurate oil level reading.
2. Pull out the dipstick and clean it with a paper towel or cloth, then push it back in all the way. Remove it again, keeping the tip down, and check the level.

When to Add Engine Oil



If the oil is below the cross-hatched area at the tip of the dipstick, add 1 L (1 qt) of the recommended oil and then recheck the level. See “Selecting the Right Engine Oil” in this section for an explanation of what kind of oil to use. For engine oil crankcase capacity, see *Capacities and Specifications on page 12-2*.

Notice: Do not add too much oil. Oil levels above or below the acceptable operating range shown on the dipstick are harmful to the engine. If you find that you have an oil level above the operating range, i.e., the engine has so much oil that the oil level gets above the cross-hatched area that shows the proper operating range, the engine could be damaged. You should drain out the excess oil or limit driving of the vehicle and seek a service professional to remove the excess amount of oil.

See *Engine Compartment Overview* on page 10-6 for the location of the engine oil fill cap.

Add enough oil to put the level somewhere in the proper operating range. Push the dipstick all the way back in when through.

Selecting the Right Engine Oil

Selecting the right engine oil depends on both the proper oil specification and viscosity grade. See *Recommended Fluids and Lubricants* on page 11-12.

Specification

Use and ask for licensed engine oils with the dexos1™ approved certification mark. Engine oils meeting the requirements for the vehicle should have the dexos1 approved certification mark. This certification mark indicates that the oil has been approved to the dexos1 specification.



Notice: Failure to use the recommended engine oil or equivalent can result in engine damage not covered by the vehicle warranty. Check with your dealer or service provider on whether the oil is approved to the dexos1 specification.

Viscosity Grade

SAE 5W-30 is the best viscosity grade for the vehicle. Do not use other viscosity grade oils such as SAE 10W-30, 10W-40, or 20W-50.

If in an area of extreme cold, where the temperature falls below -20°F (-29°C), an SAE 0W-30 oil should be used. An oil of this viscosity grade will provide easier cold starting for the engine at extremely low temperatures. When selecting an oil of the appropriate viscosity grade, always select an oil that meets the dexos1 specification or equivalent. See "Specification" for more information.

Engine Oil Additives/Engine Oil Flushes

Do not add anything to the oil. The recommended oils with the dexos specification and displaying the dexos certification mark are all that is needed for good performance and engine protection.

Engine oil system flushes are not recommended and could cause engine damage not covered by the vehicle warranty.

What to Do with Used Oil

Used engine oil contains certain elements that can be unhealthy for your skin and could even cause cancer. Do not let used oil stay on your skin for very long. Clean your skin and nails with soap and water, or a good hand cleaner. Wash or properly dispose of clothing or rags containing used engine oil. See the manufacturer's warnings about the use and disposal of oil products.

Used oil can be a threat to the environment. If you change your own oil, be sure to drain all the oil from the filter before disposal. Never dispose of oil by putting it in the trash or pouring it on the ground, into sewers, or into streams or bodies of water. Recycle it by taking it to a place that collects used oil.

Engine Oil Life System

When to Change Engine Oil

This vehicle has a computer system that indicates when to change the engine oil and filter. This is based on a combination of factors which include engine revolutions, engine temperature, and miles driven. Based on driving conditions, the mileage at which an oil change is indicated can vary considerably. For the oil life system to work properly, the system must be reset every time the oil is changed.

When the system has calculated that oil life has been diminished, it indicates that an oil change is necessary. A CHANGE ENGINE OIL SOON message comes on.

Change the oil as soon as possible within the next 1 000 km (600 mi). It is possible that, if driving under the best conditions, the oil life system might indicate that an oil change is not necessary for up to a year. The engine oil and filter must be changed at least once a year and, at this time, the system must be reset. Your dealer has trained service people who will perform this work and reset the system. It is also important to check the oil regularly over the course of an oil drain interval and keep it at the proper level.

If the system is ever reset accidentally, the oil must be changed at 5 000 km (3,000 mi) since the last oil change. Remember to reset the oil life system whenever the oil is changed.

How to Reset the Engine Oil Life System

Reset the system whenever the engine oil is changed so that the system can calculate the next engine oil change. To reset the system:

1. Turn the ignition to ON/RUN, with the engine off.
2. Press the vehicle information button until OIL LIFE REMAINING displays.

3. Press and hold the set/reset button until "100%" is displayed. Three chimes sound and the CHANGE ENGINE OIL SOON message goes off.
4. Turn the key to LOCK/OFF.

If the CHANGE ENGINE OIL SOON message comes back on when the vehicle is started, the engine oil life system has not been reset. Repeat the procedure.

Automatic Transmission Fluid

It is not necessary to check the transmission fluid level. A transmission fluid leak is the only reason for fluid loss. If a leak occurs, take the vehicle to the dealer and have it repaired as soon as possible.

Change the fluid at the intervals listed in *Maintenance Schedule on page 11-2*, and be sure to use the transmission fluid listed in *Recommended Fluids and Lubricants on page 11-12*.

Notice: Use of the incorrect automatic transmission fluid may damage the vehicle, and the damages may not be covered by the vehicle warranty. Always use the automatic transmission fluid listed in *Recommended Fluids and Lubricants on page 11-12*.

The transmission fluid will not reach the end of the dipstick unless the transmission is at operating temperature. If you need to check the transmission fluid level, please take the vehicle to your dealer.

Engine Air Cleaner/Filter

When to Inspect the Engine Air Cleaner/Filter

Inspect the air cleaner/filter at the scheduled maintenance intervals and replace it at the first oil change after each 80 000 km (50,000 mile) interval. See *Maintenance Schedule on page 11-2* for more information. If you are driving in dusty/dirty conditions, inspect the filter at each engine oil change.

See *Engine Compartment Overview on page 10-6* for the location of the engine air cleaner/filter.

How to Inspect the Engine Air Cleaner/Filter

To inspect the air cleaner/filter, remove the filter from the vehicle and lightly shake the filter (away from vehicle) to release loose dust and dirt. If the filter remains covered with dirt, a new filter is required.

To inspect or replace the engine air cleaner/filter:

1. Remove the engine cover.
See *Engine Cover on page 10-7*.

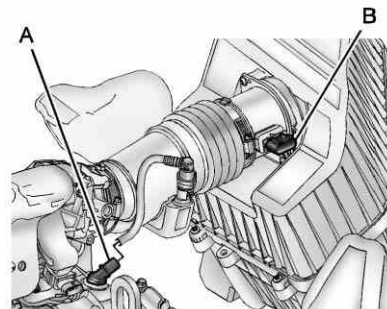

- A. Ventilation Tube
- B. Sensor

2. Disconnect the cover fitting from the ventilation tube (A).
3. Disconnect the wiring harness connector from the sensor (B).

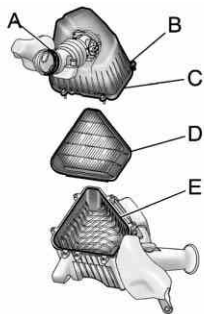

- A. Clamp
- B. Screws
- C. Housing Cover
- D. Filter
- E. Base

4. Loosen the outlet duct clamp (A).
5. Loosen the six housing cover (C) screws (B).
6. Remove the housing cover (C) with outlet duct.
7. Remove the filter (D) and any loose debris that may be found in the base (E).
8. Inspect or replace the filter (D).
9. Reverse Steps 2 through 6 to reinstall the housing cover and reconnect the electrical connector to the sensor.
10. Reinstall the engine cover. See *Engine Cover* on page 10-7.

⚠ WARNING

Operating the engine with the air cleaner/filter off can cause you or others to be burned. The air cleaner not only cleans the air; it helps to stop flames if the engine backfires. Use caution when working on the engine and do not drive with the air cleaner/filter off.

Notice: If the air cleaner/filter is off, dirt can easily get into the engine, which could damage it. Always have the air cleaner/filter in place when you are driving.

Cooling System

The cooling system allows the engine to maintain the correct working temperature.

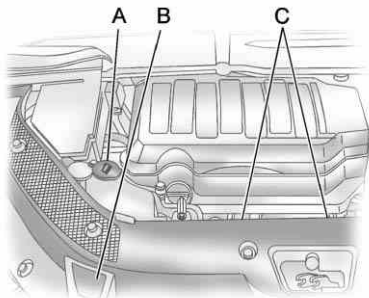

- A. Engine Coolant Recovery Tank
- B. Radiator Pressure Cap
- C. Engine Cooling Fans (Out of View)

WARNING

An electric engine cooling fan under the hood can start up even when the engine is not running and can cause injury. Keep hands, clothing, and tools away from any underhood electric fan.

WARNING

Heater and radiator hoses, and other engine parts, can be very hot. Do not touch them. If you do, you can be burned.

Do not run the engine if there is a leak. If you run the engine, it could lose all coolant. That could cause an engine fire, and you could be burned. Get any leak fixed before you drive the vehicle.

Notice: Using coolant other than DEX-COOL[®] can cause premature engine, heater core, or radiator corrosion. In addition, the engine coolant could require changing sooner, at 50 000 km (30,000 mi) or 24 months, whichever occurs first. Any repairs would not be covered by the vehicle warranty. Always use DEX-COOL (silicate-free) coolant in the vehicle.

Engine Coolant

The cooling system in the vehicle is filled with DEX-COOL[®] engine coolant. The coolant is designed to remain in the vehicle for 5 years or 240 000 km (150,000 mi), whichever occurs first.

The following explains the cooling system and how to check and add coolant when it is low. If there is a problem with engine overheating, see *Engine Overheating on page 10-18*.

What to Use

 **WARNING**

Adding only plain water or some other liquid to the cooling system can be dangerous. Plain water and other liquids, can boil before the proper coolant mixture will. The coolant warning system is set for the proper coolant mixture. With plain water or the wrong mixture, the engine could get too hot but you would not get the overheat warning. The engine could catch fire and you or others could be burned. Use a 50/50 mixture of clean, drinkable water and DEX-COOL coolant.

Use a 50/50 mixture of clean, drinkable water and DEX-COOL coolant. If using this mixture, nothing else needs to be added. This mixture:

- Gives freezing protection down to -37°C (-34°F), outside temperature.
- Gives boiling protection up to 129°C (265°F), engine temperature.
- Protects against rust and corrosion.
- Will not damage aluminum parts.
- Helps keep the proper engine temperature.

Notice: If an improper coolant mixture is used, the engine could overheat and be badly damaged. The repair cost would not be covered by the vehicle warranty. Too much water in the mixture can freeze and crack the engine, radiator, heater core, and other parts.

Notice: If extra inhibitors and/or additives are used in the vehicle's cooling system, the vehicle could be damaged. Use only the proper mixture of the engine coolant listed in this manual for the cooling system. See *Recommended Fluids and Lubricants* on page 11-12 for more information.

Never dispose of engine coolant by putting it in the trash, pouring it on the ground, or into sewers, streams, or bodies of water. Have the coolant changed by an authorized service center, familiar with legal requirements regarding used coolant disposal. This will help protect the environment and your health.

Checking Coolant

The vehicle must be on a level surface when checking the coolant level.

Check to see if coolant is visible in the coolant recovery tank. If the coolant inside the coolant recovery tank is boiling, do not do anything else until it cools down. If coolant is visible but the coolant level is not at or above the FULL COLD mark, add a 50/50 mixture of clean, drinkable water and DEX-COOL coolant at the coolant recovery tank, but be sure the cooling system is cool before this is done. See *Cooling System* on page 10-14 for more information.



The coolant recovery tank cap has this symbol on it.

When the engine is cold, the coolant level should be at or above the FULL COLD line marked on the recovery tank.

When the engine is hot, the level could be higher than the FULL COLD line. If the coolant is below the FULL COLD line when the engine is hot, there could be a leak in the cooling system.

If the coolant is low, add the coolant or take the vehicle to a dealer for service.

How to Add Coolant to the Recovery Tank



You can be burned if you spill coolant on hot engine parts. Coolant contains ethylene glycol and it will burn if the engine parts are hot enough. Do not spill coolant on a hot engine.

Notice: This vehicle has a specific coolant fill procedure. Failure to follow this procedure could cause the engine to overheat and be severely damaged.

If coolant is needed, add the proper DEX-COOL coolant mixture at the coolant recovery tank.

How to Add Coolant to the Radiator

WARNING

An electric engine cooling fan under the hood can start up even when the engine is not running and can cause injury. Keep hands, clothing, and tools away from any underhood electric fan.

WARNING

Steam and scalding liquids from a hot cooling system can blow out and burn you badly. They are under pressure, and if you turn the surge tank pressure cap — even a little — they can come out at high speed. Never turn the cap when the cooling system, including the surge tank

(Continued)

WARNING (Continued)

pressure cap, is hot. Wait for the cooling system and surge tank pressure cap to cool if you ever have to turn the pressure cap.

If coolant is needed, add the proper mixture directly to the radiator, but be sure the cooling system is cool before this is done.

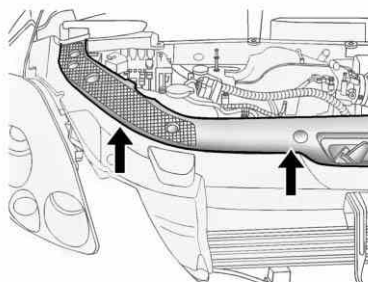

1. Detach the fasteners and lift off the panel that covers the radiator cap.



2. Remove the radiator pressure cap when the cooling system, including the upper radiator hose, is no longer hot. Turn the pressure cap slowly counterclockwise about one full turn.
If a hiss is heard, wait for that to stop. A hiss means there is still some pressure left in the system.
3. Keep turning the pressure cap slowly and remove it.
4. Fill the radiator to the base of the filler neck with the proper DEX-COOL coolant mixture.

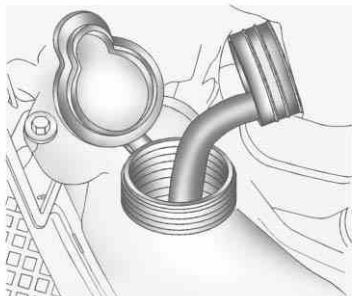

5. Fill the coolant recovery tank to the FULL COLD mark.
6. Reinstall the cap on the coolant recovery tank but leave the radiator pressure cap off.
7. Start the engine and let it run until the upper radiator hose feels warm. Any time during this procedure, watch out for the engine cooling fans.
8. If the coolant level inside the radiator filler neck is low, add more of the proper DEX-COOL coolant mixture through the filler neck until the level is back up to the base of the filler neck.
9. Replace the pressure cap. Be sure to secure it tightly. At any time during this procedure if coolant begins to flow out of the filler neck, reinstall the pressure cap.

Notice: If the pressure cap is not tightly installed, coolant loss and possible engine damage may occur. Be sure the cap is properly and tightly secured.

Engine Overheating

The vehicle has several indicators to warn of engine overheating.

There is an engine coolant temperature gauge on the instrument panel cluster. See *Engine Coolant Temperature Gauge* on page 5-15.

The vehicle may also display an ENGINE OVERHEATED IDLE ENGINE and ENGINE OVERHEATED STOP ENGINE message in the Driver Information Center (DIC). See *Engine Cooling System Messages* on page 5-33.

You may decide not to lift the hood when this warning appears, but instead get service help right away. See *Roadside Assistance Program (U.S. and Canada)* on page 13-8 or *Roadside Assistance Program (Mexico)* on page 13-10.

If you do decide to lift the hood, make sure the vehicle is parked on a level surface.

Then check to see if the engine cooling fans are running. If the engine is overheating, both fans should be running. If they are not, do not continue to run the engine and have the vehicle serviced.

Notice: Engine damage from running the engine without coolant is not covered by the warranty.

Notice: If the engine catches fire while driving with no coolant, the vehicle can be badly damaged. The costly repairs would not be covered by the vehicle warranty. See *Overheated Engine Protection Operating Mode* on page 10-20 for information on driving to a safe place in an emergency.

If Steam Is Coming from the Engine Compartment

WARNING

Steam from an overheated engine can burn you badly, even if you just open the hood. Stay away from the engine if you see or hear steam coming from it. Turn it off and get everyone away from the vehicle until it cools down. Wait until there is no sign of steam or coolant before you open the hood.

(Continued)

WARNING (Continued)

If you keep driving when the vehicle's engine is overheated, the liquids in it can catch fire. You or others could be badly burned. Stop the engine if it overheats, and get out of the vehicle until the engine is cool.

See *Overheated Engine Protection Operating Mode* on page 10-20 for information on driving to a safe place in an emergency.

If No Steam Is Coming from the Engine Compartment

If an engine overheat warning is displayed but no steam can be seen or heard, the problem may not be too serious. Sometimes the engine can get a little too hot when the vehicle:

- Climbs a long hill on a hot day
- Stops after high-speed driving
- Idles for long periods in traffic
- Tows a trailer

If the overheat warning is displayed with no sign of steam:

1. Turn the air conditioning off.
2. Turn the heater on to the highest temperature and to the highest fan speed. Open the windows as necessary.

3. If in a traffic jam, shift to N (Neutral); otherwise, shift to the highest gear while driving — D (Drive) or L (Low).

If the temperature overheat gauge is no longer in the overheat zone or an overheat warning no longer displays, the vehicle can be driven. Continue to drive the vehicle slow for about 10 minutes. Keep a safe vehicle distance from the car in front of you. If the warning does not come back on, continue to drive normally.

If the warning continues, pull over, stop, and park the vehicle right away.

If there is no sign of steam, idle the engine for three minutes while parked. If the warning is still displayed, turn off the engine until it cools down. Also, see “Overheated Engine Protection Operating Mode” next in this section.

Overheated Engine Protection Operating Mode

This emergency operating mode lets the vehicle be driven to a safe place in an emergency situation. If an overheated engine condition exists, an overheat protection mode which alternates firing groups of cylinders helps prevent engine damage. In this mode, there is a significant loss in power and engine performance. The temperature gauge indicates an overheat condition exists. Driving extended distances and/or towing a trailer in the overheat protection mode should be avoided.

Notice: After driving in the overheated engine protection operating mode, to avoid engine damage, allow the engine to cool before attempting any repair. The engine oil will be severely degraded. Repair the cause of coolant loss, change the oil and reset the oil life system. See *Engine Oil* on page 10-8.

Power Steering Fluid



The power steering fluid reservoir is located under the engine cover on the passenger side of the vehicle. See *Engine Compartment Overview* on page 10-6 for reservoir location.

When to Check Power Steering Fluid

It is not necessary to regularly check power steering fluid unless you suspect there is a leak in the system or you hear an unusual noise. A fluid loss in this system could indicate a problem. Have the system inspected and repaired.

How to Check Power Steering Fluid

To check the power steering fluid:

1. Turn the key off and let the engine compartment cool down.
2. Remove the engine cover. See *Engine Cover* on page 10-7.
3. Wipe the cap and the top of the reservoir clean.
4. Unscrew the cap and wipe the dipstick with a clean rag.

5. Replace the cap and completely tighten it.
6. Remove the cap again and look at the fluid level on the dipstick.

The fluid level should be somewhere between the MAX and MIN line on the dipstick in room temperature. If the fluid is on or below the MIN line, add fluid close to the MAX Line.

What to Use

To determine what kind of fluid to use, see *Recommended Fluids and Lubricants* on page 11-12. Always use the proper fluid.

Notice: Use of the incorrect fluid may damage the vehicle and the damages may not be covered by the vehicle's warranty. Always use the correct fluid listed in *Recommended Fluids and Lubricants* on page 11-12.

Washer Fluid

What to Use

When adding windshield washer fluid, be sure to read the manufacturer's instructions before use. If the vehicle will be operating in an area where the temperature may fall below freezing, use a fluid that has sufficient protection against freezing.

Adding Washer Fluid

When the windshield washer fluid reservoir is low, a WASHER FLUID LOW ADD FLUID message will be displayed on the Driver Information Center (DIC). See *Washer Fluid Messages on page 5-40* for more information.



Open the cap with the washer symbol on it. Add washer fluid until the tank is full. See *Engine Compartment Overview on page 10-6* for reservoir location.

Notice

- **When using concentrated washer fluid, follow the manufacturer's instructions for adding water.**
- **Do not mix water with ready-to-use washer fluid. Water can cause the solution**

to freeze and damage the washer fluid tank and other parts of the washer system. Also, water does not clean as well as washer fluid.

- **Fill the washer fluid tank only three-quarters full when it is very cold. This allows for fluid expansion if freezing occurs, which could damage the tank if it is completely full.**
- **Do not use engine coolant (antifreeze) in the windshield washer. It can damage the windshield washer system and paint.**

Brakes

This vehicle has disc brakes. Disc brake pads have built-in wear indicators that make a high-pitched warning sound when the brake pads are worn and new pads are needed. The sound can come and go or be heard all the time the vehicle is moving, except when applying the brake pedal firmly.

WARNING

The brake wear warning sound means that soon the brakes will not work well. That could lead to a crash. When the brake wear warning sound is heard, have the vehicle serviced.

Notice: Continuing to drive with worn-out brake pads could result in costly brake repair.

Some driving conditions or climates can cause a brake squeal when the brakes are first applied or lightly applied. This does not mean something is wrong with the brakes.

Properly torqued wheel nuts are necessary to help prevent brake pulsation. When tires are rotated, inspect brake pads for wear and evenly tighten wheel nuts in the proper sequence to torque specifications in *Capacities and Specifications on page 12-2*.

Brake linings should always be replaced as complete axle sets.

Brake Pedal Travel

See your dealer if the brake pedal does not return to normal height, or if there is a rapid increase in pedal travel. This could be a sign that brake service might be required.

Brake Adjustment

Every time the brakes are applied, with or without the vehicle moving, the brakes adjust for wear.

Replacing Brake System Parts

The braking system on a vehicle is complex. Its many parts have to be of top quality and work well together if the vehicle is to have really good braking. The vehicle was designed and tested with top-quality brake parts. When parts of the braking system are replaced, be sure to get new, approved replacement parts. If this is not done, the brakes might not work properly. For example, installing disc brake pads that are wrong for the vehicle, can change the balance between the front and rear brakes — for the worse. The braking performance expected can change in many other ways if the wrong replacement brake parts are installed.

Brake Fluid



The brake master cylinder reservoir is filled with DOT 3 brake fluid as indicated on the reservoir cap.

See *Engine Compartment Overview on page 10-6* for the location of the reservoir.

There are only two reasons why the brake fluid level in the reservoir might go down:

- The brake fluid level goes down because of normal brake lining wear. When new linings are installed, the fluid level goes back up.

- A fluid leak in the brake hydraulic system can also cause a low fluid level. Have the brake hydraulic system fixed, since a leak means that sooner or later the brakes will not work well.

Do not top off the brake fluid. Adding fluid does not correct a leak. If fluid is added when the linings are worn, there will be too much fluid when new brake linings are installed. Add or remove brake fluid, as necessary, only when work is done on the brake hydraulic system.

WARNING

If too much brake fluid is added, it can spill on the engine and burn, if the engine is hot enough. You or others could be burned, and the vehicle could be damaged. Add brake fluid only when work is done on the brake hydraulic system.

When the brake fluid falls to a low level, the brake warning light comes on. See *Brake System Warning Light on page 5-22*.

What to Add

Use only new DOT 3 brake fluid from a sealed container. See *Recommended Fluids and Lubricants on page 11-12*.

Always clean the brake fluid reservoir cap and the area around the cap before removing it. This helps keep dirt from entering the reservoir.

WARNING

With the wrong kind of fluid in the brake hydraulic system, the brakes might not work well. This could cause a crash. Always use the proper brake fluid.

Notice

- **Using the wrong fluid can badly damage brake hydraulic system parts. For example, just a few drops of mineral-based oil, such as engine oil, in the brake hydraulic system can damage brake hydraulic system parts so badly that they will have to be replaced. Do not let someone put in the wrong kind of fluid.**
- **If brake fluid is spilled on the vehicle's painted surfaces, the paint finish can be damaged. Be careful not to spill brake fluid on the vehicle. If you do, wash it off immediately.**

Battery

Refer to the replacement number on the original battery label when a new battery is needed.

 **WARNING**

Battery posts, terminals, and related accessories contain lead and lead compounds, chemicals known to the State of California to cause cancer and reproductive harm. Wash hands after handling.

Vehicle Storage **WARNING**

Batteries have acid that can burn you and gas that can explode. You can be badly hurt if you are not careful. See *Jump Starting on page 10-79* for tips on working around a battery without getting hurt.

Infrequent Usage: Remove the black, negative (-) cable from the battery to keep the battery from running down.

Extended Storage: Remove the black, negative (-) cable from the battery or use a battery trickle charger.

All-Wheel Drive

It is not necessary to check the all-wheel drive lubricant levels. A fluid leak is the only reason for fluid loss. If a leak occurs, take the vehicle to the dealer as soon as possible.

Starter Switch Check

 **WARNING**

When you are doing this inspection, the vehicle could move suddenly. If the vehicle moves, you or others could be injured.

1. Before starting this check, be sure there is enough room around the vehicle.
2. Firmly apply both the parking brake and the regular brake. See *Parking Brake on page 9-31*.
Do not use the accelerator pedal, and be ready to turn off the engine immediately if it starts.

3. Try to start the engine in each gear. The vehicle should start only in P (Park) or N (Neutral). If the vehicle starts in any other position, contact your dealer for service.

Automatic Transmission Shift Lock Control Function Check

 **WARNING**

When you are doing this inspection, the vehicle could move suddenly. If the vehicle moves, you or others could be injured.

1. Before starting this check, be sure there is enough room around the vehicle. It should be parked on a level surface.

2. Firmly apply the parking brake. See *Parking Brake on page 9-31*.

Be ready to apply the regular brake immediately if the vehicle begins to move.

3. With the engine off, turn the ignition on, but do not start the engine. Without applying the regular brake, try to move the shift lever out of P (Park) with normal effort. If the shift lever moves out of P (Park), contact your dealer for service.

Ignition Transmission Lock Check

While parked, and with the parking brake set, try to turn the ignition to LOCK/OFF in each shift lever position.

- The ignition should turn to LOCK/OFF only when the shift lever is in P (Park).
- The ignition key should come out only in LOCK/OFF.

Contact your dealer if service is required.

Park Brake and P (Park) Mechanism Check

WARNING

When you are doing this check, the vehicle could begin to move. You or others could be injured and property could be damaged. Make sure there is room in front

(Continued)

WARNING (Continued)

of the vehicle in case it begins to roll. Be ready to apply the regular brake at once should the vehicle begin to move.

Park on a fairly steep hill, with the vehicle facing downhill. Keeping your foot on the regular brake, set the parking brake.

- To check the parking brake's holding ability: With the engine running and the transmission in N (Neutral), slowly remove foot pressure from the regular brake pedal. Do this until the vehicle is held by the parking brake only.
- To check the P (Park) mechanism's holding ability: With the engine running, shift to P (Park). Then release the parking brake followed by the regular brake.

Contact your dealer if service is required.

Wiper Blade Replacement

Windshield wiper blades should be inspected for wear or cracking. See *Maintenance Schedule on page 11-2* for more information.

Replacement blades come in different types and are removed in different ways. To replace the wiper blade assembly:

1. Pull the windshield wiper arm away from the windshield.

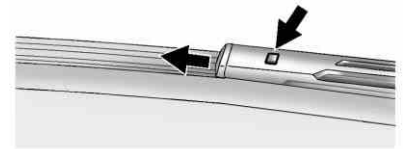

2. Press the button in the middle of the wiper arm connector and pull the wiper blade away from the arm connector.
3. Install the new wiper blade and make sure the wiper blade locks into place.

For the proper size and type see *Maintenance Replacement Parts* on page 11-14.

Backglass Wiper Blade

To replace the backglass wiper blade:

1. Pull the wiper blade assembly away from the backglass.
The backglass wiper blade will not lock in a vertical position so care should be used when pulling it away from the vehicle.
2. Rotate the wiper blade assembly, hold the wiper arm in position, and push the blade away from the wiper arm.

3. Replace the wiper blade.
4. Return the wiper arm and blade assembly to the rest position on the glass.

Windshield Replacement

The vehicle is equipped with an acoustic windshield. If you ever have to have the windshield replaced be sure to get an acoustic windshield so you will continue to have the benefits an acoustic windshield can provide.

Headlamp Aiming

Headlamp aim has been preset at the factory and should need no further adjustment.

However, if your vehicle is damaged in a crash, the headlamp aim may be affected. Aim adjustment to the low-beam headlamps may be necessary if oncoming drivers flash their high-beam headlamps at you (for vertical aim).

If the headlamps need to be re-aimed, it is recommended that you take the vehicle to your dealer for service.

Bulb Replacement

For the proper type of replacement bulbs, see *Replacement Bulbs* on page 10-30.

For any bulb-changing procedure not listed in this section, contact your dealer.

Halogen Bulbs

WARNING

Halogen bulbs have pressurized gas inside and can burst if you drop or scratch the bulb. You or others could be injured. Be sure to read and follow the instructions on the bulb package.

High Intensity Discharge (HID) Lighting

WARNING

The low beam high intensity discharge lighting system operates at a very high voltage. If you try to service any of the system components, you could be seriously injured. Have your dealer or a qualified technician service them.

After an HID headlamp bulb has been replaced, the beam might be a slightly different shade than it was originally. This is normal.

Taillamps, Turn Signal, Sidemarker, and Stoplamps

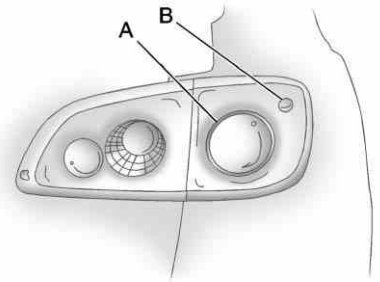

- A. Taillamp
- B. Sidemarker Lamp

To replace one of these bulbs:

1. Open the liftgate. See *Liftgate* on page 2-10.
2. Remove the black cuff from the lamp assembly by pulling rearward from the top to unfasten it from the snap tabs.

3. Remove the two hex nuts holding the taillamp assembly in place.
4. Pull out the taillamp assembly.
5. Turn the bulb socket counterclockwise and pull it straight out to remove it.
6. Replace the bulb.
7. Reverse Steps 3 through 5 to reinstall the taillamp assembly.

When reinstalling the taillamp assembly, the pin on the taillamp assembly must line up and be inserted correctly into the opening.

8. Replace the black cuff over the lamp assembly by pushing it into the snap tabs.

License Plate Lamp

To replace one of these bulbs:

1. Remove the two screws holding each of the license plate lamps to the liftgate trim.

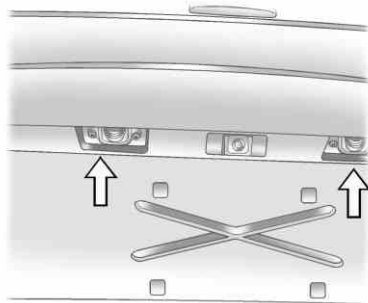

2. Turn and pull the license plate lamp forward through the liftgate trim opening.

3. Turn the bulb socket counterclockwise and pull the bulb straight out of the socket.
4. Install the new bulb.
5. Reverse Steps 1 through 3 to reinstall the license plate lamp.

Replacement Bulbs

Exterior Lamp	Bulb Number
License Plate Lamp	194LL
Rear Sidemarkers Lamp	194LL
Rear Turn Signal and Taillamps	7443 (W21/5W)

For replacement bulbs not listed here, contact your dealer.

Electrical System

High Voltage Devices and Wiring

 **WARNING**

Exposure to high voltage can cause shock, burns, and even death. The high voltage components in the vehicle can only be serviced by technicians with special training.

High voltage components are identified by labels. Do not remove, open, take apart, or modify these components. High voltage cable or wiring has orange covering. Do not probe, tamper with, cut, or modify high voltage cable or wiring.

Electrical System Overload

The vehicle has fuses and circuit breakers to protect against an electrical system overload.

When the current electrical load is too heavy, the circuit breaker opens and closes, protecting the circuit until the current load returns to normal or the problem is fixed. This greatly reduces the chance of circuit overload and fire caused by electrical problems.

Fuses and circuit breakers protect power devices in the vehicle.

Replace a bad fuse with a new one of the identical size and rating.

If there is a problem on the road and a fuse needs to be replaced, the same amperage fuse can be borrowed. Choose some feature of the vehicle that is not needed to use and replace it as soon as possible.

Headlamp Wiring

An electrical overload may cause the lamps to go on and off, or in some cases to remain off. Have the headlamp wiring checked right away if the lamps go on and off or remain off.

Windshield Wipers

If the wiper motor overheats due to heavy snow or ice, the windshield wipers will stop until the motor cools and will then restart.

Although the circuit is protected from electrical overload, overload due to heavy snow or ice may cause wiper linkage damage. Always clear ice and heavy snow from the windshield before using the windshield wipers.

If the overload is caused by an electrical problem and not snow or ice, be sure to get it fixed.

Fuses and Circuit Breakers

The wiring circuits in your vehicle are protected from short circuits by a combination of fuses, circuit breakers and fusible thermal links. This greatly reduces the chance of fires caused by electrical problems.

Look at the silver-colored band inside the fuse. If the band is broken or melted, replace the fuse. Be sure you replace a bad fuse with a new one of the identical size and rating.

Fuses of the same amperage can be temporarily borrowed from another fuse location, if a fuse goes out. Replace the fuse as soon as you can.

Engine Compartment Fuse Block

The underhood fuse block is located in the engine compartment, on the passenger side of the vehicle.

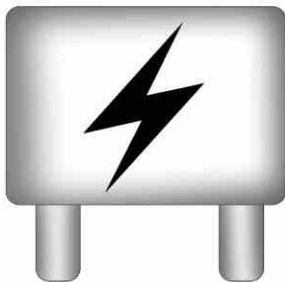

Lift the cover for access to the fuse/relay block.

Notice: Spilling liquid on any electrical component on the vehicle may damage it. Always keep the covers on any electrical component.

To remove fuses, hold the end of the fuse between your thumb and index finger and pull straight out.

10-34 Vehicle Care

Fuses	Usage
ECM	Engine Control Module
ECM 1	Engine Control Module 1
EMISSION 1	Emission 1
EMISSION 2	Emission 2
EVEN COILS	Even Injector Coils
FAN 1	Cooling Fan 1
FAN 2	Cooling Fan 2
FOG LAMP	Fog Lamps
FSCM	Fuel System Control Module
HORN	Horn
HTD MIR	Heated Outside Rearview Mirror
HUMIDITY/ MAF	Humidity Sensor/ MAF Sensor
HVAC BLWR	Heating, Ventilation and Air Conditioning Blower

Fuses	Usage
LT HI BEAM	Left High-Beam Headlamp
LT LO BEAM	Left Low-Beam Headlamp
LT PRK	Left Parking Lamp
LT TRLR STOP/TRN	Trailer Left Stoplamp and Turn Signal
ODD COILS	Odd Injector Coils
PCM IGN	Powertrain Control Module Ignition
PWR L/GATE	Power Liftgate
PWR OUTLET	Power Outlet
REAR CAMERA	Rear Vision Camera
RR APO	Rear Accessory Power Outlet
RR DEFOG	Rear Defogger
RR HVAC	Rear Climate Control System

Fuses	Usage
RT HI BEAM	Right High-Beam Headlamp
RT LO BEAM	Right Low-Beam Headlamp
RT PRK	Right Parking Lamp
RT TRLR STOP/TRN	Trailer Right Stoplamp and Turn Signal
RVC SNSR	Regulated Voltage Control Sensor
S/ROOF/ SUNSHADE	Sunroof
SERVICE	Service Repair
SPARE	Spare
STOP LAMPS (China Only)	Stoplamps (China Only)
STRTR	Starter
TCM	Transmission Control Module

Fuses	Usage
TRANS	Transmission
TRLR BCK/UP	Trailer Back-up Lamps
TRLR BRK	Trailer Brake
TRLR PRK LAMP	Trailer Parking Lamps
TRLR PWR	Trailer Power
WPR/WSW	Windshield Wiper/Washer

Relays	Usage
A/C CMPSR CLTCH	Air Conditioning Compressor Clutch
AUX VAC PUMP	Auxiliary Vacuum Pump
CRNK	Switched Power

Relays	Usage
FAN 1	Cooling Fan 1
FAN 2	Cooling Fan 2
FAN 3	Cooling Fan 3
FOG LAMP	Fog Lamps
HI BEAM	High-Beam Headlamps
HID/ LO BEAM	High Intensity Discharge (HID) Low-Beam Headlamps
HORN	Horn
IGN	Ignition Main
LT TRLR STOP/TRN	Trailer Left Stoplamp and Turn Signal Lamp
PRK LAMP	Parking Lamp
PWR/TRN	Powertrain

Relays	Usage
RR DEFOG	Rear Window Defogger
RT TRLR STOP/TRN	Trailer Right Stoplamp and Turn Signal Lamp
Stop Lamps (China Only)	Stop Lamps (China Only)
TRLR BCK/UP	Trailer Back-up Lamps
WPR	Windshield Wiper
WPR HI	Windshield Wiper High Speed

Instrument Panel Fuse Block

The instrument panel fuse block is located under the instrument panel on the passenger side of the vehicle. Pull down on the cover to access the fuse block.

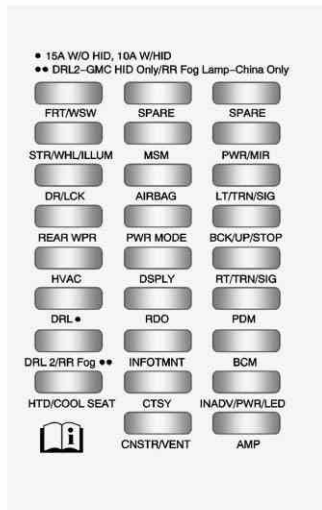

Fuse Side

The vehicle may not be equipped with all of the fuses, relays, and features shown.

Fuses	Usage
AIRBAG	Airbag
AMP	Amplifier
BCK/UP/STOP	Back-up Lamp/Stoplamp
BCM	Body Control Module
CNSTR/VENT	Canister Vent
CTSY	Courtesy Lamps
DR/LCK	Door Locks
DRL	Daytime Running Lamps
DRL 2/RR Fog	GMC HID Only (If Equipped)/ Rear Fog Lamps-China Only
DSPLY	Display
FRT/WSW	Front Windshield Washer
HTD/COOL SEAT	Heated/Cooling Seats

Fuses	Usage
HVAC	Heating, Ventilation and Air Conditioning
INADV/PWR/LED	Inadvertent Power LED
INFOTMNT	Infotainment
LT/TRN/SIG	Driver Side Turn Signal
MSM	Memory Seat Module
PDM	Power Mirrors, Liftgate Release
PWR MODE	Power Mode
PWR/MIR	Power Mirrors
RDO	Radio
REAR WPR	Rear Wiper
RT/TRN/SIG	Passenger Side Turn Signal
SPARE	Spare
STR/WHL/ILLUM	Steering Wheel Illumination

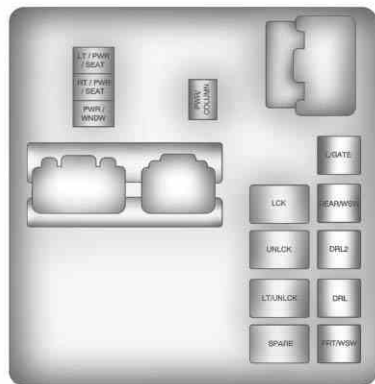

Relay Side

Relays	Usage
LT/PWR/SEAT	Driver Side Power Seat Relay
RT/PWR/SEAT	Passenger Side Power Seat Relay
PWR/WNDW	Power Windows Relay
PWR/COLUMN	Power Steering Column Relay
L/GATE	Liftgate Relay
LCK	Power Lock Relay
REAR/WSW	Rear Window Washer Relay
UNLCK	Power Unlock Relay

Relays	Usage
DRL2	Daytime Running Lamps 2 Relay (If Equipped)
LT/UNLCK	Driver Side Unlock Relay
DRL	Daytime Running Lamps Relay (If Equipped)
SPARE	Spare
FRT/WSW	Front Windshield Washer Relay

Wheels and Tires

Tires

Every new GM vehicle has high-quality tires made by a leading tire manufacturer. See the warranty manual for information regarding the tire warranty and where to get service. For additional information refer to the tire manufacturer.

WARNING

- Poorly maintained and improperly used tires are dangerous.
- Overloading the tires can cause overheating as a result of too much flexing. There could be a blowout and a serious crash. See *Vehicle Load Limits* on page 9-12.

(Continued)

WARNING (Continued)

- Underinflated tires pose the same danger as overloaded tires. The resulting crash could cause serious injury. Check all tires frequently to maintain the recommended pressure. Tire pressure should be checked when the tires are cold.
- Overinflated tires are more likely to be cut, punctured, or broken by a sudden impact — such as when hitting a pothole. Keep tires at the recommended pressure.
- Worn or old tires can cause a crash. If the tread is badly worn, replace them.

(Continued)

WARNING (Continued)

- Replace any tires that have been damaged by impacts with potholes, curbs, etc.
- Improperly repaired tires can cause a crash. Only the dealer or an authorized tire service center should repair, replace, dismount, and mount the tires.
- Do not spin the tires in excess of 55 km/h (35 mph) on slippery surfaces such as snow, mud, ice, etc. Excessive spinning may cause the tires to explode.

Tire Sidewall Labeling

Useful information about a tire is molded into its sidewall. The examples show a typical passenger vehicle tire and a compact spare tire sidewall.

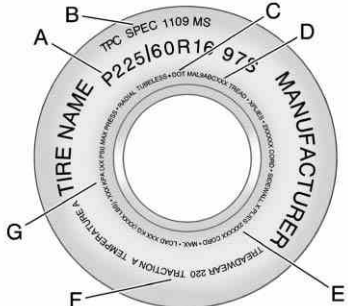

Passenger (P-Metric) Tire Example

(A) Tire Size: The tire size is a combination of letters and numbers used to define a particular tire's width, height, aspect ratio, construction type,

and service description. See the "Tire Size" illustration later in this section for more detail.

(B) TPC Spec (Tire Performance Criteria Specification): Original equipment tires designed to GM's specific tire performance criteria have a TPC specification code molded onto the sidewall. GM's TPC specifications meet or exceed all federal safety guidelines.

(C) DOT (Department of Transportation): The Department of Transportation (DOT) code indicates that the tire is in compliance with the U.S. Department of Transportation Motor Vehicle Safety Standards.

(D) Tire Identification Number (TIN): The letters and numbers following the DOT (Department of Transportation) code are the Tire Identification Number (TIN). The TIN shows the manufacturer and plant code, tire size, and date the tire was manufactured. The TIN is molded onto both sides of the tire, although only one side may have the date of manufacture.

(E) Tire Ply Material: The type of cord and number of plies in the sidewall and under the tread.

(F) Uniform Tire Quality Grading (UTQG): Tire manufacturers are required to grade tires based on three performance factors: treadwear, traction, and temperature resistance. For more information see *Uniform Tire Quality Grading on page 10-56*.

(G) Maximum Cold Inflation

Load Limit: Maximum load that can be carried and the maximum pressure needed to support that load.

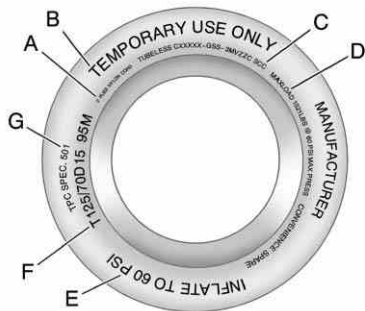

Compact Spare Tire Example

(A) Tire Ply Material: The type of cord and number of plies in the sidewall and under the tread.

(B) Temporary Use Only:

The compact spare tire or temporary use tire has a tread life of approximately 5 000 km (3,000 mi) and should not be driven at speeds over 105 km/h (65 mph). The compact spare tire is for emergency use when a regular road tire has lost air and gone flat. If the vehicle has a compact spare tire, see *Compact Spare Tire on page 10-78* and *If a Tire Goes Flat on page 10-60*.

(C) Tire Identification

Number (TIN): The letters and numbers following the DOT (Department of Transportation) code are the Tire Identification Number (TIN). The TIN shows

the manufacturer and plant code, tire size, and date the tire was manufactured. The TIN is molded onto both sides of the tire, although only one side may have the date of manufacture.

(D) Maximum Cold Inflation

Load Limit: Maximum load that can be carried and the maximum pressure needed to support that load.

(E) Tire Inflation: The temporary use tire or compact spare tire should be inflated to 420 kPa (60 psi). For more information on tire pressure and inflation see *Tire Pressure on page 10-45*.

(F) Tire Size: A combination of letters and numbers define a tire's width, height, aspect ratio, construction type, and service description. The letter T as the first character in the tire size means the tire is for temporary use only.

(G) TPC Spec (Tire Performance Criteria Specification): Original equipment tires designed to GM's specific tire performance criteria have a TPC specification code molded onto the sidewall. GM's TPC specifications meet or exceed all federal safety guidelines.

Tire Designations

Tire Size

The following is an example of a typical passenger vehicle tire size.

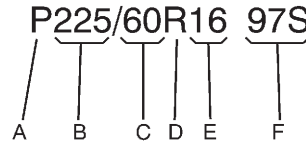

(A) Passenger (P-Metric) Tire:

The United States version of a metric tire sizing system. The letter P as the first character in the tire size means a passenger vehicle tire engineered to standards set by the U.S. Tire and Rim Association.

(B) Tire Width: The three-digit number indicates the tire section width in millimeters from sidewall to sidewall.

(C) Aspect Ratio: A two-digit number that indicates the tire height-to-width measurements. For example, if the tire size aspect ratio is 60, as shown in item C of the illustration, it would mean that the tire's sidewall is 60 percent as high as it is wide.

(D) Construction Code: A letter code is used to indicate the type of ply construction in the tire. The letter R means radial ply construction; the letter D means diagonal or bias ply construction; and the letter B means belted-bias ply construction.

(E) Rim Diameter: Diameter of the wheel in inches.

(F) Service Description: These characters represent the load index and speed rating of the tire. The load index represents the load carrying capacity a tire is certified to carry. The speed rating is the maximum speed a tire is certified to carry a load.

Tire Terminology and Definitions

Air Pressure: The amount of air inside the tire pressing outward on each square inch of the tire. Air pressure is expressed in kPa (kilopascal) or psi (pounds per square inch).

Accessory Weight: The combined weight of optional accessories. Some examples of optional accessories are automatic transmission, power steering, power brakes, power windows, power seats, and air conditioning.

Aspect Ratio: The relationship of a tire's height to its width.

Belt: A rubber coated layer of cords that is located between the plies and the tread. Cords may be made from steel or other reinforcing materials.

Bead: The tire bead contains steel wires wrapped by steel cords that hold the tire onto the rim.

Bias Ply Tire: A pneumatic tire in which the plies are laid at alternate angles less than 90 degrees to the centerline of the tread.

Cold Tire Pressure: The amount of air pressure in a tire, measured in kPa (kilopascal) or psi (pounds per square inch) before a tire has built up heat from driving. See *Tire Pressure on page 10-45*.

Curb Weight: The weight of a motor vehicle with standard and optional equipment including the maximum capacity of fuel, oil, and coolant, but without passengers and cargo.

DOT Markings: A code molded into the sidewall of a tire signifying that the tire is in compliance with the U.S. Department of Transportation (DOT) Motor Vehicle Safety Standards. The DOT code includes the Tire Identification Number (TIN), an alphanumeric designator which can also identify the tire manufacturer, production plant, brand, and date of production.

GVWR: Gross Vehicle Weight Rating. See *Vehicle Load Limits on page 9-12*.

GAWR FRT: Gross Axle Weight Rating for the front axle. See *Vehicle Load Limits on page 9-12*.

GAWR RR: Gross Axle Weight Rating for the rear axle. See *Vehicle Load Limits on page 9-12*.

Intended Outboard Sidewall: The side of an asymmetrical tire, that must always face outward when mounted on a vehicle.

Kilopascal (kPa): The metric unit for air pressure.

Light Truck (LT-Metric) Tire: A tire used on light duty trucks and some multipurpose passenger vehicles.

Load Index: An assigned number ranging from 1 to 279 that corresponds to the load carrying capacity of a tire.

Maximum Inflation Pressure: The maximum air pressure to which a cold tire can be inflated. The maximum air pressure is molded onto the sidewall.

Maximum Load Rating: The load rating for a tire at the maximum permissible inflation pressure for that tire.

Maximum Loaded Vehicle Weight: The sum of curb weight, accessory weight, vehicle capacity weight, and production options weight.

Normal Occupant Weight: The number of occupants a vehicle is designed to seat multiplied by 68 kg (150 lbs). See *Vehicle Load Limits on page 9-12*.

Occupant Distribution: Designated seating positions.

Outward Facing Sidewall: The side of an asymmetrical tire that has a particular side that faces outward when mounted on a vehicle. The side of the tire that contains a whitewall, bears white lettering, or bears manufacturer, brand, and/or model name molding that is higher or deeper than the same moldings on the other sidewall of the tire.

Passenger (P-Metric) Tire: A tire used on passenger cars and some light duty trucks and multipurpose vehicles.

Recommended Inflation Pressure: Vehicle manufacturer's recommended tire inflation pressure as shown on the tire placard. See *Tire Pressure on page 10-45* and *Vehicle Load Limits on page 9-12*.

Radial Ply Tire: A pneumatic tire in which the ply cords that extend to the beads are laid at 90 degrees to the centerline of the tread.

Rim: A metal support for a tire and upon which the tire beads are seated.

Sidewall: The portion of a tire between the tread and the bead.

Speed Rating: An alphanumeric code assigned to a tire indicating the maximum speed at which a tire can operate.

Traction: The friction between the tire and the road surface. The amount of grip provided.

Tread: The portion of a tire that comes into contact with the road.

Treadwear Indicators: Narrow bands, sometimes called wear bars, that show across the tread of a tire when only 1.6 mm (1/16 in) of tread remains. See *When It Is Time for New Tires* on page 10-53.

UTQGS (Uniform Tire Quality Grading Standards): A tire information system that provides consumers with ratings for a tire's traction, temperature, and treadwear. Ratings are determined by tire manufacturers using government testing procedures. The ratings are molded into the sidewall of the tire. See *Uniform Tire Quality Grading* on page 10-56.

Vehicle Capacity Weight: The number of designated seating positions multiplied by 68 kg (150 lbs) plus the rated cargo load. See *Vehicle Load Limits* on page 9-12.

Vehicle Maximum Load on the Tire: Load on an individual tire due to curb weight, accessory weight, occupant weight, and cargo weight.

Vehicle Placard: A label permanently attached to a vehicle showing the vehicle capacity weight and the original equipment tire size and recommended inflation pressure. See "Tire and Loading Information Label" under *Vehicle Load Limits* on page 9-12.

Tire Pressure

Tires need the correct amount of air pressure to operate effectively.

Notice: Neither tire underinflation nor overinflation is good. Underinflated tires, or tires that do not have enough air, can result in:

- Tire overloading and overheating which could lead to a blowout.
- Premature or irregular wear.
- Poor handling.
- Reduced fuel economy.

Overinflated tires, or tires that have too much air, can result in:

- Unusual wear.
- Poor handling.
- Rough ride.
- Needless damage from road hazards.

The Tire and Loading Information label on the vehicle indicates the original equipment tires and the correct cold tire inflation pressures. The recommended pressure is the minimum air pressure needed to support the vehicle's maximum load carrying capacity.

For additional information regarding how much weight the vehicle can carry, and an example of the Tire and Loading Information label, see *Vehicle Load Limits on page 9-12*. How the vehicle is loaded affects vehicle handling and ride comfort. Never load the vehicle with more weight than it was designed to carry.

When to Check

Check the tires once a month or more. Do not forget the compact spare tire, if the vehicle has one. The compact spare should be at 420 kPa (60 psi). For additional information regarding the compact spare tire, see *Compact Spare Tire on page 10-78*.

How to Check

Use a good quality pocket-type gauge to check tire pressure. Proper tire inflation cannot be determined by looking at the tire. Check the tire inflation pressure when the tires are cold, meaning the vehicle has not been driven for at least three hours or no more than 1.6 km (1 mi).

Remove the valve cap from the tire valve stem. Press the tire gauge firmly onto the valve to get a pressure measurement.

If the cold tire inflation pressure matches the recommended pressure on the Tire and Loading Information label, no further adjustment is necessary. If the inflation pressure is low, add air until the recommended pressure is reached. If the inflation pressure is high, press on the metal stem in the center of the tire valve to release air.

Re-check the tire pressure with the tire gauge.

Return the valve caps on the valve stems to prevent leaks and keep out dirt and moisture.

Tire Pressure Monitor System

The Tire Pressure Monitor System (TPMS) uses radio and sensor technology to check tire pressure levels. The TPMS sensors monitor the air pressure in your tires and transmit tire pressure readings to a receiver located in the vehicle.

Each tire, including the spare (if provided), should be checked monthly when cold and inflated to the inflation pressure recommended by the vehicle manufacturer on the vehicle placard or tire inflation pressure label. (If your vehicle has tires of a different size than the size indicated on the vehicle placard or tire inflation pressure label, you should determine the proper tire inflation pressure for those tires.)

As an added safety feature, your vehicle has been equipped with a tire pressure monitoring system (TPMS) that illuminates a low tire pressure telltale when one or more of your tires is significantly under-inflated.

Accordingly, when the low tire pressure telltale illuminates, you should stop and check your tires as soon as possible, and inflate them to the proper pressure. Driving on a significantly under-inflated tire causes the tire to overheat and can lead to tire failure. Under-inflation also reduces fuel efficiency and tire tread life, and may affect the vehicle's handling and stopping ability.

Please note that the TPMS is not a substitute for proper tire maintenance, and it is the driver's responsibility to maintain correct tire pressure, even if under-inflation has not reached the level to trigger illumination of the TPMS low tire pressure telltale.

Your vehicle has also been equipped with a TPMS malfunction indicator to indicate when the system is not operating properly. The TPMS malfunction indicator is combined with the low tire pressure telltale. When the system detects a malfunction, the telltale will flash for approximately one minute and then remain continuously illuminated. This sequence will continue upon subsequent vehicle start-ups as long as the malfunction exists.

When the malfunction indicator is illuminated, the system may not be able to detect or signal low tire pressure as intended. TPMS malfunctions may occur for a variety of reasons, including the installation of replacement or alternate tires or wheels on the vehicle that prevent the TPMS from functioning properly.

Always check the TPMS malfunction telltale after replacing one or more tires or wheels on your vehicle to ensure that the replacement or alternate tires and wheels allow the TPMS to continue to function properly.

See *Tire Pressure Monitor Operation* on page 10-48 for additional information.

Federal Communications Commission (FCC) Rules and with Industry Canada Standards

See *Radio Frequency Statement* on page 13-23 for information regarding Part 15 of the Federal Communications Commission (FCC) Rules and with Industry Canada Standards RSS-GEN/210/220/310.

Tire Pressure Monitor Operation

This vehicle may have a Tire Pressure Monitor System (TPMS). The TPMS is designed to warn the driver when a low tire pressure condition exists. TPMS sensors are mounted onto each tire and wheel assembly, excluding the spare tire and wheel assembly, if the vehicle has one. The TPMS sensors monitor the air pressure in the tires and transmits the tire pressure readings to a receiver located in the vehicle.



When a low tire pressure condition is detected, the TPMS illuminates the low tire pressure warning light located on the instrument cluster. If the warning light comes on, stop as soon as possible and inflate the tires to the recommended pressure shown on the tire loading information label. See *Vehicle Load Limits* on page 9-12.

A message to check the pressure in a specific tire displays in the Driver Information Center (DIC). The low tire pressure warning light and the DIC warning message come on at each ignition cycle until the tires are inflated to the correct inflation pressure. Using the DIC, tire pressure levels can be viewed. For additional information and details about the DIC operation and displays see *Driver Information Center (DIC)* on page 5-27 and *Tire Messages* on page 5-38.

The low tire pressure warning light may come on in cool weather when the vehicle is first started, and then turn off as the vehicle is driven. This could be an early indicator that the air pressure is getting low and needs to be inflated to the proper pressure.

A Tire and Loading Information label shows the size of the original equipment tires and the correct inflation pressure for the tires when they are cold. See *Vehicle Load Limits on page 9-12*, for an example of the Tire and Loading Information label and its location. Also see *Tire Pressure on page 10-45*.

The TPMS can warn about a low tire pressure condition but it does not replace normal tire maintenance. See *Tire Inspection on page 10-52*, *Tire Rotation on page 10-52* and *Tires on page 10-38*.

Notice: Tire sealant materials are not all the same. A non-approved tire sealant could damage the TPMS sensors. TPMS sensor damage caused by using an incorrect tire sealant is not covered by the vehicle warranty. Always use only the GM-approved tire sealant available through your dealer or included in the vehicle.

Factory-installed Tire Inflator Kits use a GM approved liquid tire sealant. Using non-approved tire sealants could damage the TPMS sensors. See *Tire Sealant and Compressor Kit on page 10-62* for information regarding the inflator kit materials and instructions.

TPMS Malfunction Light and Message

The TPMS will not function properly if one or more of the TPMS sensors are missing or inoperable. When the system detects a malfunction, the low tire warning light flashes for about one minute and then stays on for the remainder of the ignition cycle. A DIC warning message also displays. The malfunction light and DIC warning message come on at each ignition cycle until the problem is corrected. Some of the conditions that can cause these to come on are:

- One of the road tires has been replaced with the spare tire. The spare tire does not have a TPMS sensor. The malfunction light and DIC message should go off after the road tire is replaced and the sensor matching process is performed successfully. See "TPMS Sensor Matching Process" later in this section.

- The TPMS sensor matching process was not done or not completed successfully after rotating the tires. The malfunction light and the DIC message should go off after successfully completing the sensor matching process. See "TPMS Sensor Matching Process" later in this section
- One or more TPMS sensors are missing or damaged. The malfunction light and the DIC message should go off when the TPMS sensors are installed and the sensor matching process is performed successfully. See your dealer for service.

- Replacement tires or wheels do not match the original equipment tires or wheels. Tires and wheels other than those recommended could prevent the TPMS from functioning properly. See *Buying New Tires on page 10-54*.
- Operating electronic devices or being near facilities using radio wave frequencies similar to the TPMS could cause the TPMS sensors to malfunction.

If the TPMS is not functioning properly, it cannot detect or signal a low tire condition. See your dealer for service if the TPMS malfunction light and DIC message comes on and stays on.

TPMS Sensor Matching Process

Each TPMS sensor has a unique identification code. The identification code needs to be matched to a new tire/wheel position after rotating the tires or replacing one or more of the TPMS sensors. The TPMS sensor matching process should also be performed after replacing a spare tire with a road tire containing the TPMS sensor. The malfunction light and the DIC message should go off at the next ignition cycle. The sensors are matched to the tire/wheel positions, using a TPMS relearn tool, in the following order: driver side front tire, passenger side front tire, passenger side rear tire, and driver side rear. See your dealer for service or to purchase a relearn tool.

There are two minutes to match the first tire/wheel position, and five minutes overall to match all four tire/wheel positions. If it takes longer, the matching process stops and must be restarted.

The TPMS sensor matching process is:

1. Set the parking brake.
2. Turn the ignition to ON/RUN with the engine off.
3. Press the Remote Keyless Entry (RKE) transmitter's LOCK and UNLOCK buttons at the same time for approximately five seconds. The horn sounds twice to signal the receiver is in relearn mode and TIRE LEARNING ACTIVE message displays on the DIC screen.

4. Start with the driver side front tire.
5. Place the relearn tool against the tire sidewall, near the valve stem. Then press the button to activate the TPMS sensor. A horn chirp confirms that the sensor identification code has been matched to this tire and wheel position.
6. Proceed to the passenger side front tire, and repeat the procedure in Step 5.
7. Proceed to the passenger side rear tire, and repeat the procedure in Step 5.
8. Proceed to the driver side rear tire, and repeat the procedure in Step 5. The horn sounds two times to indicate the sensor identification code has been matched to the driver side rear tire, and the TPMS sensor matching process is no longer active. The TIRE LEARNING ACTIVE message on the DIC display screen goes off.
9. Turn the ignition to LOCK/OFF.
10. Set all four tires to the recommended air pressure level as indicated on the Tire and Loading Information label.

Tire Inspection

We recommend that the tires, including the spare tire, if the vehicle has one, be inspected for signs of wear or damage at least once a month.

Replace the tire if:

- The indicators at three or more places around the tire can be seen.
- There is cord or fabric showing through the tire's rubber.
- The tread or sidewall is cracked, cut, or snagged deep enough to show cord or fabric.
- The tire has a bump, bulge, or split.

- The tire has a puncture, cut, or other damage that cannot be repaired well because of the size or location of the damage.

Tire Rotation

Tires should be rotated every 12 000 km (7,500 mi). See *Maintenance Schedule on page 11-2*.

Tires are rotated to achieve a uniform wear for all tires. The first rotation is the most important.

Any time unusual wear is noticed, rotate the tires as soon as possible and check the wheel alignment. Also check for damaged tires or wheels. See *When It Is Time for New Tires on page 10-53* and *Wheel Replacement on page 10-58*.

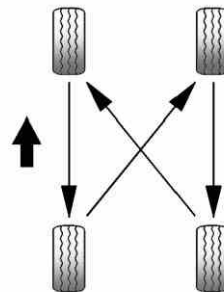

Use this rotation pattern when rotating the tires.

If the vehicle has a compact spare tire, do not include it in the tire rotation.

Adjust the front and rear tires to the recommended inflation pressure on the Tire and Loading Information label after the tires have been rotated. See *Tire Pressure on page 10-45* and *Vehicle Load Limits on page 9-12*.

Reset the Tire Pressure Monitor System. See *Tire Pressure Monitor Operation on page 10-48*.

Check that all wheel nuts are properly tightened. See “Wheel Nut Torque” under *Capacities and Specifications on page 12-2*.

⚠ WARNING

Rust or dirt on a wheel, or on the parts to which it is fastened, can make wheel nuts become loose after time. The wheel could come off and cause an accident. When changing a wheel, remove any rust or dirt from places where the wheel attaches to the vehicle. In an emergency, a cloth or a paper towel can be used; however, use a scraper or wire brush later to remove all rust or dirt.

Lightly coat the center of the wheel hub with wheel bearing grease after a wheel change or tire rotation to prevent corrosion or rust build-up. Do not get grease on the flat wheel mounting surface or on the wheel nuts or bolts.

Check that the spare tire, if the vehicle has one, is stored properly. Push, pull, and then try to rotate or turn the tire. If it moves, tighten the cable. See *Tire Changing on page 10-69*.

When It Is Time for New Tires

Factors such as maintenance, temperatures, driving speeds, vehicle loading, and road conditions affect the wear rate of the tires.

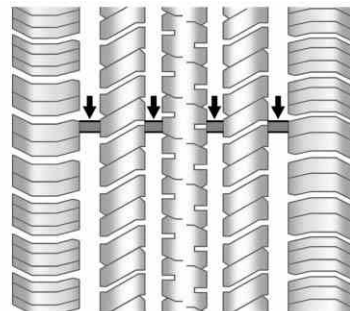

Treadwear indicators are one way to tell when it is time for new tires. Treadwear indicators appear when the tires have only 1.6 mm (1/16 in) or less of tread remaining. See *Tire Inspection on page 10-52* and *Tire Rotation on page 10-52* for more information.

The rubber in tires ages over time. This also applies for the spare tire, if the vehicle has one, even if it is never used. Multiple conditions including temperatures, loading conditions, and inflation pressure maintenance affect how fast aging takes place. Tires will typically need to be replaced due to wear before they may need to be replaced due to age. Consult the tire manufacturer for more information on when tires should be replaced.

Vehicle Storage

Tires age when stored normally mounted on a parked vehicle. Park a vehicle that will be stored for at least a month in a cool, dry, clean area away from direct sunlight to slow aging. This area should be free of grease, gasoline, or other substances that can deteriorate rubber.

Parking for an extended period can cause flat spots on the tires that may result in vibrations while driving. When storing a vehicle for at least a month, remove the tires or raise the vehicle to reduce the weight from the tires.

Buying New Tires

GM has developed and matched specific tires for the vehicle. The original equipment tires installed were designed to meet General Motors Tire Performance Criteria Specification (TPC Spec) system rating. When replacement tires are needed, GM strongly recommends buying tires with the same TPC Spec rating.

GM's exclusive TPC Spec system considers over a dozen critical specifications that impact the overall performance of the vehicle, including brake system performance, ride and handling, traction control, and tire pressure monitoring performance. GM's TPC Spec number is molded onto the tire's sidewall near the tire size. If the tires have an all-season tread design, the TPC Spec number will be followed by MS for mud and snow. See *Tire Sidewall Labeling* on page 10-39 for additional information.

GM recommends replacing all the tires at the same time. Uniform tread depth on all tires will help to maintain the performance of the vehicle. Braking and handling performance may be adversely affected if all the tires are not replaced at the same time. See *Tire Inspection on page 10-52* and *Tire Rotation on page 10-52* for information on proper tire rotation.

 **WARNING**

Tires could explode during improper service. Attempting to mount or dismount a tire could cause injury or death. Only your dealer or authorized tire service center should mount or dismount the tires.

 **WARNING**

Mixing tires of different sizes, brands, or types may cause loss of control of the vehicle, resulting in a crash or other vehicle damage. Use the correct size, brand, and type of tires on all wheels.

 **WARNING**

Using bias-ply tires on the vehicle may cause the wheel rim flanges to develop cracks after many miles of driving. A tire and/or wheel could fail suddenly and cause a crash. Use only radial-ply tires with the wheels on the vehicle.

If the vehicle tires must be replaced with a tire that does not have a TPC Spec number, make sure they are the same size, load range, speed rating, and construction (radial) as the original tires.

Vehicles that have a tire pressure monitoring system could give an inaccurate low-pressure warning if non-TPC Spec rated tires are installed. See *Tire Pressure Monitor System on page 10-46*.

The Tire and Loading Information label indicates the original equipment tires on the vehicle. See *Vehicle Load Limits on page 9-12* for the label location and more information about the Tire and Loading Information label.

Different Size Tires and Wheels

If wheels or tires are installed that are a different size than the original equipment wheels and tires, vehicle performance, including its braking, ride and handling characteristics, stability, and resistance to rollover may be affected. If the vehicle has electronic systems such as antilock brakes, rollover airbags, traction control, and electronic stability control, the performance of these systems can also be affected.

WARNING

If different sized wheels are used, there may not be an acceptable level of performance and safety if tires not recommended for those wheels are selected. This increases the chance of a crash and serious injury. Only use GM specific wheel and tire systems developed for the vehicle, and have them properly installed by a GM certified technician.

See *Buying New Tires on page 10-54* and *Accessories and Modifications on page 10-3* for additional information.

Uniform Tire Quality Grading

Quality grades can be found where applicable on the tire sidewall between tread shoulder and maximum section width. For example:

Treadwear 200 Traction AA Temperature A

The following information relates to the system developed by the United States National Highway Traffic Safety Administration (NHTSA), which grades tires by treadwear, traction, and temperature performance. This applies only to vehicles sold in the United States.

The grades are molded on the sidewalls of most passenger car tires. The Uniform Tire Quality Grading (UTQG) system does not apply to deep tread, winter-type snow tires, space-saver, or temporary use spare tires, tires with nominal rim diameters of 10 to 12 inches (25 to 30 cm), or to some limited-production tires.

While the tires available on General Motors passenger cars and light trucks may vary with respect to these grades, they must also conform to federal safety requirements and additional General Motors Tire Performance Criteria (TPC) standards.

All Passenger Car Tires Must Conform to Federal Safety Requirements In Addition To These Grades.

Treadwear

The treadwear grade is a comparative rating based on the wear rate of the tire when tested under controlled conditions on a specified government test course. For example, a tire graded 150 would wear one and a half (1½) times as well on the government course as a tire graded 100. The relative performance of tires depends upon the actual conditions of their use, however, and may depart significantly from the norm due to variations in driving habits, service practices and differences in road characteristics and climate.

Traction – AA, A, B, C

The traction grades, from highest to lowest, are AA, A, B, and C. Those grades represent the tire's ability to stop on wet pavement as measured under controlled conditions on specified government test surfaces of asphalt and concrete. A tire marked C may have poor traction performance. Warning: The traction grade assigned to this tire is based on straight-ahead braking traction tests, and does not include acceleration, cornering, hydroplaning, or peak traction characteristics.

Temperature – A, B, C

The temperature grades are A (the highest), B, and C, representing the tire's resistance to the generation of heat and its ability to dissipate heat when tested under controlled conditions on a specified indoor laboratory test wheel. Sustained high temperature can cause the material of the tire to degenerate and reduce tire life, and excessive temperature can lead to sudden tire failure. The grade C corresponds to a level of performance which all passenger car tires must meet under the Federal Motor Safety Standard No. 109. Grades B and A represent higher levels of performance on the laboratory test wheel than the minimum required by law. Warning: The

temperature grade for this tire is established for a tire that is properly inflated and not overloaded. Excessive speed, underinflation, or excessive loading, either separately or in combination, can cause heat buildup and possible tire failure.

Wheel Alignment and Tire Balance

The tires and wheels were aligned and balanced at the factory to provide the longest tire life and best overall performance. Adjustments to wheel alignment and tire balancing will not be necessary on a regular basis. However, check the alignment if there is unusual tire wear or if the vehicle is pulling to one side or the other. If the vehicle vibrates when driving on a smooth road, the tires and wheels might need to be rebalanced. See your dealer for proper diagnosis.

Wheel Replacement

Replace any wheel that is bent, cracked, or badly rusted or corroded. If wheel nuts keep coming loose, the wheel, wheel bolts, and wheel nuts should be replaced. If the wheel leaks air, replace it. Some aluminum wheels can be repaired. See your dealer if any of these conditions exist.

Your dealer will know the kind of wheel that is needed.

Each new wheel should have the same load-carrying capacity, diameter, width, offset, and be mounted the same way as the one it replaces.

Replace wheels, wheel bolts, wheel nuts, or Tire Pressure Monitor System (TPMS) sensors with new GM original equipment parts.

 **WARNING**

Using the wrong replacement wheels, wheel bolts, or wheel nuts can be dangerous. It could affect the braking and handling of the vehicle. Tires can lose air, and cause loss of control, causing a crash. Always use the correct wheel, wheel bolts, and wheel nuts for replacement.

Notice: The wrong wheel can also cause problems with bearing life, brake cooling, speedometer or odometer calibration, headlamp aim, bumper height, vehicle ground clearance, and tire or tire chain clearance to the body and chassis.

See *If a Tire Goes Flat* on page 10-60 for more information.

Used Replacement Wheels **WARNING**

Replacing a wheel with a used one is dangerous. How it has been used or how far it has been driven may be unknown. It could fail suddenly and cause a crash. When replacing wheels, use a new GM original equipment wheel.

Tire Chains **WARNING**

Do not use tire chains. There is not enough clearance. Tire chains used on a vehicle without the proper amount of clearance can cause damage to the brakes, suspension, or other vehicle

(Continued)

WARNING (Continued)

parts. The area damaged by the tire chains could cause loss of control and a crash.

Use another type of traction device only if its manufacturer recommends it for the vehicle's tire size combination and road conditions. Follow that manufacturer's instructions. To avoid vehicle damage, drive slow and readjust or remove the traction device if it contacts the vehicle. Do not spin the wheels. If traction devices are used, install them on the front tires.

If a Tire Goes Flat

It is unusual for a tire to blow out, especially if the tires are maintained properly. See *Tires* on page 10-38. If air goes out of a tire, it is much more likely to leak out slowly. But if there is ever a blowout, here are a few tips about what to expect and what to do:

If a front tire fails, the flat tire creates a drag that pulls the vehicle toward that side. Take your foot off the accelerator pedal and grip the steering wheel firmly. Steer to maintain lane position, and then gently brake to a stop, well off the road, if possible.

A rear blowout, particularly on a curve, acts much like a skid and may require the same correction as

used in a skid. Stop pressing the accelerator pedal and steer to straighten the vehicle. It may be very bumpy and noisy. Gently brake to a stop, well off the road, if possible.

WARNING

Driving on a flat tire will cause permanent damage to the tire. Re-inflating a tire after it has been driven on while severely underinflated or flat may cause a blowout and a serious crash. Never attempt to re-inflate a tire that has been driven on while severely underinflated or flat. Have your dealer or an authorized tire service center repair or replace the flat tire as soon as possible.

WARNING

Lifting a vehicle and getting under it to do maintenance or repairs is dangerous without the appropriate safety equipment and training. If a jack is provided with the vehicle, it is designed only for changing a flat tire. If it is used for anything else, you or others could be badly injured or killed if the vehicle slips off the jack. If a jack is provided with the vehicle, only use it for changing a flat tire.

If a tire goes flat, avoid further tire and wheel damage by driving slowly to a level place, well off the road, if possible. Turn on the hazard warning flashers. See *Hazard Warning Flashers* on page 6-4.

⚠ WARNING

Changing a tire can be dangerous. The vehicle can slip off the jack and roll over or fall causing injury or death. Find a level place to change the tire. To help prevent the vehicle from moving:

1. Set the parking brake firmly.
2. Put an automatic transmission in P (Park) or a manual transmission in 1 (First) or R (Reverse).
3. Turn off the engine and do not restart while the vehicle is raised.

(Continued)

WARNING (Continued)

4. Do not allow passengers to remain in the vehicle.
5. Place wheel blocks on both sides of the tire at the opposite corner of the tire being changed.

This vehicle may come with a jack and spare tire or a tire sealant and compressor kit. To use the jacking equipment to change a spare tire safely, follow the instructions below. Then see *Tire Changing on page 10-69*. To use the tire sealant and compressor kit, see *Tire Sealant and Compressor Kit on page 10-62*.

When the vehicle has a flat tire (B), use the following example as a guide to assist you in the placement of wheel blocks (A).

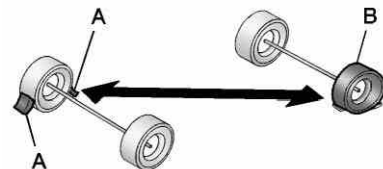

A. Wheel Block

B. Flat Tire

The following information explains how to repair or change a tire.

Tire Sealant and Compressor Kit

 **WARNING**

Idling a vehicle in an enclosed area with poor ventilation is dangerous. Engine exhaust may enter the vehicle. Engine exhaust contains carbon monoxide (CO) which cannot be seen or smelled. It can cause unconsciousness and even death. Never run the engine in an enclosed area that has no fresh air ventilation. For more information, see *Engine Exhaust* on page 9-24.

 **WARNING**

Overinflating a tire could cause the tire to rupture and you or others could be injured. Be sure to read and follow the tire sealant and compressor kit instructions and inflate the tire to its recommended pressure. Do not exceed the recommended pressure.

 **WARNING**

Storing the tire sealant and compressor kit or other equipment in the passenger compartment of the vehicle could cause injury. In a sudden stop or collision, loose equipment could strike someone. Store the tire sealant and compressor kit in its original location.

If this vehicle has a tire sealant and compressor kit, there may not be a spare tire and tire changing equipment, and on some vehicles there may not be a place to store a tire.

The tire sealant and compressor can be used to temporarily seal punctures up to 6 mm (¼ in) in the tread area of the tire. It can also be used to inflate an underinflated tire.

If the tire has been separated from the wheel, has damaged sidewalls, or has a large puncture, the tire is too severely damaged for the tire sealant and compressor kit to be effective. See *Roadside Assistance Program (U.S. and Canada)* on page 13-8 or *Roadside Assistance Program (Mexico)* on page 13-10.

Read and follow all of the tire sealant and compressor kit instructions.

The kit includes:

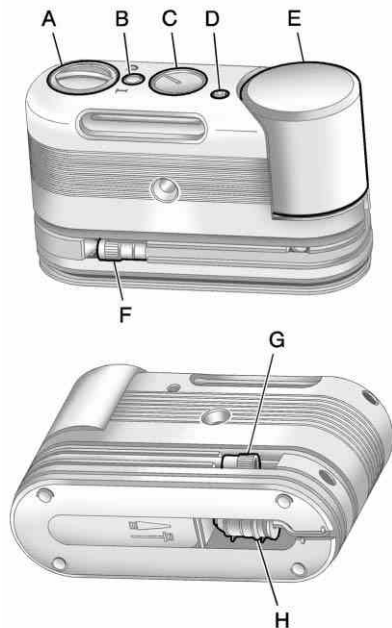

- A. Selector Switch (Sealant/Air or Air Only)
- B. On/Off Button
- C. Pressure Gauge
- D. Pressure Deflation Button (If equipped)
- E. Tire Sealant Canister
- F. Sealant/Air Hose (Clear)
- G. Air Only Hose (Black)
- H. Power Plug

Tire Sealant

Read and follow the safe handling instructions on the label adhered to the sealant canister.

Check the tire sealant expiration date on the sealant canister. The sealant canister should be replaced before its expiration date.

Replacement sealant canisters are available at your local dealer. See "Removal and Installation of the Sealant Canister" following.

There is only enough sealant to seal one tire. After usage, the sealant canister and sealant/air hose assembly must be replaced. See "Removal and Installation of the Sealant Canister" following.

Using the Tire Sealant and Compressor Kit to Temporarily Seal and Inflate a Punctured Tire

Follow the directions closely for correct sealant usage.

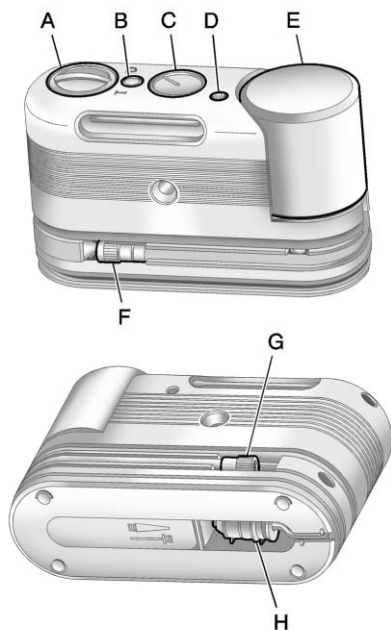

When using the tire sealant and compressor kit during cold temperatures, warm the kit in a heated environment for five minutes. This will help to inflate the tire faster.

If a tire goes flat, avoid further tire and wheel damage by driving slowly to a level place. Turn on the hazard warning flashers. See *Hazard Warning Flashers* on page 6-4.

See *If a Tire Goes Flat* on page 10-60 for other important safety warnings.

Do not remove any objects that have penetrated the tire.

1. Remove the tire sealant and compressor kit from its storage location. See *Storing the Tire Sealant and Compressor Kit* on page 10-69.
2. Unwrap the sealant/air hose (F) and the power plug (H).

3. Place the kit on the ground.
Make sure the tire valve stem is positioned close to the ground so the hose will reach it.
4. Remove the valve stem cap from the flat tire by turning it counterclockwise.
5. Attach the sealant/air hose (F) onto the tire valve stem. Turn it clockwise until it is tight.
6. Plug the power plug (H) into the accessory power outlet in the vehicle. Unplug all items from other accessory power outlets. See *Power Outlets* on page 5-10.

If the vehicle has an accessory power outlet, do not use the cigarette lighter.

If the vehicle only has a cigarette lighter, use the cigarette lighter.

Do not pinch the power plug cord in the door or window.

7. Start the vehicle. The vehicle must be running while using the air compressor.
8. Turn the selector switch (A) counterclockwise to the Sealant + Air position.
9. Press the on/off button (B) to turn the tire sealant and compressor kit on.

The compressor will inject sealant and air into the tire.

The pressure gauge (C) will initially show a high pressure while the compressor pushes the sealant into the tire. Once the sealant is completely dispersed into the tire, the pressure will quickly drop and start to rise again as the tire inflates with air only.

10. Inflate the tire to the recommended inflation pressure using the pressure gauge (C). The recommended inflation pressure can be found

on the Tire and Loading Information label. See *Tire Pressure* on page 10-45.

The pressure gauge (C) may read higher than the actual tire pressure while the compressor is on. Turn the compressor off to get an accurate pressure reading. The compressor may be turned on/off until the correct pressure is reached.

Notice: If the recommended pressure cannot be reached after approximately 25 minutes, the vehicle should not be driven farther. The tire is too severely damaged and the tire sealant and compressor kit cannot inflate the tire. Remove the power plug from the accessory power outlet and unscrew the inflating hose from the tire valve. See *Roadside Assistance Program (U.S. and Canada)* on page 13-8 or *Roadside Assistance Program (Mexico)* on page 13-10.

11. Press the on/off button (B) to turn the tire sealant and compressor kit off.
The tire is not sealed and will continue to leak air until the vehicle is driven and the sealant is distributed in the tire; therefore, Steps 12 through 18 must be done immediately after Step 11.
Be careful while handling the tire sealant and compressor kit as it could be warm after usage.
12. Unplug the power plug (H) from the accessory power outlet in the vehicle.
13. Turn the sealant/air hose (F) counterclockwise to remove it from the tire valve stem.
14. Replace the tire valve stem cap.
15. Replace the sealant/air hose (F), and the power plug (H) back in their original location.



16. If the flat tire was able to inflate to the recommended inflation pressure, remove the maximum speed label from the sealant canister (E) and place it in a highly visible location. Do not exceed the speed on this label until the damaged tire is repaired or replaced.
17. Return the equipment to its original storage location in the vehicle.
18. Immediately drive the vehicle 8 km (5 mi) to distribute the sealant in the tire.

19. Stop at a safe location and check the tire pressure. Refer to Steps 1 through 11 under "Using the Tire Sealant and Compressor Kit without Sealant to Inflate a Tire (Not Punctured)."

If the tire pressure has fallen more than 68 kPa (10 psi) below the recommended inflation pressure, stop driving the vehicle. The tire is too severely damaged and the tire sealant cannot seal the tire. See *Roadside Assistance Program (U.S. and Canada)* on page 13-8 or *Roadside Assistance Program (Mexico)* on page 13-10.

If the tire pressure has not dropped more than 68 kPa (10 psi) from the recommended inflation pressure, inflate the tire to the recommended inflation pressure.

20. Wipe off any sealant from the wheel, tire, and vehicle.
21. Dispose of the used sealant canister (E) and sealant/air hose (F) assembly at a local dealer or in accordance with local state codes and practices.
22. Replace it with a new canister available from your dealer.
23. After temporarily sealing a tire using the tire sealant and compressor kit, take the vehicle to an authorized dealer within a 161 km (100 mi) of driving to have the tire repaired or replaced.

Using the Tire Sealant and Compressor Kit without Sealant to Inflate a Tire (Not Punctured)

To use the air compressor to inflate a tire with air only and not sealant:

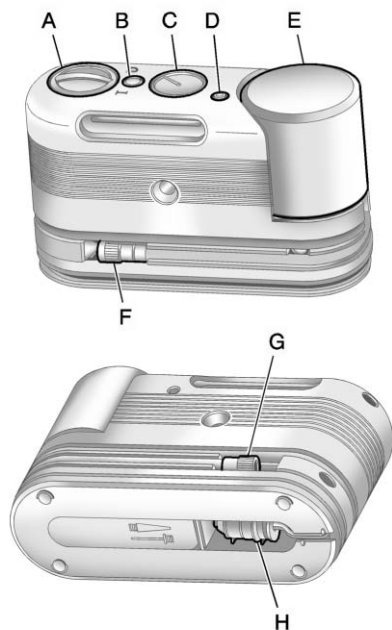

If a tire goes flat, avoid further tire and wheel damage by driving slowly to a level place. Turn on the hazard warning flashers. See *Hazard Warning Flashers* on page 6-4.

See *If a Tire Goes Flat* on page 10-60 for other important safety warnings.

1. Remove the tire sealant and compressor kit from its storage location. See *Storing the Tire Sealant and Compressor Kit* on page 10-69.
2. Unwrap the air only hose (G) and the power plug (H).
3. Place the kit on the ground.
Make sure the tire valve stem is positioned close to the ground so the hose will reach it.
4. Remove the tire valve stem cap from the flat tire by turning it counterclockwise.
5. Attach the air only hose (G) onto the tire valve stem by turning it clockwise until it is tight.

6. Plug the power plug (H) into the accessory power outlet in the vehicle. Unplug all items from other accessory power outlets. See *Power Outlets* on page 5-10.

If the vehicle has an accessory power outlet, do not use the cigarette lighter.

If the vehicle only has a cigarette lighter, use the cigarette lighter.

Do not pinch the power plug cord in the door or window.

7. Start the vehicle. The vehicle must be running while using the air compressor.
8. Turn the selector switch (A) clockwise to the Air Only position.
9. Press the on/off (B) button to turn the compressor on.
The compressor will inflate the tire with air only.

10-68 Vehicle Care

- Inflate the tire to the recommended inflation pressure using the pressure gauge (C). The recommended inflation pressure can be found on the Tire and Loading Information label. See *Tire Pressure* on page 10-45.

The pressure gauge (C) may read higher than the actual tire pressure while the compressor is on. Turn the compressor off to get an accurate reading. The compressor may be turned on/off until the correct pressure is reached.

If you inflate the tire higher than the recommended pressure you can adjust the excess pressure by pressing the pressure deflation button (D), if equipped, until the proper pressure reading is reached. This option is only functional when using the air only hose (G).

- Press the on/off button (B) to turn the tire sealant and compressor kit off.

Be careful while handling the tire sealant and compressor kit as it could be warm after usage.
- Unplug the power plug (H) from the accessory power outlet in the vehicle.
- Disconnect the air only hose (G) from the tire valve stem by turning it counterclockwise, and replace the tire valve stem cap.
- Replace the air only hose (G) and the power plug (H) and cord back in their original locations.
- Place the equipment in the original storage location in the vehicle.

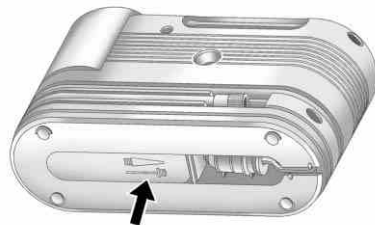

The tire sealant and compressor kit has an accessory adapter located in a compartment on the bottom of its housing that may be used to inflate air mattresses, balls, etc.

Removal and Installation of the Sealant Canister

To remove the sealant canister:

1. Unwrap the sealant hose.
2. Press the canister release button.
3. Pull up and remove the canister.
4. Replace with a new canister which is available from your dealer.
5. Push the new canister into place.

Storing the Tire Sealant and Compressor Kit

The tire sealant and compressor kit is located in the storage compartment on the driver side, at the rear of the vehicle.

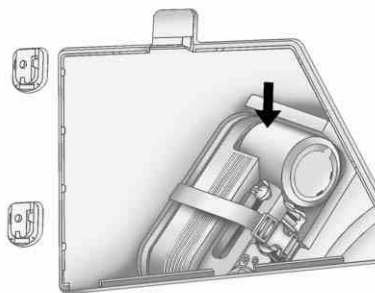

1. Press down on the latch tab and pull the cover off to access the storage compartment.

2. Press the two tabs on the quick release buckle to release the tire sealant and compressor kit strap.
3. Remove the sealant and compressor kit from its tray.

To store the tire sealant and compressor kit, reverse the steps.

Tire Changing

Removing Tools

The tools needed to remove the spare tire are located in the storage compartment on the driver side, at the rear of the vehicle.

1. Open the jack storage compartment by pulling on the latch tab, located toward the rear of the vehicle, and pulling the cover off.

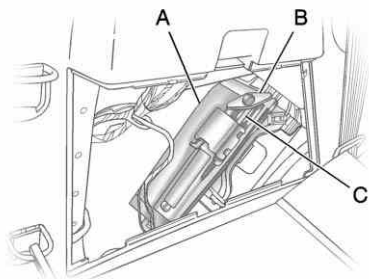

- A. Tool Bag
- B. Wing Bolt
- C. Jack

2. Remove the wing bolt (B) by turning it counterclockwise.
3. Push the jack (C) up out of the holding bracket and remove the tool bag (A).

4. Turn the jack on its side, with the bottom facing toward you.
5. Pull the jack straight out, bottom first.

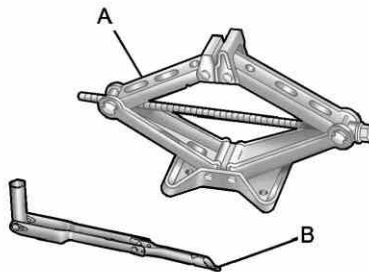

- A. Jack
- B. Wrench (Three-Piece Shown, One-Piece Similar)

The tools you will be using include the jack (A) and wrench (B).

Removing the Spare Tire

The compact spare tire is located under the vehicle, in front of the rear bumper. See *Compact Spare Tire* on page 10-78 for more information.

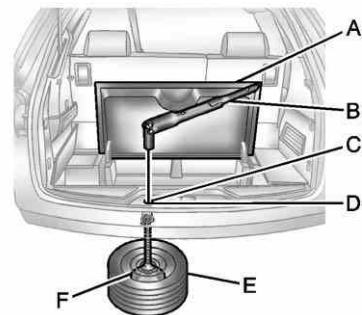

- A. Rear Convenience Center
- B. Wrench (Three-Piece Shown, One-Piece Similar)
- C. Carpet Cutout

- D. Hoist Shaft
 - E. Compact Spare Tire
 - F. Retainer
1. Open the storage compartment door of the convenience center (A) that is nearest the liftgate.
 2. Open the carpet cutout (C) that is located through the hole of the storage compartment.
 3. Attach the wrench (B) into the hoist shaft (D).
 4. Turn the wrench (B) counterclockwise to lower the spare tire (E) to the ground. Continue turning the wrench until the spare tire can be pulled out from under the vehicle.

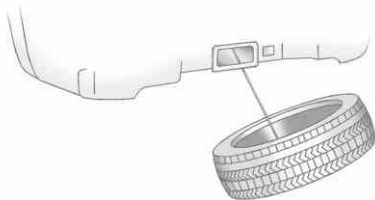

5. Tilt the retainer and slip it through the wheel opening to remove the spare tire from the cable.
6. Turn the wrench clockwise to raise the cable back up after removing the spare tire.

Do not store a full-size or a flat road tire under the vehicle. See “Storing the Spare Tire” and “Storing the Flat Tire” later in this section.

Removing the Flat Tire and Installing the Spare Tire

1. Do a safety check before proceeding. See *If a Tire Goes Flat* on page 10-60 for more information.
2. If the vehicle has a wheel cover, loosen the plastic nut caps with the wheel wrench. They will not come off. Then, using the flat end of the wheel wrench, pry along the edge of the cover until it comes off. Be careful; the edges may be sharp. Do not try to remove the cover with your bare hands.

Store the wheel cover securely in the rear of the vehicle until you have the flat tire repaired or replaced.

If the vehicle has aluminum wheels, remove the wheel nut caps using the wheel wrench.



- Loosen the wheel nuts — but do not remove them — using the wrench. For wheels with a wheel lock key, use the wheel lock key between the lock nut and wrench. The key is supplied in the front passenger door pocket.

Notice: If this vehicle has wheel locks and an impact wrench is used to remove the wheel nuts, the lock nut or wheel lock key could be damaged. Do not use an impact wrench to remove the wheel nuts if this vehicle has wheel locks.

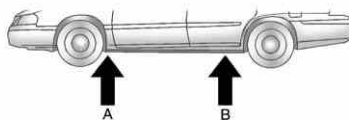

- To identify the appropriate jacking location, find the triangle (A) about 30.5 cm (12 in) from the front tire or (B) about 27 cm (10.5 in) from the rear tire.

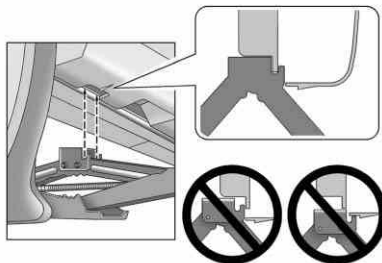

The triangle is located near each wheel on the vehicle's exterior.

Notice: If a jack is used to raise the vehicle without positioning it correctly, the vehicle could be damaged. When raising the vehicle on a jack, avoid contact with the rear axle control arms.

- Attach the wrench to the jack, and turn the wrench clockwise to raise the jack head 7.6 cm (3 in).
- Do not raise the vehicle yet. Put the compact spare tire near you.

⚠ WARNING

Getting under a vehicle when it is jacked up is dangerous. If the vehicle slips off the jack, you could be badly injured or killed. Never get under a vehicle when it is supported only by a jack.

⚠ WARNING

Raising the vehicle with the jack improperly positioned can damage the vehicle and even make the vehicle fall. To help avoid personal injury and vehicle damage, be sure to fit the jack lift head into the proper location before raising the vehicle.

7. Raise the vehicle by turning the wrench clockwise in the jack. Raise the vehicle far enough off the ground so that there is enough room for the spare tire to fit under the wheel well.
8. Remove all the wheel nuts and the flat tire.

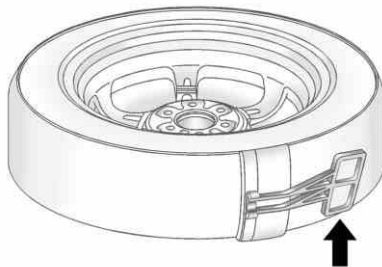

9. Remove the plastic spare tire heat shield by pulling the rubber latch. Store the plastic spare tire heat shield. See “Storing the Spare Tire” later in this section for more information.

⚠ WARNING

Rust or dirt on a wheel, or on the parts to which it is fastened, can make wheel nuts become loose after time. The wheel could come off and cause an accident. When changing a wheel, remove any rust or dirt from places where the wheel attaches to the vehicle. In an emergency, a cloth or a paper towel can be used; however, use a scraper or wire brush later to remove all rust or dirt.

⚠ WARNING

Never use oil or grease on bolts or nuts because the nuts might come loose. The vehicle's wheel could fall off, causing a crash.

10-74 Vehicle Care

10. Remove any rust or dirt from the wheel bolts, mounting surfaces, and spare wheel.
11. Place the spare tire on the wheel mounting surface.
12. Put the nuts on by hand by turning them clockwise until the wheel is held against the mounting surface. Make sure the rounded end is toward the wheel.
13. Lower the vehicle by attaching the wrench to the jack and turning the wrench counterclockwise. Lower the jack completely.

WARNING

Wheel nuts that are improperly or incorrectly tightened can cause the wheels to become loose or come off. The wheel nuts should be tightened with a torque wrench to the proper torque specification

(Continued)

WARNING (Continued)

after replacing. Follow the torque specification supplied by the aftermarket manufacturer when using accessory locking wheel nuts. See *Capacities and Specifications on page 12-2* for original equipment wheel nut torque specifications.

Notice: Improperly tightened wheel nuts can lead to brake pulsation and rotor damage. To avoid expensive brake repairs, evenly tighten the wheel nuts in the proper sequence and to the proper torque specification. See *Capacities and Specifications on page 12-2* for the wheel nut torque specification.

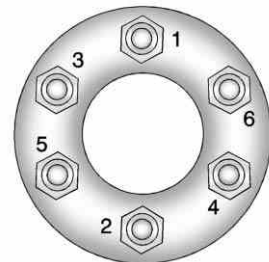

14. Tighten the wheel nuts firmly in a crisscross sequence, as shown.

Notice: Wheel covers will not fit on the vehicle's compact spare. If you try to put a wheel cover on the compact spare, the cover or the spare could be damaged.

Storing the Spare Tire

WARNING

The underbody-mounted spare tire needs to be stored with the valve stem pointing down. If the spare tire is stored with the valve stem pointing upwards, the secondary latch will not work properly and the spare tire could loosen and suddenly fall from the vehicle. If this happened when the vehicle was being driven, the tire might contact a person or another vehicle, causing injury and damage to itself. Be sure the underbody-mounted spare tire is stored with the valve stem pointing down.

WARNING

Storing a jack, a tire, or other equipment in the passenger compartment of the vehicle could cause injury. In a sudden stop or collision, loose equipment could strike someone. Store all these in the proper place.

To store the spare tire:

1. Lay the compact spare tire near the rear of the vehicle with the valve stem down.
2. Reinstall the plastic spare tire heat shield on the compact spare tire.
3. Slide the cable retainer through the center of the wheel and start to raise the compact spare tire.
Make sure the retainer is fully seated across the underside of the wheel.

4. When the compact spare tire is almost in the stored position, turn the tire so the valve is toward the rear of the vehicle.

This position helps when checking the air pressure in the compact spare tire.

5. Raise the tire fully against the underside of the vehicle. Continue turning the wrench until you feel more than two clicks. This indicates that the compact spare tire is secure and the cable is tight. The spare tire hoist cannot be overtightened.

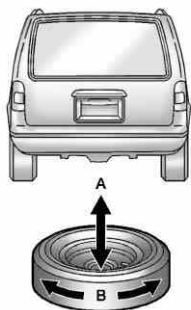

6. Make sure the tire is stored securely. Push, pull (A), and then try to turn (B) the tire. If the tire moves, use the wrench to tighten the cable.

Storing the Flat Tire

1. Remove the cable package from the jack storage area.
2. Remove the small center cap by tapping the back of the cap with the extension of the shaft, if the vehicle has aluminum wheels.
3. Put the flat tire in the rear storage area with the valve stem pointing toward the rear of the vehicle.

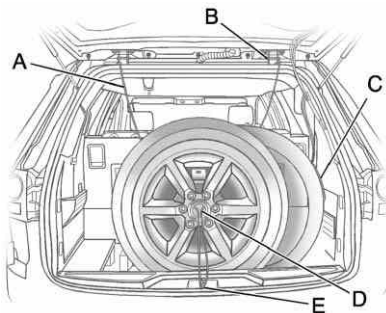

- A. Cable
- B. Liftgate Hinges

C. Spare Tire Heat Shield

D. Center of the Wheel

E. Door Striker

4. Pull the cable (A) through the door striker (E), the center of the wheel (D), and the plastic spare tire heat shield (C), as shown.

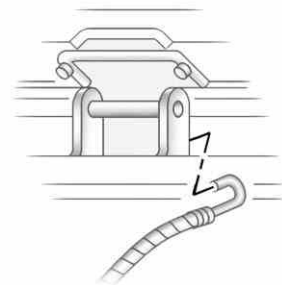

5. Hook the cable onto the outside portion of the liftgate hinges (B).
6. Hook the other end of the cable onto the outside portion of the liftgate hinge on the other side of the vehicle.

- Pull on the cable to make sure it is secure.

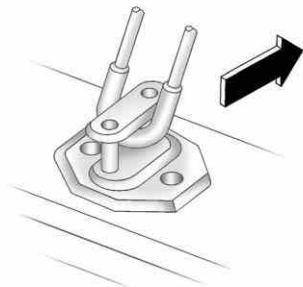

- Make sure the metal tube is centered at the striker. Push the tube toward the front of the vehicle.
- Close the liftgate and make sure it is latched properly.

Storing the Tools

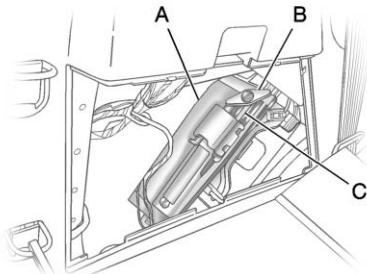

- A. Tool Bag
- B. Wing Bolt
- C. Jack

Put back all tools as they were stored in the jack storage compartment and put the compartment cover back on.

- Ensure that the bottom of the jack is facing toward you.
- Replace the tool bag (A).

- Turn the jack (C) on its side and place down on the holding bracket.
- Reinstall the wing bolt (B) by turning clockwise.
- To replace the cover, line up the tab at the front of the cover with the notch in the cover opening. Push the cover in place and make sure that the rear clips are in the slots and push the cover closed.

Store the center cap or the plastic bolt-on wheel covers until a full size tire is put back on the vehicle. When you replace the compact spare with a full-size tire, reinstall the bolt-on wheel covers or the center cap. Hand-tighten them over the wheel nuts, using the wrench.

Compact Spare Tire

 **WARNING**

Driving with more than one compact spare tire at a time could result in loss of braking and handling. This could lead to a crash and you or others could be injured. Use only one compact spare tire at a time.

The compact spare tire, if the vehicle has one, was fully inflated when the vehicle was new, however, it can lose air after a time. Check the inflation pressure regularly. It should be 420 kPa (60 psi).

After installing the compact spare on the vehicle, stop as soon as possible and make sure the spare tire is correctly inflated. The compact spare is made to perform well at speeds up to 105 km/h (65 mph) for distances up to 5 000 km (3,000 mi), so you can finish your trip and have the full-size tire repaired or replaced at your convenience. Of course, it is best to replace the spare with a full-size tire as soon as possible. The spare tire will last longer and be in good shape in case it is needed again.

Notice: When the compact spare is installed, do not take the vehicle through an automatic car wash with guide rails. The compact spare can get caught on the rails which can damage the tire, wheel, and other parts of the vehicle.

Do not use the compact spare on other vehicles.

And do not mix the compact spare tire or wheel with other wheels or tires. They will not fit. Keep the spare tire and its wheel together.

The All-Wheel Drive (AWD) system will be automatically disabled when you use the compact spare. To restore the AWD and prevent excessive wear on the clutch in your AWD, replace the compact spare tire with a full-size tire as soon as possible.

Notice: Tire chains will not fit the compact spare. Using them can damage the vehicle and can damage the chains too. Do not use tire chains on the compact spare.

Jump Starting

For more information about the vehicle battery, see *Battery* on page 10-25.

If the vehicle's battery has run down, you may want to use another vehicle and some jumper cables to start your vehicle. Be sure to use the following steps to do it safely.

WARNING

Batteries can hurt you. They can be dangerous because:

- They contain acid that can burn you.
- They contain gas that can explode or ignite.
- They contain enough electricity to burn you.

If you do not follow these steps exactly, some or all of these things can hurt you.

Notice: Ignoring these steps could result in costly damage to the vehicle that would not be covered by the warranty.

Trying to start the vehicle by pushing or pulling it will not work, and it could damage the vehicle.

1. Check the other vehicle. It must have a 12-volt battery with a negative ground system.

Notice: Only use a vehicle that has a 12-volt system with a negative ground for jump starting. If the other vehicle does not have a 12-volt system with a negative ground, both vehicles can be damaged.

2. Get the vehicles close enough so the jumper cables can reach, but be sure the vehicles are not touching each other. If they are, it could cause a ground connection you do not want.

You would not be able to start your vehicle, and the bad grounding could damage the electrical systems.

To avoid the possibility of the vehicles rolling, set the parking brake firmly on both vehicles involved in the jump start procedure. Put an automatic transmission in P (Park) or a manual transmission in Neutral before setting the parking brake. If one of the vehicles is a four-wheel-drive vehicle, be sure the transfer case is not in Neutral.

Notice: If the radio or other accessories are left on during the jump starting procedure, they could be damaged. The repairs would not be covered by the warranty. Always turn off the radio and other accessories when jump starting the vehicle.

10-80 Vehicle Care

3. Turn off the ignition on both vehicles. Unplug unnecessary accessories plugged into the cigarette lighter or the accessory power outlets. Turn off the radio and all lamps that are not needed. This will avoid sparks and help save both batteries. And it could save the radio!
4. Open the hoods and locate the positive (+) and negative (-) terminal locations on the other vehicle. Your vehicle has a remote positive (+) and a remote negative (-) jump starting terminal. See *Engine Compartment Overview on page 10-6* for more information on the terminal locations.

WARNING

Using a match near a battery can cause battery gas to explode. People have been hurt doing this, and some have been blinded. Use a flashlight if you need more light.

Be sure the batteries have enough water. You do not need to add water to the ACDelco[®] battery (or batteries) installed in your new vehicle. But if a battery has filler caps, be sure the right amount of fluid is there. If it is low, add water to take care of that first. If you do not, explosive gas could be present.

Battery fluid contains acid that can burn you. Do not get it on you. If you accidentally get it in your eyes or on your skin, flush the place with water and get medical help immediately.

WARNING

Fans or other moving engine parts can injure you badly. Keep your hands away from moving parts once the engine is running.

5. Check that the jumper cables do not have loose or missing insulation. If they do, you could get a shock. The vehicles could be damaged too.

Before you connect the cables, here are some basic things you should know. Positive (+) will go to positive (+) or to a remote positive (+) terminal if the vehicle has one. Negative (-) will go to a heavy, unpainted metal engine part or to a remote negative (-) terminal if the vehicle has one.

Do not connect positive (+) to negative (-) or you will get a short that would damage the battery and maybe other parts too. And do not connect the negative (-) cable to the negative (-) terminal on the dead battery because this can cause sparks.

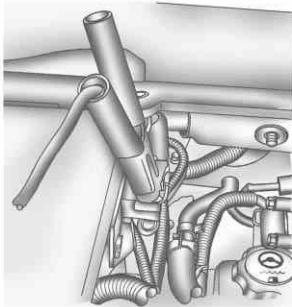

6. Connect the red positive (+) cable to the positive (+) terminal of the dead battery.

Use a remote positive (+) terminal if the vehicle has one.

7. Do not let the other end touch metal. Connect it to the positive (+) terminal of the good battery. Use a remote positive (+) terminal if the vehicle has one.

8. Now connect the black negative (-) cable to the negative (-) terminal of the good battery. Use a remote negative (-) terminal if the vehicle has one.

Do not let the other end touch anything until the next step. The other end of the negative (-) cable does not go to the dead battery. It goes to a heavy, unpainted metal engine part, or to a remote negative (-) terminal on the vehicle with the dead battery.



9. Connect the other end of the negative (-) cable to the negative (-) terminal at least 18 inches (45 cm) away from the dead battery, but not near engine parts that move.

The electrical connection is just as good there, and the chance of sparks getting back to the battery is much less.

Your vehicle has a remote negative (-) terminal for this purpose.

10. Now start the vehicle with the good battery and run the engine for a while.
11. Try to start the vehicle that had the dead battery. If it will not start after a few tries, it probably needs service.

Notice: If the jumper cables are connected or removed in the wrong order, electrical shorting may occur and damage the vehicle. The repairs would not be covered by the vehicle warranty. Always connect and remove the jumper cables in the correct order, making sure that the cables do not touch each other or other metal.

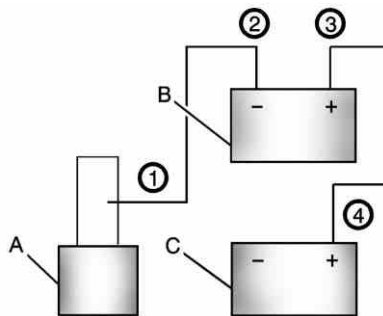

Jumper Cable Removal

- A. Heavy, Unpainted Metal Engine Part or Remote Negative (-) Terminal
- B. Good Battery or Remote Positive (+) and Remote Negative (-) Terminals
- C. Dead Battery or Remote Positive (+) Terminal

To disconnect the jumper cables from both vehicles, do the following:

1. Disconnect the black negative (-) cable from the vehicle that had the dead battery.
2. Disconnect the black negative (-) cable from the vehicle with the good battery.
3. Disconnect the red positive (+) cable from the vehicle with the good battery.
4. Disconnect the red positive (+) cable from the other vehicle.

Towing

Towing the Vehicle

Notice: To avoid damage, the disabled vehicle should be towed with all four wheels off the ground. Care must be taken with vehicles that have low ground clearance and/or special equipment. Always flatbed on a car carrier.

Consult your dealer or a professional towing service if the disabled vehicle must be towed. See *Roadside Assistance Program (U.S. and Canada)* on page 13-8 or *Roadside Assistance Program (Mexico)* on page 13-10.

To tow the vehicle behind another vehicle for recreational purposes, such as behind a motor home, see "Recreational Vehicle Towing" in this section.

Recreational Vehicle Towing

Recreational vehicle towing means towing the vehicle behind another vehicle – such as behind a motorhome. The two most common types of recreational vehicle towing are known as dinghy towing and dolly towing. Dinghy towing is towing the vehicle with all four wheels on the ground. Dolly towing is towing the vehicle with two wheels on the ground and two wheels up on a device known as a dolly.

Here are some important things to consider before recreational vehicle towing:

- What is the distance that will be travelled? Some vehicles have restrictions on how far and how long they can tow.
 - Is the proper towing equipment going to be used? See your dealer or trailering professional for additional advice and equipment recommendations.
 - Is the vehicle ready to be towed? Just as preparing the vehicle for a long trip, make sure the vehicle is prepared to be towed.
- What is the towing capacity of the towing vehicle? Be sure to read the tow vehicle manufacturer's recommendations.

Dinghy Towing

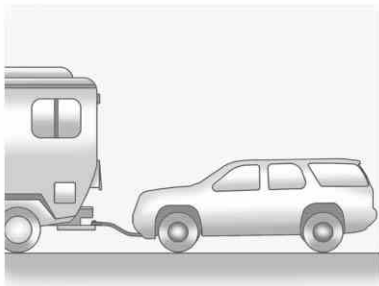

If the vehicle is front-wheel-drive, it can be dingly towed from the front. These vehicles may also be towed by putting the front wheels on a dolly. See “Dolly Towing” later in this section.

If the vehicle is all-wheel-drive, it can be dingly towed from the front. These vehicles can also be towed by placing them on a platform trailer with all four wheels off of the ground. These vehicles cannot be towed using a dolly.

For vehicles being dingly towed, the vehicle should be run at the beginning of each day and at each RV fuel stop for about five minutes. This will ensure proper lubrication of transmission components. Reinstall the fuse to start the vehicle.

To tow the vehicle from the front with all four wheels on the ground:

1. Position the vehicle to be towed, shift the transmission to P (Park), and turn the ignition to LOCK/OFF.
2. Secure the vehicle to the towing vehicle.
3. Set the parking brake.
4. Turn the ignition to ACC/ACCESSORY.
5. Shift the transmission to N (Neutral).

6. To prevent the battery from draining while the vehicle is being towed, remove the 15 amp ECM fuse and the 50 amp BATT1 fuse from the underhood fuse block and store in a safe location. See *Engine Compartment Fuse Block* on page 10-32.

7. Release the parking brake.

Notice: If the vehicle is towed without performing each of the steps listed under “Dinghy Towing,” the automatic transmission could be damaged. Be sure to follow all steps of the dinghy towing procedure prior to and after towing the vehicle.

Notice: If 105 km/h (65 mph) is exceeded while towing the vehicle, it could be damaged. Never exceed 105 km/h (65 mph) while towing the vehicle.

Once the destination is reached:

1. Set the parking brake.
2. Reinstall the fuses in the underhood fuse block.
3. Shift the transmission to P (Park), turn the ignition to LOCK/OFF and remove the key from the ignition.
4. Disconnect the vehicle from the towing vehicle.

Notice: Do not tow a vehicle with the front drive wheels on the ground if one of the front tires is a compact spare tire. Towing with two different tire sizes on the front of the vehicle can cause severe damage to the transmission.

Dolly Towing (All-Wheel-Drive Vehicles)

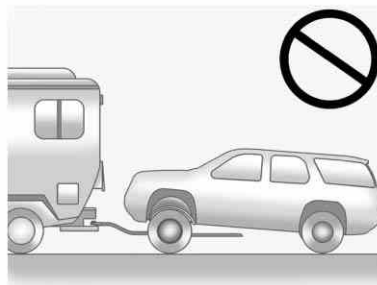

All-wheel-drive vehicles must not be towed with two wheels on the ground. To properly tow these vehicles, they should be placed on a platform trailer with all four wheels off of the ground or dinghy towed from the front.

Dolly Towing (Front-Wheel-Drive Vehicles Only)

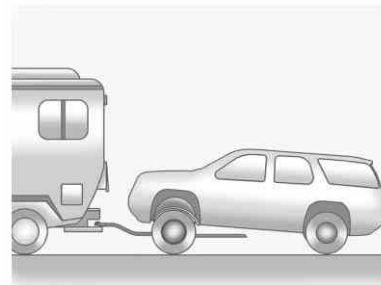

To tow a front-wheel-drive vehicle from the front with two wheels on the ground:

1. Put the front wheels on a dolly.
2. Move the shift lever to P (Park).
3. Set the parking brake.

10-86 Vehicle Care

4. Clamp the steering wheel in a straight-ahead position with a clamping device designed for towing.
5. Remove the key from the ignition.
6. Secure the vehicle to the dolly.
7. Release the parking brake.

Towing the Vehicle From the Rear

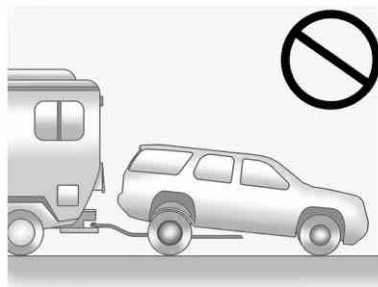
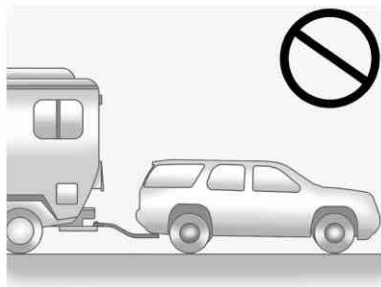

Notice: Towing the vehicle from the rear could damage it. Also, repairs would not be covered by the vehicle warranty. Never have the vehicle towed from the rear.

Do not tow the vehicle from the rear.

Appearance Care

Exterior Care

Washing the Vehicle

To preserve the vehicle's finish, wash it often and out of direct sunlight.

Notice: Do not use petroleum based, acidic, or abrasive cleaning agents as they can damage the vehicle's paint, metal, or plastic parts. If damage occurs, it would not be covered by the vehicle's warranty. Approved cleaning products can be obtained from your dealer. Follow all manufacturer directions regarding correct product usage, necessary safety precautions, and appropriate disposal of any vehicle care product.

Notice: Avoid using high pressure washes closer than 30 cm (12 in) to the surface of the vehicle. Use of power washers exceeding 8,274 kPa (1,200 psi) can result in damage or removal of paint and decals.

Rinse the vehicle well, before washing and after, to remove all cleaning agents completely. If they are allowed to dry on the surface, they could stain.

Dry the finish with a soft, clean chamois or an all-cotton towel to avoid surface scratches and water spotting.

Finish Care

Occasional hand waxing or mild polishing should be done to remove residue from the paint finish. See your dealer for approved cleaning products.

Notice: Machine compounding or aggressive polishing on a basecoat/clearcoat paint finish may damage it. Use only non-abrasive waxes and polishes that are made for a basecoat/clearcoat paint finish on the vehicle.

Foreign materials such as calcium chloride and other salts, ice melting agents, road oil and tar, tree sap, bird droppings, chemicals from industrial chimneys, etc., can damage the vehicle's finish if they remain on painted surfaces. Wash the vehicle as soon as possible. If necessary, use non-abrasive cleaners that are marked safe for painted surfaces to remove foreign matter.

To keep the paint finish looking new, keep the vehicle garaged or covered whenever possible.

Protecting Exterior Bright Metal Parts

Regularly clean bright metal parts with water or chrome polish on chrome or stainless steel trim, if necessary.

For aluminum, never use auto or chrome polish, steam, or caustic soap to clean. A coating of wax, rubbed to a high polish, is recommended for all bright metal parts.

Cleaning Exterior Lamps/Lenses and Emblems

Use only lukewarm or cold water, a soft cloth, and a car washing soap to clean exterior lamps and lenses. Follow instructions under "Washing the Vehicle" later in this section.

Windshield and Wiper Blades

Clean the outside of the windshield with glass cleaner.

Clean rubber blades using a lint-free cloth or paper towel soaked with windshield washer fluid or a mild detergent. Wash the windshield thoroughly when cleaning the blades. Bugs, road grime, sap, and a buildup of vehicle wash/wax treatments may cause wiper streaking.

Replace the wiper blades if they are worn or damaged. Damage can be caused by extreme dusty conditions, sand, salt, heat, sun, snow, and ice.

Weatherstrips

Apply silicone grease on weatherstrips to make them last longer, seal better, and not stick or squeak. See *Recommended Fluids and Lubricants* on page 11-12.

Tires

Use a stiff brush with tire cleaner to clean the tires.

Notice: Using petroleum-based tire dressing products on the vehicle may damage the paint finish and/or tires. When applying a tire dressing, always wipe off any overspray from all painted surfaces on the vehicle.

Wheels and Trim — Aluminum or Chrome

Use a soft, clean cloth with mild soap and water to clean the wheels. After rinsing thoroughly with clean water, dry with a soft, clean towel. A wax may then be applied.

Keep the wheels clean using a soft, clean cloth with mild soap and water. Rinse with clean water. After rinsing thoroughly, dry with a soft, clean towel. A wax may then be applied.

Notice: Chrome wheels and other chrome trim may be damaged if the vehicle is not washed after driving on roads that have been sprayed with magnesium, calcium, or sodium chloride. These chlorides are used on roads for conditions such as ice and dust. Always wash the chrome with soap and water after exposure.

Notice: To avoid surface damage, do not use strong soaps, chemicals, abrasive polishes, cleaners, brushes, or cleaners that contain acid on aluminum or chrome-plated wheels. Use only approved cleaners. Also, never drive a vehicle with aluminum or chrome-plated wheels through an automatic car wash that uses silicone carbide tire cleaning brushes. Damage could occur and the repairs would not be covered by the vehicle warranty.

Steering, Suspension, and Chassis Components

Visually inspect front and rear suspension and steering system for damaged, loose, or missing parts or signs of wear. Inspect power steering lines and hoses for proper hook-up, binding, leaks, cracks, chafing, etc. Visually check constant velocity joints, rubber boots, and axle seals for leaks.

Body Component Lubrication

Lubricate all key lock cylinders, hood hinges, liftgate hinges, and the steel fuel door hinge unless the components are plastic. Applying silicone grease on weatherstrips with a clean cloth will make them last longer, seal better, and not stick or squeak.

Underbody Maintenance

Use plain water to flush dirt and debris from the vehicle's underbody. Your dealer or an underbody car washing system can do this. If not removed, rust and corrosion can develop.

Sheet Metal Damage

If the vehicle is damaged and requires sheet metal repair or replacement, make sure the body repair shop applies anti-corrosion material to parts repaired or replaced to restore corrosion protection.

Original manufacturer replacement parts will provide the corrosion protection while maintaining the vehicle warranty.

Finish Damage

Quickly repair minor chips and scratches with touch-up materials available from your dealer to avoid corrosion. Larger areas of finish damage can be corrected in your dealer's body and paint shop.

Chemical Paint Spotting

Airborne pollutants can fall upon and attack painted vehicle surfaces causing blotchy, ring-shaped discolorations, and small, irregular dark spots etched into the paint surface.

Interior Care

To prevent dirt particle abrasions, regularly clean the vehicle's interior. Immediately remove any soils. Note that newspapers or dark garments that can transfer color to home furnishings can also permanently transfer color to the vehicle's interior.

Use a soft bristle brush to remove dust from knobs and crevices on the instrument cluster. Using a mild soap solution, immediately remove hand lotions, sunscreen, and insect repellent from all interior surfaces or permanent damage may result.

Your dealer may have products for cleaning the interior. Use cleaners specifically designed for the surfaces being cleaned to prevent permanent damage.

To prevent overspray, apply all cleaners directly to the cleaning cloth. Cleaners should be removed quickly. Never allow cleaners to remain on the surface being cleaned for extended periods of time.

Cleaners may contain solvents that can become concentrated in the interior. Before using cleaners, read and adhere to all safety instructions on the label. While cleaning the interior, maintain adequate ventilation by opening the doors and windows.

To prevent damage, do not clean the interior using the following cleaners or techniques:

- Never use a razor or any other sharp object to remove a soil from any interior surface.
- Never use a brush with stiff bristles.

- Never rub any surface aggressively or with excessive pressure.
- Do not use laundry detergents or dishwashing soaps with degreasers. For liquid cleaners, use approximately 20 drops per 3.78L (1 gal) of water. A concentrated soap solution will leave a residue that creates streaks and attracts dirt. Do not use solutions that contain strong or caustic soap.
- Do not heavily saturate the upholstery when cleaning.
- Do not use solvents or cleaners containing solvents.

Interior Glass

To clean, use a terry cloth fabric dampened with water. Wipe droplets left behind with a clean dry cloth. Commercial glass cleaners may be used, if necessary, after cleaning the interior glass with plain water.

Notice: To prevent scratching, never use abrasive cleaners on automotive glass. Abrasive cleaners or aggressive cleaning may damage the rear window defogger.

Fabric/Carpet

Start by vacuuming the surface using a soft brush attachment. If a rotating brush attachment is being used during vacuuming, only use it on the floor carpet.

Before cleaning, gently remove as much of the soil as possible using one of the following techniques:

- Gently blot liquids with a paper towel. Continue blotting until no more soil can be removed.
- For solid soils, remove as much as possible prior to vacuuming.

To clean:

1. Saturate a clean lint-free colorfast cloth with water or club soda. Microfiber cloth is recommended to prevent lint transfer to the fabric or carpet.
2. Remove excess moisture by gently wringing until water does not drip from the cleaning cloth.
3. Start on the outside edge of the soil and gently rub toward the center. Rotate the cleaning cloth to a clean area frequently to prevent forcing the soil in to the fabric.

4. Continue gently rubbing the soiled area until there is no longer any color transfer from the soil to the cleaning cloth.
5. If the soil is not completely removed, use a mild soap solution followed only by club soda or plain water.

If the soil is not completely removed, it may be necessary to use a commercial upholstery cleaner or spot lifter. Test a small hidden area for colorfastness before using a commercial upholstery cleaner or spot lifter. If ring formation occurs, clean the entire fabric or carpet.

Following the cleaning process, a paper towel can be used to blot excess moisture.

Instrument Panel, Vinyl, and Other Plastic Surfaces

Use a soft microfiber cloth dampened with water to remove dust and loose dirt. For a more thorough cleaning, use a soft microfiber cloth dampened with a mild soap solution.

Notice: Soaking or saturating leather, especially perforated leather, as well as other interior surfaces, may cause permanent damage. Wipe excess moisture from these surfaces after cleaning and allow them to dry naturally. Never use heat, steam, spot lifters or spot removers. Do not use cleaners that contain silicone or wax-based products. Cleaners containing these solvents can permanently change the appearance and feel of leather or soft trim and are not recommended.

Do not use cleaners that increase gloss, especially on the instrument panel. Reflected glare can decrease visibility through the windshield under certain conditions.

Notice: Use of air fresheners may cause permanent damage to plastics and painted surfaces. If an air freshener comes in contact with any plastic or painted surface in the vehicle, blot immediately and clean with a soft cloth dampened with a mild soap solution. Damage caused by air fresheners would not be covered by the vehicle warranty.

Care of Safety Belts

Keep belts clean and dry.



Do not bleach or dye safety belts. It may severely weaken them. In a crash, they might not be able to provide adequate protection. Clean safety belts only with mild soap and lukewarm water.

Floor Mats

WARNING

If a floor mat is the wrong size or is not properly installed, it can interfere with the accelerator pedal and/or brake pedal. Interference with the pedals can cause unintended acceleration and/or increased stopping distance which can cause a crash and injury. Make sure the floor mat does not interfere with the pedals.

Use the following guidelines for proper floor mat usage.

- The original equipment floor mats were designed for your vehicle. If the floor mats need replacing, it is recommended that GM certified floor mats be purchased. Non-GM floor mats may not fit properly and may interfere with the accelerator or brake pedal. Always check that the floor mats do not interfere with the pedals.
- Use the floor mat with the correct side up. Do not turn it over.
- Do not place anything on top of the driver side floor mat.
- Use only a single floor mat on the driver side.
- Do not place one floor mat on top of another.

Button Retainer

Floor mats with a button-type retainer.

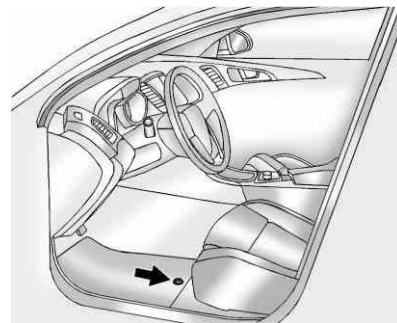

Removing and Replacing the Floor Mat

1. Pull up on the rear of the mat to unlock and remove.
2. Reinstall the floor mat by lining up the floor mat openings over the carpet retainers and snapping into position.

10-94 Vehicle Care

3. Make sure the floor mat is properly secured and verify that it does not interfere with the pedals.

Knob Retainer

Floor mats with a knob retainer.

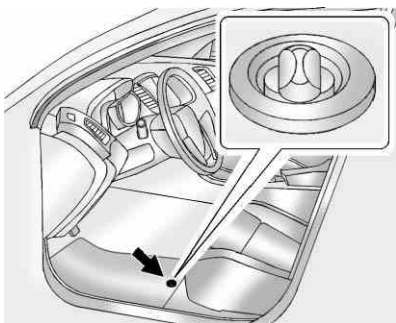

Removing and Replacing the Floor Mat

1. Turn the knob until it is aligned with the slot in the floor mat grommet.
2. Pull up on the floor mat.

3. Center the slot in the floor mat grommet with the knob on the floor and set into position.
4. Turn the knob until it is perpendicular to the slot in the grommet to lock the mat in place.
5. Make sure the floor mat is properly secured and verify that it does not interfere with the pedals.

Service and Maintenance

General Information

General Information 11-1

Maintenance Schedule

Maintenance Schedule 11-2

Special Application Services

Special Application
Services 11-8

Additional Maintenance and Care

Additional Maintenance
and Care 11-9

Recommended Fluids, Lubricants, and Parts

Recommended Fluids and
Lubricants 11-12
Maintenance Replacement
Parts 11-14

Maintenance Records

Maintenance Records 11-15

General Information

Your vehicle is an important investment. This section describes the required maintenance for the vehicle. Follow this schedule to help protect against major repair expenses resulting from neglect or inadequate maintenance. It may also help to maintain the value of the vehicle if it is sold. It is the responsibility of the owner to have all required maintenance performed.

Your dealer has trained technicians who can perform required maintenance using genuine replacement parts. They have up-to-date tools and equipment for fast and accurate diagnostics. Many dealers have extended evening and Saturday hours, courtesy transportation, and online scheduling to assist with service needs.

Your dealer recognizes the importance of providing competitively priced maintenance and repair services. With trained technicians, the dealer is the place for routine maintenance such as oil changes and tire rotations and additional maintenance items like tires, brakes, batteries, and wiper blades.

Notice: Damage caused by improper maintenance can lead to costly repairs and may not be covered by the vehicle warranty. Maintenance intervals, checks, inspections, recommended fluids, and lubricants are important to keep the vehicle in good working condition.

The Tire Rotation and Required Services are the responsibility of the vehicle owner. It is recommended to have your dealer perform these services every 12 000 km/7,500 mi. Proper vehicle maintenance helps to keep the vehicle in good working condition, improves fuel economy, and reduces vehicle emissions.

11-2 Service and Maintenance

Because of the way people use vehicles, maintenance needs vary. There may need to be more frequent checks and services. The Additional Required Services - Normal are for vehicles that:

- Carry passengers and cargo within recommended limits on the Tire and Loading Information label. See *Vehicle Load Limits on page 9-12*.
- Are driven on reasonable road surfaces within legal driving limits.
- Use the recommended fuel. See *Recommended Fuel on page 9-44*.

Refer to the information in the Maintenance Schedule Additional Required Services - Normal chart.

The Additional Required Services - Severe are for vehicles that are:

- Mainly driven in hilly or mountainous terrain.
- Frequently towing a trailer.
- Used for high speed or competitive driving.
- Used for taxi, police, or delivery service.

Refer to the information in the Maintenance Schedule Additional Required Services - Severe chart.

WARNING

Performing maintenance work can be dangerous and can cause serious injury. Perform maintenance work only if the required information, proper tools, and equipment are available. If they are not, see your dealer to have a trained technician do the work. See *Doing Your Own Service Work on page 10-4*.

Maintenance Schedule

Owner Checks and Services

At Each Fuel Stop

- Check the engine oil level. See *Engine Oil on page 10-8*.

Once a Month

- Check the tire inflation pressures. See *Tire Pressure on page 10-45*.
- Inspect the tires for wear. See *Tire Inspection on page 10-52*.
- Check the windshield washer fluid level. See *Washer Fluid on page 10-22*.

Engine Oil Change

When the CHANGE ENGINE OIL SOON message displays, have the engine oil and filter changed within the next 1 000 km/600 mi. If driven under the best conditions, the engine oil life system might not indicate the need for vehicle service for more than a year. The engine oil and filter must be changed at least once a year and the oil life system must be reset. Your trained dealer technician can perform this work. If the engine oil life system is reset accidentally, service the vehicle within 5 000 km/3,000 mi since the last service. Reset the oil life system when the oil is changed. See *Engine Oil Life System on page 10-10*.

Tire Rotation and Required Services Every 12 000 km/7,500 mi

Rotate the tires, if recommended for the vehicle, and perform the following services. See *Tire Rotation on page 10-52*.

- Check engine oil level and oil life percentage. If needed, change engine oil and filter, and reset oil life system. See *Engine Oil on page 10-8* and *Engine Oil Life System on page 10-10*.
- Check engine coolant level. See *Engine Coolant on page 10-14*.
- Check windshield washer fluid level. See *Washer Fluid on page 10-22*.
- Visually inspect windshield wiper blades for wear, cracking, or contamination. See *Exterior Care on page 10-86*. Replace worn or damaged wiper blades. See *Wiper Blade Replacement on page 10-27*.
- Check tire inflation pressures. See *Tire Pressure on page 10-45*.
- Inspect tire wear. See *Tire Inspection on page 10-52*.
- Visually check for fluid leaks.
- Inspect engine air cleaner filter. See *Engine Air Cleaner/Filter on page 10-12*.
- Inspect brake system.

11-4 Service and Maintenance

- Visually inspect steering, suspension, and chassis components for damaged, loose, or missing parts or signs of wear. See *Exterior Care* on page 10-86.
- Check restraint system components. See *Safety System Check* on page 3-22.
- Visually inspect fuel system for damage or leaks.
- Visually inspect exhaust system and nearby heat shields for loose or damaged parts.
- Lubricate body components. See *Exterior Care* on page 10-86.
- Check starter switch. See *Starter Switch Check* on page 10-26.
- Check automatic transmission shift lock control function. See *Automatic Transmission Shift Lock Control Function Check* on page 10-26.
- Check ignition transmission lock. See *Ignition Transmission Lock Check* on page 10-27.
- Check parking brake and automatic transmission park mechanism. See *Park Brake and P (Park) Mechanism Check* on page 10-27.
- Check accelerator pedal for damage, high effort, or binding. Replace if needed.
- Visually inspect gas strut for signs of wear, cracks, or other damage. Check the hold open ability of the strut. See your dealer if service is required.
- Check tire sealant expiration date, if equipped. See *Tire Sealant and Compressor Kit* on page 10-62.
- Inspect sunroof track and seal, if equipped. See *Sunroof* on page 2-22.

11-6 Service and Maintenance

Footnotes — Maintenance Schedule Additional Required Services — Normal

a) Or every two years, whichever comes first. More frequent replacement may be needed if the vehicle is driven in areas with heavy traffic, areas with poor air quality, or areas with high dust levels. Replacement may also be needed if there is a reduction in air flow, excessive window fogging, or odors.

b) Check all fuel and vapor lines and hoses for proper hook-up, routing, and condition. Check that the purge valve, if the vehicle has one, works properly. Replace as needed.

c) Or every four years, whichever comes first.

d) Do not directly power wash the transfer case output seals. High pressure water can overcome the seals and contaminate the transfer case fluid. Contaminated fluid will decrease the life of the transfer case and should be replaced.

e) Or every five years, whichever comes first. See *Cooling System on page 10-14*.

f) Or every 10 years, whichever comes first. Inspect for fraying, excessive cracking, or damage; replace, if needed.

11-8 Service and Maintenance

Footnotes — Maintenance Schedule Additional Required Services — Severe

a) Or every two years, whichever comes first.

b) Check all fuel and vapor lines and hoses for proper hook-up, routing, and condition. Check that the purge valve, if the vehicle has one, works properly. Replace as needed.

c) Or every four years, whichever comes first.

d) Do not directly power wash the transfer case output seals. High pressure water can overcome the seals and contaminate the transfer case fluid. Contaminated fluid will decrease the life of the transfer case and should be replaced.

e) Or every five years, whichever comes first. See *Cooling System on page 10-14*.

f) Or every 10 years, whichever comes first. Inspect for fraying, excessive cracking, or damage; replace, if needed.

Special Application Services

- Severe Commercial Use Vehicles Only: Lubricate chassis components every 5 000 km/3,000 mi.
- Have underbody flushing service performed once a year.

Additional Maintenance and Care

Your vehicle is an important investment and caring for it properly may help to avoid future costly repairs. To maintain vehicle performance, additional maintenance services may be required. It is recommended that your dealer perform these services — their trained dealer technicians know your vehicle best. Your dealer can also perform a thorough assessment with a multi-point inspection to recommend when your vehicle may need attention. The following list is intended to explain the services and conditions to look for that may indicate services are required.

Battery

The battery supplies power to start the engine and operate any additional electrical accessories.

- To avoid break-down or failure to start the vehicle, maintain a battery with full cranking power.
- Trained dealer technicians have the diagnostic equipment to test the battery and ensure that the connections and cables are corrosion-free.

Belts

- Belts may need replacing if they squeak or show signs of cracking or splitting.
- Trained dealer technicians can inspect the belts and recommend replacement when necessary.

Brakes

Brakes stop the vehicle and are crucial to safe driving.

- Signs of brake wear may include chirping, grinding, or squealing noises, or difficulty stopping.
- Trained dealer technicians have access to tools and equipment to inspect the brakes and recommend quality parts engineered for the vehicle.

Fluids

Proper fluid levels and approved fluids protect the vehicle's systems and components. See *Recommended Fluids and Lubricants* on page 11-12 for GM approved fluids.

- Engine oil and windshield washer fluid levels should be checked at every fuel fill.
- Instrument cluster lights may come on to indicate that fluids may be low and need to be filled.

11-10 Service and Maintenance

Hoses

Hoses transport fluids and should be regularly inspected to ensure that there are no cracks or leaks. With a multi-point inspection, your dealer can inspect the hoses and advise if replacement is needed.

Lamps

Properly working headlamps, taillamps, and brake lamps are important to see and be seen on the road.

- Signs that the headlamps need attention include dimming, failure to light, cracking, or damage. The brake lamps need to be checked periodically to ensure that they light when braking.
- With a multi-point inspection, your dealer can check the lamps and note any concerns.

Shocks and Struts

Shocks and struts help aid in control for a smoother ride.

- Signs of wear may include steering wheel vibration, bounce/sway while braking, longer stopping distance, or uneven tire wear.
- As part of the multi-point inspection, trained dealer technicians can visually inspect the shocks and struts for signs of leaking, blown seals, or damage, and can advise when service is needed.

Tires

Tires need to be properly inflated, rotated, and balanced. Maintaining the tires can save money, fuel, and can reduce the risk of tire failure.

- Signs that the tires need to be replaced include three or more visible treadwear indicators; cord or fabric showing through the rubber; cracks or cuts in the tread or sidewall; or a bulge or split in the tire.
- Trained dealer technicians can inspect and recommend the right tires. Your dealer can also provide tire/wheel balancing services to ensure smooth vehicle operation at all speeds. Your dealer sells and services name brand tires.

Vehicle Care

To help keep the vehicle looking like new, vehicle care products are available from your dealer. For information on how to clean and protect the vehicle's interior and exterior, see *Interior Care* on page 10-90 and *Exterior Care* on page 10-86.

Wheel Alignment

Wheel alignment is critical for ensuring that the tires deliver optimal wear and performance.

- Signs that the alignment may need to be adjusted include pulling, improper vehicle handling, or unusual tire wear.
- Your dealer has the required equipment to ensure proper wheel alignment.

Windshield

For safety, appearance, and the best viewing, keep the windshield clean and clear.

- Signs of damage include scratches, cracks, and chips.
- Trained dealer technicians can inspect the windshield and recommend proper replacement if needed.

Wiper Blades

Wiper blades need to be cleaned and kept in good condition to provide a clear view.

- Signs of wear include streaking, skipping across the windshield, and worn or split rubber.
- Trained dealer technicians can check the wiper blades and replace them when needed.

Recommended Fluids, Lubricants, and Parts

Recommended Fluids and Lubricants

Usage	Fluid/Lubricant
Engine Oil	Use only engine oil licensed to the dexos1 specification, or equivalent, of the proper SAE viscosity grade. ACDelco dexos1 Synthetic Blend is recommended. See <i>Engine Oil on page 10-8</i> .
Engine Coolant	50/50 mixture of clean, drinkable water and use only DEX-COOL Coolant. See <i>Engine Coolant on page 10-14</i> .
Hydraulic Brake System	DOT 3 Hydraulic Brake Fluid (GM Part No. 88862806, in Canada 88862807).
Windshield Washer	Optikleen [®] Washer Solvent.
Hydraulic Power Steering System	GM Power Steering Fluid (GM Part No. 89021184, in Canada 89021186).
Automatic Transmission	DEXRON [®] -VI Automatic Transmission Fluid.

Usage	Fluid/Lubricant
Carrier Assembly — Differential (Rear Drive Module) and Transfer Case (Power Transfer Unit)	SAE 75W-90 Synthetic Axle Lubricant (GM Part No. 89021677, in Canada 89021678).
Key Lock Cylinders	Multi-Purpose Lubricant, Superlube (GM Part No. 12346241, in Canada 10953474).
Hood Latch Assembly, Secondary Latch, Pivots, Spring Anchor, and Release Pawl	Lubriplate Lubricant Aerosol (GM Part No. 12346293, in Canada 992723) or lubricant meeting requirements of NLGI #2, Category LB or GC-LB.
Hood and Door Hinges	Multi-Purpose Lubricant, Superlube (GM Part No. 12346241, in Canada 10953474).
Weatherstrip Conditioning	Weatherstrip Lubricant (GM Part No. 3634770, in Canada 10953518) or Dielectric Silicone Grease (GM Part No. 12345579, in Canada 992887).

11-14 Service and Maintenance

Maintenance Replacement Parts

Replacement parts identified below by name, part number, or specification can be obtained from your dealer.

Part	GM Part Number	ACDelco Part Number
Engine Air Cleaner/Filter	15278634	A3083C
Engine Oil Filter	89017525	PF63
Passenger Compartment Air Filter	20958479	CF179C
Spark Plugs	12622561	41-109
Wiper Blades		
Front Driver – 62.5 cm (24.6 in)	15254805	—
Front Passenger – 53.0 cm (20.8 in)	15254804	—
Rear – 30.0 cm (11.8 in)	25820122	—

Technical Data

Vehicle Identification

Vehicle Identification	
Number (VIN)	12-1
Service Parts Identification	
Label	12-1

Vehicle Data

Capacities and	
Specifications	12-2
Engine Drive Belt Routing ...	12-3

Vehicle Identification

Vehicle Identification Number (VIN)



This legal identifier is in the front corner of the instrument panel, on the left side of the vehicle. It can be seen through the windshield from outside. The VIN also appears on the Vehicle Certification and Service Parts labels and certificates of title and registration.

Engine Identification

The eighth character in the VIN is the engine code. This code identifies the vehicle's engine, specifications, and replacement parts. See "Engine Specifications" under *Capacities and Specifications* on page 12-2 for the vehicle's engine code.

Service Parts Identification Label

This label, on the inside of the glove box, has the following information:

- Vehicle Identification Number (VIN).
- Model designation.
- Paint information.
- Production options and special equipment.

Do not remove this label from the vehicle.

Vehicle Data

Capacities and Specifications

The following approximate capacities are given in metric and English conversions. See *Recommended Fluids and Lubricants* on page 11-12 for more information.

Application	Capacities	
	Metric	English
Air Conditioning Refrigerant R134a	For the air conditioning system refrigerant charge amount, see the refrigerant label located under the hood. See your dealer for more information.	
Cooling System	10.8 L	11.4 qt
Engine Oil with Filter	5.7 L	6.0 qt
Fuel Tank	83.3 L	22.0 gal
Transmission Fluid* (Drain and Refill)	5.0 L	5.3 qt
Wheel Nut Torque	190 N•m	140 lb ft
*See <i>Automatic Transmission Fluid</i> on page 10-12 for information on checking fluid level.		
All capacities are approximate. When adding, be sure to fill to the approximate level, as recommended in this manual. Recheck fluid level after filling.		

Engine Specifications

Engine	VIN Code	Transmission	Spark Plug Gap
3.6L V6 Engine	D	Automatic	1.10 mm (0.043 in)

Engine Drive Belt Routing

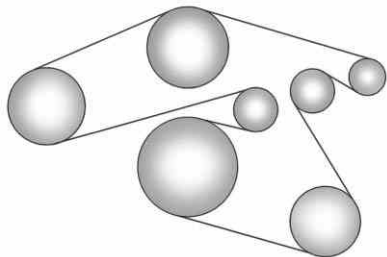

Customer Information

Customer Information

Customer Satisfaction Procedure (U.S. and Canada)	13-1
Customer Satisfaction Procedure (Mexico)	13-3
Customer Assistance Offices (U.S. and Canada)	13-5
Customer Assistance Offices (Mexico)	13-6
Customer Assistance for Text Telephone (TTY) Users (U.S. and Canada)	13-6
Online Owner Center	13-7
GM Mobility Reimbursement Program (U.S. and Canada)	13-8
Roadside Assistance Program (U.S. and Canada)	13-8
Roadside Assistance Program (Mexico)	13-10
Scheduling Service Appointments (U.S. and Canada)	13-14

Courtesy Transportation Program (U.S. and Canada)	13-14
Collision Damage Repair (U.S. and Canada)	13-16
Service Publications Ordering Information	13-18

Reporting Safety Defects

Reporting Safety Defects to the United States Government	13-19
Reporting Safety Defects to the Canadian Government	13-20
Reporting Safety Defects to General Motors	13-20

Vehicle Data Recording and Privacy

Vehicle Data Recording and Privacy	13-21
Event Data Recorders	13-21
OnStar®	13-22
Navigation System	13-22
Radio Frequency Identification (RFID)	13-22
Radio Frequency Statement	13-23

Customer Information

Customer Satisfaction Procedure (U.S. and Canada)

Your satisfaction and goodwill are important to your dealer and to Buick. Normally, any concerns with the sales transaction or the operation of the vehicle will be resolved by your dealer's sales or service departments. Sometimes, however, despite the best intentions of all concerned, misunderstandings can occur. If your concern has not been resolved to your satisfaction, the following steps should be taken:

STEP ONE: Discuss your concern with a member of dealership management. Normally, concerns can be quickly resolved at that level. If the matter has already been reviewed with the sales, service, or parts manager, contact the owner of your dealership or the general manager.

13-2 Customer Information

STEP TWO: If after contacting a member of dealership management, it appears your concern cannot be resolved by your dealership without further help, in the U.S., call 1-800-521-7300. In Canada, contact General Motors of Canada Customer Care Centre at 1-800-263-3777 (English) or 1-800-263-7854 (French).

We encourage you to call the toll-free number in order to give the inquiry prompt attention. Have the following information available to give the Customer Assistance representative:

- Vehicle Identification Number (VIN). This is available from the vehicle registration or title, or the plate at the top left of the instrument panel and visible through the windshield.
- Dealership name and location.
- Vehicle delivery date and present mileage.

When contacting Buick, remember that your concern will likely be resolved at a dealer's facility. That is why we suggest following Step One first.

STEP THREE — U.S. Owners:

Both General Motors and your dealer are committed to making sure you are completely satisfied with the new vehicle. However, if you continue to remain unsatisfied after following the procedure outlined in Steps One and Two, you can file with the Better Business Bureau (BBB) Auto Line[®] Program to enforce your rights.

The BBB Auto Line Program is an out-of-court program administered by the Council of Better Business Bureaus to settle automotive disputes regarding vehicle repairs or the interpretation of the New Vehicle Limited Warranty. Although you may be required to resort to this informal dispute resolution program prior to filing a court action, use of the program is free of charge and your

case will generally be heard within 40 days. If you do not agree with the decision given in your case, you may reject it and proceed with any other venue for relief available to you.

You may contact the BBB Auto Line Program using the toll-free telephone number or write them at the following address:

BBB Auto Line Program
Council of Better Business
Bureaus, Inc.
4200 Wilson Boulevard
Suite 800
Arlington, VA 22203-1838

Telephone: 1-800-955-5100
www.dr.bbb.org/goauto

This program is available in all 50 states and the District of Columbia. Eligibility is limited by vehicle age, mileage, and other factors. General Motors reserves the right to change eligibility limitations and/or discontinue its participation in this program.

STEP THREE — Canadian

Owners: In the event that you do not feel your concerns have been addressed after following the procedure outlined in Steps One and Two, General Motors of Canada Limited wants you to be aware of its participation in a no-charge Mediation/Arbitration program. General Motors of Canada Limited has committed to binding arbitration of owner disputes involving factory-related vehicle service claims. The program provides for the review of the facts involved by an impartial third party arbiter, and may include an informal hearing before the arbiter. The program is designed so that the entire dispute settlement process, from the time you file your complaint to the final decision, should be completed in approximately 70 days.

We believe our impartial program offers advantages over courts in most jurisdictions because it is informal, quick, and free of charge.

For further information concerning eligibility in the Canadian Motor Vehicle Arbitration Plan (CAMVAP), call toll-free 1-800-207-0685, or call the General Motors Customer Care Centre, 1-800-263-3777 (English), 1-800-263-7854 (French), or write to:

Mediation/Arbitration Program
c/o Customer Care Centre
General Motors of Canada Limited
Mail Code: CA1-163-005
1908 Colonel Sam Drive
Oshawa, Ontario L1H 8P7

The inquiry should be accompanied by the Vehicle Identification Number (VIN).

**Customer Satisfaction
Procedure (Mexico)**

Did you get the Warranty Extension Plan? This plan is recommended by General Motors to supplement the warranty included with the new vehicle purchase.

See your dealer for details.

13-4 Customer Information

Customer Assistance Procedure

Owner satisfaction and goodwill are very important to your dealer and General Motors.

Normally, any problem with the transaction, sale, or usage of the vehicle must be handled by your dealer sales or service departments. However, we recognize that despite the good intentions of all parties involved, sometimes a misunderstanding may occur.

If you have a problem that has not been satisfactorily handled through the normal means, we suggest the following steps:

STEP ONE

Explain your case to your dealer service agent, service manager, dealer sales agent, or sales manager, depending on your case.

Make sure that they have all necessary information. They are interested in your continual satisfaction.

STEP TWO

If you are not satisfied, please contact the general manager or your dealership owner to ask for their help. If they are not able to resolve your case, ask them to contact the right people at General Motors for support, if needed.

STEP THREE

If your case is not resolved in a reasonable amount of time by your dealer, please call the General Motors Customer Assistance Center (CAC) and provide the following information:

- Name
- Address

- Phone number
- Model year
- Brand
- Vehicle Identification Number (VIN)
- Mileage
- Delivery date
- Description of the problem
- Dealership name
- Dealership address

See *Customer Assistance Offices (U.S. and Canada)* on page 13-5 or *Customer Assistance Offices (Mexico)* on page 13-6 for more information.

Customer Assistance Offices (U.S. and Canada)

Buick encourages customers to call the toll-free number for assistance. However, if a customer wishes to write or e-mail Buick, the letter should be addressed to:

United States

Buick Customer Assistance Center
P.O. Box 33136
Detroit, MI 48232-5136
www.Buick.com

1-800-521-7300
1-800-832-8425 (For Text
Telephone devices (TTYs))
Roadside Assistance:
1-800-252-1112

From Puerto Rico:

1-800-496-9992 (English)
1-800-496-9993 (Spanish)

From U.S. Virgin Islands:

1-800-496-9994

Canada

General Motors of Canada Limited
Customer Care Centre,
Mail Code: CA1-163-005
1908 Colonel Sam Drive
Oshawa, Ontario L1H 8P7
www.gm.ca

1-800-263-3777 (English)
1-800-263-7854 (French)
1-800-263-3830 (For Text
Telephone devices (TTYs))
Roadside Assistance:
1-800-268-6800

All Overseas Locations

Please contact the local
General Motors Business Unit.

Mexico, Central America and Caribbean Islands/Countries (Except Puerto Rico and U.S. Virgin Islands)

General Motors de Mexico,
S. de R.L. de C.V.
Customer Assistance Center
Av. Ejercito Nacional #843
Col. Granada
C.P. 11520, Mexico, D.F.

01-800-466-0818
Long Distance: 011-52-53 29 0818

13-6 Customer Information

Customer Assistance Offices (Mexico)

To contact the Customer Assistance Center (CAC), use the phone numbers listed in this section.

Customer assistance is available Monday through Friday, 08:00 to 20:00 hours, and Saturdays from 08:00 to 15:00 hours.

All e-mail inquiries to the Customer Assistance Center (CAC) should be sent to: cac.buick@gm.com.

Mexico

From Mexico City

5329-0818

From Other Mexico Locations

01-800-466-0818

United States and Canada

1-800-521-7300

Costa Rica

00-800-052-1005

Guatemala

1-800-999-5252

Panama

00-800-052-0001

Dominican Republic

1-888-751-5301

El Salvador

800-6273

Honduras

800-0122-6101

Customer Assistance for Text Telephone (TTY) Users (U.S. and Canada)

To assist customers who are deaf, hard of hearing, or speech-impaired and who use Text Telephones (TTYs), Buick has TTY equipment available at its Customer Assistance Center. Any TTY user can communicate with Buick by dialing: 1-800-832-8425. TTY users in Canada can dial 1-800-263-3830.

Online Owner Center

Buick Owner Center (U.S.) www.buickownercenter.com

Information and services customized for your specific vehicle — all in one convenient place.

- Digital owner manual, warranty information, and more.
- Storage for online service and maintenance records.
- Buick dealer locator for service nationwide.
- Exclusive privileges and offers.
- Recall notices for your specific vehicle.
- OnStar and GM Cardmember Services Earnings summaries.

Other Helpful Links:

Buick — www.buick.com

Buick Merchandise —
www.buickmerchandise.com

Help Center —
<http://www.buick.com/help/faqs.html>

- FAQ (Frequently Asked Questions)
- Contact Us

My GM Canada www.gm.ca

My GM Canada is a password-protected section of www.gm.ca where you can save information on GM vehicles, get personalized offers, and use handy tools and forms with greater ease.

Here are a few of the valuable tools and services you will have access to:

- **My Showroom:** Find and save information on vehicles and current offers in your area.
- **My Dealers:** Save details such as address and phone number for each of your preferred GM dealers.
- **My Driveway:** Access quick links to parts and service estimates, check trade-in values, or schedule a service appointment by adding the vehicles you own to your driveway profile.
- **My Preferences:** Manage your profile and use tools and forms with greater ease.

To sign up, visit the My GM.ca section within www.gm.ca.

GM Mobility Reimbursement Program (U.S. and Canada)



This program is available to qualified applicants for cost reimbursement of eligible aftermarket adaptive equipment required for the vehicle, such as hand controls or a wheelchair/scooter lift for the vehicle.

For more information on the limited offer, visit www.gmmobility.com or call the GM Mobility Assistance Center at 1-800-323-9935. Text Telephone (TTY) users, call 1-800-833-9935.

General Motors of Canada also has a Mobility Program. Call 1-800-GM-DRIVE (463-7483) for details. TTY users call 1-800-263-3830.

Roadside Assistance Program (U.S. and Canada)

For U.S.-purchased vehicles, call **1-800-252-1112**; (Text Telephone (TTY): **1-888-889-2438**).

For Canadian-purchased vehicles, call **1-800-268-6800**.

Service is available 24 hours a day, 365 days a year.

Calling for Assistance

When calling Roadside Assistance, have the following information ready:

- Your name, home address, and home telephone number.
- Telephone number of your location.
- Location of the vehicle.
- Model, year, color, and license plate number of the vehicle.

- Odometer reading, Vehicle Identification Number (VIN), and delivery date of the vehicle.
- Description of the problem.

Coverage

Services are provided up to 5 years/160 000 km (100,000 mi), whichever comes first.

In the U.S., anyone driving the vehicle is covered. In Canada, a person driving the vehicle without permission from the owner is not covered.

Roadside Assistance is not a part of the New Vehicle Limited Warranty. Buick and General Motors of Canada Limited reserve the right to make any changes or discontinue the Roadside Assistance program at any time without notification.

Buick and General Motors of Canada Limited reserve the right to limit services or payment to an owner or driver if they decide the claims are made too often, or the same type of claim is made many times.

Services Provided

- **Emergency Fuel Delivery:** Delivery of enough fuel for the vehicle to get to the nearest service station.
- **Lock-Out Service:** Service to unlock the vehicle if you are locked out. A remote unlock may be available if you have OnStar[®]. For security reasons, the driver must present identification before this service is given.

- **Emergency Tow from a Public Road or Highway:** Tow to the nearest Buick dealer for warranty service, or if the vehicle was in a crash and cannot be driven. Assistance is also given when the vehicle is stuck in sand, mud, or snow.
- **Flat Tire Change:** Service to change a flat tire with the spare tire. The spare tire, if equipped, must be in good condition and properly inflated. It is the owner's responsibility for the repair or replacement of the tire if it is not covered by the warranty.
- **Battery Jump Start:** Service to jump start a dead battery.

Services Not Included in Roadside Assistance

- Impound towing caused by violation of any laws.
- Legal fines.
- Mounting, dismounting, or changing of snow tires, chains, or other traction devices.
- Towing or services for vehicles driven on a non-public road or highway.

Services Specific to Canadian-Purchased Vehicles

- **Fuel delivery:** Reimbursement is approximately \$5 Canadian. Diesel fuel delivery may be restricted. Propane and other fuels are not provided through this service.
- **Lock-Out Service:** Vehicle registration is required.

13-10 Customer Information

- **Trip Routing Service:** Detailed maps of North America are provided when requested either with the most direct route or the most scenic route. There is a six request limit per year. Additional travel information is also available. Allow three weeks for delivery.
- **Trip Interruption Benefits and Assistance:** Must be over 250 kilometers from where your trip was started to qualify. General Motors of Canada Limited requires pre-authorization, original detailed receipts, and a copy of the repair orders. Once authorization has been received, the Roadside Assistance advisor will help you make arrangements and explain how to receive payment.

- **Alternative Service:** If assistance cannot be provided right away, the Roadside Assistance advisor may give permission to get local emergency road service. You will receive payment, up to \$100, after sending the original receipt to Roadside Assistance. Mechanical failures may be covered, however any cost for parts and labor for repairs not covered by the warranty are the owner responsibility.

Roadside Assistance Program (Mexico)

As a new owner, your vehicle is automatically enrolled in the Roadside Assistance program. The services are available at no cost under the terms and conditions of the program. The Roadside Assistance program is not part of, or included, in the coverage provided by the new vehicle limited warranty.

Roadside Assistance provides assistance to the driver and passengers while driving the vehicle within your city of residence or on any passable road in Mexico, the United States, and Canada. Services are subject to the limitations described in the following pages. Program coverage varies by country.

Roadside Assistance is available 24 hours a day, 365 days of the year.

This program expires two years from the date of the invoice for the vehicle, regardless of vehicle mileage and changes in vehicle ownership.

For more information about the renewal of this program at the end of its term, contact the Buick Customer Assistance Center at 01-800-466-0818.

Services Provided

- **Flat Tire Change:** If unable to change a flat tire, Roadside Assistance will provide towing service to the nearest authorized Buick dealership. It is the owner's responsibility for the repair or replacement of the tire. This service is limited to the transfer of the vehicle to the repair facility.
- **Emergency Fuel Delivery:** Delivery of enough fuel for the vehicle to get to the nearest service station.
- **Lock-Out Service:** Service to unlock the vehicle if you are locked out.
- **Battery Jump Start:** Service to jump start a dead battery.
- ***Emergency Messages:** Transmission of urgent phone messages.

- ***Emergency Calls:** Call for emergency services.
- ***Dealership Location Assistance:** Information regarding addresses and telephone numbers for Buick dealers.
- **Emergency Towing:** Tow to the nearest dealer for warranty service if the vehicle cannot be driven.

If the vehicle is involved in an accident during the commission of a crime, administrative violation, or breach of traffic regulations, Roadside Assistance will not provide service. When the vehicle is not accessible to be towed, all maneuvers required to access it will be at the owner's expense.

If the vehicle is in another city outside of your residence, Roadside Assistance is limited to moving the vehicle to the nearest dealer. If you would like the vehicle moved to a different dealer, you will be asked to cover the difference in cost at the time of the move.

If the vehicle cannot be received by the nearest Buick dealer due to scheduling conflicts, the vehicle will be taken to a safe place where it will remain for up to 48 hours until it can be taken to the dealer. If the storage costs exceed the amount authorized, the owner is responsible to pay the difference at the time of service. Contact Roadside Assistance for more information on authorized amounts.

13-12 Customer Information

- ***Trip Interruption:** This service is provided if you are prevented from further usage of your vehicle while traveling and it is not possible for the nearest Buick dealership to repair the vehicle the same day, requiring the vehicle to stay at the dealership for a night or more. If this happens, in addition to the previously listed services and prior to confirmation by the dealership, you are entitled to choose one of the following alternatives, within the limits of existing Roadside Assistance program guidelines. If the costs exceed the amount authorized for these services, you must pay the difference at the time of service.

Roadside Assistance will coordinate hotel accommodations for all vehicle travelers for up to two nights.

A rental car will be provided for up to two days and the vehicle must be returned to its original destination, excluding vehicles with a carrying capacity greater than 3.5 tons.

Complimentary Transportation: If you prefer to continue your trip to the intended destination or return to your place of residence, and the trip requires more than eight hours driving on the road, transportation for the driver and passengers by first class bus or coach commercial airline will be provided to a location chosen by Roadside Assistance, depending on availability at the chosen destination. Restrictions apply based on vehicle specifications.

If you are on the road, taxi service to the nearest bus station or airport will be provided.

- ***Complimentary Transportation for Vehicle Pick Up:** Transportation to pick up your vehicle after repairs are complete. Once the dealer has reported that the vehicle has been repaired, Roadside Assistance will provide bus or commercial airline one-way service (subject to availability) for the person designated by you to collect your vehicle at the dealership's location if you or the designated person are not in the same town or city as the dealership.

*These services are not provided for U.S. or Canada residents. All services provided in the U.S. and Canada are at the owner's expense and will be reimbursed by Roadside Assistance.

Services Not Included in Roadside Assistance

Roadside Assistance does not cover or reimburse services for the following:

- Events caused by fraud or bad faith by the driver.
- Vehicle immobilization situations due to a major force or unforeseen circumstances, such as natural phenomena of an extraordinary nature, earthquakes, volcanic eruptions, and other cyclonic storms.
- Vehicle immobilization situations arising from car accidents caused by the driver of the vehicle or third parties. This means any occurrence that causes physical injury to the occupants and/or the vehicle caused by external forces.

- Acts of terrorism, riot or uproar, armed forces or police actions which prevent timely delivery of assistance services.
- Food service, beverages, telephone calls, or other extra costs. Accommodation costs apply only to Mexico per the terms and conditions of the Roadside Assistance program.
- Any damage to the vehicle without intent, derived from the services provided.
- Cost of towing a trailer when choosing a Buick dealer that is nearest to the temporary storage facility for the disabled vehicle.
- Cost of all maneuvers required to access the vehicle when it is not available to be towed.
- Cost of fuel provided.

Routine vehicle repair costs are not covered by the Roadside Assistance program. For more information, see your new vehicle warranty.

Contacting Roadside Assistance

Roadside Assistance services are of no cost to you and available 24 hours a day, 365 days a year. Costs are only incurred in situations that exceed the limits of the program, some of which are listed previously in this section.

To contact Roadside Assistance by phone, use the following numbers:

Mexico

01-800-466-0818

United States

1-866-466-8197

Canada

1-800-268-6800

E-mail

asistencia.buick@gm.com

Buick reserves the right to make any changes or discontinue the Roadside Assistance program at any time without notification.

Scheduling Service Appointments (U.S. and Canada)

When the vehicle requires warranty service, contact your dealer and request an appointment. By scheduling a service appointment and advising the service consultant of your transportation needs, your dealer can help minimize your inconvenience.

If the vehicle cannot be scheduled into the service department immediately, keep driving it until it can be scheduled for service, unless, of course, the problem is safety related. If it is, please call your dealership, let them know this, and ask for instructions.

If your dealer requests you to bring the vehicle for service, you are urged to do so as early in the work day as possible to allow for same day-repair.

Courtesy Transportation Program (U.S. and Canada)

To enhance your ownership experience, we and our participating dealers are proud to offer Courtesy Transportation, a customer support program for vehicles with the Bumper-to-Bumper (Base Warranty Coverage period in Canada), extended powertrain, and/or hybrid-specific warranties in both the U.S. and Canada.

Several Courtesy Transportation options are available to assist in reducing inconvenience when warranty repairs are required.

Courtesy Transportation is not a part of the New Vehicle Limited Warranty. A separate booklet entitled "Warranty and Owner Assistance Information" furnished with each new vehicle provides detailed warranty coverage information.

Transportation Options

Warranty service can generally be completed while you wait. However, if you are unable to wait, GM helps to minimize inconvenience by providing several transportation options. Depending on the circumstances, your dealer can offer one of the following:

Shuttle Service

Shuttle service is the preferred means of offering Courtesy Transportation. Dealers may provide shuttle service to get you to your destination with minimal interruption of your daily schedule. This includes one-way or round-trip shuttle service within reasonable time and distance parameters of your dealer's area.

Public Transportation or Fuel Reimbursement

If the vehicle requires overnight warranty repairs, and public transportation is used instead of your dealer's shuttle service, the expense must be supported by original receipts and can only be up to the maximum amount allowed by GM for shuttle service. In addition, for U.S. customers, should you arrange transportation through a friend or relative, limited reimbursement for reasonable fuel expenses may be available. Claim amounts should reflect actual costs and be supported by original receipts. See your dealer for information regarding the allowance amounts for reimbursement of fuel or other transportation costs.

Courtesy Rental Vehicle

Your dealer may arrange to provide you with a courtesy rental vehicle or reimburse you for a rental vehicle that you obtain if the vehicle is kept for an overnight warranty repair. Rental reimbursement will be limited and must be supported by original receipts. This requires that you sign and complete a rental agreement and meet state/provincial, local, and rental vehicle provider requirements. Requirements vary and may include minimum age requirements, insurance coverage, credit card, etc. You are responsible for fuel usage charges and may also be responsible for taxes, levies, usage fees, excessive mileage, or rental usage beyond the completion of the repair.

It may not be possible to provide a like vehicle as a courtesy rental.

Additional Program Information

All program options, such as shuttle service, may not be available at every dealer. Please contact your dealer for specific information about availability. All Courtesy Transportation arrangements will be administered by appropriate dealer personnel.

General Motors reserves the right to unilaterally modify, change, or discontinue Courtesy Transportation at any time and to resolve all questions of claim eligibility pursuant to the terms and conditions described herein at its sole discretion.

Collision Damage Repair (U.S. and Canada)

If the vehicle is involved in a collision and it is damaged, have the damage repaired by a qualified technician using the proper equipment and quality replacement parts. Poorly performed collision repairs diminish the vehicle resale value, and safety performance can be compromised in subsequent collisions.

Collision Parts

Genuine GM Collision parts are new parts made with the same materials and construction methods as the parts with which the vehicle was originally built. Genuine GM Collision parts are the best choice to ensure that the vehicle's designed appearance, durability, and safety are preserved. The use of Genuine GM parts can help maintain the GM New Vehicle Limited Warranty.

Recycled original equipment parts may also be used for repair. These parts are typically removed from vehicles that were total losses in prior crashes. In most cases, the parts being recycled are from undamaged sections of the vehicle. A recycled original equipment GM part may be an acceptable choice to maintain the vehicle's originally designed appearance and safety performance; however, the history of these parts is not known. Such parts are not covered by the GM New Vehicle Limited Warranty, and any related failures are not covered by that warranty.

Aftermarket collision parts are also available. These are made by companies other than GM and may not have been tested for the vehicle.

As a result, these parts may fit poorly, exhibit premature durability/corrosion problems, and may not perform properly in subsequent collisions. Aftermarket parts are not covered by the GM New Vehicle Limited Warranty, and any vehicle failure related to such parts is not covered by that warranty.

Repair Facility

GM also recommends that you choose a collision repair facility that meets your needs before you ever need collision repairs. Your dealer may have a collision repair center with GM-trained technicians and state-of-the-art equipment, or be able to recommend a collision repair center that has GM-trained technicians and comparable equipment.

Insuring the Vehicle

Protect your investment in the GM vehicle with comprehensive and collision insurance coverage. There are significant differences in the quality of coverage afforded by various insurance policy terms. Many insurance policies provide reduced protection to the GM vehicle by limiting compensation for damage repairs by using aftermarket collision parts. Some insurance companies will not specify aftermarket collision parts. When purchasing insurance, we recommend that you ensure that the vehicle will be repaired with GM original equipment collision parts. If such insurance coverage is not available from your current insurance carrier, consider switching to another insurance carrier.

If the vehicle is leased, the leasing company may require you to have insurance that ensures repairs with

Genuine GM Original Equipment Manufacturer (OEM) parts or Genuine Manufacturer replacement parts. Read the lease carefully, as you may be charged at the end of the lease for poor quality repairs.

If a Crash Occurs

If there has been an injury, call emergency services for help. Do not leave the scene of a crash until all matters have been taken care of. Move the vehicle only if its position puts you in danger, or you are instructed to move it by a police officer.

Give only the necessary information to police and other parties involved in the crash.

For emergency towing see *Roadside Assistance Program (U.S. and Canada)* on page 13-8 or *Roadside Assistance Program (Mexico)* on page 13-10.

Gather the following information:

- Driver name, address, and telephone number.
- Driver license number.
- Owner name, address, and telephone number.
- Vehicle license plate number.
- Vehicle make, model, and model year.
- Vehicle Identification Number (VIN).
- Insurance company and policy number.
- General description of the damage to the other vehicle.

Choose a reputable repair facility that uses quality replacement parts. See "Collision Parts" earlier in this section.

If the airbag has inflated, see *What Will You See after an Airbag Inflates?* on page 3-29.

Managing the Vehicle Damage Repair Process

In the event that the vehicle requires damage repairs, GM recommends that you take an active role in its repair. If you have a pre-determined repair facility of choice, take the vehicle there, or have it towed there. Specify to the facility that any required replacement collision parts be original equipment parts, either new Genuine GM parts or recycled original GM parts. Remember, recycled parts will not be covered by the GM vehicle warranty.

Insurance pays the bill for the repair, but you must live with the repair. Depending on your policy limits, your insurance company may initially value the repair using aftermarket parts. Discuss this with the repair professional, and insist on Genuine GM parts. Remember, if the vehicle is leased, you may be obligated to have the vehicle repaired with Genuine GM parts, even if your insurance coverage does not pay the full cost.

If another party's insurance company is paying for the repairs, you are not obligated to accept a repair valuation based on that insurance company's collision policy repair limits, as you have no contractual limits with that company. In such cases, you can have control of the repair and parts choices as long as the cost stays within reasonable limits.

Service Publications Ordering Information

Service Manuals

Service Manuals have the diagnosis and repair information on the engines, transmission, axle, suspension, brakes, electrical, steering, body, etc.

Service Bulletins

Service Bulletins give additional technical service information needed to knowledgeably service General Motors cars and trucks. Each bulletin contains instructions to assist in the diagnosis and service of the vehicle.

Owner Information

Owner publications are written specifically for owners and intended to provide basic operational information about the vehicle.

The Owner Manual includes the Maintenance Schedule for all models.

In-Portfolio: Includes a Portfolio, Owner Manual, and Warranty Booklet.

RETAIL SELL PRICE:

\$35.00 (U.S.) plus handling and shipping fees.

Without Portfolio: Owner Manual only.

RETAIL SELL PRICE:

\$25.00 (U.S.) plus handling and shipping fees.

Current and Past Models

Technical Service Bulletins and Manuals are available for current and past model GM vehicles.

ORDER TOLL FREE:

**1-800-551-4123 Monday - Friday
8:00 AM - 6:00 PM Eastern Time**

For Credit Card Orders Only (VISA-MasterCard-Discover), visit Helm, Inc. at: www.helminc.com.

Or write to:

Helm, Incorporated
P.O. Box 07130
Detroit, MI 48207

Prices are subject to change without notice and without incurring obligation. Allow ample time for delivery.

All listed prices are quoted in U.S. funds. Make checks payable in U.S. funds.

Reporting Safety Defects

Reporting Safety Defects to the United States Government

If you believe that your vehicle has a defect which could cause a crash or could cause injury or death, you should immediately inform the National Highway Traffic Safety Administration (NHTSA) in addition to notifying General Motors.

If NHTSA receives similar complaints, it may open an investigation, and if it finds that a safety defect exists in a group of vehicles, it may order a recall and remedy campaign.

However, NHTSA cannot become involved in individual problems between you, your dealer, or General Motors.

To contact NHTSA, you may call the Vehicle Safety Hotline toll-free at 1-888-327-4236 (TTY: 1-800-424-9153); go to <http://www.safercar.gov>; or write to:

Administrator, NHTSA
1200 New Jersey Avenue, S.E.
Washington, D.C. 20590

You can also obtain other information about motor vehicle safety from <http://www.safercar.gov>.

Reporting Safety Defects to the Canadian Government

If you live in Canada, and you believe that the vehicle has a safety defect, notify Transport Canada immediately, and notify General Motors of Canada Limited. Call Transport Canada at 1-800-333-0510 or write to:

Transport Canada
Road Safety Branch
80 rue Noel
Gatineau, QC J8Z 0A1

Reporting Safety Defects to General Motors

In addition to notifying NHTSA (or Transport Canada) in a situation like this, please notify General Motors.

Call 1-800-521-7300, or write:

Buick Customer Assistance Center
P.O. Box 33136
Detroit, MI 48232-5136

In Canada, call 1-800-263-3777 (English) or 1-800-263-7854 (French), or write:

General Motors of Canada Limited
Customer Care Centre,
Mail Code: CA1-163-005
1908 Colonel Sam Drive
Oshawa, Ontario L1H 8P7

Vehicle Data Recording and Privacy

This GM vehicle has a number of sophisticated computers that record information about the vehicle's performance and how it is driven. For example, the vehicle uses computer modules to monitor and control engine and transmission performance, to monitor the conditions for airbag deployment and deploy airbags in a crash, and, if so equipped, to provide antilock braking to help the driver control the vehicle. These modules may store data to help your dealer technician service the vehicle. Some modules may also store data about how you operate the vehicle, such as rate of fuel consumption or average speed. These modules may also retain the owner's personal preferences, such as radio pre-sets, seat positions, and temperature settings.

Event Data Recorders

This vehicle has an Event Data Recorder (EDR). The main purpose of an EDR is to record, in certain crash or near crash-like situations, such as an airbag deployment or hitting a road obstacle, data that will assist in understanding how a vehicle's systems performed. The EDR is designed to record data related to vehicle dynamics and safety systems for a short period of time, typically 30 seconds or less. The EDR in this vehicle is designed to record such data as:

- How various systems in the vehicle were operating.
- Whether or not the driver and passenger safety belts were buckled/fastened.
- How far, if at all, the driver was pressing the accelerator and/or brake pedal.
- How fast the vehicle was traveling.

This data can help provide a better understanding of the circumstances in which crashes and injuries occur.

Important: EDR data is recorded by the vehicle only if a non-trivial crash situation occurs; no data is recorded by the EDR under normal driving conditions and no personal data (e.g., name, gender, age, and crash location) is recorded. However, other parties, such as law enforcement, could combine the EDR data with the type of personally identifying data routinely acquired during a crash investigation.

To read data recorded by an EDR, special equipment is required, and access to the vehicle or the EDR is needed. In addition to the vehicle manufacturer, other parties, such as law enforcement, that have the special equipment, can read the information if they have access to the vehicle or the EDR.

GM will not access this data or share it with others except: with the consent of the vehicle owner or, if the vehicle is leased, with the consent of the lessee; in response to an official request by police or similar government office; as part of GM's defense of litigation through the discovery process; or, as required by law. Data that GM collects or receives may also be used for GM research needs or may be made available to others for research purposes, where a need is shown and the data is not tied to a specific vehicle or vehicle owner.

OnStar®

If the vehicle is equipped with an active OnStar system, that system may also record data in crash or near crash-like situations. The OnStar Terms and Conditions provides information on data collection and use and is available at www.onstar.com (U.S.) or www.onstar.ca (Canada), or by pressing the  button and speaking to an advisor. See *OnStar Overview on page 14-1* for more information.

Navigation System

If the vehicle has a navigation system, use of the system may result in the storage of destinations, addresses, telephone numbers, and other trip information. Refer to the navigation manual for information on stored data and for deletion instructions.

Radio Frequency Identification (RFID)

RFID technology is used in some vehicles for functions such as tire pressure monitoring and ignition system security, as well as in connection with conveniences such as key fobs for remote door locking/unlocking and starting, and in-vehicle transmitters for garage door openers. RFID technology in GM vehicles does not use or record personal information or link with any other GM system containing personal information.

Radio Frequency Statement

This vehicle has systems that operate on a radio frequency that comply with Part 15 of the Federal Communications Commission (FCC) rules and with Industry Canada Standards RSS-GEN/210/220/310.

Operation is subject to the following two conditions:

1. The device may not cause harmful interference.
2. The device must accept any interference received, including interference that may cause undesired operation of the device.

Changes or modifications to any of these systems by other than an authorized service facility could void authorization to use this equipment.

OnStar

OnStar Overview

OnStar Overview 14-1

OnStar Services

Emergency 14-2

Security 14-2

Navigation 14-2

Connections 14-4

Diagnostics 14-5

OnStar Additional Information

OnStar Additional
Information 14-5

OnStar Overview



If equipped, this vehicle has a comprehensive, in-vehicle system that can connect to a live Advisor for Emergency, Security, Navigation, Connection, and Diagnostic Services.

Overview

The OnStar system status light is next to the OnStar buttons. If the status light is:

- Solid Green: System is ready.
- Flashing Green: On a call.
- Red: Indicates a problem.

Push  or call 1-888-4-ONSTAR (1-888-466-7827) to speak to an Advisor.

Push  to:

- Make a call, end a call, or answer an incoming call.
- Give OnStar Hands-Free Calling voice commands.
- Give OnStar Turn-by-Turn Navigation voice commands. Requires the available Directions and Connections service plan.

Push  to connect to a live Advisor to:

- Verify account information or update contact information.
- Get driving directions. Requires the available Directions and Connections service plan.
- Receive On-Demand Diagnostics for a check on the vehicle's key operating systems.
- Receive Roadside Assistance.

Push  to get a priority connection to an Emergency Advisor available 24/7 to:

- Get help for an emergency.
- Be a Good Samaritan or respond to an AMBER Alert.
- Get crisis assistance and evacuation routes.

OnStar Services

Emergency

With Automatic Crash Response, the built-in system can automatically connect to help in a crash even if you cannot ask for it.

Push  to connect to an Emergency Advisor. GPS technology is used to identify the vehicle location and can provide critical information to emergency personnel. The Advisor is also trained to offer critical assistance in emergency situations.

Security

OnStar provides services like Stolen Vehicle Assistance, Remote Ignition Block, and Roadside Assistance, if the vehicle is equipped with these services. OnStar can unlock the vehicle doors remotely, if it is equipped with automatic door locks, and can help police locate the vehicle if it is stolen.

Navigation

OnStar navigation requires the Directions and Connections service plan.

Push  to receive directions or have them sent to the vehicle navigation screen. Destinations can also be forwarded to the vehicle from Google Maps™ or MapQuest.com. The OnStar mapping database is continuously updated. Visit www.onstar.com for coverage maps.

Turn-by-Turn Navigation

1. Push  to connect to a live Advisor.
2. Request directions.
3. Directions are downloaded to the vehicle.
4. Follow the voice-guided commands.

Using Voice Commands During a Planned Route

Cancel Route

1. Push . System responds: "OnStar ready," then a tone. Say "Cancel route." System responds: "Would you like to cancel route directions to your destination?"
2. Say "Yes." System responds: "OK, route canceled."
3. Say "Goodbye." Exits voice commands.

Route Preview

1. Push . System responds: "OnStar ready," then a tone.
2. Say "Route Preview." System responds with the next three maneuvers.
3. Say "Goodbye." Exits voice commands.

Repeat

1. Push . System responds: "OnStar ready," then a tone.
2. Say "Repeat." System responds with the last direction given, then responds with "OnStar ready," then a tone.
3. Say "Goodbye." Exits voice commands.

Get My Destination

1. Push . System responds: "OnStar ready," then a tone.
2. Say "Get my destination." System responds with miles to the destination, then responds with "OnStar ready," then a tone.
3. Say "Goodbye." Exits voice commands.

Other Navigation Services Available from OnStar

OnStar eNav: Allows subscribers to send destinations from Google Maps™ and MapQuest.com to their Turn-by-Turn Navigation or screen-based navigation system. When ready, the directions will be downloaded to the vehicle.

Destination Download:

Push , then request the Advisor to download directions to the navigation system in the vehicle. After the call ends, push the "Go" button on the navigation screen to begin driving directions.

Destinations can also be downloaded on the go. For information about eNav, Destination Download, and coverage maps visit www.onstar.com.

Connections

OnStar Hands-Free Calling allows calls to be made and received from the vehicle. The vehicle can also be controlled from a cell phone through the OnStar mobile app. See www.onstar.com for coverage maps.

Hands-Free Calling

1. Push . System responds: "OnStar ready."
2. Say "Dial." System responds: "Please say the name or number to call."
3. Say the entire number without pausing, including a "1" and the area code. System responds: "OK calling."

Retrieve My Number

1. Push . System responds: "OnStar ready."
2. Say "My Number." System responds: "Your OnStar Hands-Free Calling number is."

End a Call

Push . System responds: "Call ended."

Store a Name Tag for Speed Dialing

1. Push . System responds: "OnStar ready."
2. Say "Store." System responds: "Please say the number you would like to store."
3. Say the entire number without pausing. System responds: "Please say the name tag."

4. Pick a name tag. "System responds: "About to store <name tag>. Does that sound OK?"
5. Say "Yes" or "No" to try again. System responds: "OK, storing <name tag>."

Place a Call Using a Stored Number

1. Push . System responds: "OnStar ready."
2. Say "Call <name tag>." System responds: "OK, calling <name tag>."

Verify Minutes and Expiration

Push  and say "minutes" then "verify" to check how many minutes remain and their expiration date.

OnStar Mobile App

With an iPhone® or Android™-based mobile device, an OnStar mobile app can be downloaded. The vehicle can be remote started, if equipped, or the doors can be unlocked from anywhere there is cell phone service. It can also check the fuel level, tire pressure, and oil life. It can connect to an OnStar Advisor anytime. For OnStar mobile app compatibility or further information, see www.onstar.com.

Diagnostics

OnStar Vehicle Diagnostics will perform a vehicle check every month. It will check the engine, transmission, antilock brakes, and major vehicle systems. It also checks the tire pressures, if the vehicle is equipped with the Tire Pressure Monitoring System. If a diagnostics check is needed between e-mails, push , and an Advisor can run a check.

OnStar Additional Information

Transferring Service

Push  to request account transfer eligibility information. The Advisor can assist in canceling or removing account information. **If OnStar receives information that vehicle ownership has changed, OnStar may send a voice message to the vehicle, requesting updated account information.**

Reactivation for Subsequent Owners

Push  and follow the prompts to speak to an Advisor as soon as possible after acquiring the vehicle. The Advisor will update vehicle records and will explain the OnStar service offers and options available.

How OnStar Service Works

Automatic Crash Response, Emergency Services, Crisis Assist, Stolen Vehicle Assistance, Vehicle Diagnostics, Remote Door Unlock, Roadside Assistance, Turn-by-Turn Navigation, and Hands-Free Calling are available on most vehicles. Not all OnStar services are available everywhere or on all vehicles. For more information, a full description of OnStar services, system limitations, and OnStar terms and conditions, see www.onstar.com (U.S.) or www.onstar.ca (Canada); contact OnStar at 1-888-4-ONSTAR (1-888-466-7827) or TTY 1-877-248-2080; or push  to speak with an Advisor. OnStar services require a vehicle electrical system, wireless service, and GPS satellite technologies to be available and operating for features to function properly. These systems may not operate if the battery is discharged or disconnected.

OnStar service cannot work unless your vehicle is in a place where OnStar has an agreement with a wireless service provider for service in that area, and the wireless service provider has coverage, network capacity, reception, and technology compatible with OnStar's service. Service involving location information about the vehicle cannot work unless GPS signals are available, unobstructed, and compatible with the OnStar hardware. OnStar service may not work if the OnStar equipment is not properly installed or it has not been properly maintained. If equipment or software is added, connected, or modified, OnStar service may not work. Other problems beyond OnStar's control may prevent service such as hills, tall buildings, tunnels, weather, electrical system design and architecture of the vehicle, damage to the vehicle in a crash, or wireless phone network congestion or jamming.

See *Radio Frequency Statement on page 13-23* for information regarding Part 15 of the Federal Communications Commission (FCC) rules and Industry Canada Standards RSS-GEN/210/220/310.

Services for People with Disabilities

Advisors provide services to help subscribers with physical disabilities and medical conditions.

Push  for help with:

- Locating a gas station with an attendant to pump gas.
- Finding a hotel, restaurant, etc., that meets accessibility needs.
- Providing directions to the closest hospital or pharmacy in urgent situations.

TTY Users

OnStar has the ability to communicate to the deaf, hard-of-hearing, or speech-impaired customers while in the vehicle. The available dealer-installed TTY system can provide in-vehicle access to all of the OnStar services, except Virtual Advisor and OnStar Turn-by-Turn Navigation.

Onstar.com

The website provides access to account information, manages the OnStar subscription, and allows viewing of videos of each service. Get subscription plan pricing and sign up for OnStar Vehicle Diagnostics. Click on the "My Account" tab on the home page.

OnStar Personal Identification Number (PIN)

A PIN is needed to access some of the OnStar services, like Remote Door Unlock and Stolen Vehicle Assistance. You will be prompted to change the PIN the first time when speaking with an Advisor. To change the OnStar PIN, call OnStar and provide the Advisor with the current number.

Warranty

OnStar equipment may be warranted as part of the new-vehicle limited warranty. The manufacturer of the vehicle furnishes detailed warranty information.

Languages

The vehicle can be programmed to respond in French or Spanish. Push  and ask an Advisor. Advisors can speak French or Spanish.

Potential Issues

Some OnStar services are disabled after five days. OnStar cannot perform Remote Door Unlock or Stolen Vehicle Assistance after the vehicle has been off continuously for five days. After five days, OnStar can contact Roadside Assistance and a locksmith to help gain access to the vehicle.

Global Positioning System (GPS)

- Obstruction of the GPS can occur in a large city with tall buildings; in parking garages; around airports; in tunnels, underpasses, or parking garages; or in an area with very dense trees. If GPS signals are not available, the OnStar system should still operate to call OnStar. However, OnStar could have difficulty identifying the exact location.
- In emergency situations, OnStar can use the last stored GPS location to send to emergency responders.
- A temporary loss of GPS can cause loss of the ability to send a Turn-by-Turn Navigation route. The Advisor may give a verbal route or may ask for a call back after the vehicle is driven into an open area.

Cellular and GPS Antennas

Avoid placing items over or near the antenna to prevent blocking cellular and GPS signal reception. Cellular reception is required for OnStar to send remote signals to the vehicle.

Unable to Connect to OnStar Message

If there is limited cellular coverage or the cellular network has reached maximum capacity, this message may come on. Push  to try the call again or try again after driving a few miles into another cellular area.

Vehicle and Power Issues

OnStar services require a vehicle electrical system, wireless service, and GPS satellite technologies to be available and operating for features to function properly. These systems may not operate if the battery is discharged or disconnected.

Add-on Electrical Equipment

The OnStar system is integrated into the electrical architecture of the vehicle. Do not add any electrical equipment. See *Add-On Electrical Equipment on page 9-58*. Added electrical equipment may interfere with the operation of the OnStar system and cause it to not operate.

Privacy

The complete OnStar Privacy Statement may be found at www.onstar.com. Privacy-sensitive users of wireless communications are cautioned that the privacy of any information sent via wireless cellular communications cannot be assured. Third parties may unlawfully intercept or access transmissions and private communications without consent.

A

Accessories and
Modifications 10-3

Accessory Power 9-21

Adaptive Forward
Lighting (AFL) 6-4

Add-On Electrical
Equipment 9-58

Additional Information,
OnStar® 14-5

Adjustments
Lumbar, Front Seats 3-4

Air Cleaner/Filter, Engine 10-12

Air Filter, Passenger
Compartment 8-10

Air Vents 8-9

Airbag
Adding Equipment to the
Vehicle 3-36

Airbag System
Check 3-37

How Does an Airbag
Restrain? 3-28

Passenger Sensing
System 3-31

Airbag System (cont.)
What Makes an Airbag
Inflate? 3-28

What Will You See after an
Airbag Inflates? 3-29

When Should an Airbag
Inflate? 3-27

Where Are the Airbags? 3-25

Airbags
Passenger Status Indicator 5-18

Readiness Light 5-17

Servicing Airbag-Equipped
Vehicles 3-36

System Check 3-23

Alarm System
Anti-theft 2-14

All-Wheel Drive 10-25, 9-29

AM-FM Radio 7-7

Antenna
Multi-band 7-14

Anti-theft
Alarm System 2-14

Alarm System Messages 5-37

Antilock Brake
System (ABS) 9-30

Warning Light 5-23

Appearance Care
Exterior 10-86

Interior 10-90

Armrest Storage 4-2

Assistance Program,
Roadside 13-8, 13-10

Audio Players 7-14

CD 7-14

CD/DVD 7-16

MP3 7-24, 7-31

Audio System
Radio Reception 7-13

Rear Seat (RSA) 7-50

Theft-Deterrent Feature 7-2

Automatic
Dimming Mirrors 2-18

Door Locks 2-9

Automatic Transmission 9-26

Fluid 10-12

Manual Mode 9-28

Shift Lock Control
Function Check 10-26

Auxiliary Devices 7-38

B

Battery	10-25
Jump Starting	10-79
Load Management	6-8
Power Protection	6-9
Voltage and Charging Messages	5-32
Blade Replacement, Wiper ...	10-27
Bluetooth	7-52
Brake System Warning Light ...	5-22
Brakes	10-23
Antilock	9-30
Assist	9-31
Fluid	10-24
Parking	9-31
System Messages	5-32
Braking	9-3
Break-In, New Vehicle	9-17
Bulb Replacement	10-30
Fog Lamps	6-5
Halogen Bulbs	10-29
Headlamp Aiming	10-28
Headlamps	10-29

Bulb Replacement (cont.) High Intensity Discharge (HID) Lighting	10-29
License Plate Lamps	10-30
Taillamps, Turn Signal, Sidemarker, and Stoplamps	10-29
Buying New Tires	10-54

C

Calibration	5-7
California Fuel Requirements	9-45
Perchlorate Materials Requirements	10-3
Warning	10-3
Camera, Rear Vision	9-38
Canadian Vehicle Owners	iii
Capacities and Specifications	12-2
Carbon Monoxide Engine Exhaust	9-24
Liftgate	2-10
Winter Driving	9-9

Cargo Cover	4-4
Management System	4-4
Tie-Downs	4-4
Cautions, Danger, and Warnings	iv
CD Player	7-14
CD/DVD Player	7-16
Center Console Storage	4-2
Chains, Tire	10-59
Charging System Light	5-19
Check Engine Light	5-20
Ignition Transmission Lock	10-27
Child Restraints Infants and Young Children	3-41
Lower Anchors and Tethers for Children	3-47
Older Children	3-38
Securing	3-55, 3-57
Systems	3-43
Circuit Breakers	10-32

Cleaning
 Exterior Care 10-86
 Interior Care 10-90
 Climate Control Systems
 Dual Automatic 8-1
 Rear 8-7, 8-8
 Clock 5-9
 Cluster, Instrument 5-13
 Collision Damage Repair 13-16
 Compact Spare Tire 10-78
 Compass 5-7
 Compressor Kit, Tire
 Sealant 10-62
 Connections, OnStar® 14-4
 Control of a Vehicle 9-3
 Convenience Net 4-4
 Convex Mirrors 2-17
 Coolant
 Engine 10-14
 Engine Temperature
 Gauge 5-15
 Engine Temperature
 Warning Light 5-24

Cooling System 10-14
 Engine Messages 5-33
 Courtesy Lamps 6-6
 Courtesy Transportation
 Program 13-14
 Cover
 Cargo 4-4
 Engine 10-7
 Cruise Control 9-34
 Light 5-26
 Messages 5-32
 Cupholders 4-1
 Customer Assistance 13-6
 Offices 13-5, 13-6
 Text Telephone (TTY)
 Users 13-6
 Customer Information
 Service Publications
 Ordering Information 13-18
 Customer Satisfaction
 Procedure 13-1, 13-3

D

Damage Repair, Collision 13-16
 Danger, Warnings, and
 Cautions iv
 Data Recorders, Event 13-21
 Daytime Running Lamps/
 Automatic Headlamp
 System 6-3
 Defensive Driving 9-3
 Delayed Entry Lighting 6-7
 Delayed Exit Lighting 6-7
 Delayed Headlamps 6-4
 Delayed Locking 2-9
 Devices, Auxiliary 7-38
 Diagnostics, OnStar® 14-5
 Distracted Driving 9-2
 Dome Lamps 6-6
 Door
 Ajar Messages 5-32
 Delayed Locking 2-9
 Locks 2-8
 Power Locks 2-8

Drive Belt Routing, Engine	12-3
Drive Systems	
All-Wheel Drive	10-25, 9-29
Driver Information	
Center (DIC)	5-27
Driving	
Characteristics and	
Towing Tips	9-49
Defensive	9-3
Drunk	9-3
For Better Fuel Economy	1-22
Highway Hypnosis	9-7
Hill and Mountain Roads	9-8
If the Vehicle is Stuck	9-11
Loss of Control	9-5
Off-Road Recovery	9-5
Vehicle Load Limits	9-12
Wet Roads	9-6
Winter	9-9
Dual Automatic Climate	
Control System	8-1
DVD	
Rear Seat Entertainment	
System	7-40
DVD/CD Player	7-16

E

Electrical Equipment,	
Add-On	9-58
Electrical System	
Engine Compartment	
Fuse Block	10-32
Fuses and Circuit	
Breakers	10-32
Instrument Panel Fuse	
Block	10-35
Overload	10-31
Emergency, OnStar®	14-2
Engine	
Air Cleaner/Filter	10-12
Check and Service Engine	
Soon Light	5-20
Compartment Overview	10-6
Coolant	10-14
Coolant Temperature	
Gauge	5-15
Coolant Temperature	
Warning Light	5-24

Engine (cont.)	
Cooling System	10-14
Cooling System Messages	5-33
Cover	10-7
Drive Belt Routing	12-3
Exhaust	9-24
Heater	9-21
Overheated Protection	
Operating Mode	10-20
Overheating	10-18
Power Messages	5-35
Pressure Light	5-25
Running While Parked	9-25
Starting	9-19
Engine Oil	
Life System	10-10
Messages	5-34
Entry Lighting	6-7
Equipment, Towing	9-56
Event Data Recorders	13-21
Extender, Safety Belt	3-22
Exterior Lamp Controls	6-1

F	
Features	
Memory	1-7
Filter,	
Engine Air Cleaner	10-12
Flash-to-Pass	6-3
Flashers, Hazard Warning	6-4
Flat Tire	10-60
Changing	10-69
Floor Console Storage	4-3
Floor Mats	10-93
Fluid	
Automatic Transmission	10-12
Brakes	10-24
Power Steering	10-21
Washer	10-22
Fog Lamps	
Bulb Replacement	6-5
Folding Mirrors	2-18
Front Fog Lamp	
Light	5-26
Front Seats	
Heated and Ventilated	3-8

Fuel	9-44
Additives	9-45
Filling a Portable Fuel Container	9-48
Filling the Tank	9-46
Fuels in Foreign Countries	9-45
Gasoline Specifications	9-44
Gauge	5-14
Recommended	9-44
Requirements, California	9-45
System Messages	5-35
Fuel Economy	
Driving	1-22
Fuses	
Engine Compartment	
Fuse Block	10-32
Fuses and Circuit	
Breakers	10-32
Instrument Panel Fuse Block	10-35

G	
Garage Door Opener	5-49
Programming	5-49
Gasoline	
Specifications	9-44
Gauges	
Engine Coolant	
Temperature	5-15
Fuel	5-14
Odometer	5-14
Speedometer	5-14
Tachometer	5-14
Voltmeter	5-16
Warning Lights and Indicators	5-12
General Information	
Service and Maintenance	11-1
Towing	9-48
Vehicle Care	10-2
Glove Box	4-1
GM Mobility Reimbursement Program	13-8

H

Halogen Bulbs	10-29
Hazard Warning Flashers	6-4
Head Restraints	3-2
Headlamps	
Adaptive Forward	
Lighting (AFL)	6-4
Aiming	10-28
Bulb Replacement	10-29
Daytime Running	
Lamps/Automatic	
Headlamp System	6-3
Delayed	6-4
Flash-to-Pass	6-3
High Intensity Discharge	
(HID) Lighting	10-29
High-Beam On Light	5-26
High/Low Beam Changer	6-2
Heated and Ventilated Front	
Seats	3-8
Heated Mirrors	2-18
Heater	
Engine	9-21

High Voltage Devices and	
Wiring	10-31
High-Beam On Light	5-26
Highway Hypnosis	9-7
Hill and Mountain Roads	9-8
Hill Start Assist (HSA)	9-32
Hood	10-5
Horn	5-5
How to Wear Safety Belts	
Properly	3-15

I

Ignition Positions	9-18
Ignition Transmission Lock	
Check	10-27
Immobilizer	2-15
Infants and Young Children,	
Restraints	3-41
Infotainment	7-1
Instrument Cluster	5-13
Instrument Panel	
Storage Area	4-1
Introduction	iii

J

Jump Starting	10-79
---------------------	-------

K

Key and Lock Messages	5-36
Keyless Entry	
Remote (RKE) System	2-3
Keys	2-2

L

Labeling, Tire Sidewall	10-39
Lamp Messages	5-36
Lamps	
Courtesy	6-6
Dome	6-6
Exterior Controls	6-1
License Plate	10-30
Malfunction Indicator	5-20
Reading	6-6
Lap-Shoulder Belt	3-16
LATCH System	
Replacing Parts after a	
Crash	3-54

LATCH, Lower Anchors and
Tethers for Children 3-47

Liftgate
Carbon Monoxide 2-10

Lighting
Adaptive Forward 6-4
Delayed Entry 6-7
Delayed Exit 6-7
Entry 6-7
Illumination Control 6-6
Parade Dimming 6-8

Lights
Airbag Readiness 5-17
Antilock Brake System
(ABS) Warning 5-23
Brake System Warning 5-22
Charging System 5-19
Cruise Control 5-26
Engine Coolant
Temperature Warning 5-24
Engine Oil Pressure 5-25
Flash-to-Pass 6-3

Lights (cont.)
Front Fog Lamp 5-26
High-Beam On 5-26
High/Low Beam Changer 6-2
Safety Belt Reminders 5-16
Security 5-25
StabiliTrak® Indicator 5-24
Tire Pressure 5-24
Tow/Haul Mode 5-23

Locks
Automatic Door 2-9
Delayed Locking 2-9
Door 2-8
Lockout Protection 2-9
Power Door 2-8
Safety 2-9

Loss of Control 9-5

Lower Anchors and
Tethers for Children
(LATCH System) 3-47

Lumbar Adjustment 3-4
Front Seats 3-4

M

Maintenance
Records 11-15

Maintenance Schedule
Recommended Fluids
and Lubricants 11-12

Malfunction Indicator Lamp 5-20

Manual Mode 9-28

Memory Features 1-7

Memory Seats 3-6

Messages
Airbag System 5-37
Anti-theft Alarm System 5-37

Battery Voltage and
Charging 5-32

Brake System 5-32

Door Ajar 5-32

Engine Cooling System 5-33

Engine Oil 5-34

Engine Power 5-35

Fuel System 5-35

Messages (cont.)
 Key and Lock 5-36
 Lamp 5-36
 Object Detection System 5-36
 Ride Control System 5-37
 Service Vehicle 5-38
 Tire 5-38
 Transmission 5-39
 Vehicle 5-31
 Vehicle Reminder 5-40
 Vehicle Speed 5-40
 Washer Fluid 5-40

Mirrors
 Automatic Dimming 2-18
 Automatic Dimming
 Rearview 2-19
 Convex 2-17
 Folding 2-18
 Heated 2-18
 Park Tilt 2-19
 Power 2-17

Monitor System, Tire
 Pressure 10-46

MP3 7-24, 7-31

Multi-band Antenna 7-14

N

Navigation
 Vehicle Data Recording
 and Privacy 13-22
 Navigation, OnStar® 14-2
 Net, Convenience 4-4
 New Vehicle Break-In 9-17

O

Object Detection System
 Messages 5-36

Odometer 5-14

Off-Road
 Recovery 9-5

Oil
 Engine 10-8
 Engine Oil Life System 10-10
 Messages 5-34
 Pressure Light 5-25

Older Children, Restraints 3-38

Online Owner Center 13-7

OnStar®
 Additional Information 14-5
 Connections 14-4
 Diagnostics 14-5
 Emergency 14-2
 Navigation 14-2
 Overview 14-1
 Security 14-2

OnStar® System 1-23

Operation, Infotainment
 System 7-2

Ordering
 Service Publications 13-18

Outlets
 Power 5-10

Overheated Engine
 Protection
 Operating Mode 10-20

Overheating, Engine 10-18

Overview, OnStar® 14-1

P

Parade Dimming 6-8
 Park
 Shifting into 9-22
 Shifting out of 9-23
 Park Tilt Mirrors 2-19
 Parking
 Assist, Ultrasonic 9-37
 Brake 9-31
 Brake and P (Park)
 Mechanism Check 10-27
 Over Things That Burn 9-24
 Passenger Airbag Status
 Indicator 5-18
 Passenger Compartment Air
 Filter 8-10
 Passenger Sensing System ... 3-31
 Perchlorate Materials
 Requirements, California 10-3
 Personalization
 Vehicle 5-41

Phone
 Bluetooth 7-52
 Power
 Door Locks 2-8
 Mirrors 2-17
 Outlets 5-10
 Protection, Battery 6-9
 Retained Accessory (RAP) ... 9-21
 Seat Adjustment 3-3
 Steering Fluid 10-21
 Windows 2-20
 Pregnancy, Using Safety
 Belts 3-21
 Privacy
 Radio Frequency
 Identification (RFID) 13-22
 Program
 Courtesy Transportation 13-14
 Proposition 65 Warning,
 California 10-3

R

Radio Frequency
 Identification (RFID) 13-22
 Statement 13-23
 Radios
 AM-FM Radio 7-7
 CD/DVD Player 7-16
 Reception 7-13
 Satellite 7-9
 Reading Lamps 6-6
 Rear Climate Control
 System 8-7, 8-8
 Rear Seat Audio (RSA)
 System 7-50
 Rear Seat Entertainment
 System 7-40
 Rear Seat Audio (RSA) 7-50
 Rear Seats 3-9
 Rear Vision Camera (RVC) ... 9-38
 Rear Window Washer/Wiper ... 5-6
 Rearview Mirror
 Automatic Dimming 2-19
 Reclining Seatbacks 3-4

Recommended	
Fuel	9-44
Recommended Fluids and	
Lubricants	11-12
Records	
Maintenance	11-15
Recreational Vehicle	
Towing	10-83
Reimbursement Program,	
GM Mobility	13-8
Remote Keyless Entry (RKE)	
System	2-3
Remote Vehicle Start	2-5
Replacement Bulbs	10-30
Replacement Parts	
Airbags	3-38
Maintenance	11-14
Replacing Airbag System	3-38
Replacing LATCH System	
Parts after a Crash	3-54
Replacing Safety Belt	
System Parts after a Crash ...	3-23

Reporting Safety Defects	
Canadian Government	13-20
General Motors	13-20
U.S. Government	13-19
Restraints	
Where to Put	3-45
Retained Accessory	
Power (RAP)	9-21
Ride Control Systems	
Messages	5-37
Roads	
Driving, Wet	9-6
Roadside Assistance	
Program	13-8, 13-10
Roof	
Sunroof	2-22
Roof Rack System	4-5
Rotation, Tires	10-52
Routing, Engine Drive Belt	12-3
Running the Vehicle While	
Parked	9-25

S

Safety Belts	3-14
Care	3-22
Extender	3-22
How to Wear Safety Belts	
Properly	3-15
Lap-Shoulder Belt	3-16
Reminders	5-16
Replacing after a Crash	3-23
Use During Pregnancy	3-21
Safety Defects Reporting	
Canadian Government	13-20
General Motors	13-20
U.S. Government	13-19
Safety Locks	2-9
Safety System Check	3-22
Satellite Radio	7-9
Scheduling Appointments	13-14
Sealant Kit, Tire	10-62

Seats		Service (cont.)		Spare Tire	
Head Restraints	3-2	Maintenance Records	11-15	Compact	10-78
Heated and Ventilated Front	3-8	Maintenance, General		Specifications and	
Lumbar Adjustment, Front	3-4	Information	11-1	Capacities	12-2
Memory	3-6	Parts Identification Label	12-1	Speedometer	5-14
Power Adjustment, Front	3-3	Publications Ordering		StabiliTrak	
Rear	3-9	Information	13-18	Indicator Light	5-24
Reclining Seatbacks	3-4	Scheduling Appointments	13-14	System	9-32
Third Row Seat	3-11	Vehicle Messages	5-38	Start Assist, Hills	9-32
Securing Child		Servicing the Airbag	3-36	Start Vehicle, Remote	2-5
Restraints	3-55, 3-57	Shift Lock Control Function		Starter Switch Check	10-26
Security		Check, Automatic		Starting the Engine	9-19
Light	5-25	Transmission	10-26	Steering	9-4
Vehicle	2-14	Shifting		Fluid, Power	10-21
Security, OnStar®	14-2	Into Park	9-22	Wheel Adjustment	5-2
Service		Out of Park	9-23	Wheel Controls	5-3
Accessories and		Sidemaker and Stoplamps			
Modifications	10-3	Bulb Replacement	10-29		
Doing Your Own Work	10-4	Signals, Turn and			
Engine Soon Light	5-20	Lane-Change	6-5		

Storage Areas	
Armrest	4-2
Cargo Cover	4-4
Cargo Management System ...	4-4
Center Console	4-2
Convenience Net	4-4
Floor Console	4-3
Glove Box	4-1
Instrument Panel	4-1
Roof Rack System	4-5
Storing the Tire Sealant and Compressor Kit	10-69
Stuck Vehicle	9-11
Sun Visors	2-22
Sunroof	2-22
Symbols	iv
System	
Infotainment	7-1
Roof Rack	4-5

T

Tachometer	5-14
Taillamps	
Bulb Replacement	10-29
Text Telephone (TTY) Users ...	13-6
Theft-Deterrent Systems	2-15
Immobilizer	2-15
Third-Row Seats	3-11
Time	5-9
Tires	
Buying New Tires	10-54
Chains	10-59
Changing	10-69
Compact Spare	10-78
Designations	10-41
Different Size	10-56
If a Tire Goes Flat	10-60
Inflation Monitor System ...	10-48
Inspection	10-52
Messages	5-38
Pressure Light	5-24
Pressure Monitor System ...	10-46
Rotation	10-52

Tires (cont.)	
Sealant and Compressor Kit	10-62
Sealant and Compressor Kit, Storing	10-69
Sidewall Labeling	10-39
Terminology and Definitions	10-42
Uniform Tire Quality Grading	10-56
Wheel Alignment and Tire Balance	10-58
Wheel Replacement	10-58
When It Is Time for New Tires	10-53
Tow/Haul Mode	9-29
Tow/Haul Mode Light	5-23
Towing	
Driving Characteristics	9-49
Equipment	9-56
General Information	9-48
Recreational Vehicle	10-83
Trailer	9-54
Vehicle	10-83

Trailer Towing 9-54
 Transmission
 Automatic 9-26
 Fluid, Automatic 10-12
 Messages 5-39
 Transportation Program,
 Courtesy 13-14
 Turn and Lane-Change
 Signals 6-5
 Turn Signal,
 Bulb Replacement 10-29

U

Ultrasonic Parking Assist 9-37
 Uniform Tire Quality
 Grading 10-56
 Universal Remote System 5-49
 Operation 5-52
 Programming 5-49
 Using This Manual iv

V

Vehicle
 Canadian Owners iii
 Control 9-3
 Identification
 Number (VIN) 12-1
 Load Limits 9-12
 Messages 5-31
 Personalization 5-41
 Reminder Messages 5-40
 Remote Start 2-5
 Security 2-14
 Speed Messages 5-40
 Towing 10-83
 Vehicle Care
 Storing the Tire Sealant
 and Compressor Kit 10-69
 Tire Pressure 10-45

Vehicle Identification
 Service Parts Identification
 Label 12-1
 Ventilation, Air 8-9
 Visors 2-22
 Voltage Devices and
 Wiring 10-31
 Voltmeter Gauge 5-16

W

Warning
 Brake System Light 5-22
 Warning Lights, Gauges,
 and Indicators 5-12
 Warnings iv
 Cautions and Danger iv
 Hazard Flashers 6-4
 Washer Fluid 10-22
 Washer Fluid Messages 5-40

Wheels	
Alignment and Tire	
Balance	10-58
Different Size	10-56
Replacement	10-58
When It Is Time for New	
Tires	10-53
Where to Put the Restraint	3-45
Windows	2-20
Power	2-20
Windshield	
Replacement	10-28
Wiper/Washer	5-5
Winter	
Driving	9-9
Wiper Blade Replacement	10-27
Wipers	
Rear Washer	5-6
Wiring, High Voltage	
Devices	10-31