

2008 Buick LaCrosse Owner Manual

Seats and Restraint Systems	1-1	Driving Your Vehicle	4-1
Front Seats	1-2	Your Driving, the Road, and Your Vehicle	4-2
Rear Seats	1-8	Towing	4-27
Safety Belts	1-9	Service and Appearance Care	5-1
Child Restraints	1-29	Service	5-3
Airbag System	1-54	Fuel	5-5
Restraint System Check	1-68	Checking Things Under the Hood	5-10
Features and Controls	2-1	Headlamp Aiming	5-56
Keys	2-3	Bulb Replacement	5-58
Doors and Locks	2-11	Windshield Replacement	5-62
Windows	2-17	Windshield Wiper Blade Replacement	5-62
Theft-Deterrent Systems	2-20	Tires	5-63
Starting and Operating Your Vehicle	2-24	Appearance Care	5-99
Mirrors	2-38	Vehicle Identification	5-107
Object Detection Systems	2-41	Electrical System	5-108
OnStar® System	2-43	Capacities and Specifications	5-116
Universal Home Remote System	2-47	Maintenance Schedule	6-1
Storage Areas	2-52	Maintenance Schedule	6-2
Sunroof	2-54	Customer Assistance Information	7-1
Instrument Panel	3-1	Customer Assistance and Information	7-2
Instrument Panel Overview	3-4	Reporting Safety Defects	7-15
Climate Controls	3-20	Vehicle Data Recording and Privacy	7-17
Warning Lights, Gages, and Indicators	3-30	Index	1
Driver Information Center (DIC)	3-49		
Audio System(s)	3-84		



GENERAL MOTORS, GM, the GM Emblem, BUICK, the BUICK Emblem, and the name LACROSSE are registered trademarks of General Motors Corporation.

This manual includes the latest information at the time it was printed. We reserve the right to make changes after that time without notice. For vehicles first sold in Canada, substitute the name "General Motors of Canada Limited" for Buick Motor Division whenever it appears in this manual.

This manual describes features that may be available in this model, but your vehicle may not have all of them. For example, more than one entertainment system may be offered or your vehicle may have been ordered without a front passenger or rear seats.

Keep this manual in the vehicle for quick reference.

Canadian Owners

A French language copy of this manual can be obtained from your dealer/retailer or from:

Helm, Incorporated
P.O. Box 07130
Detroit, MI 48207
1-800-551-4123
www.helminc.com

Propriétaires Canadiens

On peut obtenir un exemplaire de ce guide en français auprès de concessionnaire ou à l'adresse suivante:

Helm Incorporated
P.O. Box 07130
Detroit, MI 48207
1-800-551-4123
www.helminc.com

Litho in U.S.A.
Part No. 15864654 A First Printing

©2007 General Motors Corporation. All Rights Reserved.

Using this Manual

Many people read the owner manual from beginning to end when they first receive their new vehicle to learn about the vehicle's features and controls. Pictures and words work together to explain things.

Index

A good place to quickly locate information about the vehicle is the Index in the back of the manual. It is an alphabetical list of what is in the manual and the page number where it can be found.

Safety Warnings and Symbols

There are a number of safety cautions in this book. A box with the word CAUTION is used to tell about things that could hurt you or others if you were to ignore the warning.

CAUTION:

These mean there is something that could hurt you or other people.

We tell you what the hazard is and what to do to help avoid or reduce the hazard. Please read these cautions. If you do not, you or others could be hurt.

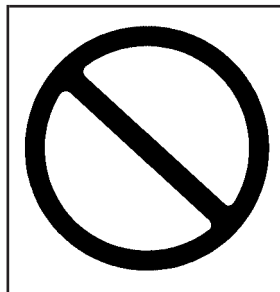

A circle with a slash through it is a safety symbol which means "Do Not," "Do Not do this" or "Do Not let this happen."

Vehicle Damage Warnings

You will also find notices in this manual.

Notice: These mean there is something that could damage your vehicle.

A notice tells about something that can damage the vehicle. Many times, this damage would not be covered by your vehicle's warranty, and it could be costly. The notice tells what to do to help avoid the damage.

When you read other manuals, you might see CAUTION and NOTICE warnings in different colors or in different words.

There are also warning labels on the vehicle which use the same words, CAUTION or NOTICE.

Vehicle Symbols

The vehicle has components and labels that use symbols instead of text. Symbols are shown along with the text describing the operation or information relating to a specific component, control, message, gage, or indicator.

Section 1 Seats and Restraint Systems

Front Seats	1-2	Lower Anchors and Tethers for Children (LATCH)	1-41
Power Seats	1-2	Securing a Child Restraint in a Rear Seat Position	1-47
Power Lumbar	1-3	Securing a Child Restraint in the Center Front Seat Position	1-50
Heated Seats	1-3	Securing a Child Restraint in the Right Front Seat Position	1-50
Reclining Seatbacks	1-4	Airbag System	1-54
Head Restraints	1-6	Where Are the Airbags?	1-57
Center Seat	1-7	When Should an Airbag Inflate?	1-59
Rear Seats	1-8	What Makes an Airbag Inflate?	1-60
Split Folding Rear Seat	1-8	How Does an Airbag Restrain?	1-60
Safety Belts	1-9	What Will You See After an Airbag Inflates?	1-60
Safety Belts: They Are for Everyone	1-9	Passenger Sensing System	1-62
How to Wear Safety Belts Properly	1-14	Servicing Your Airbag-Equipped Vehicle	1-66
Lap-Shoulder Belt	1-22	Adding Equipment to Your Airbag-Equipped Vehicle	1-67
Safety Belt Use During Pregnancy	1-27	Restraint System Check	1-68
Lap Belt	1-28	Checking the Restraint Systems	1-68
Safety Belt Extender	1-29	Replacing Restraint System Parts After a Crash	1-69
Child Restraints	1-29		
Older Children	1-29		
Infants and Young Children	1-33		
Child Restraint Systems	1-37		
Where to Put the Restraint	1-39		

Front Seats

Power Seats

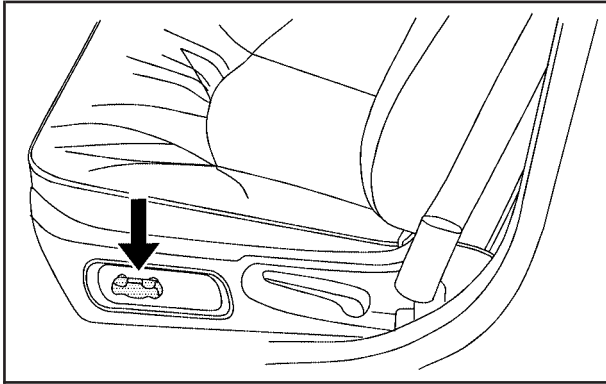

Driver Side shown, Passenger Side similar

If the vehicle has power seats, the controls used to operate them are located on the outboard side of the seats. To adjust the seat, do any of the following:

- Move the seat forward or rearward by sliding the control forward or rearward.
- Raise or lower the front part of the seat cushion by moving the front of the control up or down.
- Raise or lower the rear part of the seat cushion by moving the rear of the control up or down.
- Raise or lower the entire seat by moving the entire control up or down.

Power Lumbar

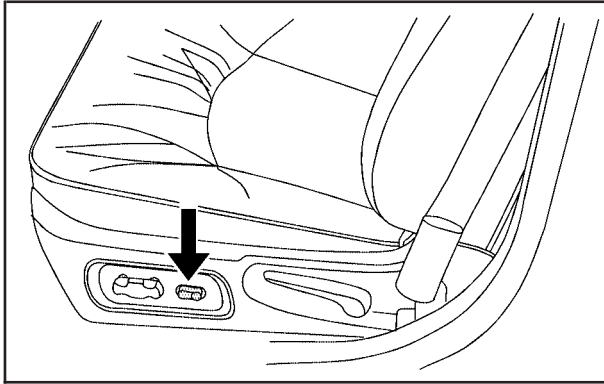

On seats with power lumbar, the control is located on the outboard side of the seat cushion.

Press the front of the control to increase lumbar support.
Press the rear of the control to decrease lumbar support.

Keep in mind that as your seating position changes, as it may during long trips, so should the position of your lumbar support. Adjust the seat as needed.

Heated Seats

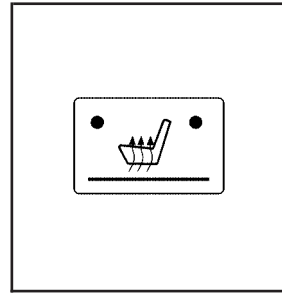

On vehicles with this feature, the buttons are located on the climate control panel.

Press the button once to activate the high heat setting. Both indicator lights on the button will come on. Press the button again to select the lower temperature setting. Only one indicator light will come on. Press the button a third time to turn the heat off.

This feature only works when the ignition is on.

Reclining Seatbacks

CAUTION:

You can lose control of the vehicle if you try to adjust a manual driver's seat while the vehicle is moving. The sudden movement could startle and confuse you, or make you push a pedal when you do not want to. Adjust the driver's seat only when the vehicle is not moving.

CAUTION:

If the seatback is not locked, it could move forward in a sudden stop or crash. That could cause injury to the person sitting there. Always push and pull on the seatback to be sure it is locked.

Your seats have manual reclining seatbacks. The lever used to operate them is located on the outboard side of the seats.

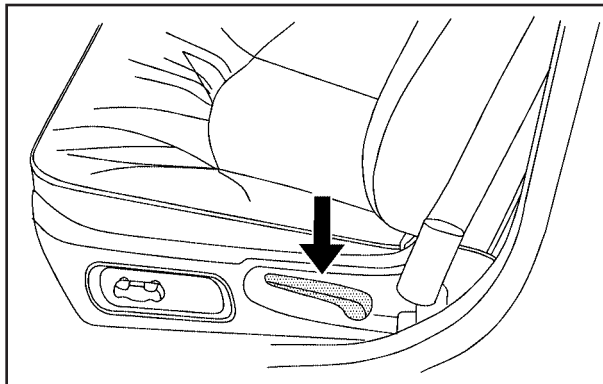

To recline the seatback, do the following:

1. Lift the recline lever.
2. Move the seatback to the desired position, then release the lever to lock the seatback in place.
3. Push and pull on the seatback to make sure it is locked.

To return the seatback to an upright position, do the following:

1. Lift the lever fully without applying pressure to the seatback and the seatback will return to the upright position.
2. Push and pull on the seatback to make sure it is locked.

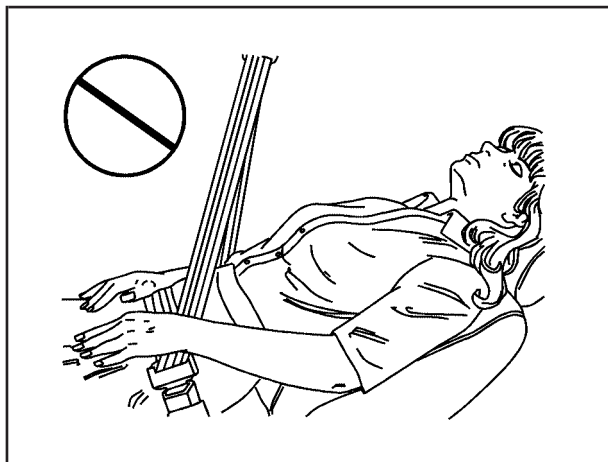

⚠ CAUTION:

Sitting in a reclined position when your vehicle is in motion can be dangerous. Even if you buckle up, your safety belts cannot do their job when you are reclined like this.

The shoulder belt cannot do its job because it will not be against your body. Instead, it will be in front of you. In a crash, you could go into it, receiving neck or other injuries.

The lap belt cannot do its job either. In a crash, the belt could go up over your abdomen. The belt forces would be there, not at your pelvic bones. This could cause serious internal injuries.

For proper protection when the vehicle is in motion, have the seatback upright. Then sit well back in the seat and wear your safety belt properly.

Do not have a seatback reclined if your vehicle is moving.

Head Restraints



Adjust the head restraint so that the top of the restraint is at the same height as the top of the occupant's head. This position reduces the chance of a neck injury in a crash.

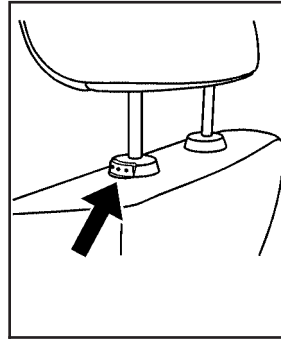

Pull the head restraint up to raise it.

To lower the head restraint, press the button, located on the top of the seatback, and push the head restraint down.

Center Seat

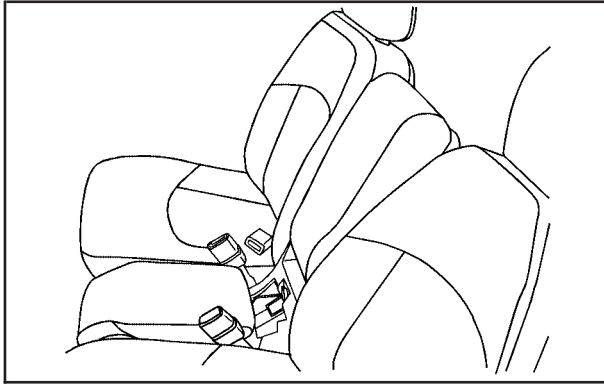

Your vehicle may have a front center seat. There are cupholders on the underside of the seat cushion. To use them, raise the seat cushion. This seat can also be converted to a storage area by lowering the armrest. See *Center Console Storage* on page 2-53.

Rear Seats

Split Folding Rear Seat

If your vehicle has this feature, both sides of the rear seatback can be folded down. This gives direct access to the trunk. Make sure the front seats are not reclined. If they are, the rear seatback(s) may not fold down all the way.

Notice: Folding a rear seat with the safety belts still fastened may cause damage to the seat or the safety belts. Always unbuckle the safety belts and return them to their normal stowed position before folding a rear seat.

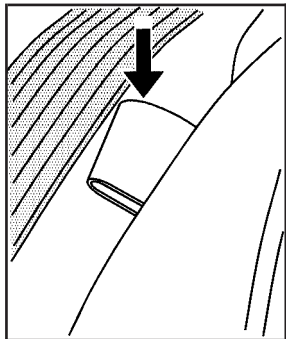

To lower the rear seatback, pull the tab located on the outboard side of the seatback and fold the seatback forward.

CAUTION:

If the seatback is not locked, it could move forward in a sudden stop or crash. That could cause injury to the person sitting there. Always push and pull on the seatback to be sure it is locked.

To raise the rear seatback, lift the seatback up until it latches. Push and pull on the seatback to be sure it is locked in position.

The seatbacks should be kept in the upright, locked position when they are not being used to extend the cargo area.

Safety Belts

Safety Belts: They Are for Everyone

This part of the manual tells you how to use safety belts properly. It also tells you some things you should not do with safety belts.

CAUTION:

Do not let anyone ride where he or she cannot wear a safety belt properly. If you are in a crash and you are not wearing a safety belt, your injuries can be much worse. You can hit things inside the vehicle harder or be ejected from it and be seriously injured or killed. In the same crash, you might not be, if you are buckled up. Always fasten your safety belt, and check that your passenger(s) are restrained properly too.

CAUTION:

It is extremely dangerous to ride in a cargo area, inside or outside of a vehicle. In a collision, people riding in these areas are more likely to be seriously injured or killed. Do not allow people to ride in any area of your vehicle that is not equipped with seats and safety belts. Be sure everyone in your vehicle is in a seat and using a safety belt properly.

Your vehicle has indicators as a reminder to buckle your safety belts. See *Safety Belt Reminders on page 3-32*.

In most states and in all Canadian provinces, the law requires wearing safety belts. Here is why:

You never know if you will be in a crash. If you do have a crash, you do not know if it will be a serious one.

A few crashes are mild, and some crashes can be so serious that even buckled up, a person would not survive. But most crashes are in between. In many of them, people who buckle up can survive and sometimes walk away. Without belts they could have been badly hurt or killed.

After more than 40 years of safety belts in vehicles, the facts are clear. In most crashes buckling up does matter... a lot!

Why Safety Belts Work

When you ride in or on anything, you go as fast as it goes.

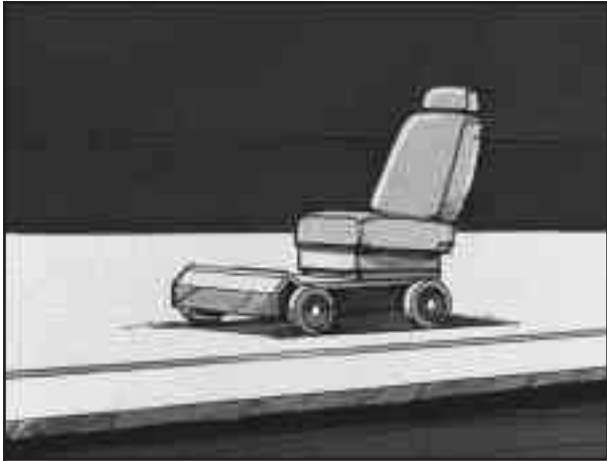

Take the simplest vehicle. Suppose it is just a seat on wheels.



Put someone on it.

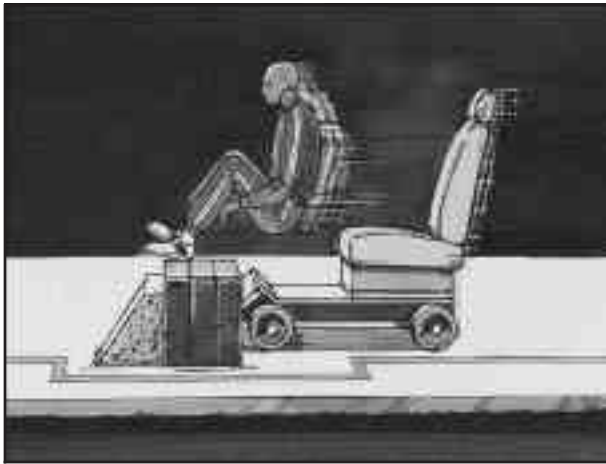

Get it up to speed. Then stop the vehicle. The rider does not stop.



The person keeps going until stopped by something. In a real vehicle, it could be the windshield...



or the instrument panel...



or the safety belts!

With safety belts, you slow down as the vehicle does. You get more time to stop. You stop over more distance, and your strongest bones take the forces. That is why safety belts make such good sense.

Questions and Answers About Safety Belts

Q: Will I be trapped in the vehicle after a crash if I am wearing a safety belt?

A: You *could* be — whether you are wearing a safety belt or not. But your chance of being conscious during and after an accident, so you *can* unbuckle and get out, is *much* greater if you are belted. And you can unbuckle a safety belt, even if you are upside down.

Q: If my vehicle has airbags, why should I have to wear safety belts?

A: Airbags are supplemental systems only; so they work *with* safety belts — not instead of them. Whether or not an airbag is provided, all occupants still have to buckle up to get the most protection. That is true not only in frontal collisions, but especially in side and other collisions.

Q: If I am a good driver, and I never drive far from home, why should I wear safety belts?

A: You may be an excellent driver, but if you are in a crash — even one that is not your fault — you and your passenger(s) can be hurt. Being a good driver does not protect you from things beyond your control, such as bad drivers.

Most accidents occur within 25 miles (40 km) of home. And the greatest number of serious injuries and deaths occur at speeds of less than 40 mph (65 km/h).

Safety belts are for everyone.

How to Wear Safety Belts Properly

This section is only for people of adult size.

Be aware that there are special things to know about safety belts and children. And there are different rules for smaller children and babies. If a child will be riding in your vehicle, see *Older Children on page 1-29* or *Infants and Young Children on page 1-33*. Follow those rules for everyone's protection.

It is very important for all occupants to buckle up. Statistics show that unbelted people are hurt more often in crashes than those who are wearing safety belts.

Occupants who are not buckled up can be thrown out of the vehicle in a crash. And they can strike others in the vehicle who are wearing safety belts.

First, before you or your passenger(s) wear a safety belt, there is important information you should know.

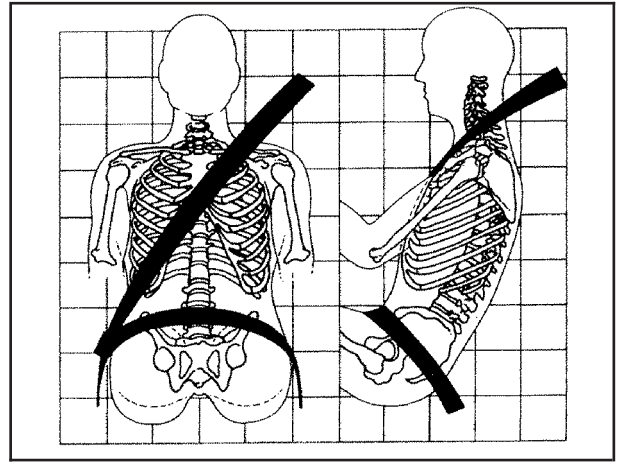

Sit up straight and always keep your feet on the floor in front of you. The lap part of the belt should be worn low and snug on the hips, just touching the thighs. In a crash, this applies force to the strong pelvic bones and you would be less likely to slide under the lap belt. If you slid under it, the belt would apply force on your abdomen. This could cause serious or even fatal injuries. The shoulder belt should go over the shoulder and across the chest. These parts of the body are best able to take belt restraining forces.

The shoulder belt locks if there is a sudden stop or crash.

Q: What is wrong with this?

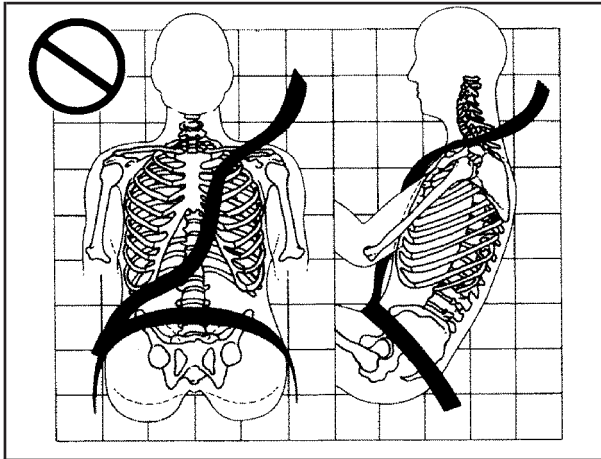

A: The shoulder belt is too loose. It will not give as much protection this way.

⚠ CAUTION:

You can be seriously hurt if your shoulder belt is too loose. In a crash, you would move forward too much, which could increase injury. The shoulder belt should fit snugly against your body.

Q: What is wrong with this?

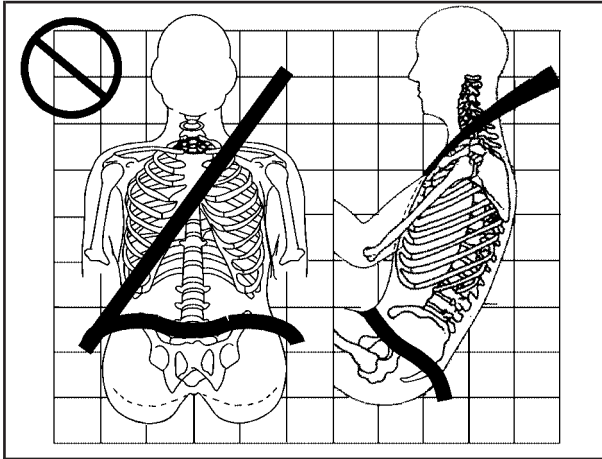

A: The lap belt is too loose. It will not give nearly as much protection this way.

⚠ CAUTION:

You can be seriously hurt if your lap belt is too loose. In a crash, you could slide under the lap belt and apply force on your abdomen. This could cause serious or even fatal injuries. The lap belt should be worn low and snug on the hips, just touching the thighs.

Q: What is wrong with this?

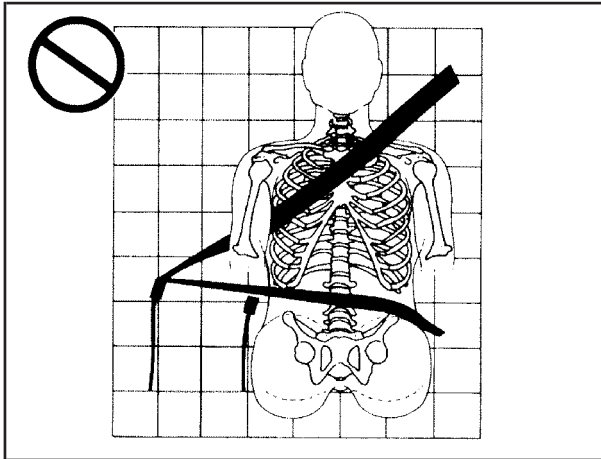

A: The belt is buckled in the wrong place.

⚠ CAUTION:

You can be seriously injured if your belt is buckled in the wrong place like this. In a crash, the belt would go up over your abdomen. The belt forces would be there, not on the pelvic bones. This could cause serious internal injuries. Always buckle your belt into the buckle nearest you.

Q: What is wrong with this?

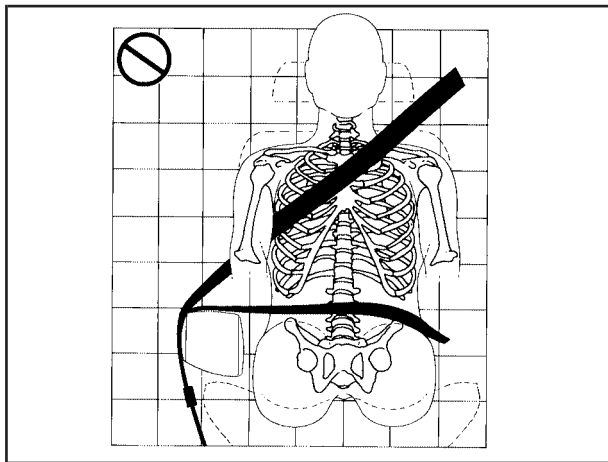

⚠ CAUTION:

You can be seriously injured if your belt goes over an armrest like this. The belt would be much too high. In a crash, you can slide under the belt. The belt force would then be applied on the abdomen, not on the pelvic bones, and that could cause serious or fatal injuries. Be sure the belt goes under the armrests.

A: The belt is over an armrest.

Q: What is wrong with this?

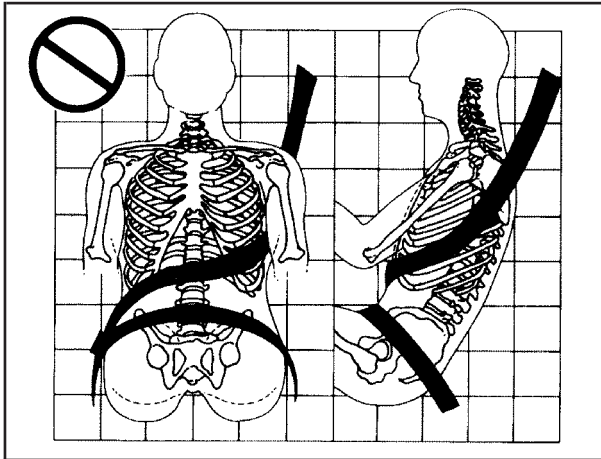

A: The shoulder belt is worn under the arm. It should be worn over the shoulder at all times.

⚠ CAUTION:

You can be seriously injured if you wear the shoulder belt under your arm. In a crash, your body would move too far forward, which would increase the chance of head and neck injury. Also, the belt would apply too much force to the ribs, which are not as strong as shoulder bones. You could also severely injure internal organs like your liver or spleen. The shoulder belt should go over the shoulder and across the chest.

Q: What is wrong with this?

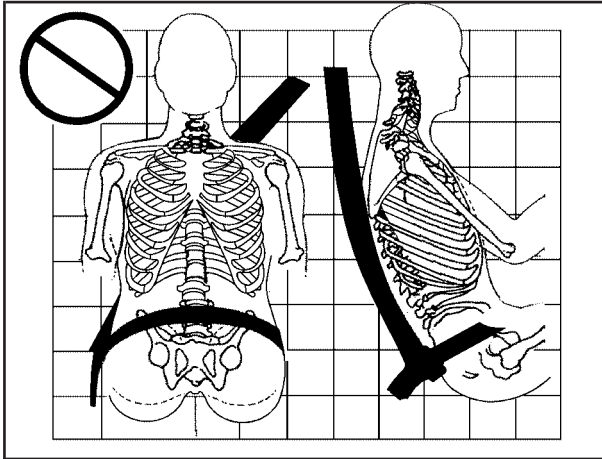

A: The belt is behind the body.

⚠ CAUTION:

You can be seriously injured by not wearing the lap-shoulder belt properly. In a crash, you would not be restrained by the shoulder belt. Your body could move too far forward increasing the chance of head and neck injury. You might also slide under the lap belt. The belt force would then be applied right on the abdomen. That could cause serious or fatal injuries. The shoulder belt should go over the shoulder and across the chest.

Q: What is wrong with this?

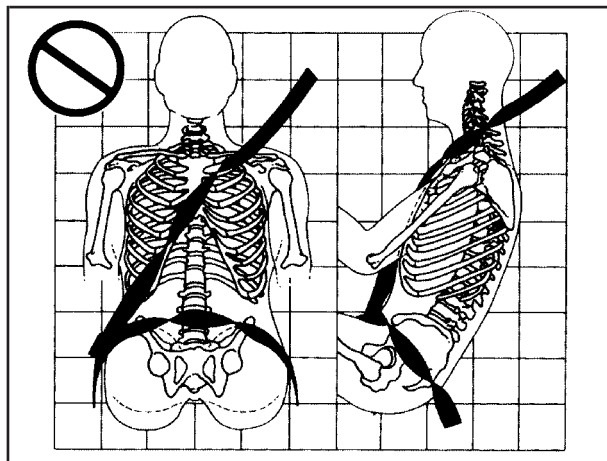

A: The belt is twisted across the body.

⚠ CAUTION:

You can be seriously injured by a twisted belt. In a crash, you would not have the full width of the belt to spread impact forces. If a belt is twisted, make it straight so it can work properly, or ask your dealer/retailer to fix it.

Lap-Shoulder Belt

All seating positions in your vehicle have a lap-shoulder belt except for the center front passenger position, if your vehicle has one, which has a lap belt. See *Lap Belt on page 1-28* for more information.

Here is how to wear a lap-shoulder belt properly.

1. Adjust the seat, if the seat is adjustable, so you can sit up straight. To see how, see “Seats” in the Index.
2. Pick up the latch plate and pull the belt across you. Do not let it get twisted.

The lap-shoulder belt may lock if you pull the belt across you very quickly. If this happens, let the belt go back slightly to unlock it. Then pull the belt across you more slowly.

If you ever pull the shoulder portion of a passenger belt out all the way, you may engage the child restraint locking feature. If this happens, just let the belt go back all the way and start again.

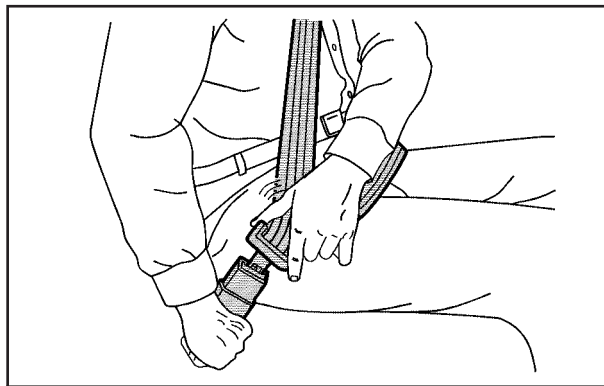

3. Push the latch plate into the buckle until it clicks.
If you find that the latch plate will not go fully into the buckle, see if you are using the correct buckle. Pull up on the latch plate to make sure it is secure. If the belt is not long enough, see *Safety Belt Extender on page 1-29*.
Make sure the release button on the buckle is positioned so you would be able to unbuckle the safety belt quickly if necessary.

4. If equipped with a shoulder belt height adjuster, move it to the height that is right for you. Improper shoulder belt height adjustment could reduce the effectiveness of the safety belt in a crash. See "Shoulder Belt Height Adjustment" later in this section.

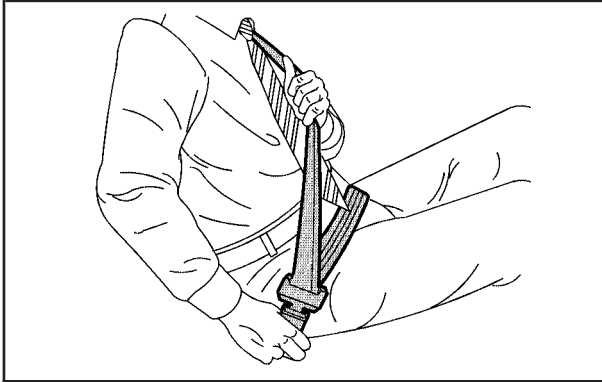

5. To make the lap part tight, pull up on the shoulder belt.

It may be necessary to pull stitching on the safety belt through the latch plate to fully tighten the lap belt on smaller occupants.

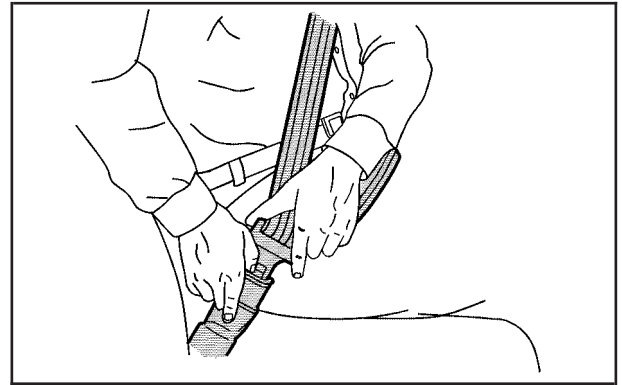

To unlatch the belt, just push the button on the buckle. The belt should go back out of the way. When the safety belt is not in use, slide the latch plate up the safety belt webbing. The latch plate should rest on the stitching on the safety belt, near the guide loop on the side wall.

Before you close a door, be sure the belt is out of the way. If you slam the door on it, you can damage both the belt and your vehicle.

Shoulder Belt Height Adjuster

Your vehicle has a shoulder belt height adjuster for the driver and right front passenger position.

Adjust the height so that the shoulder portion of the belt is centered on your shoulder. The belt should be away from your face and neck, but not falling off your shoulder.

Improper shoulder belt height adjustment could reduce the effectiveness of the safety belt in a crash.

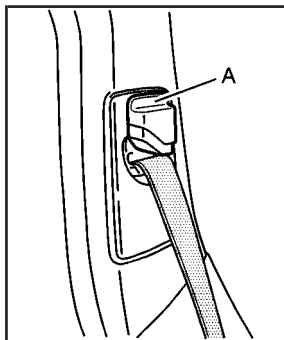

To move it down, press down on the release lever (A) and move the height adjuster to the desired position. You can move the height adjuster up just by pressing up on the shoulder belt guide.

After you move the adjuster to where you want it, try to move it down without squeezing the release lever to make sure it has locked into position.

Safety Belt Pretensioners

Your vehicle has safety belt pretensioners for front outboard occupants. Although you cannot see them, they are part of the safety belt assembly. They can help tighten the safety belts during the early stages of a moderate to severe frontal or near frontal crash if the threshold conditions for pretensioner activation are met.

Pretensioners work only once. If they activate in a crash, you will need to get new ones, and probably other new parts for your safety belt system. See *Replacing Restraint System Parts After a Crash* on page 1-69.

Rear Safety Belt Comfort Guides

Rear shoulder belt comfort guides may provide added safety belt comfort for older children who have outgrown booster seats and for some adults. When installed on a shoulder belt, the comfort guide positions the belt away from the neck and head.

There is one guide for each outboard passenger position in the rear seat. Here is how to install a comfort guide to the safety belt:

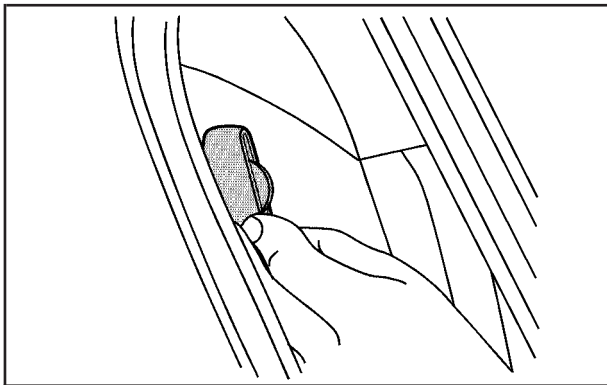

1. Pull the elastic cord out from between the edge of the seatback and the interior body to remove the guide from its storage clip.

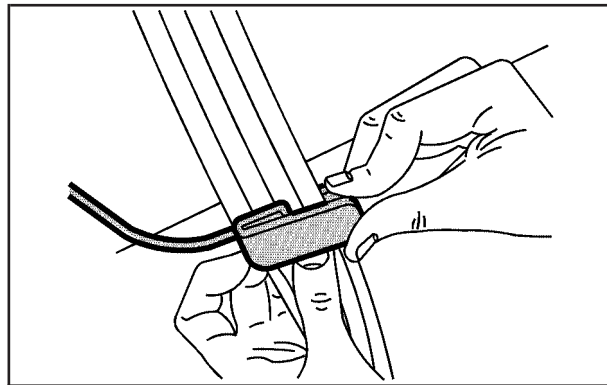

2. Place the guide over the belt and insert the two edges of the belt into the slots of the guide.

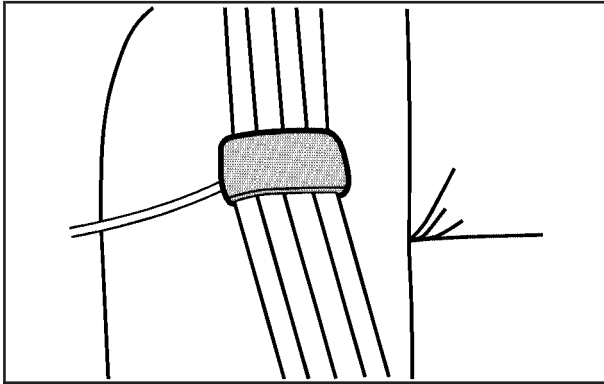

⚠ CAUTION:

A safety belt that is not properly worn may not provide the protection needed in a crash. The person wearing the belt could be seriously injured. The shoulder belt should go over the shoulder and across the chest. These parts of the body are best able to take belt restraining forces.

3. Be sure that the belt is not twisted and it lies flat. The elastic cord must be under the belt and the guide on top.

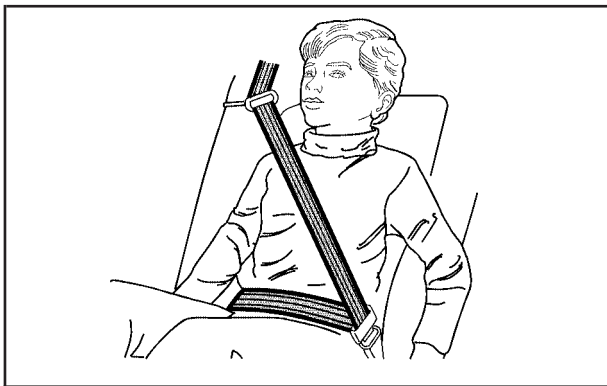

4. Buckle, position, and release the safety belt as described previously in this section. Make sure that the shoulder belt crosses the shoulder.

To remove and store the comfort guide, squeeze the belt edges together so that you can take them out of the guide. Pull the guide upward to expose its storage clip, and then slide the guide onto the clip. Turn the guide and clip inward and slide them in between the seatback and the interior body, leaving only the loop of the elastic cord exposed.

Safety Belt Use During Pregnancy

Safety belts work for everyone, including pregnant women. Like all occupants, they are more likely to be seriously injured if they do not wear safety belts.

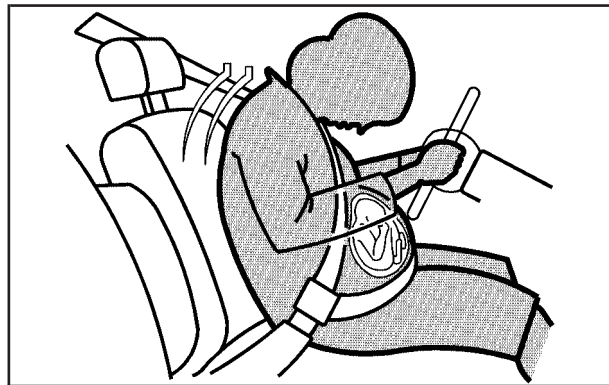

A pregnant woman should wear a lap-shoulder belt, and the lap portion should be worn as low as possible, below the rounding, throughout the pregnancy.

The best way to protect the fetus is to protect the mother. When a safety belt is worn properly, it is more likely that the fetus will not be hurt in a crash. For pregnant women, as for anyone, the key to making safety belts effective is wearing them properly.

Lap Belt

This part is only for the lap belt. To learn how to wear a lap-shoulder belt, see *Lap-Shoulder Belt on page 1-22*.

You vehicle may have a center seating position. When you sit in the center front seating position, you have a lap safety belt, which has no retractor.

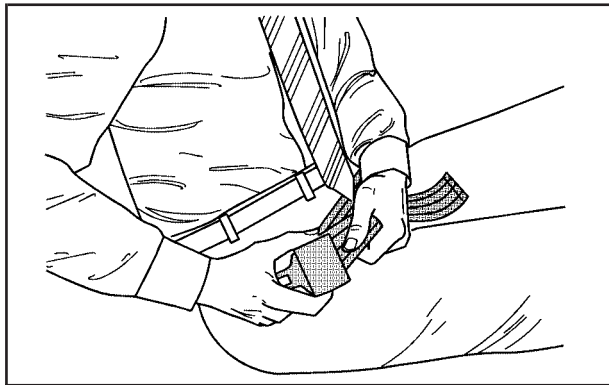

To make the belt longer, tilt the latch plate and pull it along the belt.

Buckle, position and release it the same way as the lap part of a lap-shoulder belt.

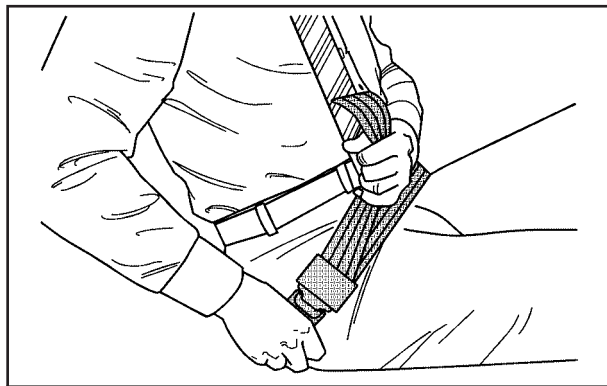

To make the belt shorter, pull its free end as shown until the belt is snug.

If the belt is not long enough, see *Safety Belt Extender on page 1-29*.

Make sure the release button on the buckle is positioned so you would be able to unbuckle the safety belt quickly if necessary.

If you find that the latch plate will not go fully into the buckle, see if you are using the correct buckle. Be sure that the latch plate clicks when inserted into the buckle.

Safety Belt Extender

If the vehicle's safety belt will fasten around you, you should use it.

But if a safety belt is not long enough, your dealer/retailer will order you an extender. When you go in to order it, take the heaviest coat you will wear, so the extender will be long enough for you. To help avoid personal injury, do not let someone else use it, and use it only for the seat it is made to fit. The extender has been designed for adults. Never use it for securing child seats. To wear it, attach it to the regular safety belt. For more information, see the instruction sheet that comes with the extender.

Child Restraints

Older Children

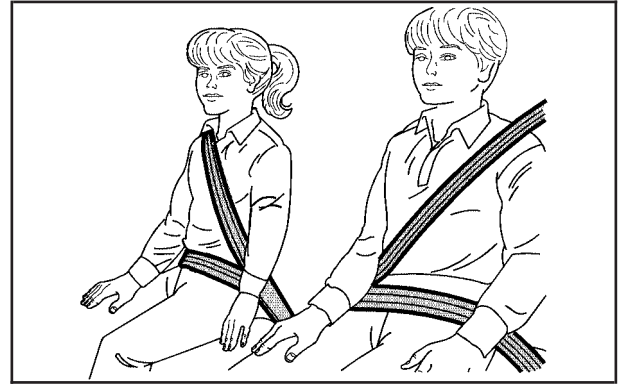

Older children who have outgrown booster seats should wear the vehicle's safety belts.

The manufacturer's instructions that come with the booster seat, state the weight and height limitations for that booster.

Use a booster seat with a lap-shoulder belt until the child passes the below fit test:

- Sit all the way back on the seat. Do the knees bend at the seat edge? If yes, continue. If no, return to the booster seat.
- Buckle the lap-shoulder belt. Does the shoulder belt rest on the shoulder? If yes, continue. If no, try using the rear safety belt comfort guide. See “Rear Safety Belt Comfort Guides” under *Lap-Shoulder Belt on page 1-22* for more information. If the shoulder belt still does not rest on the shoulder, then return to the booster seat.
- Does the lap belt fit low and snug on the hips, touching the thighs? If yes, continue. If no, return to the booster seat.
- Can proper safety belt fit be maintained for length of trip? If yes, continue. If no, return to the booster seat.

If you have the choice, a child should sit in a position with a lap-shoulder belt and get the additional restraint a shoulder belt can provide.

Q: What is the proper way to wear safety belts?

A: An older child should wear a lap-shoulder belt and get the additional restraint a shoulder belt can provide. The shoulder belt should not cross the face or neck. The lap belt should fit snugly below the hips, just touching the top of the thighs. This applies belt force to the child’s pelvic bones in a crash. It should never be worn over the abdomen, which could cause severe or even fatal internal injuries in a crash.

Also see “Rear Safety Belt Comfort Guides” under *Lap-Shoulder Belt on page 1-22*.

According to accident statistics, children and infants are safer when properly restrained in the rear seating positions than in the front seating positions.

In a crash, children who are not buckled up can strike other people who are buckled up, or can be thrown out of the vehicle. Older children need to use safety belts properly.

⚠ CAUTION:

Never do this.

Here two children are wearing the same belt. The belt cannot properly spread the impact forces. In a crash, the two children can be crushed together and seriously injured. A belt must be used by only one person at a time.



⚠ CAUTION:

Never do this.

Here a child is sitting in a seat that has a lap-shoulder belt, but the shoulder part is behind the child. In a crash, the child would not be restrained by the shoulder belt. The child might slide under the lap belt. The belt force would then be applied right on the abdomen. That could cause serious or fatal injuries. The child could also move too far forward increasing the chance of head and neck injury. The shoulder belt should go over the shoulder and across the chest.



Infants and Young Children

Everyone in a vehicle needs protection! This includes infants and all other children. Neither the distance traveled nor the age and size of the traveler changes the need, for everyone, to use safety restraints. In fact, the law in every state in the United States and in every Canadian province says children up to some age must be restrained while in a vehicle.

CAUTION:

Children can be seriously injured or strangled if a shoulder belt is wrapped around their neck and the safety belt continues to tighten. Never leave children unattended in a vehicle and never allow children to play with the safety belts.

Every time infants and young children ride in vehicles, they should have the protection provided by appropriate restraints. Children who are not restrained properly can strike other people, or can be thrown out of the vehicle. In addition, young children should not use the vehicle's adult safety belts alone; they need to use a child restraint.

⚠ CAUTION:

People should never hold an infant in their arms while riding in a vehicle. An infant does not weigh much — until a crash. During a crash an infant will become so heavy it is not possible to hold it. For example, in a crash at only 25 mph (40 km/h), a 12 lb (5.5 kg) infant will suddenly become a 240 lb (110 kg) force on a person's arms. An infant should be secured in an appropriate restraint.

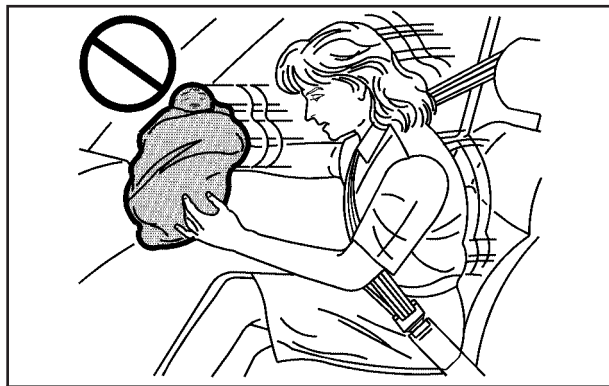

⚠ CAUTION:

Children who are up against, or very close to, any airbag when it inflates can be seriously injured or killed. Airbags plus lap-shoulder belts offer protection for adults and older children, but not for young children and infants. Neither the vehicle's safety belt system nor its airbag system is designed for them. Young children and infants need the protection that a child restraint system can provide.

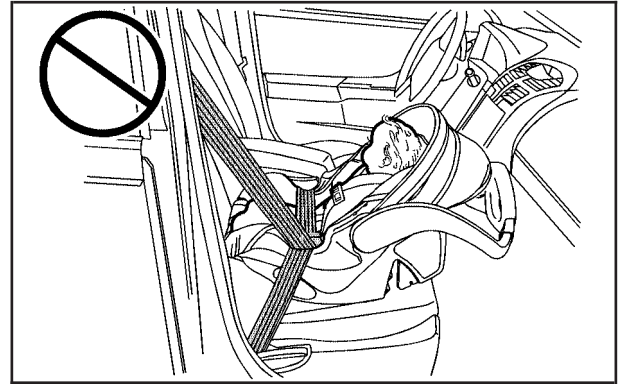

Q: What are the different types of add-on child restraints?

A: Add-on child restraints, which are purchased by the vehicle's owner, are available in four basic types. Selection of a particular restraint should take into consideration not only the child's weight, height, and age but also whether or not the restraint will be compatible with the motor vehicle in which it will be used.

For most basic types of child restraints, there are many different models available. When purchasing a child restraint, be sure it is designed to be used in a motor vehicle. If it is, the restraint will have a label saying that it meets federal motor vehicle safety standards.

The restraint manufacturer's instructions that come with the restraint state the weight and height limitations for a particular child restraint. In addition, there are many kinds of restraints available for children with special needs.

 **CAUTION:**

Newborn infants need complete support, including support for the head and neck. This is necessary because a newborn infant's neck is weak and its head weighs so much compared with the rest of its body. In a crash, an infant in a rear-facing seat settles into the restraint, so the crash forces can be distributed across the strongest part of an infant's body, the back and shoulders. Infants should always be secured in appropriate infant restraints.

⚠ CAUTION:

The body structure of a young child is quite unlike that of an adult or older child, for whom the safety belts are designed. A young child's hip bones are still so small that the vehicle's regular safety belt may not remain low on the hip bones, as it should. Instead, it may settle up around the child's abdomen. In a crash, the belt would apply force on a body area that is unprotected by any bony structure. This alone could cause serious or fatal injuries. Young children should always be secured in appropriate child restraints.

Child Restraint Systems

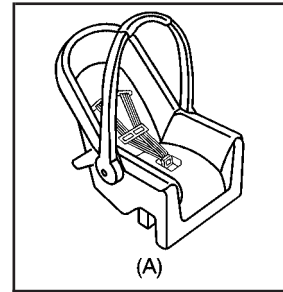

A rear-facing infant seat (A) provides restraint with the seating surface against the back of the infant.

The harness system holds the infant in place and, in a crash, acts to keep the infant positioned in the restraint.

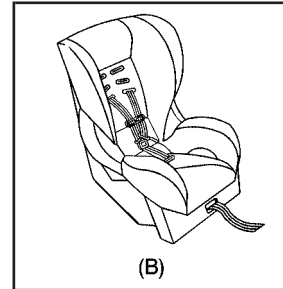

A forward-facing child seat (B) provides restraint for the child's body with the harness.

Securing an Add-On Child Restraint in the Vehicle

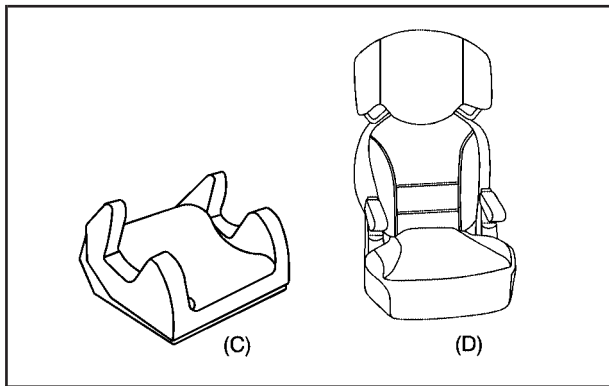

A booster seat (C-D) is a child restraint designed to improve the fit of the vehicle's safety belt system. A booster seat can also help a child to see out the window.

CAUTION:

A child can be seriously injured or killed in a crash if the child restraint is not properly secured in the vehicle. Make sure the child restraint is properly installed in the vehicle using the vehicle's safety belt or LATCH system, following the instructions that came with that restraint, and also the instructions in this manual.

To help reduce the chance of injury, the child restraint must be secured in the vehicle. Child restraint systems must be secured in vehicle seats by lap belts or the lap belt portion of a lap-shoulder belt, or by the LATCH system. See *Lower Anchors and Tethers for Children (LATCH)* on page 1-41 for more information. A child can be endangered in a crash if the child restraint is not properly secured in the vehicle.

When securing an add-on child restraint, refer to the instructions that come with the restraint which may be on the restraint itself or in a booklet, or both, and to this manual. The child restraint instructions are important, so if they are not available, obtain a replacement copy from the manufacturer.

Keep in mind that an unsecured child restraint can move around in a collision or sudden stop and injure people in the vehicle. Be sure to properly secure any child restraint in your vehicle — even when no child is in it.

Securing the Child Within the Child Restraint

CAUTION:

A child can be seriously injured or killed in a crash if the child is not properly secured in the child restraint. Because there are different systems, it is important to refer to the instructions that come with the restraint. Make sure the child is properly secured, following the instructions that came with that restraint.

Where to Put the Restraint

Accident statistics show that children are safer if they are restrained in the rear rather than the front seat.

We recommend that children and child restraints be secured in a rear seat, including: an infant or a child riding in a rear-facing child restraint; a child riding in a forward-facing child seat; an older child riding in a booster seat; and children, who are large enough, using safety belts.

A label on your sun visor says, “Never put a rear-facing child seat in the front.” This is because the risk to the rear-facing child is so great, if the airbag deploys.

 **CAUTION:**

A child in a rear-facing child restraint can be seriously injured or killed if the right front passenger’s airbag inflates. This is because the back of the rear-facing child restraint would be very close to the inflating airbag.

Even though the passenger sensing system is designed to turn off the right front passenger’s frontal airbag if the system detects a rear-facing child restraint, no system is fail-safe, and no one can guarantee that an airbag will not deploy under some unusual circumstance, even though it is turned off. We recommend that rear-facing child restraints be secured in a rear seat, even if the airbag is off.

CAUTION: (Continued)

CAUTION: (Continued)

If you secure a forward-facing child restraint in the right front seat, always move the front passenger seat as far back as it will go. It is better to secure the child restraint in a rear seat.

See *Passenger Sensing System* on page 1-62 for additional information.

 **CAUTION:**

A child in a child restraint in the center front seat can be badly injured or killed by the frontal airbags if they inflate. Never secure a child restraint in the center front seat. It is always better to secure a child restraint in a rear seat.

Do not use child restraints in the center front seat position.

When securing a child restraint in a rear seating position, study the instructions that came with your child restraint to make sure it is compatible with this vehicle.

Wherever you install a child restraint, be sure to secure the child restraint properly.

Keep in mind that an unsecured child restraint can move around in a collision or sudden stop and injure people in the vehicle. Be sure to properly secure any child restraint in your vehicle — even when no child is in it.

Lower Anchors and Tethers for Children (LATCH)

The LATCH system holds a child restraint during driving or in a crash. This system is designed to make installation of a child restraint easier. The LATCH system uses anchors in the vehicle and attachments on the child restraint that are made for use with the LATCH system.

Make sure that a LATCH-compatible child restraint is properly installed using the anchors, or use the vehicle's safety belts to secure the restraint, following the instructions that came with that restraint, and also the instructions in this manual. When installing a child restraint with a top tether, you must also use either the lower anchors or the safety belts to properly secure the child restraint. A child restraint must never be installed using only the top tether and anchor.

In order to use the LATCH system in your vehicle, you need a child restraint that has LATCH attachments. The child restraint manufacturer will provide you with instructions on how to use the child restraint and its attachments. The following explains how to attach a child restraint with these attachments in your vehicle.

Not all vehicle seating positions or child restraints have lower anchors and attachments or top tether anchors and attachments.

Lower Anchors

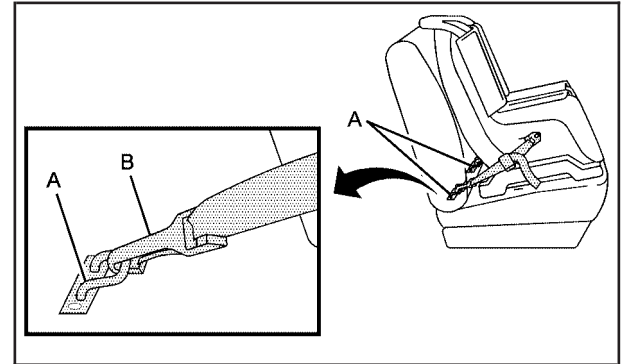

Lower anchors (A) are metal bars built into the vehicle. There are two lower anchors for each LATCH seating position that will accommodate a child restraint with lower attachments (B).

Top Tether Anchor

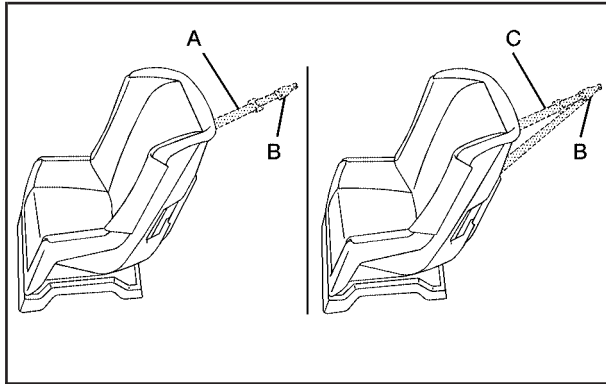

A top tether (A, C) anchors the top of the child restraint to the vehicle. A top tether anchor is built into the vehicle. The top tether attachment (B) on the child restraint connects to the top tether anchor in the vehicle in order to reduce the forward movement and rotation of the child restraint during driving or in a crash.

Your child restraint may have a single tether (A) or a dual tether (C). Either will have a single attachment (B) to secure the top tether to the anchor.

Some child restraints that have top tethers are designed for use with or without the top tether being attached. Others require the top tether always to be attached. In Canada, the law requires that forward-facing child restraints have a top tether, and that the tether be attached. Be sure to read and follow the instructions for your child restraint.

If the child restraint does not have a top tether, one can be obtained, in kit form, for many child restraints. Ask the child restraint manufacturer whether or not a kit is available.

Lower Anchor and Top Tether Anchor Locations

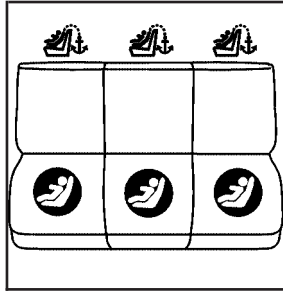

Rear Seat

 (Top Tether Anchor):
Seating positions with top
tether anchors.

 (Lower Anchor):
Seating positions with
two lower anchors.



To assist you in locating
the lower anchors, each
seating position with lower
anchors has two labels,
near the crease between
the seatback and the
seat cushion.

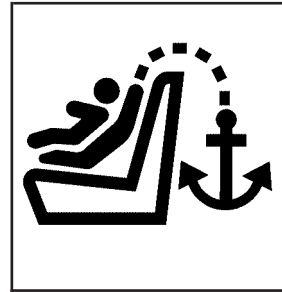

To assist you in locating
the top tether anchors, the
top tether anchor symbol
is located on the cover.

The top tether anchors are located under the covers
on the rear seatback filler panel. Flip open the cover to
access the anchors. Be sure to use an anchor located
on the same side of the vehicle as the seating position
where the child restraint will be placed.

Securing a Child Restraint Designed for the LATCH System

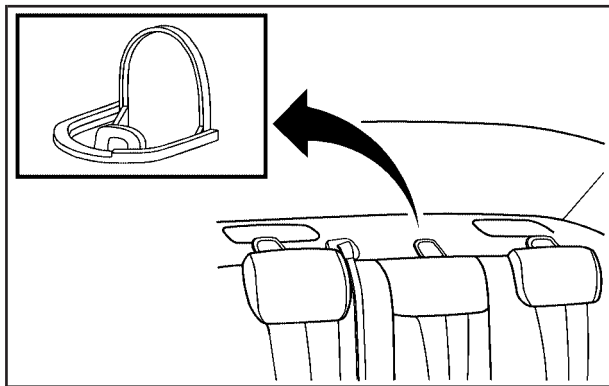

Do not secure a child restraint in a position without a top tether anchor if a national or local law requires that the top tether be attached, or if the instructions that come with the child restraint say that the top tether must be attached.

Accident statistics show that children are safer if they are restrained in the rear rather than the front seat. See *Where to Put the Restraint* on page 1-39 for additional information.

⚠ CAUTION:

If a LATCH-type child restraint is not attached to anchors, the restraint will not be able to protect the child correctly. In a crash, the child could be seriously injured or killed. Make sure that a LATCH-type child restraint is properly installed using the anchors, or use the vehicle's safety belts to secure the restraint, following the instructions that came with that restraint, and also the instructions in this manual.

⚠ CAUTION:

Each top tether anchor and lower anchor in the vehicle is designed to hold only one child restraint. Attaching more than one child restraint to a single anchor could cause the

CAUTION: (Continued)

CAUTION: (Continued)

anchor or attachment to come loose or even break during a crash. A child or others could be injured if this happens. To help prevent injury to people and damage to your vehicle, attach only one child restraint per anchor.

CAUTION:

Children can be seriously injured or strangled if a shoulder belt is wrapped around their neck and the safety belt continues to tighten. Secure any unused safety belts behind the child restraint so children cannot reach them. Pull the shoulder belt all the way out of the retractor to set the lock, if your vehicle has one, after the child restraint has been installed. Be sure to follow the instructions of the child restraint manufacturer.

Notice: Contact between the child restraint LATCH attachment parts and the vehicle's safety belt assembly may cause damage to these parts. Make sure when securing unused safety belts behind the child restraint that there is no contact between the child restraint LATCH attachment parts and the vehicle's safety belt assembly.

Folding an empty rear seat with the safety belts secured may cause damage to the safety belt or the seat. When removing the child restraint, always remember to return the safety belts to their normal, stowed position before folding the rear seat.

1. Attach and tighten the lower attachments to the lower anchors. If the child restraint does not have lower attachments or the desired seating position does not have lower anchors, secure the child restraint with the top tether and the safety belts. Refer to your child restraint manufacturer instructions and the instructions in this manual.
 - 1.1. Find the lower anchors for the desired seating position.
 - 1.2. Put the child restraint on the seat.
 - 1.3. Attach and tighten the lower attachments on the child restraint to the lower anchors.

2. If the child restraint manufacturer recommends that the top tether be attached, attach and tighten the top tether to the top tether anchor, if equipped. Refer to the child restraint instructions and the following steps:

- 2.1. Find the top tether anchor.
- 2.2. Open the top tether anchor cover to expose the anchor.
- 2.3. Route, attach, and tighten the top tether according to your child restraint instructions and the following instructions:

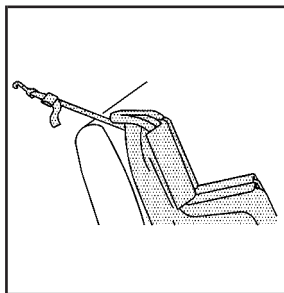

If the position you are using does not have a headrest or head restraint and you are using a single tether, route the tether over the seatback.

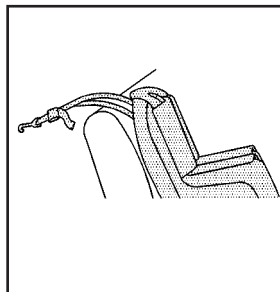

If the position you are using does not have a headrest or head restraint and you are using a dual tether, route the tether over the seatback.

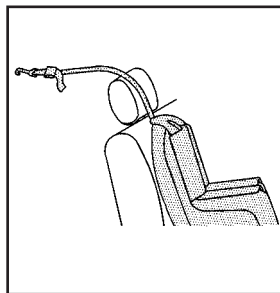

If the position you are using has a fixed headrest or head restraint and you are using a single tether, route the tether over the headrest or head restraint.

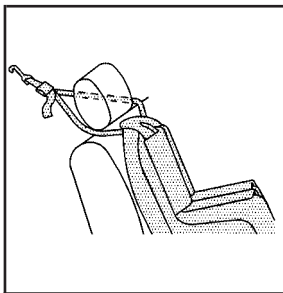

If the position you are using has a fixed headrest or head restraint and you are using a dual tether, route the tether around the headrest or head restraint.

3. Push and pull the child restraint in different directions to be sure it is secure.

Securing a Child Restraint in a Rear Seat Position

When securing a child restraint in a rear seating position, study the instructions that came with your child restraint to make sure it is compatible with this vehicle.

If your child restraint has the LATCH system, see *Lower Anchors and Tethers for Children (LATCH)* on page 1-41 for how to install your child restraint using LATCH. If you secure a child restraint using a safety belt and it uses a top tether, see *Lower Anchors and Tethers for Children (LATCH)* on page 1-41 for top tether anchor locations.

Do not secure a child restraint in a position without a top tether anchor if a national or local law requires that the top tether be anchored, or if the instructions that come with the child restraint say that the top strap must be anchored.

In Canada, the law requires that forward-facing child restraints have a top tether, and that the tether be attached.

If your child restraint does not have the LATCH system, you will be using the safety belt to secure the child restraint in this position. Be sure to follow the instructions that came with the child restraint. Secure the child in the child restraint when and as the instructions say.

If you need to install more than one child restraint in the rear seat, be sure to read *Where to Put the Restraint* on page 1-39.

1. Put the child restraint on the seat.
2. Pick up the latch plate, and run the lap and shoulder portions of the vehicle's safety belt through or around the restraint. The child restraint instructions will show you how.

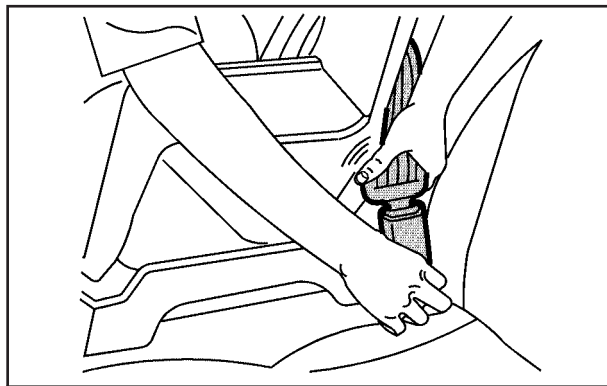

3. Push the latch plate into the buckle until it clicks. Make sure the release button is positioned so you would be able to unbuckle the safety belt quickly if necessary.

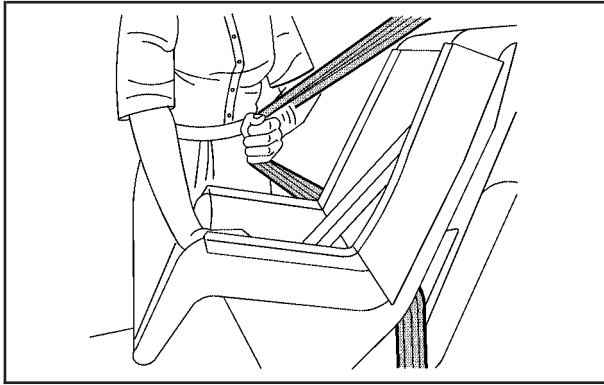

4. Pull the rest of the shoulder belt all the way out of the retractor to set the lock.

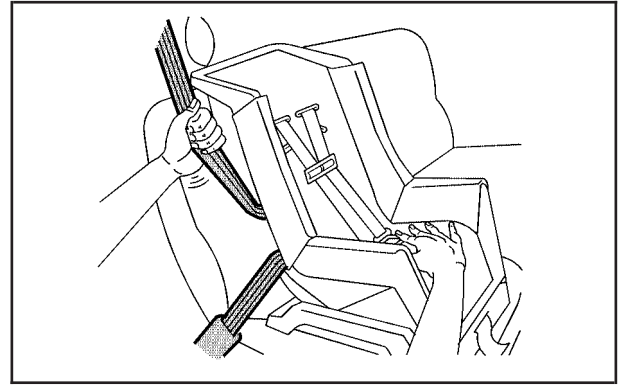

5. To tighten the belt, push down on the child restraint, pull the shoulder portion of the belt to tighten the lap portion of the belt, and feed the shoulder belt back into the retractor. If you are using a forward-facing child restraint, you may find it helpful to use your knee to push down on the child restraint as you tighten the belt.

6. If your child restraint has a top tether, follow the child restraint manufacturer's instructions regarding the use of the top tether. See *Lower Anchors and Tethers for Children (LATCH)* on page 1-41 for more information.
7. Push and pull the child restraint in different directions to be sure it is secure.

To remove the child restraint, unbuckle the vehicle's safety belt and let it go back all the way. If the top tether is attached to a top tether anchor, disconnect it.

Securing a Child Restraint in the Center Front Seat Position

CAUTION:

A child in a child restraint in the center front seat can be badly injured or killed by the frontal airbags if they inflate. Never secure a child restraint in the center front seat. It is always better to secure a child restraint in a rear seat.

Do not use child restraints in the center front seat position.

Securing a Child Restraint in the Right Front Seat Position

Your vehicle has airbags. A rear seat is a safer place to secure a forward-facing child restraint. See *Where to Put the Restraint* on page 1-39.

In addition, your vehicle has a passenger sensing system which is designed to turn off the right front passenger's frontal airbag under certain conditions. See *Passenger Sensing System* on page 1-62 and *Passenger Airbag Status Indicator* on page 3-34 for more information on this, including important safety information.

A label on your sun visor says, "Never put a rear-facing child seat in the front." This is because the risk to the rear-facing child is so great, if the airbag deploys.

 **CAUTION:**

A child in a rear-facing child restraint can be seriously injured or killed if the right front passenger's airbag inflates. This is because the back of the rear-facing child restraint would be very close to the inflating airbag.

Even though the passenger sensing system is designed to turn off the right front passenger's frontal airbag if the system detects a rear-facing child restraint, no system is fail-safe, and no one can guarantee that an airbag will not deploy under some unusual circumstance, even though it is turned off. We recommend that rear-facing child restraints be secured in a rear seat, even if the airbag is off.

If you secure a forward-facing child restraint in the right front seat, always move the front passenger seat as far back as it will go. It is better to secure the child restraint in a rear seat.

See *Passenger Sensing System* on page 1-62 for additional information.

If your child restraint has the LATCH system, see *Lower Anchors and Tethers for Children (LATCH)* on page 1-41 for how to install your child restraint using LATCH. If you secure a child restraint using a safety belt and it uses a top tether, see *Lower Anchors and Tethers for Children (LATCH)* on page 1-41 for top tether anchor locations.

Do not secure a child seat in a position without a top tether anchor if a national or local law requires that the top tether be anchored, or if the instructions that come with the child restraint say that the top strap must be anchored.

In Canada, the law requires that forward-facing child restraints have a top tether, and that the tether be attached.

You will be using the lap-shoulder belt to secure the child restraint in this position. Follow the instructions that came with the child restraint.

1. Move the seat as far back as it will go before securing the forward-facing child restraint.

When the passenger sensing system has turned off the right front passenger's frontal airbag, the off indicator on the passenger airbag status indicator should light and stay lit when you start the vehicle. See *Passenger Airbag Status Indicator* on page 3-34.

2. Put the child restraint on the seat.

3. Pick up the latch plate, and run the lap and shoulder portions of the vehicle's safety belt through or around the restraint. The child restraint instructions will show you how.

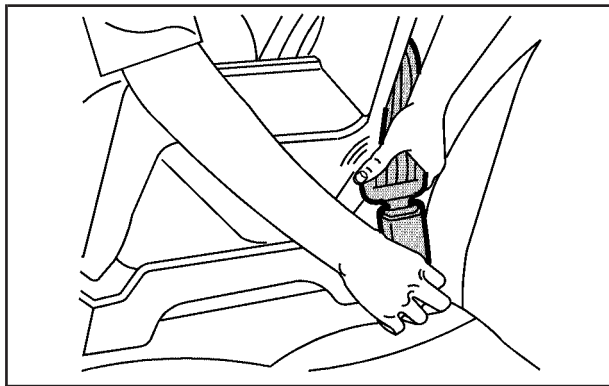

4. Push the latch plate into the buckle until it clicks. Make sure the release button is positioned so you would be able to unbuckle the safety belt quickly if necessary.

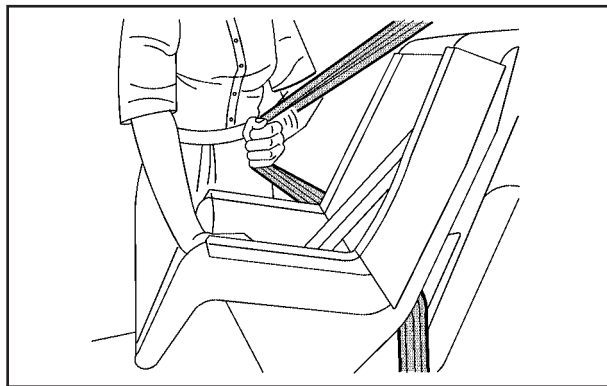

5. Pull the rest of the shoulder belt all the way out of the retractor to set the lock.

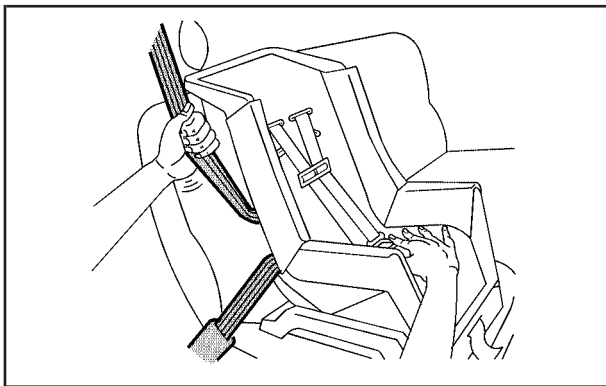

6. To tighten the belt, push down on the child restraint, pull the shoulder portion of the belt to tighten the lap portion of the belt and feed the shoulder belt back into the retractor. If you are using a forward-facing child restraint, you may find it helpful to use your knee to push down on the child restraint as you tighten the belt.
7. Push and pull the child restraint in different directions to be sure it is secure.

If the airbag is off, the off indicator in the passenger airbag status indicator will come on and stay on when the vehicle is started.

If a child restraint has been installed and the on indicator is lit, turn the vehicle off. Remove the child restraint from the vehicle and reinstall the child restraint.

If, after reinstalling the child restraint and restarting the vehicle, the on indicator is still lit, check to make sure that the vehicle's seatback is not pressing the child restraint into the seat cushion. If this happens, slightly recline the vehicle's seatback and adjust the seat cushion if possible. Also make sure the child restraint is not trapped under the vehicle head restraint. If this happens, adjust the head restraint.

Remove any additional material from the seat such as blankets, cushions, seat covers, seat heaters or seat massagers before reinstalling or securing the child restraint.

If the on indicator is still lit, secure the child in the child restraint in a rear seat position in the vehicle and check with your dealer/retailer.

To remove the child restraint, unbuckle the vehicle's safety belt and let it go back all the way.

Airbag System

Your vehicle has the following airbags:

- A frontal airbag for the driver.
- A frontal airbag for the right front passenger

Your vehicle may also have the following airbags:

- A roof-rail airbag for the driver and the passenger seated directly behind the driver.
- A roof-rail airbag for the right front passenger and the passenger seated directly behind the right front passenger.

All of the airbags in your vehicle will have the word AIRBAG embossed in the trim or on an attached label near the deployment opening.

For frontal airbags, the word AIRBAG will appear on the middle part of the steering wheel for the driver and on the instrument panel for the right front passenger.

With roof-rail airbags, the word AIRBAG will appear along the headliner or trim.

Airbags are designed to supplement the protection provided by safety belts. Even though today's airbags are also designed to help reduce the risk of injury from the force of an inflating bag, all airbags must inflate very quickly to do their job.

Here are the most important things to know about the airbag system:

CAUTION:

You can be severely injured or killed in a crash if you are not wearing your safety belt — even if you have airbags. Wearing your safety belt during a crash helps reduce your chance of hitting things inside the vehicle or being ejected from it. Airbags are “supplemental restraints” to the safety belts. All airbags are designed to work with safety belts, but do not replace them.

 **CAUTION:**

Frontal airbags are designed to deploy in moderate to severe frontal and near frontal crashes. They are not designed to inflate in rollover, rear crashes, or in many side crashes.

Roof-rail airbags are designed to inflate in moderate to severe crashes where something hits the side of your vehicle. They are not designed to inflate in frontal, in rollover, or in rear crashes.

Everyone in your vehicle should wear a safety belt properly — whether or not there is an airbag for that person.

 **CAUTION:**

Airbags inflate with great force, faster than the blink of an eye. Anyone who is up against, or very close to, any airbag when it inflates can be seriously injured or killed. Do not sit unnecessarily close to the airbag, as you would be if you were sitting on the edge of your seat or leaning forward. Safety belts help keep you in position before and during a crash. Always wear your safety belt, even with airbags. The driver should sit as far back as possible while still maintaining control of the vehicle.

Occupants should not lean on or sleep against the door or side windows in seating positions with roof-rail airbags.

⚠ CAUTION:

Airbags plus lap-shoulder belts offer the best protection for adults, but not for young children and infants. Neither the vehicle's safety belt system nor its airbag system is designed for them. Young children and infants need the protection that a child restraint system can provide. Always secure children properly in your vehicle. To read how, see *Older Children on page 1-29* or *Infants and Young Children on page 1-33*.



There is an airbag readiness light on the instrument panel, which shows the airbag symbol.

The system checks the airbag electrical system for malfunctions. The light tells you if there is an electrical problem. See *Airbag Readiness Light on page 3-33* for more information.

Where Are the Airbags?



The driver's frontal airbag is in the middle of the steering wheel.



The right front passenger's airbag is in the instrument panel on the passenger's side.



Driver Side shown, Passenger Side similar

If your vehicle has roof-rail airbags for the driver, right front passenger, and second row outboard passengers, they are in the ceiling above the side windows.

⚠ CAUTION:

If something is between an occupant and an airbag, the airbag might not inflate properly or it might force the object into that person causing severe injury or even death. The path of an inflating airbag must be kept clear. Do not put anything between an occupant and an airbag, and do not attach or put anything on the steering wheel hub or on or near any other airbag covering.

If your vehicle has roof-rail airbags, never secure anything to the roof of your vehicle by routing the rope or tie down through any door or window opening. If you do, the path of an inflating roof-rail airbag will be blocked.

When Should an Airbag Inflate?

Frontal airbags are designed to inflate in moderate to severe frontal or near-frontal crashes to help reduce the potential for severe injuries mainly to the driver's or right front passenger's head and chest. However, they are only designed to inflate if the impact exceeds a predetermined deployment threshold. Deployment thresholds are used to predict how severe a crash is likely to be in time for the airbags to inflate and help restrain the occupants.

Whether your frontal airbags will or should deploy is not based on how fast your vehicle is traveling. It depends largely on what you hit, the direction of the impact, and how quickly your vehicle slows down.

Frontal airbags may inflate at different crash speeds. For example:

- If the vehicle hits a stationary object, the airbags could inflate at a different crash speed than if the vehicle hits a moving object.
- If the vehicle hits an object that deforms, the airbags could inflate at a different crash speed than if the vehicle hits an object that does not deform.
- If the vehicle hits a narrow object (like a pole), the airbags could inflate at a different crash speed than if the vehicle hits a wide object (like a wall).
- If the vehicle goes into an object at an angle, the airbags could inflate at a different crash speed than if the vehicle goes straight into the object.

Thresholds can also vary with specific vehicle design. Frontal airbags are not intended to inflate during vehicle rollovers, rear impacts, or in many side impacts.

In addition, your vehicle has dual-stage frontal airbags. Dual-stage airbags adjust the restraint according to crash severity. Your vehicle has electronic frontal sensors, which help the sensing system distinguish between a moderate frontal impact and a more severe frontal impact. For moderate frontal impacts, dual-stage airbags inflate at a level less than full deployment. For more severe frontal impacts, full deployment occurs.

Your vehicle may or may not have roof-rail airbags. See *Airbag System on page 1-54*. Roof-rail airbags are intended to inflate in moderate to severe side crashes. Roof-rail airbags will inflate if the crash severity is above the system's designed threshold level. The threshold level can vary with specific vehicle design.

Roof-rail airbags are not intended to inflate in frontal impacts, near-frontal impacts, rollovers, or rear impacts. A roof-rail airbag is intended to deploy on the side of the vehicle that is struck.

In any particular crash, no one can say whether an airbag should have inflated simply because of the damage to a vehicle or because of what the repair costs were. For frontal airbags, inflation is determined by what the vehicle hits, the angle of the impact, and how quickly the vehicle slows down. For roof-rail airbags, deployment is determined by the location and severity of the side impact.

What Makes an Airbag Inflate?

In a deployment event, the sensing system sends an electrical signal triggering a release of gas from the inflator. Gas from the inflator fills the airbag causing the bag to break out of the cover and deploy. The inflator, the airbag, and related hardware are all part of the airbag module.

Frontal airbag modules are located inside the steering wheel and instrument panel. For vehicles with roof-rail airbags, there are airbag modules in the ceiling of the vehicle, near the side windows that have occupant seating positions.

How Does an Airbag Restrain?

In moderate to severe frontal or near frontal collisions, even belted occupants can contact the steering wheel or the instrument panel. In moderate to severe side collisions, even belted occupants can contact the inside of the vehicle.

Airbags supplement the protection provided by safety belts. Frontal airbags distribute the force of the impact more evenly over the occupant's upper body, stopping the occupant more gradually. Roof-rail airbags distribute the force of the impact more evenly over the occupant's upper body.

But airbags would not help in many types of collisions, primarily because the occupant's motion is not toward those airbags. See *When Should an Airbag Inflate?* on page 1-59 for more information.

Airbags should never be regarded as anything more than a supplement to safety belts.

What Will You See After an Airbag Inflates?

After the frontal airbags inflate, they quickly deflate, so quickly that some people may not even realize an airbag inflated. Roof-rail airbags may still be at least partially inflated for some time after they deploy. Some components of the airbag module may be hot for several minutes. For location of the airbag modules, see *What Makes an Airbag Inflate?* on page 1-60.

The parts of the airbag that come into contact with you may be warm, but not too hot to touch. There may be some smoke and dust coming from the vents in the deflated airbags. Airbag inflation does not prevent the driver from seeing out of the windshield or being able to steer the vehicle, nor does it prevent people from leaving the vehicle.

 **CAUTION:**

When an airbag inflates, there may be dust in the air. This dust could cause breathing problems for people with a history of asthma or other breathing trouble. To avoid this, everyone in the vehicle should get out as soon as it is safe to do so. If you have breathing problems but cannot get out of the vehicle after an airbag inflates, then get fresh air by opening a window or a door. If you experience breathing problems following an airbag deployment, you should seek medical attention.

Your vehicle has a feature that may automatically unlock the doors, turn the interior lamps on, and turn the hazard warning flashers on when the airbags inflate. You can lock the doors, turn the interior lamps off, and turn the hazard warning flashers off by using the controls for those features.

In many crashes severe enough to inflate the airbag, windshields are broken by vehicle deformation. Additional windshield breakage may also occur from the right front passenger airbag.

- Airbags are designed to inflate only once. After an airbag inflates, you will need some new parts for the airbag system. If you do not get them, the airbag system will not be there to help protect you in another crash. A new system will include airbag modules and possibly other parts. The service manual for your vehicle covers the need to replace other parts.
- Your vehicle has a crash sensing and diagnostic module which records information after a crash. See *Vehicle Data Recording and Privacy on page 7-17* and *Event Data Recorders on page 7-18*.
- Let only qualified technicians work on the airbag systems. Improper service can mean that an airbag system will not work properly. See your dealer/retailer for service.

Passenger Sensing System

Your vehicle has a passenger sensing system for the right front passenger's position. The passenger airbag status indicator will be visible on the instrument panel when you start your vehicle.

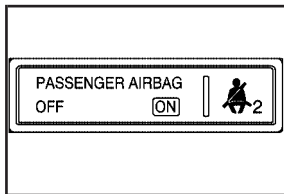

The words ON and OFF will be visible during the system check.

If you are using remote start to start your vehicle from a distance, if equipped, you may not see the system check. When the system check is complete, either the word ON or the word OFF will be visible. See *Passenger Airbag Status Indicator* on page 3-34.

The passenger sensing system will turn off the right front passenger's frontal airbag under certain conditions. The driver's airbags are not part of the passenger sensing system.

The passenger sensing system works with sensors that are part of the right front passenger's seat. The sensors are designed to detect the presence of a properly-seated occupant and determine if the right front passenger's frontal airbag should be enabled (may inflate) or not.

Accident statistics show that children are safer if they are restrained in the rear rather than the front seat.

We recommend that children be secured in a rear seat, including: an infant or a child riding in a rear-facing child restraint; a child riding in a forward-facing child seat; an older child riding in a booster seat; and children, who are large enough, using safety belts.

A label on your sun visor says, "Never put a rear-facing child seat in the front." This is because the risk to the rear-facing child is so great, if the airbag deploys.

 **CAUTION:**

A child in a rear-facing child restraint can be seriously injured or killed if the right front passenger's airbag inflates. This is because the back of the rear-facing child restraint would be very close to the inflating airbag.

Even though the passenger sensing system is designed to turn off the right front passenger's frontal airbag if the system detects a rear-facing child restraint, no system is fail-safe, and no one can guarantee that an airbag will not deploy under some unusual circumstance, even though it is turned off. We recommend that rear-facing child restraints be secured in a rear seat, even if the airbag is off.

If you secure a forward-facing child restraint in the right front seat, always move the front passenger seat as far back as it will go. It is better to secure the child restraint in a rear seat.

The passenger sensing system is designed to turn off the right front passenger's frontal airbag if:

- The right front passenger seat is unoccupied.
- The system determines that an infant is present in a rear-facing infant seat.
- The system determines that a small child is present in a child restraint.
- The system determines that a small child is present in a booster seat.
- A right front passenger takes his/her weight off of the seat for a period of time.
- The right front passenger seat is occupied by a smaller person, such as a child who has outgrown child restraints.
- Or, if there is a critical problem with the airbag system or the passenger sensing system.

When the passenger sensing system has turned off the right front passenger's frontal airbag, the off indicator will light and stay lit to remind you that the airbag is off. See *Passenger Airbag Status Indicator on page 3-34*.

If a child restraint has been installed and the on indicator is lit, turn the vehicle off. Remove the child restraint from the vehicle and reinstall the child restraint following the child restraint manufacturer's directions and refer to *Securing a Child Restraint in the Right Front Seat Position on page 1-50*.

If, after reinstalling the child restraint and restarting the vehicle, the on indicator is still lit, check to make sure that the vehicle's seatback is not pressing the child restraint into the seat cushion. If this happens, slightly recline the vehicle's seatback and adjust the seat cushion if possible. Also make sure the child restraint is not trapped under the vehicle head restraint. If this happens, adjust the head restraint. See *Head Restraints on page 1-6*.

Remove any additional material from the seat such as blankets, cushions, seat covers, seat heaters, or seat massagers before reinstalling or securing the child restraint.

If the on indicator is still lit, secure the child in the child restraint in a rear seat position in the vehicle, and check with your dealer/retailer.

The passenger sensing system is designed to enable (may inflate) the right front passenger's frontal airbag anytime the system senses that a person of adult size is sitting properly in the right front passenger's seat. When the passenger sensing system has allowed the airbag to be enabled, the on indicator will light and stay lit to remind you that the airbag is active.

For some children who have outgrown child restraints and for very small adults, the passenger sensing system may or may not turn off the right front passenger's frontal airbag, depending upon the person's seating posture and body build. Everyone in your vehicle who has outgrown child restraints should wear a safety belt properly — whether or not there is an airbag for that person.

If a person of adult-size is sitting in the right front passenger's seat, but the off indicator is lit, it could be because that person is not sitting properly in the seat. If this happens, turn the vehicle off, remove any additional material from the seat, such as blankets, cushions, seat covers, seat heaters or seat massagers and ask the person to place the seatback in the fully upright position, then sit upright in the seat, centered on the seat cushion, with the person's legs comfortably extended. Restart the vehicle and have the person remain in this position for two to three minutes. This will allow the system to detect that person and then enable the right front passenger's frontal airbag.



Safety belts help keep the passenger in position on the seat during vehicle maneuvers and braking, which helps the passenger sensing system maintain the passenger airbag status. See “Safety Belts” and “Child Restraints” in the Index for additional information about the importance of proper restraint use.

CAUTION:

If the airbag readiness light in the instrument panel cluster ever comes on and stays on, it means that something may be wrong with the airbag system. If this ever happens, have the vehicle serviced promptly, because an adult-size person sitting in the right front passenger’s seat may not have the protection of the airbag(s). See *Airbag Readiness Light on page 3-33* for more on this, including important safety information.

A thick layer of additional material, such as a blanket or cushion, or aftermarket equipment such as seat covers, seat heaters, and seat massagers can affect how well the passenger sensing system operates. We recommend that you not use seat covers or other aftermarket equipment other than any that GM has approved for your specific vehicle. See *Adding Equipment to Your Airbag-Equipped Vehicle on page 1-67* for more information about modifications that can affect how the system operates.

The passenger sensing system may suppress the airbag deployment when liquid soaks into the seat. If this happens, the off indicator in the passenger airbag status indicator and the airbag readiness light on the instrument panel will be lit. The system should resume normal operation after the seat is allowed to dry. If the system operates incorrectly after the seat has dried, have your dealer/retailer check the system.

 **CAUTION:**

Stowing of articles under the passenger's seat or between the passenger's seat cushion and seatback may interfere with the proper operation of the passenger sensing system.

Servicing Your Airbag-Equipped Vehicle

Airbags affect how your vehicle should be serviced. There are parts of the airbag system in several places around your vehicle. Your dealer/retailer and the service manual have information about servicing your vehicle and the airbag system. To purchase a service manual, see *Service Publications Ordering Information* on page 7-16.

 **CAUTION:**

For up to 10 seconds after the ignition is turned off and the battery is disconnected, an airbag can still inflate during improper service. You can be injured if you are close to an airbag when it inflates. Avoid yellow connectors. They are probably part of the airbag system. Be sure to follow proper service procedures, and make sure the person performing work for you is qualified to do so.

Adding Equipment to Your Airbag-Equipped Vehicle

Q: Is there anything I might add to or change about the vehicle that could keep the airbags from working properly?

A: Yes. If you add things that change your vehicle's frame, bumper system, height, front end or side sheet metal, they may keep the airbag system from working properly. Changing or moving any parts of the front seats, safety belts, the airbag sensing and diagnostic module, steering wheel, instrument panel, roof-rail airbag modules, ceiling headliner or pillar garnish trim, front sensors, or airbag wiring can affect the operation of the airbag system.

In addition, your vehicle has a passenger sensing system for the right front passenger's position, which includes sensors that are part of the passenger's seat. The passenger sensing system may not operate properly if the original seat trim is replaced with non-GM covers, upholstery or trim, or with GM covers, upholstery or trim designed for a different vehicle. Any object, such as an aftermarket seat heater or a comfort enhancing pad or device, installed under or on top of the seat fabric, could also

interfere with the operation of the passenger sensing system. This could either prevent proper deployment of the passenger airbag(s) or prevent the passenger sensing system from properly turning off the passenger airbag(s). See *Passenger Sensing System on page 1-62*.

If you have any questions about this, you should contact Customer Assistance before you modify your vehicle. The phone numbers and addresses for Customer Assistance are in Step Two of the Customer Satisfaction Procedure in this manual. See *Customer Satisfaction Procedure on page 7-2*.

Q: Because I have a disability, I have to get my vehicle modified. How can I find out whether this will affect my airbag system?

A: If you have questions, call Customer Assistance. The phone numbers and addresses for Customer Assistance are in Step Two of the Customer Satisfaction Procedure in this manual. See *Customer Satisfaction Procedure on page 7-2*.

In addition, your dealer/retailer and the service manual have information about the location of the airbag sensors, sensing and diagnostic module and airbag wiring.

Restraint System Check

Checking the Restraint Systems

Safety Belts

Now and then, make sure the safety belt reminder light and all your belts, buckles, latch plates, retractors and anchorages are working properly.

Look for any other loose or damaged safety belt system parts. If you see anything that might keep a safety belt system from doing its job, have it repaired. Torn or frayed safety belts may not protect you in a crash. They can rip apart under impact forces. If a belt is torn or frayed, get a new one right away.

Make sure the safety belt reminder light is working. See *Safety Belt Reminders on page 3-32* for more information.

Keep safety belts clean and dry. See *Care of Safety Belts on page 5-102*.

Airbags

The airbag system does not need regularly scheduled maintenance or replacement. Make sure the airbag readiness light is working. See *Airbag Readiness Light on page 3-33* for more information.

Notice: If an airbag covering is damaged, opened, or broken, the airbag may not work properly. Do not open or break the airbag coverings. If there are any opened or broken airbag covers, have the airbag covering and/or airbag module replaced. For the location of the airbag modules, see *What Makes an Airbag Inflate? on page 1-60*. See your dealer/retailer for service.

Replacing Restraint System Parts After a Crash

CAUTION:

A crash can damage the restraint systems in your vehicle. A damaged restraint system may not properly protect the person using it, resulting in serious injury or even death in a crash. To help make sure your restraint systems are working properly after a crash, have them inspected and any necessary replacements made as soon as possible.

If you have had a crash, do you need new belts or LATCH system (if equipped) parts?

After a very minor crash, nothing may be necessary. But the belt assemblies that were used during any crash may have been stressed or damaged. See your dealer/retailer to have your safety belt assemblies inspected or replaced.

If your vehicle has the LATCH system and it was being used during a crash, you may need new LATCH system parts.

New parts and repairs may be necessary even if the belt or LATCH system (if equipped), was not being used at the time of the crash.

If an airbag inflates, you will need to replace airbag system parts. See the part on the airbag system earlier in this section.

Have your safety belt pretensioners checked if your vehicle has been in a crash, if your airbag readiness light stays on after you start your vehicle, or while you are driving. See *Airbag Readiness Light* on page 3-33.

 **NOTES**

Section 2 Features and Controls

Keys	2-3	Starting and Operating Your Vehicle	2-24
Remote Keyless Entry (RKE) System	2-4	New Vehicle Break-In	2-24
Remote Keyless Entry (RKE) System Operation	2-5	Ignition Positions	2-24
Remote Vehicle Start	2-8	Retained Accessory Power (RAP)	2-25
Doors and Locks	2-11	Starting the Engine	2-26
Door Locks	2-11	Engine Coolant Heater	2-27
Power Door Locks	2-11	Active Fuel Management™	2-28
Delayed Locking	2-12	Automatic Transmission Operation	2-29
Automatic Door Lock	2-12	Parking Brake	2-32
Programmable Automatic Door Unlock	2-12	Shifting Into PARK (P)	2-33
Rear Door Security Locks	2-12	Shifting Out of PARK (P)	2-35
Lockout Protection	2-13	Parking Over Things That Burn	2-36
Trunk	2-14	Engine Exhaust	2-37
Windows	2-17	Running the Vehicle While Parked	2-37
Power Windows	2-18	Mirrors	2-38
Sun Visors	2-19	Manual Rearview Mirror	2-38
Theft-Deterrent Systems	2-20	Manual Rearview Mirror with OnStar®	2-38
Content Theft-Deterrent	2-20	Automatic Dimming Rearview Mirror	2-39
PASS-Key® III	2-22	Automatic Dimming Rearview Mirror with OnStar®	2-39
PASS-Key® III Operation	2-22	Outside Power Mirrors	2-40
		Outside Power Heated Mirrors	2-40
		Outside Convex Mirror	2-40

Section 2 Features and Controls

Object Detection Systems	2-41	Storage Areas	2-52
Ultrasonic Rear Parking Assist (URPA)	2-41	Glove Box	2-52
OnStar® System	2-43	Cupholder(s)	2-52
Universal Home Remote System	2-47	Center Console Storage	2-53
Universal Home Remote System	2-47	Convenience Net	2-54
Universal Home Remote System Operation	2-48	Sunroof	2-54

Keys

CAUTION:

Leaving children in a vehicle with the ignition key is dangerous for many reasons, children or others could be badly injured or even killed. They could operate the power windows or other controls or even make the vehicle move. The windows will function with the keys in the ignition and they could be seriously injured or killed if caught in the path of a closing window. Do not leave the keys in a vehicle with children.

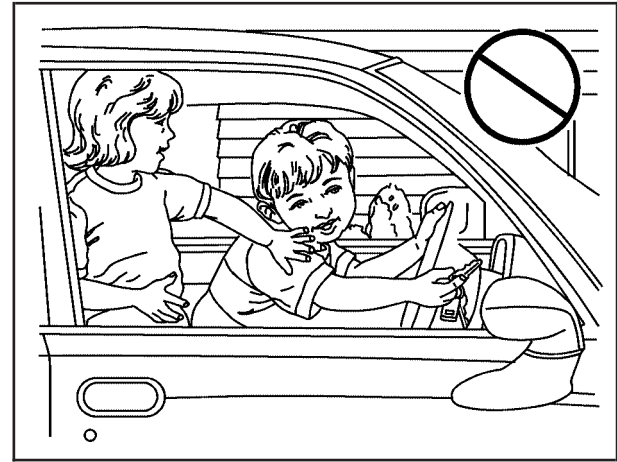

The key can be used for the ignition and all locks.

The key has a bar-coded key tag that the dealer/retailer or qualified locksmith can use to make new keys. Store this information in a safe place, not in your vehicle.

The vehicle has the PASS-Key® III vehicle theft system. The key has a transponder in the key head that matches a decoder in the vehicle's instrument panel. The key will have PK3 stamped on it. If a replacement key or an additional key is needed, it must be purchased from your dealer/retailer or certified locksmith.

Any new PASS-Key® III key must be programmed before it will start the vehicle. See *PASS-Key® III Operation on page 2-22* for more information on programming a new key.

Notice: If you ever lock your keys in your vehicle, you may have to damage the vehicle to get in. Be sure you have spare keys.

In an emergency, contact Roadside Assistance. See *Roadside Assistance Program on page 7-8* for more information.

Remote Keyless Entry (RKE) System

Your Remote Keyless Entry (RKE) system operates on a radio frequency subject to Federal Communications Commission (FCC) Rules and with Industry Canada.

This device complies with Part 15 of the FCC Rules. Operation is subject to the following two conditions:

1. This device may not cause interference.
2. This device must accept any interference received, including interference that may cause undesired operation of the device.

This device complies with RSS-210 of Industry Canada. Operation is subject to the following two conditions:

1. This device may not cause interference.
2. This device must accept any interference received, including interference that may cause undesired operation of the device.

Changes or modifications to this system by other than an authorized service facility could void authorization to use this equipment.

At times you may notice a decrease in operating range. This is normal for any RKE system. If the transmitter does not work or if you have to stand closer to your vehicle for the transmitter to work, try this:

- Check the distance. You may be too far from your vehicle. You may need to stand closer during rainy or snowy weather.
- Check the location. Other vehicles or objects may be blocking the signal. Take a few steps to the left or right, hold the transmitter higher, and try again.
- Check to determine if battery replacement is necessary. See “Battery Replacement” later in this section.
- If you are still having trouble, see your dealer/retailer or a qualified technician for service.



Remote Keyless Entry (RKE) System Operation



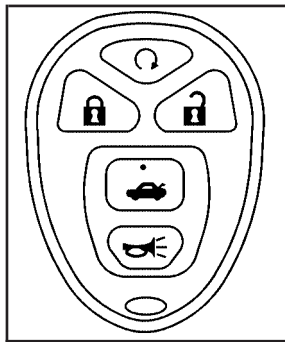

The Remote Keyless Entry (RKE) transmitter functions will work up to 195 feet (60 m) away, however, the operating range may be less while the vehicle is running.





There are other conditions which can affect the performance of the transmitter. See *Remote Keyless Entry (RKE) System on page 2-4*.







**With Remote Start
Shown, Without Remote
Start Similar**

 (Remote Vehicle Start): If your vehicle has this feature, press  to start the engine from outside the vehicle using the RKE transmitter. See *Remote Vehicle Start on page 2-8* for additional information.

 (Lock): Press  to lock all the doors. If enabled through the Driver Information Center (DIC), the parking lamps may flash once to indicate locking has occurred, or the horn may chirp when  is pressed again within five seconds from the previous press of the lock button. See “FOB LOCK FEEDBACK” under *DIC Vehicle Personalization on page 3-76* for additional information. If the vehicle has the content theft-deterrent system, pressing  may also arm it. See *Content Theft-Deterrent on page 2-20*.

 (Unlock): Press  to unlock the driver's door. If  is pressed again within five seconds, all remaining doors will unlock. The interior lamps will come on and stay on for 20 seconds or until the ignition is turned on. If enabled through the DIC, the parking lamps can be programmed to come on for a set amount of time when the vehicle is unlocked using the RKE transmitter. See “EXT (Exterior) LIGHT DELAY” under *DIC Vehicle Personalization on page 3-76*. If the vehicle has the content theft-deterrent system, pressing  on the RKE transmitter may disarm it. See *Content Theft-Deterrent on page 2-20*.

 (Remote Trunk Release): Press and hold  for about one second to release the trunk lid. The transmission must be in PARK (P) for this feature to operate.

 (Panic Alarm): Press  to activate the alarm. The headlamps will flash and the horn will sound repeatedly for two minutes. The alarm will turn off when the ignition is moved to ON/RUN or  is pressed again. The ignition must be in LOCK/OFF or ACC/ACCESSORY for the alarm to work.

Matching Transmitter(s) to Your Vehicle

Each RKE transmitter is coded to prevent another transmitter from unlocking your vehicle. If a transmitter is lost or stolen, a replacement can be purchased through your dealer/retailer. All transmitters need to be re-coded to match the new transmitter. The lost transmitter will no longer work after the new transmitters are re-coded. The vehicle can have a maximum of four transmitters matched to it.

Battery Replacement

Replace the battery if the KEY FOB BATT LOW message displays in the DIC. See “KEY FOB BATTERY LOW” under *DIC Warnings and Messages on page 3-58* for additional information.

Notice: When replacing the battery, use care not to touch any of the circuitry. Static from your body transferred to these surfaces may damage the transmitter.

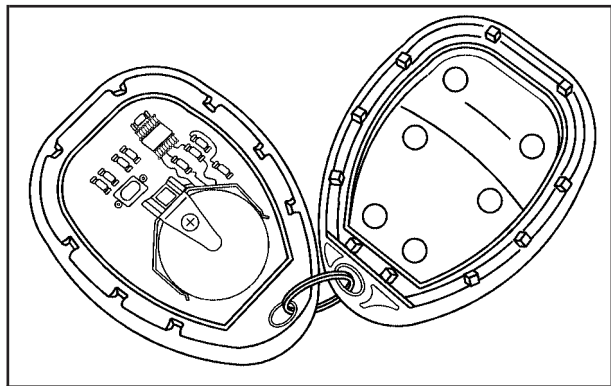

To replace the battery in the RKE transmitter:

1. Separate the halves of the transmitter with a flat, thin object inserted into the notch on the side.
2. Remove the old battery. Do not use a metal object.
3. Insert the new battery, positive side facing up. Replace with a CR2032 or equivalent battery.
4. Put the transmitter back together tightly.

Remote Vehicle Start

Your vehicle may have a remote starting feature that allows you to start the engine from outside the vehicle. It may also start the vehicle's heating or air conditioning systems and rear window defogger. When the remote start system is active and the vehicle has an automatic climate control system, it will automatically regulate the inside temperature. Normal operation of these systems will return after the ignition key is turned to ON/RUN.

Laws in some communities may restrict the use of remote starters. For example, some laws may require a person using remote start to have the vehicle in view when doing so. Check local regulations for any requirements on remote starting of vehicles.

Do not use the remote start feature if your vehicle is low on fuel. Your vehicle may run out of fuel.

There are other conditions which can affect the performance of the transmitter, see *Remote Keyless Entry (RKE) System on page 2-4* for additional information.

 **(Remote Start):** This button will be on the RKE transmitter if you have remote start.

To start the vehicle using the remote start feature:

1. Aim the transmitter at the vehicle.
2. Press and release the transmitter's lock button, then immediately press and hold the transmitter's remote start button for about four seconds or until the vehicle's turn signal lamps flash. The doors will lock.

When the vehicle starts, the parking lamps turn on and remain on while the engine is running.

The remote start feature provides two separate starts per ignition cycle, each with 10 minutes of engine running time, or one start with a time extension. The first start must expire or be canceled to get two separate 10 minute starts.

If it is the first remote start since the vehicle has been driven, repeat the previous steps, while the engine is still running, to extend the engine running time by 10 minutes from the time you repeat the steps for remote starting. The remote start running time can be extended one time and only after the first remote start.

After entering the vehicle during a remote start, insert and turn the key to ON/RUN to drive the vehicle.

The engine will shut off automatically after 10 minutes, unless a time extension has been done or the vehicle's key is inserted into the ignition switch and turned to ON/RUN.

To manually shut off a remote start, do any of the following.

- Aim the RKE transmitter at the vehicle and press and release the remote start button.
- Turn on the hazard warning flashers.
- Turn the ignition switch out of LOCK/OFF position and then back to LOCK/OFF.

The parking lamps turn off to indicate the engine is off.

After the engine has been started two times, or one time with a time extension, the vehicle's ignition must be turned to ON/RUN using the key before the remote start procedure can be used again. See *Ignition Positions on page 2-24* for information regarding the ignition positions on your vehicle.

The remote vehicle start feature will not operate if any of the follow occur:

- The remote start system is disabled through the DIC.
- The vehicle's key is in the ignition.
- A door on the vehicle is open.
- The vehicle's hood is open.
- The hazard warning flashers are on.
- The check engine light is on. See *Malfunction Indicator Lamp on page 3-42*

- The engine coolant temperature is too high.
- The oil pressure is low.
- Two remote vehicle starts, or one start with a time extension, have already been provided for that ignition cycle.

If a remote start is attempted and is unsuccessful, the Driver Information Center (DIC) will display REMOTE START DISABLED.

Vehicles that have the remote start feature are shipped from the factory with the remote vehicle start system enabled. The system may be enabled or disabled through the DIC. See “REMOTE START” under *DIC Vehicle Personalization on page 3-76* for additional

information. If your vehicle does not have the DIC feature, and remote vehicle start was installed at the dealer/retailer, you will need to have the dealer/retailer enable or disable the system.

Remote Start Ready

If your vehicle does not have the remote vehicle start feature, it may have the remote start ready feature. This feature allows your dealer/retailer to add the manufacturer’s remote vehicle start feature.

See your dealer/retailer if you would like to add the manufacturer’s remote vehicle start feature to your vehicle.

Doors and Locks

Door Locks

CAUTION:

Unlocked doors can be dangerous.

- Passengers, especially children, can easily open the doors and fall out of a moving vehicle. When a door is locked, the handle will not open it. You increase the chance of being thrown out of the vehicle in a crash if the doors are not locked. So, wear safety belts properly and lock the doors whenever you drive.
- Young children who get into unlocked vehicles may be unable to get out. A child can be overcome by extreme heat and can suffer permanent injuries or even death from heat stroke. Always lock your vehicle whenever you leave it.
- Outsiders can easily enter through an unlocked door when you slow down or stop your vehicle. Locking your doors can help prevent this from happening.

There are several ways to lock and unlock the vehicle.

From the outside, turn the key in the driver's door lock cylinder briefly counterclockwise to unlock the driver's door. Turn and hold it to unlock all the doors. You can also use the remote keyless entry transmitter. From the inside use the manual or power door locks.

Power Door Locks

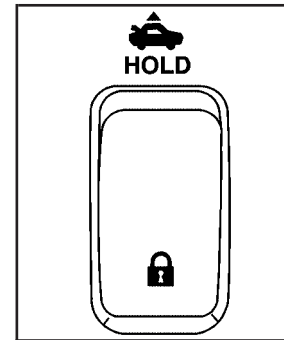

Driver's side shown

To lock or unlock all doors from inside the vehicle, use the power door lock switch located on either front door armrest.

Press the bottom of the switch to lock all doors. Press the top of the switch to unlock all doors.

If the vehicle has the content theft-deterrent system, the vehicle is programmed to arm the system with the power door lock switch. If your vehicle has a Driver Information Center (DIC) this feature can be turned off. See “Content Theft” under *DIC Vehicle Personalization* on page 3-76.

Delayed Locking

Your vehicle may have this feature. It delays the locking of the vehicle’s doors for five seconds after the last door is closed. Two chimes will sound when the power door lock switch or the LOCK button on the Remote Keyless Entry (RKE) transmitter is pressed when a door is open. If your vehicle has a Driver Information Center (DIC), a Delayed Locking warning will be displayed.

The doors can be locked immediately by pressing the power door lock switch or the LOCK button on the transmitter a second time.

The delayed locking feature will not activate when the ignition is in ON/RUN or ACC/ACCESSORY.

You can program this feature on or off through the Driver Information Center (DIC), if equipped. See “Delayed Locking” under *DIC Vehicle Personalization* on page 3-76.

Automatic Door Lock

The vehicle’s doors are programmed to lock when the shift lever is moved into a forward gear.

If someone needs to get in or out of the vehicle after the doors have been locked, place the shift lever into PARK (P). You may also unlock all doors using the power door lock switch or unlock one door using the inside manual door lock.

The automatic door lock feature cannot be disabled.

Programmable Automatic Door Unlock

The vehicle’s doors are programmed from the factory to unlock when the shift lever is moved into PARK (P).

On vehicles with a Driver Information Center (DIC), there are different programming options for unlocking the doors automatically. See *DIC Vehicle Personalization* on page 3-76.

Rear Door Security Locks

Your vehicle has rear door security locks, that prevent passengers from opening the rear doors from the inside.

The rear door security locks are located on the inside edge of each rear door. You must open the rear doors to access them.

To assist you in finding the lock, your vehicle will have one of the following:

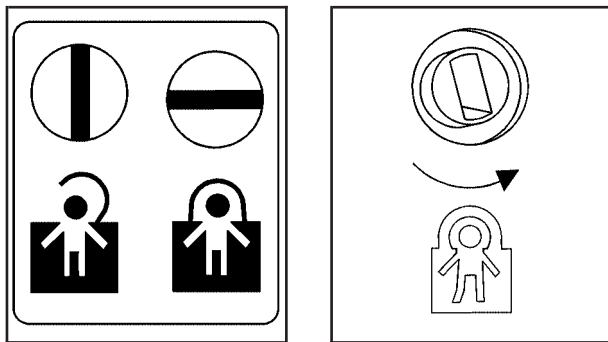

To use these locks, do the following:

1. Insert the key into the security lock slot and turn it so the slot is in the horizontal position.
2. Close the door.
3. Do the same for the other rear door.

When you want to open a rear door when the security lock is on, do the following:

1. Unlock the door using the remote keyless entry transmitter, if the vehicle has one, the power door lock switch, or by lifting the rear door manual lock.
2. Open the door from the outside.

To cancel the rear door security lock, do the following:

1. Unlock the door and open it from the outside.
2. Insert the key into the security lock slot and turn it so the slot is in the vertical position.
3. Do the same for the other rear door.

Lockout Protection

The lockout protection feature makes it more difficult to lock the key in the vehicle. If the driver's door is open while the key is in the ignition, the door cannot be locked with the power door lock switch.

This feature cannot guarantee that you will never be locked out of the vehicle. If the key is not left in the ignition, or, if the manual door lock is used, the key could still be locked inside the vehicle. Always remember to take the key with you.

Trunk

CAUTION:

It can be dangerous to drive with the trunk lid open because carbon monoxide (CO) gas can come into your vehicle. You cannot see or smell CO. It can cause unconsciousness and even death. If you must drive with the trunk lid open or if electrical wiring or other cable connections must pass through the seal between the body and the trunk lid:

- Make sure all other windows are shut.
- Turn the fan on your heating or cooling system to its highest speed and select the control setting that will force outside air into your vehicle. See Climate Control System.
- If you have air outlets on or under the instrument panel, open them all the way.

See *Engine Exhaust* on page 2-37.

Opening the Trunk

To open the trunk from the outside, use the Remote Keyless Entry (RKE) transmitter. See *Remote Keyless Entry (RKE) System Operation* on page 2-5 for more information.

The ignition must be off, or the transmission must be in PARK (P) to open the trunk.

Remote Trunk Release

This feature is used to unlock the trunk from inside the vehicle using the power door lock switch.

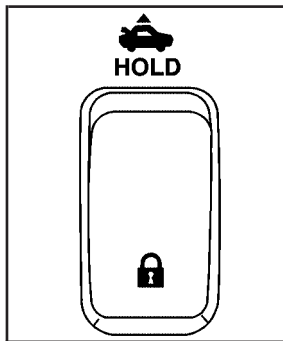

Press and hold the top of the driver's power door lock switch to unlock the trunk.

The vehicle must be in PARK (P) to unlock the trunk.

Emergency Trunk Release Handle

Notice: Do not use the emergency trunk release handle as a tie-down or anchor point when securing items in the trunk as it could damage the handle. The emergency trunk release handle is only intended to aid a person trapped in a latched trunk, enabling them to open the trunk from the inside.

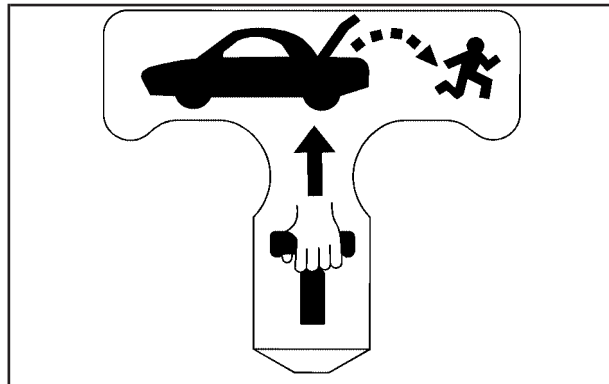

There is a glow-in-the-dark emergency trunk release handle located on the trunk latch of the trunk lid. This handle will glow following exposure to light. If ever needed, pull the emergency trunk release handle to open the trunk from the inside.

Trunk Lid Pull Down Handle and Tie-Down Features

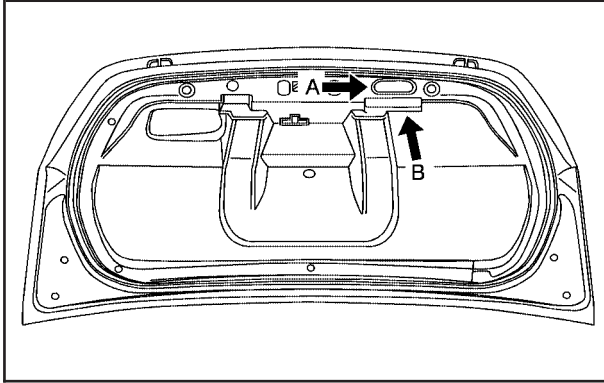

Your vehicle has a trunk lid pull down handle (A) located on the inside of the trunk lid on the driver's side of the vehicle. Use the handle to pull down the trunk lid when closing it.

On vehicles with a tie-down feature (B), it is located inside the trunk lid on the passenger's side of the vehicle and can be used to secure the trunk lid when large items are stored in the trunk.

Windows

CAUTION:

Leaving children, helpless adults, or pets in a vehicle with the windows closed is dangerous. They can be overcome by the extreme heat and suffer permanent injuries or even death from heat stroke. Never leave a child, a helpless adult, or a pet alone in a vehicle, especially with the windows closed in warm or hot weather.

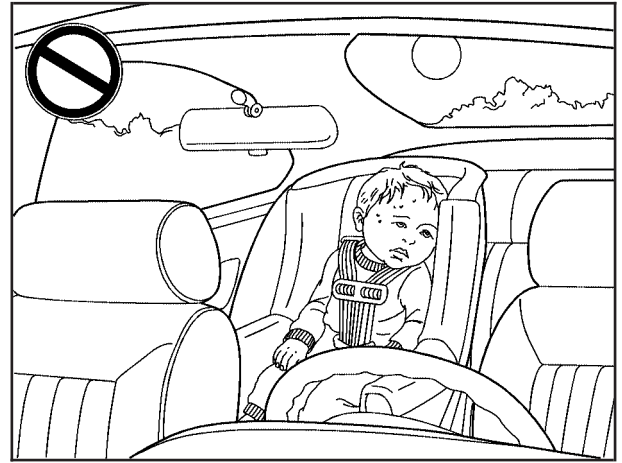

Power Windows

CAUTION:

Leaving children, helpless adults, or pets in a vehicle with the windows closed is dangerous. They can be overcome from extreme heat in warm or hot weather and suffer permanent injuries or even death from heat stroke.

Leaving children in a vehicle with the ignition key is dangerous for many reasons, children or others could be badly injured or even killed. They could operate the power windows or other controls or even make the vehicle move. The windows will function with the keys in the ignition and they could be seriously injured or killed if caught in the path of a closing window. Do not leave keys in a vehicle with children.

When there are children in the rear seat use the window lockout button to prevent unintentional operation of the windows.

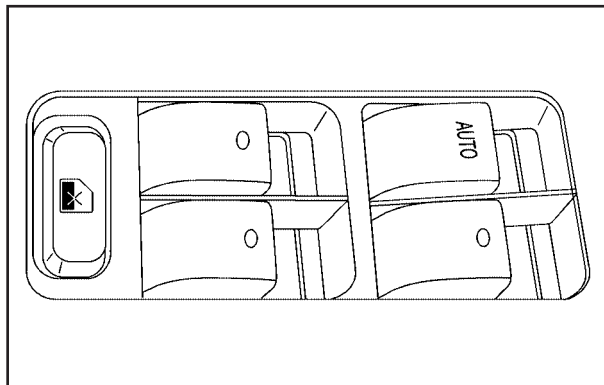

The switches on the driver's door armrest are used to control each of the windows. The power window switches work while the ignition is in ON/RUN, ACC/ACCESSORY, or while Retained Accessory Power (RAP) is active. See *Retained Accessory Power (RAP)* on page 2-25. Each passenger door has its own window switch.

To lower the window, press and hold the front of the switch to the first position until the window is at the desired level. To raise the window, pull up and hold the front of the switch.

Express-Down Window

The driver's window switch has an express-down feature labeled AUTO. This lets you lower the window completely without holding the switch. Press the front of the switch to the second position and release.

To stop the window while it is lowering, briefly pull up on the switch.

Window Lockout

 **(Window Lockout):** The driver's window switches also include a lockout switch. Press the right side of the switch to prevent the rear passengers from using their window switches. The driver can still control all the windows and the front passenger can control their own window with the lockout on. Press the left side of the switch to return to normal window operation. A red bar on the right side of the switch indicates that the lockout is off.

Sun Visors

To block out glare, swing down the sun visors. They can be detached from the center retainer and slid along the rod to cover different areas of the front window and turned to cover the side windows.

Visor Vanity Mirror

Swing down the sun visors and lift the cover to expose the vanity mirror. Do not drive with the cover lifted due to possible glare impeding other drivers behind or to the side of the vehicle.

Theft-Deterrent Systems

Vehicle theft is big business, especially in some cities. Although your vehicle has a number of theft-deterrent features, we know that nothing we put on it can make it impossible to steal.

Content Theft-Deterrent

Your vehicle may have a content theft-deterrent alarm system.

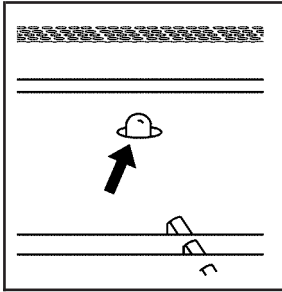

Your vehicle may have a red light located on top of the instrument panel, toward the center of the vehicle and near the windshield, that will flash slowly when the system is armed.

The theft-deterrent alarm system needs to be activated through the Driver Information Center (DIC). See “CONTENT THEFT” under “Customization Menu Items” in *DIC Vehicle Personalization on page 3-76*. While armed, the doors will not unlock with the power door lock switch. The remote alarm will sound if someone tampers with the trunk or enters the vehicle without using the Remote Keyless Entry (RKE) transmitter or key to unlock the doors. The horn will sound and the headlamps will flash for up to two minutes. The system will also cut off the fuel supply, preventing the vehicle from being driven.

Arming with the Power Lock Switch

The vehicle’s content theft-deterrent alarm system can be activated when the key is removed from the ignition and the power door lock switch of either the driver’s or front passenger’s door is used to lock the vehicle. The door needs to be in the open position when pressing the power door lock switch. The system will not arm if the door is closed when the power door lock switch is pressed. This system can be activated through the Driver Information Center (DIC). See “CONTENT THEFT” under “Customization Menu Items” in *DIC Vehicle Personalization on page 3-76*.

When the doors are locked using the power door lock switch of either front door, the red light, if your vehicle has one, will start flashing at a fast rate, indicating that the system is arming. After all the doors are locked there will be a time delay and then the red light, if your vehicle has one, will begin to flash at a very slow rate, indicating the system is armed.

Arming with the RKE Transmitter

The alarm system will arm when the RKE transmitter is used to lock the doors after the key is removed from the ignition. The red light, if your vehicle has one, will come on to indicate that the system is arming. After all doors are closed and locked, and after a time delay, the red light, if your vehicle has one, will begin flashing at a very slow rate to show the system is armed.

Arming Confirmation

Your vehicle may have a red light located on top of the instrument panel, towards the center of the vehicle and near the windshield, that will flash slowly to confirm when the system is armed.

Disarming with the RKE Transmitter

The alarm system will disarm when the RKE transmitter is used to unlock the doors. The red light, if your vehicle has one, will go out to show that the system is disarmed.

Disarming with Your Key

The alarm system will disarm when the key is used to unlock the doors. The red light, if your vehicle has one, will stop flashing when the system is disarmed. If you would like the key to disarm the alarm system, see "CONTENT THEFT" under *DIC Vehicle Personalization* on page 3-76 for more information.

PASS-Key® III

Your PASS-Key® III system operates on a radio frequency subject to Federal Communications Commission (FCC) Rules and with Industry Canada.

This device complies with Part 15 of the FCC Rules. Operation is subject to the following two conditions:

1. This device may not cause harmful interference.
2. This device must accept any interference received, including interference that may cause undesired operation.

This device complies with RSS-210 of Industry Canada. Operation is subject to the following two conditions:

1. This device may not cause interference.
2. This device must accept any interference received, including interference that may cause undesired operation of the device.

Changes or modifications to this system by other than an authorized service facility could void authorization to use this equipment.

PASS-Key® III uses a radio frequency transponder in the key that matches a decoder in your vehicle.

PASS-Key® III Operation

Your vehicle is equipped with PASS-Key® III (Personalized Automotive Security System) theft-deterrent system. PASS-Key® III is a passive theft-deterrent system.

The system is automatically armed when the key is removed from the ignition.

You do not have to manually arm or disarm the system.

The security light will come on if there is a problem with arming or disarming the theft-deterrent system.

PASS-Key III® uses a transponder in the ignition key that matches a decoder in the vehicle.

When the PASS-Key® III system senses that the wrong key has been inserted into the ignition, it shuts down the vehicle's starter and fuel systems. The starter will not work and fuel will stop flowing to the engine. If someone tries to start the vehicle again with the wrong key, the vehicle will not start. Anyone using a trial-and-error method to start the vehicle will be discouraged to do so because of the high number of electrical key codes.

When trying to start the vehicle, if the engine does not start and the STARTING DISABLED warning message on the Driver Information Center (DIC) comes on, there may be a problem with your theft-deterrent system. Turn the ignition off and try again.

If the engine still does not start, and the key appears to be undamaged, try another ignition key. At this time, you may also want to check the fuse. See *Fuses and Circuit Breakers on page 5-109*. If the engine still does not start with the other key, the vehicle needs service. If the vehicle does start, the first key may be faulty. See your dealer/retailer who can service the PASS-Key® III to have a new key made. In an emergency, contact Roadside Assistance. See *Roadside Assistance Program on page 7-8* for more information.

It is possible for the PASS-Key® III decoder to accept the transponder value of a new or replacement key. Up to 10 keys may be programmed for the vehicle. The following procedure is for programming additional keys only. If all the programmed keys are lost or do not operate, see your dealer/retailer or a locksmith who can service PASS-Key® III to have keys made and programmed to the system.

To program the new key do the following:

1. Verify that the new key has PK3 stamped on it.
2. Insert the master key in the ignition and start the engine. If the engine will not start, see your dealer/retailer for service.
3. After the engine has started, turn the key to LOCK/OFF, and remove the key.

4. Insert the key to be programmed and turn it to ON/RUN within five seconds of removing the original key.
5. The SERVICE THEFT SYSTEM warning message on the DIC will turn off, once the key has been programmed. It may not be apparent that the SERVICE THEFT SYSTEM warning message went on due to how quickly the key is programmed.
6. Repeat Steps 1 through 5 if additional keys are to be programmed.

If the SERVICE THEFT SYSTEM warning message appears and stays on the DIC while the vehicle is being driven, the engine will be able to be restarted if it is turned off. Your PASS-Key® III system, however, is not working properly and must be serviced by your dealer/retailer. The vehicle is not protected by the PASS-Key® III system at this time.

If the PASS-Key® III key is lost or stolen, see your dealer/retailer or a locksmith who can service PASS-Key® III to have a new key made.

Do not leave the key or device that disarms or deactivates the theft deterrent system in the vehicle.

Starting and Operating Your Vehicle

New Vehicle Break-In

Notice: Your vehicle does not need an elaborate break-in. But it will perform better in the long run if you follow these guidelines:

- Do not drive at any one constant speed, fast or slow, for the first 500 miles (805 km). Do not make full-throttle starts. Avoid downshifting to brake or slow the vehicle.
- Avoid making hard stops for the first 200 miles (322 km) or so. During this time the new brake linings are not yet broken in. Hard stops with new linings can mean premature wear and earlier replacement. Follow this breaking-in guideline every time you get new brake linings.
- Do not tow a trailer during break-in. See *Towing a Trailer on page 4-28* for the trailer towing capabilities of your vehicle and more information.

Following break-in, engine speed and load can be gradually increased.

Ignition Positions

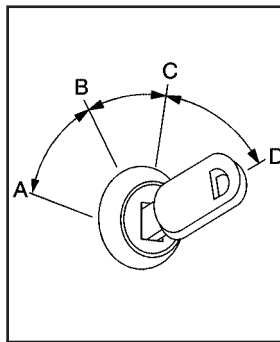

With the ignition key in the ignition, the key can be turned to four different positions.

In order to shift out of PARK (P), the ignition must be in ON/RUN and the regular brake pedal must be applied.

Notice: Using a tool to force the key from the ignition switch could cause damage or break the key. Use the correct key and turn the key only with your hand. Make sure the key is in all the way. If none of this works, then your vehicle needs service.

A (LOCK/OFF): This is the only position in which the ignition key can be inserted or removed. This position locks the ignition and transmission. It is a theft-deterrent feature.

If the steering wheel is locked, move it from right to left and turn the key to ACC/ACCESSORY. If none of this works, then your vehicle needs service.

B (ACC/ACCESSORY): This position lets the radio and windshield wipers operate while the engine is off. To use ACC/ACCESSORY, turn the key clockwise.

C (ON/RUN): This position is where the key returns to after the vehicle is started. This position displays some of the warning and indicator lights.

The battery could be drained if you leave the key in the ACC/ACCESSORY or ON/RUN position with the engine off. You may not be able to start your vehicle if the battery is allowed to drain for an extended period of time.

D (START): This position starts the engine.

A warning chime will sound and the Driver Information Center (DIC) will display DRIVER'S DOOR AJAR when the driver's door is opened if the ignition is in LOCK/OFF, ACC/ACCESSORY and the key is in the ignition. See *DIC Warnings and Messages on page 3-58* for more information.

Key In the Ignition

Never leave your vehicle with the keys inside, as it is an easy target for joy riders or thieves. If you leave the key in the ignition and park your vehicle, a chime will sound, when you open the driver's door. Always remember to remove your key from the ignition and take it with you. This will lock your ignition and transmission. Also, always remember to lock the doors.

The battery could be drained if you leave the key in the ignition while your vehicle is parked. You may not be able to start your vehicle after it has been parked for an extended period of time.

Retained Accessory Power (RAP)

These vehicle accessories can be used for up to 10 minutes after the engine is turned off:

- Audio System
- Power Windows

Power to these accessories continues to work for 10 minutes or until a door is opened.

Starting the Engine

Move your shift lever to PARK (P) or NEUTRAL (N). Your engine will not start in any other position – this is a safety feature. To restart when you are already moving, use NEUTRAL (N) only.

Notice: Do not try to shift to PARK (P) if your vehicle is moving. If you do, you could damage the transmission. Shift to PARK (P) only when your vehicle is stopped.

Starting Procedure

1. With your foot off the accelerator pedal, turn the ignition key to START. When the engine starts, let go of the key. The idle speed will go down as your engine gets warm. Do not race the engine immediately after starting it. Operate the engine and transmission gently to allow the oil to warm up and lubricate all moving parts.

Your vehicle has a Computer-Controlled Cranking System. This feature assists in starting the engine and protects components. If the ignition key is turned to the START position, and then released when the engine begins cranking, the engine will continue cranking for a few seconds or until the vehicle starts. If the engine does not start and the key is held in START for many seconds, cranking will be stopped after 15 seconds to prevent cranking motor damage. To prevent gear damage, this system also prevents cranking if the engine is already running. Engine cranking can be stopped by turning the ignition switch to the ACC/ACCESSORY or LOCK/OFF position.

Notice: Cranking the engine for long periods of time, by returning the key to the START position immediately after cranking has ended, can overheat and damage the cranking motor, and drain the battery. Wait at least 15 seconds between each try, to let the cranking motor cool down.

2. If the engine does not start after 5-10 seconds, especially in very cold weather (below 0°F or -18°C), it could be flooded with too much gasoline. Try pushing the accelerator pedal all the way to the floor and holding it there as you hold the key in START for up to a maximum of 15 seconds. Wait at least 15 seconds between each try, to allow the cranking motor to cool down. When the engine starts, let go of the key and accelerator. If the vehicle starts briefly but then stops again, do the same thing. This clears the extra gasoline from the engine. Do not race the engine immediately after starting it. Operate the engine and transmission gently until the oil warms up and lubricates all moving parts.

Notice: The engine is designed to work with the electronics in your vehicle. If you add electrical parts or accessories, you could change the way the engine operates. Before adding electrical equipment, check with your dealer/retailer. If you do not, your engine might not perform properly. Any resulting damage would not be covered by your vehicle's warranty.

Engine Coolant Heater

The engine coolant heater, if available, can help in cold weather conditions at or below 0°F (-18°C) for easier starting and better fuel economy during engine warm-up. Plug in the coolant heater at least four hours before starting your vehicle. An internal thermostat in the plug-end of the cord may exist which will prevent engine coolant heater operation at temperatures above 0°F (-18°C).

To Use the Engine Coolant Heater

1. Turn off the engine.
2. Open the hood and unwrap the electrical cord. The cord is attached to the underside of the diagonal brace, which is located above the engine air cleaner/filter assembly.
3. Plug it into a normal, grounded 110-volt AC outlet.

CAUTION:

Plugging the cord into an ungrounded outlet could cause an electrical shock. Also, the wrong kind of extension cord could overheat and cause a fire. You could be seriously injured. Plug the cord into a properly grounded three-prong 110-volt AC outlet. If the cord will not reach, use a heavy-duty three-prong extension cord rated for at least 15 amps.

4. Before starting the engine, be sure to unplug and store the cord as it was before to keep it away from moving engine parts. If you do not, it could be damaged.

How long should you keep the coolant heater plugged in? The answer depends on the outside temperature, the kind of oil you have, and some other things. Instead of trying to list everything here, we ask that you contact your dealer/retailer in the area where you will be parking your vehicle. The dealer/retailer can give you the best advice for that particular area.

Active Fuel Management™

Your vehicle's V8 engine may have Active Fuel Management™. This system allows the engine to operate on either all or half of its cylinders, depending on your driving conditions.

When less power is required, such as cruising at a constant vehicle speed, the system will operate in the half cylinder mode, allowing your vehicle to achieve better fuel economy. When greater power demands are required, such as accelerating from a stop, passing, or merging onto a freeway, the system will maintain full-cylinder operation.

Automatic Transmission Operation

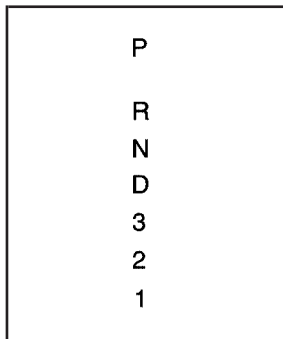

Console Shift Lever

Your vehicle's automatic transmission may have a shift lever on the steering column or on the console between the seats.

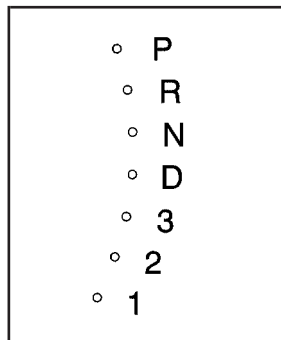

There is also a display located on the instrument panel cluster that indicates the vehicle's gear position.

 **CAUTION:**

It is dangerous to get out of your vehicle if the shift lever is not fully in PARK (P) with the parking brake firmly set. Your vehicle can roll.

Do not leave your vehicle when the engine is running unless you have to. If you have left the engine running, the vehicle can move suddenly. You or others could be injured. To be sure your vehicle will not move, even when you are on fairly level ground, always set your parking brake and move the shift lever to PARK (P). See *Shifting Into PARK (P)* on page 2-33. If you are pulling a trailer, see *Towing a Trailer* on page 4-28.

The positions for the shift lever are:

PARK (P): This position locks the vehicle's front wheels. It is the best position to use when the engine is started because the vehicle cannot move easily.

Make sure the shift lever is fully in PARK (P) before starting the engine. The vehicle has an electronic shift lock release system. You must fully apply the regular brakes before shifting from PARK (P) when the ignition is in ON/RUN. If you cannot shift out of PARK (P), ease pressure on the shift lever by pushing it all the way into PARK (P) as you maintain brake application. Then move the shift lever into another gear. See *Shifting Out of PARK (P)* on page 2-35

Notice: Shifting to REVERSE (R) while your vehicle is moving forward could damage the transmission. The repairs would not be covered by your warranty. Shift to REVERSE (R) only after your vehicle is stopped.

REVERSE (R): Use this gear to back up.

To rock the vehicle back and forth in order to get it out of snow, ice, or sand without damaging the transmission, see *If Your Vehicle is Stuck in Sand, Mud, Ice, or Snow* on page 4-20.

NEUTRAL (N): In this position, the engine does not connect with the wheels. To restart when you are already moving, use NEUTRAL (N) only. Also, use NEUTRAL (N) when the vehicle is being towed.

 **CAUTION:**

Shifting into a drive gear while the engine is running at high speed is dangerous. Unless your foot is firmly on the brake pedal, your vehicle could move very rapidly. You could lose control and hit people or objects. Do not shift into a drive gear while your engine is running at high speed.

Notice: Shifting out of PARK (P) or NEUTRAL (N) with the engine running at high speed may damage the transmission. The repairs would not be covered by your warranty. Be sure the engine is not running at high speed when shifting your vehicle.

Notice: Driving your vehicle if you notice that it is moving slowly or not shifting gears as you increase speed may damage the transmission. Have your vehicle serviced right away. You can drive in SECOND (2) when you are driving less than 35 mph (55 km/h) and DRIVE (D) for higher speeds until then.

DRIVE (D): This position is for normal driving. It provides the best fuel economy for your vehicle. If more power is needed for passing, and the vehicle is:

- Going less than 35 mph (55 km/h), push the accelerator pedal about halfway down.
- Going about 35 mph (55 km/h) or more, push the accelerator pedal all the way down.

By doing this the vehicle will automatically shift down to the next gear and have more power.

Downshifting the transmission in slippery road conditions could result in skidding, see Skidding under *Loss of Control* on page 4-12.

THIRD (3): This position is also used for normal driving. However it reduces vehicle speed more than DRIVE (D) without using your brakes. You might choose THIRD (3) instead of DRIVE (D) when driving on hilly, winding roads, when towing a trailer, so there is less shifting between gears and when going down a steep hill.

Notice: Driving in **SECOND (2)** for more than 25 miles (40 km) or at speeds over 55 mph (90 km/h) may damage the transmission. Also, shifting into **SECOND (2)** at speeds above 65 mph (105 km/h) can cause damage. Drive in **THIRD (3)** or **DRIVE (D)** instead of **SECOND (2)**.

SECOND (2): This position reduces vehicle speed even more than **THIRD (3)** without using your brakes. You can use **SECOND (2)** on hills. It can help control your speed as you go down steep mountain roads, but then you would also want to use your brakes off and on.

FIRST (1): This position reduces vehicle speed even more than **SECOND (2)** without using your brakes. You can use it on very steep hills, or in deep snow or mud. If the shift lever is put in **FIRST (1)** while the vehicle is moving forward, the transmission will not shift into first gear until the vehicle is going slowly enough.

Notice: Spinning the tires or holding the vehicle in one place on a hill using only the accelerator pedal may damage the transmission. The repair will not be covered by your warranty. If you are stuck, do not spin the tires. When stopping on a hill, use the brakes to hold the vehicle in place.

Parking Brake

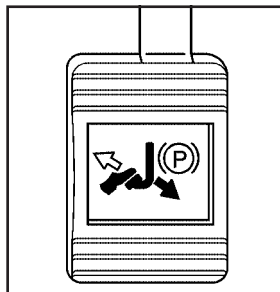

To set the parking brake, hold the regular brake pedal down with your right foot. Push down the parking brake pedal with your left foot.

To release the parking brake, hold the regular brake pedal down with your right foot and push the parking brake pedal with your left foot. While you lift your left foot, the parking brake pedal will follow it to the released position.

A warning chime will sound and **PARKING BRAKE ON** will display in the DIC if the parking brake is set, the ignition is on, and the vehicle speed is greater than 5 mph (8km/h). For more information see *Brake System Warning Light on page 3-37* and *DIC Warnings and Messages on page 3-58*.

Notice: Driving with the parking brake on can overheat the brake system and cause premature wear or damage to brake system parts. Make sure that the parking brake is fully released and the brake warning light is off before driving.

If you are towing a trailer and parking on any hill, see *Towing a Trailer on page 4-28*. That section shows what to do first to keep the trailer from moving.

Shifting Into PARK (P)

CAUTION:

It can be dangerous to get out of your vehicle if the shift lever is not fully in PARK (P) with the parking brake firmly set. Your vehicle can roll. If you have left the engine running, the vehicle can move suddenly. You or others could be injured. To be sure your vehicle will not move, even when you are on fairly level ground, use the steps that follow. If you are pulling a trailer, see *Towing a Trailer on page 4-28*.

Steering Column Shift Lever

If your vehicle has a steering column shift lever, use this procedure to shift the vehicle into PARK (P):

1. Hold the brake pedal down with your right foot.
2. Move the shift lever into PARK (P) by pulling the shift lever toward you and moving it up as far as it will go.
3. With your right foot still holding the brake pedal down, set the parking brake. See *Parking Brake on page 2-32* for more information.
4. Turn the ignition key to LOCK/OFF.
5. Remove the key and take it with you. If you can leave your vehicle with the ignition key in your hand, your vehicle is in PARK (P).

Console Shift Lever

If your vehicle is equipped with a console shift lever, use this procedure to shift the vehicle into PARK (P):

1. Hold the brake pedal down with your right foot.
2. Move the shift lever into PARK (P) by pushing the lever all the way toward the front of your vehicle and then to the left.
3. With your right foot still holding the brake pedal down, set the parking brake. See *Parking Brake on page 2-32* for more information.
4. Turn the ignition key to LOCK/OFF.
5. Remove the key and take it with you. If you can leave your vehicle with the ignition key in your hand, your vehicle is in PARK (P).

Leaving Your Vehicle With the Engine Running

CAUTION:

It can be dangerous to leave your vehicle with the engine running. Your vehicle could move suddenly if the shift lever is not fully in PARK (P) with the parking brake firmly set. And, if you leave the vehicle with the engine running, it could overheat and even catch fire. You or others could be injured. Do not leave your vehicle with the engine running.

If you have to leave your vehicle with the engine running, be sure your vehicle is in PARK (P) and your parking brake is firmly set before you leave it. See *Parking Brake on page 2-32* for more information.

Torque Lock

If you are parking on a hill and you do not shift your transmission into PARK (P) properly, the weight of the vehicle may put too much force on the parking pawl in the transmission. You may find it difficult to pull the shift lever out of PARK (P). This is called torque lock. To prevent torque lock, set the parking brake and then shift into PARK (P) properly before you leave the driver's seat. To find out how, see *Shifting Into PARK (P) on page 2-33*.

If torque lock does occur, you may need to have another vehicle push yours a little uphill to take some of the pressure from the parking pawl in the transmission, so you can pull the shift lever out of PARK (P).

Shifting Out of PARK (P)

Automatic Transmission Shift Lock

This vehicle has an electronic shift lock release system. The shift lock release is designed to:

- Prevent ignition key removal unless the shift lever is in PARK (P)
- Prevent movement of the shift lever out of PARK (P), unless the ignition is in ON/RUN and the regular brake pedal is applied.

The shift lock is always functional except in the case of a an uncharged or low voltage (less than 9 volt) battery.

If your vehicle has an uncharged battery or a battery with low voltage, try charging or jump starting the battery. See *Jump Starting on page 5-50*.

Console Shift

If your console shift lever cannot be moved out of PARK (P)

1. Apply and maintain the regular brakes.
2. Turn the ignition to ON/RUN position. See *Ignition Positions on page 2-24* for more information.
3. Let up on the shift lever and make sure the shift lever is pushed all the way into PARK (P).
4. Press the shift lever button
5. Then, move the shift into the desired gear.

If you still cannot move the shift lever from PARK (P), consult your dealer/retailer or a professional towing service.

Column Shift

If your column shift lever cannot be moved out of PARK (P)

1. Apply and maintain the regular brakes.
2. Turn the ignition key to the ON/RUN position. See *Ignition Positions on page 2-24* for more information.

3. Shift out of the PARK (P) position to the NEUTRAL (N) position.
4. Move the vehicle to a safe location.

If you still cannot move the shift lever from PARK (P), consult your dealer/retailer or a professional towing service.

Parking Over Things That Burn

CAUTION:

Things that can burn could touch hot exhaust parts under your vehicle and ignite. Do not park over papers, leaves, dry grass, or other things that can burn.

Engine Exhaust

CAUTION:

Engine exhaust can kill. It contains the gas carbon monoxide (CO), which you cannot see or smell. It can cause unconsciousness and death.

You might have exhaust coming in if:

- The exhaust system sounds strange or different.
- Your vehicle gets rusty underneath.
- Your vehicle was damaged in a collision.
- Your vehicle was damaged when driving over high points on the road or over road debris.
- Repairs were not done correctly.
- Your vehicle or the exhaust system has been modified improperly.

If you ever suspect exhaust is coming into your vehicle:

- Drive it only with all the windows down to blow out any CO; and
- Have your vehicle fixed immediately.

Running the Vehicle While Parked

It is better not to park with the engine running. But if you ever have to, here are some things to know.

CAUTION:

Idling the engine with the climate control system off could allow dangerous exhaust into your vehicle. See the earlier caution under *Engine Exhaust on page 2-37*.

Also, idling in a closed-in place can let deadly carbon monoxide (CO) into your vehicle even if the climate control fan is at the highest setting. One place this can happen is a garage. Exhaust — with CO — can come in easily. NEVER park in a garage with the engine running.

Another closed-in place can be a blizzard. See *Winter Driving on page 4-17*.

CAUTION:

It can be dangerous to get out of your vehicle if the shift lever is not fully in PARK (P) with the parking brake firmly set. Your vehicle can roll. Do not leave your vehicle when the engine is running unless you have to. If you have left the engine running, the vehicle can move suddenly. You or others could be injured. To be sure your vehicle will not move, even when you are on fairly level ground, always set the parking brake and move the shift lever to PARK (P).

Follow the proper steps to be sure your vehicle will not move. See *Shifting Into PARK (P)* on page 2-33.

If you are parking on a hill and if you are pulling a trailer, also see *Towing a Trailer* on page 4-28.

Mirrors

Manual Rearview Mirror

When you are sitting in a comfortable driving position, adjust the mirror so you can see clearly behind your vehicle. Grip the mirror in the center to move it up or down and side to side. The day/night adjustment allows you to adjust the mirror to avoid glare from the lamps behind you. Push the tab forward for daytime use and pull it for nighttime use.

Manual Rearview Mirror with OnStar[®]

The vehicle may have a mirror with Onstar[®]. While sitting in a comfortable driving position, adjust the mirror so you can see clearly behind your vehicle. Hold the mirror in the center to move it up and down and side to side.

The mirror has a day/night control located at the bottom. Turn the control to the right for the night position to reduce glare from other vehicles' headlamps. Turn the control to the front for the day position.

There are also three OnStar[®] buttons located at the bottom of the mirror. See your dealer/retailer for more information on the system and how to subscribe to OnStar[®]. See *OnStar[®] System on page 2-43* for more information about the services OnStar[®] provides.

Automatic Dimming Rearview Mirror

While sitting in a comfortable driving position, adjust the mirror so you can see clearly behind your vehicle. Hold the mirror in the center to move it up or down and side to side.

The vehicle may have an automatic dimming rearview mirror that darkens gradually to reduce the glare of headlamps from behind. Press the AUTO button located in the lower center of the mirror to turn automatic dimming on and the  (off) button located next to the AUTO button to turn automatic dimming off.

One photocell on the front of the mirror senses when it is becoming dark outside. Another photocell, facing rearward, senses headlamps behind you.

To keep the photocells operating well, occasionally clean them with a cotton swab and glass cleaner.

Automatic Dimming Rearview Mirror with OnStar[®]

While sitting in a comfortable driving position, adjust the mirror so you can see clearly behind your vehicle. Hold the mirror in the center to move it up or down and side to side.

The vehicle may have an automatic dimming rearview mirror with the OnStar[®] System. The automatic dimming feature is turned on or off by pressing the left button, located on the lower part of the mirror, for up to three seconds. When turned on, this mirror functions like the automatic dimming rearview mirror described previously. See *Automatic Dimming Rearview Mirror on page 2-39*.

There are also three OnStar[®] buttons located at the bottom of the mirror. See your dealer/retailer for more information on the system and how to subscribe to OnStar[®]. See *OnStar[®] System on page 2-43* for more information about the services OnStar[®] provides.

Outside Power Mirrors

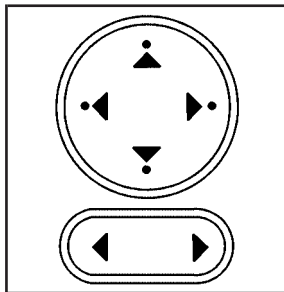

The controls for the outside power mirrors, are located on the driver's door armrest.

Move the selector switch located below the four-way control pad to the left or right to choose either the driver's side or passenger's side mirror. To adjust a mirror, use the arrows located on the four-way control pad to move the mirror in the desired direction. Adjust each outside mirror so that a little of the vehicle and the area behind it can be seen while sitting in a comfortable driving position. Keep the selector switch in the center position when not adjusting either outside mirror.

Outside Power Heated Mirrors

For information on the operation of the outside power mirrors see *Outside Power Mirrors* on page 2-40.

If the vehicle has heated mirrors, they will warm up to melt ice and snow, and remove condensation when the defroster is turned on. See *Dual Automatic Climate Control System* on page 3-24 or *Climate Control System* on page 3-20.

Outside Convex Mirror

CAUTION:

A convex mirror can make things (like other vehicles) look farther away than they really are. If you cut too sharply into the right lane, you could hit a vehicle on your right. Check your inside mirror or glance over your shoulder before changing lanes.

The passenger side mirror is convex. A convex mirror's surface is curved so more can be seen from the driver seat. It also makes things, like other vehicles, look farther away than they really are.

Object Detection Systems

Ultrasonic Rear Parking Assist (URPA)

If your vehicle has the Ultrasonic Rear Parking Assist (URPA) system, it helps you park easier and avoid other vehicles while in REVERSE (R). It operates at speeds less than 3 mph (5 km/h). It can determine how close objects are to the rear bumper, up to 5 feet (1.5 m) behind your vehicle. The distance sensors are located on the rear bumper.

CAUTION:

The Ultrasonic Rear Parking Assist (URPA) system does not replace driver vision. It cannot detect:

- objects that are below the bumper, underneath the vehicle, or if they are too close or far from the vehicle
- children, pedestrians, bicyclists, or pets.

CAUTION: (Continued)

CAUTION: (Continued)

If you do not use proper care before and while backing; vehicle damage, injury, or death could occur. Even with URPA, always check behind your vehicle before backing up. While backing, be sure to look for objects and check your vehicle's mirrors.

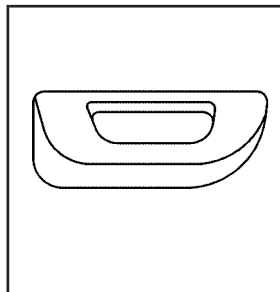

The display is located above the rear window and can be seen by looking over your right shoulder.

URPA uses three color-coded lights to provide distance and system information.

How the System Works

URPA comes on automatically when the shift lever is moved into REVERSE (R). The rear display will then briefly illuminate to let you know the system is working.

URPA operates only at speeds less than 3 mph (5 km/h). If you are above this speed, the red light on the rear display will flash.

To be detected, objects must be at least 10 inches (25.4 cm) off the ground and below trunk level. Objects must also be within 5 feet (1.5 m) from your rear bumper. This distance may be less during warmer or humid weather.

A single beep will sound the first time an object is detected between 20 inches (0.5 m) and 5 feet (1.5 m) away. Repeated beeping will occur when you are closer than 20 inches (0.5 m) from the object.

The following describes what will occur with the URPA display as you get closer to a detected object:

Description	English	Metric
amber light	5 ft	1.5 m
amber/amber lights	40 in	1.0 m
amber/amber/red lights/continuous beep	20 in	0.5 m
amber/amber/red lights flashing and continuous beep	1 ft	0.3 m

When the System Does Not Seem to Work Properly

- The ultrasonic sensors are not clean, a red URPA display light may illuminate when the vehicle is in REVERSE (R). Keep your rear bumper free of mud, dirt, snow, ice and slush. For cleaning instructions, see *Washing Your Vehicle on page 5-102*.

- A trailer was attached to your vehicle, or a bicycle or an object was hanging out of your trunk during your last drive cycle, the red light may illuminate. Once the attached object is removed, URPA will return to normal operation.
- A tow bar is attached to your vehicle.
- The vehicle's bumper is damaged. Take the vehicle to your dealer/retailer to repair the system.
- Other conditions may affect system performance, such as vibrations from a jackhammer or the compression of air brakes on a very large truck.

If the system is still disabled, after driving forward at least 15 mph (25 km/h), take your vehicle to your dealer/retailer.

OnStar[®] System

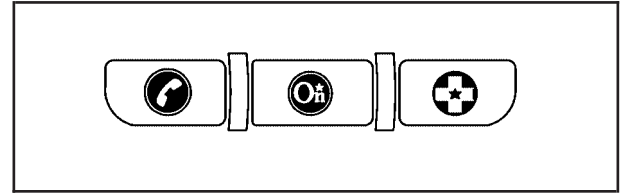

OnStar uses several innovative technologies and live advisors to provide you with a wide range of safety, security, information, and convenience services. If your airbags deploy, the system is designed to make an automatic call to OnStar Emergency advisors who can request emergency services be sent to your location. If you lock your keys in the vehicle, call OnStar at 1-888-4-ONSTAR and they can send a signal to unlock your doors. If you need roadside assistance, press the OnStar button and they can contact Roadside Service for you.

OnStar service is provided to you subject to the OnStar Terms and Conditions. You may cancel your OnStar service at any time by contacting OnStar. A complete OnStar Owner's Guide and the OnStar Terms and Conditions are included in the vehicle's OnStar Subscriber glove box literature. For more information, visit onstar.com or onstar.ca, contact OnStar at 1-888-4-ONSTAR (1-888-466-7827) or TTY 1-877-248-2080, or press the OnStar button to speak with an OnStar advisor 24 hours a day, 7 days a week.

Not all OnStar features are available on all vehicles. To check if your vehicle is equipped to provide the services described below, or for a full description of OnStar services and system limitations, see the OnStar Owner's Guide in your glove box or visit onstar.com.

OnStar Services

For new vehicles with OnStar, the Safe & Sound Plan, or the Directions & Connections Plan is included for one year from the date of purchase. You can extend this plan beyond the first year, or upgrade to the Directions & Connections Plan. For more information, press the OnStar button to speak with an advisor. Some OnStar services (such as Remote Door Unlock or Stolen Vehicle Location Assistance) may not be available until you register with OnStar.

Available Services with Safe & Sound Plan

- Automatic Notification of Airbag Deployment
- Advanced Automatic Crash Notification (AACN) (If equipped)
- Link to Emergency Services
- Roadside Assistance
- Stolen Vehicle Location Assistance
- AccidentAssist
- Remote Door Unlock/Vehicle Alert
- OnStar Vehicle Diagnostics
- GM Goodwrench® On Demand Diagnostics
- OnStar Hands-Free Calling with 30 complimentary minutes
- OnStar Virtual Advisor (U.S. Only)

Available Services included with Directions & Connections Plan

- All Safe and Sound Plan Services
- Driving Directions - Advisor delivered or OnStar Turn-by-Turn Navigation (If equipped)
- RideAssist
- Information and Convenience Services

OnStar Hands-Free Calling

OnStar Hands-Free Calling allows eligible OnStar subscribers to make and receive calls using voice commands. Hands-Free Calling is fully integrated into the vehicle, and can be used with OnStar Pre-Paid Minute Packages. Hands-Free Calling may also be linked to a Verizon Wireless service plan in the U.S. or a Bell Mobility service plan in Canada, depending on eligibility. To find out more, refer to the OnStar Owner's Guide in the vehicle's glove box, visit www.onstar.com or www.onstar.ca, or speak with an OnStar advisor by pressing the OnStar button or calling 1-888-4-ONSTAR (1-888-466-7827).

OnStar Virtual Advisor

OnStar Virtual Advisor is a feature of OnStar Hands-Free Calling that uses your minutes to access location-based weather, local traffic reports, and stock quotes. By pressing the phone button and giving a few simple voice commands, you can browse through the various topics. See the OnStar Owner's Guide for more information (Only available in the continental U.S.).

OnStar Steering Wheel Controls

Your vehicle may have a Talk/Mute button that can be used to interact with OnStar Hands-Free Calling. See *Audio Steering Wheel Controls on page 3-102* for more information.

On some vehicles, you may have to hold the button for a few seconds and give the command “ONSTAR” to activate the OnStar Hands-Free Calling.

On some vehicles, the mute button can be used to dial numbers into voicemail systems, or to dial phone extensions. See the OnStar Owner’s Guide for more information.

How OnStar Service Works

Your vehicle’s OnStar system has the capability of recording and transmitting vehicle information. This information is automatically sent to an OnStar Call Center at the time of an OnStar button press, Emergency button press or if your airbags or AACN system deploys. The vehicle information usually includes your GPS location and, in the event of a crash, additional information regarding the accident that your vehicle has been involved in (e.g. the direction from which your vehicle was hit). When you use the Virtual

Advisor feature of OnStar Hands-Free Calling, your vehicle also sends OnStar your GPS location so that we can provide you with location-based services.

OnStar service cannot work unless your vehicle is in a place where OnStar has an agreement with a wireless service provider for service in that area. OnStar service also cannot work unless you are in a place where the wireless service provider OnStar has hired for that area has coverage, network capacity and reception when the service is needed, and technology that is compatible with the OnStar service. Not all services are available everywhere, particularly in remote or enclosed areas, or at all times.

Location information about your vehicle is only available if the GPS satellite signals are unobstructed and available.

Your vehicle must have a working electrical system (including adequate battery power) for the OnStar equipment to operate. There are other problems OnStar cannot control that may prevent OnStar from providing OnStar service to you at any particular time or place. Some examples are damage to important parts of your vehicle in an accident, hills, tall buildings, tunnels, weather or wireless phone network congestion.

Your Responsibility

Increase the radio volume if you cannot hear the OnStar advisor. If the light next to the OnStar buttons is red, this means that your system is not functioning properly and should be checked by your dealer/retailer. If the light appears clear (no light is appearing), your OnStar subscription has expired. You can always press the OnStar button to confirm that your OnStar equipment is active.

Universal Home Remote System

The Universal Home Remote System provides a way to replace up to three hand-held radio-frequency (RF) transmitters used to activate devices such as garage door openers, security systems, and home lighting.

This device complies with Part 15 of the FCC Rules. Operation is subject to the following two conditions:

1. This device may not cause harmful interference.
2. This device must accept any interference received, including interference that may cause undesired operation.

The FCC Grant of Equipment Authorization Certificate number is CB2SAHL3.

This device complies with RSS-210 of Industry Canada. Operation is subject to the following two conditions:

1. This device may not cause interference.
2. This device must accept any interference received, including interference that may cause undesired operation of the device.

The Canadian Registration ID number is 2791021849A.

Changes or modifications to this system by other than an authorized service facility could void authorization to use this equipment.

Universal Home Remote System Operation

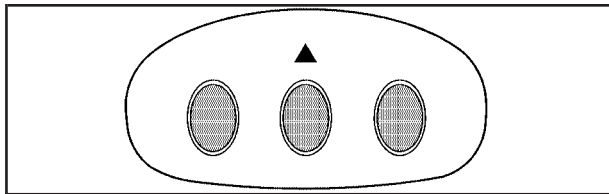

If there is one triangular Light Emitting Diode (LED) indicator light above the Universal Home Remote buttons, follow the instructions below.

This system provides a way to replace up to three remote control transmitters used to activate devices such as garage door openers, security systems, and home automation devices.

Do not use the Universal Home Remote with any garage door opener that does not have the stop and reverse feature. This includes any garage door opener model manufactured before April 1, 1982.

Read the instructions completely before attempting to program the Universal Home Remote. Because of the steps involved, it may be helpful to have another person available to assist you in the programming the Universal Home Remote.

Keep the original hand-held transmitter for use in other vehicles as well as for future Universal Home Remote programming. It is also recommended that upon the sale of the vehicle, the programmed Universal Home Remote buttons should be erased for security purposes. See "Erasing Universal Home Remote Buttons" later in this section.

When programming a garage door, park outside of the garage. Park directly in line with and facing the garage door opener motor-head or gate motor-head. Be sure that people and objects are clear of the garage door or gate you are programming.

It is recommended that a new battery be installed in your hand-held transmitter for quicker and more accurate transmission of the radio-frequency signal.

Programming the Universal Home Remote System

If you have questions or need help programming the Universal Home Remote System, call 1-800-355-3515 or go to www.homelink.com.

Programming a garage door opener involves time-sensitive actions, so read the entire procedure before you begin. If you do not follow these actions, the device will time out and you will have to repeat the procedure.

To program up to three devices:

1. Turn the ignition to ACC/ACCESSORY or ON/RUN.
Programming can only occur with the vehicle in ACC/ACCESSORY or ON/RUN and until 10 minutes after the ignition is turned off.

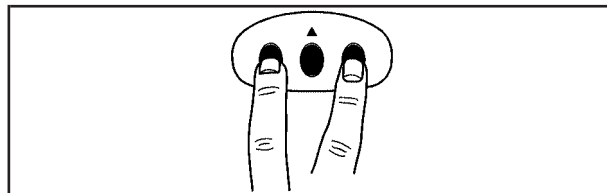

2. From inside the vehicle, press and hold down the two outside buttons at the same time, releasing only when the Universal Home Remote indicator light begins to flash, after 20 seconds. This step will erase the factory settings or all previously programmed buttons.
Do not hold down the buttons for longer than 30 seconds and do not repeat this step to program the remaining two Universal Home Remote buttons.
3. Hold the end of your hand-held transmitter about 1 to 3 inches (3 to 8 cm) away from the Universal Home Remote buttons while keeping the indicator light in view. The hand-held transmitter was supplied by the manufacturer of your garage door opener receiver (motor head unit).

4. At the same time, press and hold both the Universal Home Remote button that you would like to use to control the garage door and the hand-held transmitter button. Do not release the Universal Home Remote button or the hand-held transmitter button until Step 4 has been completed.

Some entry gates and garage door openers may require you to substitute Step 3 with the procedure noted in “Gate Operator and Canadian Programming” later in this section.

5. The indicator light on the Universal Home Remote will flash slowly at first and then rapidly after Universal Home Remote successfully receives the frequency signal from the hand-held transmitter. Release both buttons.
6. Press and hold the newly-trained Universal Home Remote button and observe the indicator light.

If the indicator light stays on continuously, the programming is complete and your garage door should move when the Universal Home Remote button is pressed and released. You do not need to continue the programming Steps 6 through 8 and can stop here.

If the Universal Home Remote indicator light blinks rapidly for two seconds and then turns to a constant light, continue with the programming Steps 6 through 8.

It may be helpful to have another person available to assist with the remaining steps.

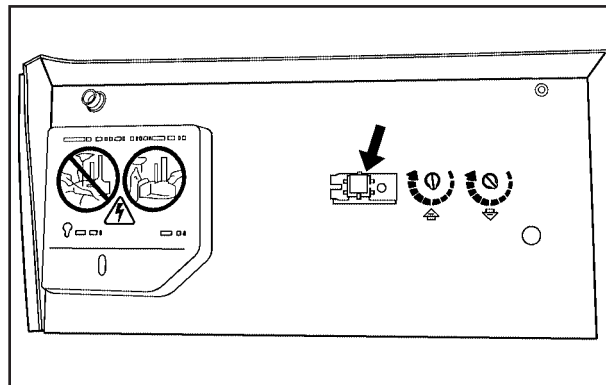

7. After Steps 1 through 5 have been completed, locate inside the garage the garage door opener receiver (motor-head unit). Locate the “Learn” or “Smart” button. The name and color of the button may vary by manufacturer.
8. Firmly press and release the “Learn” or “Smart” button. After you press this button, you will have 30 seconds to complete Step 8.

9. Immediately return to the vehicle. Firmly press and hold the Universal Home Remote button, chosen in Step 3 to control the garage door, for two seconds, and then release it. If the garage door does not move, press and hold the same button a second time for two seconds, and then release it. Again, if the door does not move, press and hold the same button a third time for two seconds, and then release.

The Universal Home Remote should now activate the garage door.

To program the remaining two Universal Home Remote buttons, begin with Step 2 of “Programming the Universal Home Remote System.” Do not repeat Step 1, as this will erase all previous programming from the Universal Home Remote buttons.

Gate Operator and Canadian Programming

If you have questions or need help programming the Universal Home Remote System, call 1-800-355-3515 or go to www.homelink.com.

Canadian radio-frequency laws require transmitter signals to time out or quit after several seconds of transmission. This may not be long enough for Universal Home Remote to pick up the signal during programming. Similarly, some U.S. gate operators are manufactured to time out in the same manner.

If you live in Canada, or you are having difficulty programming a gate operator or garage door opener by using the “Programming Universal Home Remote” procedures, regardless of where you live, replace Step 3 under “Programming Universal Home Remote” with the following:

Continue to press and hold the Universal Home Remote button while you press and release every two seconds (cycle) the hand-held transmitter button until the frequency signal has been successfully accepted by the Universal Home Remote. The Universal Home Remote indicator light will flash slowly at first and then rapidly. Proceed with Step 4 under “Programming Universal Home Remote” to complete.

Using Universal Home Remote

Press and hold the appropriate Universal Home Remote button for at least half of a second. The indicator light will come on while the signal is being transmitted.

Operation can only occur with the vehicle in ACC/ACCESSORY or ON/RUN and until 10 minutes after the ignition is turned off.

Erasing Universal Home Remote Buttons

Erase the programmed buttons when you sell or terminate your lease.

To erase all programmed buttons on the Universal Home Remote device:

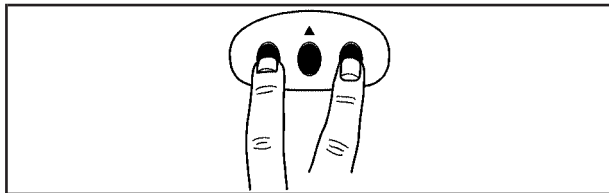

1. Press and hold down the two outside buttons until the indicator light begins to flash, after 20 seconds.
2. Release both buttons.

Reprogramming a Single Universal Home Remote Button

To reprogram any of the three Universal Home Remote buttons, repeat the programming instructions earlier in this section, beginning with Step 2.

For help or information on the Universal Home Remote System, call the customer assistance phone number under *Customer Assistance Offices on page 7-6*.

Storage Areas

Glove Box

To open the glove box, lift up on the lever.

Cupholder(s)

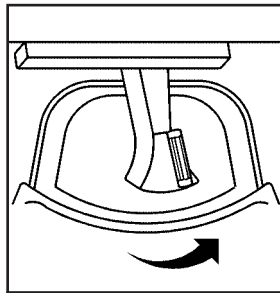

If your vehicle is the five-passenger model, there is a cupholder in front of the center console.

The cupholder has an arm that adjusts to two positions to fit either a large cup or two smaller cups.

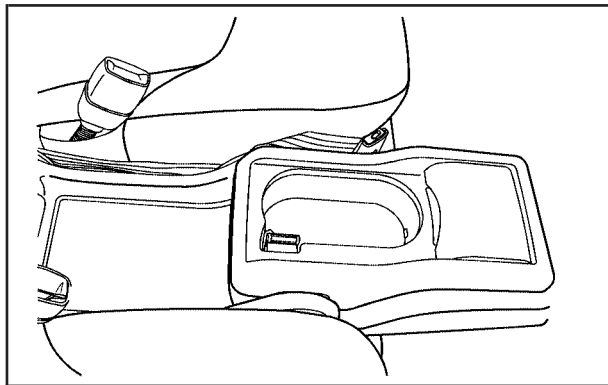

If your vehicle is the six-passenger model, there is a cupholder located underneath the seat. To access, pull the center seat forward. The cupholder has a support that adjusts to two positions to fit either a large cup or two smaller cups.

Center Console Storage

If your vehicle has a five-passenger console, the center console has a padded lid that can be used as an armrest. Lift the armrest lid to access a storage bin with a coin holder and a CD holder. Located under the lid is a card clip.

If your vehicle has a six-passenger console, there is a flip and fold center armrest that allows you to choose between a three-passenger front row bench seat or a center console. For more information see *Center Seat on page 1-7*. In the upward position the armrest acts as a back support for the front row bench seat. Flip the center armrest down and it can be used as an armrest for the driver and passenger seat. Lift the armrest lid to access the storage area.

Convenience Net

Your vehicle may have a convenience net in the rear of the vehicle. Store small loads as far forward as possible. The net should not be used to store heavy loads.

Sunroof

The vehicle may have a sunroof. It includes a sliding glass panel and a sunshade.

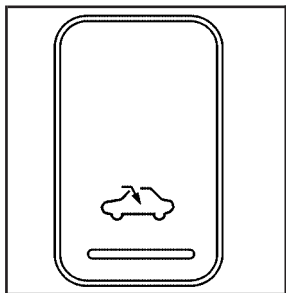

The sunroof control is on the headliner, by the map lamps.

The sunroof control works only when the ignition is on or in ACC/ACCESSORY, or when Retained Accessory Power (RAP) is active. See *Retained Accessory Power (RAP)* on page 2-25.

To raise the sunroof to the vent position, open the sunshade by hand, then press the back of the control. Push and hold the front of the control to close the sunroof from the vent position.

With the sunroof in the vent position, press and release the back of the control to express-open the sunroof. The sunshade will automatically open with the sunroof. To stop the express-open function, press the back of the control again.

To close the sunroof, press and hold the front of the control. To stop the sunroof, release the control. The sunshade must be closed manually.

The sunroof panel cannot be opened or closed if your vehicle has an electrical failure.

Section 3 Instrument Panel

Instrument Panel Overview	3-4	Electric Power Management	3-18
Hazard Warning Flashers	3-6	Battery Run-Down Protection	3-19
Other Warning Devices	3-6	Accessory Power Outlet(s)	3-19
Horn	3-6	Ashtray(s) and Cigarette Lighter	3-20
Tilt Wheel	3-6	Climate Controls	3-20
Turn Signal/Multifunction Lever	3-7	Climate Control System	3-20
Turn and Lane-Change Signals	3-8	Dual Automatic Climate Control System	3-24
Headlamp High/Low-Beam Changer	3-8	Outlet Adjustment	3-28
Flash-to-Pass	3-8	Passenger Compartment Air Filter	3-29
Windshield Wipers	3-9	Warning Lights, Gages, and Indicators	3-30
Windshield Washer	3-9	Instrument Panel Cluster	3-31
Cruise Control	3-10	Speedometer and Odometer	3-32
Exterior Lamps	3-13	Tachometer	3-32
Daytime Running Lamps (DRL)/ Automatic Headlamp System	3-14	Safety Belt Reminders	3-32
Fog Lamps	3-15	Airbag Readiness Light	3-33
Exterior Lighting Battery Saver	3-15	Passenger Airbag Status Indicator	3-34
Interior Lamps	3-16	Charging System Light	3-36
Instrument Panel Brightness	3-16	Brake System Warning Light	3-37
Courtesy Lamps	3-16	Antilock Brake System Warning Light	3-38
Entry Lighting	3-16	Traction Control System (TCS) Warning Light	3-38
Delayed Entry Lighting	3-17	Enhanced Traction System Warning Light	3-39
Theater Dimming	3-17	Engine Coolant Temperature Warning Light	3-40
Delayed Exit Lighting	3-17	Engine Coolant Temperature Gage	3-40
Perimeter Lighting	3-17		
Overhead Console Reading Lamps	3-18		
Rear Assist Handle Reading Lamps	3-18		

Section 3 Instrument Panel

Low Coolant Warning Light	3-41	Driver Information Center (DIC)	3-49
Tire Pressure Light	3-41	DIC Operation and Displays	3-50
Malfunction Indicator Lamp	3-42	DIC Compass (Uplevel Only)	3-56
Oil Pressure Light	3-45	DIC Warnings and Messages	3-58
Change Engine Oil Light	3-45	DIC Vehicle Personalization	3-76
Security Light	3-45	Audio System(s)	3-84
Cruise Control Light	3-46	Setting the Clock	3-85
Reduced Engine Power Light	3-46	Radio(s)	3-86
Highbeam On Light	3-46	Using an MP3	3-97
Headlamps Suggested Light	3-47	XM Radio Messages	3-100
Low Washer Fluid Warning Light	3-47	Theft-Deterrent Feature	3-101
Door Ajar Light	3-47	Audio Steering Wheel Controls	3-102
Trunk Ajar Light	3-47	Radio Reception	3-103
Service Vehicle Soon Light	3-48	Backglass Antenna	3-104
Fuel Gage	3-48	XM™ Satellite Radio Antenna System	3-105
Low Fuel Warning Light	3-48	Chime Level Adjustment	3-105
Check Gas Cap Light	3-49		

Instrument Panel Overview

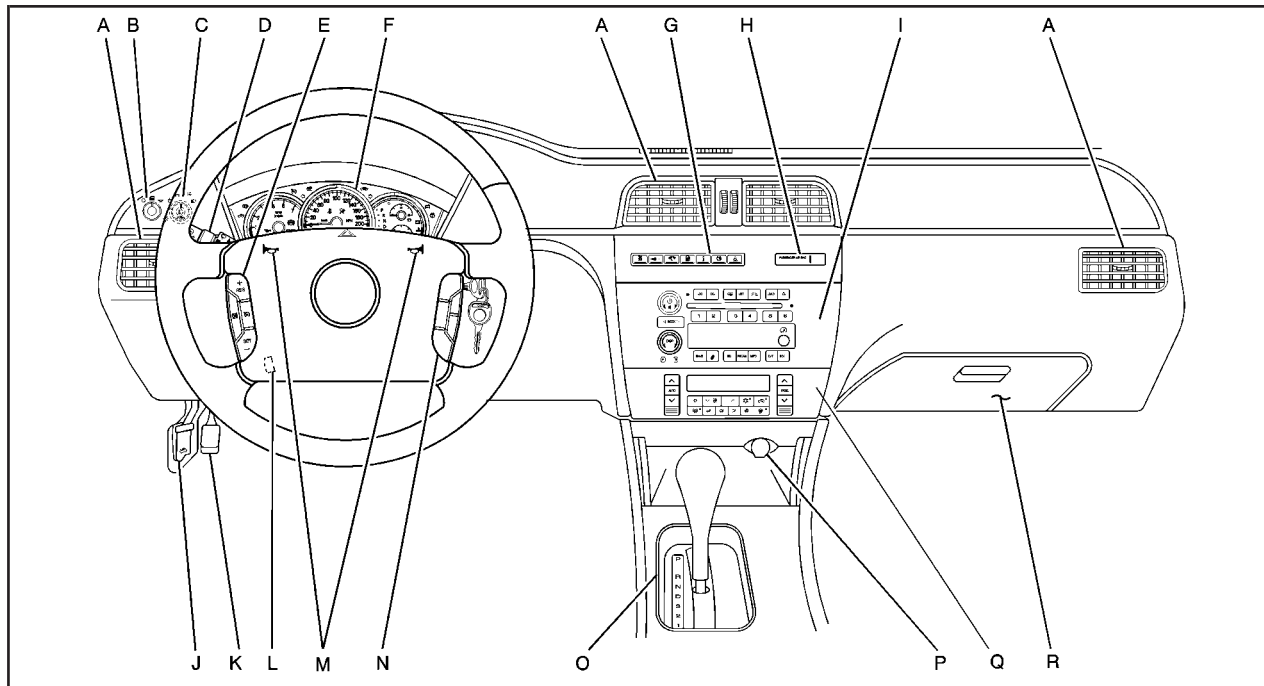

The main components of the instrument panel are the following:

- A. Air Outlets. See *Outlet Adjustment on page 3-28.*
- B. Interior Lamps Control. See *Interior Lamps on page 3-16.*
- C. Exterior Lamps Control. See *Exterior Lamps on page 3-13.* Fog Lamp Control. See *Fog Lamps on page 3-15.*
- D. Turn Signal/Multifunction Lever. See *Turn Signal/Multifunction Lever on page 3-7.*
- E. Cruise Controls. See *Cruise Control on page 3-10.*
- F. Instrument Panel Cluster. See *Instrument Panel Cluster on page 3-31.*
- G. DIC Buttons (If Equipped) and Hazard Warning Flasher Button. See *DIC Operation and Displays on page 3-50* and *Hazard Warning Flashers on page 3-6.*
- H. Passenger Airbag Status Indicator. See *Passenger Airbag Status Indicator on page 3-34.*
- I. Audio System Controls. See *Audio System(s) on page 3-84.*
- J. Hood Release. See *Hood Release on page 5-11.*
- K. Parking Brake. See *Parking Brake on page 2-32.*
- L. Tilt Lever (If Equipped) and Telescoping Column Lever (If Equipped). See *Tilt Wheel on page 3-6.*
- M. Horn. See *Horn on page 3-6.*
- N. Audio Steering Wheel Controls (If Equipped). See *Audio Steering Wheel Controls on page 3-102.*
- O. Shift Lever. See *Shifting Into PARK (P) on page 2-33.*
- P. Accessory Power Outlet. See *Accessory Power Outlet(s) on page 3-19.*
- Q. Climate Controls. See *Climate Control System on page 3-20* or *Dual Automatic Climate Control System on page 3-24.*
- R. Glove Box. See *Glove Box on page 2-52.*

Hazard Warning Flashers

The hazard warning flashers let you warn the police and others that you have a problem. The front and rear turn signal lamps will flash on and off.

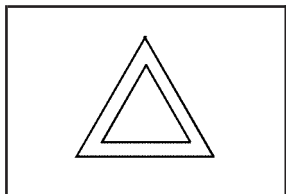

The hazard warning flasher button is on the instrument panel.

Press the button to make the front and rear turn signal lamps flash on and off. Press again to turn the flashers completely off.

The hazard warning flashers work even if the key is not in the ignition switch.

Other Warning Devices

If you carry reflective triangles, you can set them up at the side of the road about 300 feet (100 m) behind your vehicle.

Horn

Press near or on the horn symbols on the steering wheel pad to sound the horn.

Tilt Wheel

If the vehicle has a tilt wheel the steering wheel can be adjusted to a higher or lower position. Do not adjust the tilt wheel while driving.

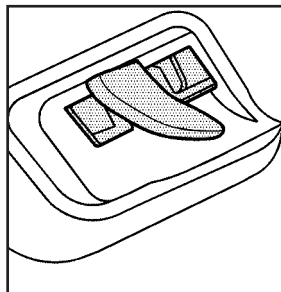

The lever used to tilt the steering wheel is located on the left side of the steering column.

To tilt the wheel, pull the lever towards you, move the wheel to a comfortable position, and then release the lever to lock the wheel in place.

Telescoping Column

If the vehicle has a telescoping column on the steering wheel it adjusts the distance of the steering wheel to the driver without having to move the driver's seat.

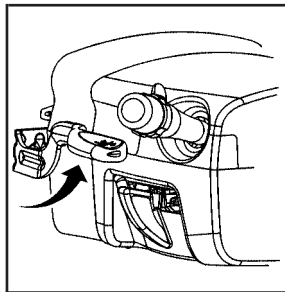

The lever that makes this adjustment is located on the left side of the steering column and behind the tilt lever, if the vehicle has this feature.



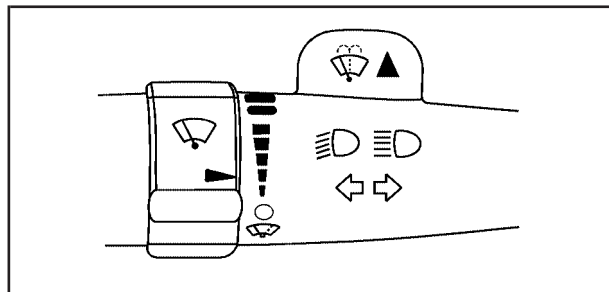

To adjust the steering wheel, pull the steering wheel column lever down and push or pull the steering wheel to a comfortable position. Then pull the lever up to lock the wheel in place.

Do not drive the vehicle unless the telescoping column is locked.

Turn Signal/Multifunction Lever



The lever on the left side of the steering column includes the following:

-  Turn and Lane Change Signals. See *Turn and Lane-Change Signals* on page 3-8.
-  Headlamp High/Low-Beam Changer. See *Headlamp High/Low-Beam Changer* on page 3-8.
- Flash-to-Pass. See *Flash-to-Pass* on page 3-8.
-  Windshield Wipers. See *Windshield Wipers* on page 3-9.
-  Windshield Washer. See *Windshield Washer* on page 3-9.

For information on the headlamps, see *Exterior Lamps* on page 3-13.

Turn and Lane-Change Signals

To signal a turn, move the lever up or down. The lever returns to its original position when the turn is completed.

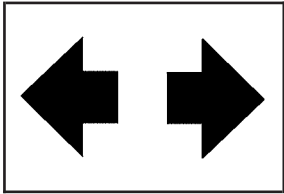

An arrow on the instrument panel cluster will flash in the direction of the turn or lane change.

To signal a lane change, raise or lower the lever until the arrow starts to flash. Hold it there until the lane change is completed. The lever will return to its original position when released.

Arrows that flash rapidly when signaling for a turn or lane change, or that fail to work, may indicate a burned-out signal bulb or fuse. Other drivers will not see the signal. See *Taillamps, Turn Signal, Sidemarker, Stoplamps and Back-up Lamps on page 5-59* for turn signal bulb replacement procedures. Also see *Fuses and Circuit Breakers on page 5-109* for location of fuses.

A chime will sound if the turn signal is left on for more than 3/4 mile (1.2 km).

Headlamp High/Low-Beam Changer

To change the headlamps from low beam to high beam, push the turn signal/multifunction lever away from you.

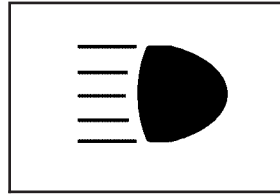

This light comes on in the instrument panel cluster if the high beam lamps are turned on while the ignition is in ON/RUN.

To change the headlamps from high beam to low beam, pull the turn signal lever toward you.

Flash-to-Pass

This feature lets you use your high-beam headlamps momentarily to signal a driver in front of you that you want to pass.

To use it, pull the turn signal/multifunction lever toward you until the high-beam headlamps come on, then release the lever to turn them off.

Windshield Wipers

Clear ice and snow from the wiper blades before using them. If they are frozen to the windshield, gently loosen or thaw them. Damaged wiper blades may not clear the windshield well, making it harder to see and drive safely. If the blades do become damaged, install new blades or blade inserts. For more information, see *Windshield Wiper Blade Replacement on page 5-62*.

Heavy snow or ice can overload the wiper motor. A circuit breaker will stop the motor until it cools down. Clear away snow or ice to prevent an overload.

Turn the band with the wiper symbol to control the windshield wipers.

 **(Mist):** Turn the band to mist for a single wiping cycle. Hold it there until the wipers start. Then let go. The wipers stop after one wipe. Hold the band on mist longer, for more wipe cycles.



 **(Off):** To stop the wipers, move the band to off.

 **(Delay):** Turn the band to adjust the delay time. The delay between wiping cycles becomes shorter as the band is moved to the top of the lever. This can be very useful in light rain or snow.

 **(Low Speed):** Turn the band away from you to the first solid band past the delay settings, for steady wiping at low speed.

 **(High Speed):** Turn the band further, to the second solid band past the delay settings, for high-speed wiping.

Windshield Washer

  **(Washer Fluid):** There is a paddle marked with the windshield washer symbol at the top of the multifunction lever. To spray washer fluid on the windshield, push the paddle. The wipers will clear the window and then either stop or return to your preset speed.

CAUTION:

In freezing weather, do not use your washer until the windshield is warmed. Otherwise the washer fluid can form ice on the windshield, blocking your vision.

Cruise Control

With cruise control, you can maintain a speed of about 25 mph (40 km/h) or more without keeping your foot on the accelerator. This can really help on long trips. Cruise control does not work at speeds below about 25 mph (40 km/h).

CAUTION:

Cruise control can be dangerous where you cannot drive safely at a steady speed. So, do not use your cruise control on winding roads or in heavy traffic.

Cruise control can be dangerous on slippery roads. On such roads, fast changes in tire traction can cause excessive wheel slip, and you could lose control. Do not use cruise control on slippery roads.

If your vehicle has the Traction Control System (TCS) and the cruise control is on, TCS will begin to limit wheel spin and the cruise control automatically turns off. See *Traction Control System (TCS) on page 4-6*. When road conditions allow you to safely use it again, the cruise control can be turned back on.

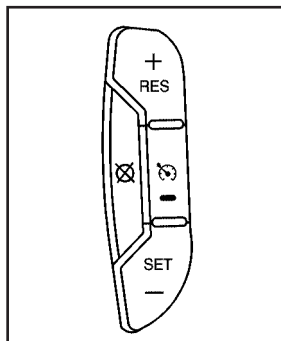

The cruise control buttons are located on outboard side of the steering wheel.

 **(On/Off):** Press this button to turn cruise control on and off. The indicator is lit when cruise control is on.

+ RES (Resume/Accelerate): Press this button to make the vehicle accelerate or resume to a previously set speed.

SET-: Press this button to set the speed or make the vehicle decelerate.

 **(Cancel):** Press this button to cancel cruise control.

Setting Cruise Control

Cruise control will not work if the parking brake is set, or if the master cylinder brake fluid level is low.

The cruise control light on the instrument panel cluster comes on after the cruise control has been set to the desired speed. See *Instrument Panel Cluster on page 3-31*.

CAUTION:

If you leave your cruise control on when you are not using cruise, you might hit a button and go into cruise when you do not want to. You could be startled and even lose control. Keep the cruise control switch off until you want to use cruise control.

1. Press the cruise control on/off button.
2. Get up to the desired speed.
3. Press and release the SET- button located on the steering wheel.
4. Take your foot off the accelerator.

Resuming a Set Speed

If cruise control is set at a desired speed and the brakes are applied, this shuts off the cruise control. However, it does not need to be reset.

Once your vehicle reaches a speed of about 25 mph (40 km/h) or more, press the +RES button on the steering wheel. The vehicle goes back to the previously selected speed and stays there.

Increasing Speed While Using Cruise Control

To increase the cruise speed while using cruise control:

- Press and hold the +RES button on the steering wheel until you reach your new desired speed, then release it.
- To increase vehicle speed in small increments, press the +RES button. Each time this is done, the vehicle will go about 1 mph (1.6 km/h) faster.

Reducing Speed While Using Cruise Control

To reduce your speed while using cruise control:

- Press and hold the SET- button on the steering wheel until you reach the desired lower speed, then release it.
- To slow down in very small amounts, press the SET- button on the steering wheel briefly. Each time this is done, the vehicle will go about 1 mph (1.6 km/h) slower.

Passing Another Vehicle While Using Cruise Control



Use the accelerator pedal to increase vehicle speed. When you take your foot off the pedal, the vehicle will slow down to the cruise speed you set earlier.

Using Cruise Control on Hills

How well the cruise control will work on hills depends upon the vehicle speed, load and the steepness of the hills. When going up steep hills, you might have to step on the accelerator pedal to maintain your speed. When going downhill, you might have to brake or shift to a lower gear to keep your speed down. If the brakes are applied the cruise control will turn off. Many drivers find this to be too much trouble and do not use cruise control on steep hills.

Ending Cruise Control

There are three ways to end cruise control:

- Step lightly on the brake pedal.
- Press the  button on the steering wheel.
- Press the  button on the steering wheel.

Erasing Speed Memory

The cruise control set speed memory is erased by turning off the cruise control or the ignition.

Exterior Lamps

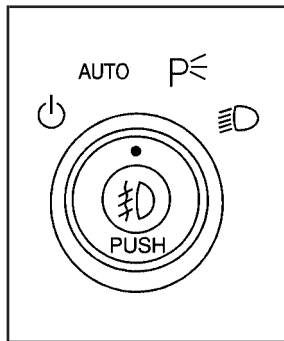

The control located to the left of the cluster on the instrument panel, operates the exterior lamps.

It controls the following systems:

- Headlamps
- Taillamps
- Parking Lamps
- License Plate Lamps
- Instrument Panel Lights
- Fog Lamps (If Equipped)

The exterior lamps control has four positions:

⏻ (On/Off): Briefly turn the control to this position to turn off the automatic light control. Briefly turn to this position again to turn automatic light control on again.

AUTO (Automatic): Turn the control to this position to automatically turn on the headlamps at normal brightness, together with the following:

- Parking Lamps
- Taillamps
- License Plate Lamps
- Instrument Panel Lights

P (Parking Lamps): Turn the control to this position to turn on the parking lamps together with the following:

- Taillamps
- License Plate Lamps
- Instrument Panel Lights

 **(Headlamps):** Turn the control to this position to turn on the headlamps together with the following lamps listed below.

A warning chime will sound if the driver's door is opened when the ignition switch is turned to LOCK/OFF or ACC/ACCESSORY and the headlamps or parking lamps are on.

- Parking Lamps
- Taillamps
- License Plate Lamps
- Instrument Panel Lights

 **(Foglamps) (If Equipped):** Push the fog lamps button to turn them on and off. See *Fog Lamps on page 3-15* for additional information.

Daytime Running Lamps (DRL)/ Automatic Headlamp System

Daytime Running Lamps (DRL) can make it easier for others to see the front of your vehicle during the day. DRL can be helpful in many different driving conditions, but they can be especially helpful in the short periods after dawn and before sunset. DRL lamps are required to function at all times on all vehicles first sold in Canada.

A light sensor on top of the instrument panel makes the DRL work, so be sure it is not covered.

The DRL system will make the low-beam headlamps come on at reduced brightness when the following conditions are met:

- The ignition is on.
- The exterior lamps control is off.
- The parking brake is released.

While the DRL are on, only the vehicle's low-beam headlamps will be on at reduced brightness. The turn signal, taillamps, sidemarker, and other lamps will not be on. The instrument panel will not be lit up either.

When it is dark enough outside, the DRL will turn off and the vehicle's headlamps and parking lamps will turn on. The other lamps that come on with the headlamps will also come on.

When it is bright enough outside, the headlamps will go off and the DRL will come on.

To idle the vehicle with the DRL off, turn the exterior lamp control off and then do one of the following:

- Turn the exterior lamp control to the parking lamp position.
- Turn the exterior lamp control to the headlamp position.
- Turn the exterior lamp control from AUTO to off and back to AUTO.

This feature is not available for vehicles first sold in Canada.

To turn off the automatic headlamp feature when it is dark outside, move the exterior lamp control to the parking lamp position. The parking lamps remain on and the headlamps turn off. The fog lamps also go on if they were on previously.

As with any vehicle, the regular headlamp system should be turned on when needed.

Fog Lamps

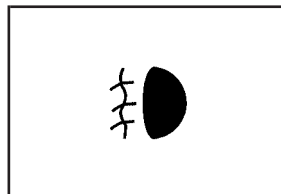

If your vehicle has fog lamps, the button is located in the center of the exterior lamps control on the left side of the steering column.

Press the fog lamps button to turn the lamps on or off.

While the high-beam headlamps are on, the fog lamps are off.

Some localities have laws that require the headlamps to be on along with the fog lamps.

Exterior Lighting Battery Saver

If the parking lamps or headlamps have been left on after the ignition has been turned to off, the exterior lamps will turn off after about 10 minutes. This protects the battery from being drained.

Use the exterior lamp control to turn the lamps back on, if they are still needed.

Interior Lamps

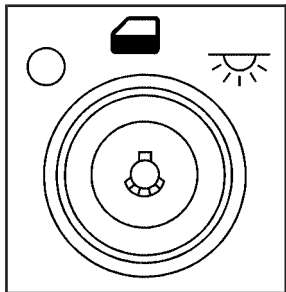

Your interior lamps control is located next to the exterior lamps control and to the left of the steering wheel on the instrument panel.

○ **(Off):** Turn the control to this position to disable courtesy lamps, entry lighting, delayed entry lighting, and delayed exit lighting.

🚪 **(Door):** Turn the control to this position to turn the interior lamps on when any door is open and when the ignition key is removed from the ignition.

☀️ **(On):** Turn the control to this position to turn on the interior lamps.

The interior lamps can be controlled, or automatically turned on or off under certain conditions. They are explained in the following text.

Instrument Panel Brightness

The instrument panel lights can be brightened or dimmed by pressing the center knob of the interior lamp controls until it pops out. Turn the knob clockwise to brighten the lights or counterclockwise to dim them.

Courtesy Lamps

Courtesy lamps come on to make it easier to enter and exit the vehicle. These lamps will come on when the interior lamp control is in the door position and any door is opened.

Entry Lighting

The courtesy lamps come on and stay on for a set time whenever the interior lamp control is in the door position and the UNLOCK button on the Remote Keyless Entry (RKE) transmitter is pressed.

The lamps stay on while a door is opened and then turn off automatically about 25 seconds after it is closed. If the UNLOCK button is pressed and a door is not opened, the lamps will turn off after about 25 seconds.

The courtesy lamps turn off when the ignition key is turned to ON/RUN or START. They will come on again when a door is opened.

Delayed Entry Lighting

Delayed entry lighting lights the vehicle's interior for a period of time after all the doors have been closed.

After all the doors have been closed, the delayed entry lighting feature will continue to work until one of the following occurs:

- The ignition is in ON/RUN.
- The doors are locked.
- 25 seconds has passed.

If during the illumination period a door is opened, the timed illumination period will be canceled and the interior lamps will remain on.

Theater Dimming

This feature allows for a three to five second fade out of the courtesy lamps instead of immediate turn off.

Delayed Exit Lighting

This feature can be programmed either on or off using the Driver Information Center. See *DIC Vehicle Personalization on page 3-76* under INT (Interior) LIGHTS KEYS REMOVED. When activated, the interior will be lit for a short period of time after the ignition key is removed from the ignition.

The ignition must be off and the interior lamp control must be in the door position for delayed exit lighting to work. When the ignition key is removed, interior illumination will activate and remain on until one of the following occurs:

- The ignition is in ON/RUN.
- The power door locks are activated.
- 25 seconds has passed.

If during the illumination period a door is opened, the timed illumination period will be canceled and the interior lamps will remain on.

Perimeter Lighting

Perimeter lighting provides a period of exterior vehicle lighting. Perimeter lighting activates when the key is removed from the ignition or the vehicle is unlocked using the Remote Keyless Entry (RKE) transmitter. The amount of time the exterior lamps will remain on can be programmed using the Driver Information Center (DIC). See "EXIT LIGHT DELAY" under *DIC Vehicle Personalization on page 3-76* for additional information.

Overhead Console Reading Lamps

Your vehicle may have reading lamps located on the overhead console. Press the lens to turn them on and off.

Rear Assist Handle Reading Lamps

Your vehicle may have reading lamps located near the rear assist handles. Press the lens to turn them on and off.

Electric Power Management

The vehicle has Electric Power Management (EPM) that estimates the battery's temperature and state of charge. It then adjusts the voltage for best performance and extended life of the battery.

When the battery's state of charge is low, the voltage is raised slightly to quickly put the charge back in. When the state of charge is high, the voltage is lowered slightly to prevent overcharging. If the vehicle has a voltmeter gage or voltage display on the Driver Information Center (DIC), you may see the voltage move up or down. This is normal. If there is a problem, an alert will be displayed.

The battery can be discharged at idle if the electrical loads are very high. This is true for all vehicles. This is because the generator (alternator) may not be spinning fast enough at idle to produce all the power that is needed for very high electrical loads.

A high electrical load occurs when several of the following loads are on: headlamps, high beams, fog lamps, rear window defogger, climate control fan at high speed, heated seats, engine cooling fans, trailer loads, and loads plugged into accessory power outlets.

EPM works to prevent excessive discharge of the battery. It does this by balancing the generator's output and the vehicle's electrical needs. It can increase engine idle speed to generate more power, whenever needed. It can temporarily reduce the power demands of some accessories.

Normally, these actions occur in steps or levels, without being noticeable. In rare cases at the highest levels of corrective action, this action may be noticeable to the driver. If so, the Driver Information Center (DIC) message might display Battery Saver Active. If this message is displayed, it is recommended that the driver reduce the electrical loads as much as possible. See *DIC Warnings and Messages on page 3-58*.

Battery Run-Down Protection

This helps prevent the vehicle's battery from draining in case the interior courtesy lamps, reading lamps, trunk lamp, underhood lamp, glove box lamps, or sun visor vanity lamps, if equipped, are accidentally left on. If any of these lamps are left on while the ignition is off, they will automatically turn off after 10 minutes. The lamps will not come back on again until one of the following occurs:

- The ignition is turned on.
- The interior lamps control is turned off, then to door or on.

Accessory Power Outlet(s)

The accessory power outlets enable power electrical equipment such as a cellular telephone or a CB radio to be used inside the vehicle.

Your vehicle has 12-volt outlets. One outlet is located on the center console below the climate controls. There may be another outlet located inside the center storage console or in the flip and fold console.

Open the cover to use the outlet. Be sure to close the cover when the outlet is not in use.

Notice: Adding any electrical equipment to your vehicle may damage it or keep other components from working as they should. The repairs would not be covered by your warranty. Do not use equipment exceeding maximum amperage rating of 20 amperes. Check with your dealer/retailer before adding electrical equipment.

Certain power accessory plugs may not be compatible to the power accessory outlet and could result in blown vehicle or adapter fuses. If you experience a problem, see your dealer/retailer.

Notice: Improper use of the power outlet can cause damage not covered by your warranty. Do not hang any type of accessory or accessory bracket from the plug because the power outlets are designed for accessory power plugs only.

Notice: Leaving electrical equipment plugged in for an extended period of time while the vehicle is off will drain the battery. Power is always supplied to the outlets. Always unplug electrical equipment when not in use and do not plug in equipment that exceeds the maximum 20 ampere rating.

When adding electrical equipment, be sure to follow the proper installation instructions included with the equipment.

Ashtray(s) and Cigarette Lighter

Your vehicle may have a removable ashtray and cigarette lighter. The cigarette lighter may be located under the climate control system. The removable ashtray can be placed into the front console cupholder.

Notice: If you put papers, pins, or other flammable items in the ashtray, hot cigarettes or other smoking materials could ignite them and possibly damage your vehicle. Never put flammable items in the ashtray.

To use the cigarette lighter, push it in all the way, and let go. When the heating element is ready, it will pop back out by itself.

Notice: Holding a cigarette lighter in while it is heating will not allow the lighter to back away from the heating element when it is hot. Damage from overheating may occur to the lighter or heating element, or a fuse could be blown. Do not hold a cigarette lighter in while it is heating. Do not use equipment exceeding maximum amperage rating of 20 amperes.

Climate Controls

Climate Control System

With this system you can control the heating, cooling and ventilation for your vehicle.

If your vehicle has the remote start feature and it is activated, the climate control system will automatically cool the vehicle if the temperature is greater than 90°F (32°C) and heat the vehicle if the temperature is below 37°F (3°C). If the temperature is between 37°F (3°C) and 90°F (32°C), the last control setting selected when the engine was running will be used. Normal operation and the last setting of the climate control system will return after the key is turned to the ON/RUN position.

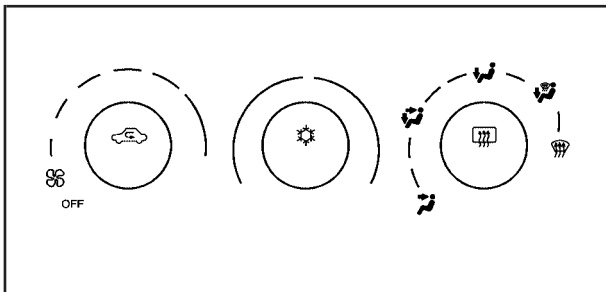

Operation

OFF: Turn the left knob to this position to turn the climate control system off.

 **(Fan):** Turn the knob by this symbol, located on the left side of the climate control panel, clockwise or counterclockwise to increase or decrease the fan speed. The fan speed will be temporarily reduced between the transition to a new mode. The fan will resume the original speed when the transition to the new mode is complete.

Temperature Control: Turn the center knob clockwise or counterclockwise to increase or decrease the temperature inside your vehicle.

Use the right knob to select from the following modes:

 **(Vent):** This mode directs outside air to the instrument panel outlets. If driving in city traffic, and the vehicle is stopped and idling, or the weather is hot, turning on the recirculation mode helps to prevent the air inside the vehicle from becoming stale. After five minutes recirculate will allow some outside air into the vehicle.

 **(Bi-Level):** This mode directs half of the air to the instrument panel outlets, and the remaining air to the floor outlets. Some air may be directed toward the windshield. Slightly cooler air is directed to the instrument panel outlets and warmer air is directed to the floor outlets.

 **(Floor):** This mode directs most of the air to the floor outlets with some air directed toward the side window outlets and a little air directed to the windshield.

In this mode, the system will automatically use outside air. The air conditioning compressor will be engaged unless the outside temperature is 40°F (4°C) or below.

You can also select modes by using the following buttons:

 **(Recirculate):** Press this button to recirculate cabin air through the vehicle. It can be used to help reduce the outside air and odors that enter your vehicle or to help heat or cool the air inside your vehicle quicker. An indicator light below the button will come on in this mode. Operation in this mode during periods of high humidity and cool outside temperatures may result in increased window fogging. If window fogging is experienced, select the defrost mode. To prevent the air inside the vehicle from becoming stale, after five minutes recirculate will allow some outside air into the vehicle.

 **(Air Conditioning):** Press this button to turn the air conditioning system on or off. When this button is pressed, an indicator light below the button will come on to let you know the air conditioning is activated. Air conditioning can be selected in any mode as long as the fan switch is on. The indicator light will change with each button press even when conditions prevent operation.

On hot days during the vehicle's initial start-up, open the windows to let hot inside air escape; then close them. This helps to reduce the time it takes for the vehicle to cool down. It also helps the system to operate more efficiently.

For quicker cool down on hot days, do the following:

1. Select the vent air mode.
2. Select the recirculation mode.
3. Select the air conditioner.
4. Select the coolest temperature.
5. Select the highest fan speed.

The air conditioning system removes moisture from the air, so you may sometimes notice a small amount of water dripping underneath your vehicle while idling or after turning off the engine. This is normal.

Using these settings together for long periods of time may cause the air inside the vehicle to become too dry. To prevent this, after five minutes recirculate will allow some outside air into the vehicle.

Defogging and Defrosting

Fog on the inside of the vehicle is a result of high humidity causing moisture to condense on the cool window glass. This can be minimized if the climate control system is used properly. There are two modes to clear frost or fog from the windshield. Use the defog mode to clear the windows of condensation and to warm the vehicle's occupants. Use the defrost mode to remove frost or condensation from the windshield quickly.

See "Rear Window Defogger" later in this section for information on clearing the rear window of fog or ice.

Turn the right knob to select the defog or defrost mode.
Do not drive the vehicle until all windows are clear.

 **(Defog):** This mode directs half of the air to the windshield and the side window outlets and half to the floor outlets. When you select this mode, the system turns recirculation off and runs the air conditioning compressor unless the outside temperature is near or below freezing. Pressing the recirculation button will have no effect other than turning on the indicator light while in defog mode.

 **(Defrost):** This mode directs most of the air to the windshield and the side window outlets, with some air directed to the floor outlets. When you select this mode, the system turns recirculation off and runs the air conditioning compressor unless the outside temperature is near or below freezing. Pressing the recirculation button will have no effect other than turning on the indicator light while in defrost mode.

Rear Window Defogger

The rear window defogger uses a warming grid to remove fog from the rear window.

 **(Rear):** Press the button to turn the rear window defogger on or off. An indicator light below the button will come on to let you know that the rear window defogger is activated.

The rear window defogger will only work when the ignition is in ON/RUN. The rear window defogger will stay on for about 20 minutes after the button is pressed. If turned on again, the defogger will only run for about 20 minutes before turning off. The defogger can also be turned off by pressing the button again or by turning off the engine.

Do not drive the vehicle until all windows are clear.

Notice: Do not use anything sharp on the inside of the rear window. If you do, you could cut or damage the warming grid, and the repairs would not be covered by your warranty. Do not attach a temporary vehicle license, tape, a decal or anything similar to the defogger grid.

Dual Automatic Climate Control System

With this system you can control the heating, cooling, and ventilation for the vehicle.

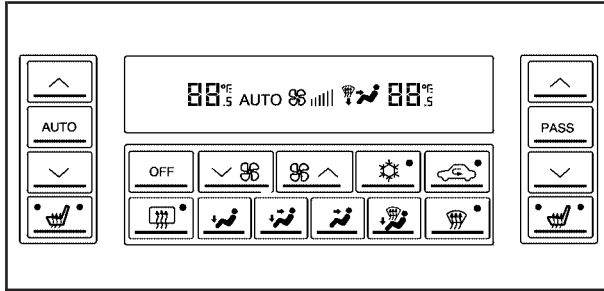

Automatic Operation

AUTO (Automatic): Press the AUTO button for automatic control of the inside temperature, the air delivery mode, and the fan speed. There might be a delay of two to three minutes before the fan comes on when the automatic operation is used in cold weather. For the automatic system to function, the temperature must be set between 61°F (15°C) and 89°F (32°C).

1. Adjust the temperature to a comfortable setting.
2. Press the PASS button or the up or down arrows on the passenger side to turn the passenger temperature set on and off. When turned on, the passenger temperature will be the same as the driver setting. Press the up or down arrow on passenger side to adjust the passenger temperature setting.

When the passenger's temperature set is off, the passenger display will be off and the driver's set temperature will be for the driver and passenger.

In cold weather, the system will start at reduced fan speeds to avoid blowing cold air into the vehicle until warmer air is available. The system will start out blowing air at the floor but may change modes automatically as the vehicle warms up to maintain the chosen temperature setting. The length of time needed for warm up will depend on the outside temperature and the length of time that has elapsed since the vehicle was last driven.

3. Wait for the system to regulate. This may take from 10 to 30 minutes. Then, adjust the temperature, if necessary.

Do not cover the solar sensor located in the center of the instrument panel, near the windshield. For more information on the solar sensor, see "Sensors" later in this section.

4. Press OFF to turn the climate control system off. Only the rear defog and heated seats will function. Press AUTO or any other button except the heated seats or rear defog to turn the climate control system back on.

This control has four types of operation.

- Automatic can set/change the temperature only. AUTO and temperature only will appear on the display.
- Semi-Automatic Fan can set/change the temperature and mode. The fan operates automatically. The temperature and mode will appear on the display.
- Semi-Automatic Mode can set/change the temperature and fan speed. The mode operates automatically. The fan speed and temperature will appear on the display.
- Manual can set/change the temperature, mode and fan. The fan speed, temperature, and mode will appear on the display.

If your vehicle has the remote start feature, the climate control system will automatically regulate the inside temperature of your vehicle when the remote start system is activated. Normal operation and the last setting of the climate control system will return after the key is turned on.

Manual Operation

During daylight hours, the instrument panel brightness control might need to be adjusted to the highest setting, in order to see the indicator lights for the various climate control settings.

OFF: Press this button to turn the climate control system off.

^ v (Temperature): Press these buttons to manually adjust the temperature inside the vehicle. Press the up arrow on the driver or passenger side to raise the temperature, and press the down arrow to lower the temperature. The display will show the selected temperature.

v  (Fan): Press this button to decrease the fan speed. Pressing the arrows cancels the automatic operation and places the system in manual or semi-automatic mode. Press the AUTO button to return to automatic operation. If the airflow seems low when the fan is at the highest setting, the passenger compartment air filter may need to be replaced. For more information see *Passenger Compartment Air Filter on page 3-29* and *Scheduled Maintenance on page 6-4*.

 **(Fan):** Press this button to increase the fan speed. Pressing the arrows cancels the automatic operation and places the system in manual or semi-automatic mode. Press the AUTO button to return to automatic operation. If the airflow seems low when the fan is at the highest setting, the passenger compartment air filter may need to be replaced. For more information see *Passenger Compartment Air Filter on page 3-29* and *Scheduled Maintenance on page 6-4*.

 **(Floor):** This mode directs most of the air to the floor, with some air directed to the side window outlets and a small amount to the windshield.

 **(Bi-Level):** This setting directs airflow to the instrument panel and floor outlets. A small amount of air is also directed to the windshield and the side window outlets.

 **(Vent):** This mode directs air through the instrument panel outlets.

 **(Recirculation):** Press this button to turn recirculation mode on or off. This mode keeps outside air from coming into the vehicle. It can be used to help reduce the outside air and odors that enter your vehicle or help cool the air inside the vehicle quicker.

Recirculation is not available while in the floor, defrost, or floor/defog modes. Using recirculation for long periods of time may cause the air inside your vehicle to become too dry. Recirculation mode has a five minute timer after which the system allows for some fresh outside air into the vehicle to maintain interior air quality.

 **(Air Conditioning):** Press this button to turn the air conditioning compressor on and off. The indicator light on the button will come on when the air conditioning is on. The indicator light will change with each button press even when conditions prevent operation.

 **(Heated Seats):** Press this button to turn the driver or passenger heated seats on and off. See *Heated Seats on page 1-3* for additional information.

Defogging and Defrosting

Fog on the inside of windows is a result of high humidity (moisture) condensing on the cool window glass. This can be minimized if the climate control system is used properly. There are two modes to clear fog or frost from your windshield. Use the floor/defog mode to clear the windows of fog or moisture and warm the passengers. Use defrost to remove fog or frost from the windshield more quickly.

 **(Floor/Defog):** Press this button to direct the air between the windshield, floor outlets and side windows. When you select this mode, the system turns recirculation off and runs the air conditioning compressor unless the outside temperature is near or below freezing. Pressing the recirculation button will have no effect other than turning on the indicator light while in floor/defog mode.

 **(Defrost):** Press this button to direct most of the air to the windshield, with some air directed to the side windows. In this mode, the system will automatically turn off the recirculation and run the air conditioning compressor, unless the outside temperature is near or below freezing. Pressing the recirculation button will have no effect other than turning on the indicator light while in defrost mode.

Do not drive the vehicle until all windows are clear.

Sensors

The solar sensor on the vehicle monitors the solar heat and the air inside of the vehicle. This information is used to maintain the selected temperature by initiating needed adjustments to the temperature, the fan speed, and the air delivery system. The system may also supply cooler air to the side of the vehicle facing the sun. The recirculation mode will also be activated, as necessary. Do not cover the solar sensor located in the center of the instrument panel, near the windshield, or the system will not work properly.

Rear Window Defogger

The rear window defogger uses a warming grid to remove fog or frost from the rear window. The rear window defogger will only work when the engine is running.

 **(Rear Window Defogger):** Press this button to turn the rear window defogger on and off. Be sure to clear as much snow from the rear window as possible.

The rear window defogger will turn off about 20 minutes after the button is pressed. If turned on again, the defogger will only run for about 20 minutes before turning off. The defogger can also be turned off by pressing the button again or by turning off the engine.

Do not drive the vehicle until all the windows are clear.

Notice: Do not use a razor blade or sharp object to clear the inside rear window. Do not adhere anything to the defogger grid lines in the rear glass. These actions may damage the rear defogger. Repairs would not be covered by your warranty.

Outlet Adjustment

Use the thumbwheels located between the center outlets to open and close the outlets. Move the lever in the center of each air outlet to adjust the direction of the airflow.

Operation Tips

- Clear away any ice, snow or leaves from the air inlets at the base of the windshield that may block the flow of air into the vehicle.
- Use of non-GM approved hood deflectors may adversely affect the performance of the system.
- Keep the path under the front seats clear of objects to help circulate the air inside of the vehicle more effectively.
- This vehicle has a passenger compartment air filter. If the airflow seems low when the fan is at the highest setting it may need to be replaced. For more information, see *Passenger Compartment Air Filter* on page 3-29.

Passenger Compartment Air Filter

The passenger compartment air filter is located in the engine compartment below the air inlet grille, near the passenger's side windshield wiper arm. See *Engine Compartment Overview on page 5-12*.

The filter traps most of the pollen from the air entering the air conditioning module. The filter needs to be changed periodically to keep the air conditioning working at its best. For information on how often to change the passenger compartment air filter, see *Scheduled Maintenance on page 6-4*.

To change the passenger compartment air filter, use the following steps:

1. Turn the ignition to ACC/ACCESSORY and turn the windshield wipers on.
2. Turn the ignition to LOCK/OFF when the windshield wipers are in the upright position.
3. Raise the hood.

4. Disconnect the windshield washer pump hose from the fender rail and air inlet grille.
5. Peel back the hood weather-strip from the passenger's side of the vehicle halfway to the center of the hood.

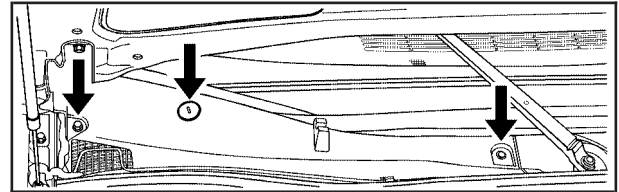

6. Remove the three air inlet grille retainers.
7. Remove the air inlet grille.
8. Remove the water deflector panel.

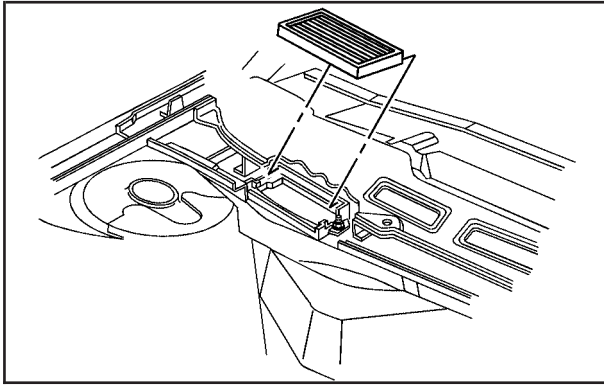

Warning Lights, Gages, and Indicators

This part describes the warning lights and gages that may be on the vehicle. The pictures will help you locate them.

Warning lights and gages can signal that something is wrong before it becomes serious enough to cause an expensive repair or replacement. Paying attention to the warning lights and gages could also save you or others from injury.

Warning lights come on when there may be or is a problem with one of the vehicle's functions. As you will see in the details on the next few pages, some warning lights come on briefly when you start the engine just to let you know they are working. If you are familiar with this section, you should not be alarmed when this happens.

Gages can indicate when there may be or is a problem with one of your vehicle's functions. Often gages and warning lights work together to let you know when there is a problem with your vehicle.

When one of the warning lights comes on and stays on when you are driving, or when one of the gages shows there may be a problem, check the section that tells you what to do about it. Please follow this manual's advice. Waiting to do repairs can be costly – and even dangerous. So please get to know the warning lights and gages. They are a big help.

9. Remove the old air filter.
10. Install a new passenger compartment air filter. See *Maintenance Replacement Parts on page 6-13* for the type of filter to use. Make sure it slides under the compartment retainers.
11. Reverse Steps 1 through 8.

For best climate control performance, re-installation of a clean air filter is required.

Instrument Panel Cluster

The instrument panel cluster is designed to let the driver know at a glance how the vehicle is running. It will show how fast the vehicle is going, about how much fuel is in the fuel tank and many other things needed to drive safely and economically.

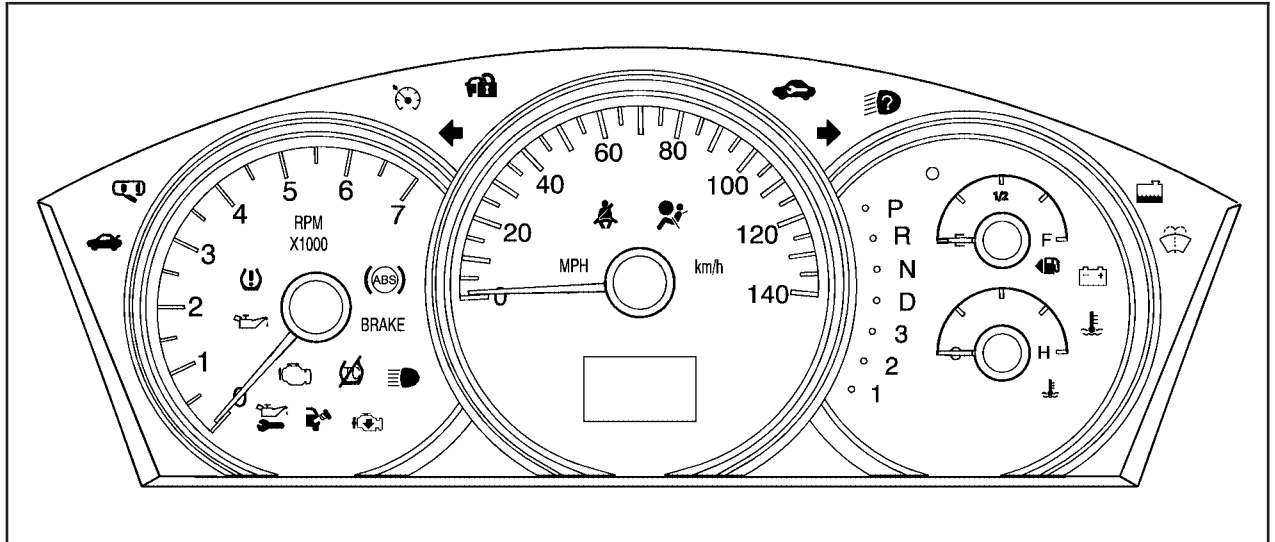

Base level shown, Uplevel similar

Speedometer and Odometer

Your speedometer lets you see your speed in both miles per hour (mph) and kilometers per hour (km/h).

Your vehicle's odometer works together with the driver information center. You can set a Trip A and Trip B odometer. See "Trip Information" under *DIC Operation and Displays* on page 3-50.

The odometer mileage can be checked without the vehicle running. Simply press the odometer/trip switch on the instrument panel cluster.

If your vehicle ever needs a new odometer installed, the new one will be set to the correct mileage total of the old odometer.

Tachometer

Your tachometer displays the engine speed in revolutions per minute (rpm).

Safety Belt Reminders

Safety Belt Reminder Light

When the engine is started, a chime will come on for several seconds to remind people to fasten their safety belts, unless the driver's safety belt is already buckled.



The safety belt light will also come on and stay on for several seconds, then it will flash for several more.

This chime and light is repeated if the driver remains unbuckled and the vehicle is in motion. If the driver's belt is already buckled, neither the chime nor the light will come on.

Passenger Safety Belt Reminder Light

Several seconds after the engine is started, a chime will sound for several seconds to remind the front passenger to buckle their safety belt. This would only occur if the passenger airbag is enabled. See *Passenger Sensing System on page 1-62* for more information. The passenger safety belt light, located on the instrument panel, will come on and stay on for several seconds and then flash for several more.



This chime and light are repeated if the passenger remains unbuckled and the vehicle is in motion.

If the passenger's safety belt is buckled, neither the chime nor the light will come on.

Airbag Readiness Light

There is an airbag readiness light on the instrument panel cluster, which shows the airbag symbol. The system checks the airbag's electrical system for malfunctions. The light tells you if there is an electrical problem. The system check includes the airbag sensor, the pretensioners, the airbag modules, the wiring and the crash sensing and diagnostic module. For more information on the airbag system, see *Airbag System on page 1-54*.



This light will come on when you start your vehicle, and it will flash for a few seconds. The light should go out and the system is ready.

If the airbag readiness light stays on after you start the vehicle or comes on when you are driving, your airbag system may not work properly. Have your vehicle serviced right away.

CAUTION:

If the airbag readiness light stays on after you start your vehicle, it means the airbag system may not be working properly. The airbags in your vehicle may not inflate in a crash, or they could even inflate without a crash. To help avoid injury to yourself or others, have your vehicle serviced right away if the airbag readiness light stays on after you start your vehicle.

The airbag readiness light should flash for a few seconds when you start the engine. If the light does not come on then, have it fixed immediately. If there is a problem with the airbag system, an airbag Driver Information Center (DIC) message may also come on. See *DIC Warnings and Messages on page 3-58* for more information.

Passenger Airbag Status Indicator

Your vehicle has the passenger sensing system. Your instrument panel has a passenger airbag status indicator.



When you start the vehicle, the passenger airbag status indicator will light ON and OFF for several seconds as a system check.

If you use remote start to start your vehicle from a distance, if equipped, you may not see the system check. Then, after several more seconds, the status indicator will light either ON or OFF to let you know the status of the right front passenger's frontal airbag.

If the word ON is lit on the passenger airbag status indicator, it means that the right front passenger's frontal airbag is enabled (may inflate).

 **CAUTION:**

If the on indicator comes on when you have a rear-facing child restraint installed in the right front passenger's seat, it means that the passenger sensing system has not turned off the passenger's frontal airbag. A child in a rear-facing child restraint can be seriously injured or killed if the right front passenger's airbag inflates. This is because the back of the rear-facing child restraint would be very close to the inflating airbag. Do not use a rear-facing child restraint in the right front passenger's seat if the airbag is turned on.

 **CAUTION:**

Even though the passenger sensing system is designed to turn off the right front passenger's frontal airbag if the system detects a rear-facing child restraint, no system is fail-safe, and no one can guarantee that an airbag will not deploy under some unusual circumstance, even though it is turned off. We recommend that rear-facing child restraints be secured in the rear seat, even if the airbag is off.

If the word OFF is lit on the airbag status indicator, it means that the passenger sensing system has turned off the right front passenger's frontal airbag. See *Passenger Sensing System on page 1-62* for more on this, including important safety information.

If, after several seconds, both status indicator lights remain on, or if there are no lights at all, there may be a problem with the lights or the passenger sensing system. See your dealer/retailer for service.

CAUTION:

If the airbag readiness light in the instrument panel cluster ever comes on and stays on, it means that something may be wrong with the airbag system. If this ever happens, have the vehicle serviced promptly, because an adult-size person sitting in the right front passenger's seat may not have the protection of the airbag(s). See *Airbag Readiness Light on page 3-33* for more on this, including important safety information.

Charging System Light

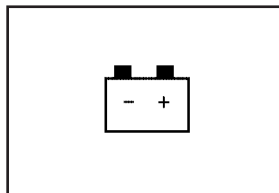

This light will come on briefly when you turn on the ignition key, but the engine is not running, as a check to show you it is working.

It should go out once the engine is running. If it stays on, or comes on while driving, there could be a problem with the charging system. A charging system Driver Information Center (DIC) message may also appear. See *DIC Warnings and Messages on page 3-58* for more information. This light could indicate that there are problems with a generator drive belt, or that there is an electrical problem. Have it checked right away. If you must drive a short distance with the light on, be certain to turn off all the accessories, such as the radio and air conditioner.

Brake System Warning Light

Your vehicle's hydraulic brake system is divided into two parts. If one part is not working, the other part can still work and stop you. For good braking, though, you need both parts working well.

If the warning light comes on and the parking brake is not applied, there is a brake problem. Have your brake system inspected right away.

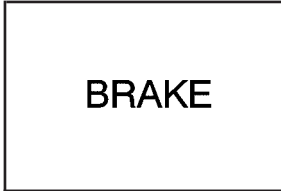

This light should come on briefly when you turn the ignition key to ON/RUN.

If it does not come on then, have it fixed so it will be ready to warn you if there is a problem.

When the ignition is on, the brake system warning light will also come on when you set your parking brake. The light will stay on if your parking brake does not release fully. If it stays on after your parking brake is fully released, it means you have a brake problem.

If the light comes on while you are driving, a chime will sound and you should pull off the road and stop carefully. You may notice that the pedal is harder to push. Or, the pedal may go closer to the floor. It may take longer to stop. If the light is still on, have the vehicle towed for service. See *Towing Your Vehicle on page 4-27*.

CAUTION:

Your brake system may not be working properly if the brake system warning light is on. Driving with the brake system warning light on can lead to an accident. If the light is still on after you have pulled off the road and stopped carefully, have the vehicle towed for service.

Antilock Brake System Warning Light

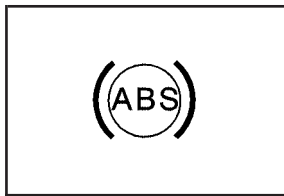

For vehicles with the Antilock Brake System (ABS), this light comes on briefly when the engine is started.

That is normal. If the light does not come on then, have it fixed so it will be ready to warn you if there is a problem.

If the ABS light stays on, turn the ignition off, if the light comes on when you are driving, stop as soon as it is safely possible and turn the ignition off. Then start the engine again to reset the system. If the ABS light still stays on, or comes on again while you are driving, your vehicle needs service. If the regular brake system warning light is not on, your vehicle still has brakes, but not antilock brakes. If the regular brake system warning light is also on, your vehicle does not have antilock brakes and there is a problem with the regular brakes. See *Brake System Warning Light* on page 3-37.

For vehicles with a Driver Information Center (DIC), see *DIC Warnings and Messages* on page 3-58 for all brake related DIC messages.

Traction Control System (TCS) Warning Light

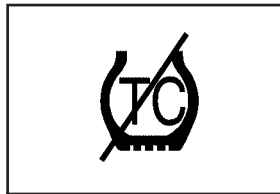

Your vehicle has a Traction Control System (TCS) warning light.

If this warning light comes on and stays on, there may be a problem with the TCS and, if your vehicle has this feature, the StabiliTrak[®] system.

The TCS warning light will come on briefly when the engine is started. If it does not come on then, have it fixed so it will be ready to warn you if there is a problem. This light will also come on when the traction control button is pressed disabling the system.

If the TCS warning light stays on or comes on while you are driving, pull off the road as soon as possible and stop carefully. Try resetting the system by turning the ignition off then back on. If the light still stays on or comes back on again while you are driving, your vehicle needs service. Have the traction control system and, if your vehicle has this feature, the StabiliTrak[®] system inspected as soon as possible. See *Traction Control System (TCS)* on page 4-6 and *StabiliTrak[®] System* on page 4-8 for more information.

Enhanced Traction System Warning Light

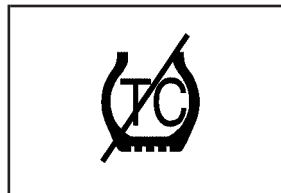

For vehicles with the Enhanced Traction System (ETS), this light may come on for the following reasons:

- If the traction control button located on the center console is pressed, turning the system off. This light will come on and stay on. To turn the system back on, press the button again and the warning light should turn off. See *Enhanced Traction System (ETS)* on page 4-7.
- If the system is affected by an engine-related problem, the system will turn off and the warning light will come on.

If the light comes on and stays on for an extended period of time when the system is turned on, the vehicle needs service.

Engine Coolant Temperature Warning Light

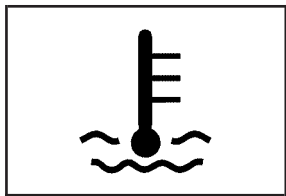

The engine coolant temperature warning light will come on when the engine has overheated.

If this happens you should pull over and turn off the engine as soon as possible. See *Engine Overheating on page 5-30* for more information.

Notice: Driving with the engine coolant temperature warning light on could cause your vehicle to overheat. See *Engine Overheating on page 5-30*. Your vehicle could be damaged, and it might not be covered by your warranty. Never drive with the engine coolant temperature warning light on.

This light will also come on briefly when starting your vehicle. If it does not, have your vehicle serviced.

Engine Coolant Temperature Gage

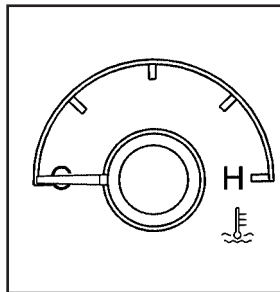

The vehicle has a gage that shows the engine coolant temperature.

If the gage pointer moves towards the H, the engine is too hot.

This reading indicates the same thing as the warning light. It means that the engine coolant has overheated. If the vehicle has been operating under normal driving conditions, pull off the road, stop the vehicle, and turn off the engine as soon as possible. See *Engine Overheating on page 5-30*.

Low Coolant Warning Light

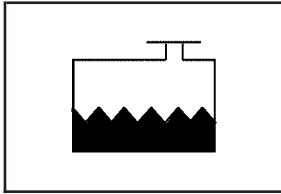

If your vehicle has this light, it comes on briefly when you turn your ignition on as a bulb check only.

Tire Pressure Light

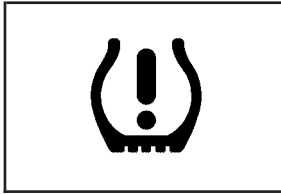

Your vehicle has a tire pressure light.

This light comes on briefly when the engine is started and provides information about tire pressures and the Tire Pressure Monitoring System.

When the Light is Solid

This indicates that one or more of your tires are significantly underinflated.

A tire pressure message in the Driver Information Center (DIC), may accompany the light. See *DIC Warnings and Messages on page 3-58* for more information. Stop and check your tires as soon as it is safe to do so. If underinflated, inflate to the proper pressure. See *Tires on page 5-63* for more information.

When the Light Flashes First and Then is Solid

This indicates that there may be a problem with the Tire Pressure Monitor System. The light flashes for about a minute and stays on solid for the remainder of the ignition cycle. This sequence will repeat with every ignition cycle. See *Tire Pressure Monitor System on page 5-71* for more information.

Malfunction Indicator Lamp

Check Engine Light

A computer system called OBD II (On-Board Diagnostics-Second Generation) monitors operation of the fuel, ignition, and emission control systems. It makes sure that emissions are at acceptable levels for the life of the vehicle, helping to produce a cleaner environment.

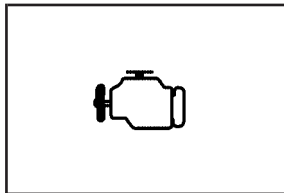

The check engine light comes on to indicate that there is an OBD II problem and service is required.

Malfunctions often are indicated by the system before any problem is apparent. This can prevent more serious damage to your vehicle. This system is also designed to assist your service technician in correctly diagnosing any malfunction.

Notice: If you keep driving your vehicle with this light on, after a while, the emission controls might not work as well, your vehicle's fuel economy might not be as good, and the engine might not run as smoothly. This could lead to costly repairs that might not be covered by your warranty.

Notice: Modifications made to the engine, transmission, exhaust, intake, or fuel system of your vehicle or the replacement of the original tires with other than those of the same Tire Performance Criteria (TPC) can affect your vehicle's emission controls and can cause this light to come on. Modifications to these systems could lead to costly repairs not covered by your warranty. This could also result in a failure to pass a required Emission Inspection/Maintenance test. See *Accessories and Modifications on page 5-3*.

This light comes on, as a check to show it is working, when the ignition is turned ON/RUN but the engine is not running. If the light does not come on, have it repaired. This light also comes on during a malfunction in one of two ways:

- **Light Flashing** — A misfire condition has been detected. A misfire increases vehicle emissions and could damage the emission control system on your vehicle. Diagnosis and service might be required.
- **Light On Steady** — An emission control system malfunction has been detected on your vehicle. Diagnosis and service might be required.

If the Light is Flashing

The following can prevent more serious damage to your vehicle:

- Reduce vehicle speed.
- Avoid hard accelerations.
- Avoid steep uphill grades.
- If you are towing a trailer, reduce the amount of cargo being hauled as soon as it is possible.

If the light stops flashing and remains on steady, see “If the Light Is On Steady” following.

If the light continues to flash, when it is safe to do so, stop the vehicle. Find a safe place to park the vehicle. Turn the ignition off, wait at least 10 seconds, and restart the engine. If the light remains on steady, see “If the Light Is On Steady” following. If the light is still flashing, follow the previous steps and see your dealer/retailer for service as soon as possible.

If the Light Is On Steady

You might be able to correct the emission system malfunction by considering the following:

Did you recently put fuel into your vehicle?

If so, reinstall the fuel cap, making sure to fully install the cap. See *Filling the Tank on page 5-8*. The diagnostic system can determine if the fuel cap has been left off or improperly installed. A loose or missing fuel cap allows fuel to evaporate into the atmosphere. A few driving trips with the cap properly installed should turn the light off.

Did you just drive through a deep puddle of water?

If so, your vehicle’s electrical system might be wet. The condition is usually corrected when the electrical system dries out. A few driving trips should turn the light off.

Have you recently changed brands of fuel?

If so, be sure to fuel your vehicle with quality fuel. See *Gasoline Octane on page 5-5*. Poor fuel quality causes the engine not to run as efficiently as designed. You might notice this as stalling after start-up, stalling when you put the vehicle into gear, misfiring, hesitation on acceleration, or stumbling on acceleration — these conditions might go away once the engine is warmed up. This will be detected by the system and cause the light to turn on.

If you experience one or more of these conditions, change the fuel brand you use. It will require at least one full tank of the proper fuel to turn the light off.

If none of the above steps have made the light turn off, your dealer/retailer can check the vehicle. Your dealer/retailer has the proper test equipment and diagnostic tools to fix any mechanical or electrical problems that might have developed.

Emissions Inspection and Maintenance Programs

Some state/provincial and local governments have or might begin programs to inspect the emission control equipment on your vehicle. Failure to pass this inspection could prevent you from getting a vehicle registration.

Here are some things you need to know to help your vehicle pass an inspection:

Your vehicle will not pass this inspection if the check engine light is on or not working properly.

Your vehicle will not pass this inspection if the OBD (on-board diagnostic) system determines that critical emission control systems have not been completely diagnosed by the system. The vehicle would be considered not ready for inspection. This can happen if you have recently replaced the battery or if the battery has run down. The diagnostic system is designed to evaluate critical emission control systems during normal driving. This can take several days of routine driving. If you have done this and your vehicle still does not pass the inspection for lack of OBD system readiness, your dealer/retailer can prepare the vehicle for inspection.

Oil Pressure Light

CAUTION:

Do not keep driving if the oil pressure is low. If you do, your engine can become so hot that it catches fire. You or others could be burned. Check your oil as soon as possible and have your vehicle serviced.

Notice: Lack of proper engine oil maintenance may damage the engine. The repairs would not be covered by your warranty. Always follow the maintenance schedule in this manual for changing engine oil.

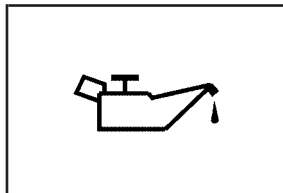

This light will come on briefly when you start your engine as a check to be sure it works. If it does not, have your vehicle serviced.

If the light comes on and stays on, it means that oil is not flowing through your engine properly. You could be low on oil and you might have some other system problem.

Change Engine Oil Light

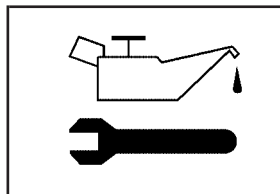

If this light comes on, it means that service is required for your vehicle.

See *Scheduled Maintenance* on page 6-4 and *Engine Oil* on page 5-18 for more information.

After having the oil changed you will need to reset the light. See *Engine Oil* on page 5-18 for more information.

If this light is blinking, a chime will sound indicating low engine oil.

Security Light

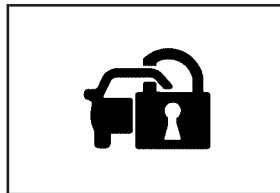

For information regarding this light and the vehicle's security system, see *Content Theft-Deterrent* on page 2-20.

Cruise Control Light

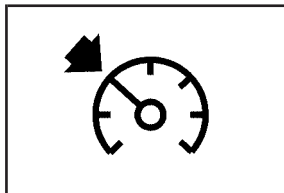

This light comes on whenever you set the cruise control.

The light goes out when the cruise control is turned off. See *Cruise Control* on page 3-10 for more information.

Reduced Engine Power Light

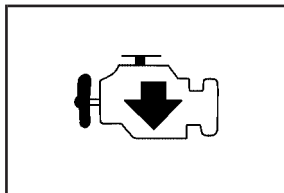

If the reduced engine power light is on, a chime will sound and a noticeable reduction in the vehicle's performance may occur.

If the reduced engine power light is on, but there is no reduction in performance, proceed to your destination. The performance may be reduced the next time the vehicle is driven. The vehicle may be driven at a reduced speed while the reduced engine power light is on, but acceleration and speed may be reduced.

Anytime the reduced engine power light stays on, the vehicle should be taken to an authorized GM dealer as soon as possible for service.

Highbeam On Light

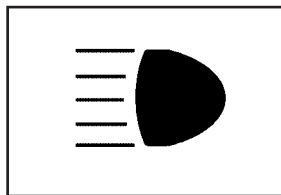

This light comes on when the high-beam headlamps are in use.

See *Headlamp High/Low-Beam Changer* on page 3-8 for more information.

Headlamps Suggested Light

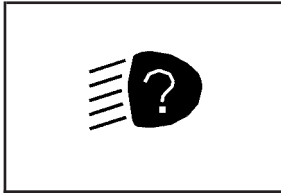

This light will come on when the use of headlamps is suggested.

Door Ajar Light

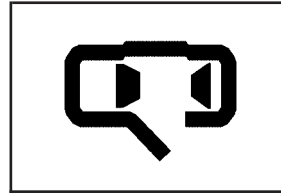

When the ignition is on, this light will stay on until all doors are closed and completely latched.

Low Washer Fluid Warning Light

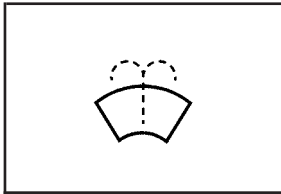

This light will come on briefly when the ignition is on. If the light stays on, a chime will sound indicating your windshield washer fluid is low.

See *Windshield Washer Fluid* on page 5-44 for more information.

You will hear a chime if a door is unlatched after the engine is started and the vehicle is not in PARK (P).

Trunk Ajar Light

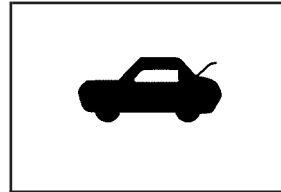

This light will come on and a chime will sound if the trunk is ajar and the vehicle is not in PARK (P).

Try closing the trunk again. Never drive with the trunk open.

Service Vehicle Soon Light



For vehicles with this light, it will come on if a condition exists that may require the vehicle to be taken in for service.

If the light comes on, see your dealer/retailer for service as soon as possible.

Fuel Gage

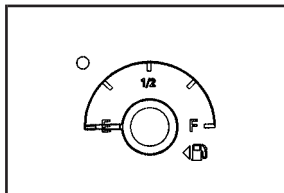

The fuel gage indicates about how much fuel is left in the fuel tank when the ignition is on.

When the indicator nears empty, there is still a little fuel left, but you should get more fuel soon.

Here are four things that some owners ask about. All these things are normal and do not indicate that anything is wrong with the fuel gage:

- At the gas station, the pump shuts off before the gage reads full.
- It takes more, or less, fuel to fill up than the gage reads. For example, the gage reads half full, but it took more, or less, than half of the tank's capacity to fill it.
- The gage pointer may move while cornering, braking or accelerating.
- The gage may not indicate empty when the ignition is turned off.

Low Fuel Warning Light

Your vehicle may have a low fuel light. It is a circle located on the fuel gage and will come on and a chime will sound periodically when the vehicle is low on fuel. The light will go off when fuel is added to the fuel tank.

It will also come on for a few seconds when the ignition is turned on as a check to indicate it is working. If it does not come on then, have it fixed.

For vehicles with a Driver Information Center (DIC), a LOW FUEL message will appear. See *DIC Warnings and Messages on page 3-58* for more information.

Check Gas Cap Light

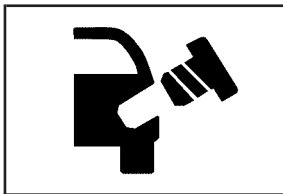

If your vehicle has this light, it will come on if your gas cap is not securely fastened.

See *Malfunction Indicator Lamp* on page 3-42 for more information.

Driver Information Center (DIC)

Your vehicle may have a Driver Information Center (DIC).

All messages will appear in the DIC display located in the instrument panel cluster, below the speedometer. The DIC buttons are located on the center of the instrument panel, below the center outlets.

The DIC comes on when the ignition is on. After a short delay, the uplevel DIC will display the WELCOME DRIVER (1 or 2) if a personalized key 1 or 2 is used, and then the information that was last displayed before the engine was turned off.

The base level DIC displays the odometer and trip odometers only.

The uplevel DIC displays the odometer, trip odometers, fuel economy, trip computer, vehicle system, and compass display information. It also displays warning messages if a system problem is detected. In addition, the uplevel DIC displays phone numbers that are called using the OnStar[®] system, if equipped. See *OnStar[®] System* on page 2-43.

The outside air temperature automatically appears in the bottom right corner of the uplevel DIC display when viewing the trip/odometer screens, fuel screens and some of the gages screens. If the outside air temperature is at or below 37°F (3°C), the temperature reading will toggle between displaying the outside temperature and the word ICE for two minutes. If there is a problem with the system that controls the temperature display, the letters OC (open circuit) or SC (short circuit) will appear on the display. If this occurs, have the vehicle serviced by your dealer/retailer.

The uplevel DIC also allows some features to be customized or personalized. See *DIC Vehicle Personalization* on page 3-76 for more information.

DIC Operation and Displays

The DIC has different modes which can be accessed by pressing the DIC buttons located on the center of the instrument panel. Depending on whether your vehicle has the base level or uplevel DIC, the buttons and modes available will differ.

The base level buttons are the trip/odometer and English/Metric buttons.

The uplevel buttons are the trip/odometer, fuel, gages, set/reset, and option buttons.

The button functions are detailed in the following pages.

DIC Buttons

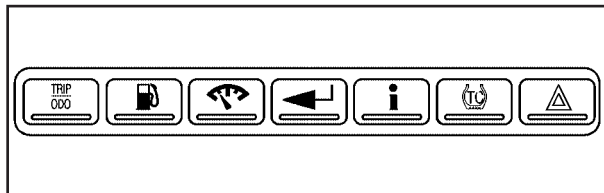

Uplevel shown

TRIP/ODO (Trip/Odometer): For vehicles with the base level DIC, press this button to display the odometer and trip distance.

For vehicles with the uplevel DIC, press this button to display the odometer, trip distance, time elapsed, and average speed.

E/M (English/Metric):** For vehicles with the base level DIC, press this button to select between English or Metric units.

For vehicles with the uplevel DIC, to select between English or Metric units, see “Units” later in this section.

F (Fuel)*: Press this button to display the fuel range and average fuel economy.

 **(Gages)*:** Press this button to display the battery voltage, oil life, and tire pressure readings.

 **(Set/Reset)*:** Press this button to set or reset certain functions and to turn off or acknowledge messages on the DIC.

i (Option)*: Press this button to display the units, language, personalization, compass zone, and compass calibration. See *DIC Vehicle Personalization on page 3-76* and *DIC Compass (Uplevel Only) on page 3-56* for more information.

 **(Traction Control):** Press this button to turn traction control on or off. See *Traction Control System (TCS) on page 4-6* for more information.

Press and hold this button to turn StabiliTrak[®] off, for vehicles with this feature. Press this button again to turn both traction control and StabiliTrak[®] on. See *StabiliTrak[®] System on page 4-8* for more information.

 **(Hazard):** Press this button to turn the hazard warning flashers on and off. See *Hazard Warning Flashers on page 3-6* for more information.

*These buttons are only available on vehicles with the uplevel DIC.

**This button is only available on vehicles with the base level DIC.

Trip/Odometer Menu Items

TRIP/ODO (Trip Odometer): Press this button to scroll through the following menu items:

Odometer

Press the trip/odometer button until the odometer displays. This mode shows the distance the vehicle has been driven in either miles or kilometers.

Trip A and Trip B

Press the trip/odometer button until A or B displays. This mode shows the current distance traveled in either miles or kilometers since the last reset for each trip odometer. Both trip odometers can be used at the same time.

The display will show the odometer on the top line and the trip odometer information, either A or B, on the bottom line.

Each trip odometer can be reset to zero separately by briefly pressing the set/reset button on vehicles with the uplevel DIC or by briefly pressing and holding the trip odometer button on vehicles with the base level DIC while the desired trip odometer is displayed.

There is also a retroactive trip odometer function that performs the following for each trip odometer:

- If the vehicle's speed has exceeded 3 mph (5 km/h) during the current ignition cycle, this function will set the trip odometer to the distance driven during the current ignition cycle.
- If the vehicle's speed has not exceeded 3 mph (5 km/h), this function will set the trip odometer to the distance driven during the previous ignition cycle plus the distance driven during the current ignition cycle.

Press and hold the set/reset button on vehicles with the uplevel DIC or the trip/odometer button on vehicles with the base level DIC for three seconds, then release the button. The retroactive trip odometer value will be set into the currently displayed trip odometer.

Time Elapsed (Uplevel Only)

Press the trip/odometer button until TIME ELAPSED :00 displays. This mode is like a stopwatch, in that you can clock the time it takes to get from one point to another. Each of the fields for the hours, minutes, and seconds are two numeric digits.

Once TIME ELAPSED :00 is displayed, press the set/reset button on vehicles with the uplevel DIC to start the timing feature. Press the set/reset button again to stop it. If you will be starting and stopping your vehicle, during a trip for instance, the TIME ELAPSED feature will automatically start timing where it left off when you last stopped. To reset it, press and hold the set/reset button for about 1.5 seconds. The display will return to zero. Press the trip/odometer button to exit from the TIME ELAPSED display.

Average Speed (Uplevel Only)

Press the trip/odometer button until AVERAGE SPEED displays. This mode shows the average speed of the vehicle in miles per hour (mph) or kilometers per hour (km/h). This average is calculated based on the various vehicle speed recorded since the last reset of this value. To reset the value, press the trip/odometer button to display AVERAGE SPEED, then press and hold the set/reset button on vehicles with the uplevel DIC. The display will return to zero.

Fuel Menu Items (Uplevel Only)

 **(Fuel):** Press this button to scroll through the following menu items:

Fuel Range

Press the fuel button until FUEL RANGE displays. This mode shows the approximate number of remaining miles or kilometers the vehicle can be driven without refueling.

Fuel range is based on several factors, including distance traveled, fuel used, fuel capacity, etc. This estimate will change if driving conditions change. For example, if driving in traffic and making frequent stops, this mode may read one number, but if the vehicle is driven on a freeway, the number may change even though the same amount of fuel is in the fuel tank. This is because different driving conditions produce different fuel economies. Generally, freeway driving produces better fuel economy than city driving. Fuel range cannot be reset.

If your vehicle is low on fuel, FUEL RANGE LOW will display followed by the LOW FUEL message. See “LOW FUEL” under *DIC Warnings and Messages on page 3-58* for more information.

Average Fuel Economy

Press the fuel button until AVG ECONOMY displays. This mode shows the approximate average miles per gallon (mpg) or liters per 100 kilometers (L/100 km). This number is calculated based on the number of mpg (L/100 km) recorded since the last time this menu item was reset. To reset AVG ECONOMY, press and hold the set/reset button. The display will return to zero.

Gages Menu Items (Uplevel Only)

 **(Gages):** Press this button to scroll through the following menu items:

Battery

Press the gages button until BATTERY displays. This mode shows the current battery voltage.

Your vehicle's charging system regulates voltage based on the state of the battery. The battery voltage may fluctuate when viewing this information on the DIC. This is normal.

If there is a problem with the battery charging system, a DIC message will display. See *DIC Warnings and Messages on page 3-58* for more information.

See *Electric Power Management on page 3-18* for more information.

Oil Life

Press the gages button until OIL LIFE displays. This mode shows an estimate of the oil's remaining useful life. If you see OIL LIFE 99% on the display, that means 99% of the current oil life remains. The engine oil life system will alert you to change your oil on a schedule consistent with your driving conditions.

When the remaining oil life is low, the CHANGE OIL SOON message will appear on the display. You should change your oil as soon as possible. See *Engine Oil on page 5-18*. In addition to the engine oil life system monitoring the oil life, additional maintenance is recommended in the Maintenance Schedule in this manual. See *Scheduled Maintenance on page 6-4* for more information.

Remember, you must reset the OIL LIFE yourself after each oil change. It will not reset itself. Also, be careful not to reset the OIL LIFE accidentally at any time other than when the oil has just been changed. It cannot be reset accurately until the next oil change. To reset the engine oil life system, see *Engine Oil Life System on page 5-21*. The display will show 100% when the system is reset.

Tire Pressure

Press the gages button until FRONT TIRE PRESSURE displays. This mode shows the pressure for the front tires. To view the pressure for the rear tires, press the gages button again until REAR TIRE PRESSURE displays. The tire pressure will be shown in either pounds per square inch (psi) or kilopascals (kPa).

If a low tire pressure condition is detected by the system while driving, a message advising you to check the pressure in a specific tire will appear in the display. See *Inflation - Tire Pressure on page 5-70* and *DIC Warnings and Messages on page 3-58* for more information.

If the tire pressure display shows dashes or blanks instead of a value, there may be a problem with your vehicle. If this consistently occurs, see your dealer/retailer for service.

Option Menu Items (Uplevel Only)

i (Option): Press this button to scroll through the following menu items:

Units

Press the option button until UNITS displays. This mode allows you to select between English or Metric units of measurement. Once in this mode, press the set/reset button to select between ENGLISH or METRIC units.

Language

Press the option button until the language screen displays. This mode allows you to select the language in which the DIC messages will appear. Once in this mode, press the set/reset button to select among the following choices:

- English
- Francais (French)
- Espanol (Spanish)

Personalization

Press the option button until PERSONAL PROGRAM displays. Your vehicle may have personalization capabilities that allow you to program certain features to a preferred setting for up to two drivers.

Your vehicle may also have customization capabilities that allow you to program certain features to one preferred setting. Customization features can only be programmed to one setting on the vehicle and cannot be programmed to a preferred setting for up to two drivers. See *DIC Vehicle Personalization on page 3-76* for additional information on personal programming.

Compass Zone

To change the compass zone through the DIC, see *DIC Compass (Uplevel Only) on page 3-56*.

Compass Calibration

The compass can be manually calibrated. To calibrate the compass through the DIC, see *DIC Compass (Uplevel Only) on page 3-56*.

DIC Compass (Uplevel Only)

Your vehicle may have a compass in the Driver Information Center (DIC).

Compass Zone

The zone is set to zone eight upon leaving the factory. Your dealer/retailer will set the correct zone for your location.

Under certain circumstances, such as during a long distance cross-country trip or moving to a new state or province, it will be necessary to compensate for compass variance by resetting the zone through the DIC if the zone is not set correctly.

Compass variance is the difference between the earth's magnetic north and true geographic north. If the compass is not set to the zone where you live, the compass may give false readings. The compass must be set to the variance zone in which the vehicle is traveling.

To adjust for compass variance, use the following procedure:

Compass Variance (Zone) Procedure

1. Do not set the compass zone when the vehicle is moving. Only set it when the vehicle is in PARK (P).
Press the option button until COMPASS ZONE displays.

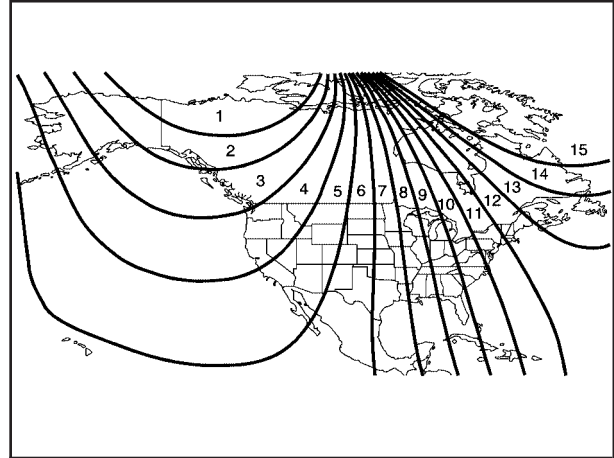

2. Find the vehicle's current location and variance zone number on the map.
Zones 1 through 15 are available.

3. Press the set/reset button to scroll through and select the appropriate variance zone.
4. Press the trip or fuel button until the vehicle heading, for example, N for North, is displayed in the DIC.
5. If calibration is necessary, calibrate the compass. See "Compass Calibration Procedure" following.

Compass Calibration

The compass can be manually calibrated. Only calibrate the compass in a magnetically clean and safe location, such as an open parking lot, where driving the vehicle in circles is not a danger. It is suggested to calibrate away from tall buildings, utility wires, manhole covers, or other industrial structures, if possible.

If CAL should ever appear in the DIC display, the compass should be calibrated.

If the DIC display does not show a heading, for example, N for North, or the heading does not change after making turns, there may be a strong magnetic field interfering with the compass. Such interference may be caused by a magnetic CB or cell phone antenna mount, a magnetic emergency light, magnetic note pad holder, or any other magnetic item. Turn off the vehicle, move the magnetic item, then turn on the vehicle and calibrate the compass.

To calibrate the compass, use the following procedure:

Compass Calibration Procedure

1. Before calibrating the compass, make sure the compass zone is set to the variance zone in which the vehicle is located. See "Compass Variance (Zone) Procedure" earlier in this section. Do not operate any switches such as window, sunroof, climate controls, seats, etc. during the calibration procedure.
2. Press the option button until COMPASS CALIBRATION displays.
3. Press the set/reset button to start the compass calibration.
4. The DIC will display CALIBRATION BEGUN DRIVE IN CIRCLES. Drive the vehicle in tight circles at less than 5 mph (8 km/h) to complete the calibration. The DIC will display CALIBRATION FINISHED for a few seconds when the calibration is complete. The DIC display will then return to COMPASS CALIBRATION.

DIC Warnings and Messages

Messages are displayed on the uplevel DIC to notify the driver that the status of the vehicle has changed and that some action may be needed by the driver to correct the condition. Multiple messages may appear one after another.

Some messages may not require immediate action, but you can press any of the uplevel DIC buttons to acknowledge that you received the message and clear it from the DIC display.

Some messages cannot be cleared from the DIC display because they are more urgent. These messages require action before they can be cleared.

If there are any active warning messages when the vehicle is turned off, two chimes sound and the DIC goes into a reminder mode. The reminder mode displays any active message. If there are multiple messages, the DIC displays each message for five seconds. After each active message is displayed once, the reminder mode turns off.

You should take any messages that appear on the display seriously and remember that clearing the messages will only make the messages disappear, not correct the problem.

The following are the possible messages that can be displayed and some information about them.

A/C OFF FOR ENGINE PROTECTION

This message displays when the engine coolant becomes hotter than the normal operating temperature. See *Engine Coolant Temperature Gage on page 3-40*. To avoid added strain on a hot engine, the air conditioning compressor is automatically turned off. When the coolant temperature returns to normal, the air conditioning compressor turns back on. You can continue to drive your vehicle.

This message comes on while the ignition is in ON/RUN. Press any of the DIC buttons to acknowledge this warning message and to clear it from the screen.

This message continues to display for two seconds if it has not been acknowledged when the engine is turned off. It also re-displays for two seconds if the message has been acknowledged, but the condition still exists when the engine is turned off.

If the condition still exists, the message re-appears when the engine is turned on. If this message continues to appear, have the system repaired by your dealer/retailer as soon as possible to avoid damage to the engine.

BATTERY SAVER ACTIVE

This message displays when the system detects that the battery voltage is dropping beyond a reasonable level. The battery saver system starts reducing certain features of the vehicle that you may be able to notice. At the point that the features are disabled, this message is displayed. It means that the vehicle is trying to save the charge in the battery.

Turn off all unnecessary accessories to allow the battery to recharge.

The normal battery voltage range is 11.5 to 15.5 volts. If your vehicle has an uplevel DIC, you can monitor the battery voltage by pressing the gages button until BATTERY displays.

CHANGE OIL SOON

This message displays when service is required for the vehicle. See your dealer/retailer. See *Engine Oil on page 5-18* and *Scheduled Maintenance on page 6-4* for more information.

The CHANGE OIL SOON message is reset by acknowledging the message. The OIL LIFE screen under the gages menu on the DIC must also be reset. See “Oil Life” under *DIC Operation and Displays on page 3-50* and *Engine Oil Life System on page 5-21*.

This message displays while the ignition is in ON/RUN. Press any of the DIC buttons to acknowledge this message and to clear it from the screen.

This message continues to display for two seconds if it has not been acknowledged when the engine is turned off. It also re-displays for two seconds if the message has been acknowledged, but the condition still exists when the engine is turned off.

If the condition still exists, the message re-appears when the engine is turned on.

CHARGING SYSTEM FAILURE

This message displays when there is a problem with the generator and battery charging systems. Driving with this problem could drain the battery. Turn off all unnecessary accessories. Stop and turn off the vehicle as soon as it is safe to do so. Have the electrical system checked by your dealer/retailer immediately.

This message displays and a chime sounds while the ignition is in ON/RUN. Press any of the DIC buttons to acknowledge this message and to clear it from the screen.

This message continues to display for two seconds if it has not been acknowledged when the engine is turned off. It also re-displays for two seconds if the message has been acknowledged, but the condition still exists when the engine is turned off.

If the condition still exists, the message re-appears when the engine is turned on.

CHECK GAS CAP

This message may display if the fuel cap is not on, or is not fully tightened. The check gas cap light also appears on the instrument panel cluster. See *Check Gas Cap Light on page 3-49*. Check the fuel cap to ensure that it is on properly. The diagnostic system can determine if the fuel cap has been left off or improperly installed. A loose or missing fuel cap allows fuel to evaporate into the atmosphere. A few driving trips with the cap properly installed should turn this message off. See *Filling the Tank on page 5-8* for more information.

This message displays while the ignition is in ON/RUN. Press any of the DIC buttons to acknowledge this message and to clear it from the screen.

This message continues to display for two seconds if it has not been acknowledged when the engine is turned off. It also re-displays for two seconds if the message has been acknowledged, but the condition still exists when the engine is turned off.

If the condition still exists, the message re-appears when the engine is turned on.

CHECK TIRE PRESSURE

This message displays when the pressure in one or more of the vehicle's tires needs to be checked. This message also displays LEFT FRONT, RIGHT FRONT, LEFT REAR, or RIGHT REAR to indicate which tire needs to be checked. You can receive more than one tire pressure message at a time. To read the other messages that may have been sent at the same time, press the set/reset button. If a tire pressure message appears on the DIC, stop as soon as you can. Have the tire pressures checked and set to those shown on the Tire Loading Information label. See *Tires on page 5-63*, *Loading Your Vehicle on page 4-21*, and *Inflation - Tire Pressure on page 5-70*. The DIC also shows the tire pressure values. See *DIC Operation and Displays on page 3-50*. If the tire pressure is low, the low tire pressure warning light comes on. See *Tire Pressure Light on page 3-41*.

This message displays while the ignition is in ON/RUN. Press any of the DIC buttons to acknowledge this message and to clear it from the screen.

This message continues to display for two seconds if it has not been acknowledged when the engine is turned off. It also re-displays for two seconds if the message has been acknowledged, but the condition still exists when the engine is turned off.

If the condition still exists, the message re-appears when the engine is turned on.

DELAYED LOCKING

This message displays to inform the driver that even though a door lock switch or the lock button on the Remote Keyless Entry (RKE) transmitter has been pressed, that actual locking of the doors is being delayed because the delayed locking feature has been activated in the DIC. See “DELAYED LOCKING” under *DIC Vehicle Personalization on page 3-76* for more information.

This message appears and a chime sounds when the ignition is off.

This message cannot be acknowledged.

DRIVER’S DOOR AJAR

This message displays when the driver door is not closed properly. Make sure that the door is closed completely.

This message displays while the ignition is in ON/RUN. A chime sounds when the gear position is shifted out of PARK (P). Press any of the DIC buttons to acknowledge this message and to clear it from the screen.

This message continues to display for two seconds if it has not been acknowledged when the engine is turned off. It also re-displays for two seconds if the message has been acknowledged, but the condition still exists when the engine is turned off.

If the condition still exists, the message re-appears when the engine is turned on.

DRIVER'S REAR DOOR AJAR

This message displays when the driver side rear door is not closed properly. Make sure that the door is closed completely.

This message displays while the ignition is in ON/RUN. A chime sounds when the gear position is shifted out of PARK (P). Press any of the DIC buttons to acknowledge this message and to clear it from the screen.

This message continues to display for two seconds if it has not been acknowledged when the engine is turned off. It also re-displays for two seconds if the message has been acknowledged, but the condition still exists when the engine is turned off.

If the condition still exists, the message re-appears when the engine is turned on.

ENGINE COOLANT HOT

Notice: If you drive your vehicle while the engine is overheating, severe engine damage may occur. If an overheat warning appears on the instrument panel cluster and/or DIC, stop the vehicle as soon as possible. Do not increase the engine speed above normal idling speed. See *Engine Overheating on page 5-30* for more information.

This message displays when the engine coolant temperature is too hot. The engine coolant temperature warning light also appears on the instrument panel cluster. See *Engine Coolant Temperature Warning Light on page 3-40* and *Engine Coolant Temperature Gage on page 3-40* for more information.

To avoid added strain on the engine, turn off the air conditioner if it is on. When the coolant temperature returns to normal, the air conditioner can be turned back on.

This message displays only when the ignition is in ON/RUN. A chime sounds continuously when this message is displayed. Press any of the DIC buttons to acknowledge this message and to clear it from the screen.

This message continues to display for two seconds if it has not been acknowledged when the engine is turned off. It also re-displays for two seconds if the message has been acknowledged, but the condition still exists when the engine is turned off.

If the condition still exists, the message re-appears when the engine is turned on.

HEADLAMPS SUGGESTED

This message displays when the amount of available light outside of the vehicle is low, or the windshield wipers have been on for about 30 seconds, and the exterior lamps control is off or in the parking lamps position. This message informs the driver that turning on the exterior lamps is recommended. See *Exterior Lamps on page 3-13* for more information.

This message displays while the ignition is in ON/RUN. Press any of the DIC buttons to acknowledge this message and to clear it from the screen.

This message continues to display for two seconds if it has not been acknowledged when the engine is turned off. It also re-displays for two seconds if the message has been acknowledged, but the condition still exists when the engine is turned off.

If the condition still exists, the message re-appears when the engine is turned on.

HOOD AJAR

If your vehicle has the remote start feature, this message displays when the hood is not closed properly. Make sure that the hood is closed completely. See *Hood Release on page 5-11*.

This message displays while the ignition is in ON/RUN. Press any of the DIC buttons to acknowledge this message and to clear it from the screen.

This message continues to display for two seconds if it has not been acknowledged when the engine is turned off. It also re-displays for two seconds if the message has been acknowledged, but the condition still exists when the engine is turned off.

If the condition still exists, the message re-appears when the engine is turned on.

HOT TRANS (Transmission) FLUID

This message displays when the transmission fluid in your vehicle is too hot. Stop the vehicle and allow it to idle until it cools down. If the warning message continues to display, have the vehicle serviced by your dealer/retailer as soon as possible.

This message displays and a chime sounds only while the ignition is in ON/RUN. Press any of the DIC buttons to acknowledge this message and to clear it from the screen.

This message continues to display for two seconds if it has not been acknowledged when the engine is turned off. It also re-displays for two seconds if the message has been acknowledged, but the condition still exists when the engine is turned off.

If the condition still exists, the message re-appears when the engine is turned on.

KEY FOB BATTERY LOW

This message displays when the battery in the Remote Keyless Entry (RKE) transmitter needs to be replaced. To replace the battery, see “Battery Replacement” under *Remote Keyless Entry (RKE) System Operation on page 2-5*.

This message displays while the ignition is in ON/RUN. Press any of the DIC buttons to acknowledge this message and to clear it from the screen.

This message continues to display for two seconds if it has not been acknowledged when the engine is turned off. It also re-displays for two seconds if the message has been acknowledged, but the condition still exists when the engine is turned off.

If the condition still exists, the message re-appears when the engine is turned on.

KEY IN IGNITION

This message displays and a chime sounds continuously when the driver's door is open and the key is in ACC/ACCESSORY or LOCK/OFF.

This message cannot be acknowledged.

This message disappears and the chiming stops when the key is removed from the ignition.

LEFT FRONT TURN LAMP OUT

This message displays when the left front turn signal bulb needs to be replaced.

This message displays while the ignition is in ON/RUN. Press any of the DIC buttons to acknowledge this message and to clear it from the screen.

This message continues to display for two seconds if it has not been acknowledged when the engine is turned off. It also re-displays for two seconds if the message has been acknowledged, but the condition still exists when the engine is turned off.

If the condition still exists, the message re-appears when the engine is turned on.

LEFT REAR TURN LAMP OUT

This message displays when the left rear turn signal bulb needs to be replaced. See *Taillamps, Turn Signal, Sidemarker, Stoplamps and Back-up Lamps on page 5-59*.

This message displays while the ignition is in ON/RUN. Press any of the DIC buttons to acknowledge this message and to clear it from the screen.

This message continues to display for two seconds if it has not been acknowledged when the engine is turned off. It also re-displays for two seconds if the message has been acknowledged, but the condition still exists when the engine is turned off.

If the condition still exists, the message re-appears when the engine is turned on.

LOW BRAKE FLUID

This message displays when the brake fluid level is low. Have the brake system serviced by your dealer/retailer as soon as possible. See *Brakes on page 5-46* for proper fluid level.

The brake system warning light also appears on the instrument panel cluster when this message appears on the DIC. See *Brake System Warning Light on page 3-37*.

This message displays and a chime sounds only while the ignition is in ON/RUN. Press any of the DIC buttons to acknowledge this message and to clear it from the screen.

This message continues to display for two seconds if it has not been acknowledged when the engine is turned off. It also re-displays for two seconds if the message has been acknowledged, but the condition still exists when the engine is turned off.

If the condition still exists, the message re-appears when the engine is turned on.

LOW FUEL

This message displays when your vehicle is low on fuel. Refill the fuel tank as soon as possible. See *Fuel Gage on page 3-48* and *Filling the Tank on page 5-8* for more information.

The message displays and a chime sounds while the ignition is in ON/RUN. Press any of the DIC buttons to acknowledge this message and to clear it from the screen.

If the condition still exists, the message re-appears when the engine is turned on.

LOW OIL PRESSURE

Notice: If the **LOW OIL PRESSURE** warning message appears on the DIC display, stop the vehicle immediately. Do not drive the vehicle until the cause of the low oil pressure is corrected. Severe engine damage can result from driving a vehicle with low oil pressure. See *Engine Oil* on page 5-18 for more information.

This message displays when the vehicle's engine oil pressure is low. The oil pressure light also appears on the instrument panel cluster. See *Oil Pressure Light* on page 3-45.

Stop the vehicle immediately, as engine damage can result from driving a vehicle with low oil pressure. Have the vehicle serviced by your dealer/retailer as soon as possible when this message is displayed.

This message displays only when the ignition is in ON/RUN. A chime sounds continuously when this message is displayed.

This message cannot be acknowledged and cleared from the screen. This message re-displays for a few seconds if the condition still exists when the engine is turned off.

If the condition still exists, the message re-appears when the engine is turned on.

LOW WASHER FLUID

This message displays when the windshield washer fluid is low. Fill the windshield washer reservoir as soon as possible. See *Engine Compartment Overview* on page 5-12 for the location of the windshield washer reservoir. Also, see *Windshield Washer Fluid* on page 5-44 for more information.

This message displays and a chime sounds only when the ignition is in ON/RUN. Press any of the DIC buttons to acknowledge this message and to clear it from the screen.

This message continues to display for two seconds if it has not been acknowledged when the engine is turned off. It also re-displays for two seconds if the message has been acknowledged, but the condition still exists when the engine is turned off.

If the condition still exists, the message re-appears when the engine is turned on.

PARKING BRAKE ON

This message displays to alert the driver when the vehicle's parking brake is on, the ignition is in ON/RUN, and the vehicle speed is greater than 5 mph (8 km/h). Release the parking brake before driving. See *Parking Brake* on page 2-32 for more information.

The brake system warning light also appears on the instrument panel cluster when this message appears on the DIC. See *Brake System Warning Light* on page 3-37.

A chime sounds continuously while this message is displayed if driving above 5 mph (8 km/h). Press any of the DIC buttons to acknowledge this message and to clear it from the screen.

This message continues to display for two seconds if it has not been acknowledged when the engine is turned off. It also re-displays for two seconds if the message has been acknowledged, but the condition still exists when the engine is turned off.

If the condition still exists, the message re-appears when the engine is turned on.

PARK LAMPS ON

This message displays to alert the driver when the headlamps or parking lamps are on while the ignition is off and the driver's door is opened. See *Exterior Lamps* on page 3-13 for more information. A chime sounds continuously while this message is displayed.

Press any of the DIC buttons to acknowledge this message and to clear it from the screen.

PASSENGER'S DOOR AJAR

This message displays when the front passenger door is not closed properly. Make sure that the door is closed completely.

This message displays while the ignition is in ON/RUN. A chime sounds when the gear position is shifted out of PARK (P). Press any of the DIC buttons to acknowledge this message and to clear it from the screen.

This message continues to display for two seconds if it has not been acknowledged when the engine is turned off. It also re-displays for two seconds if the message has been acknowledged, but the condition still exists when the engine is turned off.

If the condition still exists, the message re-appears when the engine is turned on.

PASSENGER'S REAR DOOR AJAR

This message displays when the passenger side rear door is not closed properly. Make sure that the door is closed completely.

This message displays while the ignition is in ON/RUN. A chime sounds when the gear position is shifted out of PARK (P). Press any of the DIC buttons to acknowledge this message and to clear it from the screen.

This message continues to display for two seconds if it has not been acknowledged when the engine is turned off. It also re-displays for two seconds if the message has been acknowledged, but the condition still exists when the engine is turned off.

If the condition still exists, the message re-appears when the engine is turned on.

REDUCED ENGINE POWER

This message displays when the vehicle's engine power is reduced. Reduced engine power can affect the vehicle's ability to accelerate. If this message is on, but there is no reduction in performance, proceed to your destination. The performance may be reduced the next time the vehicle is driven. The vehicle may be driven at a reduced speed while this message is on, but acceleration and speed may be reduced. Anytime this message stays on, the vehicle should be taken to your dealer/retailer for service as soon as possible.

This message displays and a chime sounds only when the ignition is in ON/RUN. Press any of the DIC buttons to acknowledge this message and to clear it from the screen.

This message continues to display for two seconds if it has not been acknowledged when the engine is turned off. It also re-displays for two seconds if the message has been acknowledged, but the condition still exists when the engine is turned off.

If the condition still exists, the message re-appears when the engine is turned on.

REDUCED POWER STOP WHEN SAFE

This message displays when your vehicle is in an overheated engine operating mode. This operating mode allows your vehicle to be driven to a safe place in an emergency. In this mode, you will notice a significant loss in power and engine performance. See *Overheated Engine Protection Operating Mode on page 5-32* for more information. Anytime this message is on, the vehicle should be taken to your dealer/retailer for service as soon as possible.

This message displays and a chime sounds only when the ignition is in ON/RUN. Press any of the DIC buttons to acknowledge this message and to clear it from the screen.

This message continues to display for two seconds if it has not been acknowledged when the engine is turned off. It also re-displays for two seconds if the message has been acknowledged, but the condition still exists when the engine is turned off.

If the condition still exists, the message re-appears when the engine is turned on.

REMOTE START DISABLED

If your vehicle has the remote start feature, this message displays if a remote start attempt is unsuccessful. This may be caused if any of the following conditions are true when a remote start attempt is made:

- The remote start system is disabled through the DIC.
- The key is in the ignition.
- The hood or the doors are not closed.
- There is an emission control system malfunction.
- The engine coolant temperature is too high.
- The oil pressure is low.

- The hazard warning flashers are turned on.
- The maximum number of remote starts or remote start attempts between ignition cycles has been reached.
- The content theft-deterrent alarm is on while attempting to remote start the vehicle.

See “REMOTE START” under *DIC Vehicle Personalization on page 3-76* and *Remote Vehicle Start on page 2-8* for more information.

RIGHT FRONT TURN LAMP OUT

This message displays when the right front turn signal bulb needs to be replaced.

This message displays while the ignition is in ON/RUN. Press any of the DIC buttons to acknowledge this message and to clear it from the screen.

This message continues to display for two seconds if it has not been acknowledged when the engine is turned off. It also re-displays for two seconds if the message has been acknowledged, but the condition still exists when the engine is turned off.

If the condition still exists, the message re-appears when the engine is turned on.

RIGHT REAR TURN LAMP OUT

This message displays when the right rear turn signal bulb needs to be replaced. See *Taillamps, Turn Signal, Sidemarker, Stoplamps and Back-up Lamps on page 5-59*.

This message displays while the ignition is in ON/RUN. Press any of the DIC buttons to acknowledge this message and to clear it from the screen.

This message continues to display for two seconds if it has not been acknowledged when the engine is turned off. It also re-displays for two seconds if the message has been acknowledged, but the condition still exists when the engine is turned off.

If the condition still exists, the message re-appears when the engine is turned on.

SERVICE ABS SYSTEM

This message displays when the Antilock Brake System (ABS) is not functioning properly. Have the brake system serviced by your dealer/retailer as soon as possible.

The antilock brake system warning light also appears on the instrument panel cluster when this message appears on the DIC. See *Antilock Brake System Warning Light on page 3-38*.

This message only displays while the ignition is in ON/RUN. Press any of the DIC buttons to acknowledge this message and to clear it from the screen.

This message continues to display for two seconds if it has not been acknowledged when the engine is turned off. It also re-displays for two seconds if the message has been acknowledged, but the condition still exists when the engine is turned off.

If the condition still exists, the message re-appears when the engine is turned on.

SERVICE BRAKE SYSTEM

This message displays when a problem with the brake system has been detected. Have your vehicle serviced by your dealer/retailer as soon as possible.

The brake system warning light also appears on the instrument panel cluster when this message appears on the DIC. See *Brake System Warning Light on page 3-37*.

This message only displays while the ignition is in ON/RUN. Press any of the DIC buttons to acknowledge this message and to clear it from the screen.

This message continues to display for two seconds if it has not been acknowledged when the engine is turned off. It also re-displays for two seconds if the message has been acknowledged, but the condition still exists when the engine is turned off.

If the condition still exists, the message re-appears when the engine is turned on.

SERVICE PARK LAMPS

This message displays when there is a problem with the park lamps. Check to see if the park lamp fuse is blown and replace the fuse if necessary. See *Fuses and Circuit Breakers on page 5-109* and *Instrument Panel Fuse Block on page 5-110* for more information. If changing the fuse does not correct the problem, see your dealer/retailer.

This message only displays while the ignition is in ON/RUN. Press any of the DIC buttons to acknowledge this message and to clear it from the screen.

This message continues to display for two seconds if it has not been acknowledged when the engine is turned off. It also re-displays for two seconds if the message has been acknowledged, but the condition still exists when the engine is turned off.

If the condition still exists, the message re-appears when the engine is turned on.

SERVICE STABILITY SYSTEM

If your vehicle has StabiliTrak[®], this message displays if there has been a problem detected with StabiliTrak[®]. A warning light also appears on the instrument panel cluster. See *Traction Control System (TCS) Warning Light on page 3-38*. See *StabiliTrak[®] System on page 4-8* for more information.

If this message turns on while you are driving, pull off the road as soon as possible and stop carefully. Try resetting the system by turning the ignition off and then back on. If this message still stays on or turns back on again while you are driving, your vehicle needs service. Have the StabiliTrak[®] System inspected by your dealer/retailer as soon as possible.

This message displays only while the ignition is in ON/RUN. Press any of the DIC buttons to acknowledge this message and to clear it from the screen.

This message continues to display for two seconds if it has not been acknowledged when the engine is turned off. It also re-displays for two seconds if the message has been acknowledged, but the condition still exists when the engine is turned off.

If the condition still exists, the message re-appears when the engine is turned on.

SERVICE THEFT SYSTEM

This message displays when there is a problem with the theft-deterrent system programmed in the key. A fault has been detected in the system which means that the system is disabled and it is not protecting the vehicle. The vehicle usually restarts; however, you may want to take the vehicle to your dealer/retailer before turning off the engine. See *PASS-Key® III Operation on page 2-22* for more information.

This message displays and a chime sounds only while the ignition is in ON/RUN. Press any of the DIC buttons to acknowledge this message and to clear it from the screen.

This message continues to display for two seconds if it has not been acknowledged when the engine is turned off. It also re-displays for two seconds if the message has been acknowledged, but the condition still exists when the engine is turned off.

If the condition still exists, the message re-appears when the engine is turned on.

SERVICE TIRE MONITOR SYSTEM

This message displays if a part on the Tire Pressure Monitor System (TPMS) is not working properly. The tire pressure light also flashes and then remains on during the same ignition cycle. See *Tire Pressure Light on page 3-41*. Several conditions may cause this message to appear. See *Tire Pressure Monitor Operation on page 5-73* for more information. If the warning comes on and stays on, there may be a problem with the TPMS. See your dealer/retailer.

This message displays while the ignition is in ON/RUN. Press any of the DIC buttons to acknowledge this message and to clear it from the screen.

This message continues to display for two seconds if it has not been acknowledged when the engine is turned off. It also re-displays for two seconds if the message has been acknowledged, but the condition still exists when the engine is turned off.

If the condition still exists, the message re-appears when the engine is turned on.

SERVICE TRACTION SYSTEM

This message displays when the traction system is not functioning properly. A warning light also appears on the instrument panel cluster. See *Traction Control System (TCS) Warning Light* on page 3-38. See *Traction Control System (TCS)* on page 4-6 or *Enhanced Traction System (ETS)* on page 4-7 for more information. Have the system serviced by your dealer/retailer as soon as possible.

This message displays only while the ignition is in ON/RUN. Press any of the DIC buttons to acknowledge this message and to clear it from the screen.

This message continues to display for two seconds if it has not been acknowledged when the engine is turned off. It also re-displays for two seconds if the message has been acknowledged, but the condition still exists when the engine is turned off.

If the condition still exists, the message re-appears when the engine is turned on.

SERVICE VARIABLE EFFORT STEERING

If your vehicle has variable effort steering, this message displays when if this system is not functioning properly. See *Steering* on page 4-9 for more information. Have the system serviced by your dealer/retailer as soon as possible.

This message displays only while the ignition is in ON/RUN. Press any of the DIC buttons to acknowledge this message and to clear it from the screen.

This message continues to display for two seconds if it has not been acknowledged when the engine is turned off. It also re-displays for two seconds if the message has been acknowledged, but the condition still exists when the engine is turned off.

If the condition still exists, the message re-appears when the engine is turned on.

SERVICE VEHICLE SOON

This message displays when a non-emissions related malfunction occurs. Have the vehicle serviced by your dealer/retailer as soon as possible.

This message displays only while the ignition is in ON/RUN. Press any of the DIC buttons to acknowledge this message and to clear it from the screen.

This message continues to display for two seconds if it has not been acknowledged when the engine is turned off. It also re-displays for two seconds if the message has been acknowledged, but the condition still exists when the engine is turned off.

If the condition still exists, the message re-appears when the engine is turned on.

STABILITY CONTROL ACTIVE

If your vehicle has StabiliTrak[®], this message displays when StabiliTrak[®] is actively assisting you with directional control of the vehicle. Slippery road conditions may exist when this message is displayed, so adjust your driving accordingly. See *StabiliTrak[®] System on page 4-8*.

This message displays only while the ignition is in ON/RUN. This message stays on until road conditions change and StabiliTrak[®] is not active.

This message cannot be acknowledged and cleared from the screen.

STABILITY CONTROL OFF

If your vehicle has StabiliTrak[®], this message displays any time the system turns off. When this message has been displayed, StabiliTrak[®] is no longer available to assist you with directional control of the vehicle. Adjust your driving accordingly. See *StabiliTrak[®] System on page 4-8*.

This message displays only while the ignition is in ON/RUN.

Any of the following conditions may cause the StabiliTrak[®] system to turn off:

- The system is turned off by pressing and holding the traction control button for five seconds. See *StabiliTrak[®] System on page 4-8*.
- The battery is low.
- There is a StabiliTrak[®] system failure. See your dealer/retailer for service.

STARTING DISABLED

This message displays if the starting of the engine is disabled due to the electronic throttle control system or vehicle theft-deterrent system. Have your vehicle serviced by your dealer/retailer immediately.

This message only appears while the ignition is in ON/RUN and will not disappear until the problem is resolved.

This message cannot be acknowledged.

TRACTION CONTROL ACTIVE

This message displays when the traction system is on. Slippery road conditions may exist if this message is displayed, so adjust your driving accordingly. See *Traction Control System (TCS)* on page 4-6 or *Enhanced Traction System (ETS)* on page 4-7 for more information.

This message only displays while the ignition is in ON/RUN and will not disappear until driving conditions change and the system is no longer active.

This message cannot be acknowledged or cleared from the screen.

TRACTION CONTROL OFF

This message displays when the traction system turns off. See *Traction Control System (TCS)* on page 4-6 or *Enhanced Traction System (ETS)* on page 4-7 for more information.

This message only displays while the ignition is in ON/RUN and disappears after two seconds.

Any of the following conditions may cause the system to turn off:

- The system is turned off by pressing the traction control button located on the center of the instrument panel. See *Traction Control System (TCS)* on page 4-6 or *Enhanced Traction System (ETS)* on page 4-7.
- The battery is low.
- There is a system failure. See your dealer/retailer for service.

TRUNK AJAR

This message displays when the trunk is not closed completely. Make sure that the trunk is closed completely. See *Trunk on page 2-14*.

This message displays while the ignition is in ON/RUN. A chime sounds when the gear position is shifted out of PARK (P). Press any of the DIC buttons to acknowledge this message and to clear it from the screen.

This message continues to display for two seconds if it has not been acknowledged when the engine is turned off. It also re-displays for two seconds if the message has been acknowledged, but the condition still exists when the engine is turned off.

If the condition still exists, the message re-appears when the engine is turned on.

TURN SIGNAL ON

This message displays as a reminder to turn off the turn signal if you drive your vehicle for more than about 0.75 mile (1.2 km) with a turn signal on. See *Turn Signal/Multifunction Lever on page 3-7*.

This message displays and a chime sounds only when the ignition is in ON/RUN. This message clears from the DIC if the turn signal is manually turned off, a turn is completed, or the message is acknowledged.

DIC Vehicle Personalization

Your vehicle may have customization capabilities that allow you to program certain features to one preferred setting. Customization features can only be programmed to one setting on the vehicle and cannot be programmed to a preferred setting for two different drivers. The customization features include the following:

- Exterior lighting delay
- Interior lighting delay
- Delayed locking
- Content theft
- Remote keyless entry feedback
- Remote start

Your vehicle may also have personalization capabilities that allow you to program certain features to a preferred setting for up to two drivers. The first personalized key corresponds to driver 1 and the second personalized key corresponds to driver 2. The personalization features include the following:

- Radio station presets
- Auto door unlock preferences
- Remote keyless entry unlock preferences

All of the customization and personalization options may not be available on your vehicle. Only the options available will be displayed on the DIC.

The default settings for the customization and personalization features were set when your vehicle left the factory, but may have been changed from their default state since then.

The customization preferences are automatically recalled.

The driver's personalization preferences are recalled by using the key programmed for driver 1 or 2.

To change customization and personalization preferences, use the following procedure:

Entering the Personal Program Menu

1. Turn the ignition on and place the vehicle in PARK (P).

To avoid excessive drain on the battery, it is recommended that the headlamps are turned off.

2. Press the option button until PERSONAL PROGRAM displays.

If the vehicle is not in PARK (P), PERSONAL PROGRAM ONLY IN PARK will display.

If the vehicle is not able to enter the personal program menu, PERSONAL PROGRAM NOT AVAILABLE will display.

3. Press the set/reset button to begin.
4. The DIC will then display an instruction screen.

Press the option button to display the features that are available to program.

Press the set/reset button to change the setting of each feature.

Customization Menu Items

The following are customization features that allow you to program settings to the vehicle:

FACTORY DEFAULTS

This feature allows you to set all of the customization and personalization features back to their factory default settings.

Press the option button until FACTORY DEFAULTS appears on the DIC display. Press the set/reset button to scroll through the following settings:

NO (default): The customization and personalization features will not be set to their factory default settings.

YES: The customization and personalization features will be set to their factory default settings.

To select a setting and move on to the next feature, press the option button while the desired setting is displayed on the DIC.

ALL KEYS WILL BE RESET

This screen will only display if YES was selected on the FACTORY DEFAULTS screen.

Press the set/reset button to scroll through the following settings:

CANCEL (default): The features will not be set to their factory default settings and the DIC will return to the PERSONAL PROGRAM menu.

OK: The features will be set to their factory default settings, the DIC will exit the personal program menu, and PERSONAL OPTIONS SAVED will display.

EXT (Exterior) LIGHT DELAY

This feature allows you to set the amount of time the exterior lamps remain on after the key is removed from the ignition or the vehicle is unlocked using the Remote Keyless Entry (RKE) transmitter.

Press the option button until EXT LIGHT DELAY appears on the DIC display. Press the set/reset button to scroll through the following settings:

OFF: The exterior lamps will not turn on.

15 seconds: The exterior lamps will stay on for 15 seconds.

30 seconds (default): The exterior lamps will stay on for 30 seconds.

60 seconds: The exterior lamps will stay on for 60 seconds.

90 seconds: The exterior lamps will stay on for 90 seconds.

To select a setting and move on to the next feature, press the option button while the desired setting is displayed on the DIC.

INT (Interior) LIGHTS KEYS REMOVED

This feature enables the interior lamps in the vehicle to turn on for about 25 seconds after the key is removed from the ignition.

Press the option button until INT LIGHTS KEYS REMOVED appears on the DIC display. Press the set/reset button to scroll through the following settings:

OFF: Removing the key from the ignition will not cause the interior lamps to turn on.

ON (default): Removing the key from the ignition will cause the interior lamps to be turned on for about 25 seconds.

To select a setting and move on to the next feature, press the option button while the desired setting is displayed on the DIC.

DELAYED LOCKING

This feature allows the locking of the vehicle to be delayed until all of the doors have been closed for about five seconds.

When the delayed locking feature is enabled, it may be activated when the key is out of the ignition by doing one of the following:

- Pressing the driver's door power lock switch one time while the driver's door is open.
- Pressing the passenger's door power lock switch one time while the passenger's door is open.
- Pressing the lock button on the Remote Keyless Entry (RKE) transmitter one time while any door is open.

Two chimes will sound to signal that delayed locking is active.

The doors may be locked immediately by repeating one of the above actions more than one time.

If a door remains open, without any other door being opened or closed, the vehicle will lock after about 45 seconds.

If a key is in the ignition, this feature will not lock the doors. See *Delayed Locking on page 2-12* for more information.

Press the option button until DELAYED LOCKING appears on the DIC display. Press the set/reset button to scroll through the following settings:

OFF: There will be no delayed locking of the vehicle's doors.

ON (default): The locking of the vehicle's doors will be delayed by five seconds while a door is open after a power door lock switch is pressed, or the lock button on the RKE transmitter is pressed while a door is open.

To select a setting and move on to the next feature, press the option button while the desired setting is displayed on the DIC.

CONTENT THEFT

If your vehicle has the content theft-deterrent system, once this feature is turned on, the system will activate if someone tries to enter the vehicle without using the Remote Keyless Entry (RKE) transmitter or the correct key.

Press the option button until CONTENT THEFT appears on the DIC display. Press the set/reset button to scroll through the following settings:

OFF: The content theft-deterrent system will be turned off.

ON (default): The content theft-deterrent system will be turned on.

When ON is selected, the content theft-deterrent system will be armed when the vehicle is locked by pressing the lock button on the RKE transmitter or by pressing the power door lock switch. See *Content Theft-Deterrent on page 2-20* and *Power Door Locks on page 2-11* for more information.

To select a setting and move on to the next feature, press the option button while the desired setting is displayed on the DIC.

FOB LOCK FEEDBACK

This feature allows you to select the type of feedback you will receive when locking the vehicle with the Remote Keyless Entry (RKE) transmitter.

Press the option button until FOB LOCK FEEDBACK appears on the DIC display. Press the set/reset button to scroll through the following settings:

OFF: There will be no feedback when locking the vehicle.

LIGHTS: The exterior lamps will flash when you press the lock button on the RKE transmitter.

LIGHTS and HORN (default): The exterior lamps will flash when you press the lock button on the RKE transmitter, and the horn will sound when the lock button is pressed again within five seconds of the previous command.

To select a setting and move on to the next feature, press the option button while the desired setting is displayed on the DIC.

REMOTE START

If your vehicle has remote start, this feature allows the remote start to be turned off or on. The remote start feature allows you to start the engine from outside of the vehicle using the Remote Keyless Entry (RKE) transmitter. See *Remote Vehicle Start on page 2-8* for more information.

Press the option button until REMOTE START appears on the DIC display. Press the set/reset button to scroll through the following settings:

OFF: The remote start feature will be disabled.

ON (default): The remote start feature will be enabled.

To select a setting and move on to the next feature, press the option button while the desired setting is displayed on the DIC.

Personalization Menu Items

The following are personalization features that allow you to program setting for up to two drivers:

PERSONALIZE KEY

This feature allows you to personalize a key to be recognized as key 1 or 2. A personalized key allows you to program personalization features to a preferred setting to correspond to key 1 or 2. If you are using a key that has already been personalized, this screen will not display.

Press the option button until PERSONALIZE KEY appears on the DIC display. Press the set/reset button to scroll through the following settings:

NO (default): The key will not be personalized.

YES: The key will be personalized.

To select a setting and move on to the next feature, press the option button while the desired setting is displayed on the DIC.

REPLACE KEY

This screen displays only if YES was selected for the PERSONALIZE KEY feature, keys 1 and 2 have already been personalized, and the current key being used is not key 1 or 2. This feature allows you to program a key to be recognized as key 1 or 2 in the event that the previously programmed key needs to be replaced.

1: The key will be programmed to be recognized as key 1.

2: The key will be programmed to be recognized as key 2.

CANCEL (default): The key will not be programmed.

RADIO STATIONS PERSONALIZED

This screen displays only if YES was selected for the PERSONALIZE KEY feature. This feature allows you to set the radio station presets to be recognized for the key, 1 or 2, that is being used. You may notice a change to the radio after this message displays. After this message displays, any change to the presets will be recognized for key 1 or 2 and will be maintained by the radio.

AUTO DOOR UNLOCK

This feature allows automatic door unlocking to be turned off, used for the driver's door only, or for all of the doors.

Press the option button until AUTO DOOR UNLOCK appears on the DIC display. Press the set/reset button to scroll through the following settings:

OFF: None of the doors will unlock when the vehicle is shifted into PARK (P) or the key is taken out of the ignition.

DRIVER: Only the driver's door will unlock when the vehicle is shifted into PARK (P) or the key is taken out of the ignition.

ALL (default): All of the doors will unlock when the vehicle is shifted into PARK (P) or the key is taken out of the ignition.

To select a setting and move on to the next feature, press the option button while the desired setting is displayed on the DIC.

AUTO UNLOCK ON

This feature displays only if DRIVER or ALL was selected for the AUTO DOOR UNLOCK feature. This feature allows the selection of when the vehicle's doors will unlock.

Press the option button until AUTO UNLOCK ON appears on the DIC display. Press the set/reset button to scroll through the following settings:

KEY-OUT: The door(s) will unlock when the key is taken out of the ignition.

PARK (default): The door(s) will unlock when the vehicle is shifted into PARK (P).

To select a setting and move on to the next feature, press the option button while the desired setting is displayed on the DIC.

FOB UNLOCK ON 1ST PRESS

This feature allows the selection of which doors will unlock on the first press of the unlock button on the Remote Keyless Entry (RKE) transmitter. See *Remote Keyless Entry (RKE) System Operation on page 2-5* for more information.

Press the option button until FOB UNLOCK ON 1ST PRESS appears on the DIC display. Press the set/reset button to scroll through the following settings:

DRIVER (default): The driver's door will unlock on the first press of the unlock button on the RKE transmitter.

ALL: All of the doors will unlock on the first press of the unlock button on the RKE transmitter.

To select a setting, press the option button while the desired setting is displayed on the DIC. The DIC will then display PRESS UNLOCK SWITCH ON KEY FOB. Press the unlock button on the RKE transmitter and the setting will be saved for that RKE transmitter.

After programming the last option, the message PERSONAL OPTIONS SAVED appears on the DIC display for a few seconds, then the display returns to the PERSONAL PROGRAM main screen.

Exiting the Personal Program Menu

The personal program menu will be exited when any of the following occurs:

- The vehicle is shifted out of PARK (P).
- The vehicle is no longer in ON/RUN.
- The end of the personal program menu is reached.

Audio System(s)

Determine which radio your vehicle has and then read the pages following to familiarize yourself with its features.

CAUTION:

This system provides you with far greater access to audio stations and song listings. Giving extended attention to entertainment tasks while driving can cause a crash and you or others can be injured or killed. Always keep your eyes on the road and your mind on the drive — avoid engaging in extended searching while driving.

Keeping your mind on the drive is important for safe driving. See *Defensive Driving on page 4-2*. Here are some ways in which you can help avoid distraction while driving.

While your vehicle is parked:

- Familiarize yourself with all of its controls.
- Familiarize yourself with its operation.
- Set up your audio system by presetting your favorite radio stations, setting the tone, and adjusting the speakers. Then, when driving conditions permit, you can tune to your favorite radio stations using the presets and steering wheel controls if the vehicle has them.

Notice: Before adding any sound equipment to your vehicle, such as an audio system, CD player, CB radio, mobile telephone, or two-way radio, make sure that it can be added by checking with your dealer/retailer. Also, check federal rules covering mobile radio and telephone units. If sound equipment can be added, it is very important to do it properly. Added sound equipment may interfere with the operation of your vehicle's engine, radio, or other systems, and even damage them. Your vehicle's systems may interfere with the operation of sound equipment that has been added.

Notice: The chime signals related to safety belts, parking brake, and other functions of your vehicle operate through the radio/entertainment system. If that equipment is replaced or additional equipment is added to your vehicle, the chimes may not work. Make sure that replacement or additional equipment is compatible with your vehicle before installing it. See *Accessories and Modifications on page 5-3*.

Your vehicle may have a feature called Retained Accessory Power (RAP). With RAP, the audio system can be played even after the ignition is turned off. See *Retained Accessory Power (RAP) on page 2-25* for more information.

Setting the Clock

Press and hold H until the correct hour and AM or PM displays. Press and hold M until the correct minute displays. The time can be set with the ignition on or off.

Radio(s)

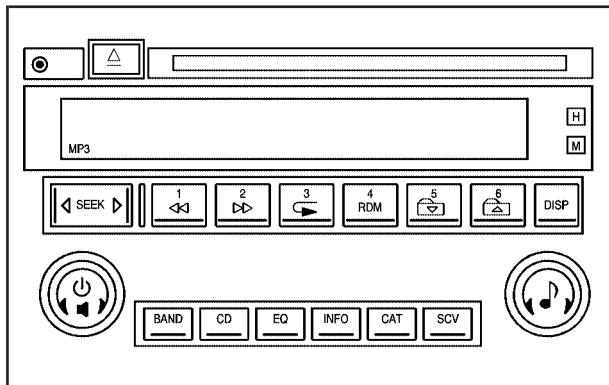

Radio with CD (MP3) shown, Radio with CD similar

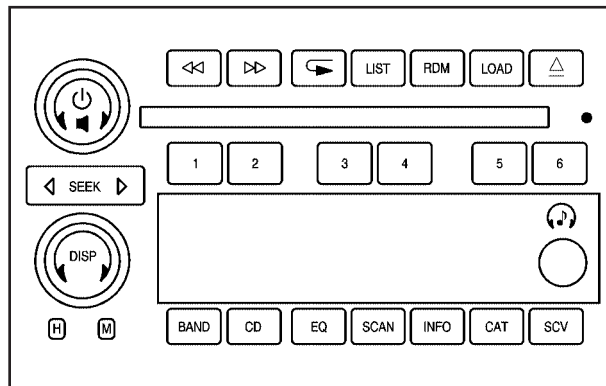

Radio with Six-Disc CD

Your vehicle has one of these radios as its audio system.

Playing the Radio

 **(Power):** Press to turn the system on and off.

 **(Volume):** Turn to increase or to decrease the volume.

DISP (Display): Press to switch the display between the radio station frequency and time of day. While the ignition is off, press this button to display the time.

If your vehicle's radio has XM™ (if equipped), press the DISP button while in XM™ mode to retrieve four different categories of information related to the current song or channel: Artist, Song Title, Category or PTY, Channel Number/Channel Name.

To change the default on the display, press the DISP button until the desired display appears, then hold this button for two seconds. The radio beeps once and the selected display becomes the default.



SCV (Speed Compensated Volume): If your vehicle's radio has Speed Compensated Volume (SCV), the audio system adjusts automatically to make up for road and wind noise while driving.

Set the volume at the desired level. Press this button to select LOW, MEDIUM, or HIGH. Depending on the radio, the selection may be SPEED VOL MIN (volume minimum), SPEED VOL MED (volume medium), or SPEED VOL MAX (volume maximum). Each higher setting allows for more volume compensation at faster vehicle speeds. Then while driving, SCV increases the volume, as necessary, to overcome noise at any speed. The volume level should always sound the same to you as you drive. NONE displays if the radio cannot determine the vehicle speed. To turn SCV off, press this button until OFF or SPEED VOL OFF displays.

Finding a Station

BAND: Press to switch between FM1, FM2, AM, or XM1™ or XM2™ (if equipped).

 **(Tune):** Turn to select radio stations.

 **SEEK**  : Press and release the arrows to go to the previous or the next station and stay there.

To scan stations, press and hold either arrow for more than two seconds. SCAN or SCN displays and the radio beeps once. The radio goes to a station, plays for a few seconds, and then goes to the next station. Press either arrow again or one of the pushbuttons to stop scanning presets.

To scan preset stations, press and hold either arrow for more than four seconds. PSCAN or PSC displays and the radio beeps twice. The radio goes to a preset station, plays for a few seconds, then goes to the next preset station. Press either arrow again or one of the pushbuttons to stop scanning presets.

The radio seeks and scans stations only with a strong signal that are in the selected band.

SCAN: Press until SC displays. The radio goes to a station, plays for a few seconds, and then goes to the next station. Press again to stop scanning stations.

The radio scans stations only with a strong signal that are in the selected band.

INFO (Information) (XM™ Satellite Radio Service

Only): Your vehicle's radio may have an INFO button. If the current station on the radio has a message, the information symbol displays. Press to see the message. If the entire message is not displayed, parts of the message appears every three seconds. To manually scroll through the message, press and release the INFO button.

When a message is not available from a station, NO INFO displays.

Setting Preset Stations

Up to 30 stations (six FM1, six FM2, six AM, six XM1™ and six XM2™ (if equipped)) can be programmed on the six numbered pushbuttons.

To program either radio:

1. Turn the radio on.
2. Press BAND to select FM1, FM2, AM, or XM1™ or XM2™ (if equipped).
3. Tune to the desired station.
4. Press EQ to select the equalization.
5. Press and hold one of the six numbered pushbuttons until the radio beeps once. When that numbered pushbutton is pressed again, the station and equalization that were stored, returns.
6. Repeat the steps for each pushbutton.

Setting the Tone (Bass/Treble)

 **(Bass/Treble):** Press and release until BASS or TREBLE displays. Turn this knob to increase or to decrease the bass or treble.

Press and hold to adjust the bass and treble to the middle position. The radio beeps once.

To adjust all tone and speaker controls to the middle position, press and hold when no tone or speaker control displays. ALL CENTERED displays and the radio beeps once.

EQ (Equalization): Press to select customized equalization settings.

To return the bass and treble to the manual mode, press and release until BASS or TREBLE displays.

Adjusting the Speakers (Balance/Fade)

 **(Balance/Fade):** To adjust the balance between the right and the left speakers, press and release until BAL (balance) displays. Turn this knob to move the sound toward the right or the left speakers.

To adjust the fade between the front and the rear speakers, press and release until FAD (fade) displays. Turn this knob to move the sound toward the front or the rear speakers.

To adjust the balance and the fade to the middle position, press, then press and hold until the radio beeps once.

To adjust all tone and speaker controls to the middle position, press and hold when no tone or speaker control displays. ALL CENTERED displays and the radio beeps once.

Finding a Category (CAT) Station (XM™ Satellite Radio Service Only)

To select and find a desired category, perform the following:

1. Press the CAT button to enter the category select mode. The current category displays.
2. Turn the  knob to select a category.
3. Once the desired category is displayed, press either SEEK arrow to go to the category's first station.
4. Press either SEEK arrow again to go to another station within that category. The category will display. If CAT times out and is no longer on the display, go back to Step 1.
5. Press CAT to exit the category select mode or wait for CAT to time out.

If the radio cannot find the desired category, NOT FOUND displays and the radio returns to the last station you were listening to.

Scanning Categories (CAT) (XM™ Satellite Radio Service Only)

To scan a desired category by doing the following:

1. Press the CAT button to enter the category select mode. The current category displays.
2. Turn the  knob to select a category.
3. Press either SEEK arrow for two seconds once the desired category is displayed, to scan the stations in that category.
4. Press either SEEK arrow again to stop scanning.

If the radio cannot find the desired category, NOT FOUND displays and the radio returns to the last station you were listening to.

Radio Messages

CALIBRATE: The audio system has been calibrated for your vehicle from the factory. If CALIBRATE displays, it means that the radio has not been configured properly for your vehicle and it must be returned to your dealer/retailer for service.

LOCKED: If LOCKED displays, it means the THEFTLOCK® system has locked up. Take your vehicle to your dealer/retailer for service.

If any error occurs repeatedly or if an error cannot be corrected, contact your dealer/retailer.

XM™ Satellite Radio Service

XM™ is a satellite radio service that is based in the 48 contiguous United States and 10 Canadian provinces. XM™ Satellite Radio has a wide variety of programming and commercial-free music, coast-to-coast, and in digital-quality sound. During your trial or when you subscribe, you will get unlimited access to XM™ Radio Online for when you are not in your vehicle. A service fee is required to receive the XM™ service. For more information, contact XM™ at www.xmradio.com or call 1-800-929-2100 in the U.S. and www.xmradio.ca or call 1-877-438-9677 in Canada.

Radio Messages for XM™ Only

See *XM Radio Messages on page 3-100* later in this section for further detail.

Playing a CD

Insert a CD partway into the slot, label side up. The player pulls it in and the CD begins playing. To insert a CD while the ignition is off, first press the  button or the DISP knob.

If the ignition or radio is turned off while a CD is in the player, it stays in the player. While the ignition or radio is turned on, the CD starts to play where it stopped, if it was the last selected audio source.

When the CD is inserted, the CD symbol displays. As each new track starts to play, the track number displays.

The CD player can play the smaller 3 inch (8 cm) single CDs with an adapter ring. Full-size CDs and the smaller CDs are loaded in the same manner.

Care of Your CDs

If playing a CD, the sound quality can be reduced due to CD quality, the method of recording, the quality of the music that has been recorded, and the way the CD has been handled. Handle them carefully. Store CD(s) in their original cases or other protective cases and away from direct sunlight and dust. The CD player scans the bottom surface of the disc. If the surface of a CD is damaged, such as cracked, broken, or scratched, the CD does not play properly or not at all.

Do not touch the bottom side of a CD while handling it; this could damage the surface. Pick up CDs by grasping the outer edges or the edge of the hole and the outer edge.

If the surface of a CD is soiled, take a soft, lint free cloth or dampen a clean, soft cloth in a mild, neutral detergent solution mixed with water, and clean it. Make sure the wiping process starts from the center to the edge.

Care of Your CD Player

Do not add any label to a CD, it could get caught in the CD player. If a CD is recorded on a personal computer and a description label is needed, try labeling the top of the recorded CD with a marking pen.

The use of CD lens cleaners for CDs is not advised, due to the risk of contaminating the lens of the CD optics with lubricants internal to the CD player mechanism.

Notice: If a label is added to a CD, or more than one CD is inserted into the slot at a time, or an attempt is made to play scratched or damaged CDs, the CD player could be damaged. While using the CD player, use only CDs in good condition without any label, load one CD at a time, and keep the CD player and the loading slot free of foreign materials, liquids, and debris.

If an error displays, see “CD Messages” later in this section.

For vehicles that have a radio with a Six-Disc CD player, see the following:

LOAD: Press to load CDs into the CD player. This CD player holds up to six CDs.

To insert one CD:

1. Turn the ignition on.
2. Press and release the LOAD button.
3. Wait for the indicator light, located to the right of the slot, to turn green.
4. Load a CD. Insert the CD partway into the slot, label side up. The player pulls the CD in.

To insert multiple CDs:

1. Turn the ignition on.
2. Press and hold the LOAD button for two seconds. The radio beeps once and the indicator light, located to the right of the slot, begins to flash and MULTI LOAD # displays.
3. Once the light stops flashing and turns green, INSERT CD # displays, load a CD. Insert the CD partway into the slot, label side up. The player pulls the CD in.

Once the CD is loaded, the indicator light begins flashing again. Once the light stops flashing and turns green, another CD can be loaded. The CD player takes up to six CDs.

To load more than one CD but less than six, complete Steps 1 through 3. When finished loading CDs, press the LOAD button to cancel the loading function. The radio begins to play the last CD loaded.

If more than one CD has been loaded, a number for each CD displays.

Playing a Specific Loaded CD

For every CD loaded, a number displays. To play a specific CD, press the numbered pushbutton that corresponds to the CD. A small bar appears under the CD number that is playing and the track number displays.

 **(Eject):** Press to eject CD(s).

To eject the CD that is currently playing, press and release.

To eject multiple CDs, do the following:

1. Press and hold this button for two seconds.

The radio beeps once and the indicator light, located to the right of the slot, begins to flash and EJECT ALL displays.

2. Once the light stops flashing, REMOVE CD # displays. The CD ejects and can be removed.

Once the CD is removed, the indicator light begins flashing again and another CD ejects.

To stop ejecting the CDs, press the LOAD or the  button.

If the CD is not removed, after 25 seconds, the CD is automatically pulled back into the player. If a CD is pushed back into the player, before the 25 second time period is complete, the player senses an error and tries to eject the CD several times before stopping.

Do not repeatedly press the  button to eject a CD after trying to push it in manually. The player's 25-second eject timer resets at each press of the eject button, causing the player to not eject the CD until the 25-second time period has elapsed.

1  **(Reverse):** Press to reverse within the current track.

2  **(Fast Forward):** Press to fast forward within the current track.

3  **(Repeat):** Depending on the radio, press to hear a track over again. REPEAT TRACK displays. The current track continues to repeat.

For the radio with a Six-Disc CD player, press to repeat one track or an entire CD.

To use repeat, do the following:

- To repeat playing a track, press and release this button. RPT # displays. Press this button again to turn off repeat play.
- To repeat playing a CD, press and hold this button for two seconds. REPEAT CD # displays. Press this button again to turn off repeat play.

4 RDM (Random): Depending on the radio, press to hear the tracks in random, rather than sequential, order. RANDOM ON displays. Press again to turn off random play.

For the radio with a Six-Disc CD player, press to listen to the tracks in random, on one CD or on all of the CDs.

To use random on a Six-Disc CD player, do one of the following:

- To play the tracks on a CD in random order, press and release the random button. RANDOM ONE displays. Press again to turn off random play.
- To play the tracks on all of the CDs that are loaded in random order, press and hold this button for more than two seconds. A beep sounds and RANDOM ALL displays. Press again to turn off random play.

◀ **SEEK** ▶ : Press the left arrow to go to the start of the current or the previous track. Press the right arrow to go to the start of the next track.

To scan tracks, press and hold either arrow for more than two seconds. SCAN displays. The radio goes to the next track, plays 10 seconds, then goes to the next track.

To scan one CD on a Six-Disc CD player, press and hold either SEEK arrow for more than two seconds until TRACK SCAN displays and a beep sounds. The radio goes to the next track, plays for 10 seconds, then goes to the next track.

Press either arrow again, to stop scanning.

To scan all loaded CDs, press and hold either arrow for more than four seconds until ALL CD SCAN displays and a beep sounds. Use this feature to listen to 10 seconds of the first track of each loaded CD.

Press either arrow again, to stop scanning.

DISP (Display): Press to see how long the current track has been playing. The elapsed time of the track displays. To change the default on the display, track, or elapsed time, press until the desired display appears, then hold the button for two seconds. The radio produces one beep and the selected display becomes the default.

BAND: Press to listen to the radio while a CD is playing. The inactive CD remains inside the radio for future listening.

CD: Press to play a CD while listening to the radio. The CD symbol displays when a CD is loaded.

EQ (Equalization): Press to select an equalization setting while playing a CD. The equalization is set while a CD is played. See “EQ” listed previously for more information. If an EQ setting is selected for a CD, it is activated each time a CD is played.

 **(Eject):** Press to eject a CD. Eject is activated while either the ignition or radio is off. CDs can be loaded while the ignition and radio is off if this button is pressed first.

Playing an MP3 CD-R Disc

Your vehicle's radio may have the MP3 CD-R disc capability feature. For more information, see *Using an MP3 on page 3-97* later in this section.

Using List Mode

The Six-Disc CD player has a feature called song list. This feature is capable of saving 20 track selections.

To save tracks into the song list feature, perform the following steps:

1. Turn the CD player on and load it with at least one CD. See “LOAD” listed previously in this section for more information.
2. Check to see that the CD player is not in song list mode. LIST should not display. If LIST is displayed, press the LIST button to turn it off.
3. Select the desired CD by pressing the numbered pushbutton and then use the  arrow to locate the track to be saved. The track begins to play.
4. Press and hold the LIST button to save the track into memory. When LIST is pressed, one beep sounds immediately. After two seconds of continuously pressing the LIST button, TRACK ADD displays and two beeps sound to confirm the track has been saved.
5. Repeat Steps 3 and 4 for saving other selections.

S-LIST FULL displays if more than 20 selections are saved.

To play the song list, press the LIST button. One beep sounds and S-LIST displays. The recorded tracks begins to play in the order they were saved.

Seek through the song list by using the SEEK arrows. Seeking past the last saved track returns to the first saved track.

To delete tracks from the song list, perform the following steps:

1. Turn the CD player on.
2. Press the LIST button to turn song list on. LIST displays.
3. Press either SEEK arrow to select the desired track to be deleted.
4. Press and hold the LIST button for two seconds. When LIST is pressed, one beep sounds immediately. After two seconds of continuously pressing the LIST button, TRACK DELETE displays and the radio beeps twice to confirm that the track has been deleted.

After a track has been deleted, the remaining tracks are moved up the list. When another track is added to the song list, the track is added to the end of the list.

To delete the entire song list, perform the following steps:

1. Turn the CD player on.
2. Press the LIST button to turn song list on. LIST displays.
3. Press and hold the LIST button for more than four seconds. The radio beeps once, followed by two beeps after two seconds, and a final beep sounds after four seconds. LIST EMPTY displays indicating the song list has been deleted.

If a CD is ejected, and the song list contains saved tracks from that CD, those tracks are automatically deleted from the song list. Any tracks saved to the song list again are added to the bottom of the list.

To end song list mode, press the LIST button. The radio beeps once and LIST is removed from the display.

CD Messages

CHECK CD: If this message displays and/or the CD comes out, it could be for one of the following reasons:

- It is very hot. When the temperature returns to normal, the CD should play.
- You are driving on a very rough road. When the road becomes smoother, the CD should play.
- The CD is dirty, scratched, wet, or upside down.
- The air is very humid. If so, wait about an hour and try again.
- The format of the CD might not be compatible. Depending on the radio, see “MP3 Format” later in this section.
- There could have been a problem while burning the CD.
- The label could be caught in the CD player.

If the CD is not playing correctly, for any other reason, try a known good CD.

If any error occurs repeatedly or if an error cannot be corrected, contact your dealer/retailer. If the radio displays an error message, write it down and provide it to your dealer/retailer when reporting the problem.

Using an MP3

MP3 CD-R Disc MP3 Format

If you burn your own MP3 disc on a personal computer:

- Make sure the MP3 files are recorded on a CD-R disc.
- Do not mix standard audio and MP3 files on one disc.
- Make sure playlists have a .mp3 or .wpl extension, other file extensions may not work.
- Files can be recorded with a variety of fixed or variable bit rates. Song title, artist name, and album will be available for display by the radio when recorded using ID3 tags version 1 and 2.
- Create a folder structure that makes it easy to find songs while driving. Organize songs by albums using one folder for each album. Each folder or album should contain 18 songs or less.
- Make sure to finalize the disc when burning an MP3 disc, using multiple sessions. It is usually better to burn the disc all at once.

The player is able to read and play a maximum of 50 folders, 50 playlists, 10 sessions, and 255 files. Long file names, folder names, or playlist names could use more disc memory space than necessary. To conserve disc space, keep the length of the file, folder, or playlist name brief. MP3 CDs do not require file folders. The system can support up to 11 folders in depth. The depth of the folders should be kept down to make it easier while locating a folder during playback. All items over the maximum are ignored.

Root Directory

The root directory is treated as a folder. If the root directory has compressed audio files, the directory displays as F1 ROOT. All files contained directly under the root directory are accessed prior to any root directory folders. However, playlists (Px) always are accessed before root folders or files.

Empty Directory or Folder

If a root directory or a folder exists somewhere in the file structure that contains only folders/subfolders and no compressed files directly beneath them, the player advances to the next folder in the file structure that contains compressed audio files and the empty folder does not display.

No Folder

If a CD has no folder, only compressed files or playlists are located under the root folder. The next and previous folder functions have no function on a CD that is recorded without folders or playlists. When displaying the name of the folder the radio displays ROOT.

Order of Play

Tracks are played in the following order:

- Play begins from the first track in the first playlist and continues sequentially through all tracks in each playlist. When the last track of the last playlist has played, play continues from the first track of the first playlist.
- If the CD does not contain any playlists, then play begins from the first track under the root directory. When all tracks from the root directory have played, play continues from files according to their numerical listing. After playing the last track from the last folder, play begins again at the first track of the first folder or root directory.

When play enters a new folder, the display does not automatically show the new folder name unless the folder mode is chosen as the default display. See "DISP" later in this section for more information. The new track name displays.

File System and Naming

The song name that displays is the song name that is contained in the ID3 tag. If the song name is not present in the ID3 tag, then the radio displays the file name without the extension (such as .mp3) as the track name.

Track names longer than 32 characters or four pages are shortened. The display does not show parts of words on the last page of text, and the extension of the filename is not displayed.

Preprogrammed Playlists

Preprogrammed playlists which were created by WinAmp™, MusicMatch™, or Real Jukebox™ software can be accessed, however, there is no editing capability. These playlists are treated as special folders containing compressed audio song files.

Playing an MP3



Insert a CD partway into the slot, label side up. The player pulls it in, and READING DISC displays. The CD should begin playing and the CD symbol displays. See “Playing a CD” earlier in this section.

3  (Repeat): Repeat lets one track, the entire folder, or playlist be repeated.

Press and release this button until REPEAT TRACK, REPEAT FOLDER, or REPEAT P-LIST displays. The current track, folder or playlist continues to repeat. Press and release this button until REPEAT OFF displays to turn off repeated play.

4 RDM (Random): Press this pushbutton to hear tracks in random, rather than sequential order. The entire folder, playlist, or CD can be played in random order.

Press and release this pushbutton until RANDOM FOLDER, RANDOM P-LIST (playlist), or RANDOM DISC displays. Once all of the tracks in the current folder or playlist have played, the system moves on to the next folder or playlist, and plays all of the tracks in random order.

While in random, pressing and releasing  or  SEEK arrow takes you to the previous or to the next random track.

Press and release this pushbutton until RANDOM OFF displays, to turn off random play.

5  (**Previous Folder**): Press this button to go to the first track in the previous folder. Press this button while in random folder mode to go to the previous folder and randomly play the tracks in that folder.

6  (**Next Folder**): Press this button to go to the first track in the next folder. Press this button while in random folder mode to go to the next folder and randomly play the tracks in that folder.

DISP (Display): Press this button to change between track mode, folder/playlist mode, and ID3 tag. The display shows only eight characters, but there can be up to four pages of text. If there are more than eight characters in the song, folder, or playlist name, pressing this knob within two seconds goes to the next page of text. If there are no other pages to be shown, pressing this button within two seconds goes to the next display mode.

- Song name and time of day mode displays the current song name and time of day.
- Folder/playlist mode displays the current folder or playlist number the track number and the elapsed time of the track.

- Song name and track number mode displays the current song name and track number.
- ID3 Tag and folder mode displays the ID3 tag information and the folder number.
- Song and folder mode displays the number of songs in the folder and the folder number.

INFO (Information): INFO displays when a current track has ID3 tag information. Press this button to display the artist name and album contained in the tag.

BAND: Press this button to listen to the radio when a CD is playing. The inactive CD remains inside the radio for future listening.

XM Radio Messages

XL (Explicit Language Channels): These channels, or any others, can be blocked at a customer's request, by calling 1-800-852-XXXM (9696).

Updating: The encryption code in the receiver is being updated, and no action is required.

No Signal: The vehicle is in a location that is blocking the XM™ signal. When the vehicle is moved into an open area, the signal should return.

Loading XM: The radio is processing audio and text data received. No action is needed. This message should disappear shortly.

CH Off Air: This channel is not currently in service.

CH Unavail: This previously assigned channel is no longer assigned. Tune to another station. If this station was one of the presets, choose another station for that preset button.

No Info: No artist, song title, category, or text information is available at this time on this channel. The system is working properly.

Not Found: There are no channels available for the selected category. The system is working properly.

XM Locked: The XM™ receiver may have previously been in another vehicle. For security purposes, XM™ receivers cannot be swapped between vehicles. If this message is received after having your vehicle serviced, check with your dealer/retailer.

Radio ID: If tuned to channel 0, this message will alternate with the XM™ Radio eight-digit radio ID label. This label is needed to activate the service.

Unknown: If this message is received when tuned to channel 0, there may be a receiver fault. Consult with your dealer/retailer.

Chk XMRCvr: If this message does not clear within a short period of time, the receiver may have a fault. Consult with your dealer/retailer.

Theft-Deterrent Feature

THEFTLOCK® is designed to discourage theft of your vehicle's radio. The feature works automatically by learning a portion of the Vehicle Identification Number (VIN). If the radio is moved to a different vehicle, it does not operate and LOC, LOCK, or LOCKED could display.

With THEFTLOCK® activated, the radio does not operate if stolen.

Audio Steering Wheel Controls

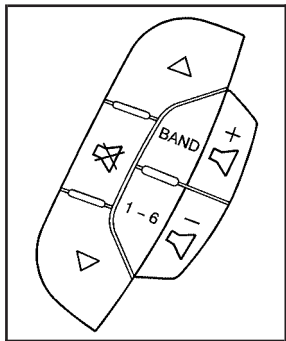

If your vehicle has this feature, some audio controls can be adjusted at the steering wheel. They include the following:

▽ △ (Seek): Press the seek arrows to go to the next or to the previous radio station. The radio seeks stations only with a strong signal that are in the selected band.

To scan stations, press and hold either arrow for two seconds until a beep sounds. The radio goes to a station, play for a few seconds, then goes to the next station. Press either seek arrow again to stop scanning.

While a CD is playing, press the seek arrows to go to the next or previous track.

⊗ (Mute/OnStar®): Press this button to silence the system. Press this button again, or any other radio button, to turn the sound on.

If your vehicle has OnStar®, press and hold this button for more than two seconds to interact with the OnStar® system. See the *OnStar® System on page 2-43* in this manual for more information.

BAND: Press this button to switch between FM1, FM2, AM, or XM1™ or XM2™ (if equipped).

1-6 (Preset Pushbuttons): Press this button to play stations that are programmed on the radio preset pushbuttons. The radio seeks preset stations only with a strong signal that are in the selected band.

When a CD is playing in the six-disc CD changer, press this button to go to the next available CD, if multiple CDs are loaded.

+ / - (Volume): Press the plus or minus volume button to increase or to decrease the volume.

Radio Reception

Frequency interference and static during normal radio reception can occur if items such as cellphone chargers, vehicle convenience accessories, and external electronic devices are plugged into the accessory power outlet. If there is interference or static, unplug the item from the accessory power outlet.

AM

The range for most AM stations is greater than for FM, especially at night. The longer range can cause station frequencies to interfere with each other. For better radio reception, most AM radio stations boost the power levels during the day, and then reduce these levels during the night. Static can also occur when things like storms and power lines interfere with radio reception. When this happens, try reducing the treble on your radio.

FM Stereo

FM stereo gives the best sound, but FM signals reach only about 10 to 40 miles (16 to 65 km). Tall buildings or hills can interfere with FM signals, causing the sound to fade in and out.

XM™ Satellite Radio Service

XM™ Satellite Radio Service gives digital radio reception from coast-to-coast in the 48 contiguous United States, and in Canada. Just as with FM, tall buildings or hills can interfere with satellite radio signals, causing the sound to fade in and out. In addition, traveling or standing under heavy foliage, bridges, garages, or tunnels may cause loss of the XM™ signal for a period of time. The radio may display NO SIGNAL to indicate interference.

Backglass Antenna

The AM-FM antenna is integrated with the rear window defogger, located in the rear window. Make sure that the inside surface of the rear window is not scratched and that the lines on the glass are not damaged. If the inside surface is damaged, it could interfere with radio reception. Also, for proper radio reception, the antenna connector at the top-center of the rear window needs to be properly attached to the post on the glass.

Notice: Using a razor blade or sharp object to clear the inside rear window may damage the rear window antenna and/or the rear window defogger. Repairs would not be covered by your warranty. Do not clear the inside rear window with sharp objects.

Notice: Do not apply aftermarket glass tinting with metallic film. The metallic film in some tinting materials will interfere with or distort the incoming radio reception. Any damage caused to your backglass antenna due to metallic tinting materials will not be covered by your warranty.

Because this antenna is built into the rear window, there is a reduced risk of damage caused by car washes and vandals.

If static is heard on the radio, when the rear window defogger is turned on, it could mean that a defogger grid line has been damaged and the grid line must be repaired.

If adding a cellular telephone to your vehicle, and the antenna needs to be attached to the glass, make sure that you do not damage the grid lines for the AM-FM antenna. There is enough space between the lines to attach a cellular telephone antenna without interfering with radio reception.

XM™ Satellite Radio Antenna System

The XM™ Satellite Radio antenna is located on the roof of your vehicle. Keep this antenna clear of snow and ice build up for clear radio reception.

If your vehicle has a sunroof, the performance of the XM™ system may be affected if the sunroof is open.

Loading items onto the roof of your vehicle can interfere with the performance of the XM™ system. Make sure the XM™ Satellite Radio antenna is not obstructed.

Chime Level Adjustment

The radio is used to adjust the vehicle's chime level. To change the volume level of the chime, press and hold pushbutton 6 with the ignition on and the radio power off. The volume level will change from the normal level to loud, and LOUD will appear on the radio display. To change back to the default or normal setting, press and hold pushbutton 6 again. The volume level will change from the loud level to normal, and NORMAL will appear on the radio display. Removing the radio and not replacing it with a factory radio or chime module will disable vehicle chimes.

 **NOTES**

Section 4 Driving Your Vehicle

Your Driving, the Road, and Your Vehicle	4-2	Driving at Night	4-13
Defensive Driving	4-2	Driving in Rain and on Wet Roads	4-14
Drunk Driving	4-2	Before Leaving on a Long Trip	4-15
Control of a Vehicle	4-3	Highway Hypnosis	4-15
Braking	4-3	Hill and Mountain Roads	4-16
Antilock Brake System (ABS)	4-4	Winter Driving	4-17
Braking in Emergencies	4-5	If Your Vehicle is Stuck in Sand, Mud, Ice, or Snow	4-20
Traction Control System (TCS)	4-6	Rocking Your Vehicle to Get It Out	4-21
Enhanced Traction System (ETS)	4-7	Loading Your Vehicle	4-21
StabiliTrak® System	4-8	Towing	4-27
Steering	4-9	Towing Your Vehicle	4-27
Off-Road Recovery	4-11	Recreational Vehicle Towing	4-27
Passing	4-11	Towing a Trailer	4-28
Loss of Control	4-12		

Your Driving, the Road, and Your Vehicle

Defensive Driving

Defensive driving means “always expect the unexpected.” The first step in driving defensively is to wear your safety belt — See *Safety Belts: They Are for Everyone* on page 1-9.

CAUTION:

Assume that other road users (pedestrians, bicyclists, and other drivers) are going to be careless and make mistakes. Anticipate what they might do and be ready. In addition:

- Allow enough following distance between you and the driver in front of you.
- Focus on the task of driving.

Driver distraction can cause collisions resulting in injury or possible death. These simple defensive driving techniques could save your life.

Drunk Driving

CAUTION:

Drinking and then driving is very dangerous. Your reflexes, perceptions, attentiveness, and judgment can be affected by even a small amount of alcohol. You can have a serious — or even fatal — collision if you drive after drinking. Do not drink and drive or ride with a driver who has been drinking. Ride home in a cab; or if you are with a group, designate a driver who will not drink.

Death and injury associated with drinking and driving is a global tragedy.

Alcohol affects four things that anyone needs to drive a vehicle: judgment, muscular coordination, vision, and attentiveness.

Police records show that almost 40 percent of all motor vehicle-related deaths involve alcohol. In most cases, these deaths are the result of someone who was drinking and driving. In recent years, more than 17,000 annual motor vehicle-related deaths have been associated with the use of alcohol, with about 250,000 people injured.

For persons under 21, it is against the law in every U.S. state to drink alcohol. There are good medical, psychological, and developmental reasons for these laws.

The obvious way to eliminate the leading highway safety problem is for people never to drink alcohol and then drive.

Medical research shows that alcohol in a person's system can make crash injuries worse, especially injuries to the brain, spinal cord, or heart. This means that when anyone who has been drinking — driver or passenger — is in a crash, that person's chance of being killed or permanently disabled is higher than if the person had not been drinking.

Control of a Vehicle

The following three systems help to control your vehicle while driving — brakes, steering, and accelerator. At times, as when driving on snow or ice, it is easy to ask more of those control systems than the tires and road can provide. Meaning, you can lose control of your vehicle. See *Traction Control System (TCS)* on page 4-6, *Enhanced Traction System (ETS)* on page 4-7, and *StabiliTrak[®] System* on page 4-8.

Adding non-dealer/non-retailer accessories can affect your vehicle's performance. See *Accessories and Modifications* on page 5-3.

Braking

See *Brake System Warning Light* on page 3-37.

Braking action involves perception time and reaction time. First, you have to decide to push on the brake pedal. That is perception time. Then you have to bring up your foot and do it. That is reaction time.

Average reaction time is about three-fourths of a second. But that is only an average. It might be less with one driver and as long as two or three seconds or more with another. Age, physical condition, alertness, coordination, and eyesight all play a part. So do alcohol, drugs, and frustration. But even in three-fourths of a second, a vehicle moving at 60 mph (100 km/h) travels 66 feet (20 m). That could be a lot of distance in an emergency, so keeping enough space between your vehicle and others is important.

And, of course, actual stopping distances vary greatly with the surface of the road, whether it is pavement or gravel; the condition of the road, whether it is wet, dry, or icy; tire tread; the condition of the brakes; the weight of the vehicle; and the amount of brake force applied.

Avoid needless heavy braking. Some people drive in spurts — heavy acceleration followed by heavy braking — rather than keeping pace with traffic. This is a mistake. The brakes might not have time to cool between hard stops. The brakes will wear out much faster if you do a lot of heavy braking. If you keep pace with the traffic and allow realistic following distances, you will eliminate a lot of unnecessary braking. That means better braking and longer brake life.

If your vehicle's engine ever stops while you are driving, brake normally but do not pump the brakes. If you do, the pedal could get harder to push down. If the engine stops, you will still have some power brake assist. But you will use it when you brake. Once the power assist is used up, it can take longer to stop and the brake pedal will be harder to push.

Adding non-dealer/non-retailer accessories can affect your vehicle's performance. See *Accessories and Modifications on page 5-3*.

Antilock Brake System (ABS)

Your vehicle has the Antilock Brake System (ABS), an advanced electronic braking system that will help prevent a braking skid.

When you start the engine and begin to drive away, ABS will check itself. You might hear a momentary motor or clicking noise while this test is going on, and you might even notice that the brake pedal moves a little. This is normal.

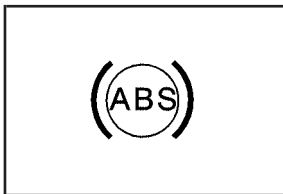

If there is a problem with ABS, this warning light will stay on. See *Antilock Brake System Warning Light* on page 3-38.

Let us say the road is wet and you are driving safely. Suddenly, an animal jumps out in front of you. You slam on the brakes and continue braking. Here is what happens with ABS:

A computer senses that wheels are slowing down. If one of the wheels is about to stop rolling, the computer will separately work the brakes at each wheel.

ABS can change the brake pressure faster than any driver could. The computer is programmed to make the most of available tire and road conditions. This can help you steer around the obstacle while braking hard.

As you brake, the computer keeps receiving updates on wheel speed and controls braking pressure accordingly.

Remember: ABS does not change the time you need to get your foot up to the brake pedal or always decrease stopping distance. If you get too close to the vehicle in front of you, you will not have time to apply the brakes if that vehicle suddenly slows or stops. Always leave enough room up ahead to stop, even though you have ABS.

Using ABS

Do not pump the brakes. Just hold the brake pedal down firmly and let antilock work for you. You might hear the antilock pump or motor operate, and feel the brake pedal pulsate, but this is normal.

Braking in Emergencies

With ABS, you can steer and brake at the same time. In many emergencies, steering can help you more than even the very best braking.

Traction Control System (TCS)

Your vehicle may have a Traction Control System (TCS) that limits wheel spin. This is especially useful in slippery road conditions. The system operates only if it senses that one or both of the front wheels are spinning or beginning to lose traction. When this happens, the system works the front brakes and reduces engine power to limit wheel spin. It may also upshift the transmission to limit wheel spin. You may feel or hear the system working, but this is normal.

The TRACTION CONTROL ACTIVE message on the Driver Information Center (DIC) will be displayed when the system is limiting wheel spin.

If the vehicle is in cruise control when the TCS begins to limit wheel spin, the cruise control will automatically disengage. When road conditions allow safe use of the cruise control, it can be used again. See *Cruise Control on page 3-10*.

The TCS operates in all transmission shift lever positions. But the system can upshift the transmission only as high as the shift lever position that was chosen, so use the lower gears only when necessary. See *Automatic Transmission Operation on page 2-29*.

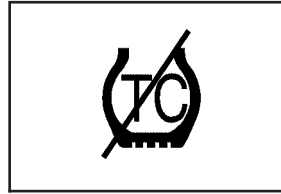

This light, along with the TRACTION CONTROL OFF message, will display on the DIC for three seconds when the TCS is not on.

If there is a problem with the system, the SERVICE TRACTION SYSTEM message will also come on in the DIC. When this warning light is on, the system will not limit wheel spin. Adjust driving accordingly.

To limit wheel spin, especially in slippery road conditions, you should always leave the TCS on. But you can turn the system off if you ever need to. The TCS should be turned off if the vehicle ever gets stuck in sand, mud or snow and rocking the vehicle is required. See *Rocking Your Vehicle to Get It Out on page 4-21* and *If Your Vehicle is Stuck in Sand, Mud, Ice, or Snow on page 4-20*.

To turn the TCS on or off, press the TCS button located above the radio.

When the TCS is turned off, the TCS warning light will come on along with the TRACTION CONTROL OFF message on the DIC. It will disappear when the TCS is turned back on. If the TCS is limiting wheel spin when the TCS button is pressed, the TCS warning light will come on and the TCS will turn off right away.

Adding non-dealer/non-retailer accessories can affect your vehicle's performance. See *Accessories and Modifications on page 5-3* for more information.

Enhanced Traction System (ETS)

Your vehicle may have an Enhanced Traction System (ETS) that limits wheel spin. This is especially useful in slippery road conditions. The system operates only if it senses that one or both of the front wheels are spinning or beginning to lose traction. When this happens, the system reduces engine power and may also upshift the transmission to limit wheel spin. You may feel or hear the system working, but this is normal.

The TRACTION CONTROL ACTIVE message on the Driver Information Center (DIC) will be displayed when the system is limiting wheel spin.

If the vehicle is in cruise control when ETS begins to limit wheel spin, the cruise control will automatically disengage. When road conditions allow safe use of it, the cruise control can be used again. See *Cruise Control on page 3-10*.

The ETS operates in all transmission shift lever positions. But the system can upshift the transmission only as high as the chosen shift lever position, so use the lower gears only when necessary. See *Automatic Transmission Operation on page 2-29*.

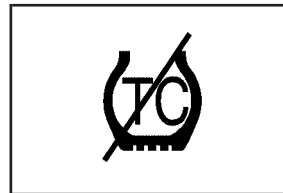

This warning light, along with the TRACTION CONTROL OFF message, will display on the DIC for three seconds when the ETS is not on.

If there is a problem with the system, the SERVICE TRACTION SYSTEM message will also come on in the DIC. When this warning light is on, the system will not limit wheel spin. Adjust your driving accordingly.

To limit wheel spin, especially in slippery road conditions, you should always leave the ETS on. But you can turn the system off if you ever need to. The ETS should be turned off if the vehicle ever gets stuck in sand, mud or snow and rocking the vehicle is required.

To turn the ETS on or off, press the Traction Control button located above the radio.

When the ETS is turned off, the ETS warning light will come on along with the TRACTION CONTROL OFF message on the DIC. It will disappear when the ETS is turned back on. If the ETS is limiting wheel spin when the traction control button is pressed, the ETS warning light will come on and the ETS will turn off right away.

StabiliTrak[®] System

Your vehicle may be equipped with a vehicle stability enhancement system called StabiliTrak[®]. It is an advanced computer controlled system that assists you with directional control of the vehicle in difficult driving conditions.

StabiliTrak[®] activates when the computer senses a discrepancy between your intended path and the direction the vehicle is actually traveling.

StabiliTrak[®] selectively applies braking pressure at any one of the vehicle's brakes to help steer the vehicle in the direction which you are steering.

When the system activates, a STABILITY CONTROL ACTIVE message will be displayed on the Driver Information Center (DIC). See *DIC Warnings and Messages on page 3-58*. You may also hear a noise or feel vibration in the brake pedal. This is normal. Continue to steer the vehicle in the direction you want it to go.

If there is a problem detected with StabiliTrak[®], a SERVICE STABILITY SYSTEM or STABILITY CONTROL OFF message will be displayed on the Driver Information Center (DIC). A warning light will also appear on the instrument panel cluster. See *DIC Warnings and Messages on page 3-58*. When this message is displayed, the system is not operational. Driving should be adjusted accordingly.

If your vehicle is in cruise control when the StabiliTrak[®] activates, the cruise control will automatically disengage. When road conditions allow you to safely use it again, you may reengage the cruise control. See *Cruise Control on page 3-10* for more information.

For vehicles with the 5.3L V8 engine, StabiliTrak[®] can be turned off by pressing and holding the traction control button, located above the radio, for approximately five seconds. A STABILITY CONTROL OFF message will be displayed on the Driver Information Center (DIC) when StabiliTrak[®] is turned off. StabiliTrak[®] will remain off until the traction control button is pressed once to turn it back on, or until the engine is started.

Steering

Power Steering

If you lose power steering assist because the engine stops or the system is not functioning, you can steer but it will take much more effort.

Steering Tips

It is important to take curves at a reasonable speed.

A lot of the “driver lost control” accidents mentioned on the news happen on curves. Here is why:

Experienced driver or beginner, each of us is subject to the same laws of physics when driving on curves. The traction of the tires against the road surface makes it possible for the vehicle to change its path when you turn the front wheels. If there is no traction, inertia will keep the vehicle going in the same direction. If you have ever tried to steer a vehicle on wet ice, you will understand this.

The traction you can get in a curve depends on the condition of the tires and the road surface, the angle at which the curve is banked, and your speed. While you are in a curve, speed is the one factor you can control.

Suppose you are steering through a sharp curve. Then you suddenly apply the brakes. Both control systems — steering and braking — have to do their work where the tires meet the road. Unless you have antilock brakes, adding the hard braking can demand too much of those places. You can lose control.

The same thing can happen if you are steering through a sharp curve and you suddenly accelerate. Those two control systems — steering and acceleration — can overwhelm those places where the tires meet the road and make you lose control. See *Traction Control System (TCS)* on page 4-6, *Enhanced Traction System (ETS)* on page 4-7, and *StabiliTrak® System* on page 4-8.

What should you do if this ever happens? Ease up on the brake or accelerator pedal, steer the vehicle the way you want it to go, and slow down.

Speed limit signs near curves warn that you should adjust your speed. Of course, the posted speeds are based on good weather and road conditions. Under less favorable conditions you will want to go slower.

If you need to reduce your speed as you approach a curve, do it before you enter the curve, while the front wheels are straight ahead.

Try to adjust your speed so you can drive through the curve. Maintain a reasonable, steady speed. Wait to accelerate until you are out of the curve, and then accelerate gently into the straightaway.

Adding non-dealer/non-retailer accessories can affect your vehicle's performance. See *Accessories and Modifications on page 5-3*.

Steering in Emergencies

There are times when steering can be more effective than braking. For example, you come over a hill and find a truck stopped in your lane, or a car suddenly pulls out from nowhere, or a child darts out from between parked cars and stops right in front of you. You can avoid these problems by braking — if you can stop in time. But sometimes you cannot; there is not room. That is the time for evasive action — steering around the problem.

Your vehicle can perform very well in emergencies like these. First apply the brakes. See *Braking on page 4-3*. It is better to remove as much speed as you can from a possible collision. Then steer around the problem, to the left or right depending on the space available.

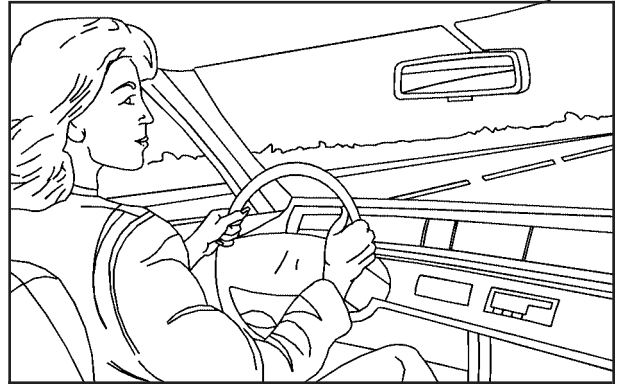

An emergency like this requires close attention and a quick decision. If you are holding the steering wheel at the recommended 9 and 3 o'clock positions, you can turn it a full 180 degrees very quickly without removing either hand. But you have to act fast, steer quickly, and just as quickly straighten the wheel once you have avoided the object.

The fact that such emergency situations are always possible is a good reason to practice defensive driving at all times and wear safety belts properly.

Off-Road Recovery

You may find that your vehicle's right wheels have dropped off the edge of a road onto the shoulder while you are driving.

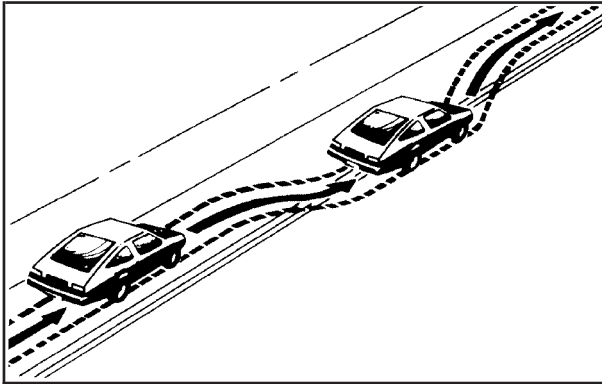

If the level of the shoulder is only slightly below the pavement, recovery should be fairly easy. Ease off the accelerator and then, if there is nothing in the way, steer so that your vehicle straddles the edge of the pavement. You can turn the steering wheel up to one-quarter turn until the right front tire contacts the pavement edge. Then turn the steering wheel to go straight down the roadway.

Passing

Passing another vehicle on a two-lane road can be dangerous. To reduce the risk of danger while passing, we suggest the following tips:

- Look down the road, to the sides, and to crossroads for situations that might affect a successful pass. If in doubt, wait.
- Watch for traffic signs, pavement markings, and lines that could indicate a turn or an intersection. Never cross a solid or double-solid line on your side of the lane.
- Do not get too close to the vehicle you want to pass. Doing so can reduce your visibility.
- Wait your turn to pass a slow vehicle.
- When you are being passed, ease to the right.

Loss of Control

Let us review what driving experts say about what happens when the three control systems — brakes, steering, and acceleration — do not have enough friction where the tires meet the road to do what the driver has asked.

In any emergency, do not give up. Keep trying to steer and constantly seek an escape route or area of less danger.

Skidding

In a skid, a driver can lose control of the vehicle. Defensive drivers avoid most skids by taking reasonable care suited to existing conditions, and by not overdriving those conditions. But skids are always possible.

The three types of skids correspond to your vehicle's three control systems. In the braking skid, the wheels are not rolling. In the steering or cornering skid, too much speed or steering in a curve causes tires to slip and lose cornering force. And in the acceleration skid, too much throttle causes the driving wheels to spin.

A cornering skid is best handled by easing your foot off the accelerator pedal.

Remember: Any traction control system helps avoid only the acceleration skid. If your traction control system is off, then an acceleration skid is also best handled by easing your foot off the accelerator pedal.

If your vehicle starts to slide, ease your foot off the accelerator pedal and quickly steer the way you want the vehicle to go. If you start steering quickly enough, your vehicle may straighten out. Always be ready for a second skid if it occurs.

Of course, traction is reduced when water, snow, ice, gravel, or other material is on the road. For safety, you will want to slow down and adjust your driving to these conditions. It is important to slow down on slippery surfaces because stopping distance will be longer and vehicle control more limited.

While driving on a surface with reduced traction, try your best to avoid sudden steering, acceleration, or braking, including reducing vehicle speed by shifting to a lower gear. Any sudden changes could cause the tires to slide. You may not realize the surface is slippery until your vehicle is skidding. Learn to recognize warning clues — such as enough water, ice, or packed snow on the road to make a mirrored surface — and slow down when you have any doubt.

Remember: Any Antilock Brake System (ABS) helps avoid only the braking skid.

Driving at Night

Night driving is more dangerous than day driving because some drivers are likely to be impaired — by alcohol or drugs, with night vision problems, or by fatigue.

Night driving tips include:

- Drive defensively.
- Do not drink and drive.
- Reduce headlamp glare by adjusting the inside rearview mirror.

- Slow down and keep more space between you and other vehicles because your headlamps can only light up so much road ahead.
- Watch for animals.
- When tired, pull off the road.
- Do not wear sunglasses.
- Avoid staring directly into approaching headlamps.
- Keep the windshield and all glass on your vehicle clean — inside and out.
- Keep your eyes moving, especially during turns or curves.

No one can see as well at night as in the daytime. But, as we get older, these differences increase. A 50-year-old driver might need at least twice as much light to see the same thing at night as a 20-year-old.

Driving in Rain and on Wet Roads

Rain and wet roads can reduce vehicle traction and affect your ability to stop and accelerate. Always drive slower in these types of driving conditions and avoid driving through large puddles and deep-standing or flowing water.

CAUTION:

Wet brakes can cause crashes. They might not work as well in a quick stop and could cause pulling to one side. You could lose control of the vehicle.

After driving through a large puddle of water or a car/vehicle wash, lightly apply the brake pedal until the brakes work normally.

Flowing or rushing water creates strong forces. Driving through flowing water could cause your vehicle to be carried away. If this happens, you and other vehicle occupants could drown. Do not ignore police warnings and be very cautious about trying to drive through flowing water.

Hydroplaning

Hydroplaning is dangerous. Water can build up under your vehicle's tires so they actually ride on the water. This can happen if the road is wet enough and you are going fast enough. When your vehicle is hydroplaning, it has little or no contact with the road.

There is no hard and fast rule about hydroplaning. The best advice is to slow down when the road is wet.

Other Rainy Weather Tips

Besides slowing down, other wet weather driving tips include:

- Allow extra following distance.
- Pass with caution.
- Keep windshield wiping equipment in good shape.
- Keep the windshield washer fluid reservoir filled.
- Have good tires with proper tread depth. See *Tires on page 5-63*.

Before Leaving on a Long Trip

To prepare your vehicle for a long trip, consider having it serviced by your dealer/retailer before departing.

Things to check on your own include:

- *Windshield Washer Fluid*: Reservoir full? Windows clean — inside and outside?
- *Wiper Blades*: In good shape?
- *Fuel, Engine Oil, Other Fluids*: All levels checked?
- *Lamps*: Do they all work and are lenses clean?
- *Tires*: Are treads good? Are tires inflated to recommended pressure?
- *Weather and Maps*: Safe to travel? Have up-to-date maps?

Highway Hypnosis

Always be alert and pay attention to your surroundings while driving. If you become tired or sleepy, find a safe place to park your vehicle and rest.

Other driving tips include:

- Keep the vehicle well ventilated.
- Keep interior temperature cool.
- Keep your eyes moving — scan the road ahead and to the sides.
- Check the rearview mirror and vehicle instruments often.

Hill and Mountain Roads

Driving on steep hills or through mountains is different than driving on flat or rolling terrain. Tips for driving in these conditions include:

- Keep your vehicle serviced and in good shape.
- Check all fluid levels and brakes, tires, cooling system, and transmission.
- Going down steep or long hills, shift to a lower gear.

CAUTION:

If you do not shift down, the brakes could get so hot that they would not work well. You would then have poor braking or even none going down a hill. You could crash. Shift down to let the engine assist the brakes on a steep downhill slope.

CAUTION:

Coasting downhill in NEUTRAL (N) or with the ignition off is dangerous. The brakes will have to do all the work of slowing down and they could get so hot that they would not work well. You would then have poor braking or even none going down a hill. You could crash. Always have the engine running and your vehicle in gear when you go downhill.

- Stay in your own lane. Do not swing wide or cut across the center of the road. Drive at speeds that let you stay in your own lane.
- Top of hills: Be alert — something could be in your lane (stalled car, accident).
- Pay attention to special road signs (falling rocks area, winding roads, long grades, passing or no-passing zones) and take appropriate action.

Winter Driving

Here are some tips for winter driving:

- Have your vehicle in good shape for winter.
- You might want to put winter emergency supplies in your trunk.

Include an ice scraper, a small brush or broom, a supply of windshield washer fluid, a rag, some winter outer clothing, a small shovel, a flashlight, a red cloth, and a couple of reflective warning triangles. And, if you will be driving under severe conditions, include a small bag of sand, a piece of old carpet, or a couple of burlap bags to help provide traction. Be sure you properly secure these items in your vehicle.

Also see *Tires* on page 5-63.

Driving on Snow or Ice

Most of the time, those places where the tires meet the road probably have good traction.

However, if there is snow or ice between the tires and the road, you can have a very slippery situation. You have a lot less traction, or grip, and need to be very careful.



What is the worst time for this? Wet ice. Very cold snow or ice can be slick and hard to drive on. But wet ice can be even more trouble because it can offer the least traction of all. You can get wet ice when it is about freezing, 32°F (0°C), and freezing rain begins to fall. Try to avoid driving on wet ice until salt and sand crews can get there.

Whatever the condition — smooth ice, packed, blowing, or loose snow — drive with caution.

A traction system improves your ability to accelerate when driving on a slippery road. Even though you have a traction system, slow down and adjust your driving to the road conditions. Under certain conditions, you might want to turn the traction system off, such as when driving through deep snow and loose gravel, to help maintain vehicle motion at lower speeds. See *Traction Control System (TCS) on page 4-6*, *Enhanced Traction System (ETS) on page 4-7*, and *StabiliTrak® System on page 4-8*.

The Antilock Brake System (ABS) improves your vehicle's stability when you make a hard stop on a slippery road. Even though you have ABS, begin stopping sooner than you would on dry pavement. See *Antilock Brake System (ABS) on page 4-4*.

- Allow greater following distance on any slippery road.
- Watch for slippery spots. The road might be fine until you hit a spot that is covered with ice. On an otherwise clear road, ice patches can appear in shaded areas where the sun cannot reach, such as around clumps of trees, behind buildings, or under bridges. Sometimes the surface of a curve or an overpass can remain icy when the surrounding roads are clear. If you see a patch of ice ahead of you, brake before you are on it. Try not to brake while you are actually on the ice, and avoid sudden steering maneuvers.

If You Are Caught in a Blizzard

If you are stopped by heavy snow, you could be in a serious situation. You should probably stay with your vehicle unless you know for sure that you are near help and you can hike through the snow. Here are some things to do to summon help and keep yourself and your passengers safe:

- Turn on the hazard warning flashers.
- Tie a red cloth to your vehicle to alert police that you have been stopped by the snow.
- Put on extra clothing or wrap a blanket around you. If you do not have blankets or extra clothing, make body insulators from newspapers, burlap bags, rags, floor mats — anything you can wrap around yourself or tuck under your clothing to keep warm.

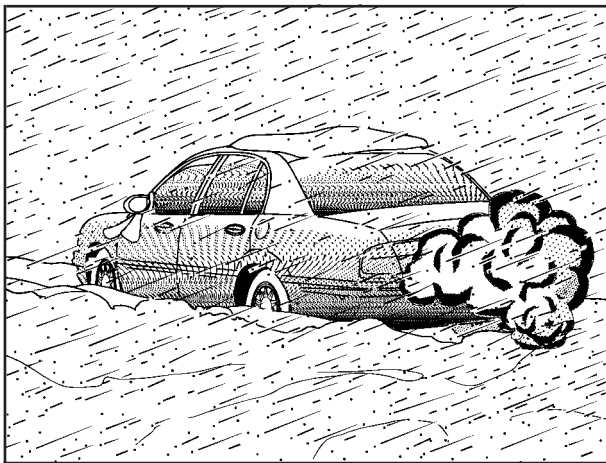

You can run the engine to keep warm, but be careful.

⚠ CAUTION:

Snow can trap exhaust gases under your vehicle. This can cause deadly CO (carbon monoxide) gas to get inside. CO could overcome you and kill you. You cannot see it or smell it, so you might not know it is in your vehicle. Clear away snow from around the base of your vehicle, especially any that is blocking the exhaust pipe. And check around again from time to time to be sure snow does not collect there.

Open a window just a little on the side of the vehicle that is away from the wind. This will help keep CO out.

Run your engine only as long as you must. This saves fuel. When you run the engine, make it go a little faster than just idle. That is, push the accelerator slightly. This uses less fuel for the heat that you get and it keeps the battery charged. You will need a well-charged battery to restart the vehicle, and possibly for signaling later on with the headlamps. Let the heater run for a while.

Then, shut the engine off and close the window almost all the way to preserve the heat. Start the engine again and repeat this only when you feel really uncomfortable from the cold. But do it as little as possible. Preserve the fuel as long as you can. To help keep warm, you can get out of the vehicle and do some fairly vigorous exercises every half hour or so until help comes.

If Your Vehicle is Stuck in Sand, Mud, Ice, or Snow

Slowly and cautiously spin the wheels to free your vehicle when stuck in sand, mud, ice, or snow. See *Rocking Your Vehicle to Get It Out on page 4-21*.

If your vehicle has a traction system, it can often help to free a stuck vehicle. Refer to your vehicle's traction system in the Index. If the stuck condition is too severe for the traction system to free the vehicle, turn the traction system off and use the rocking method.

CAUTION:

If you let your vehicle's tires spin at high speed, they can explode, and you or others could be injured. The vehicle can overheat, causing an engine compartment fire or other damage. Spin the wheels as little as possible and avoid going above 35 mph (55 km/h) as shown on the speedometer.

For information about using tire chains on your vehicle, see *Tire Chains on page 5-84*.

Rocking Your Vehicle to Get It Out

First, turn the steering wheel left and right to clear the area around the front wheels. Turn off any traction or stability system. See *Traction Control System (TCS) on page 4-6*, *Enhanced Traction System (ETS) on page 4-7*, and *StabiliTrak® System on page 4-8*. Then shift back and forth between REVERSE (R) and a forward gear, spinning the wheels as little as possible. To prevent transmission wear, wait until the wheels stop spinning before shifting gears. Release the accelerator pedal while you shift, and press lightly on the accelerator pedal when the transmission is in gear. By slowly spinning the wheels in the forward and reverse directions, you will cause a rocking motion that could free your vehicle. If that does not get your vehicle out after a few tries, it might need to be towed out. If your vehicle does need to be towed out, see *Towing Your Vehicle on page 4-27*.

Loading Your Vehicle

It is very important to know how much weight your vehicle can carry. Two labels on your vehicle show how much weight it may properly carry, the Tire and Loading Information label and the Vehicle Certification label.

CAUTION:

Do not load your vehicle any heavier than the Gross Vehicle Weight Rating (GVWR), or either the maximum front or rear Gross Axle Weight Rating (GAWR). If you do, parts on your vehicle can break, and it can change the way your vehicle handles. These could cause you to lose control and crash. Also, overloading can shorten the life of your vehicle.

Tire and Loading Information Label

The diagram shows a rectangular label with a tire icon on the left. Callout A points to the tire icon. Callout B points to the top right corner of the label. Callout C points to the 'ORIGINAL SIZE' column in the table. Callout D points to the 'COLD TIRE PRESSURE' column in the table.

TIRE AND LOADING INFORMATION				
SEATING CAPACITY		TOTAL	FRONT	REAR
The combined weight of occupants and cargo should never exceed XXX kg or XXX lbs.				
TIRE	ORIGINAL SIZE	COLD TIRE PRESSURE		SEE OWNER'S MANUAL FOR ADDITIONAL INFORMATION
FRONT				
REAR				
SPARE				

Label Example

A vehicle specific Tire and Loading Information label is attached to the vehicle's center pillar (B-pillar). With the driver's door open, you will find the label attached below the door lock post (striker).

The Tire and Loading Information label lists the number of occupant seating positions (A), and the maximum vehicle capacity weight (B) in kilograms and pounds. The vehicle capacity weight includes the weight of all occupants, cargo, and all nonfactory-installed options.

The Tire and Loading Information label also lists the tire size of the original equipment tires (C) and the recommended cold tire inflation pressures (D). For more information on tires and inflation, see *Tires on page 5-63* and *Inflation - Tire Pressure on page 5-70*.

There is also important loading information on the Certification label. It tells you the Gross Vehicle Weight Rating (GVWR) and the Gross Axle Weight Rating (GAWR) for the front and rear axle, see "Certification Label" later in this section.

Steps for Determining Correct Load Limit

1. Locate the statement “The combined weight of occupants and cargo should never exceed XXX kg or XXX lbs” on your vehicle’s placard.
2. Determine the combined weight of the driver and passengers that will be riding in your vehicle.
3. Subtract the combined weight of the driver and passengers from XXX kg or XXX lbs.
4. The resulting figure equals the available amount of cargo and luggage load capacity. For example, if the “XXX” amount equals 1400 lbs and there will be five 150 lb passengers in your vehicle, the amount of available cargo and luggage load capacity is 650 lbs ($1400 - 750 (5 \times 150) = 650$ lbs).
5. Determine the combined weight of luggage and cargo being loaded on the vehicle. That weight may not safely exceed the available cargo and luggage load capacity calculated in Step 4.
6. If your vehicle will be towing a trailer, the load from your trailer will be transferred to your vehicle. Consult this manual to determine how this reduces the available cargo and luggage load capacity for your vehicle.

If your vehicle can tow a trailer, see *Towing a Trailer on page 4-28* for important information on towing a trailer, towing safety rules, and trailering tips.

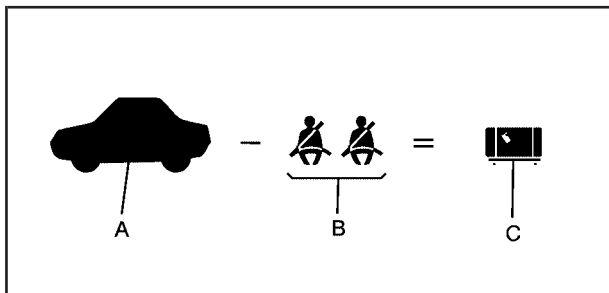

Example 1

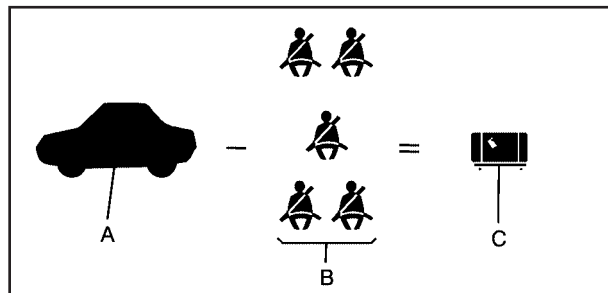

Example 2

Item	Description	Total
A	Maximum Vehicle Capacity Weight for Example 1 =	1,000 lbs (453 kg)
B	Subtract Occupant Weight 150 lbs (68 kg) × 2 =	300 lbs (136 kg)
C	Available Occupant and Cargo Weight =	700 lbs (317 kg)

Item	Description	Total
A	Maximum Vehicle Capacity Weight for Example 2 =	1,000 lbs (453 kg)
B	Subtract Occupant Weight 150 lbs (68 kg) × 5 =	750 lbs (340 kg)
C	Available Cargo Weight =	250 lbs (113 kg)

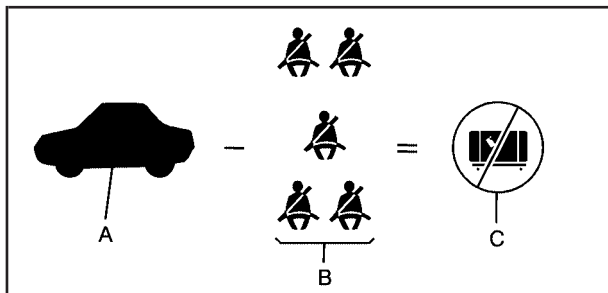

Example 3

Item	Description	Total
A	Maximum Vehicle Capacity Weight for Example 3 =	1,000 lbs (453 kg)
B	Subtract Occupant Weight 200 lbs (91 kg) × 5 =	1,000 lbs (453 kg)
C	Available Cargo Weight =	0 lbs (0 kg)

Refer to your vehicle's Tire and Loading Information label for specific information about your vehicle's maximum vehicle capacity weight and seating positions. The combined weight of the driver, passengers, and cargo should never exceed your vehicle's maximum vehicle capacity weight.

Certification Label

MFD BY GENERAL MOTORS CORP

DATE GVWR GAWR FRT GVWR RR

THIS VEHICLE CONFORMS TO ALL APPLICABLE U.S. FEDERAL MOTOR VEHICLE SAFETY, BUMPER, AND TRAFFIC PREVENTION STANDARDS IN EFFECT ON THE DATE OF MANUFACTURE SHOWN ABOVE.

2000 PLEPASS CAR

EXAMPLE

A vehicle specific Certification label is found on the rear edge of the driver's door.

The label shows the gross weight capacity of your vehicle, called the Gross Vehicle Weight Rating (GVWR). The GVWR includes the weight of the vehicle, all occupants, fuel, and cargo.

Never exceed the GVWR for your vehicle or the Gross Axle Weight Rating (GAWR) for either the front or rear axle.

If the vehicle is going to carry a heavy load, spread it out. See “Steps for Determining Correct Load Limit” earlier in this section.

 **CAUTION:**

Do not load your vehicle any heavier than the Gross Vehicle Weight Rating (GVWR), or either the maximum front or rear Gross Axle Weight Rating (GAWR). If you do, parts on your vehicle can break, and it can change the way your vehicle handles. These could cause you to lose control and crash. Also, overloading can shorten the life of your vehicle.

Notice: Overloading your vehicle may cause damage. Repairs would not be covered by your warranty. Do not overload your vehicle.

If things like suitcases, tools, packages, or anything else are put inside the vehicle, they will go as fast as the vehicle goes. If you have to stop or turn quickly, or if there is a crash, they will keep going.

 **CAUTION:**

Things you put inside your vehicle can strike and injure people in a sudden stop or turn, or in a crash.

- Put things in the trunk of your vehicle. In a trunk, put them as far forward as you can. Try to spread the weight evenly.
- Never stack heavier things, like suitcases, inside the vehicle so that some of them are above the tops of the seats.
- Do not leave an unsecured child restraint in your vehicle.
- When you carry something inside the vehicle, secure it whenever you can.
- Do not leave a seat folded down unless you need to.

Towing

Towing Your Vehicle

Consult your dealer/retailer or a professional towing service if you need to have your disabled vehicle towed. See *Roadside Assistance Program on page 7-8*.

If you want to tow your vehicle behind another vehicle for recreational purposes (such as behind a motorhome), see “Recreational Vehicle Towing” following.

Recreational Vehicle Towing

Recreational vehicle towing means towing your vehicle behind another vehicle — such as behind a motorhome. The two most common types of recreational vehicle towing are known as dinghy towing, towing your vehicle with all four wheels on the ground, and dolly towing, towing your vehicle with two wheels on the ground and two wheels up on a device known as a dolly.

With the proper preparation and equipment, many vehicles can be towed in these ways. See “Dinghy Towing” and “Dolly Towing,” following.

Here are some important things to consider before you do recreational vehicle towing:

- What is the towing capacity of the towing vehicle? Be sure you read the tow vehicle manufacturer's recommendations.
- How far will you tow? Some vehicles have restrictions on how far and how long they can tow.
- Do you have the proper towing equipment? See your dealer/retailer or trailering professional for additional advice and equipment recommendations.
- Is your vehicle ready to be towed? Just as you would prepare your vehicle for a long trip, you will want to make sure your vehicle is prepared to be towed. See *Before Leaving on a Long Trip on page 4-15*.

Dinghy Towing

Notice: If you tow your vehicle with all four wheels on the ground, the drivetrain components could be damaged. The repairs would not be covered by your warranty. Do not tow your vehicle with all four wheels on the ground.

The vehicle was not designed to be towed with all four wheels on the ground. If your vehicle must be towed, you should use a dolly. See “Dolly Towing” that follows for more information.

Dolly Towing

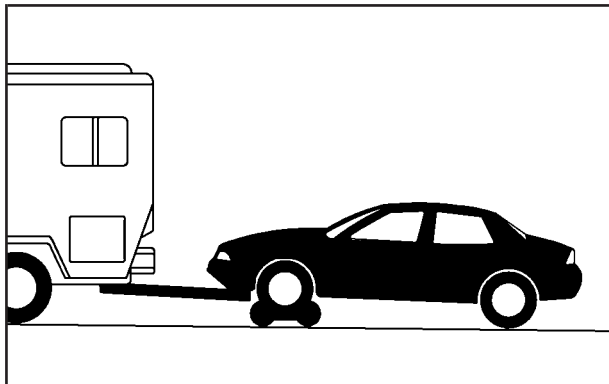

Your vehicle can be towed using a dolly. To tow your vehicle using a dolly:

1. Put the front wheels on a dolly.
2. Put the gear shift lever in PARK (P).
3. Set the parking brake and then remove the ignition key.
4. Clamp the steering wheel in a straight-ahead position.
5. Release the parking brake.

Towing a Trailer

CAUTION:

If you do not use the correct equipment and drive properly, you can lose control when you pull a trailer. For example, if the trailer is too heavy, the brakes may not work well — or even at all. You and your passengers could be seriously injured. You may also damage your vehicle; the resulting repairs would not be covered by your warranty. Pull a trailer only if you have followed all the steps in this section. Ask your dealer/retailer for advice and information about towing a trailer with your vehicle.

Your vehicle can tow a trailer if it has the proper trailer towing equipment. To identify the trailering capacity of your vehicle, read the information in “Weight of the Trailer” that appears later in this section. Trailering is different than just driving the vehicle by itself.

Trailer means changes in handling, acceleration, braking, durability, and fuel economy. Successful, safe trailering takes correct equipment, and it has to be used properly.

That is the reason for this part. In it are many time-tested, important trailering tips and safety rules. Many of these are important for your safety and that of your passengers. So please read this section carefully before pulling a trailer.

Load-pulling components such as the engine, transmission, wheel assembly, and tires are forced to work harder against the drag of the added weight. The engine is required to operate at relatively higher speeds and under greater loads, generating extra heat. What is more, the trailer adds considerably to wind resistance, increasing the pulling requirements.

If You Do Decide To Pull A Trailer

Here are some important points:

- There are many different laws, including speed limit restrictions, having to do with trailering. Make sure your rig will be legal, not only where you live but also where you will be driving. A good source for this information can be state or provincial police.
- Consider using a sway control. Ask a hitch dealer about sway controls.
- Do not tow a trailer at all during the first 1,000 miles (1 600 km) the vehicle is driven. The engine, axle or other parts could be damaged.
- Then, during the first 500 miles (800 km) that the vehicle tows a trailer, do not drive over 50 mph (80 km/h) and do not make starts at full throttle. This helps the engine and other parts of the vehicle wear in at the heavier loads.
- Obey speed limit restrictions when towing a trailer. Do not drive faster than the maximum posted speed for trailers, or no more than 55 mph (90 km/h), to save wear on the vehicle's parts.

There are three important considerations have to do with weight:

- The weight of the trailer
- The weight of the trailer tongue
- The total weight on the vehicle's tires

Weight of the Trailer

How heavy can a trailer safely be?

It should never weigh more than 1,000 lbs (450 kg). But even that can be too heavy.

It depends on how you plan to use your rig. For example, speed, altitude, road grades, outside temperature and how much the vehicle is used to pull a trailer are all important. It can also depend on any special equipment that is on the vehicle, and the amount of tongue weight the vehicle can carry. See "Weight of the Trailer Tongue" later in this section for more information.

Maximum trailer weight is calculated assuming only the driver is in the tow vehicle and it has all the required trailering equipment. The weight of additional optional equipment, passengers and cargo must be subtracted from the maximum trailer weight.

Ask your dealer/retailer for our trailering information or advice, or write us at our Customer Assistance Offices. See *Customer Assistance Offices on page 7-6* for more information.

Weight of the Trailer Tongue

The tongue load (A) of any trailer is an important weight to measure because it affects the total or gross weight of the vehicle. The Gross Vehicle Weight (GVW) includes the curb weight of the vehicle, any cargo in it, and the people who will be riding in the vehicle. If there are a lot of options, equipment, passengers or cargo in the vehicle, it will reduce the tongue weight the vehicle can carry, which will also reduce the trailer weight the vehicle can tow. And if you tow a trailer, you must add the tongue load to the GVW because the vehicle will be carrying that weight, too. See *Loading Your Vehicle on page 4-21* for more information about the vehicle's maximum load capacity.

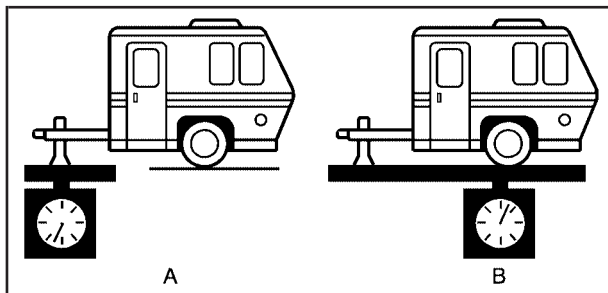

When using a weight-carrying hitch, the trailer tongue (A) should weigh 10 percent to 15 percent of the total loaded trailer weight (B).

After the trailer is loaded, weigh the trailer and the tongue, separately, to see if the weights are proper. The correct weight could be achieved simply by moving some items around in the trailer.

Total Weight on Your Vehicle's Tires

Be sure the vehicle's tires are inflated to the upper limit for cold tires. These numbers can be found on the Tire-Loading Information label. See *Loading Your Vehicle on page 4-21*. Be sure not to go over the GVW limit for the vehicle, or the GAWR, including the weight of the trailer tongue. If a weight distribution hitch is used, make sure not to go over the rear axle limit before applying the weight distribution spring bars.

Hitches

It is important to have the correct hitch equipment. Crosswinds, large trucks going by and rough roads are a few reasons why the right hitch is needed. Here are some rules to follow:

- The rear bumper on the vehicle is not intended for hitches. Do not attach rental hitches or other bumper-type hitches to it. Use only a frame-mounted hitch that does not attach to the bumper.
- If holes need to be made in the body of the vehicle to install a trailer hitch, then be sure to seal the holes later when the hitch is removed. If the holes are not sealed, deadly carbon monoxide (CO) from the exhaust can get into the vehicle. See *Engine Exhaust on page 2-37*. Dirt and water can, too.

Safety Chains

Chains should always be attached between the vehicle and the trailer. Cross the safety chains under the tongue of the trailer so that the tongue will not drop to the road if it becomes separated from the hitch. Instructions about safety chains may be provided by the hitch manufacturer or by the trailer manufacturer. Follow the manufacturer's recommendation for attaching safety chains and do not attach them to the bumper. Always leave just enough slack so the rig can be turned. And, never allow safety chains to drag on the ground.

Trailer Brakes

Does your trailer have its own brakes? Be sure to read and follow the instructions for the trailer brakes so you'll be able to install, adjust and maintain them properly.

- If your vehicle has antilock brakes, do not try to tap into your vehicle's brake system. If you do, both brake systems will not work well, or at all.
- Even if your vehicle does not have antilock brakes, do not tap into your vehicle's brake system if the trailer's brake system will use more than 0.02 cubic inch (0.3 cc) of fluid from your vehicle's master cylinder. If it does, both braking systems will not work well. You could even lose your brakes.
- Will the trailer brake parts take 3,000 psi (20 650 kPa) of pressure? If not, the trailer brake system must not be used with your vehicle.
- If everything checks out this far, then make the brake fluid tap at the upper rear master cylinder port. But do not use copper tubing for this. If you do, it will bend and break off. Use steel brake tubing.

Driving with a Trailer

Towing a trailer requires a certain amount of experience. Before setting out for the open road, get to know the rig. Acquaint yourself with the feel of handling and braking with the added weight of the trailer. And always keep in mind that the vehicle is now a good deal longer and not nearly as responsive as the vehicle is by itself.

Before starting, check all trailer hitch parts and attachments, safety chains, electrical connector, lamps, tires, and mirror adjustment. If the trailer has electric brakes, start the vehicle and trailer moving and then apply the trailer brake controller by hand to be sure the brakes are working. This lets you check the electrical connection at the same time.

During your trip, check occasionally to be sure that the load is secure, and that the lamps and any trailer brakes are still working.

Following Distance

Stay at least twice as far behind the vehicle ahead as when driving the vehicle without a trailer. This can help avoid situations that require heavy braking and sudden turns.

Passing

More passing distance is needed up ahead when towing a trailer. And, because the vehicle is a good deal longer with the trailer, you will need to go much farther beyond the vehicle you have passed before you can return to the proper lane.

Backing Up

Hold the bottom of the steering wheel with one hand. Then, to move the trailer to the left, move that hand to the left. To move the trailer to the right, move your hand to the right. Always back up slowly and, if possible, have someone guide you.

Making Turns

Notice: Making very sharp turns while trailering could cause the trailer to come in contact with the vehicle. Your vehicle could be damaged. Avoid making very sharp turns while trailering.

When turning with a trailer, make wider turns than normal. Do this so the trailer will not strike soft shoulders, curbs, road signs, trees, or other objects. Avoid jerky or sudden maneuvers. Signal well in advance.

Turn Signals When Towing a Trailer

When towing a trailer, the vehicle may need a different turn signal flasher and/or extra wiring. Check with your dealer/retailer. The arrows on the instrument panel will flash whenever signaling a turn or lane change. Properly hooked up, the trailer lamps will also flash, telling other drivers you are about to turn, change lanes or stop.

When towing a trailer, the arrows on the instrument panel will flash for turns even if the bulbs on the trailer are burned out. You may think drivers behind you are seeing your signal when they are not. It is important to check occasionally to be sure the trailer bulbs are still working.

Driving On Grades

Reduce speed and shift to a lower gear *before* starting down a long hill or steep downgrade. If the vehicle is not shifted down, the brakes might have to be used so much that they would get hot and no longer work well.

On a long uphill grade, shift down and reduce the vehicle's speed to around 45 mph (70 km/h) to reduce the possibility of engine and transmission overheating.

If towing a trailer, you may want to drive in THIRD (3) instead of DRIVE (D). Shift to a lower gear as needed.

Parking on Hills

CAUTION:

You really should not park your vehicle, with a trailer attached, on a hill. If something goes wrong, your rig could start to move. People can be injured, and both your vehicle and the trailer can be damaged.

But if the rig ever has to be parked on a hill, here is how to do it:

1. Apply the regular brakes, but do not shift into PARK (P) yet.
2. Have someone place chocks under the trailer's wheels.
3. When the wheel chocks are in place, release the regular brakes until the chocks absorb the load.
4. Reapply the regular brakes. Then apply the parking brake, and shift to PARK (P).
5. Release the regular brakes.

When You Are Ready to Leave After Parking on a Hill

1. Apply the regular brakes and hold the pedal down while you:
 - Start the engine.
 - Shift into a gear.
 - Release the parking brake.
2. Let up on the brake pedal.
3. Drive slowly until the trailer is clear of the chocks.
4. Stop and have someone pick up and store the chocks.

Maintenance When Trailer Towing

The vehicle will need service more often when it pulls a trailer. See *Scheduled Maintenance on page 6-4* for more information. Things that are especially important in trailer operation are automatic transmission fluid; which should not be overfilled; engine oil, drive belt(s), and cooling and brake systems. Each of these is covered in this manual, and the Index will help you find them quickly. If trailering, it is a good idea to review this information before starting on a trip.

Check periodically to see that all hitch nuts and bolts are tight.

Engine Cooling When Trailer Towing

The cooling system may temporarily overheat during severe operating conditions. See *Engine Overheating on page 5-30*.

Section 5 Service and Appearance Care

Service	5-3	Engine Overheating	5-30
Accessories and Modifications	5-3	Overheated Engine Protection	
California Proposition 65 Warning	5-3	Operating Mode	5-32
California Perchlorate Materials Requirements	5-4	Cooling System	5-33
Doing Your Own Service Work	5-4	Power Steering Fluid	5-43
Adding Equipment to the Outside of		Windshield Washer Fluid	5-44
Your Vehicle	5-5	Brakes	5-46
Fuel	5-5	Battery	5-49
Gasoline Octane	5-5	Jump Starting	5-50
Gasoline Specifications	5-6	Headlamp Aiming	5-56
California Fuel	5-6	Bulb Replacement	5-58
Additives	5-7	Halogen Bulbs	5-58
Fuels in Foreign Countries	5-7	Taillamps, Turn Signal, Sidemarkers, Stoplamps	
Filling the Tank	5-8	and Back-up Lamps	5-59
Filling a Portable Fuel Container	5-10	License Plate Lamp	5-61
Checking Things Under the Hood	5-10	Replacement Bulbs	5-61
Hood Release	5-11	Windshield Replacement	5-62
Engine Compartment Overview	5-12	Windshield Wiper Blade Replacement	5-62
Engine Oil	5-18	Tires	5-63
Engine Oil Life System	5-21	Tire Sidewall Labeling	5-64
Engine Air Cleaner/Filter	5-23	Tire Terminology and Definitions	5-67
Automatic Transmission Fluid	5-25	Inflation - Tire Pressure	5-70
Engine Coolant	5-27	Tire Pressure Monitor System	5-71
Radiator Pressure Cap	5-29	Tire Pressure Monitor Operation	5-73
Pressure Cap	5-30		

Section 5 Service and Appearance Care

Tire Inspection and Rotation	5-75	Washing Your Vehicle	5-102
When It Is Time for New Tires	5-77	Cleaning Exterior Lamps/Lenses	5-103
Buying New Tires	5-78	Finish Care	5-103
Different Size Tires and Wheels	5-80	Windshield and Wiper Blades	5-104
Uniform Tire Quality Grading	5-80	Aluminum or Chrome-Plated Wheels and Trim	5-104
Wheel Alignment and Tire Balance	5-82	Tires	5-105
Wheel Replacement	5-82	Sheet Metal Damage	5-105
Tire Chains	5-84	Finish Damage	5-105
If a Tire Goes Flat	5-86	Underbody Maintenance	5-106
Changing a Flat Tire	5-87	Chemical Paint Spotting	5-106
Removing the Spare Tire and Tools	5-88	Vehicle Care/Appearance Materials	5-106
Removing the Flat Tire and Installing the Spare Tire	5-89	Vehicle Identification	5-107
Storing a Flat or Spare Tire and Tools (Base Model)	5-95	Vehicle Identification Number (VIN)	5-107
Storing a Flat or Spare Tire and Tools (Super Only)	5-97	Service Parts Identification Label	5-108
Compact Spare Tire	5-98	Electrical System	5-108
Appearance Care	5-99	Add-On Electrical Equipment	5-108
Interior Cleaning	5-99	Headlamp Wiring	5-109
Fabric/Carpet	5-100	Windshield Wiper Fuses	5-109
Leather	5-101	Power Windows and Other Power Options	5-109
Instrument Panel, Vinyl, and Other Plastic Surfaces	5-101	Fuses and Circuit Breakers	5-109
Care of Safety Belts	5-102	Instrument Panel Fuse Block	5-110
Weatherstrips	5-102	Underhood Fuse Block	5-112
		Capacities and Specifications	5-116
		Capacities and Specifications	5-116

Service

For service and parts needs, visit your dealer/retailer. You will receive genuine GM parts and GM-trained and supported service people.

Genuine GM parts have one of these marks:

ACDelco

GM Parts

**GM
Goodwrench**

GM Accessories

Accessories and Modifications

When non-dealer/non-retailer accessories are added to your vehicle they can affect your vehicle's performance and safety, including such things as, airbags, braking, stability, ride and handling, emissions systems, aerodynamics, durability, and electronic systems like antilock brakes, traction control and stability control. Some of these accessories could even cause malfunction or damage not covered by warranty.

GM Accessories are designed to complement and function with other systems on your vehicle. Your GM dealer/retailer can accessorize your vehicle using genuine GM Accessories. When you go to your GM dealer/retailer and ask for GM Accessories, you will know that GM-trained and supported service technicians will perform the work using genuine GM Accessories.

Also, see *Adding Equipment to Your Airbag-Equipped Vehicle on page 1-67.*

California Proposition 65 Warning

Most motor vehicles, including this one, contain and/or emit chemicals known to the State of California to cause cancer and birth defects or other reproductive harm. Engine exhaust, many parts and systems (including some inside the vehicle), many fluids, and some component wear by-products contain and/or emit these chemicals.

California Perchlorate Materials Requirements

Certain types of automotive applications, such as airbag initiators, seat belt pretensioners, and lithium batteries contained in remote keyless entry transmitters, may contain perchlorate materials. Special handling may be necessary. For additional information, see www.dtsc.ca.gov/hazardouswaste/perchlorate.

Doing Your Own Service Work

CAUTION:

You can be injured and your vehicle could be damaged if you try to do service work on a vehicle without knowing enough about it.

CAUTION: (Continued)

CAUTION: (Continued)

- **Be sure you have sufficient knowledge, experience, the proper replacement parts, and tools before you attempt any vehicle maintenance task.**
- **Be sure to use the proper nuts, bolts, and other fasteners. English and metric fasteners can be easily confused. If you use the wrong fasteners, parts can later break or fall off. You could be hurt.**

If you want to do some of your own service work, you should use the proper service manual. It tells you much more about how to service your vehicle than this manual can. To order the proper service manual, see *Service Publications Ordering Information on page 7-16*.

Your vehicle has an airbag system. Before attempting to do your own service work, see *Servicing Your Airbag-Equipped Vehicle on page 1-66*.

You should keep a record with all parts receipts and list the mileage and the date of any service work you perform. See *Maintenance Record on page 6-16*.

Adding Equipment to the Outside of Your Vehicle

Things you might add to the outside of your vehicle can affect the airflow around it. This can cause wind noise and can affect fuel economy and windshield washer performance. Check with your dealer/retailer before adding equipment to the outside of your vehicle.

Fuel

Use of the recommended fuel is an important part of the proper maintenance of your vehicle. To help keep the engine clean and maintain optimum vehicle performance, we recommend the use of gasoline advertised as TOP TIER Detergent Gasoline.

The 8th digit of the Vehicle Identification Number (VIN) shows the code letter or number that identifies your vehicle's engine. The VIN is at the top left of the instrument panel. See *Vehicle Identification Number (VIN)* on page 5-107.

Gasoline Octane

If your vehicle has the 3.8L V6 engine (VIN Code 2), use regular unleaded gasoline with a posted octane rating of 87 or higher. If the octane rating is less than 87, you might notice an audible knocking noise when you drive, commonly referred to as spark knock. If this occurs, use a gasoline rated at 87 octane or higher as soon as possible. If you are using gasoline rated at 87 octane or higher and you hear heavy knocking, the engine needs service.

If your vehicle has the 3.6L V6 engine (VIN Code 7), use regular unleaded gasoline with a posted octane rating of 87 or higher. For best performance or trailer towing, you could choose to use middle grade 89 octane unleaded gasoline. If the octane rating is less than 87, you might notice an audible knocking noise when you drive, commonly referred to as spark knock. If this occurs, use a gasoline rated at 87 octane or higher as soon as possible. If you are using gasoline rated at 87 octane or higher and you hear heavy knocking, the engine needs service.

If your vehicle has the 5.3L V8 engine (VIN Code C), use premium unleaded gasoline with a posted octane rating of 91 or higher. You can also use regular unleaded gasoline rated at 87 octane or higher, but your vehicle's acceleration could be slightly reduced, and you might notice a slight audible knocking noise, commonly referred to as spark knock. If the octane is less than 87, you might notice a heavy knocking noise when you drive. If this occurs, use a gasoline rated at 87 octane or higher as soon as possible. Otherwise, you could damage the engine. If you are using gasoline rated at 87 octane or higher and you hear heavy knocking, the engine needs service.

Gasoline Specifications

At a minimum, gasoline should meet ASTM specification D 4814 in the United States or CAN/CGSB-3.5 or 3.511 in Canada. Some gasolines contain an octane-enhancing additive called methylcyclopentadienyl manganese tricarbonyl (MMT). We recommend against the use of gasolines containing MMT. See *Additives on page 5-7* for additional information.

California Fuel

If your vehicle is certified to meet California Emissions Standards, it is designed to operate on fuels that meet California specifications. See the underhood emission control label. If this fuel is not available in states adopting California emissions standards, your vehicle will operate satisfactorily on fuels meeting federal specifications, but emission control system performance might be affected. The malfunction indicator lamp could turn on and your vehicle might fail a smog-check test. See *Malfunction Indicator Lamp on page 3-42*. If this occurs, return to your authorized dealer/retailer for diagnosis. If it is determined that the condition is caused by the type of fuel used, repairs might not be covered by your warranty.

Additives

To provide cleaner air, all gasolines in the United States are now required to contain additives that help prevent engine and fuel system deposits from forming, allowing the emission control system to work properly. In most cases, you should not have to add anything to the fuel. However, some gasolines contain only the minimum amount of additive required to meet U.S. Environmental Protection Agency regulations. To help keep fuel injectors and intake valves clean, or if your vehicle experiences problems due to dirty injectors or valves, look for gasoline that is advertised as TOP TIER Detergent Gasoline. Also, your dealer/retailer has additives that will help correct and prevent most deposit-related problems.

Gasolines containing oxygenates, such as ethers and ethanol, and reformulated gasolines might be available in your area. We recommend that you use these gasolines, if they comply with the specifications described earlier. However, E85 (85% ethanol) and other fuels containing more than 10% ethanol must not be used in vehicles that were not designed for those fuels.

Notice: Your vehicle was not designed for fuel that contains methanol. Do not use fuel containing methanol. It can corrode metal parts in the fuel system and also damage plastic and rubber parts. That damage would not be covered under your warranty.

Some gasolines that are not reformulated for low emissions can contain an octane-enhancing additive called methylcyclopentadienyl manganese tricarbonyl (MMT); ask the attendant where you buy gasoline whether the fuel contains MMT. We recommend against the use of such gasolines. Fuels containing MMT can reduce the life of spark plugs and the performance of the emission control system could be affected. The malfunction indicator lamp might turn on. If this occurs, return to your dealer/retailer for service.

Fuels in Foreign Countries

If you plan on driving in another country outside the United States or Canada, the proper fuel might be hard to find. Never use leaded gasoline or any other fuel not recommended in the previous text on fuel. Costly repairs caused by use of improper fuel would not be covered by your warranty.

To check the fuel availability, ask an auto club, or contact a major oil company that does business in the country where you will be driving.

Filling the Tank

CAUTION:

Fuel vapor burns violently and a fuel fire can cause bad injuries. To help avoid injuries to you and others, read and follow all the instructions on the pump island. Turn off your engine when you are refueling. Do not smoke if you are near fuel or refueling your vehicle. Do not use cellular phones. Keep sparks, flames, and smoking materials away from fuel. Do not leave the fuel pump unattended when refueling your vehicle. This is against the law in some places. Do not re-enter the vehicle while pumping fuel. Keep children away from the fuel pump; never let children pump fuel.

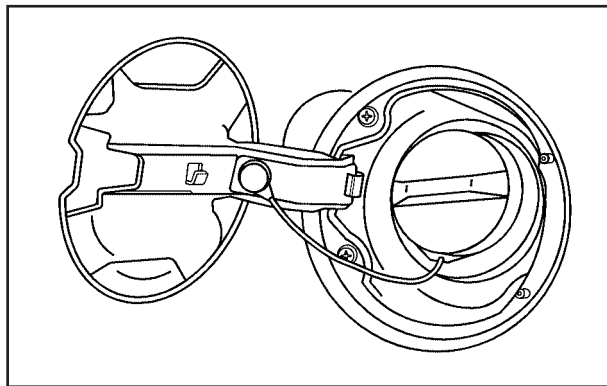

The tethered fuel cap is located behind a hinged fuel door on the driver's side of the vehicle.

To remove the fuel cap, turn it slowly counterclockwise.

While refueling, hang the tethered fuel cap from the hook on the fuel door.

 **CAUTION:**

Fuel can spray out on you if you open the fuel cap too quickly. If you spill fuel and then something ignites it, you could be badly burned. This spray can happen if your tank is nearly full, and is more likely in hot weather. Open the fuel cap slowly and wait for any hiss noise to stop. Then unscrew the cap all the way.

Be careful not to spill fuel. Do not top off or overfill the tank and wait a few seconds after you have finished pumping before removing the nozzle. Clean fuel from painted surfaces as soon as possible. See *Washing Your Vehicle* on page 5-102.

When replacing the fuel cap, turn it clockwise until it clicks. Make sure the cap is fully installed. The diagnostic system can determine if the fuel cap has been left off or improperly installed. This would allow fuel to evaporate into the atmosphere. See *Malfunction Indicator Lamp* on page 3-42.

Your vehicle may also have a check gas cap warning light, which will be displayed on the instrument panel cluster if the fuel cap is not properly installed. See *Check Gas Cap Light* on page 3-49 for more information.

If your vehicle has a Driver Information Center (DIC), the CHECK GAS CAP message will be displayed if the fuel cap is not properly installed. See *DIC Warnings and Messages* on page 3-58 for more information.

 **CAUTION:**

If a fire starts while you are refueling, do not remove the nozzle. Shut off the flow of fuel by shutting off the pump or by notifying the station attendant. Leave the area immediately.

Notice: If you need a new fuel cap, be sure to get the right type. Your dealer/retailer can get one for you. If you get the wrong type, it may not fit properly. This may cause your malfunction indicator lamp to light and may damage your fuel tank and emissions system. See *Malfunction Indicator Lamp* on page 3-42.

Filling a Portable Fuel Container

CAUTION:

Never fill a portable fuel container while it is in your vehicle. Static electricity discharge from the container can ignite the fuel vapor. You can be badly burned and your vehicle damaged if this occurs. To help avoid injury to you and others:

- Dispense fuel only into approved containers.
- Do not fill a container while it is inside a vehicle, in a vehicle's trunk, pickup bed, or on any surface other than the ground.
- Bring the fill nozzle in contact with the inside of the fill opening before operating the nozzle. Contact should be maintained until the filling is complete.
- Do not smoke while pumping fuel.
- Do not use a cellular phone while pumping fuel.

Checking Things Under the Hood

CAUTION:

An electric fan under the hood can start up and injure you even when the engine is not running. Keep hands, clothing, and tools away from any underhood electric fan.

CAUTION:

Things that burn can get on hot engine parts and start a fire. These include liquids like fuel, oil, coolant, brake fluid, windshield washer and other fluids, and plastic or rubber. You or others could be burned. Be careful not to drop or spill things that will burn onto a hot engine.

Hood Release

To open the hood, do the following:

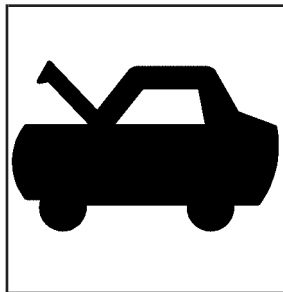

1. Pull the interior hood release handle with this symbol on it. It is located to the left of the steering column below the instrument panel.

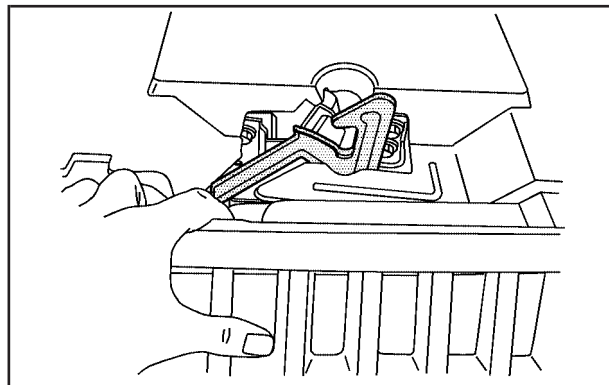

2. Push the secondary hood release lever, located under the center of the hood above the grille, up and to the right to disengage it.
3. Lift the hood.

Before closing the hood, make sure all the filler caps are properly secured. Pull the hood down and close it firmly.

Engine Compartment Overview

When you open the hood on the 3.6L V6 engine, this is what you will see:

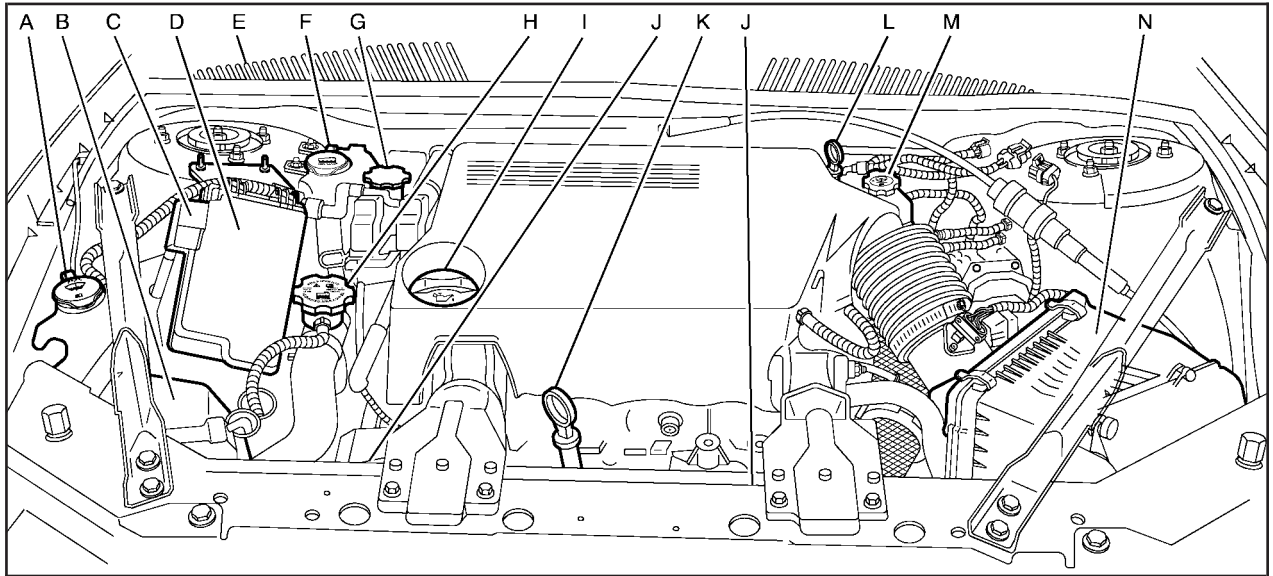

- A. Windshield Washer Fluid Reservoir. See “Adding Washer Fluid” under *Windshield Washer Fluid* on page 5-44.
- B. Battery. See *Battery* on page 5-49.
- C. Remote Positive (+) Terminal. See *Jump Starting* on page 5-50.
- D. Underhood Fuse Block. See *Underhood Fuse Block* on page 5-112.
- E. Passenger Compartment Air Filter. See *Passenger Compartment Air Filter* on page 3-29.
- F. Engine Coolant Recovery Tank. See *Cooling System* on page 5-33.
- G. Power Steering Fluid Reservoir. See *Power Steering Fluid* on page 5-43.
- H. Pressure Cap. See *Radiator Pressure Cap* on page 5-29.
- I. Engine Oil Fill Cap. See “When to Add Engine Oil” under *Engine Oil* on page 5-18.
- J. Electric Engine Cooling Fans. See *Cooling System* on page 5-33.
- K. Engine Oil Dipstick. See “Checking Engine Oil” under *Engine Oil* on page 5-18.
- L. Automatic Transmission Fluid Dipstick. See “Checking the Fluid Level” under *Automatic Transmission Fluid* on page 5-25.
- M. Brake Master Cylinder Reservoir. See “Brake Fluid” under *Brakes* on page 5-46.
- N. Engine Air Cleaner/Filter. See *Engine Air Cleaner/Filter* on page 5-23.

When you open the hood on the 3.8L V6 engine, this is what you will see:

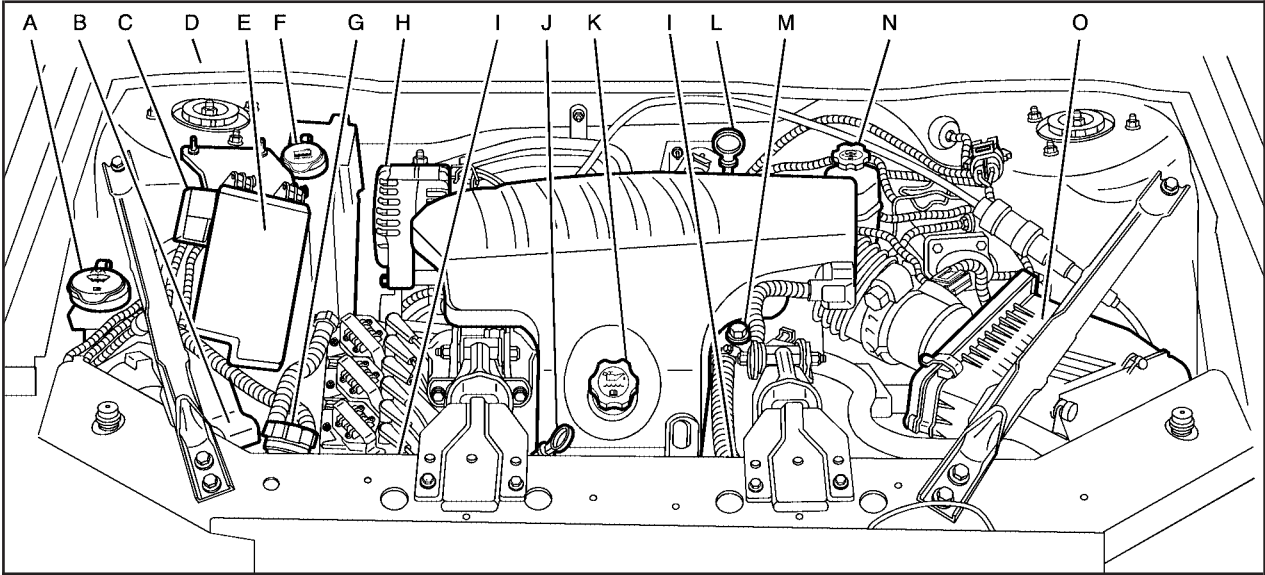

- A. Windshield Washer Fluid Reservoir. See “Adding Washer Fluid” under *Windshield Washer Fluid* on page 5-44.
- B. Battery. See *Battery* on page 5-49.
- C. Remote Positive (+) Terminal. See *Jump Starting* on page 5-50.
- D. Passenger Compartment Air Filter. See *Passenger Compartment Air Filter* on page 3-29.
- E. Underhood Fuse Block. See *Underhood Fuse Block* on page 5-112.
- F. Engine Coolant Recovery Tank. See *Cooling System* on page 5-33.
- G. Radiator Pressure Cap. See *Radiator Pressure Cap* on page 5-29.
- H. Power Steering Fluid Reservoir (Out of View). See *Power Steering Fluid* on page 5-43.
- I. Electric Engine Cooling Fans. See *Cooling System* on page 5-33.
- J. Engine Oil Dipstick. See “Checking Engine Oil” under *Engine Oil* on page 5-18.
- K. Engine Oil Fill Cap. See “When to Add Engine Oil” under *Engine Oil* on page 5-18.
- L. Automatic Transmission Fluid Dipstick. See “Checking the Fluid Level” under *Automatic Transmission Fluid* on page 5-25.
- M. Engine Coolant Bleed Valve. See “How to Add Coolant to the Radiator” under *Cooling System* on page 5-33.
- N. Brake Master Cylinder Reservoir. See “Brake Fluid” under *Brakes* on page 5-46.
- O. Engine Air Cleaner/Filter. See *Engine Air Cleaner/Filter* on page 5-23.

When you open the hood on the 5.3L V8 engine, here is what you will see:

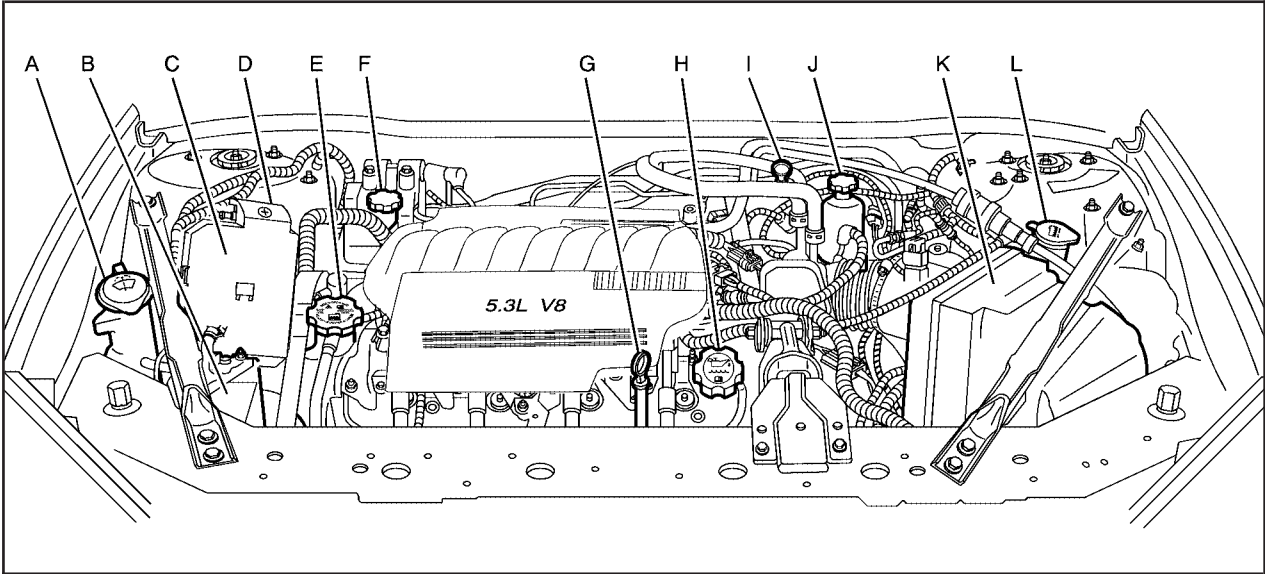

- A. Windshield Washer Fluid Reservoir. See “Adding Washer Fluid” under *Windshield Washer Fluid* on page 5-44.
- B. Battery. See *Battery* on page 5-49.
- C. Underhood Fuse Block. See *Underhood Fuse Block* on page 5-112.
- D. Remote Positive (+) Terminal. See *Jump Starting* on page 5-50.
- E. Pressure Cap. See *Pressure Cap* on page 5-30.
- F. Power Steering Fluid Reservoir. See *Power Steering Fluid* on page 5-43.
- G. Engine Oil Dipstick. See “Checking Engine Oil” under *Engine Oil* on page 5-18.
- H. Engine Oil Fill Cap. See “When to Add Engine Oil” under *Engine Oil* on page 5-18.
- I. Automatic Transmission Fluid Dipstick. See “Checking the Fluid Level” under *Automatic Transmission Fluid* on page 5-25.
- J. Brake Master Cylinder Reservoir. See “Brake Fluid” under *Brakes* on page 5-46.
- K. Engine Air Cleaner/Filter. See *Engine Air Cleaner/Filter* on page 5-23.
- L. Engine Coolant Recovery Tank. See *Cooling System* on page 5-33.

Engine Oil

Checking Engine Oil

It is a good idea to check the engine oil every time you get fuel. In order to get an accurate reading, the oil must be warm and the vehicle must be on level ground.

The engine oil dipstick handle is a yellow loop. See *Engine Compartment Overview on page 5-12* for the location of the engine oil dipstick.

1. Turn off the engine and give the oil several minutes to drain back into the oil pan. If you do not do this, the oil dipstick might not show the actual level.
2. Pull out the dipstick and clean it with a paper towel or cloth, then push it back in all the way. Remove it again, keeping the tip down, and check the level.

When to Add Engine Oil

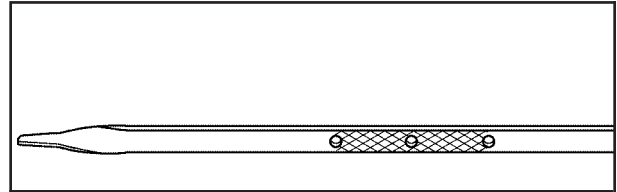

3.6L V6 Engine

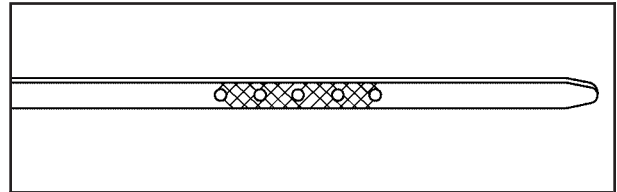

3.8L V6 Engine

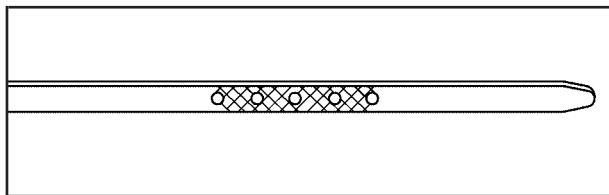

5.3L V8 Engine

If the oil is below the cross-hatched area at the tip of the dipstick, add at least one quart/liter of the recommended oil. This section explains what kind of oil to use. For engine oil crankcase capacity, see *Capacities and Specifications on page 5-116*.

Notice: Do not add too much oil. If the engine has so much oil that the oil level gets above the cross-hatched area that shows the proper operating range, the engine could be damaged.

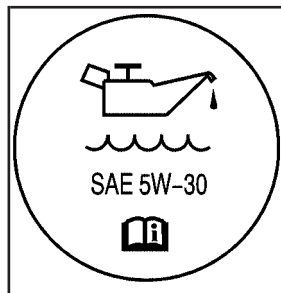

See *Engine Compartment Overview on page 5-12* for the location of the engine oil fill cap.

Be sure to add enough oil to put the level somewhere in the proper operating range in the cross-hatched area. Push the dipstick all the way back in when you are through.

What Kind of Engine Oil to Use

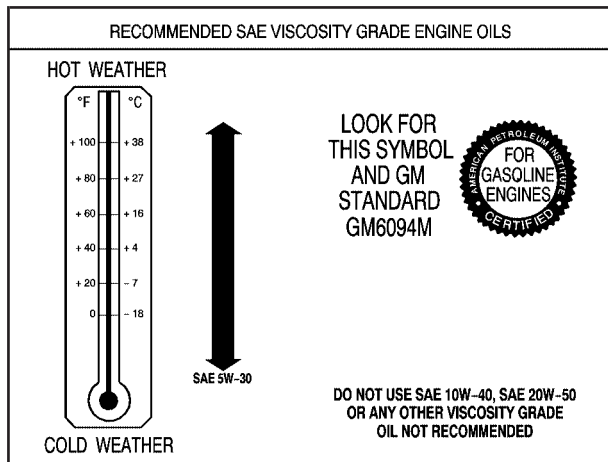

Look for three things:

- GM6094M

Your vehicle's engine requires oil meeting GM Standard GM6094M. Look for and use only an oil that meets GM Standard GM6094M.

- SAE 5W-30

As shown in the viscosity chart, SAE 5W-30 is best for your vehicle.

These numbers on an oil container show its viscosity, or thickness. Do not use other viscosity oils such as SAE 20W-50.



- Oils meeting these requirements should have the starburst symbol on the container. This symbol indicates that the oil has been certified by the American Petroleum Institute (API).

Look for this information on the oil container, and use only those oils that are identified as meeting GM Standard GM6094M and have the starburst symbol on the front of the oil container.

Notice: Use only engine oil identified as meeting GM Standard GM6094M and showing the American Petroleum Institute Certified For Gasoline Engines starburst symbol. Failure to use the recommended oil can result in engine damage not covered by your warranty.

If you are in an area of extreme cold, where the temperature falls below -20°F (-29°C), it is recommended that you use either an SAE 5W-30 synthetic oil or an SAE 0W-30 oil. Both provide easier cold starting and better protection for the engine at extremely low temperatures.

Engine Oil Additives

Do not add anything to the oil. The recommended oils with the starburst symbol that meet GM Standard GM6094M are all you need for good performance and engine protection.

Engine Oil Life System

When to Change Engine Oil

Your vehicle has a computer system that lets you know when to change the engine oil and filter. This is based on engine revolutions and engine temperature, and not on mileage. Based on driving conditions, the mileage at which an oil change will be indicated can vary considerably. For the oil life system to work properly, you must reset the system every time the oil is changed.

When the system has calculated that oil life has been diminished, it will indicate that an oil change is necessary. A change engine oil light or, if your vehicle has the Driver Information Center (DIC), a CHANGE OIL SOON message will come on. See *Change Engine Oil Light on page 3-45* or *DIC Warnings and Messages on page 3-58*. Change the oil as soon as possible within the next 600 miles (1 000 km). It is possible that, if you are driving under the best conditions, the oil life system might not indicate that an oil change is necessary for over a year. However, the engine oil and filter must be changed at least once a year and at this time the system must be reset. Your dealer/retailer has trained service people who will perform this work using genuine parts and reset the system. It is also important to check the oil regularly and keep it at the proper level.

If the system is ever reset accidentally, you must change the oil at 3,000 miles (5 000 km) since the last oil change. Remember to reset the oil life system whenever the oil is changed.

How to Reset the Engine Oil Life System

The Engine Oil Life System calculates when to change the engine oil and filter based on vehicle use. Whenever the oil is changed, reset the system so it can calculate when the next oil change is required. If a situation occurs where you change the oil prior to a change engine oil light or CHANGE OIL SOON message being turned on, reset the system.

After changing the engine oil, reset the system:

- Vehicles with Driver Information Center (DIC)
 1. Press the option button on the DIC until ENGINE OIL MONITOR appears on the DIC screen.
 2. Press the set/reset button to reset the system. The next screen indicates that the CHANGE OIL SOON message has been reset.

If the vehicle has the uplevel DIC, when the gages button is pressed and the OIL LIFE REMAINING mode appears, it should read 100 percent OIL LIFE REMAINING.
 3. Turn the key to LOCK/OFF.

- Vehicles without Driver Information Center (DIC)
 1. With the engine off, turn the ignition key to ON/RUN.
 2. Fully press and release the accelerator pedal slowly three times within five seconds.
 3. Turn the key to LOCK/OFF, then start the vehicle.

If the light or message comes back on when you start your vehicle, the oil life system has not reset. Repeat the procedure.

What to Do with Used Oil

Used engine oil contains certain elements that can be unhealthy for your skin and could even cause cancer. Do not let used oil stay on your skin for very long. Clean your skin and nails with soap and water, or a good hand cleaner. Wash or properly dispose of clothing or rags containing used engine oil. See the manufacturer's warnings about the use and disposal of oil products.

Used oil can be a threat to the environment. If you change your own oil, be sure to drain all the oil from the filter before disposal. Never dispose of oil by putting it in the trash, pouring it on the ground, into sewers, or into streams or bodies of water. Instead, recycle it by taking it to a place that collects used oil. If you have a problem properly disposing of used oil, ask your dealer/retailer, a service station, or a local recycling center for help.

Engine Air Cleaner/Filter

The engine air cleaner/filter is located in the engine compartment on the driver's side of the vehicle. See *Engine Compartment Overview* on page 5-12 for more information on location.

When to Inspect the Engine Air Cleaner/Filter

Inspect the air cleaner/filter at the Maintenance II intervals and replace it at the first oil change after each 50,000 mile (80 000 km) interval. See *Scheduled Maintenance* on page 6-4 for more information. If you are driving in dusty/dirty conditions, inspect the filter at each engine oil change.

How to Inspect the Engine Air Cleaner/Filter

To inspect the air cleaner/filter, remove the filter from the vehicle and lightly shake the filter to release loose dust and dirt. If the filter remains caked with dirt, a new filter is required.

To inspect or replace the engine air cleaner/filter do the following:

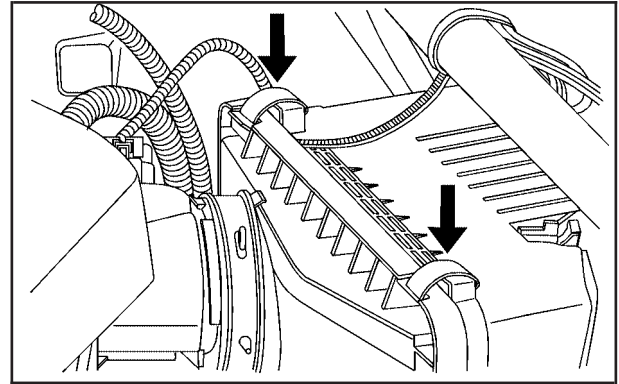

3.8L V6 Engine shown, 3.6L Engine similar

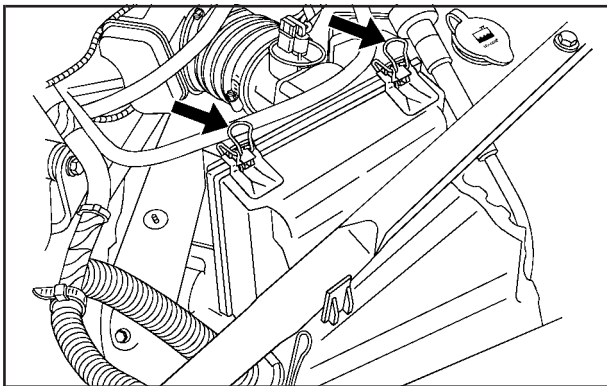

5.3L V8 Engine

1. Lift the filter cover tabs on top of the engine air cleaner/filter housing.
2. Push the filter cover housing toward the engine.
3. Pull out the filter.
4. Inspect or replace the engine air cleaner/filter.

5. To reinstall the cover, position the tabs through the slots on the housing. If your vehicle has one of the V6 engines, a notch on the sides of the filter cover will indicate the correct engagement.
6. Push the cover tabs on top of the housing to lock the cover in place.

⚠ CAUTION:

Operating the engine with the air cleaner/filter off can cause you or others to be burned. The air cleaner not only cleans the air; it helps to stop flames if the engine backfires. If it is not there and the engine backfires, you could be burned. Do not drive with it off, and be careful working on the engine with the air cleaner/filter off.

Notice: If the air cleaner/filter is off, a backfire can cause a damaging engine fire. And, dirt can easily get into your engine, which will damage it. Always have the air cleaner/filter in place when you are driving.

Automatic Transmission Fluid

When to Check and Change Automatic Transmission Fluid

A good time to check the automatic transmission fluid level is when the engine oil is changed.

Change the fluid and filter at the intervals listed in *Additional Required Services on page 6-6*, and be sure to use the transmission fluid listed in *Recommended Fluids and Lubricants on page 6-12*.

How to Check Automatic Transmission Fluid

Because this operation can be a little difficult, you may choose to have this done at the dealer/retailer service department.

If you do it yourself, be sure to follow all the instructions here, or you could get a false reading on the dipstick.

Notice: Too much or too little fluid can damage your transmission. Too much can mean that some of the fluid could come out and fall on hot engine parts or exhaust system parts, starting a fire. Too little fluid could cause the transmission to overheat. Be sure to get an accurate reading if you check your transmission fluid.

Wait at least 30 minutes before checking the transmission fluid level if you have been driving:

- When outside temperatures are above 90°F (32°C).
- At high speed for quite a while.
- In heavy traffic — especially in hot weather.
- While pulling a trailer.

To get the right reading, the fluid should be at normal operating temperature, which is 180°F to 200°F (82°C to 93°C).

Get the vehicle warmed up by driving about 15 miles (24 km) when outside temperatures are above 50°F (10°C). If it is colder than 50°F (10°C), you may have to drive longer.

Checking the Fluid Level

Prepare the vehicle as follows:

1. Park the vehicle on a level place. Keep the engine running.
2. With the parking brake applied, place the shift lever in PARK (P).
3. With your foot on the brake pedal, move the shift lever through each gear, pausing for about three seconds in each one. Then, position the shift lever in PARK (P).
4. Let the engine run at idle for three to five minutes.

Then, without shutting off the engine, follow these steps:

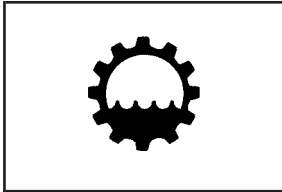

The transmission fluid dipstick handle has this symbol on it, and is located near the rear of the engine compartment.

See *Engine Compartment Overview* on page 5-12 for more information on location.

1. Pull out the dipstick and wipe it with a clean rag or paper towel.
2. Push it back in all the way, wait three seconds and then pull it back out again.

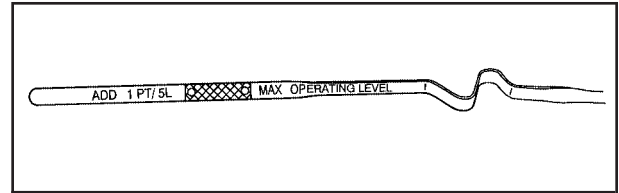

3. Check both sides of the dipstick, and read the lower level. The fluid level must be in the crosshatched area.
4. If the fluid level is in the acceptable range, push the dipstick back in all the way.

How to Add Automatic Transmission Fluid

Refer to the Maintenance Schedule to determine what kind of transmission fluid to use. See *Recommended Fluids and Lubricants on page 6-12*.

If the fluid level is low, add only enough of the proper fluid to bring the level into the crosshatched area on the dipstick.

1. Pull out the dipstick.
2. Using a long-neck funnel, add enough fluid at the dipstick hole to bring it to the proper level.

It does not take much fluid, generally less than one pint (0.5 L). Do not overfill.

Notice: Use of the incorrect automatic transmission fluid may damage your vehicle, and the damages may not be covered by your warranty. Always use the automatic transmission fluid listed in *Recommended Fluids and Lubricants on page 6-12*.

3. After adding fluid, recheck the fluid level as described under “How to Check Automatic Transmission Fluid,” earlier in this section.
4. When the correct fluid level is obtained, push the dipstick back in all the way.

Engine Coolant

The cooling system in the vehicle is filled with DEX-COOL[®] engine coolant. This coolant is designed to remain in the vehicle for five years or 150,000 miles (240 000 km), whichever occurs first, if only DEX-COOL[®] extended life coolant is added.

The following explains the cooling system and how to add coolant when it is low. If there is a problem with engine overheating or if coolant needs to be added to the radiator, see *Engine Overheating on page 5-30*.

A 50/50 mixture of clean, drinkable water and DEX-COOL[®] engine coolant will:

- Give freezing protection down to -34°F (-37°C).
- Give boiling protection up to 265°F (129°C).
- Protect against rust and corrosion.
- Help keep the proper engine temperature.
- Let the warning lights and gages work as they should.

Notice: Using coolant other than DEX-COOL[®] may cause premature engine, heater core, or radiator corrosion. In addition, the engine coolant may require changing sooner, at the first maintenance service after each 30,000 miles (50 000 km) or 24 months, whichever occurs first. Any repairs would not be covered by your warranty. Always use DEX-COOL[®] (silicate-free) coolant in your vehicle.

What to Use

Use a mixture of one-half clean, drinkable water and one-half DEX-COOL® engine coolant which will not damage aluminum parts. If this coolant mixture is used, nothing else needs to be added.

CAUTION:

Adding only plain water to your cooling system can be dangerous. Plain water, or some other liquid such as alcohol, can boil before the proper coolant mixture will. Your vehicle's coolant warning system is set for the proper coolant mixture. With plain water or the wrong mixture, your engine could get too hot but you would not get the overheat warning. Your engine could catch fire and you or others could be burned. Use a 50/50 mixture of clean, drinkable water and DEX-COOL® coolant.

Notice: If you use an improper coolant mixture, your engine could overheat and be badly damaged. The repair cost would not be covered by your warranty. Too much water in the mixture can freeze and crack the engine, radiator, heater core, and other parts.

If coolant needs to be added more than four times a year, have your dealer/retailer check the cooling system.

Notice: If you use extra inhibitors and/or additives in your vehicle's cooling system, you could damage your vehicle. Use only the proper mixture of the engine coolant listed in this manual for the cooling system. See *Recommended Fluids and Lubricants* on page 6-12 for more information.

Checking Coolant

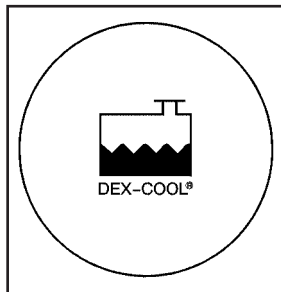

The coolant recovery tank is located in the engine compartment toward the rear of the engine on the passenger side of the vehicle.

If your vehicle is equipped with the 5.3L engine the coolant recovery tank is located in the engine compartment toward the rear of the engine on the driver side of the vehicle. See *Engine Compartment Overview* on page 5-12 for more information on location.

The vehicle must be on a level surface when checking the coolant level.

When the engine is cold, the coolant level should be at the COLD FILL line or a little higher. The COLD FILL line is near the bottom of the recovery tank and has an arrow pointing down at it.

Adding Coolant

If more coolant is needed, add the proper DEX-COOL® coolant mixture at the coolant recovery tank, but be careful not to spill it.

If the coolant recovery tank is completely empty, add coolant to the radiator. See *Engine Overheating on page 5-30*.

CAUTION:

Turning the radiator pressure cap when the engine and radiator are hot can allow steam and scalding liquids to blow out and burn you badly. With the coolant recovery tank, you will almost never have to add coolant at the radiator. Never turn the radiator pressure cap — even a little — when the engine and radiator are hot.

CAUTION:

You can be burned if you spill coolant on hot engine parts. Coolant contains ethylene glycol, and it will burn if the engine parts are hot enough. Do not spill coolant on a hot engine.

Occasionally check the coolant level in the radiator. For information on how to add coolant to the radiator, see *Cooling System on page 5-33*.

Radiator Pressure Cap

Notice: If the pressure cap is not tightly installed, coolant loss and possible engine damage may occur. Be sure the cap is properly and tightly secured.

The radiator pressure cap is located in the front of the engine compartment on the passenger's side of the vehicle. See *Engine Compartment Overview on page 5-12* for more information on location.

Pressure Cap

Notice: If the pressure cap is not tightly installed, coolant loss and possible engine damage may occur. Be sure the cap is properly and tightly secured.

See *Engine Compartment Overview* on page 5-12 for more information on location.

Engine Overheating

There is a coolant temperature gage and a warning light on the instrument panel cluster that indicate an overheated engine condition. See *Engine Coolant Temperature Gage* on page 3-40 and *Engine Coolant Temperature Warning Light* on page 3-40 for more information.

In addition, if your vehicle is equipped with a Driver Information Center (DIC), you will find an ENGINE COOLANT HOT and a REDUCED POWER STOP WHEN SAFE message displayed on the DIC. See *DIC Warnings and Messages* on page 3-58 for more information.

If Steam Is Coming From Your Engine

CAUTION:

Steam from an overheated engine can burn you badly, even if you just open the hood. Stay away from the engine if you see or hear steam coming from it. Turn it off and get everyone away from the vehicle until it cools down. Wait until there is no sign of steam or coolant before you open the hood.

If you keep driving when the vehicle's engine is overheated, the liquids in it can catch fire. You or others could be badly burned. Stop your engine if it overheats, and get out of the vehicle until the engine is cool.

See *Overheated Engine Protection Operating Mode* on page 5-32 for information on driving to a safe place in an emergency.

Notice: If your engine catches fire because you keep driving with no coolant, your vehicle can be badly damaged. The costly repairs would not be covered by your warranty. See *Overheated Engine Protection Operating Mode* on page 5-32 for information on driving to a safe place in an emergency.

If No Steam Is Coming From Your Engine

If you get an engine overheat warning, but see or hear no steam, the problem may not be too serious. Sometimes the engine can get a little too hot when you:

- Climb a long hill on a hot day.
- Stop after high-speed driving.
- Idle for long periods in traffic.
- Tow a trailer.

If you get the overheat warning with no sign of steam, try this for a minute or so:

1. In heavy traffic, let the engine idle in NEUTRAL (N) while stopped. If it is safe to do so, pull off the road, shift to PARK (P) or NEUTRAL (N) and let the engine idle.
2. Set the climate controls to the highest heat setting and fan speed and open the windows as necessary.

If you no longer have the overheat warning, you can drive. Just to be safe, drive slower for about 10 minutes. If the warning does not come back on, you can drive normally.

If the warning continues and you have not stopped, pull over, stop, and park your vehicle right away.

If there is still no sign of steam, you can idle the engine for three minutes while you are parked. If you still have the warning, turn off the engine and get everyone out of the vehicle until it cools down. Also, see “Overheated Engine Protection Operating Mode” later in this section.

You may decide not to lift the hood but to get service help right away.

Overheated Engine Protection Operating Mode

This emergency operating mode allows your vehicle to be driven to a safe place in an emergency situation. If an overheated engine condition exists, an overheat protection mode which alternates firing groups of cylinders helps prevent engine damage. In this mode, you will notice a significant loss in power and engine performance. The REDUCED POWER STOP WHEN SAFE message will come on in the Driver Information Center (DIC), if the vehicle has one, along with the engine coolant temperature warning light on the instrument panel, to indicate the vehicle has entered overheated engine protection operating mode. The temperature gage will also indicate an overheat condition exists. Driving extended miles (km) and/or towing a trailer in the overheat protection mode should be avoided.

Notice: After driving in the overheated engine protection operating mode, to avoid engine damage, allow the engine to cool before attempting any repair. The engine oil will be severely degraded. Repair the cause of coolant loss, change the oil and reset the oil life system. See *Engine Oil on page 5-18*.

Cooling System

When you decide it is safe to lift the hood, this is what you will see:

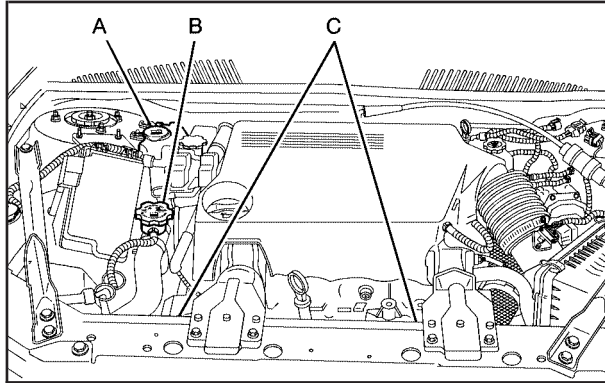

3.6L V6 Engine

- A. Coolant Recovery Tank
- B. Pressure Cap
- C. Electric Engine Cooling Fans

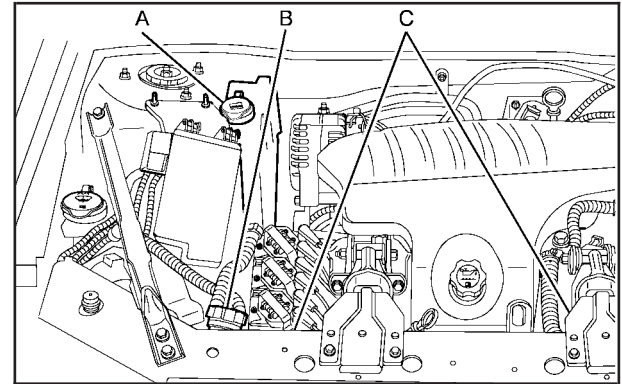

3.8L V6 Engine

- A. Coolant Recovery Tank
- B. Radiator Pressure Cap
- C. Electric Engine Cooling Fans

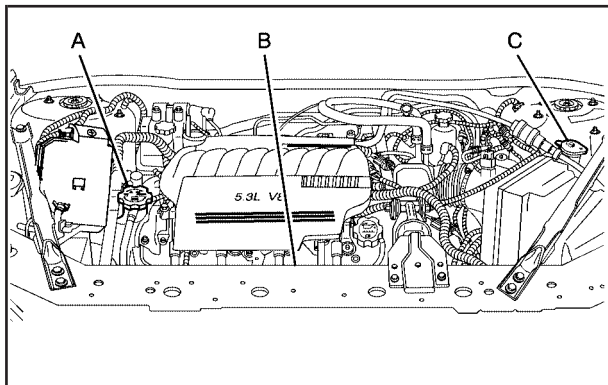

5.3L V8 Engine

- A. Pressure Cap
- B. Electric Engine Cooling Fans
- C. Coolant Recovery Tank

⚠ CAUTION:

An electric engine cooling fan under the hood can start up even when the engine is not running and can injure you. Keep hands, clothing, and tools away from any underhood electric fan.

If the coolant inside the coolant recovery tank is boiling, do not do anything else until it cools down. The vehicle should be parked on a level surface.

When the engine is cold, the coolant level should be at or above the COLD FILL line on the coolant recovery tank. If it is not, there may be a leak at the pressure cap or in the radiator hoses, heater hoses, radiator, water pump, or somewhere else in the cooling system.

 **CAUTION:**

Heater and radiator hoses, and other engine parts, can be very hot. Do not touch them. If you do, you can be burned.

Do not run the engine if there is a leak. If you run the engine, it could lose all coolant. That could cause an engine fire, and you could be burned. Get any leak fixed before you drive the vehicle.

If there seems to be no leak, with the engine on, check to see if the electric engine cooling fans are running. If the engine is overheating, the fans should be running. If the fans are not running, the vehicle needs service.

Notice: Engine damage from running your engine without coolant is not covered by your warranty. See *Overheated Engine Protection Operating Mode on page 5-32* for information on driving to a safe place in an emergency.

Notice: Using coolant other than DEX-COOL[®] may cause premature engine, heater core, or radiator corrosion. In addition, the engine coolant could require changing sooner, at 30,000 miles (50 000 km) or 24 months, whichever occurs first. Any repairs would not be covered by the warranty. Always use DEX-COOL[®] (silicate-free) coolant in the vehicle.

How to Add Coolant to the Coolant Recovery Tank

CAUTION:

Adding only plain water to the cooling system can be dangerous. Plain water, or some other liquid such as alcohol, can boil before the proper coolant mixture will. The vehicle's coolant warning system is set for the proper coolant mixture. With plain water or the wrong mixture, the engine could get too hot but you would not get the overheat warning. The engine could catch fire and you or others could be burned. Use a 50/50 mixture of clean, drinkable water and DEX-COOL[®] coolant.

If you have not found a problem yet, but the coolant level is not at the COLD FILL line, add a 50/50 mixture of clean, drinkable water and DEX-COOL[®] engine coolant at the coolant recovery tank. See *Engine Coolant* on page 5-27 for more information.

Notice: In cold weather, water can freeze and crack the engine, radiator, heater core and other parts. Use the recommended coolant and the proper coolant mixture.

 **CAUTION:**

You can be burned if you spill coolant on hot engine parts. Coolant contains ethylene glycol and it will burn if the engine parts are hot enough. Do not spill coolant on a hot engine.

When the coolant level in the coolant recovery tank is at the COLD FILL line, start the vehicle.

If the overheat warning continues, there is one more thing you can try. You can add the proper coolant mixture directly to the cooling system through the coolant fill neck under the pressure cap, but be sure the system is cool before you do it.

 **CAUTION:**

Steam and scalding liquids from a hot cooling system can blow out and burn you badly. They are under pressure, and if you turn the radiator pressure cap — even a little — they can come out at high speed. Never turn the cap when the cooling system, including the radiator pressure cap, is hot. Wait for the cooling system and radiator pressure cap to cool if you ever have to turn the pressure cap.

How to Add Coolant to the Cooling System (3.6L V6 Engine)

Notice: The engine has a specific cooling system drain and fill procedure. Failure to follow this procedure could cause the engine to overheat and be severely damaged. If the engine's cooling system needs to be drained and re-filled, please see the dealer/retailer.

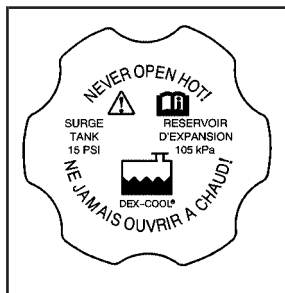

1. You can remove the pressure cap when the cooling system, including the pressure cap and upper radiator hose is no longer hot.

Turn the pressure cap slowly counterclockwise. If you hear a hiss, wait for that to stop. A hiss means that there is still some pressure left.

2. Then keep turning the pressure cap and remove it.

CAUTION:

You can be burned if you spill coolant on hot engine parts. Coolant contains ethylene glycol and it will burn if the engine parts are hot enough. Do not spill coolant on a hot engine.

3. Fill the cooling system with the proper DEX-COOL[®] coolant mixture, up to the base of the filler neck. See *Engine Coolant on page 5-27* for more information about the proper coolant mixture.
4. Rinse or wipe any spilled coolant from the engine and the compartment.

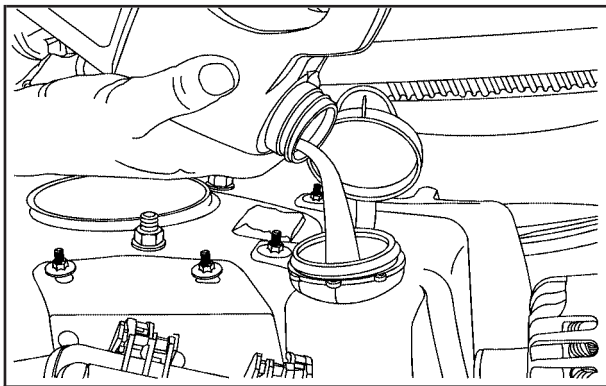

5. Then fill the coolant recovery tank to the COLD FILL line.
6. Reinstall the coolant recovery tank cap and the pressure cap.
7. If the coolant in the recovery tank is constantly low, you should have your dealer/retailer service department inspect the vehicle for leaks.

How to Add Coolant to the Radiator (3.8L V6 Engine)

Notice: Your engine has a specific radiator fill procedure. Failure to follow this procedure could cause your engine to overheat and be severely damaged.

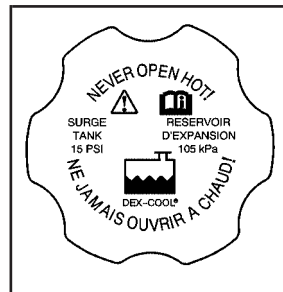

1. You can remove the radiator pressure cap when the cooling system, including the radiator pressure cap and upper radiator hose, is no longer hot.

Turn the pressure cap slowly counterclockwise until it first stops. Do not press down while turning the pressure cap. If you hear a hiss, wait for that to stop. A hiss means there is still some pressure left.

2. Then keep turning the pressure cap, but now push down as you turn it. Remove the pressure cap.

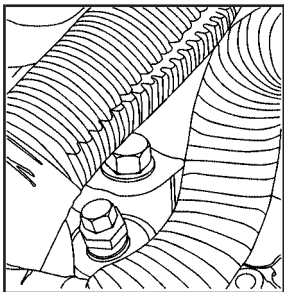

3. Open the coolant air bleed valve located on the thermostat housing, near the upper radiator hose.

See *Engine Compartment Overview* on page 5-12 for more information on location.

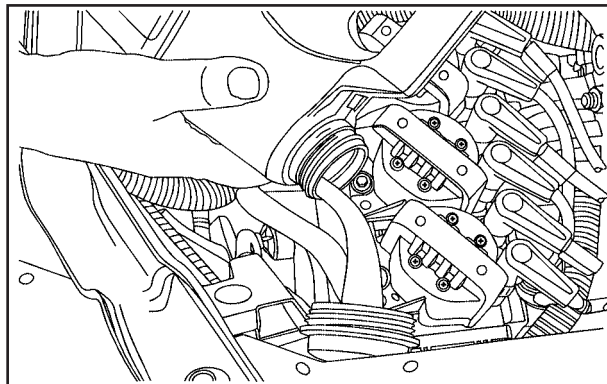

4. Fill the radiator with the proper DEX-COOL[®] coolant mixture, up to the base of the filler neck. See *Engine Coolant* on page 5-27 for more information about the proper coolant mixture.
If you see a stream of coolant coming from the air bleed valve, close the valve. Otherwise, close the valve after the radiator is filled.
5. Rinse or wipe any spilled coolant from the engine and the compartment.

6. Then fill the coolant recovery tank to the COLD FILL line.
7. Put the cap back on the coolant recovery tank, but leave the radiator pressure cap off.

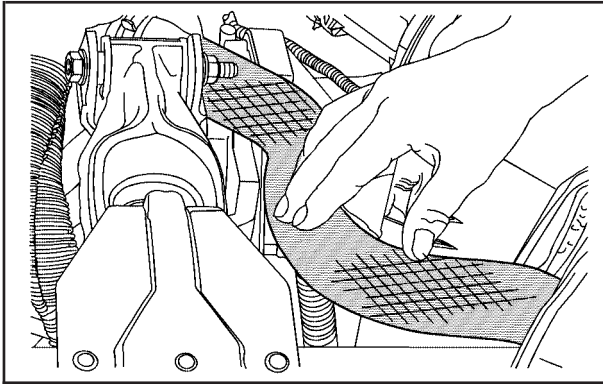

8. Start the engine and let it run until you can feel the upper radiator hose getting hot. Watch out for the engine cooling fans.
9. By this time, the coolant level inside the radiator filler neck may be lower. If the level is lower, add more of the proper DEX-COOL[®] coolant mixture through the filler neck until the level reaches the base of the filler neck.
10. Then replace the radiator pressure cap. At any time during this procedure if coolant begins to flow out of the filler neck, reinstall the pressure cap. Be sure the pressure cap is hand-tight and fully seated.
11. Check the coolant in the recovery tank. The level in the coolant recovery tank should be at the COLD FILL line when the engine is cold.

How to Add Coolant to the Cooling System (5.3L V8 Engine)

Notice: The engine has a specific cooling system drain and fill procedure. Failure to follow this procedure could cause the engine to overheat and be severely damaged. If the engine's cooling system needs to be drained and re-filled, please see the dealer/retailer.

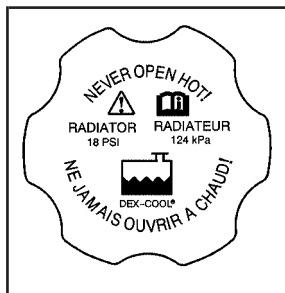

1. You can remove the pressure cap when the cooling system, including the pressure cap and upper radiator hose is no longer hot. Turn the pressure cap slowly counterclockwise.

If you hear a hiss, wait for that to stop. A hiss means that there is still some pressure left.

2. Then keep turning the pressure cap and remove it.

CAUTION:

You can be burned if you spill coolant on hot engine parts. Coolant contains ethylene glycol and it will burn if the engine parts are hot enough. Do not spill coolant on a hot engine.

3. Fill the cooling system with the proper DEX-COOL[®] coolant mixture, up to the base of the filler neck. See *Engine Coolant* on page 5-27 Engine Coolant for more information about the proper coolant mixture.
4. Rinse or wipe any spilled coolant from the engine and the compartment.

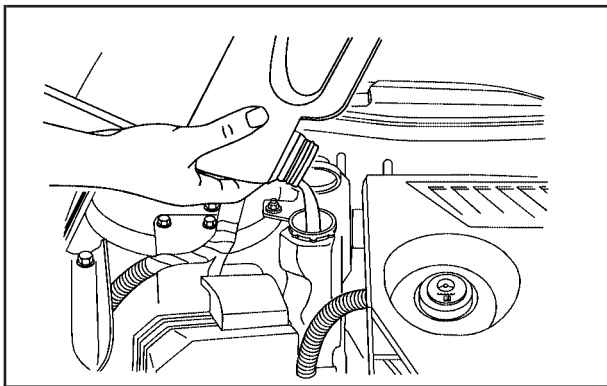

5. Then fill the coolant recovery tank to the COLD FILL line.
6. Install the coolant recovery tank cap and the pressure cap. After a day or two of driving, when the engine is cold, check the coolant level in the recovery tank. If it is low, refill it to the COLD FILL line.

If the coolant in the recovery tank is constantly low, you should have a dealer/retailer service department inspect the vehicle for leaks.

Power Steering Fluid

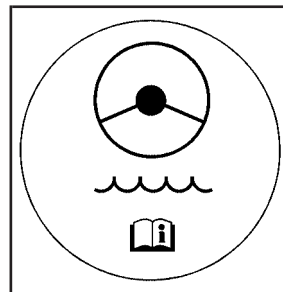

See *Engine Compartment Overview* on page 5-12 for reservoir location.

When to Check Power Steering Fluid

It is not necessary to regularly check power steering fluid unless you suspect there is a leak in the system or you hear an unusual noise. A fluid loss in this system could indicate a problem. Have the system inspected and repaired.

How to Check Power Steering Fluid

To check the power steering fluid, do the following:

1. Turn the key off and let the engine compartment cool down.
2. Wipe the cap and the top of the reservoir clean.
3. Unscrew the cap and wipe the dipstick with a clean rag.
4. Replace the cap and completely tighten it.
5. Remove the cap again and look at the fluid level on the dipstick.

If your vehicle has the 3.8L V6 engine or the 5.3L V8 engine, the fluid level should be between the ADD and HOT marks when the engine is cold, and at the HOT mark when the engine is hot. If the fluid is at the ADD mark when the engine is cold or hot, power steering fluid should be added.

If your vehicle has the 3.6L V6 engine, the fluid level should be between the Min (Minimum) and Max (Maximum) marks when the engine is cold, and at the Max mark when the engine is hot. If the fluid is at the Min mark when the engine is cold or hot, power steering fluid should be added.

What to Use

To determine what kind of fluid to use, see *Recommended Fluids and Lubricants on page 6-12*. Always use the proper fluid.

Notice: Use of the incorrect fluid may damage your vehicle and the damages may not be covered by your warranty. Always use the correct fluid listed in *Recommended Fluids and Lubricants on page 6-12*.

Windshield Washer Fluid

What to Use

When you need windshield washer fluid, be sure to read the manufacturer's instructions before use. If you will be operating your vehicle in an area where the temperature may fall below freezing, use a fluid that has sufficient protection against freezing.

Adding Washer Fluid

When the windshield washer fluid is low, a low washer fluid light may appear on the instrument panel cluster. See *Low Washer Fluid Warning Light on page 3-47* for more information.

In addition, if your vehicle has a Driver Information Center (DIC), the LOW WASHER FLUID message will display when the fluid level is low. See *DIC Warnings and Messages on page 3-58* for more information.

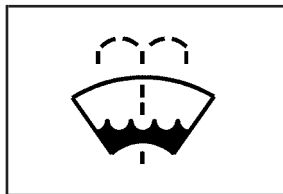

Open the cap with the washer symbol on it. Add washer fluid until the tank is full. See *Engine Compartment Overview on page 5-12* for reservoir location.

Notice:

- **When using concentrated washer fluid, follow the manufacturer's instructions for adding water.**
- **Do not mix water with ready-to-use washer fluid. Water can cause the solution to freeze and damage your washer fluid tank and other parts of the washer system. Also, water does not clean as well as washer fluid.**
- **Fill the washer fluid tank only three-quarters full when it is very cold. This allows for fluid expansion if freezing occurs, which could damage the tank if it is completely full.**
- **Do not use engine coolant (antifreeze) in your windshield washer. It can damage the vehicle's windshield washer system and paint.**

Brakes

Brake Fluid

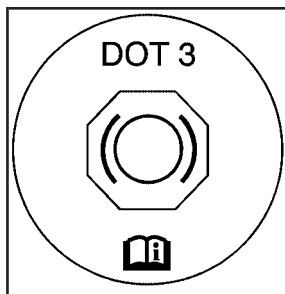

The brake master cylinder reservoir is filled with DOT-3 brake fluid. See *Engine Compartment Overview on page 5-12* for the location of the reservoir.

There are only two reasons why the brake fluid level in the reservoir might go down. The first is that the brake fluid goes down to an acceptable level during normal brake lining wear. When new linings are put in, the fluid level goes back up. The other reason is that fluid is leaking out of the brake hydraulic system. If it is, you should have the brake hydraulic system fixed, since a leak means that sooner or later the brakes will not work well.

It is not a good idea to top off the brake fluid. Adding brake fluid will not correct a leak. If fluid is added when the linings are worn, there will be too much fluid when

new brake linings are installed. Add or remove brake fluid, as necessary, only when work is done on the brake hydraulic system.

CAUTION:

If your vehicle has too much brake fluid, it can spill on the engine. The fluid will burn if the engine is hot enough. You or others could be burned, and your vehicle could be damaged. Add brake fluid only when work is done on the brake hydraulic system.

When the brake fluid falls to a low level, the brake warning light comes on. See *Brake System Warning Light on page 3-37*.

What to Add

When you need brake fluid, use only DOT-3 brake fluid. Use new brake fluid from a sealed container only. See *Recommended Fluids and Lubricants on page 6-12*.

Always clean the brake fluid reservoir cap and the area around the cap before removing it. This helps keep dirt from entering the reservoir.

CAUTION:

With the wrong kind of fluid in the brake hydraulic system, the brakes might not work well. This could cause a crash. Always use the proper brake fluid.

Notice:

- Using the wrong fluid can badly damage brake hydraulic system parts. For example, just a few drops of mineral-based oil, such as engine oil, in the brake hydraulic system can damage brake hydraulic system parts so badly that they will have to be replaced. Do not let someone put in the wrong kind of fluid.
- If you spill brake fluid on your vehicle's painted surfaces, the paint finish can be damaged. Be careful not to spill brake fluid on your vehicle. If you do, wash it off immediately. See *Washing Your Vehicle on page 5-102*.

Brake Wear

Your vehicle has disc brakes. Disc brake pads have built-in wear indicators that make a high-pitched warning sound when the brake pads are worn and new pads

are needed. The sound can come and go or be heard all the time your vehicle is moving, except when you are pushing on the brake pedal firmly.

CAUTION:

The brake wear warning sound means that soon the brakes will not work well. That could lead to an accident. When you hear the brake wear warning sound, have your vehicle serviced.

Notice: Continuing to drive with worn-out brake pads could result in costly brake repair.

Some driving conditions or climates can cause a brake squeal when the brakes are first applied or lightly applied. This does not mean something is wrong with the brakes.

Properly torqued wheel nuts are necessary to help prevent brake pulsation. When tires are rotated, inspect brake pads for wear and evenly tighten wheel nuts in the proper sequence to torque specifications in *Capacities and Specifications on page 5-116*.

Brake linings should always be replaced as complete axle sets.

Brake Pedal Travel

See your dealer/retailer if the brake pedal does not return to normal height, or if there is a rapid increase in pedal travel. This could be a sign that brake service might be required.

Brake Adjustment

Every time you apply the brakes, with or without the vehicle moving, the brakes adjust for wear.

Replacing Brake System Parts

The braking system on a vehicle is complex. Its many parts have to be of top quality and work well together if the vehicle is to have really good braking. Your vehicle was designed and tested with top-quality brake parts. When you replace parts of the braking system — for example, when the brake linings wear down and you need new ones put in — be sure you get new approved replacement parts. If you do not, the brakes might not work properly. For example, if someone puts in brake linings that are wrong for your vehicle, the balance between the front and rear brakes can change — for the worse. The braking performance you have come to expect can change in many other ways if someone puts in the wrong replacement brake parts.

Battery

Your vehicle has a maintenance free battery. When it is time for a new battery, see your dealer/retailer for one that has the replacement number shown on the original battery's label. See *Engine Compartment Overview on page 5-12* for battery location.

Warning: Battery posts, terminals, and related accessories contain lead and lead compounds, chemicals known to the State of California to cause cancer and reproductive harm. Wash hands after handling.

If the battery has a very low charge or is dead, you might not be able to remove the ignition key from the ignition switch or shift out of PARK (P). See *Shifting Out of PARK (P) on page 2-35*.

Vehicle Storage

CAUTION:

Batteries have acid that can burn you and gas that can explode. You can be badly hurt if you are not careful. See *Jump Starting on page 5-50* for tips on working around a battery without getting hurt.

Infrequent Usage: If you drive your vehicle infrequently, remove the black, negative (-) cable from the battery. This will help keep the battery from running down.

Extended Storage: For extended storage of your vehicle, remove the black, negative (-) cable from the battery or use a battery trickle charger. This will help maintain the charge of the battery over an extended period of time.

Jump Starting

If your vehicle's battery has run down, you may want to use another vehicle and some jumper cables to start your vehicle. Be sure to use the following steps to do it safely.

CAUTION:

Batteries can hurt you. They can be dangerous because:

- They contain acid that can burn you.
- They contain gas that can explode or ignite.
- They contain enough electricity to burn you.

If you do not follow these steps exactly, some or all of these things can hurt you.

Notice: Ignoring these steps could result in costly damage to your vehicle that would not be covered by your warranty.

Trying to start your vehicle by pushing or pulling it will not work, and it could damage your vehicle.

1. Check the other vehicle. It must have a 12-volt battery with a negative ground system.

Notice: If the other vehicle's system is not a 12-volt system with a negative ground, both vehicles can be damaged. Only use vehicles with 12-volt systems with negative grounds to jump start your vehicle.

2. Get the vehicles close enough so the jumper cables can reach, but be sure the vehicles are not touching each other. If they are, it could cause a ground connection you do not want. You would not be able to start your vehicle, and the bad grounding could damage the electrical systems.

To avoid the possibility of the vehicles rolling, set the parking brake firmly on both vehicles involved in the jump start procedure. Put an automatic transmission in PARK (P) or a manual transmission in NEUTRAL before setting the parking brake.

Notice: If you leave your radio or other accessories on during the jump starting procedure, they could be damaged. The repairs would not be covered by your warranty. Always turn off your radio and other accessories when jump starting your vehicle.

3. Turn off the ignition on both vehicles. Unplug unnecessary accessories plugged into the cigarette lighter or the accessory power outlets. Turn off the radio and all lamps that are not needed. This will avoid sparks and help save both batteries. And it could save the radio!
4. Open the hood on the other vehicle and locate the positive (+) and negative (-) terminal locations on that vehicle.

You will not use your vehicle's battery for jump starting. It has a remote positive (+) jump starting terminal, located on the underhood fuse block, for that purpose. See *Engine Compartment Overview* on page 5-12 for more information on location.

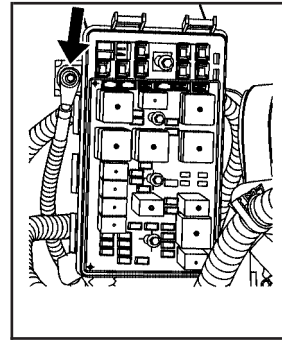

**3.8L V6 Engine shown,
3.6L V6 Engine
similar**

If your vehicle has a V6 engine, to uncover the remote positive (+) terminal, press the tab at the bottom of the fuse block and lift the cover up.

Always use the remote positive (+) terminal instead of the positive (+) terminal on the battery.

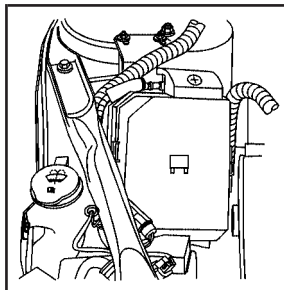

5.3L Engine

If your vehicle has the 5.3L V8 engine, to uncover the remote positive (+) terminal, remove the fuse block cover.

⚠ CAUTION:

An electric fan can start up even when the engine is not running and can injure you. Keep hands, clothing and tools away from any underhood electric fan.

⚠ CAUTION:

Fans or other moving engine parts can injure you badly. Keep your hands away from moving parts once the engine is running.

⚠ CAUTION:

Using a match near a battery can cause battery gas to explode. People have been hurt doing this, and some have been blinded. Use a flashlight if you need more light.

Be sure the battery has enough water. You do not need to add water to the battery installed in your new vehicle. But if a battery has fillercaps, be sure the right amount of fluid is there. If it is low, add water to take care of that first. If you do not, explosive gas could be present.

CAUTION: (Continued)

CAUTION: (Continued)

Battery fluid contains acid that can burn you. Do not get it on you. If you accidentally get it in your eyes or on your skin, flush the place with water and get medical help immediately.

5. Check that the jumper cables do not have loose or missing insulation. If they do, you could get a shock. The vehicles could be damaged too.

Before you connect the cables, here are some basic things you should know. Positive (+) will go to positive (+) or to a remote positive (+) terminal if the vehicle has one. Negative will go to a heavy, unpainted metal engine part or to a remote negative (-) terminal if the vehicle has one.

Notice: If you connect a negative cable to the Engine Control Module (ECM), ECM mounting bracket or any cables that attach to the ECM bracket, you may damage the ECM. Attach the negative cable to a heavy, unpainted metal engine part, other than the ECM, ECM bracket or cables attached to the ECM bracket.

Do not connect positive (+) to negative (-), or you will get a short that would damage the battery and maybe other parts too. And do not connect the negative (-) cable to the negative (-) terminal on the dead battery because this can cause sparks.

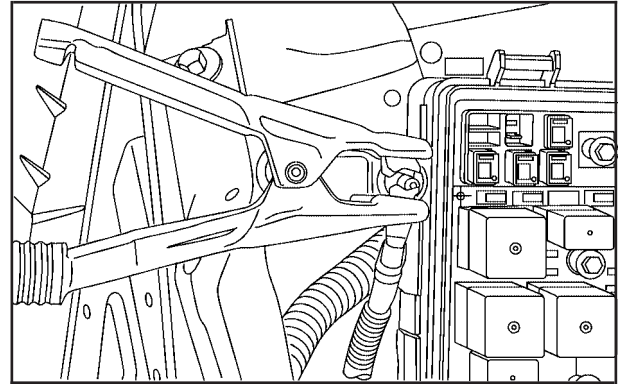

3.8L V6 Engine shown, 3.6L V6 Engine similar

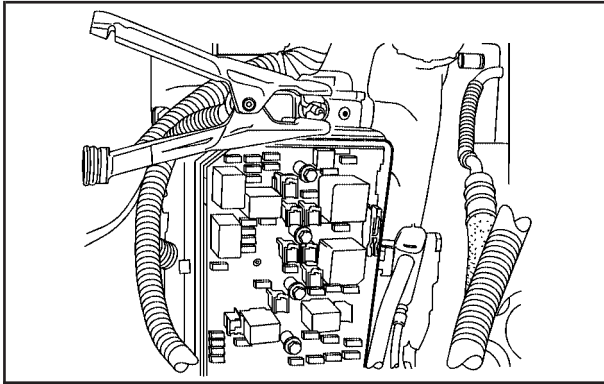

5.3L Engine

6. Connect the red positive (+) cable to the positive (+) terminal location on the vehicle with the dead battery. Use a remote positive (+) terminal if the vehicle has one.
7. Do not let the other end touch metal. Connect it to the positive (+) terminal location on the vehicle with the good battery. Use a remote positive (+) terminal if the vehicle has one.

8. Now connect the black negative (-) cable to the negative (-) terminal location on the vehicle with the good battery. Use a remote negative (-) terminal if the vehicle has one.

Do not let the other end touch anything until the next step. The other end of the negative (-) cable does not go to the dead battery. It goes to a heavy, unpainted metal engine part or to a remote negative (-) terminal on the vehicle with the dead battery.

9. Connect the other end of the negative (-) cable at least 18 inches (45 cm) away from the dead battery, but not near engine parts that move. The electrical connection is just as good there, and the chance of sparks getting back to the battery is much less.
10. Now start the vehicle with the good battery and run the engine for a while.
11. Try to start the vehicle that had the dead battery. If it will not start after a few tries, it probably needs service.

Notice: If the jumper cables are connected or removed in the wrong order, electrical shorting may occur and damage the vehicle. The repairs would not be covered by your warranty. Always connect and remove the jumper cables in the correct order, making sure that the cables do not touch each other or other metal.

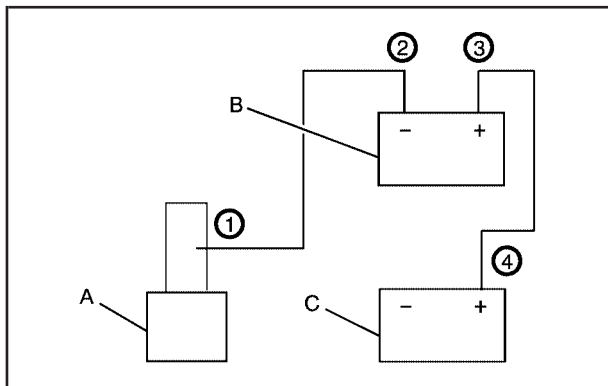

Jumper Cable Removal

- A. Heavy, Unpainted Metal Engine Part or Remote Negative (-) Terminal
- B. Good Battery or Remote Positive (+) and Remote Negative (-) Terminals
- C. Dead Battery or Remote Positive (+) Terminal

To disconnect the jumper cables from both vehicles, do the following:

1. Disconnect the black negative (-) cable from the vehicle that had the dead battery.
2. Disconnect the black negative (-) cable from the vehicle with the good battery.
3. Disconnect the red positive (+) cable from the vehicle with the good battery.
4. Disconnect the red positive (+) cable from the other vehicle.
5. Return the fuse block cover to its original position.

Headlamp Aiming

The vehicle has a visual optical headlamp aiming system. The aim has been preset at the factory and should need no further adjustment

However, if the vehicle is damaged in a crash, the headlamp aim may be affected and adjustment may be necessary.

If oncoming vehicles flash their high beams at you, this may also mean the vertical aim needs to be adjusted.

It is recommended that the vehicle is taken to your dealer/retailer for service if the headlamps need to be re-aimed. It is possible however, to re-aim the headlamps as described.

The vehicle should:

- Be placed so the headlamps are 25 ft. (7.6 m) from a light colored wall.
- Have all four tires on a perfectly level surface which is level all the way to the wall.
- Be placed so it is perpendicular to the wall.
- Not have any snow, ice or mud on it.
- Be fully assembled and all other work stopped while headlamp aiming is being done.
- Be normally loaded with a full tank of fuel and one person or 160 lbs (75 kg) on the driver seat.
- Have all tires properly inflated.

Headlamp aiming is done with the vehicle's low-beam headlamps. The high-beam headlamps will be correctly aimed if the low-beam headlamps are aimed properly.

Locate the vertical headlamp aiming screws under the hood near the headlamps.

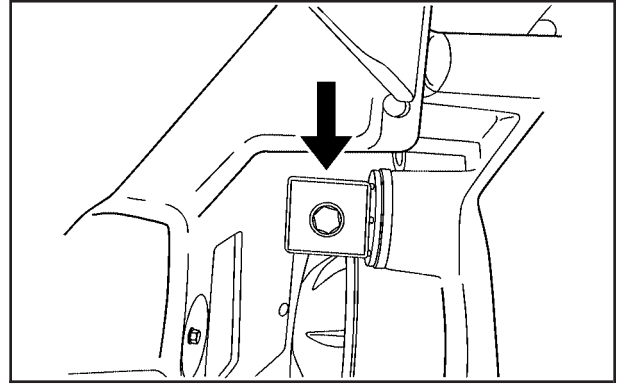

The adjustment screw can be turned with a 6 mm male hex.

To adjust the vertical aim on the headlamps:

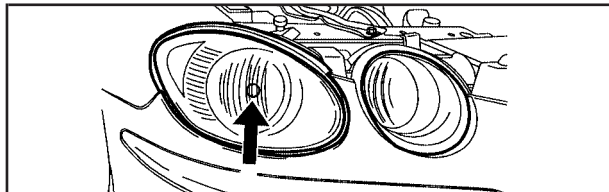

1. Open the hood. See *Hood Release* on page 5-11 for more information.
2. Locate the aim dot on the lens of the low-beam headlamp.
3. Measure the distance from the ground to the aim dot on the low-beam headlamp. Record the distance.

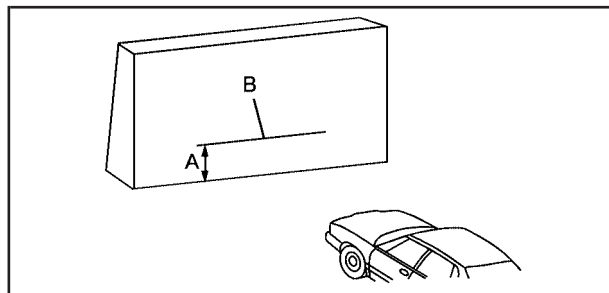

4. At the wall measure from the ground upward (A) to the recorded distance from Step 3 and mark it.

Notice: Do not cover a headlamp to improve beam cut-off when aiming. Covering a headlamp may cause excessive heat build-up which may cause damage to the headlamp.

5. Draw or tape a horizontal line (B) on the wall the width of the vehicle at the height of the mark in Step 4.
6. Turn on the low-beam headlamps and place a piece of cardboard or equivalent in front of the headlamp not being adjusted. Do not place directly on the headlamp. This allows only the beam of light from the headlamp being adjusted to be seen on the flat surface.

7. Locate the vertical headlamp aiming screws, which are under the hood near each headlamp assembly.

The adjustment screw can be turned with a 6 mm male hex.

8. Turn the vertical aiming screw until the headlamp beam is aimed to the horizontal tape line. Turn it clockwise or counterclockwise to raise or lower the angle of the beam.

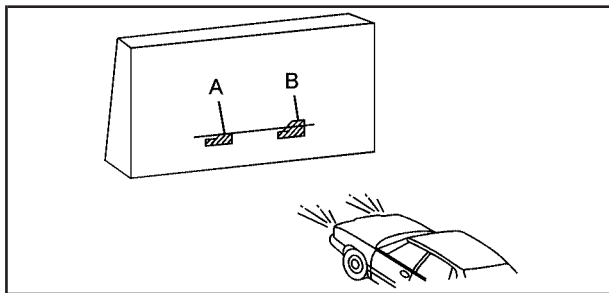

9. Make sure that the light from the headlamp is positioned at the bottom edge of the horizontal tape line. The lamp on the left (A) shows the correct headlamp aim. The lamp on the right (B) shows the incorrect headlamp aim.
10. Repeat Steps 7 through 9 for the opposite headlamp.

Bulb Replacement

For the proper type of replacement bulbs, see *Replacement Bulbs on page 5-61*.

For any bulb changing procedure not listed in this section, contact your dealer/retailer.

Halogen Bulbs

CAUTION:

Halogen bulbs have pressurized gas inside and can burst if you drop or scratch the bulb. You or others could be injured. Be sure to read and follow the instructions on the bulb package.

Taillamps, Turn Signal, Sidemarker, Stoplamps and Back-up Lamps

To replace a taillamp, turn signal, sidemarker, stoplamp or back-up lamp bulb:

1. Open the trunk. See *Trunk* on page 2-14 for more information.
2. Remove the convenience net if the vehicle has one.

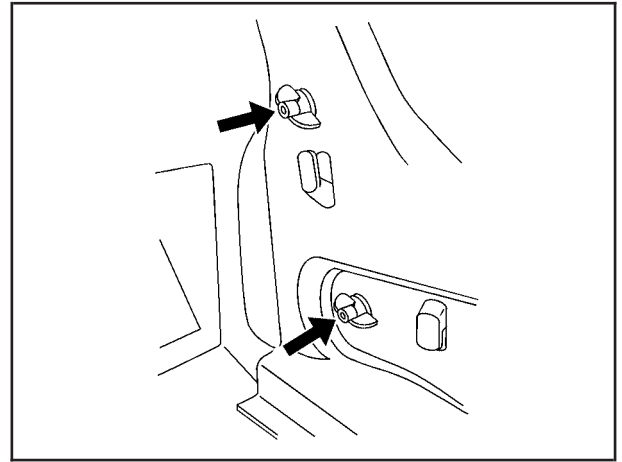

3. Remove the four plastic wing nuts retaining the trunk trim. There are two wing nuts located on the driver side (shown) and two located on the passenger side of the vehicle.
4. Pull back the trunk trim.

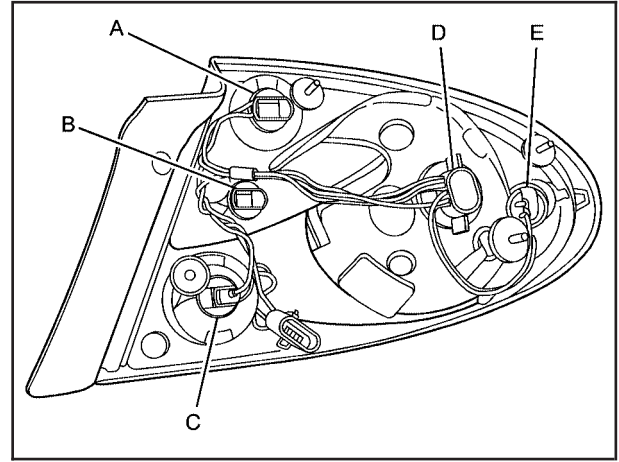
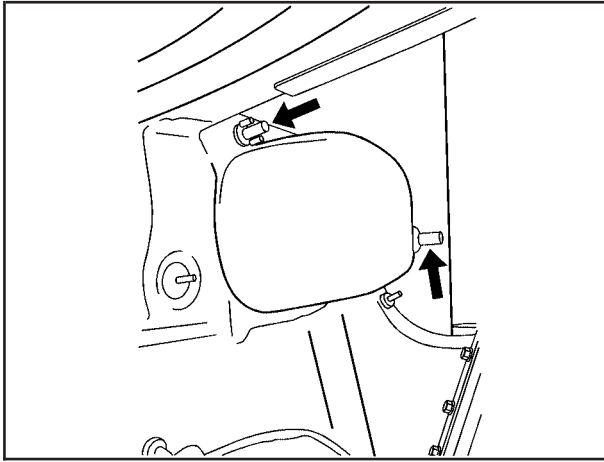

5. Remove the two wing nuts holding the taillamp assembly in place.
6. Pull out the taillamp assembly and disconnect the wiring harness.

- | | |
|-------------|----------------------------------|
| A. Taillamp | D. Stoplamp/Taillamp/Turn Signal |
| B. Back-up | E. Sidemarker |
| C. Taillamp | |
7. Turn the bulb socket counterclockwise to remove it.
 8. Replace with a new bulb.
 9. Turn the bulb socket clockwise to reinstall.
 10. Reverse these steps to reinstall the taillamp assembly.

License Plate Lamp

To replace one of these bulbs:

1. Remove the screws for either of the license plate lamps.

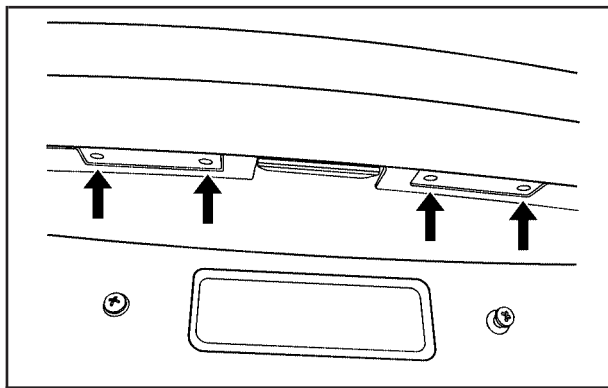

2. Turn and pull the license plate lamp forward through the fascia opening.

3. Turn the bulb socket counterclockwise and pull the bulb straight out of the socket.
4. Install the new bulb.
5. Reverse Steps 1 through 3 to reinstall the license plate lamp.

Replacement Bulbs

Exterior Lamps	Bulb Number
Back-Up Lamps	921
Rear Sidemarker, License Plate Lamp, and Taillamp	194
Stoplamps and Taillamps	3057

For replacement bulbs not listed here, contact your dealer/retailer.

Windshield Replacement

Your vehicle is equipped with an acoustic windshield. If you ever have to have your windshield replaced be sure to get an acoustic windshield so you will continue to have the benefits an acoustic windshield can provide.

Windshield Wiper Blade Replacement

Windshield wiper blades should be inspected for wear or cracking. See *Scheduled Maintenance on page 6-4* for more information on wiper blade inspection.

Replacement blades come in different types and are removed in different ways. For the proper type and length, see *Maintenance Replacement Parts on page 6-13*. Here is how to remove the wiper blade:

1. Pull the windshield wiper arm connector away from the windshield.

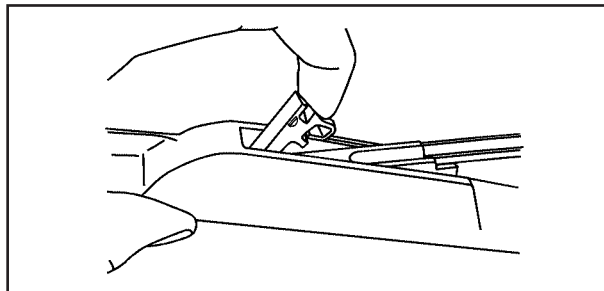

2. While holding the wiper arm, pull the clip up from the blade connecting point, and pull the blade assembly down toward the windshield to remove it from the wiper arm.
3. Install the new wiper blade onto the wiper arm and snap the clip into place.

Tires

Your new vehicle comes with high-quality tires made by a leading tire manufacturer. If you ever have questions about your tire warranty and where to obtain service, see your vehicle Warranty booklet for details.

CAUTION:

Poorly maintained and improperly used tires are dangerous.

- **Overloading your vehicle's tires can cause overheating as a result of too much flexing. You could have an air-out and a serious accident. See *Loading Your Vehicle on page 4-21.***
- **Underinflated tires pose the same danger as overloaded tires. The resulting accident could cause serious injury. Check all tires frequently to maintain the recommended pressure. Tire pressure should be checked when your vehicle's tires are cold. See *Inflation - Tire Pressure on page 5-70.***

CAUTION: (Continued)

CAUTION: (Continued)

- **Overinflated tires are more likely to be cut, punctured, or broken by a sudden impact — such as when you hit a pothole. Keep tires at the recommended pressure.**
- **Worn, old tires can cause accidents. If the tire's tread is badly worn, or if your vehicle's tires have been damaged, replace them.**

(G) Maximum Cold Inflation Load

Limit: Maximum load that can be carried and the maximum pressure needed to support that load.

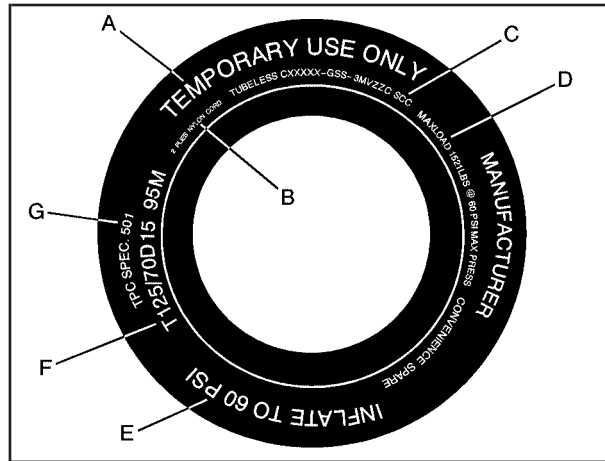

Compact Spare Tire Example

(A) Temporary Use Only: The compact spare tire or temporary use tire has a tread life of approximately 3,000 miles (5 000 km) and should not be driven at speeds over 65 mph (105 km/h). The compact spare tire is for emergency use when a regular road tire has lost air and gone flat. If your vehicle has a compact spare tire, see *Compact Spare Tire on page 5-98* and *If a Tire Goes Flat on page 5-86*.

(B) Tire Ply Material: The type of cord and number of plies in the sidewall and under the tread.

(C) Tire Identification Number (TIN): The letters and numbers following the DOT (Department of Transportation) code is the Tire Identification Number (TIN). The TIN shows the manufacturer and plant code, tire size, and date the tire was manufactured. The TIN is molded onto both sides of the tire, although only one side may have the date of manufacture.

(D) Maximum Cold Inflation Load

Limit: Maximum load that can be carried and the maximum pressure needed to support that load.

(E) Tire Inflation: The temporary use tire or compact spare tire should be inflated to 60 psi (420 kPa). For more information on tire pressure and inflation see *Inflation - Tire Pressure* on page 5-70.

(F) Tire Size : A combination of letters and numbers define a tire's width, height, aspect ratio, construction type, and service description. The letter T as the first character in the tire size means the tire is for temporary use only.

(G) TPC Spec (Tire Performance Criteria Specification): Original equipment tires designed to GM's specific tire performance criteria have a TPC specification code molded onto the sidewall. GM's TPC specifications meet or exceed all federal safety guidelines.

Tire Size

The following illustration shows an example of a typical passenger vehicle tire size.

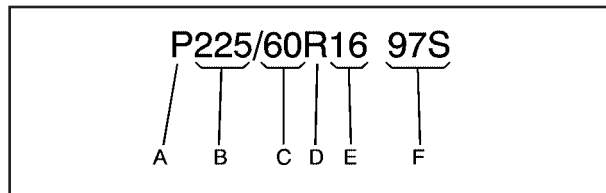

(A) Passenger (P-Metric) Tire: The United States version of a metric tire sizing system. The letter P as the first character in the tire size means a passenger vehicle tire engineered to standards set by the U.S. Tire and Rim Association.

(B) Tire Width: The three-digit number indicates the tire section width in millimeters from sidewall to sidewall.

(C) Aspect Ratio: A two-digit number that indicates the tire height-to-width measurements. For example, if the tire size aspect ratio is 60, as shown in item C of the illustration, it would mean that the tire's sidewall is 60 percent as high as it is wide.

(D) Construction Code: A letter code is used to indicate the type of ply construction in the tire. The letter R means radial ply construction; the letter D means diagonal or bias ply construction; and the letter B means belted-bias ply construction.

(E) Rim Diameter: Diameter of the wheel in inches.

(F) Service Description: These characters represent the load range and speed rating of the tire. The load index represents the load capacity a tire is certified to carry. The load index can range from 1 to 279. The speed rating is the maximum speed a tire is certified to carry a load. Speed ratings range from A to Z.

Tire Terminology and Definitions

Air Pressure: The amount of air inside the tire pressing outward on each square inch of the tire. Air pressure is expressed in pounds per square inch (psi) or kilopascal (kPa).

Accessory Weight: This means the combined weight of optional accessories. Some examples of optional accessories are, automatic transmission, power steering, power brakes, power windows, power seats, and air conditioning.

Aspect Ratio: The relationship of a tire's height to its width.

Belt: A rubber coated layer of cords that is located between the plies and the tread. Cords may be made from steel or other reinforcing materials.

Bead: The tire bead contains steel wires wrapped by steel cords that hold the tire onto the rim.

Bias Ply Tire: A pneumatic tire in which the plies are laid at alternate angles less than 90 degrees to the centerline of the tread.

Cold Tire Pressure: The amount of air pressure in a tire, measured in pounds per square inch (psi) or kilopascals (kPa) before a tire has built up heat from driving. See *Inflation - Tire Pressure on page 5-70*.

Curb Weight: The weight of a motor vehicle with standard and optional equipment including the maximum capacity of fuel, oil, and coolant, but without passengers and cargo.

DOT Markings: A code molded into the sidewall of a tire signifying that the tire is in compliance with the U.S. Department of Transportation (DOT) motor vehicle safety standards. The DOT code includes the Tire Identification Number (TIN), an alphanumeric designator which can also identify the tire manufacturer, production plant, brand, and date of production.

GVWR: Gross Vehicle Weight Rating. See *Loading Your Vehicle on page 4-21*.

GAWR FRT: Gross Axle Weight Rating for the front axle. See *Loading Your Vehicle on page 4-21*.

GAWR RR: Gross Axle Weight Rating for the rear axle. See *Loading Your Vehicle on page 4-21*.

Intended Outboard Sidewall: The side of an asymmetrical tire, that must always face outward when mounted on a vehicle.

Kilopascal (kPa): The metric unit for air pressure.

Light Truck (LT-Metric) Tire: A tire used on light duty trucks and some multipurpose passenger vehicles.

Load Index: An assigned number ranging from 1 to 279 that corresponds to the load carrying capacity of a tire.

Maximum Inflation Pressure: The maximum air pressure to which a cold tire can be inflated. The maximum air pressure is molded onto the sidewall.

Maximum Load Rating: The load rating for a tire at the maximum permissible inflation pressure for that tire.

Maximum Loaded Vehicle Weight: The sum of curb weight, accessory weight, vehicle capacity weight, and production options weight.

Normal Occupant Weight: The number of occupants a vehicle is designed to seat multiplied by 150 lbs (68 kg). See *Loading Your Vehicle on page 4-21*.

Occupant Distribution: Designated seating positions.

Outward Facing Sidewall: The side of an asymmetrical tire that has a particular side that faces outward when mounted on a vehicle. The side of the tire that contains a whitewall, bears white lettering, or bears manufacturer, brand, and/or model name molding that is higher or deeper than the same moldings on the other sidewall of the tire.

Passenger (P-Metric) Tire: A tire used on passenger cars and some light duty trucks and multipurpose vehicles.

Recommended Inflation Pressure: Vehicle manufacturer's recommended tire inflation pressure as shown on the tire placard. See *Inflation - Tire Pressure on page 5-70* and *Loading Your Vehicle on page 4-21*.

Radial Ply Tire: A pneumatic tire in which the ply cords that extend to the beads are laid at 90 degrees to the centerline of the tread.

Rim: A metal support for a tire and upon which the tire beads are seated.

Sidewall: The portion of a tire between the tread and the bead.

Speed Rating: An alphanumeric code assigned to a tire indicating the maximum speed at which a tire can operate.

Traction: The friction between the tire and the road surface. The amount of grip provided.

Tread: The portion of a tire that comes into contact with the road.

Treadwear Indicators: Narrow bands, sometimes called wear bars, that show across the tread of a tire when only 1/16 inch (1.6 mm) of tread remains. See *When It Is Time for New Tires on page 5-77*.

UTQGS (Uniform Tire Quality Grading Standards): A tire information system that provides consumers with ratings for a tire's traction, temperature, and treadwear. Ratings are determined by tire manufacturers using government testing procedures. The ratings are molded into the sidewall of the tire. See *Uniform Tire Quality Grading on page 5-80*.

Vehicle Capacity Weight: The number of designated seating positions multiplied by 150 lbs (68 kg) plus the rated cargo load. See *Loading Your Vehicle on page 4-21*.

Vehicle Maximum Load on the Tire: Load on an individual tire due to curb weight, accessory weight, occupant weight, and cargo weight.

Vehicle Placard: A label permanently attached to a vehicle showing the vehicle's capacity weight and the original equipment tire size and recommended inflation pressure. See "Tire and Loading Information Label" under *Loading Your Vehicle on page 4-21*.

Inflation - Tire Pressure

Tires need the correct amount of air pressure to operate effectively.

Notice: Do not let anyone tell you that under-inflation or over-inflation is all right. It is not. If your tires do not have enough air (under-inflation), you can get the following:

- Too much flexing
- Too much heat
- Tire overloading
- Premature or irregular wear
- Poor handling
- Reduced fuel economy

If your tires have too much air (over-inflation), you can get the following:

- Unusual wear
- Poor handling
- Rough ride
- Needless damage from road hazards

A vehicle specific Tire and Loading Information label is attached to your vehicle. This label shows your vehicle's original equipment tires and the correct inflation pressures for your tires when they are cold. The recommended cold tire inflation pressure, shown on the label, is the minimum amount of air pressure needed to support your vehicle's maximum load carrying capacity.

For additional information regarding how much weight your vehicle can carry, and an example of the Tire and Loading Information label, see *Loading Your Vehicle on page 4-21*. How you load your vehicle affects vehicle handling and ride comfort. Never load your vehicle with more weight than it was designed to carry.

When to Check

Check your tires once a month or more. Do not forget to check the compact spare tire, it should be at 60 psi (420 kPa). For additional information regarding the compact spare tire, see *Compact Spare Tire on page 5-98*.

How to Check

Use a good quality pocket-type gage to check tire pressure. You cannot tell if your tires are properly inflated simply by looking at them. Radial tires may look properly inflated even when they are under-inflated. Check the tire's inflation pressure when the tires are cold. Cold means your vehicle has been sitting for at least three hours or driven no more than 1 mile (1.6 km).

Remove the valve cap from the tire valve stem. Press the tire gage firmly onto the valve to get a pressure measurement. If the cold tire inflation pressure matches the recommended pressure on the Tire and Loading Information label, no further adjustment is necessary. If the inflation pressure is low, add air until you reach the recommended amount.

If you overfill the tire, release air by pushing on the metal stem in the center of the tire valve. Re-check the tire pressure with the tire gage.

Be sure to put the valve caps back on the valve stems. They help prevent leaks by keeping out dirt and moisture.

Tire Pressure Monitor System

The Tire Pressure Monitor System (TPMS) uses radio and sensor technology to check tire pressure levels. The TPMS sensors monitor the air pressure in your vehicle's tires and transmit tire pressure readings to a receiver located in the vehicle.

Each tire, including the spare (if provided), should be checked monthly when cold and inflated to the inflation pressure recommended by the vehicle manufacturer on the vehicle placard or tire inflation pressure label. (If your vehicle has tires of a different size than the size indicated on the vehicle placard or tire inflation pressure label, you should determine the proper tire inflation pressure for those tires.)

As an added safety feature, your vehicle has been equipped with a tire pressure monitoring system (TPMS) that illuminates a low tire pressure telltale when one or more of your tires is significantly under-inflated.

Accordingly, when the low tire pressure telltale illuminates, you should stop and check your tires as soon as possible, and inflate them to the proper pressure. Driving on a significantly under-inflated tire causes the tire to overheat and can lead to tire failure. Under-inflation also reduces fuel efficiency and tire tread life, and may affect the vehicle's handling and stopping ability.

Please note that the TPMS is not a substitute for proper tire maintenance, and it is the driver's responsibility to maintain correct tire pressure, even if under-inflation has not reached the level to trigger illumination of the TPMS low tire pressure telltale.

Your vehicle has also been equipped with a TPMS malfunction indicator to indicate when the system is not operating properly. The TPMS malfunction indicator is combined with the low tire pressure telltale. When the system detects a malfunction, the telltale will flash for approximately one minute and then remain continuously illuminated. This sequence will continue upon subsequent vehicle start-ups as long as the malfunction exists.

When the malfunction indicator is illuminated, the system may not be able to detect or signal low tire pressure as intended. TPMS malfunctions may occur for a variety of reasons, including the installation of replacement or alternate tires or wheels on the vehicle that prevent the TPMS from functioning properly. Always check the TPMS malfunction telltale after replacing one or more tires or wheels on your vehicle to ensure that the replacement or alternate tires and wheels allow the TPMS to continue to function properly.

See *Tire Pressure Monitor Operation on page 5-73*, for additional information.

Federal Communications Commission (FCC) and Industry and Science Canada

The Tire Pressure Monitor System (TPMS) operates on a radio frequency and complies with Part 15 of the FCC Rules. Operation is subject to the following two conditions:

1. This device may not cause harmful interference.
2. This device must accept any interference received, including interference that may cause undesired operation.

The Tire Pressure Monitor System (TPMS) operates on a radio frequency and complies with RSS-210 of Industry and Science Canada. Operation is subject to the following two conditions:

1. This device may not cause interference.
2. This device must accept any interference received, including interference that may cause undesired operation of the device.

Changes or modifications to this system by other than an authorized service facility could void authorization to use this equipment.

Tire Pressure Monitor Operation

The Tire Pressure Monitor System (TPMS) is designed to warn the driver when a low tire pressure condition exists. TPMS sensors are mounted onto each tire and wheel assembly, excluding the spare tire and wheel assembly. The TPMS sensors monitor the air pressure in the vehicle's tires and transmits the tire pressure readings to a receiver located in the vehicle.

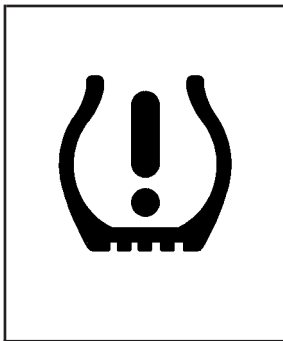

When a low tire pressure condition is detected, the TPMS illuminates the low tire pressure warning light located on the instrument panel cluster.

If your vehicle has the uplevel Driver Information Center (DIC), a warning message to check the pressure in a specific tire displays at the same time the low tire pressure warning light comes on. The low tire pressure warning light and the DIC warning message come on at each ignition cycle until the tires are inflated to the correct

inflation pressure. Vehicles that have the uplevel DIC buttons can also check tire pressure levels by pressing the gages button. For additional information and details about the DIC operation and displays see *DIC Operation and Displays on page 3-50* and *DIC Warnings and Messages on page 3-58*

The low tire pressure warning light may come on in cool weather when the vehicle is first started, and then turn off as you start to drive. This could be an early indicator that the air pressure in the tire(s) are getting low and need to be inflated to the proper pressure.

A Tire and Loading Information label, attached to your vehicle, shows the size of your vehicle's original equipment tires and the correct inflation pressure for your vehicle's tires when they are cold. See *Loading Your Vehicle on page 4-21*, for an example of the Tire and Loading Information label and its location on your vehicle. Also see *Inflation - Tire Pressure on page 5-70*.

Your vehicle's TPMS system can warn you about a low tire pressure condition but it does not replace normal tire maintenance. See *Tire Inspection and Rotation on page 5-75* and *Tires on page 5-63*.

Notice: Liquid tire sealants could damage the Tire Pressure Monitor System (TPMS) sensors. Sensor damage caused by using a tire sealant is not covered by your warranty. Do not use liquid tire sealants.

TPMS Malfunction Light and Message

The TPMS will not function properly if one or more of the TPMS sensors are missing or inoperable. When the system detects a malfunction, the low tire warning light flashes for about one minute and then stays on for the remainder of the ignition cycle. If your vehicle has the uplevel Driver Information Center (DIC), a DIC warning message is also displayed. The low tire warning light and DIC warning message come on at each ignition cycle until the problem is corrected. Some of the conditions that can cause the malfunction light and DIC message to come on are:

- One of the road tires has been replaced with the spare tire. The spare tire does not have a TPMS sensor. The TPMS malfunction light should go off once you re-install the road tire containing the TPMS sensor.
- The TPMS sensor matching process was started but not completed or not completed successfully after rotating the vehicle's tires. The TPMS malfunction light should go off once the TPMS sensor matching process is performed successfully. See "TPMS Sensor Matching Process" later in this section.
- One or more TPMS sensors are missing or damaged. The TPMS malfunction light should go off when the TPMS sensors are installed and the sensor matching process is performed successfully. See your dealer/retailer for service.

- Replacement tires or wheels do not match your vehicle's original equipment tires or wheels. Tires and wheels other than those recommended for your vehicle could prevent the TPMS from functioning properly. See *Buying New Tires on page 5-78*.
- Operating electronic devices or being near facilities using radio wave frequencies similar to the TPMS could cause the TPMS sensors to malfunction.

If the TPMS is not functioning it cannot detect or signal a low tire condition. See your dealer/retailer for service if the TPMS malfunction light comes on and stays on.

TPMS Sensor Matching Process

Each TPMS sensor has a unique identification code. Any time you replace one or more of the TPMS sensors or rotate the vehicle's tires, the identification codes need to be matched to the new tire/wheel position. The sensors are matched, to the tire/wheel positions, in the following order: driver side front tire, passenger side front tire, passenger side rear tire, and driver side rear tire using a TPMS diagnostic tool. See your dealer/retailer for service.

The TPMS sensors may also be matched to each tire/wheel position by increasing or decreasing the tire's air pressure. When increasing the tire's pressure, do not exceed the maximum inflation pressure indicated on the tire's sidewall.

To decrease the tire's air-pressure use the pointed end of the valve cap, a pencil-style air pressure gage, or a key.

You have two minutes to match each tire and wheel position. If it takes longer than two minutes to match any tire and wheel position, the matching process stops and you need to start over.

The TPMS sensor matching process is outlined below:

1. Set the parking brake.
2. Turn the ignition switch to ON/RUN with the engine off.
3. Press the Remote Keyless Entry (RKE) transmitter's LOCK and UNLOCK buttons at the same time for approximately five seconds. The horn sounds twice to signal the receiver is in relearn mode and the TPMS sensor matching process can begin.
4. Start with the driver side front tire.
5. Remove the valve cap from the tire's valve stem. Activate the TPMS sensor by increasing or decreasing the tire's air pressure for 10 seconds, or until a horn chirp sounds. The horn chirp, which may take up to 30 seconds to sound, confirms that the sensor identification code has been matched to the tire/wheel position.
6. Proceed to the passenger side front tire, and repeat the procedure in Step 5.
7. Proceed to the passenger side rear tire, and repeat the procedure in Step 5.
8. Proceed to the driver side rear tire, and repeat the procedure in Step 5.
9. After hearing the confirming horn chirp for the driver side rear tire, the horn chirps two more times to signal the tire learning process has ended. Turn the ignition switch to LOCK/OFF.
10. Set all four tires to the recommended air pressure level as indicated on the tire and loading information label.
11. Put the valve caps back on the valve stems.

Tire Inspection and Rotation

We recommend that you regularly inspect your vehicle's tires, including the spare tire, for signs of wear or damage. See *When It Is Time for New Tires* on page 5-77 for more information.

Tires should be rotated every 5,000 to 8,000 miles (8 000 to 13 000 km). See *Scheduled Maintenance* on page 6-4.

The purpose of a regular tire rotation is to achieve a uniform wear for all tires on the vehicle. This will ensure that your vehicle continues to perform most like it did when the tires were new.

Any time you notice unusual wear, rotate the tires as soon as possible and check wheel alignment. Also check for damaged tires or wheels. See *When It Is Time for New Tires on page 5-77* and *Wheel Replacement on page 5-82*.

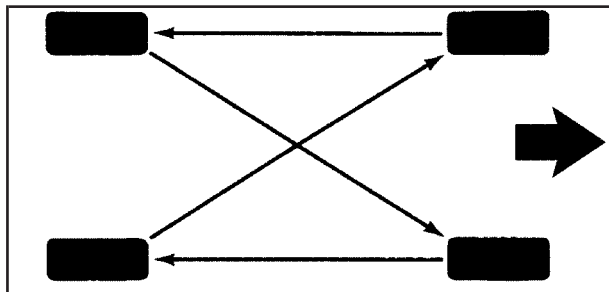

When rotating your vehicle's tires, always use the correct rotation pattern shown here.

Do not include the compact spare tire in the tire rotation.

After the tires have been rotated, adjust the front and rear inflation pressures as shown on the Tire and Loading Information label. See *Inflation - Tire Pressure on page 5-70* and *Loading Your Vehicle on page 4-21*.

Reset the Tire Pressure Monitor System. See *Tire Pressure Monitor Operation on page 5-73*.

Make certain that all wheel nuts are properly tightened. See "Wheel Nut Torque" under *Capacities and Specifications on page 5-116*.

CAUTION:

Rust or dirt on a wheel, or on the parts to which it is fastened, can make wheel nuts become loose after time. The wheel could come off and cause an accident. When you change a wheel, remove any rust or dirt from places where the wheel attaches to the vehicle. In an emergency, you can use a cloth or a paper towel to do this; but be sure to use a scraper or wire brush later, if needed, to get all the rust or dirt off. See *Changing a Flat Tire on page 5-87*.

When It Is Time for New Tires

Various factors, such as maintenance, temperatures, driving speeds, vehicle loading, and road conditions influence when you need new tires.

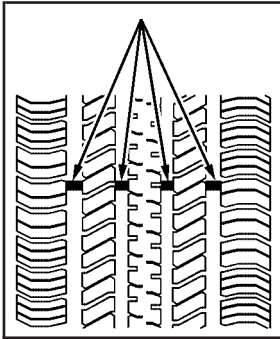

One way to tell when it is time for new tires is to check the treadwear indicators, which will appear when your tires have only 1/16 inch (1.6 mm) or less of tread remaining.

You need new tires if any of the following statements are true:

- You can see the indicators at three or more places around the tire.
- You can see cord or fabric showing through the tire's rubber.
- The tread or sidewall is cracked, cut, or snagged deep enough to show cord or fabric.
- The tire has a bump, bulge, or split.
- The tire has a puncture, cut, or other damage that cannot be repaired well because of the size or location of the damage.

The rubber in tires degrades over time, even if they are not being used. This is also true for the spare tire, if your vehicle has one. Multiple conditions affect how fast this aging takes place, including temperatures, loading conditions, and inflation pressure maintenance. With proper care and maintenance tires will typically wear out before they degrade due to age. If you are unsure about the need to replace your tires as they get older, consult the tire manufacturer for more information.

Buying New Tires

GM has developed and matched specific tires for your vehicle. The original equipment tires installed on your vehicle, when it was new, were designed to meet General Motors Tire Performance Criteria Specification (TPC Spec) system rating. If you need replacement tires, GM strongly recommends that you get tires with the same TPC Spec rating. This way, your vehicle will continue to have tires that are designed to give the same performance and vehicle safety, during normal use, as the original tires.

GM's exclusive TPC Spec system considers over a dozen critical specifications that impact the overall performance of your vehicle, including brake system performance, ride and handling, traction control, and tire pressure monitoring performance. GM's TPC Spec number is molded onto the tire's sidewall near the tire size. If the tires have an all-season tread design, the TPC Spec number will be followed by an MS for mud and snow. See *Tire Sidewall Labeling on page 5-64* for additional information.

GM recommends replacing tires in sets of four. This is because uniform tread depth on all tires will help keep your vehicle performing most like it did when the tires were new. Replacing less than a full set of tires can affect the braking and handling performance of your vehicle. See *Tire Inspection and Rotation on page 5-75* for information on proper tire rotation.

CAUTION:

Mixing tires could cause you to lose control while driving. If you mix tires of different sizes, brands, or types (radial and bias-belted tires), the vehicle may not handle properly, and you could have a crash. Using tires of different sizes, brands, or types may also cause damage to your vehicle. Be sure to use the correct size, brand, and type of tires on all wheels. It is all right to drive with your compact spare temporarily, as it was developed for use on your vehicle. See *Compact Spare Tire on page 5-98*.

 **CAUTION:**

If you use bias-ply tires on your vehicle, the wheel rim flanges could develop cracks after many miles of driving. A tire and/or wheel could fail suddenly, causing a crash. Use only radial-ply tires with the wheels on your vehicle.

If you must replace your vehicle's tires with those that do not have a TPC Spec number, make sure they are the same size, load range, speed rating, and construction type (radial and bias-belted tires) as your vehicle's original tires.

Vehicles that have a tire pressure monitoring system could give an inaccurate low-pressure warning if non-TPC Spec rated tires are installed on your vehicle. Non-TPC Spec rated tires may give a low-pressure warning that is higher or lower than the proper warning level you would get with TPC Spec rated tires. See *Tire Pressure Monitor System* on page 5-71.

Your vehicle's original equipment tires are listed on the Tire and Loading Information Label. See *Loading Your Vehicle* on page 4-21, for more information about the Tire and Loading Information Label and its location on your vehicle.

Different Size Tires and Wheels

If you add wheels or tires that are a different size than your original equipment wheels and tires, this may affect the way your vehicle performs, including its braking, ride and handling characteristics, stability, and resistance to rollover. Additionally, if your vehicle has electronic systems such as, anti-lock brakes, traction control, and electronic stability control, the performance of these systems can be affected.

CAUTION:

If you add different sized wheels, your vehicle may not provide an acceptable level of performance and safety if tires not recommended for those wheels are selected. You may increase the chance that you will crash and suffer serious injury. Only use GM specific wheel and tire systems developed for your vehicle, and have them properly installed by a GM certified technician.

See *Buying New Tires on page 5-78* and *Accessories and Modifications on page 5-3* for additional information.

Uniform Tire Quality Grading

Quality grades can be found where applicable on the tire sidewall between tread shoulder and maximum section width. For example:

Treadwear 200 Traction AA Temperature A

The following information relates to the system developed by the United States National Highway Traffic Safety Administration (NHTSA), which grades tires by treadwear, traction, and temperature performance. This applies only to vehicles sold in the United States. The grades are molded on the sidewalls of most passenger car tires. The Uniform Tire Quality Grading (UTQG) system does not apply to deep tread, winter-type snow tires, space-saver, or temporary use spare tires, tires with nominal rim diameters of 10 to 12 inches (25 to 30 cm), or to some limited-production tires.

While the tires available on General Motors passenger cars and light trucks may vary with respect to these grades, they must also conform to federal safety requirements and additional General Motors Tire Performance Criteria (TPC) standards.

Treadwear

The treadwear grade is a comparative rating based on the wear rate of the tire when tested under controlled conditions on a specified government test course. For example, a tire graded 150 would wear one and a half (1.5) times as well on the government course as a tire graded 100. The relative performance of tires depends upon the actual conditions of their use, however, and may depart significantly from the norm due to variations in driving habits, service practices, and differences in road characteristics and climate.

Traction – AA, A, B, C

The traction grades, from highest to lowest, are AA, A, B, and C. Those grades represent the tire's ability to stop on wet pavement as measured under controlled conditions on specified government test surfaces of asphalt and concrete. A tire marked C may have poor traction performance.

Warning: The traction grade assigned to this tire is based on straight-ahead braking traction tests, and does not include acceleration, cornering, hydroplaning, or peak traction characteristics.

Temperature – A, B, C

The temperature grades are A (the highest), B, and C, representing the tire's resistance to the generation of heat and its ability to dissipate heat when tested under controlled conditions on a specified indoor laboratory test wheel. Sustained high temperature can cause the material of the tire to degenerate and reduce tire life, and excessive temperature can lead to sudden tire failure. The grade C corresponds to a level of performance which all passenger car tires must meet under the Federal Motor Vehicle Safety Standard No. 109. Grades B and A represent higher levels of performance on the laboratory test wheel than the minimum required by law.

Warning: The temperature grade for this tire is established for a tire that is properly inflated and not overloaded. Excessive speed, underinflation, or excessive loading, either separately or in combination, can cause heat buildup and possible tire failure.

Wheel Alignment and Tire Balance

The tires and wheels on your vehicle were aligned and balanced carefully at the factory to give you the longest tire life and best overall performance. Adjustments to wheel alignment and tire balancing will not be necessary on a regular basis. However, if you notice unusual tire wear or your vehicle pulling to one side or the other, the alignment might need to be checked. If you notice your vehicle vibrating when driving on a smooth road, the tires and wheels might need to be rebalanced. See your dealer/retailer for proper diagnosis.

Wheel Replacement

Replace any wheel that is bent, cracked, or badly rusted or corroded. If wheel nuts keep coming loose, the wheel, wheel bolts, and wheel nuts should be replaced. If the wheel leaks air, replace it (except some aluminum wheels, which can sometimes be repaired). See your dealer/retailer if any of these conditions exist.

Your dealer/retailer will know the kind of wheel you need.

Each new wheel should have the same load-carrying capacity, diameter, width, offset, and be mounted the same way as the one it replaces.

If you need to replace any of your wheels, wheel bolts, wheel nuts, or Tire Pressure Monitor System (TPMS) sensors, replace them only with new GM original equipment parts. This way, you will be sure to have the right wheel, wheel bolts, wheel nuts, and TPMS sensors for your vehicle.

 **CAUTION:**

Using the wrong replacement wheels, wheel bolts, or wheel nuts on your vehicle can be dangerous. It could affect the braking and handling of your vehicle, make your tires lose air and make you lose control. You could have a collision in which you or others could be injured. Always use the correct wheel, wheel bolts, and wheel nuts for replacement.

Notice: The wrong wheel can also cause problems with bearing life, brake cooling, speedometer or odometer calibration, headlamp aim, bumper height, vehicle ground clearance, and tire or tire chain clearance to the body and chassis.

See *Changing a Flat Tire* on page 5-87 for more information.

Used Replacement Wheels

CAUTION:

Putting a used wheel on your vehicle is dangerous. You cannot know how it has been used or how far it has been driven. It could fail suddenly and cause a crash. If you have to replace a wheel, use a new GM original equipment wheel.

Tire Chains

CAUTION:

If your vehicle has P225/55R17 or P235/50R18 size tires, do not use tire chains, there is not enough clearance.

Tire chains used on a vehicle without the proper amount of clearance can cause damage to the brakes, suspension or other vehicle parts. The area damaged by the tire chains could cause you to lose control of your vehicle and you or others may be injured in a crash.

CAUTION: (Continued)

CAUTION: (Continued)

Use another type of traction device only if its manufacturer recommends it for use on your vehicle and tire size combination and road conditions. Follow that manufacturer's instructions. To help avoid damage to your vehicle, drive slowly, readjust or remove the device if it is contacting your vehicle, and do not spin your wheels.

If you do find traction devices that will fit, install them on the front tires.

Notice: If your vehicle has a tire size other than P225/55R17 or P235/50R18 size tires, use tire chains only where legal and only when you must. Use only SAE Class "S" type chains that are the proper size for your tires. Install them on the front tires and tighten them as tightly as possible with the ends securely fastened. Drive slowly and follow the chain manufacturer's instructions. If you can hear the chains contacting your vehicle, stop and retighten them. If the contact continues, slow down until it stops. Driving too fast or spinning the wheels with chains on will damage your vehicle.

If a Tire Goes Flat

It is unusual for a tire to blowout while you are driving, especially if you maintain your vehicle's tires properly. If air goes out of a tire, it is much more likely to leak out slowly. But if you should ever have a blowout, here are a few tips about what to expect and what to do:

If a front tire fails, the flat tire creates a drag that pulls the vehicle toward that side. Take your foot off the accelerator pedal and grip the steering wheel firmly. Steer to maintain lane position, and then gently brake to a stop well out of the traffic lane.

A rear blowout, particularly on a curve, acts much like a skid and may require the same correction you would use in a skid. In any rear blowout remove your foot from the accelerator pedal. Get the vehicle under control by steering the way you want the vehicle to go. It may be very bumpy and noisy, but you can still steer. Gently brake to a stop, well off the road if possible.

CAUTION:

Lifting a vehicle and getting under it to do maintenance or repairs is dangerous without the appropriate safety equipment and training. The jack provided with your vehicle is designed only for changing a flat tire. If it is used for anything else, you or others could be badly injured or killed if the vehicle slips off the jack. Use the jack provided with your vehicle only for changing a flat tire.

If a tire goes flat, the next part shows how to use the jacking equipment to change a flat tire safely.

Changing a Flat Tire

If a tire goes flat, avoid further tire and wheel damage by driving slowly to a level place. Turn on your vehicle's hazard warning flashers. See *Hazard Warning Flashers* on page 3-6 for more information.

CAUTION:

Changing a tire can be dangerous. The vehicle can slip off the jack and roll over or fall on you or other people. You and they could be badly injured or even killed. Find a level place to change your tire. To help prevent the vehicle from moving:

1. Set the parking brake firmly.
2. Put the shift lever in PARK (P).
3. Turn off the engine and do not restart while the vehicle is raised.
4. Do not allow passengers to remain in the vehicle.

CAUTION: (Continued)

CAUTION: (Continued)

To be even more certain the vehicle will not move, you should put blocks at the front and rear of the tire farthest away from the one being changed. That would be the tire, on the other side, at the opposite end of the vehicle.

When your vehicle has a flat tire, use the following example as a guide to assist you in the placement of wheel blocks.

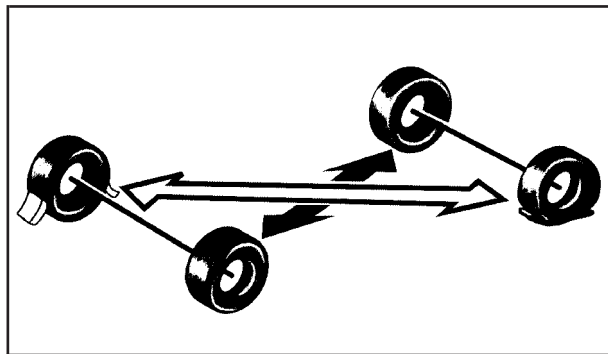

The following information tells you how to use the jack and change a tire.

Removing the Spare Tire and Tools

The equipment you will need is located in the trunk.

1. Open the trunk. See *Trunk* on page 2-14 for more information.
2. Remove the convenience net if the vehicle has one.
3. Remove the spare tire cover.

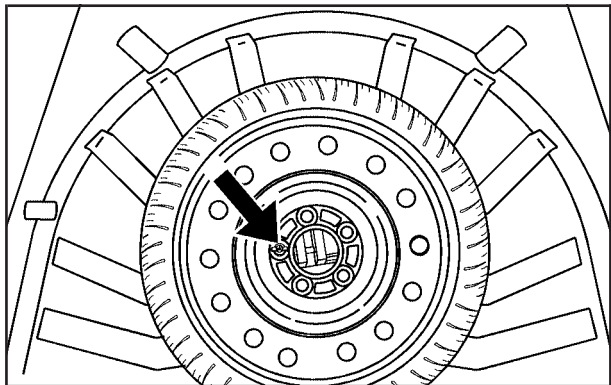

4. Turn the wing nut counterclockwise and remove it.
5. Remove the compact spare tire.

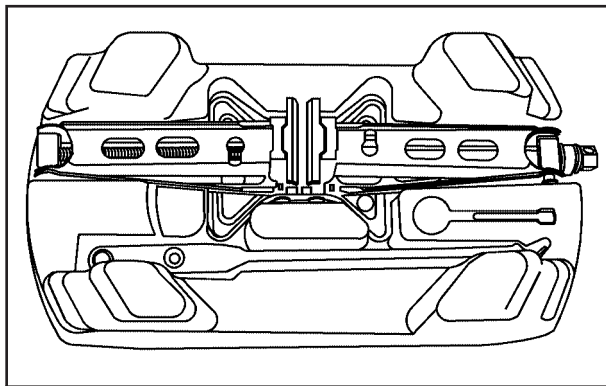

6. Turn the nut holding the jack counterclockwise and remove it. Then remove the jack and wrench.

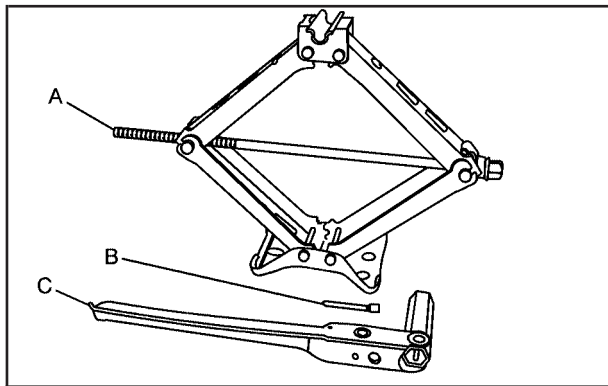

The tools you will need to change a tire include the jack (A), extension and protection guide (B), and wheel wrench (C).

Removing the Flat Tire and Installing the Spare Tire

Your vehicle may have wheels with exposed wheel nuts. If so, go to the Removing the Wheel Nuts section. If the vehicle has steel wheel covers with plastic nut caps, the wheel nuts are hidden behind the cap. To remove the wheel cover:

1. Do a safety check before proceeding. See *Changing a Flat Tire on page 5-87* for more information.
2. Use the wheel wrench to loosen the plastic wheel nut caps in a counterclockwise direction.

If needed, finish loosening them by hand. The nut caps will not come off of the wheel cover.

The edge of the wheel cover could be sharp, so do not try to remove the cover with your bare hands. Do not drop the cap or lay it face down, as it could become scratched or damaged.

Store the wheel cover in the trunk until you have the flat tire repaired or replaced.

Once you have removed the wheel cover or plastic nut caps, use the following procedure to remove the flat tire and install the spare tire.

Removing the Wheel Nuts

1. Place the wheel wrench securely over the wheel nut. Turn the wheel wrench counterclockwise to loosen all the wheel nuts, but do not remove them yet.
2. Turn the jack handle clockwise to raise the jack lift head.

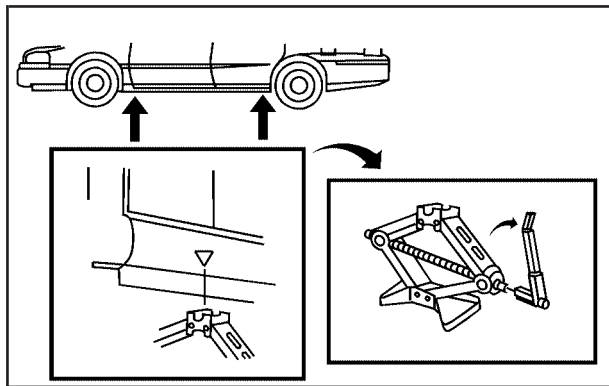

3. Find the jacking location using the diagram above and corresponding triangular-shaped hoisting notches located on the underside of the vehicle's plastic molding.

The front location is about 6.5 inches (16.5 cm) from the rear edge of the front wheel well. The rear location is about 9 inches (22.8 cm) from the front edge of the rear wheel well.

CAUTION:

Getting under a vehicle when it is jacked up is dangerous. If the vehicle slips off the jack you could be badly injured or killed. Never get under a vehicle when it is supported only by a jack.

CAUTION:

Raising your vehicle with the jack improperly positioned can damage the vehicle and even make the vehicle fall. To help avoid personal injury and vehicle damage, be sure to fit the jack lift head into the proper location before raising the vehicle.

4. Put the compact spare tire near you.

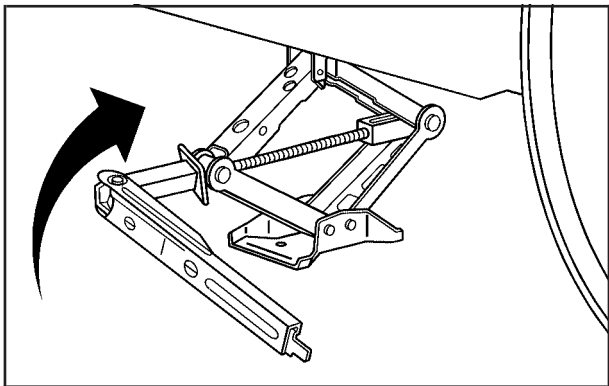

5. Raise the vehicle by turning the jack handle clockwise. Raise the vehicle far enough off the ground for the compact spare tire to fit under the vehicle.

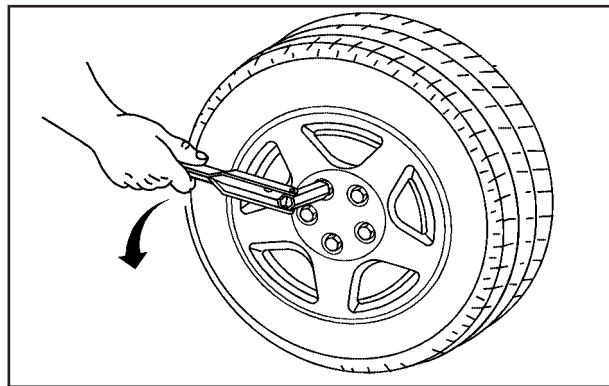

6. Remove all wheel nuts and take off the flat tire.

⚠ CAUTION:

Rust or dirt on a wheel, or on the parts to which it is fastened, can make wheel nuts become loose after time. The wheel could come off and cause an accident. When you change a wheel, remove any rust or dirt from places where the wheel attaches to the vehicle. In an emergency, you can use a cloth or a paper towel to do this; but be sure to use a scraper or wire brush later, if needed, to get all the rust or dirt off. See *Changing a Flat Tire on page 5-87*.

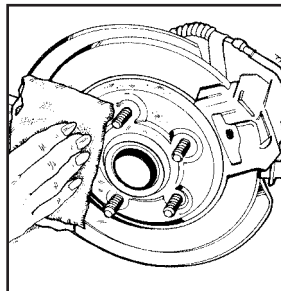

7. Remove any rust or dirt from the wheel bolts, mounting surfaces, and spare wheel.

8. Install the compact spare tire.

⚠ CAUTION:

Never use oil or grease on studs or nuts. Because the nuts might come loose. The vehicle's wheel could fall off, causing a crash.

- Put the wheel nuts back on with the rounded end of the nuts toward the wheel. Tighten each nut by hand until the wheel is held against the hub.

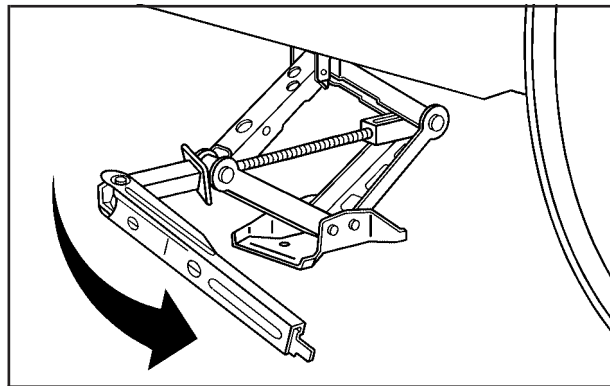

- Lower the vehicle by turning the jack handle counterclockwise. Lower the jack completely.

⚠ CAUTION:

Incorrect or improperly tightened wheel nuts can cause the wheel to come loose and even come off. This could lead to a crash. If you have to replace them, be sure to get new original equipment wheel nuts. Stop somewhere as soon as you can and have the nuts tightened with a torque wrench to the proper torque specification. See *Capacities and Specifications* on page 5-116 for wheel nut torque specification.

Notice: Improperly tightened wheel nuts can lead to brake pulsation and rotor damage. To avoid expensive brake repairs, evenly tighten the wheel nuts in the proper sequence and to the proper torque specification. See *Capacities and Specifications* on page 5-116 for the wheel nut torque specification.

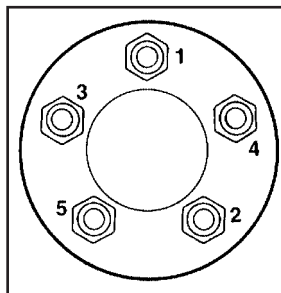

11. Tighten the wheel nuts firmly in a crisscross sequence as shown.

Notice: Wheel covers will not fit on your vehicle's compact spare. If you try to put a wheel cover on the compact spare, the cover or the spare could be damaged.

Storing a Flat or Spare Tire and Tools (Base Model)

CAUTION:

Storing a jack, a tire, or other equipment in the passenger compartment of the vehicle could cause injury. In a sudden stop or collision, loose equipment could strike someone. Store all these in the proper place.

After the compact spare tire has been installed on the vehicle, store the flat tire in the trunk.

When storing a full-size tire, use the extension with the extension protector, located in the foam holder, to help avoid wheel surface damage.

To store a full-size tire:

1. Install the tools in their original location in the trunk area and secure.
2. Place the tire valve stem facing down and the protector/guide placed through a wheel bolt hole.
3. Remove the protector and attach the retainer securely
4. Store the cover as far forward as possible.

When storing a compact spare tire in the trunk, put the protector back in the foam holder.

The compact spare is for temporary use only. Replace the compact spare tire with a full-size tire as soon as you can. See *Compact Spare Tire on page 5-98*. Use this as a guide for storing the compact spare tire and tools.

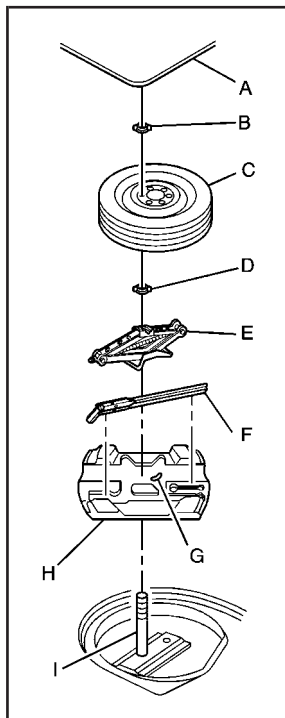

Compact Spare Tire

- A. Cover
- B. Retainer
- C. Compact Spare Tire
- D. Wing Nut
- E. Jack
- F. Wheel Wrench
- G. Extension Protector
- H. Foam Holder
- I. Bolt Screw

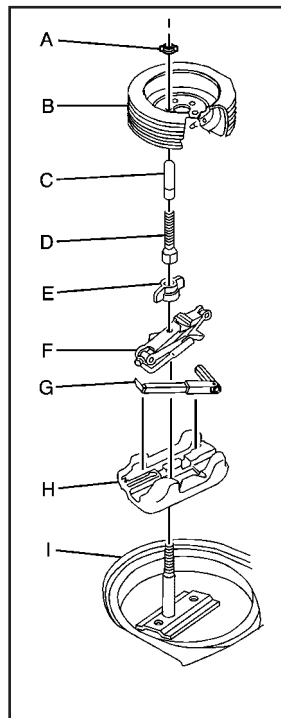

Full-Size Flat Tire

- A. Retainer
- B. Full-Size Flat Tire
- C. Protective Guide
- D. Extension Bolt Screw
- E. Wing Nut
- F. Jack
- G. Wheel Wrench
- H. Foam Holder
- I. Bolt Screw

Storing a Flat or Spare Tire and Tools (Super Only)

Super Model

CAUTION:

Storing a jack, a tire, or other equipment in the passenger compartment of the vehicle could cause injury. In a sudden stop or collision, loose equipment could strike someone. Store all these in the proper place.

After the compact spare tire has been installed on the vehicle, store the flat tire in the trunk.

When storing a full-size tire, use the extension with the protector, located in the foam holder, to help avoid wheel surface damage.

To store a full-size tire:

1. Install the tools in their original location in the trunk area and secure.
2. Place the tire valve stem facing down and the protector/guide placed through a wheel bolt hole.

3. Remove the protector and attach the retainer securely
4. Store the cover as far forward as possible.

When storing a compact spare tire in the trunk, put the protector back in the foam holder. When storing the compact spare tire, the tire must be stored valve stem down.

The compact spare is for temporary use only. Replace the compact spare tire with a full-size tire as soon as you can. See *Compact Spare Tire* on page 5-98. Use this as a guide for storing the compact spare tire and tools.

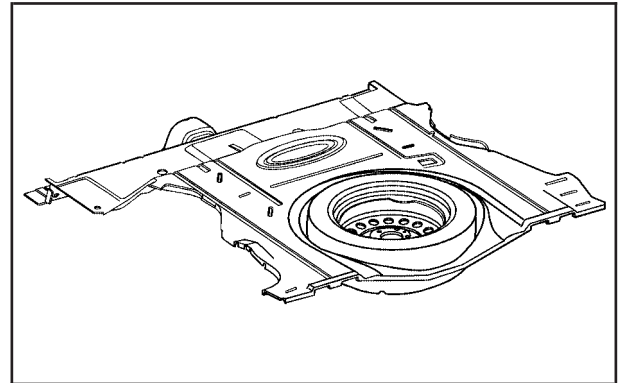

Compact Spare Tire

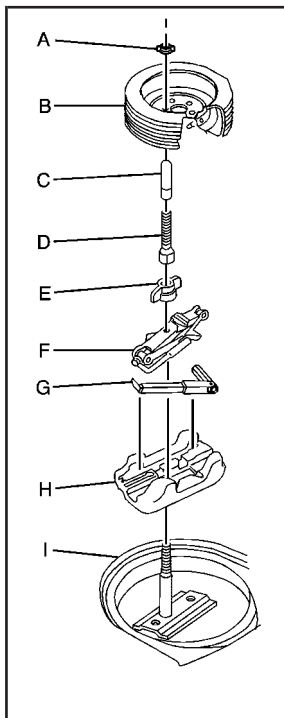

Full-Size Flat Tire

- A. Retainer
- B. Full-Size Flat Tire
- C. Protective Guide
- D. Extension Bolt Screw
- E. Wing Nut
- F. Jack
- G. Wheel Wrench
- H. Foam Holder
- I. Bolt Screw

Compact Spare Tire

Although the compact spare tire was fully inflated when the vehicle was new, it can lose air after a time. Check the inflation pressure regularly. It should be 60 psi (420 kPa).

After installing the compact spare on the vehicle, stop as soon as possible and make sure the spare tire is correctly inflated. The compact spare is made to perform well at speeds up to 65 mph (105 km/h) for distances up to 3,000 miles (5 000 km), so you can finish your trip and have the full-size tire repaired or replaced at your convenience. Of course, it is best to replace the spare with a full-size tire as soon as possible. The spare tire will last longer and be in good shape in case it is needed again.

Notice: When the compact spare is installed, do not take your vehicle through an automatic car wash with guide rails. The compact spare can get caught on the rails. That can damage the tire and wheel, and maybe other parts of your vehicle.

Do not use the compact spare on other vehicles.

And do not mix the compact spare tire or wheel with other wheels or tires. They will not fit. Keep the spare tire and its wheel together.

Notice: Tire chains will not fit your compact spare. Using them can damage your vehicle and can damage the chains too. Do not use tire chains on your compact spare.

Appearance Care

Interior Cleaning

Your vehicle's interior will continue to look its best if it is cleaned often. Although not always visible, dust and dirt can accumulate on your upholstery. Dirt can damage carpet, fabric, leather, and plastic surfaces. Regular vacuuming is recommended to remove particles from your upholstery. It is important to keep your upholstery from becoming and remaining heavily soiled. Soils should be removed as quickly as possible. Your vehicle's interior may experience extremes of heat that could cause stains to set rapidly.

Lighter colored interiors may require more frequent cleaning. Use care because newspapers and garments that transfer color to your home furnishings may also transfer color to your vehicle's interior.

When cleaning your vehicle's interior, only use cleaners specifically designed for the surfaces being cleaned. Permanent damage may result from using cleaners on surfaces for which they were not intended. Use glass cleaner only on glass. Remove any accidental over-spray from other surfaces immediately. To prevent over-spray, apply cleaner directly to the cleaning cloth.

Notice: If you use abrasive cleaners when cleaning glass surfaces on your vehicle, you could scratch the glass and/or cause damage to the rear window defogger. When cleaning the glass on your vehicle, use only a soft cloth and glass cleaner.

Many cleaners contain solvents that may become concentrated in your vehicle's breathing space. Before using cleaners, read and adhere to all safety instructions on the label. While cleaning your vehicle's interior, maintain adequate ventilation by opening your vehicle's doors and windows.

Dust may be removed from small buttons and knobs using a small brush with soft bristles.

Your dealer/retailer has a product for cleaning your vehicle's glass. Should it become necessary, you can also obtain a product from your dealer/retailer to remove odors from your vehicle's upholstery.

Do not clean your vehicle using the following cleaners or techniques:

- Never use a knife or any other sharp object to remove a soil from any interior surface.
- Never use a stiff brush. It can cause damage to your vehicle's interior surfaces.
- Never apply heavy pressure or rub aggressively with a cleaning cloth. Use of heavy pressure can damage your interior and does not improve the effectiveness of soil removal.
- Use only mild, neutral-pH soaps. Avoid laundry detergents or dishwashing soaps with degreasers. Using too much soap will leave a residue that leaves streaks and attracts dirt. For liquid cleaners, about 20 drops per gallon (3.78 L) of water is a good guide.
- Do not heavily saturate your upholstery while cleaning.
- Damage to your vehicle's interior may result from the use of many organic solvents such as naphtha, alcohol, etc.

Fabric/Carpet

Use a vacuum cleaner with a soft brush attachment frequently to remove dust and loose dirt. A canister vacuum with a beater bar in the nozzle may only be used on floor carpet and carpeted floor mats. For soils, always try to remove them first with plain water or club soda. Before cleaning, gently remove as much of the soil as possible using one of the following techniques:

- For liquids: gently blot the remaining soil with a paper towel. Allow the soil to absorb into the paper towel until no more can be removed.
- For solid dry soils: remove as much as possible and then vacuum.

To clean, use the following instructions:

1. Saturate a lint-free, clean white cloth with water or club soda.
2. Wring the cloth to remove excess moisture.
3. Start on the outside edge of the soil and gently rub toward the center. Continue cleaning, using a clean area of the cloth each time it becomes soiled.
4. Continue to gently rub the soiled area until the cleaning cloth remains clean.
5. If the soil is not completely removed, use a mild soap solution and repeat the cleaning process that was used with plain water.

If any of the soil remains, a commercial fabric cleaner or spot lifter may be necessary. When a commercial upholstery cleaner or spot lifter is to be used, test a small hidden area for colorfastness first. If the locally cleaned area gives any impression that a ring formation may result, clean the entire surface.

After the cleaning process has been completed, a paper towel can be used to blot excess moisture from the fabric or carpet.

Leather

A soft cloth dampened with water can be used to remove dust. If a more thorough cleaning is necessary, a soft cloth dampened with a mild soap solution can be used. Allow the leather to dry naturally. Do not use heat to dry. Never use steam to clean leather. Never use spot lifters or spot removers on leather. Many commercial leather cleaners and coatings that are sold to preserve and protect leather may permanently change the appearance and feel of your leather and are not recommended. Do not use silicone or wax-based products, or those containing organic solvents to clean your vehicle's interior because they can alter the appearance by increasing the gloss in a non-uniform manner. Never use shoe polish on leather.

Instrument Panel, Vinyl, and Other Plastic Surfaces

A soft cloth dampened with water may be used to remove dust. If a more thorough cleaning is necessary, a clean soft cloth dampened with a mild soap solution can be used to gently remove dust and dirt. Never use spot lifters or removers on plastic surfaces. Many commercial cleaners and coatings that are sold to preserve and protect soft plastic surfaces may permanently change the appearance and feel of your interior and are not recommended. Do not use silicone or wax-based products, or those containing organic solvents to clean your vehicle's interior because they can alter the appearance by increasing the gloss in a non-uniform manner.

Some commercial products may increase gloss on your instrument panel. The increase in gloss may cause annoying reflections in the windshield and even make it difficult to see through the windshield under certain conditions.

Care of Safety Belts

Keep belts clean and dry.

CAUTION:

Do not bleach or dye safety belts. If you do, it may severely weaken them. In a crash, they might not be able to provide adequate protection. Clean safety belts only with mild soap and lukewarm water.

Weatherstrips

Silicone grease on weatherstrips will make them last longer, seal better, and not stick or squeak. Apply silicone grease with a clean cloth. During very cold, damp weather frequent application may be required. See *Recommended Fluids and Lubricants* on page 6-12.

Washing Your Vehicle

The best way to preserve your vehicle's finish is to keep it clean by washing it often.

Notice: Certain cleaners contain chemicals that can damage the emblems or nameplates on your vehicle. Check the cleaning product label. If it states that it should not be used on plastic parts, do not use it on your vehicle or damage may occur and it would not be covered by the warranty.

Do not wash the vehicle in direct sunlight. Use a car washing soap. Do not use cleaning agents that are petroleum based or that contain acid or abrasives, as they can damage the paint, metal or plastic on your vehicle. Approved cleaning products can be obtained from your dealer/retailer. See *Vehicle Care/Appearance Materials* on page 5-106. Follow all manufacturers' directions regarding correct product usage, necessary safety precautions and appropriate disposal of any vehicle care product.

Rinse the vehicle well, before washing and after to remove all cleaning agents completely. If they are allowed to dry on the surface, they could stain.

Dry the finish with a soft, clean chamois or an all-cotton towel to avoid surface scratches and water spotting.

High pressure car washes may cause water to enter the vehicle. Avoid using high pressure washes closer than 12 inches (30 cm) to the surface of the vehicle. Use of power washers exceeding 1,200 psi (8 274 kPa) can result in damage or removal of paint and decals.

Cleaning Exterior Lamps/Lenses

Use only lukewarm or cold water, a soft cloth and a car washing soap to clean exterior lamps and lenses. Follow instructions under *Washing Your Vehicle on page 5-102*.

Finish Care

Occasional waxing or mild polishing of your vehicle by hand may be necessary to remove residue from the paint finish. You can get approved cleaning products from your dealer/retailer. See *Vehicle Care/Appearance Materials on page 5-106*.

If your vehicle has a basecoat/clearcoat paint finish, the clearcoat gives more depth and gloss to the colored basecoat. Always use waxes and polishes that are non-abrasive and made for a basecoat/clearcoat paint finish.

Notice: Machine compounding or aggressive polishing on a basecoat/clearcoat paint finish may damage it. Use only non-abrasive waxes and polishes that are made for a basecoat/clearcoat paint finish on your vehicle.

Foreign materials such as calcium chloride and other salts, ice melting agents, road oil and tar, tree sap, bird droppings, chemicals from industrial chimneys, etc., can damage your vehicle's finish if they remain on painted surfaces. Wash the vehicle as soon as possible. If necessary, use non-abrasive cleaners that are marked safe for painted surfaces to remove foreign matter.

Exterior painted surfaces are subject to aging, weather and chemical fallout that can take their toll over a period of years. You can help to keep the paint finish looking new by keeping your vehicle garaged or covered whenever possible.

Protecting Exterior Bright Metal Parts

Bright metal parts should be cleaned regularly to keep their luster. Washing with water is all that is usually needed. However, you may use chrome polish on chrome or stainless steel trim, if necessary.

Use special care with aluminum trim. To avoid damaging protective trim, never use auto or chrome polish, steam or caustic soap to clean aluminum. A coating of wax, rubbed to high polish, is recommended for all bright metal parts.

Windshield and Wiper Blades

Clean the outside of the windshield with glass cleaner.

Clean the rubber blades using a lint free cloth or paper towel soaked with windshield washer fluid or a mild detergent. Wash the windshield thoroughly when cleaning the blades. Bugs, road grime, sap, and a buildup of vehicle wash/wax treatments may cause wiper streaking. Replace the wiper blades if they are worn or damaged.

Wipers can be damaged by:

- Extreme dusty conditions
- Sand and salt
- Heat and sun
- Snow and ice, without proper removal

Aluminum or Chrome-Plated Wheels and Trim

Your vehicle may have either aluminum or chrome-plated wheels.

Keep the wheels clean using a soft clean cloth with mild soap and water. Rinse with clean water. After rinsing thoroughly, dry with a soft clean towel. A wax may then be applied.

Notice: Chrome wheels and other chrome trim may be damaged if you do not wash your vehicle after driving on roads that have been sprayed with magnesium, calcium or sodium chloride. These chlorides are used on roads for conditions such as ice and dust. Always wash your vehicle's chrome with soap and water after exposure.

Notice: If you use strong soaps, chemicals, abrasive polishes, cleaners, brushes, or cleaners that contain acid on aluminum or chrome-plated wheels, you could damage the surface of the wheel(s). The repairs would not be covered by your warranty. Use only approved cleaners on aluminum or chrome-plated wheels.

The surface of these wheels is similar to the painted surface of your vehicle. Do not use strong soaps, chemicals, abrasive polishes, abrasive cleaners, cleaners with acid, or abrasive cleaning brushes on them because you could damage the surface. Do not use chrome polish on aluminum wheels.

Notice: Using chrome polish on aluminum wheels could damage the wheels. The repairs would not be covered by your warranty. Use chrome polish on chrome wheels only.

Use chrome polish only on chrome-plated wheels, but avoid any painted surface of the wheel, and buff off immediately after application.

Notice: If you drive your vehicle through an automatic car wash that has silicone carbide tire cleaning brushes, you could damage the aluminum or chrome-plated wheels. The repairs would not be covered by your warranty. Never drive a vehicle equipped with aluminum or chrome-plated wheels through an automatic car wash that uses silicone carbide tire cleaning brushes.

Tires

To clean the tires, use a stiff brush with tire cleaner.

Notice: Using petroleum-based tire dressing products on your vehicle may damage the paint finish and/or tires. When applying a tire dressing, always wipe off any overspray from all painted surfaces on your vehicle.

Sheet Metal Damage

If the vehicle is damaged and requires sheet metal repair or replacement, make sure the body repair shop applies anti-corrosion material to parts repaired or replaced to restore corrosion protection.

Original manufacturer replacement parts will provide the corrosion protection while maintaining the warranty.

Finish Damage

Any stone chips, fractures or deep scratches in the finish should be repaired right away. Bare metal will corrode quickly and may develop into major repair expense.

Minor chips and scratches can be repaired with touch-up materials available from your dealer/retailer. Larger areas of finish damage can be corrected in your dealer's/retailer's body and paint shop.

Underbody Maintenance

Chemicals used for ice and snow removal and dust control can collect on the underbody. If these are not removed, corrosion and rust can develop on the underbody parts such as fuel lines, frame, floor pan, and exhaust system even though they have corrosion protection.

At least every spring, flush these materials from the underbody with plain water. Clean any areas where mud and debris can collect. Dirt packed in close areas of the frame should be loosened before being flushed. Your dealer/retailer or an underbody car washing system can do this for you.

Chemical Paint Spotting

Some weather and atmospheric conditions can create a chemical fallout. Airborne pollutants can fall upon and attack painted surfaces on the vehicle. This damage can take two forms: blotchy, ring-shaped discolorations, and small, irregular dark spots etched into the paint surface.

Although no defect in the paint job causes this, we will repair, at no charge to the owner, the surfaces of new vehicles damaged by this fallout condition within 12 months or 12,000 miles (20 000 km) of purchase, whichever occurs first.

Vehicle Care/Appearance Materials

Description	Usage
Polishing Cloth	Interior and exterior polishing cloth.
Tar and Road Oil Remover	Removes tar, road oil, and asphalt.
Chrome Cleaner and Polish	Use on chrome or stainless steel.
White Sidewall Tire Cleaner	Removes soil and black marks from whitewalls and raised white lettering.
Vinyl Cleaner	Cleans vinyl.
Glass Cleaner	Removes dirt, grime, smoke and fingerprints.
Chrome Wheel Cleaner	Removes dirt and grime from chrome wheels.
Finish Enhancer	Removes dust, fingerprints, and surface contaminants. Spray on and wipe off.
Swirl Remover Polish	Removes swirl marks, fine scratches, and other light surface contamination.
Cleaner Wax	Removes light scratches and protects finish.

Description	Usage
Foaming Tire Shine Low Gloss	Cleans, shines, and protects tires. No wiping necessary.
Wash Wax Concentrate	Medium foaming shampoo. Cleans and lightly waxes. Biodegradable and phosphate free.
Spot Lifter	Quickly removes spots and stains from carpets, vinyl, and cloth upholstery.
Odor Eliminator	Odorless spray odor eliminator used on fabrics, vinyl, leather and carpet.

Vehicle Identification

Vehicle Identification Number (VIN)



This is the legal identifier for your vehicle. It appears on a plate in the front corner of the instrument panel, on the driver side. You can see it if you look through the windshield from outside your vehicle. The VIN also appears on the Vehicle Certification and Service Parts labels and the certificates of title and registration.

Engine Identification

The eighth character in the VIN is the engine code. This code helps you identify your vehicle's engine, specifications, and replacement parts. See *Capacities and Specifications on page 5-116* for your vehicle's engine code.

Service Parts Identification Label

This label is in the trunk. It is very helpful if you ever need to order parts. The label has the following information:

- Vehicle Identification Number (VIN)
- Model designation
- Paint information
- Production options and special equipment

Do not remove this label from the vehicle.

Electrical System

Add-On Electrical Equipment

Notice: Do not add anything electrical to your vehicle unless you check with your dealer/retailer first. Some electrical equipment can damage your vehicle and the damage would not be covered by your warranty. Some add-on electrical equipment can keep other components from working as they should.

Add-on equipment can drain your vehicle's battery, even if your vehicle is not operating.

Your vehicle has an airbag system. Before attempting to add anything electrical to your vehicle, see *Servicing Your Airbag-Equipped Vehicle* on page 1-66.

Headlamp Wiring

The headlamp wiring is protected by a circuit breaker. An electrical overload will cause the lamps to go on and off, or in some cases to remain off. If this happens, have your headlamp wiring checked right away.

Windshield Wiper Fuses

The windshield wiper motor is protected by a circuit breaker and a fuse. If the motor overheats due to heavy snow, etc., the wiper will stop until the motor cools. If the overload is caused by some electrical problem, have it fixed.

Power Windows and Other Power Options

Circuit breakers in the fuse block protect the power windows and other power accessories. When the current load is too heavy, the circuit breaker opens and closes, protecting the circuit until the problem is fixed or goes away.

Fuses and Circuit Breakers

The wiring circuits in the vehicle are protected from short circuits by a combination of fuses, circuit breakers and in the fuse block wiring itself. This greatly reduces the chance of fires caused by electrical problems.

Look at the silver-colored band inside the fuse. If the band is broken or melted, replace the fuse. Make sure a bad fuse is replaced with a new one of the identical size and rating.

Instrument Panel Fuse Block

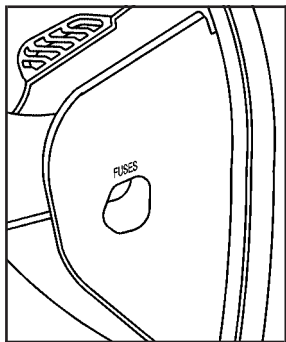

The instrument panel fuse block is located on the passenger side of the instrument panel. Pull off the cover labeled FUSES to expose the fuse block.

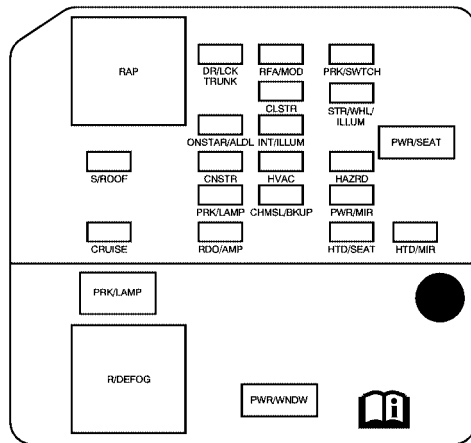

Fuses	Usage
DR/LCK TRUNK	Door Locks, Trunk
RFA/MOD	Remote Keyless Entry
PRK/SWTCH	Ignition Key Lock
CLSTR	Cluster
STR/WHL/ ILLUM	Steering Wheel Controls Illumination
ONSTAR/ALDL	OnStar [®] , Data Link
INT/ILLUM	Interior Lamps
PWR/SEAT	Power Seat
S/ROOF	Sunroof
CNSTR	Canister Vent
HVAC	Climate Control System
HAZRD	Turn Signal, Hazard
PRK/LAMP	Park Lamps

Fuses	Usage
CHMSL/BKUP	Center-High-Mounted Stoplamp/Back-up Lamps
PWR/MIR	Power Mirrors
CRUISE	Cruise Control
RDO/AMP	Radio, Amplifier
HTD/SEAT	Heated Seats
HTD/MIR	Heated Mirrors
PWR/WNDW	Power Window

Relays	Usage
RAP	Retained Accessory Power
PRK/LAMP	Park Lamp Relay
R/DEFOG	Rear Defogger Relay

Underhood Fuse Block

Some fuses and relays are located in the underhood fuse block on the passenger side of the vehicle in the engine compartment. See *Engine Compartment Overview* on page 5-12 for more information on location.

Notice: Spilling liquid on any electrical components on your vehicle may damage it. Always keep the covers on any electrical component.

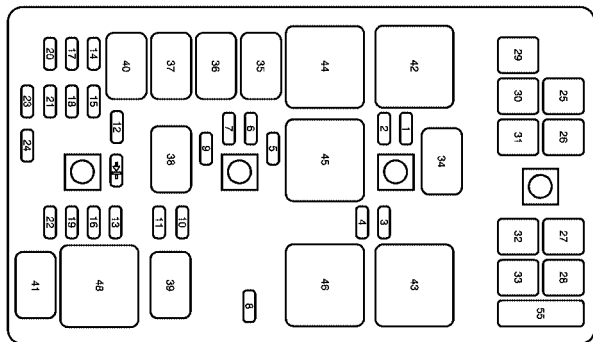

3.6L & 3.8L V6 Engines

Mini-Fuses	Usage
1	Driver Side High-Beam
2	Passenger Side High-Beam

Mini-Fuses	Usage
3	Driver Side Low-Beam
4	Passenger Side Low-Beam
5	Windshield Wiper
6	Washer/Regulated Voltage Control
7	Fog Lamps
8	Transmission Control Module
9	Supplemental Inflatable Restraint
10	Auxiliary Power
11	Horn
12	Emission
13	Air Conditioner Clutch
14	Oxygen Sensor
15	Powertrain Control Module
16	Powertrain Control Module, Electronic Throttle Control
17	Electronic Throttle Control
18	Display
19	Antilock Brake Solenoid
20	Fuel Injector
21	Transmission Solenoid

Mini-Fuses	Usage
22	Fuel Pump
23	Antilock Brake System
24	Ignition

J-Style Fuses	Usage
25	Air Pump
26	Battery Main 1
27	Battery Main 2
28	Battery Main 3
29	Fan 1
30	Battery Main 4
31	Antilock Brake System Motor
32	Fan 2
33	Starter

Micro-Relays	Usage
34	Headlamp High-Beam
35	Headlamp Driver Module
36	Fog Lamp
37	Ignition 1

Micro-Relays	Usage
38	Air Conditioning Compressor
39	Horn
40	Powertrain
41	Fuel Pump

Mini-Relays	Usage
42	Fan 1
43	Fan 3
44	Windshield Wiper High
45	Windshield Wiper
46	Fan 2
48	Crank

Fuse Puller	Usage
55	Fuse Puller

Diodes	Usage
	Air Conditioner Compressor Clutch Diode

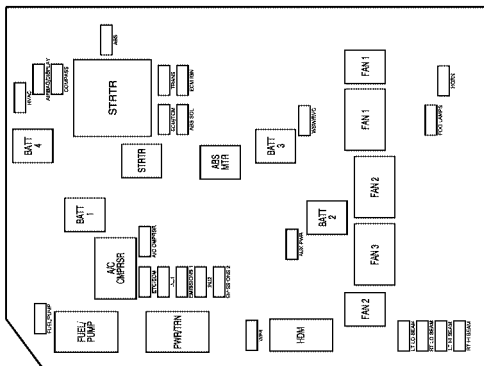

5.3L V8 Engine

Fuses	Usage
HVAC	Climate Control System
FUEL/PUMP	Fuel Pump
AIRBAG/ DISPLAY	Airbag, Display
COMPASS	Compass
ABS	Antilock Brake System

Fuses	Usage
ETC/ECM	Electronic Throttle Control, Engine Control Module
A/C CMPRSR	Air Conditioning Compressor
INJ 1	Injectors 1
ECM/TCM	Engine Control Module, Transmission Control Module
TRANS	Transmission
EMISSIONS1	Emissions 1
ABS SOL	Antilock Brake Solenoid
ECM IGN	Engine Control Module, Ignition
INJ 2	Injectors 2
EMISSIONS2	Emissions 2
WPR	Windshield Wipers
AUX PWR	Auxiliary Power
WSW/RVC	Windshield Washer, Regulated Voltage Control
LT LO BEAM	Driver Side Low-Beam Headlamp
RT LO BEAM	Passenger Side Low-Beam Headlamp
FOG LAMPS	Fog Lamps
LT HI BEAM	Driver Side High-Beam Headlamp

Fuses	Usage
HORN	Horn
RT HI BEAM	Passenger Side High-Beam Headlamp
BATT 4	Battery 4
BATT 1	Battery 1
STRTR	Starter
ABS MTR	Antilock Brake System Motor
BATT 3	Battery 3
BATT 2	Battery 2
FAN 2	Cooling Fan 2
FAN 1	Cooling Fan 1

Relays	Usage
FUEL/PUMP	Fuel Pump
A/C CMPRSR	Air Conditioning Compressor
PWR/TRN	Powertrain
STRTR	Starter
FAN 3	Cooling Fan 3
FAN 2	Cooling Fan 2
FAN 1	Cooling Fan 1
HDM	Headlamp Driver Module

Capacities and Specifications

The following approximate capacities are given in English and metric conversions.

Capacities and Specifications

Application	Capacities	
	English	Metric
Air Conditioning Refrigerant R134a	For the air conditioning system refrigerant charge amount, see the refrigerant caution label located under the hood. See your dealer/retailer for more information.	
Automatic Transmission (Drain and Refill)	7.4 qt	7.0 L
Cooling System Including Reservoir		
3.6L V6 and 3.8L V6 Engine	11.2 qt	10.6 L
5.3L V8 Engine	13.3 qt	12.6 L
Engine Oil with Filter		
3.6L V6 Engine	5.5 qt	5.2 L
3.8L V6 Engine	4.5 qt	4.3 L
5.3L V8 Engine	6.0 qt	5.7 L
Fuel Tank		
3.8LV6 Engine (with NU6 emissions) sold new in CA, ME, VT, NY, MA (see your dealer/retailer for bordering states)	17.0 gal	64.4 L
3.8LV6 Engine (without NU6 emissions) sold new in all other states (see your dealer/retailer for more information)	17.5 gal	66.2 L

Capacities and Specifications (cont'd)

Application	Capacities	
	English	Metric
3.6LV6 Engine sold new in all states	17.5 gal	66.2 L
5.3L V8 Engine	17.5 gal	66.2 L
Wheel Nut Torque	100 lb ft	140 N•m
All capacities are approximate. When adding, be sure to fill to the approximate level, as recommended in this manual. See <i>Scheduled Maintenance on page 6-4</i>		

Engine Specifications

Engine	VIN Code	Transmission	Spark Plug Gap
3.6L V6 Engine	7	Automatic	0.044 inches (1.1 mm)
3.8L V6 Engine	2	Automatic	0.060 inches (1.52 mm)
5.3 V8 Engine with Active Fuel Management™	C	Automatic	0.040 in (1.01 mm)

Section 6 Maintenance Schedule

Maintenance Schedule	6-2	Owner Checks and Services	6-8
Introduction	6-2	At Each Fuel Fill	6-8
Maintenance Requirements	6-2	At Least Once a Month	6-9
Your Vehicle and the Environment	6-2	At Least Once a Year	6-9
Using the Maintenance Schedule	6-2	Recommended Fluids and Lubricants	6-12
Scheduled Maintenance	6-4	Maintenance Replacement Parts	6-13
Additional Required Services	6-6	Engine Drive Belt Routing	6-14
Maintenance Footnotes	6-7	Maintenance Record	6-16

Maintenance Schedule

Introduction

Important: Keep engine oil at the proper level and change as recommended.



Have you purchased the GM Protection Plan? The Plan supplements your new vehicle warranties. See your Warranty and Owner Assistance booklet or your dealer/retailer for details.

Maintenance Requirements

Notice: Maintenance intervals, checks, inspections, replacement parts, and recommended fluids and lubricants as prescribed in this manual are necessary to keep your vehicle in good working condition. Any damage caused by failure to follow scheduled maintenance might not be covered by warranty.

Your Vehicle and the Environment

Proper vehicle maintenance not only helps to keep your vehicle in good working condition, but also helps the environment. All recommended maintenance is important. Improper vehicle maintenance can even affect the quality of the air we breathe. Improper fluid levels or the wrong tire inflation can increase the level of emissions from your vehicle. To help protect our environment, and to keep your vehicle in good condition, be sure to maintain your vehicle properly.

Using the Maintenance Schedule

We want to help you keep your vehicle in good working condition. But we do not know exactly how you will drive it. You might drive very short distances only a few times a week. Or you might drive long distances all the time in very hot, dusty weather. You might use your vehicle in making deliveries. Or you might drive it to work, to do errands, or in many other ways.

Because of all the different ways people use their vehicles, maintenance needs vary. You might need more frequent checks and replacements. So please read the following and note how you drive. If you have any questions on how to keep your vehicle in good condition, see your dealer/retailer.

This schedule is for vehicles that:

- carry passengers and cargo within recommended limits. You will find these limits on the Tire and Loading Information label. See *Loading Your Vehicle* on page 4-21.
- are driven on reasonable road surfaces within legal driving limits.
- use the recommended fuel. See *Gasoline Octane* on page 5-5.

The services in *Scheduled Maintenance* on page 6-4 should be performed when indicated. See *Additional Required Services* on page 6-6 and *Maintenance Footnotes* on page 6-7 for further information.

 **CAUTION:**

Performing maintenance work on a vehicle can be dangerous. In trying to do some jobs, you can be seriously injured. Do your own maintenance work only if you have the required know-how and the proper tools and equipment for the job.

CAUTION: (Continued)

CAUTION: (Continued)

If you have any doubt, see your dealer/retailer to have a qualified technician do the work. See *Doing Your Own Service Work* on page 5-4.

Some maintenance services can be complex. So, unless you are technically qualified and have the necessary equipment, you should have your dealer/retailer do these jobs.

When you go to your dealer/retailer for your service needs, you will know that trained and supported service technicians will perform the work using genuine parts.

If you want to purchase service information, see *Service Publications Ordering Information* on page 7-16.

Owner Checks and Services on page 6-8 tells you what should be checked, when to check it, and what you can easily do to help keep your vehicle in good condition.

The proper replacement parts, fluids, and lubricants to use are listed in *Recommended Fluids and Lubricants* on page 6-12 and *Maintenance Replacement Parts* on page 6-13. When your vehicle is serviced, make sure these are used. All parts should be replaced and all necessary repairs done before you or anyone else drives the vehicle. We recommend the use of genuine parts from your dealer/retailer.

Scheduled Maintenance

When the change engine oil light or CHANGE OIL SOON DIC message comes on, it means that service is required for your vehicle. Have your vehicle serviced as soon as possible within the next 600 miles (1 000 km). It is possible that, if you are driving under the best conditions, the engine oil life system may not indicate that vehicle service is necessary for over a year. However, the engine oil and filter must be changed at least once a year and at this time the system must be reset. Your dealer/retailer has trained service technicians who will perform this work using genuine parts and reset the system.

If the engine oil life system is ever reset accidentally, you must service your vehicle within 3,000 miles (5 000 km) since the last service. Remember to reset the oil life system whenever the oil is changed. See *Engine Oil Life System on page 5-21* for information on the Engine Oil Life System and resetting the system.

When the light or message appears, certain services, checks, and inspections are required. Required services are described in the following for “Maintenance I” and “Maintenance II.” Generally, it is recommended that the first service be Maintenance I, the second service be Maintenance II, and that you alternate Maintenance I and Maintenance II thereafter. However, in some cases, Maintenance II may be required more often.

Maintenance I — Use Maintenance I if the light or message comes on within 10 months since the vehicle was purchased or Maintenance II was performed.

Maintenance II — Use Maintenance II if the previous service performed was Maintenance I. Always use Maintenance II whenever the light or message comes on 10 months or more since the last service or if the light or message has not come on at all for one year.

Scheduled Maintenance

Service	Maintenance I	Maintenance II
Change engine oil and filter. See <i>Engine Oil</i> on page 5-18. Reset oil life system. See <i>Engine Oil Life System</i> on page 5-21. An <i>Emission Control Service</i> .	•	•
Visually check for any leaks or damage. See footnote (k).	•	•
Inspect engine air cleaner filter. If necessary, replace filter. See <i>Engine Air Cleaner/Filter</i> on page 5-23. See footnote (l).		•
Rotate tires and check inflation pressures and wear. See <i>Tire Inspection and Rotation</i> on page 5-75 and "Tire Wear Inspection" in <i>At Least Once a Month</i> on page 6-9.	•	•
Inspect brake system. See footnote (a).	•	•
Check engine coolant and windshield washer fluid levels and add fluid as needed.	•	•
Perform any needed additional services. See "Additional Required Services" in this section.	•	•
Inspect suspension and steering components. See footnote (b).		•
Inspect engine cooling system. See footnote (c).		•
Inspect wiper blades. See footnote (d).		•
Inspect restraint system components. See footnote (e).		•
Lubricate body components. See footnote (f).		•
Check transmission fluid level and add fluid as needed.		•
Replace passenger compartment air filter. See footnote (g).		•
Inspect throttle system. See footnote (j).		•

Additional Required Services

The following services should be performed at the first maintenance service (I or II) after the indicated miles (kilometers) shown for each item.

Additional Required Services

Service and Miles (Kilometers)	25,000 (40 000)	50,000 (80 000)	75,000 (120 000)	100,000 (160 000)	125,000 (200 000)	150,000 (240 000)
Inspect fuel system for damage or leaks.	•	•	•	•	•	•
Inspect exhaust system for loose or damaged components.	•	•	•	•	•	•
Replace engine air cleaner filter. See <i>Engine Air Cleaner/Filter on page 5-23</i> .		•		•		•
Change automatic transmission fluid and filter (severe service). See <i>footnote (h)</i> .		•		•		•
Change automatic transmission fluid and filter (normal service).				•		
Replace spark plugs and inspect spark plug wires. <i>An Emission Control Service</i> .				•		
Engine cooling system service (or every five years, whichever occurs first). <i>An Emission Control Service</i> . See <i>footnote (i)</i> .						•
Inspect engine accessory drive belt. <i>An Emission Control Service</i> . See <i>footnote (m)</i> .						•

Maintenance Footnotes

(a) *Visually inspect brake lines and hoses for proper hook-up, binding, leaks, cracks, chafing, etc. Inspect disc brake pads for wear and rotors for surface condition. Inspect other brake parts, including calipers, parking brake, etc.*

(b) *Visually inspect front and rear suspension and steering system for damaged, loose, or missing parts or signs of wear. Inspect power steering lines and hoses for proper hook-up, binding, leaks, cracks, chafing, etc.*

(c) *Visually inspect hoses and have them replaced if they are cracked, swollen, or deteriorated. Inspect all pipes, fittings and clamps; replace with genuine parts as needed. To help ensure proper operation, a pressure test of the cooling system and pressure cap and cleaning the outside of the radiator and air conditioning condenser is recommended at least once a year.*

(d) *Inspect wiper blades for wear, cracking, or contamination. Clean the windshield and wiper blades, if contaminated. Replace wiper blades that are worn or damaged. See Windshield Wiper Blade Replacement on page 5-62 and Windshield and Wiper Blades on page 5-104 for more information.*

(e) *Make sure the safety belt reminder light and safety belt assemblies are working properly. Look for any other loose or damaged safety belt system parts. If you see anything that might keep a safety belt system from doing its job, have it repaired. Have any torn or frayed safety belts replaced. Also see Checking the Restraint Systems on page 1-68.*

(f) *Lubricate all key lock cylinders. Lubricate all hinges and latches, including those for the body doors, hood, secondary latch, pivots, spring anchor, release pawl, rear compartment, glove box door, and console door. More frequent lubrication may be required when exposed to a corrosive environment. Applying silicone grease on weatherstrips with a clean cloth will make them last longer, seal better, and not stick or squeak.*

(g) *If you drive regularly under dusty conditions, the filter may require replacement more often.*

(h) *Change automatic transmission fluid and filter if the vehicle is mainly driven under one or more of these conditions:*

- In heavy city traffic where the outside temperature regularly reaches 90°F (32°C) or higher.*
- In hilly or mountainous terrain.*
- When doing frequent trailer towing.*
- Uses such as found in taxi, police, or delivery service.*

(i) *Drain, flush, and refill cooling system. This service can be complex; you should have your dealer/retailer perform this service. See Engine Coolant on page 5-27 for what to use. Inspect hoses. Clean radiator, condenser, pressure cap, and filler neck. Pressure test the cooling system and pressure cap.*

(j) *Check throttle system for interference or binding and for damaged or missing parts. Replace parts as needed. Replace any components that have high effort or excessive wear. Do not lubricate accelerator or cruise control cables.*

(k) *A fluid loss in any vehicle system could indicate a problem. Have the system inspected and repaired and the fluid level checked. Add fluid if needed.*

(l) *If you drive regularly under dusty conditions, inspect the filter at each engine oil change.*

(m) *Visually inspect belt for fraying, excessive cracks, or obvious damage. Replace belt if necessary.*

Owner Checks and Services

These owner checks and services should be performed at the intervals specified to help ensure the safety, dependability, and emission control performance of your vehicle. Your dealer/retailer can assist you with these checks and services.

Be sure any necessary repairs are completed at once. Whenever any fluids or lubricants are added to your vehicle, make sure they are the proper ones, as shown in *Recommended Fluids and Lubricants on page 6-12*.

At Each Fuel Fill

It is important to perform these underhood checks at each fuel fill.

Engine Oil Level Check

Notice: It is important to check the engine oil regularly and keep it at the proper level. Failure to keep the engine oil at the proper level can cause damage to the engine not covered by your warranty.

Check the engine oil level and add the proper oil if necessary. See *Engine Oil on page 5-18*.

Engine Coolant Level Check

Check the engine coolant level and add DEX-COOL[®] coolant mixture if necessary. See *Engine Coolant on page 5-27*.

Windshield Washer Fluid Level Check

Check the windshield washer fluid level in the windshield washer reservoir and add the proper fluid if necessary.

At Least Once a Month

Tire Inflation Check

Inspect your vehicle's tires and make sure they are inflated to the correct pressures. Do not forget to check the spare tire. See *Inflation - Tire Pressure on page 5-70*. Check to make sure the spare tire is stored securely. See *Changing a Flat Tire on page 5-87*.

Tire Wear Inspection

Tire rotation may be required for high mileage highway drivers prior to the Engine Oil Life System service notification. Check the tires for wear and, if necessary, rotate the tires. See *Tire Inspection and Rotation on page 5-75*.

At Least Once a Year

Starter Switch Check

CAUTION:

When you are doing this inspection, the vehicle could move suddenly. If the vehicle moves, you or others could be injured.

1. Before you start, be sure you have enough room around the vehicle.
2. Firmly apply both the parking brake and the regular brake. See *Parking Brake on page 2-32*.
Do not use the accelerator pedal, and be ready to turn off the engine immediately if it starts.
3. Try to start the engine in each gear. The vehicle should start only in PARK (P) or NEUTRAL (N). If the vehicle starts in any other position, contact your dealer/retailer for service.

Automatic Transmission Shift Lock Control System Check

CAUTION:

When you are doing this inspection, the vehicle could move suddenly. If the vehicle moves, you or others could be injured.

1. Before you start, be sure you have enough room around the vehicle. It should be parked on a level surface.
2. Firmly apply the parking brake. See *Parking Brake* on page 2-32.

Be ready to apply the regular brake immediately if the vehicle begins to move.

3. With the engine off, turn the ignition to ON/RUN, but do not start the engine. Without applying the regular brake, try to move the shift lever out of PARK (P) with normal effort. If the shift lever moves out of PARK (P), contact your dealer/retailer for service.

Ignition Transmission Lock Check

While parked, and with the parking brake set, try to turn the ignition to LOCK/OFF in each shift lever position.

- The ignition should turn to LOCK/OFF only when the shift lever is in PARK (P).
- The ignition key should come out only in LOCK/OFF.

Contact your dealer/retailer if service is required.

Parking Brake and Automatic Transmission Park (P) Mechanism Check

CAUTION:

When you are doing this check, your vehicle could begin to move. You or others could be injured and property could be damaged. Make sure there is room in front of your vehicle in case it begins to roll. Be ready to apply the regular brake at once should the vehicle begin to move.

Park on a fairly steep hill, with the vehicle facing downhill. Keeping your foot on the regular brake, set the parking brake.

- To check the parking brake's holding ability: With the engine running and the transmission in NEUTRAL (N), slowly remove foot pressure from the regular brake pedal. Do this until the vehicle is held by the parking brake only.
- To check the PARK (P) mechanism's holding ability: With the engine running, shift to PARK (P). Then release the parking brake followed by the regular brake.

Contact your dealer/retailer if service is required.

Underbody Flushing Service

At least every spring, use plain water to flush any corrosive materials from the underbody. Take care to clean thoroughly any areas where mud and other debris can collect.

Recommended Fluids and Lubricants

Fluids and lubricants identified below by name, part number, or specification can be obtained from your dealer/retailer.

Usage	Fluid/Lubricant
Engine Oil	Engine oil which meets GM Standard GM6094M and displays the American Petroleum Institute Certified for Gasoline Engines starburst symbol. To determine the proper viscosity for your vehicle's engine, see <i>Engine Oil</i> on page 5-18.
Engine Coolant	50/50 mixture of clean, drinkable water and use only DEX-COOL [®] Coolant. See <i>Engine Coolant</i> on page 5-27.
Hydraulic Brake System	Delco [®] Supreme 11 Brake Fluid or equivalent DOT-3 brake fluid.
Windshield Washer	Optikleen [®] Washer Solvent.

Usage	Fluid/Lubricant
Power Steering System	GM Power Steering Fluid (GM Part No. U.S. 89021184, in Canada 89021186).
Automatic Transmission	DEXRON [®] -VI Automatic Transmission Fluid.
Key Lock Cylinders	Multi-Purpose Lubricant, Superlube (GM Part No. U.S. 12346241, in Canada 10953474).
Hood Latch Assembly, Secondary Latch, Pivots, Spring Anchor, and Release Pawl	Lubriplate Lubricant Aerosol (GM Part No. U.S. 12346293, in Canada 992723) or lubricant meeting requirements of NLGI #2, Category LB or GC-LB.
Hood and Door Hinges	Multi-Purpose Lubricant, Superlube (GM Part No. U.S. 12346241, in Canada 109435474).
Weatherstrip Conditioning	Weatherstrip Lubricant (GM Part No. U.S. 3634770, in Canada 10953518) or Dielectric Silicone Grease (GM Part No. U.S. 12345579, in Canada 992887).

Maintenance Replacement Parts

Replacement parts identified below by name, part number, or specification can be obtained from your dealer/retailer.

Maintenance Replacement Parts

Part	GM Part Number	ACDelco® Part Number
Engine Air Cleaner/Filter		
3.6L and 3.8L Engines	15221217	A1614C
5.3L Engine	10350737	A2962C
Engine Oil Filter		
3.6L V6 and 5.3L V8 Engines	89017524	PF48
3.8L V6 Engine	25010792	PF47
Passenger Compartment Air Filter	15284938	CF132
Spark Plugs		
3.6L V6 Engine	12597464	41-990
3.8L V6 Engine	12568387	41-101
5.3L V8 Engine	12571164	41-985
Windshield Wiper Blade Assembly – 22.0 inches (55.0 cm)		
Driver's Side	15941735	—
Passenger's Side	15941736	—

Engine Drive Belt Routing

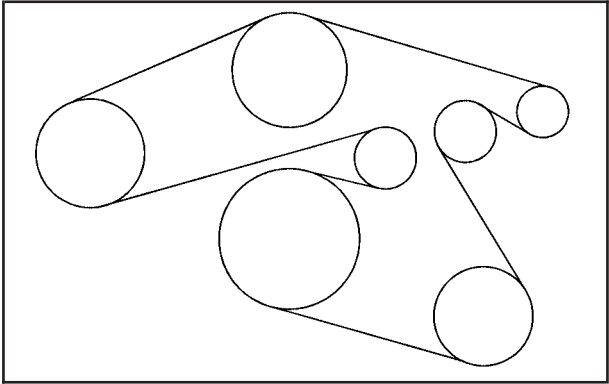

3.6L V6 Engine

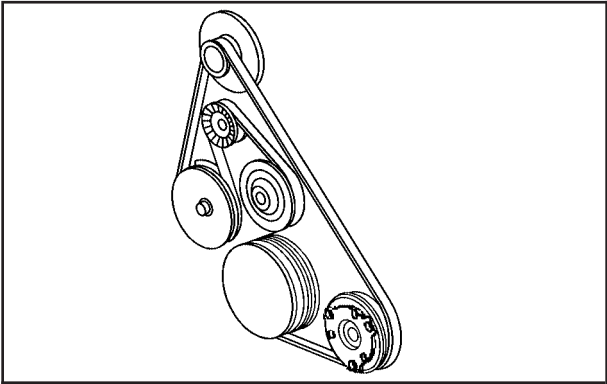

3.8L V6 Engine

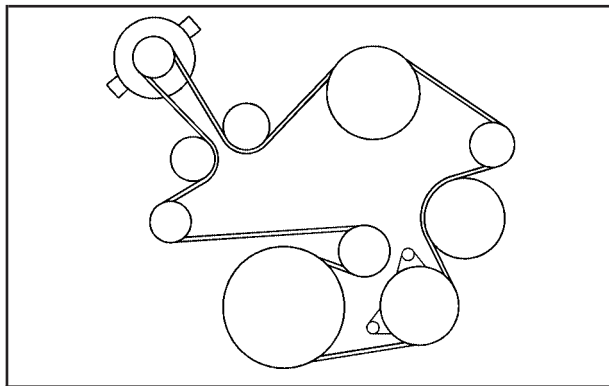

5.3L V8 Engine

Maintenance Record

After the scheduled services are performed, record the date, odometer reading, who performed the service, and the type of services performed in the boxes provided. See *Maintenance Requirements on page 6-2*. Any additional information from *Owner Checks and Services on page 6-8* can be added on the following record pages. You should retain all maintenance receipts.

Maintenance Record

Date	Odometer Reading	Serviced By	Maintenance I or Maintenance II	Services Performed

Maintenance Record (cont'd)

Date	Odometer Reading	Serviced By	Maintenance I or Maintenance II	Services Performed

Section 7 Customer Assistance Information

Customer Assistance and Information	7-2	Reporting Safety Defects	7-15
Customer Satisfaction Procedure	7-2	Reporting Safety Defects to the United States Government	7-15
Online Owner Center	7-5	Reporting Safety Defects to the Canadian Government	7-15
Customer Assistance for Text Telephone (TTY) Users	7-6	Reporting Safety Defects to General Motors	7-16
Customer Assistance Offices	7-6	Service Publications Ordering Information	7-16
GM Mobility Reimbursement Program	7-7	Vehicle Data Recording and Privacy	7-17
Roadside Assistance Program	7-8	Event Data Recorders	7-18
Scheduling Service Appointments	7-10	OnStar®	7-19
Courtesy Transportation	7-10	Navigation System	7-19
Collision Damage Repair	7-12	Radio Frequency Identification (RFID)	7-19

Customer Assistance and Information

Customer Satisfaction Procedure

Your satisfaction and goodwill are important to your dealer and to Buick. Normally, any concerns with the sales transaction or the operation of your vehicle will be resolved by your GM dealer's sales or service departments. Sometimes, however, despite the best intentions of all concerned, misunderstandings can occur. If your concern has not been resolved to your satisfaction, the following steps should be taken:

STEP ONE: Discuss your concern with a member of dealership management. Normally, concerns can be quickly resolved at that level. If the matter has already been reviewed with the sales, service, or parts manager, contact the owner of the dealership or the general manager.

STEP TWO: If after contacting a member of dealership management, it appears your concern cannot be resolved by the dealership without further help, in the U.S., contact the Buick Customer Assistance Center by calling 1-800-521-7300. In Canada, contact General Motors of Canada Customer Communication Centre by calling 1-800-263-3777 (English) or 1-800-263-7854 (French).

We encourage you to call the toll-free number in order to give your inquiry prompt attention. Please have the following information available to give the Customer Assistance Representative:

- Vehicle Identification Number. This is available from the vehicle registration or title, or the plate at the top left of the instrument panel.
- Dealership name and location
- Vehicle delivery date and present mileage

When contacting Buick, please remember that your concern will likely be resolved at a dealer's facility. That is why we suggest you follow Step One first if you have a concern.

STEP THREE — U.S. Owners: Both General Motors and your dealer are committed to making sure you are completely satisfied with your new vehicle. However, in the United States, if you continue to remain unsatisfied after following the procedure outlined in Steps One and Two, you should file with the BBB Auto Line Program to enforce your rights.

The BBB Auto Line Program is an out of court program administered by the Council of Better Business Bureaus to settle automotive disputes regarding vehicle repairs or the interpretation of the New Vehicle Limited Warranty. Although you may be required to resort to this informal dispute resolution program prior to filing a court action, use of the program is free of charge and your case will generally be heard within 40 days. If you do not agree with the decision given in your case, you may reject it and proceed with any other venue for relief available to you.

You may contact the BBB Auto Line Program using the toll-free telephone number or write them at the following address:

BBB Auto Line Program
Council of Better Business Bureaus, Inc.
4200 Wilson Boulevard
Suite 800
Arlington, VA 22203-1838
Telephone: 1-800-955-5100

This program is available in all 50 states and the District of Columbia. Eligibility is limited by vehicle age, mileage and other factors. General Motors reserves the right to change eligibility limitations and/or discontinue its participation in this program.

STEP THREE — Canadian Owners: In the event that you do not feel your concerns have been addressed after following the procedure outlined in Steps one and two, General Motors of Canada Limited wants you to be aware of its participation in a no-charge Mediation/Arbitration program. General Motors of Canada Limited has committed to binding arbitration of owner disputes involving factory-related vehicle service claims. The program provides for the review of the facts involved by an impartial third party arbiter, and may include an informal hearing before the arbiter. The program is designed so that the entire dispute settlement process, from the time you file your complaint to the final decision, should be completed in approximately 70 days. We believe our impartial program offers advantages over courts in most jurisdictions because it is informal, quick, and free of charge.

For further information concerning eligibility in the Canadian Motor Vehicle Arbitration Plan (CAMVAP), call toll-free 1-800-207-0685. Alternatively you may call the General Motors Customer Communication Centre, 1-800-263-3777 (English), 1-800-263-7854 (French), or you may write to the Mediation/Arbitration Program at the following address. Your inquiry should be accompanied by your Vehicle Identification Number (VIN).

Mediation/Arbitration Program
c/o Customer Communication Centre
General Motors of Canada Limited
Mail Code: CA1-163-005
1908 Colonel Sam Drive
Oshawa, Ontario L1H 8P7

Online Owner Center

(United States only)

The Owner Center is a resource for your GM ownership needs. Specific vehicle information can be found in one place.

The Online Owner Center allows you to:

- Get e-mail service reminders.
- Access information about your specific vehicle, including tips and videos and an electronic version of this owner manual.
- Keep track of your vehicle's service history and maintenance schedule.
- Find GM dealers/retailers for service nationwide.
- Receive special promotions and privileges only available to members.

Refer to www.MyGMLink.com on the web for updated information and to register your vehicle.

My GM Canada (Canada only)

My GM Canada is a password-protected section of gmcanada.com where you can save information on GM vehicles, get personalized offers, and use handy tools and forms with greater ease.

Here are a few of the valuable tools and services you will have access to:

- My Showroom: Find and save information on vehicles and current offers in your area.
- My Dealers/Retailers: Save details such as address and phone number for each of your preferred GM Dealers or Retailers.
- My Driveway: Receive service reminders and helpful advice on owning and maintaining your vehicle.
- My Preferences: Manage your profile, subscribe to E-News and use tools and forms with greater ease.

To sign up to My GM Canada, visit the My GM Canada section within www.gmcanada.com.

Customer Assistance for Text Telephone (TTY) Users

To assist customers who are deaf, hard of hearing, or speech-impaired and who use Text Telephones (TTYs), Buick has TTY equipment available at its Customer Assistance Center. Any TTY user can communicate with Buick by dialing: 1-800-83-BUICK. TTY users in Canada can dial 1-800-263-3830.

Customer Assistance Offices

Buick encourages customers to call the toll-free number for assistance. However, if a customer wishes to write or e-mail Buick, the letter should be addressed to:

United States — Customer Assistance

Buick Customer Assistance Center
P.O. Box 33136
Detroit, MI 48232-5136

www.Buick.com
1-800-521-7300
1-800-832-8425 (For Text Telephone devices (TTYs))
Roadside Assistance: 1-800-252-1112
Fax Number: 313-381-0022

From Puerto Rico:
1-800-496-9992 (English)
1-800-496-9993 (Spanish)
Fax Number: 313-381-0022

From U.S. Virgin Islands
1-800-496-9994
Fax Number: 313-381-0022

Canada — Customer Assistance

General Motors of Canada Limited
Customer Communication Centre, CA1-163-005
1908 Colonel Sam Drive
Oshawa, Ontario L1H 8P7

www.gmcanada.com
1-800-263-3777 (English)
1-800-263-7854 (French)
1-800-263-3830 (For Text Telephone devices (TTYs))
Roadside Assistance: 1-800-268-6800

Overseas — Customer Assistance

Please contact the local General Motors Business Unit.

Mexico, Central America and Caribbean Islands/Countries (Except Puerto Rico and U.S. Virgin Islands) — Customer Assistance

General Motors de Mexico, S. de R.L. de C.V.
Customer Assistance Center
Paseo de la Reforma # 2740
Col. Lomas de Bezares
C.P. 11910, Mexico, D.F.
01-800-508-0000
Long Distance: 011-52-53 29 0 800

GM Mobility Reimbursement Program



This program, available to qualified applicants, can reimburse you up to \$1,000 of the cost of eligible aftermarket adaptive equipment required for your vehicle, such as hand controls or a wheelchair/scooter lift.

The offer is available for a very limited period of time from the date of vehicle purchase/lease. For more details, or to determine your vehicle's eligibility, visit gmmobility.com or call the GM Mobility Assistance Center at 1-800-323-9935. Text telephone (TTY) users, call 1-800-833-9935.

General Motors of Canada also has a Mobility Program. Call 1-800-GM-DRIVE (463-7483) for details. TTY users call 1-800-263-3830.

Roadside Assistance Program

For vehicles purchased in the U.S., call **1-800-252-1112**;
(Text Telephone (TTY): 1-888-889-2438).

For vehicles purchased in Canada, call **1-800-268-6800**.

Service is available 24 hours a day, 365 days a year.

As the owner of a new Buick vehicle, you are automatically enrolled in the Buick Roadside Assistance program.

Who is Covered?

Roadside Assistance coverage is for the vehicle operator, regardless of ownership. In Canada, a person driving the vehicle without the consent of the owner is not eligible for coverage.

Services Provided

The following services are provided in the U.S. and Canada up to 5 years/100,000 miles (160 000 km), whichever occurs first, and, in Canada only, up to a maximum coverage of \$100.

- **Fuel Delivery:** Delivery of enough fuel for the vehicle to get to the nearest service station (approximately \$5 in Canada). In Canada, service to provide diesel may be restricted. For safety reasons, propane and other alternative fuels will not be provided through this service.

- **Lock-out Service:** Lock-out service will be covered at no charge if you are unable to gain entry into your vehicle. A remote unlock may be available if you have an active OnStar[®] subscription. To ensure security, the driver must present personal identification before lock-out service is provided. In Canada, the vehicle registration is also required.
- **Emergency Tow From a Public Roadway or Highway:** Tow to the nearest dealership for warranty service or in the event of a vehicle-disabling crash. Winch-out assistance is provided when the vehicle is mired in sand, mud, or snow.
- **Flat Tire Change:** Installation of a spare tire in good condition, when equipped and properly inflated, is covered at no charge. The customer is responsible for the repair or replacement of the tire if not covered by a warrantable failure.
- **Jump Start:** A battery jump start is covered at no charge if the vehicle does not start.
- **Trip Routing Service (Canada only):** Upon request, Roadside Assistance will send you detailed, computer personalized maps, highlighting your choice of either the most direct route or the most scenic route to your destination, anywhere in North America, along with helpful travel information pertaining to your trip.

Please allow three weeks before your planned departure date. Trip routing requests will be limited to six per calendar year.

- **Trip Interruption Benefits and Assistance**

(Canada only): In the event of a warranty related vehicle disablement, while en route and over 250 kilometres from the original point of departure, you may qualify for trip interruption expense assistance. This assistance covers reasonable reimbursement of up to a maximum of \$500 (Canadian) for (A) meals (maximum of \$50/day), (B) lodging (maximum of \$100/night) and (C) alternate ground transportation (maximum of \$40/day). This benefit is to assist you with some of the unplanned expense you may incur while waiting for your vehicle to be repaired.

Pre-authorization, original detailed receipts, and a copy of the repair order are required.

Once authorization has been given, your advisor will help you make any necessary arrangements and explain how to claim for trip interruption expense assistance.

- **Alternative Service (Canada only):** There may be times when Roadside Assistance cannot provide timely assistance. Your advisor may authorize you to secure local emergency road service, and you will be reimbursed up to \$100 upon submission of the original receipt to Roadside Assistance.

In many instances, mechanical failures may be covered. However, any cost for parts and labor for non-warranty repairs are the responsibility of the driver.

Buick and General Motors of Canada Limited reserve the right to limit services or reimbursement to an owner or driver when, in their sole discretion, the claims become excessive in frequency or type of occurrence.

Calling For Assistance

For prompt and efficient assistance when calling, please provide the following to the Roadside Assistance Representative:

- Your name, home address, and home telephone number
- Telephone number of your location
- Location of the vehicle
- Model, year, color, and license plate number of the vehicle
- Odometer reading, Vehicle Identification Number (VIN), and delivery date of the vehicle
- Description of the problem

Towing and Road Service Exclusions

Specifically excluded from Roadside Assistance coverage are towing or services for vehicles operated on a non-public roadway or highway, fines, impound towing caused by a violation of local, Municipal, State, Provincial, or Federal law, and mounting, dismounting or changing of snow tires, chains, or other traction devices.

Roadside Assistance is not part of or included in the coverage provided by the New Vehicle Limited Warranty. Buick and General Motors of Canada Limited reserve the right to make any changes or discontinue the Roadside Assistance program at any time without notification.

Scheduling Service Appointments

When your vehicle requires warranty service, contact your dealer/retailer and request an appointment. By scheduling a service appointment and advising your service consultant of your transportation needs, your dealer/retailer can help minimize your inconvenience.

If your vehicle cannot be scheduled into the service department immediately, keep driving it until it can be scheduled for service, unless, of course, the problem is safety-related. If it is, please call your dealership/retailer, let them know this, and ask for instructions.

If the dealer/retailer requests that you simply drop the vehicle off for service, you are urged to do so as early in the work day as possible to allow for the same day repair.

Courtesy Transportation

To enhance your ownership experience, we and our participating dealers are proud to offer Courtesy Transportation, a customer support program for vehicles with the Bumper to Bumper (Base Warranty Coverage period in Canada) and extended powertrain warranty in both the U.S. and Canada.

Several courtesy transportation options are available to assist in reducing your inconvenience when warranty repairs are required.

Courtesy Transportation is not a part of the New Vehicle Limited Warranty. A separate booklet entitled "Warranty and Owner Assistance Information" furnished with each new vehicle provides detailed warranty coverage information.

Transportation Options

Warranty service can generally be completed while you wait. However, if you are unable to wait, GM helps to minimize your inconvenience by providing several transportation options. Depending on the circumstances, your dealer can offer you one of the following:

Shuttle Service

Shuttle service is the preferred means of offering Courtesy Transportation. Dealers may provide you with shuttle service to get you to your destination with minimal interruption of your daily schedule. This includes one-way or round trip shuttle service within reasonable time and distance parameters of the dealer's area.

Public Transportation or Fuel Reimbursement

If your vehicle requires overnight warranty repairs, and public transportation is used instead of the dealer's shuttle service, the expense must be supported by original receipts and can only be up to the maximum amount allowed by GM for shuttle service. In addition, for U.S. customers, should you arrange transportation

through a friend or relative, limited reimbursement for reasonable fuel expenses may be available. Claim amounts should reflect actual costs and be supported by original receipts. See your dealer for information regarding the allowance amounts for reimbursement of fuel or other transportation costs.

Courtesy Rental Vehicle

Your dealer may arrange to provide you with a courtesy rental vehicle or reimburse you for a rental vehicle that you obtain if your vehicle is kept for an overnight warranty repair. Rental reimbursement will be limited and must be supported by original receipts. This requires that you sign and complete a rental agreement and meet state/provincial, local, and rental vehicle provider requirements. Requirements vary and may include minimum age requirements, insurance coverage, credit card, etc. You are responsible for fuel usage charges and may also be responsible for taxes, levies, usage fees, excessive mileage, or rental usage beyond the completion of the repair.

It may not be possible to provide a like-vehicle as a courtesy rental.

Additional Program Information

All program options, such as shuttle service, may not be available at every dealer. Please contact your dealer for specific information about availability. All Courtesy Transportation arrangements will be administered by appropriate dealer personnel.

General Motors reserves the right to unilaterally modify, change or discontinue Courtesy Transportation at any time and to resolve all questions of claim eligibility pursuant to the terms and conditions described herein at its sole discretion.

Collision Damage Repair

If your vehicle is involved in a collision and it is damaged, have the damage repaired by a qualified technician using the proper equipment and quality replacement parts. Poorly performed collision repairs diminish your vehicle's resale value, and safety performance can be compromised in subsequent collisions.

Collision Parts

Genuine GM Collision parts are new parts made with the same materials and construction methods as the parts with which your vehicle was originally built. Genuine GM Collision parts are your best choice to ensure that your vehicle's designed appearance, durability, and safety are preserved. The use of Genuine GM parts can help maintain your GM New Vehicle Warranty.

Recycled original equipment parts may also be used for repair. These parts are typically removed from vehicles that were total losses in prior crashes. In most cases, the parts being recycled are from undamaged sections of the vehicle. A recycled original equipment GM part, may be an acceptable choice to maintain your vehicle's originally designed appearance and safety performance, however, the history of these parts is not known. Such parts are not covered by your GM New Vehicle Limited Warranty, and any related failures are not covered by that warranty.

Aftermarket collision parts are also available. These are made by companies other than GM and may not have been tested for your vehicle. As a result, these parts may fit poorly, exhibit premature durability/corrosion problems, and may not perform properly in subsequent collisions. Aftermarket parts are not covered by your GM New Vehicle Limited Warranty, and any vehicle failure related to such parts are not covered by that warranty.

Repair Facility

GM also recommends that you choose a collision repair facility that meets your needs before you ever need collision repairs. Your dealer/retailer may have a collision repair center with GM-trained technicians and state of the art equipment, or be able to recommend a collision repair center that has GM-trained technicians and comparable equipment.

Insuring Your Vehicle

Protect your investment in your GM vehicle with comprehensive and collision insurance coverage. There are significant differences in the quality of coverage afforded by various insurance policy terms. Many insurance policies provide reduced protection to your GM vehicle by limiting compensation for damage repairs by using aftermarket collision parts. Some insurance companies will not specify aftermarket collision parts. When purchasing insurance, we recommend that you assure your vehicle will be repaired with GM original equipment collision parts. If such insurance coverage is not available from your current insurance carrier, consider switching to another insurance carrier.

If your vehicle is leased, the leasing company may require you to have insurance that assures repairs with Genuine GM Original Equipment Manufacturer (OEM) parts or Genuine Manufacturer replacement parts. Read your lease carefully, as you may be charged at the end of your lease for poor quality repairs.

If a Crash Occurs

Here is what to do if you are involved in a crash.

- Try to relax and then check to make sure you are all right. If you are uninjured, make sure that no one else in your vehicle, or the other vehicle, is injured.
- If there has been an injury, call emergency services for help. Do not leave the scene of a crash until all matters have been taken care of. Move your vehicle only if its position puts you in danger or you are instructed to move it by a police officer.
- Give only the necessary and requested information to police and other parties involved in the crash. Do not discuss your personal condition, mental frame of mind, or anything unrelated to the crash. This will help guard against post-crash legal action.
- If you need roadside assistance, call GM Roadside Assistance. See *Roadside Assistance Program on page 7-8* for more information.
- If your vehicle cannot be driven, know where the towing service will be taking it. Get a card from the tow truck operator or write down the driver's name, the service's name, and the phone number.

- Remove any valuables from your vehicle before it is towed away. Make sure this includes your insurance information and registration if you keep these items in your vehicle.
- Gather the important information you will need from the other driver. Things like name, address, phone number, driver's license number, vehicle license plate, vehicle make, model and model year, Vehicle Identification Number (VIN), insurance company and policy number, and a general description of the damage to the other vehicle.
- If possible, call your insurance company from the scene of the crash. They will walk you through the information they will need. If they ask for a police report, phone or go to the police department headquarters the next day and you can get a copy of the report for a nominal fee. In some states/provinces with "no fault" insurance laws, a report may not be necessary. This is especially true if there are no injuries and both vehicles are driveable.
- Choose a reputable collision repair facility for your vehicle. Whether you select a dealer/retailer or a private collision repair facility to fix the damage, make sure you are comfortable with them. Remember, you will have to feel comfortable with their work for a long time.

- Once you have an estimate, read it carefully and make sure you understand what work will be performed on your vehicle. If you have a question, ask for an explanation. Reputable shops welcome this opportunity.

Managing the Vehicle Damage Repair Process

In the event that your vehicle requires damage repairs, GM recommends that you take an active role in its repair. If you have a pre-determined repair facility of choice, take your vehicle there, or have it towed there. Specify to the facility that any required replacement collision parts be original equipment parts, either new Genuine GM parts or recycled original GM parts. Remember, recycled parts will not be covered by your GM vehicle warranty.

Insurance pays the bill for the repair, but you must live with the repair. Depending on your policy limits, your insurance company may initially value the repair using aftermarket parts. Discuss this with your repair professional, and insist on Genuine GM parts. Remember if your vehicle is leased you may be obligated to have the vehicle repaired with Genuine GM parts, even if your insurance coverage does not pay the full cost.

If another party's insurance company is paying for the repairs, you are not obligated to accept a repair valuation based on that insurance company's collision policy repair limits, as you have no contractual limits with that company. In such cases, you can have control of the repair and parts choices as long as cost stays within reasonable limits.

Reporting Safety Defects

Reporting Safety Defects to the United States Government

If you believe that your vehicle has a defect which could cause a crash or could cause injury or death, you should immediately inform the National Highway Traffic Safety Administration (NHTSA) in addition to notifying General Motors.

If NHTSA receives similar complaints, it may open an investigation, and if it finds that a safety defect exists in a group of vehicles, it may order a recall and remedy campaign. However, NHTSA cannot become involved in individual problems between you, your dealer/retailer, or General Motors.

To contact NHTSA, you may call the Vehicle Safety Hotline toll-free at 1-888-327-4236 (TTY: 1-800-424-9153); go to <http://www.safercar.gov>; or write to:

Administrator, NHTSA
400 Seventh Street, SW.
Washington D.C., 20590

You can also obtain other information about motor vehicle safety from <http://www.safercar.gov>.

Reporting Safety Defects to the Canadian Government

If you live in Canada, and you believe that your vehicle has a safety defect, notify Transport Canada immediately, in addition to notifying General Motors of Canada Limited. Call them at 1-800-333-0510 or write to:

Transport Canada
Road Safety Branch
2780 Sheffield Road
Ottawa, Ontario K1B 3V9

Reporting Safety Defects to General Motors

In addition to notifying NHTSA (or Transport Canada) in a situation like this, please notify General Motors.

Call 1-800-521-7300, or write:

Buick Customer Assistance Center
P.O. Box 33136
Detroit, MI 48232-5136

In Canada, call 1-800-263-3777 (English) or 1-800-263-7854 (French), or write:

General Motors of Canada Limited
Customer Communication Centre, CA1-163-005
1908 Colonel Sam Drive
Oshawa, Ontario L1H 8P7

Service Publications Ordering Information

Service Manuals

Service Manuals have the diagnosis and repair information on engines, transmission, axle suspension, brakes, electrical, steering, body, etc.

Service Bulletins

Service Bulletins' give additional technical service information needed to knowledgeably service General Motors cars and trucks. Each bulletin contains instructions to assist in the diagnosis and service of your vehicle.

Owner Information

Owner publications are written specifically for owners and intended to provide basic operational information about the vehicle. The owner manual includes the Maintenance Schedule for all models.

In-Portfolio: Includes a Portfolio, Owner Manual, and Warranty Booklet.

RETAIL SELL PRICE: \$35.00 (U.S.) plus processing fee

Without Portfolio: Owner Manual only.

RETAIL SELL PRICE: \$25.00 (U.S.) plus processing fee

Current and Past Model Order Forms

Technical Service Bulletins and Manuals are available for current and past model GM vehicles. To request an order form, specify year and model name of the vehicle.

ORDER TOLL FREE: 1-800-551-4123
Monday-Friday 8:00 AM - 6:00 PM
Eastern Time

For Credit Card Orders Only
(VISA-MasterCard-Discover), visit Helm, Inc. on the
World Wide Web at: www.helminc.com

Or you can write to:

Helm, Incorporated
P.O. Box 07130
Detroit, MI 48207

Prices are subject to change without notice and without
incurring obligation. Allow ample time for delivery.

Note to Canadian Customers: All listed prices are
quoted in U.S. funds. Canadian residents are to make
checks payable in U.S. funds.

Vehicle Data Recording and Privacy

Your GM vehicle has a number of sophisticated computers that record information about the vehicle's performance and how it is driven. For example, your vehicle uses computer modules to monitor and control engine and transmission performance, to monitor the conditions for airbag deployment and deploy airbags in a crash and, if so equipped, to provide antilock braking to help the driver control the vehicle. These modules may store data to help your dealer/retailer technician service your vehicle. Some modules may also store data about how you operate the vehicle, such as rate of fuel consumption or average speed. These modules may also retain the owner's personal preferences, such as radio pre-sets, seat positions, and temperature settings.

Event Data Recorders

This vehicle has an Event Data Recorder (EDR). The main purpose of an EDR is to record, in certain crash or near crash-like situations, such as an airbag deployment or hitting a road obstacle, data that will assist in understanding how a vehicle's systems performed. The EDR is designed to record data related to vehicle dynamics and safety systems for a short period of time, typically 30 seconds or less. The EDR in this vehicle is designed to record such data as:

- How various systems in your vehicle were operating
- Whether or not the driver and passenger safety belts were buckled/fastened
- How far, if at all, the driver was pressing the accelerator and/or brake pedal
- How fast the vehicle was traveling

This data can help provide a better understanding of the circumstances in which crashes and injuries occur.

Important: EDR data is recorded by your vehicle only if a non-trivial crash situation occurs; no data is recorded by the EDR under normal driving conditions and no personal data (e.g., name, gender, age, and crash location) is recorded. However, other parties, such as law enforcement, could combine the EDR data with the type of personally identifying data routinely acquired during a crash investigation.

To read data recorded by an EDR, special equipment is required, and access to the vehicle or the EDR is needed. In addition to the vehicle manufacturer, other parties, such as law enforcement, that have the special equipment, can read the information if they have access to the vehicle or the EDR.

GM will not access this data or share it with others except: with the consent of the vehicle owner or, if the vehicle is leased, with the consent of the lessee; in response to an official request of police or similar government office; as part of GM's defense of litigation through the discovery process; or, as required by law. Data that GM collects or receives may also be used for GM research needs or may be made available to others for research purposes, where a need is shown and the data is not tied to a specific vehicle or vehicle owner.

OnStar®

If your vehicle has OnStar and you subscribe to the OnStar services, please refer to the OnStar Terms and Conditions for information on data collection and use. See also *OnStar® System on page 2-43* in this manual for more information.

Navigation System

If your vehicle has a navigation system, use of the system may result in the storage of destinations, addresses, telephone numbers, and other trip information. Refer to the navigation system operating manual for information on stored data and for deletion instructions.

Radio Frequency Identification (RFID)

RFID technology is used in some vehicles for functions such as tire pressure monitoring and ignition system security, as well as in connection with conveniences such as key fobs for remote door locking/unlocking and starting, and in-vehicle transmitters for garage door openers. RFID technology in GM vehicles does not use or record personal information or link with any other GM system containing personal information.

A

Accessories and Modifications	5-3
Adding Equipment to Your Airbag-Equipped Vehicle	1-67
Additives, Fuel	5-7
Add-On Electrical Equipment	5-108
Air Cleaner/Filter, Engine	5-23
Air Conditioning	3-20, 3-24
Airbag	
Passenger Status Indicator	3-34
Readiness Light	3-33
Airbag System	1-54
What Will You See After an Airbag Inflates?	1-60
When Should an Airbag Inflate?	1-59
Where Are the Airbags?	1-57
Airbag Systems	
Adding Equipment to Your Airbag-Equipped Vehicle	1-67
How Does an Airbag Restrain?	1-60
Passenger Sensing System	1-62
Servicing Your Airbag-Equipped Vehicle	1-66
What Makes an Airbag Inflate?	1-60
Antenna, Backglass	3-104
Antenna, XM™ Satellite Radio Antenna System	3-105
Antilock Brake System (ABS)	4-4
Antilock Brake, System Warning Light	3-38

Appearance Care	
Aluminum or Chrome-Plated Wheels	5-104
Care of Safety Belts	5-102
Chemical Paint Spotting	5-106
Cleaning Exterior Lamps/Lenses	5-103
Fabric/Carpet	5-100
Finish Care	5-103
Finish Damage	5-105
Instrument Panel, Vinyl, and Other Plastic Surfaces	5-101
Interior Cleaning	5-99
Leather	5-101
Sheet Metal Damage	5-105
Tires	5-105
Underbody Maintenance	5-106
Vehicle Care/Appearance Materials	5-106
Washing Your Vehicle	5-102
Weatherstrips	5-102
Windshield and Wiper Blades	5-104
Appointments, Scheduling Service	7-10
Ashtray	3-20
Audio System	3-84
Audio Steering Wheel Controls	3-102
Backglass Antenna	3-104
Chime Level Adjustment	3-105
Radio Reception	3-103
Setting the Clock	3-85
Theft-Deterrent Feature	3-101
XM™ Satellite Radio Antenna System	3-105

Audio System(s)	3-86
Automatic Door Lock	2-12
Automatic Transmission	
Fluid	5-25
Operation	2-29

B

Backglass Antenna	3-104
Battery	5-49
Electric Power Management	3-18
Exterior Lighting Battery Saver	3-15
Run-Down Protection	3-19
Brake	
Emergencies	4-5
Brakes	5-46
System Warning Light	3-37
Braking	4-3
Braking in Emergencies	4-5
Break-In, New Vehicle	2-24
Bulb Replacement	5-58
Halogen Bulbs	5-58
Headlamp Aiming	5-56
License Plate Lamps	5-61
Replacement Bulbs	5-61
Taillamps, Turn Signal, Sidemarker, Stoplamps, and Back-Up Lamps	5-59
Buying New Tires	5-78

C

Calibration	3-56
California Fuel	5-6
California Perchlorate Materials Requirements	5-4
California Proposition 65 Warning	5-3
Canadian Owners	ii
Capacities and Specifications	5-116
Carbon Monoxide	2-14, 2-37, 4-17, 4-28
Care of	
Safety Belts	5-102
CD, MP3	3-97
Center Console Storage Area	2-53
Center Seat	1-7
Chains, Tire	5-84
Charging System Light	3-36
Check	
Engine Light	3-42
Check Gas Cap Light	3-49
Checking Things Under the Hood	5-10
Chemical Paint Spotting	5-106
Child Restraints	
Child Restraint Systems	1-37
Infants and Young Children	1-33
Lower Anchors and Tethers for Children	1-41
Older Children	1-29
Securing a Child Restraint in a Rear Seat Position	1-47

Child Restraints (cont.)	
Securing a Child Restraint in the Center	
Front Seat Position	1-50
Securing a Child Restraint in the Right Front	
Seat Position	1-50
Where to Put the Restraint	1-39
Chime Level Adjustment	3-105
Cigarette Lighter	3-20
Cleaning	
Aluminum or Chrome-Plated Wheels	5-104
Exterior Lamps/Lenses	5-103
Fabric/Carpet	5-100
Finish Care	5-103
Instrument Panel, Vinyl, and Other Plastic	
Surfaces	5-101
Interior	5-99
Leather	5-101
Tires	5-105
Underbody Maintenance	5-106
Washing Your Vehicle	5-102
Weatherstrips	5-102
Windshield and Wiper Blades	5-104
Climate Control System	3-20
Air Filter, Passenger Compartment	3-29
Dual Automatic	3-24
Outlet Adjustment	3-28
Clock, Setting	3-85
Collision Damage Repair	7-12
Compact Spare Tire	5-98
Compass	3-56
Content Theft-Deterrent	2-20
Control of a Vehicle	4-3
Convenience Net	2-54
Coolant	
Engine Temperature Gage	3-40
Engine Temperature Warning Light	3-40
Heater, Engine	2-27
Low Warning Light	3-41
Cooling System	5-33
Courtesy Lamps	3-16
Cruise Control	3-10
Cruise Control Light	3-46
Cupholder(s)	2-52
Customer Assistance Information	
Courtesy Transportation	7-10
Customer Assistance for Text Telephone	
(TTY) Users	7-6
Customer Assistance Offices	7-6
Customer Satisfaction Procedure	7-2
GM Mobility Reimbursement Program	7-7
Reporting Safety Defects to General Motors	7-16
Reporting Safety Defects to the Canadian	
Government	7-15
Reporting Safety Defects to the United	
States Government	7-15
Roadside Assistance Program	7-8
Service Publications Ordering Information	7-16

D

Daytime Running Lamps/Automatic Headlamp System	3-14
Defensive Driving	4-2
Delayed Entry Lighting	3-17
Delayed Exit Lighting	3-17
Delayed Locking	2-12
DIC Compass	3-56
Diesel	
Running Out of Fuel	2-37
Disc, MP3	3-97
Doing Your Own Service Work	5-4
Door	
Ajar Light	3-47
Automatic Door Lock	2-12
Delayed Locking	2-12
Locks	2-11
Power Door Locks	2-11
Programmable Automatic Door Unlock	2-12
Rear Door Security Locks	2-12
Driver Information Center (DIC)	3-49
DIC Operation and Displays	3-50
DIC Vehicle Personalization	3-76
DIC Warnings and Messages	3-58

Driving	
At Night	4-13
Before a Long Trip	4-15
Defensive	4-2
Drunken	4-2
Highway Hypnosis	4-15
Hill and Mountain Roads	4-16
In Rain and on Wet Roads	4-14
Rocking Your Vehicle to Get it Out	4-21
Winter	4-17
Dual Automatic Climate Control System	3-24

E

EDR	7-17
Electrical System	
Add-On Equipment	5-108
Fuses and Circuit Breakers	5-109
Headlamp Wiring	5-109
Instrument Panel Fuse Block	5-110
Power Windows and Other Power Options	5-109
Underhood Fuse Block	5-112
Windshield Wiper Fuses	5-109

Engine	
Air Cleaner/Filter	5-23
Change Engine Oil Light	3-45
Check and Service Engine Soon Light	3-42
Coolant	5-27
Coolant Heater	2-27
Coolant Temperature Gage	3-40
Coolant Temperature Warning Light	3-40
Drive Belt Routing	6-14
Engine Compartment Overview	5-12
Exhaust	2-37
Oil	5-18
Oil Life System	5-21
Overheated Protection Operating Mode	5-32
Overheating	5-30
Reduced Power Light	3-46
Starting	2-26
Enhanced Traction System (ETS)	4-7
Warning Light	3-39
Entry Lighting	3-16
Event Data Recorders	7-18
Extender, Safety Belt	1-29
Exterior Lamps	3-13
Exterior Lighting Battery Saver	3-15

F

Filter	
Engine Air Cleaner	5-23
Finish Damage	5-105
Flashers, Hazard Warning	3-6
Flash-to-Pass	3-8
Flat Tire	5-86
Flat Tire, Changing	5-87
Flat Tire, Storing	5-95, 5-97
Fluid	5-25
Power Steering	5-43
Windshield Washer	5-44
Fog Lamp	
Fog	3-15
Folding Rear Seat	1-8
Fuel	
Additives	5-7
California Fuel	5-6
Check Gas Cap Light	3-49
Filling a Portable Fuel Container	5-10
Filling the Tank	5-8
Fuels in Foreign Countries	5-7
Gage	3-48
Gasoline Octane	5-5
Gasoline Specifications	5-6
Low Warning Light	3-48
Running Out of	2-37

Fuses	
Fuses and Circuit Breakers	5-109
Instrument Panel Fuse Block	5-110
Underhood Fuse Block	5-112
Windshield Wiper	5-109

G

Gage	
Engine Coolant Temperature	3-40
Fuel	3-48
Speedometer	3-32
Tachometer	3-32
Garage Door Opener	2-47
Gasoline	
Octane	5-5
Specifications	5-6
Glove Box	2-52
GM Mobility Reimbursement Program	7-7

H

Hazard Warning Flashers	3-6
Head Restraints	1-6
Headlamp	
Aiming	5-56
Headlamp Wiring	5-109

Headlamps	
Bulb Replacement	5-58
Daytime Running Lamps/Automatic Headlamp System	3-14
Exterior Lamps	3-13
Flash-to-Pass	3-8
Halogen Bulbs	5-58
High/Low Beam Changer	3-8
Suggested Light	3-47
Heated Seats	1-3
Heater	3-20
Heater	3-24
Highbeam On Light	3-46
Highway Hypnosis	4-15
Hill and Mountain Roads	4-16
Hood	
Checking Things Under	5-10
Release	5-11
Horn	3-6
How to Wear Safety Belts Properly	1-14

I

Ignition Positions	2-24
Infants and Young Children, Restraints	1-33
Inflation - Tire Pressure	5-70
Instrument Panel	
Overview	3-4

Instrument Panel (I/P)	
Brightness	3-16
Cluster	3-31
Interior Lamps	3-16

J

Jump Starting	5-50
---------------------	------

K

Keyless Entry System	2-4
Keys	2-3

L

Labeling, Tire Sidewall	5-64
Lamps	
Courtesy	3-16
Exterior Lighting Battery Saver	3-15
Overhead Console Reading	3-18
Rear Assist Handle Reading	3-18
Lap Belt	1-28
Lap-Shoulder Belt	1-22
LATCH System	
Child Restraints	1-41
License Plate Lamps	5-61

Light

Airbag Readiness	3-33
Antilock Brake System Warning	3-38
Brake System Warning	3-37
Change Engine Oil	3-45
Charging System	3-36
Check Gas Cap	3-49
Cruise Control	3-46
Door Ajar	3-47
Engine Coolant Temperature Warning	3-40
Enhanced Traction System (ETS)	
Warning Light	3-39
Headlamps Suggested	3-47
Highbeam On	3-46
Low Coolant Warning	3-41
Low Fuel Warning	3-48
Low Washer Fluid Warning	3-47
Malfunction Indicator	3-42
Oil Pressure	3-45
Passenger Airbag Status Indicator	3-34
Reduced Engine Power	3-46
Safety Belt Reminders	3-32
Security	3-45
Service Vehicle Soon	3-48
TCS Warning Light	3-38
Tire Pressure	3-41
Traction Control System (TCS) Warning	3-38
Trunk Ajar	3-47

Lighting	
Delayed Entry	3-17
Delayed Exit	3-17
Entry	3-16
Perimeter	3-17
Theater Dimming	3-17
Lights	
Exterior Lamps	3-13
Flash-to-Pass	3-8
High/Low Beam Changer	3-8
Interior Lamps	3-16
Loading Your Vehicle	4-21
Lockout Protection	2-13
Locks	
Automatic Door Lock	2-12
Delayed Locking	2-12
Door	2-11
Lockout Protection	2-13
Power Door	2-11
Programmable Automatic Door Unlock	2-12
Rear Door Security Locks	2-12
Loss of Control	4-12
Low Coolant Warning Light	3-41
Low Fuel Warning Light	3-48
Low Washer Fluid Warning Light	3-47
Lumbar	
Power Controls	1-3

M

Maintenance Schedule	
Additional Required Services	6-6
At Each Fuel Fill	6-8
At Least Once a Month	6-9
At Least Once a Year	6-9
Introduction	6-2
Maintenance Footnotes	6-7
Maintenance Record	6-16
Maintenance Replacement Parts	6-13
Maintenance Requirements	6-2
Owner Checks and Services	6-8
Recommended Fluids and Lubricants	6-12
Scheduled Maintenance	6-4
Using	6-2
Your Vehicle and the Environment	6-2
Malfunction Indicator Light	3-42
Manual, Using	iii
Message	
DIC Warnings and Messages	3-58
Mirrors	
Automatic Dimming Rearview	2-39
Automatic Dimming Rearview with OnStar®	2-39
Manual Rearview Mirror	2-38
Manual Rearview Mirror with OnStar®	2-38
Outside Convex Mirror	2-40
Outside Power Heated Mirrors	2-40
Outside Power Mirrors	2-40

MP3	3-97
MyGMLink.com	7-5

N

Navigation System, Privacy	7-19
New Vehicle Break-In	2-24

O

Odometer	3-32
Off-Road Recovery	4-11
Oil	
Change Engine Oil Light	3-45
Engine	5-18
Pressure Light	3-45
Oil, Engine Oil Life System	5-21
Older Children, Restraints	1-29
Online Owner Center	7-5
OnStar, Privacy	7-19
OnStar [®] System, see OnStar [®] Manual	2-43
Operation, Universal Home Remote System	2-48
Other Warning Devices	3-6
Outlet Adjustment	3-28
Outlets	
Accessory Power	3-19

Outside	
Convex Mirror	2-40
Power Heated Mirrors	2-40
Power Mirrors	2-40
Overhead Console Reading Lamps	3-18
Overheated Engine Protection	
Operating Mode	5-32
Owner Checks and Services	6-8
Owners, Canadian	ii

P

Paint, Damage	5-105
Park Aid	2-41
Park Brake	2-32
Park (P)	
Shifting Into	2-33
Shifting Out of	2-35
Parking	
Assist	2-41
Over Things That Burn	2-36
Passenger Airbag Status Indicator	3-34
Passenger Compartment Air Filter	3-29
Passenger Sensing System	1-62
Passing	4-11
PASS-Key [®] III	2-22
PASS-Key [®] III Operation	2-22
Perchlorate Materials Requirements, California	5-4

Perimeter Lighting	3-17
Power	
Door Locks	2-11
Electrical System	5-109
Lumbar Controls	1-3
Reduced Engine Light	3-46
Retained Accessory (RAP)	2-25
Seat	1-2
Steering Fluid	5-43
Windows	2-18
Pressure Cap	5-30
Privacy	7-17
Event Data Recorders	7-18
Navigation System	7-19
OnStar	7-19
Radio Frequency Identification	7-19
Programmable Automatic Door Unlock	2-12

R

Radiator Pressure Cap	5-29
Radio Frequency Identification (RFID), Privacy	7-19
Radios	3-84
Radio(s)	3-86
Radios	
Reception	3-103
Setting the Clock	3-85
Theft-Deterrent	3-101
Rear Assist Handle Reading Lamps	3-18

Rear Door Security Locks	2-12
Rearview Mirror, Automatic Dimming	2-39
Rearview Mirror, Automatic Dimming with OnStar®	2-39
Rearview Mirror with OnStar®	2-38
Rearview Mirrors	2-38
Reclining Seatbacks	1-4
Recommended Fluids and Lubricants	6-12
Recreational Vehicle Towing	4-27
Reduced Engine Power Light	3-46
Remote Keyless Entry (RKE) System	2-4
Remote Keyless Entry (RKE) System, Operation	2-5
Remote Vehicle Start	2-8
Removing the Flat Tire and Installing the Spare Tire	5-89
Removing the Spare Tire and Tools	5-88
Replacement Bulbs	5-61
Replacement Parts, Maintenance	6-13
Replacement, Windshield	5-62
Reporting Safety Defects	
Canadian Government	7-15
General Motors	7-16
United States Government	7-15
Restraint System Check	
Checking the Restraint Systems	1-68
Replacing Restraint System Parts After a Crash	1-69
Retained Accessory Power (RAP)	2-25

StabiliTrak® System	4-8
Start Vehicle, Remote	2-8
Starting the Engine	2-26
Steering	4-9
Steering Wheel Controls, Audio	3-102
Steering Wheel, Tilt Wheel	3-6
Storage Areas	
Center Console Storage Area	2-53
Convenience Net	2-54
Cupholder(s)	2-52
Glove Box	2-52
Stuck in Sand, Mud, Ice, or Snow	4-20
Sun Visors	2-19
Sunroof	2-54

T

Tachometer	3-32
Taillamps	
Turn Signal, Sidemarker, Stoplamps, and Back-Up Lamps	5-59
TCS Warning Light	3-38
Theater Dimming	3-17
Theft-Deterrent, Radio	3-101
Theft-Deterrent Systems	2-20
Content Theft-Deterrent	2-20
PASS-Key® III	2-22
PASS-Key® III Operation	2-22

Tilt Wheel	3-6
Time, Setting	3-85
Tire	
Pressure Light	3-41
Tires	5-63
Aluminum or Chrome-Plated Wheels, Cleaning	5-104
Buying New Tires	5-78
Chains	5-84
Changing a Flat Tire	5-87
Cleaning	5-105
Compact Spare Tire	5-98
Different Size	5-80
If a Tire Goes Flat	5-86
Inflation - Tire Pressure	5-70
Inspection and Rotation	5-75
Installing the Spare Tire	5-89
Pressure Monitor Operation	5-73
Pressure Monitor System	5-71
Removing the Flat Tire	5-89
Removing the Spare Tire and Tools	5-88
Storing a Flat or Spare Tire and Tools	5-95, 5-97
Tire Sidewall Labeling	5-64
Tire Terminology and Definitions	5-67
Uniform Tire Quality Grading	5-80
Wheel Alignment and Tire Balance	5-82
Wheel Replacement	5-82
When It Is Time for New Tires	5-77

Towing	
Recreational Vehicle	4-27
Towing a Trailer	4-28
Your Vehicle	4-27
Traction	
Control System (TCS)	4-6
Control System Warning Light	3-38
Enhanced Traction System (ETS)	4-7
Enhanced Traction System (ETS) Warning Light	3-39
StabiliTrak [®] System	4-8
Transmission	
Fluid, Automatic	5-25
Transmission Operation, Automatic	2-29
Trunk	2-14
Trunk Ajar Light	3-47
Turn and Lane-Change Signals	3-8
Turn Signal/Multifunction Lever	3-7

U

Ultrasonic Rear Parking Assist (URPA)	2-41
Uniform Tire Quality Grading	5-80

Universal Home Remote System	2-47
Operation	2-48
Using this Manual	iii

V

Vehicle	
Control	4-3
Damage Warnings	iv
Loading	4-21
Service Soon Light	3-48
Symbols	iv
Vehicle Data Recording and Privacy	7-17
Vehicle Identification	
Number (VIN)	5-107
Service Parts Identification Label	5-108
Vehicle Personalization	
DIC	3-76
Vehicle, Remote Start	2-8
Ventilation Adjustment	3-28
Visors	2-19

W

Warning Lights, Gages and Indicators	3-30
Warnings	
DIC Warnings and Messages	3-58
Hazard Warning Flashers	3-6
Other Warning Devices	3-6
Safety and Symbols	iii
Vehicle Damage	iv
Washer Fluid, Low Warning Light	3-47
Wheels	
Alignment and Tire Balance	5-82
Different Size	5-80
Replacement	5-82
Where to Put the Restraint	1-39
Windows	2-17
Power	2-18

Windshield	
Replacement	5-62
Washer	3-9
Washer Fluid	5-44
Wiper Blade Replacement	5-62
Wiper Blades, Cleaning	5-104
Wiper Fuses	5-109
Wipers	3-9
Winter Driving	4-17

X

XM Radio Messages	3-100
XM™ Satellite Radio Antenna System	3-105

Y

Your Vehicle and the Environment	6-2
--	-----