

'98

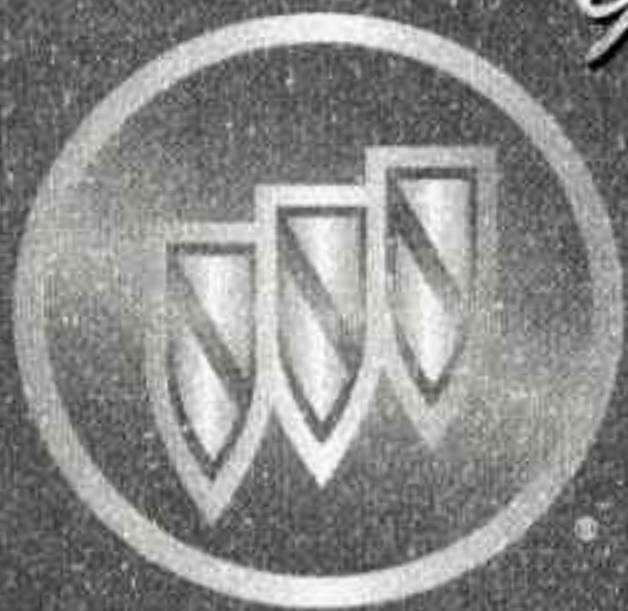

PARK AVENUE



**Buick backs  
every  
1998 Park Avenue  
under warranty  
with the  
following  
services**

**Bumper-to-Bumper  
3-years/36,000 miles  
(60 000 km)  
Limited Warranty**

**Courtesy  
Transportation**

**24-hour  
Buick Premium  
Roadside Assistance  
1-800-252-1112**

*(In Canada, call 1-800-268-6800)*  
**that provides in an emergency:**

- Free lockout assistance
- Free dead-battery assistance
- Free out-of-fuel assistance
- Free flat-tire change
- Emergency towing service



**THE INFORMATION ON THE NEXT FEW PAGES IS TO HELP YOU FIND THE MOST COMMONLY REFERRED TO TOPICS QUICKLY. FOR INFORMATION NOT INCLUDED HERE, PLEASE USE THE TABLE OF CONTENTS OR THE INDEX IN THE MANUAL.**

## Safety

Section 1

Wearing a safety belt correctly is one of the most important things you and your passengers can do. This section contains very important information about safety belt usage, air bags and child restraints.

## Adjusting the Seat

Pages 1-2  
to 1-7

One of the first things you'll probably want to do when you get in your new vehicle is adjust the power seats.

## Maintaining the Temperature

Pages 3-2  
to 3-9

Read through these pages to learn more about how to use the heating, cooling, defogging and defrosting features in your vehicle.

## Setting the Clock

Page 3-10

To set the clock, press and hold HRS until the correct hour appears. Press and hold MIN until the correct minute appears.





## Features and Controls

Sections  
2 & 3

*Included in section 2 is a picture of the overall instrument panel (page 2-70). The location of the features and controls you will use are noted here. Refer to the following pages for information about:*

- Power Door Locks Page 2-5
- Power Windows Page 2-33
- Tilt Steering Wheel Page 2-35
- Turn Signal Lever Page 2-35
- Changing the High/Low Beams Page 2-37
- Windshield Wipers And Washer Page 2-38
- Cruise Control Page 2-40
- Turning on Headlamps and Other Lamps Page 2-44
- Power Remote Control Mirrors Page 2-55
- Warning Lights and Gages Page 2-75
- Rear Window Defogger Page 3-8



## Audio

Section 3

- AM-FM Stereos with Cassette Tape Players, Compact Disc Players and Tone Control Page 3-10
- Trunk - Mounted 12 - Disc CD Changer Page 3-27

**Problems That  
May Occur  
While  
Driving**

**Section 5**

**Special Features  
That May Be  
On Your  
Vehicle**

**Sections  
2 & 3**

*Although we hope you'll never run into trouble on the road, refer to the following pages for help with some of the most common problems that may occur.*

- How to turn on your hazard warning flashers **Page 5-2**
- How to jump start your vehicle **Page 5-3**
- How your vehicle should be towed **Page 5-7**
- What to do if your engine overheats **Page 5-12**
- How to change a flat tire **Page 5-22**

- Heated Front Seat **Page 1-5**
- Remote Keyless Entry (RKE) **Page 2-8**
- Personal Choice Features **Page 2-10**
- Theft-Deterrent System **Page 2-16**
- PASS-Key® III **Page 2-18**
- Moisture-Sensing Wipers **Page 2-39**
- Astrorooft **Page 2-65**
- Driver Information Center (DIC) **Page 2-86**
- Steering Wheel Controls **Page 3-9, 3-33**





# The 1998 Buick Park Avenue Owner's Manual

---

## **1-1 Seats and Restraint Systems**

This section tells you how to use your seats and safety belts properly. It also explains the "SRS" system.

## **2-1 Features and Controls**

This section explains how to start and operate your vehicle.

## **3-1 Comfort Controls and Audio Systems**

This section tells you how to adjust the ventilation and comfort controls and how to operate your audio system.

## **4-1 Your Driving and the Road**

Here you'll find helpful information and tips about the road and how to drive under different conditions.

## **5-1 Problems on the Road**

This section tells what to do if you have a problem while driving, such as a flat tire or overheated engine, etc.

## **6-1 Service and Appearance Care**

Here the manual tells you how to keep your vehicle running properly and looking good.

## **7-1 Maintenance Schedule**

This section tells you when to perform vehicle maintenance and what fluids and lubricants to use.

## **8-1 Customer Assistance Information**

This section tells you how to contact Buick for assistance and how to get service and owner publications. It also gives you information on "Reporting Safety Defects" on page 8-8.

## **9-1 Index**

Here's an alphabetical listing of almost every subject in this manual. You can use it to quickly find something you want to read.





GENERAL MOTORS, GM, the GM Emblem, BUICK, the BUICK Emblem and the name PARK AVENUE are registered trademarks of General Motors Corporation.

This manual includes the latest information at the time it was printed. We reserve the right to make changes in the product after that time without further notice. For vehicles first sold in Canada, substitute the name "General Motors of Canada Limited" for Buick Motor Division whenever it appears in this manual.

Please keep this manual in your vehicle, so it will be there if you ever need it when you're on the road. If you sell the vehicle, please leave this manual in it so the new owner can use it.



We support voluntary technician certification.

## For Canadian Owners Who Prefer a French Language Manual:

**Aux propriétaires canadiens:** Vous pouvez vous procurer un exemplaire de ce guide en français chez votre concessionnaire ou au:

DGN Marketing Services Ltd.  
1577 Meyerside Dr.  
Mississauga, Ontario L5T 1B9

## How to Use this Manual

Many people read their owner's manual from beginning to end when they first receive their new vehicle. If you do this, it will help you learn about the features and controls for your vehicle. In this manual, you'll find that pictures and words work together to explain things quickly.

## Index

A good place to look for what you need is the Index in back of the manual. It's an alphabetical list of what's in the manual, and the page number where you'll find it.

## Safety Warnings and Symbols

You will find a number of safety cautions in this book. We use a box and the word CAUTION to tell you about things that could hurt you if you were to ignore the warning.



### CAUTION:

**These mean there is something that could hurt you or other people.**

In the caution area, we tell you what the hazard is. Then we tell you what to do to help avoid or reduce the hazard. Please read these cautions. If you don't, you or others could be hurt.



You will also find a circle with a slash through it in this book. This safety symbol means "Don't," "Don't do this" or "Don't let this happen."

## Vehicle Damage Warnings

Also, in this book you will find these notices:

### **NOTICE:**

**These mean there is something that could damage your vehicle.**

In the notice area, we tell you about something that can damage your vehicle. Many times, this damage would not be covered by your warranty, and it could be costly. But the notice will tell you what to do to help avoid the damage.

When you read other manuals, you might see CAUTION and NOTICE warnings in different colors or in different words.

You'll also see warning labels on your vehicle. They use the same words, CAUTION or NOTICE.



## Vehicle Symbols

These are some of the symbols you may find on your vehicle.

For example, these symbols are used on an original battery:

CAUTION  
POSSIBLE  
INJURY



PROTECT  
EYES BY  
SHIELDING



CAUSTIC  
BATTERY  
ACID COULD  
CAUSE  
BURNS



AVOID  
SPARKS OR  
FLAMES



SPARK OR  
FLAME  
COULD  
EXPLODE  
BATTERY



These symbols are important for you and your passengers whenever your vehicle is driven:

DOOR LOCK  
UNLOCK



FASTEN  
SEAT  
BELTS



POWER  
WINDOW



AIR BAG



These symbols have to do with your lamps:

MASTER  
LIGHTING  
SWITCH



TURN  
SIGNALS



PARKING  
LAMPS

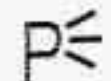

HAZARD  
WARNING  
FLASHER



DAYTIME  
RUNNING  
LAMPS



FOG LAMPS



These symbols are on some of your controls:

WINDSHIELD  
WIPER



WINDSHIELD  
WASHER



WINDSHIELD  
DEFOGGER



REAR  
WINDOW  
DEFOGGER



VENTILATING  
FAN



These symbols are used on warning and indicator lights:

ENGINE  
COOLANT  
TEMP



BATTERY  
CHARGING  
SYSTEM



BRAKE



COOLANT



ENGINE OIL  
PRESSURE



ANTI-LOCK  
BRAKES



Here are some other symbols you may see:

FUSE



LIGHTER



HORN



SPEAKER



FUEL







## Section 1 Seats and Restraint Systems

---

Here you'll find information about the seats in your Buick and how to use your safety belts properly. You can also learn about some things you should *not* do with air bags and safety belts.

1-2	Seats and Seat Controls	1-28	Rear Seat Passengers
1-8	Safety Belts: They're for Everyone	1-32	Rear Safety Belt Comfort Guides for Children and Small Adults
1-12	Here Are Questions Many People Ask About Safety Belts -- and the Answers	1-34	Children
1-13	How to Wear Safety Belts Properly	1-37	Child Restraints
1-13	Driver Position	1-47	Larger Children
1-20	Safety Belt Use During Pregnancy	1-50	Safety Belt Extender
1-21	Right Front Passenger Position	1-50	Checking Your Restraint Systems
1-21	Supplemental Restraint System (SRS)	1-50	Replacing Restraint System Parts After a Crash
1-27	Center Passenger Position		



## Seats and Seat Controls

This part tells you about the seats — how to adjust them, and also about memory seats, reclining seatbacks and head restraints.

### 4-way Power Lumbar Control (Option)

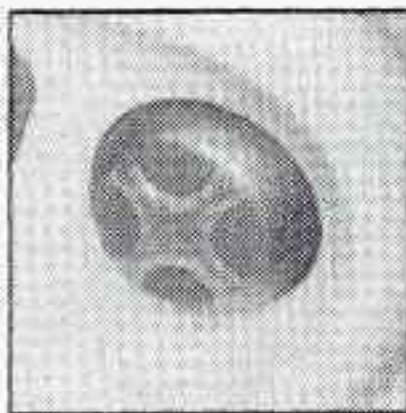

If you have this option, the driver's and passenger's seatback lumbar support can be adjusted four ways by moving the single switch located on the side of the seat.

To increase or decrease support, hold the switch forward or rearward. To move the lumbar up and down, hold the switch upward or downward.

## Power Seats

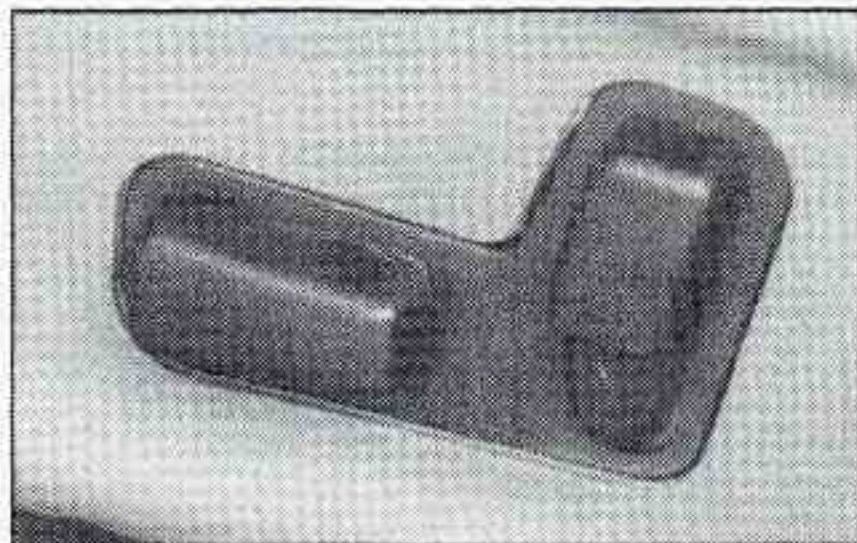

- Raise or lower the front of the seat cushion by holding the front part of the horizontal control up or down.

- Raise or lower the rear of the seat cushion by holding the rear part of the horizontal control up or down.
- Raise or lower the entire seat cushion by holding the whole horizontal control up or down.
- Move the seat forward or back by pushing the horizontal control to the front or back.
- Push the vertical control forward to bring the seat to a more upright position. Push it rearward to recline the seatback.
- Raise or lower the shoulder belt and head rest by pushing the vertical control to the top or bottom.

## Memory Seat and Mirrors (If Equipped)



If your vehicle has this option, the control on the driver's door panel looks like this.

You can use this memory function to save your seat cushion (minus the head restraint), optional lumbar, mirror adjustment, window lockout, HVAC and radio settings by using the following procedure:

1. You must first program the SEAT RECALL feature to be ON when this choice appears on the DIC. See "Memory Seat Recall" in the Index for programming instructions.

2. Adjust the driver's seat and lumbar position (if equipped) to a safe and comfortable driving position. Adjust both outside mirrors to suit you. See "Outside Mirrors" in the Index.
3. Press one of the two MEMORY buttons corresponding with your driver number, for longer than three seconds. You will hear two beeps to confirm that the mirror and seat positions have been entered into memory.
4. Press UNLOCK on the transmitter within five seconds.

When your vehicle is in PARK (P), push and release the memory button you just stored. The seat and mirrors will move to the set position. You will hear one beep.

To set the seat and mirror positions for a second driver, follow the previous steps, but use the other MEMORY button.

If you press the wrong MEMORY button, or if there is a third driver, use the seat adjuster.

The EXIT button allows for easy exit from the vehicle. Push and release the EXIT button while in PARK (P) and the seat will move all the way back. You will hear a beep when the EXIT button is pressed.

You can also set unique exit positions by moving the seat to the desired position, and then pushing and holding the EXIT button for greater than three seconds. You will hear two beeps to confirm the position has been set. The exit position will be set for the previously identified driver.

If the ignition is not in RUN, automatic seat and mirror movement will occur if the UNLOCK button on the remote keyless entry transmitter is pressed. Automatic seat and mirror movement is programmed through the Driver Information Center (DIC) so that the driver can select whether the seat moves to the programmed driving position, the programmed exit position, or does not move at all. For memory seat and mirror recall programming instructions, see "DIC Personal Choice Programming" in the Index.



## Heated Seats (Option)



The heated seat controls are located next to the climate controls on the instrument panel. Press this button to turn on the heating element in the seat.

The LO setting warms the seatback and cushion until the seat nears body temperature. The HI setting heats the seat to a slightly higher temperature.

A telltale light in the control reminds you that the heating system is in use.

## Reclining Front Seatbacks



The front seatbacks can be adjusted by pressing the vertical control located on the side of the seat. Push it forward to bring the seat to a more upright position. Push it rearward to recline the seatback.



But don't have a seatback reclined if your vehicle is moving.

**⚠ CAUTION:**

Sitting in a reclined position when your vehicle is in motion can be dangerous. Even if you buckle up, your safety belts can't do their job when you're reclined like this.

The shoulder belt can't do its job. In a crash you could go into it, receiving neck or other injuries.

The lap belt can't do its job either. In a crash the belt could go up over your abdomen. The belt forces would be there, not at your pelvic bones. This could cause serious internal injuries.

For proper protection when the vehicle is in motion, have the seatback upright. Then sit well back in the seat and wear your safety belt properly.



## Head Restraints

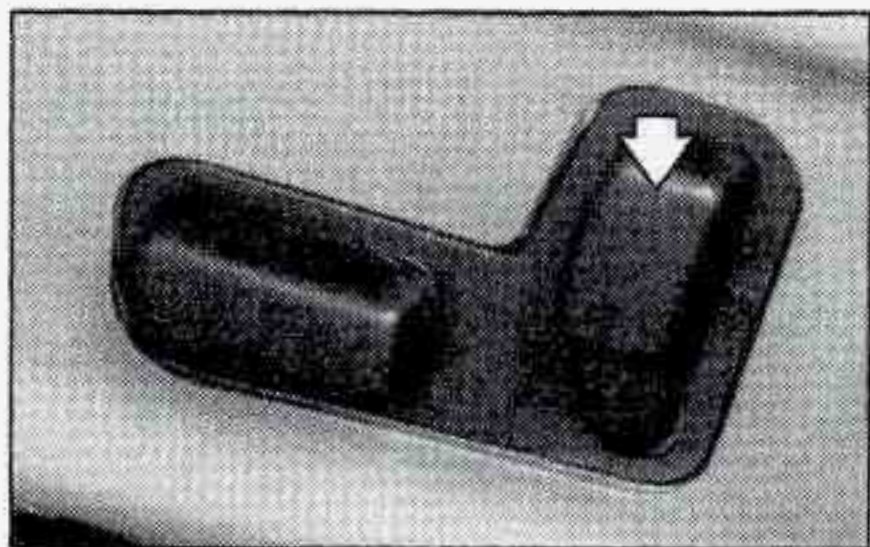

Use this switch to move a front head restraint up or down. Lift up on the switch to move the head restraint up. Press down on the switch to move the head restraint down. The top of the head restraint should be closest to the top of your ears. This position helps reduce the chance of a neck injury in a crash. When you move a front seat head restraint up or down, the shoulder belt height changes. On some models, the head restraints tilt forward and rearward also.

Some rear seats have adjustable head restraints. Slide an adjustable head restraint up or down so that the top of the restraint is closest to the top of your ears. This position reduces the chance of a neck injury in a crash.

On some models, the rear seat head restraints tilt forward and rearward also.

There are four different positions for the front seat head restraints and three different positions for the rear seat head restraints. Adjust either head restraint by grasping the top of the restraint and moving it forward the way you want it to go until you hear a click. It will then be locked into that position until you need to move it again. Pulling it forward past the last position will allow the headrest to return to its full rear position.



## Safety Belts: They're for Everyone

This part of the manual tells you how to use safety belts properly. It also tells you some things you should not do with safety belts.

And it explains the Supplemental Restraint System (SRS), or air bag system.

### CAUTION:

**Don't let anyone ride where he or she can't wear a safety belt properly. If you are in a crash and you're not wearing a safety belt, your injuries can be much worse. You can hit things inside the vehicle or be ejected from it. You can be seriously injured or killed. In the same crash, you might not be if you are buckled up. Always fasten your safety belt, and check that your passengers' belts are fastened properly too.**

### CAUTION:

**It is extremely dangerous to ride in a cargo area, inside or outside of a vehicle. In a collision, people riding in these areas are more likely to be seriously injured or killed. Do not allow people to ride in any area of your vehicle that is not equipped with seats and safety belts. Be sure everyone in your vehicle is in a seat and using a safety belt properly.**



Your vehicle has a light that comes on as a reminder to buckle up. (See "Safety Belt Reminder Light" in the Index.)

In most states and Canadian provinces, the law says to wear safety belts. Here's why: *They work.*

You never know if you'll be in a crash. If you do have a crash, you don't know if it will be a bad one.

A few crashes are mild, and some crashes can be so serious that even buckled up a person wouldn't survive. But most crashes are in between. In many of them, people who buckle up can survive and sometimes walk away. Without belts they could have been badly hurt or killed.

After more than 30 years of safety belts in vehicles, the facts are clear. In most crashes buckling up does matter ... a lot!

## Why Safety Belts Work

When you ride in or on anything, you go as fast as it goes.

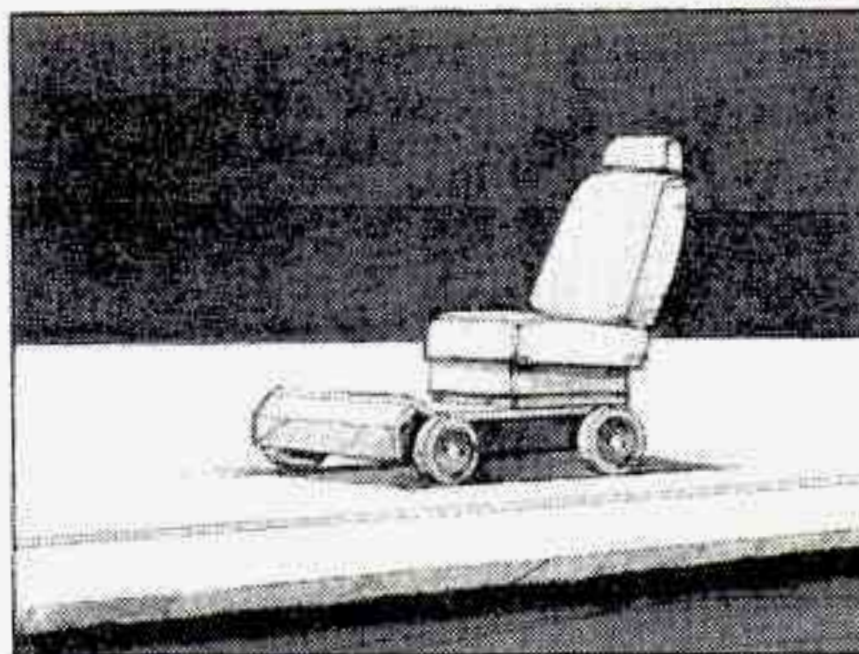

Take the simplest vehicle. Suppose it's just a seat on wheels.



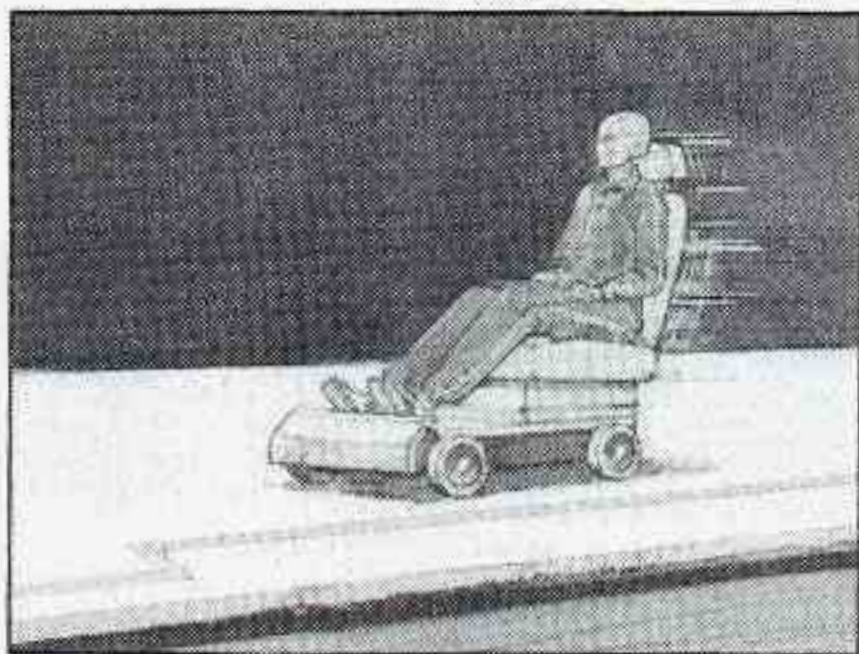

Put someone on it.

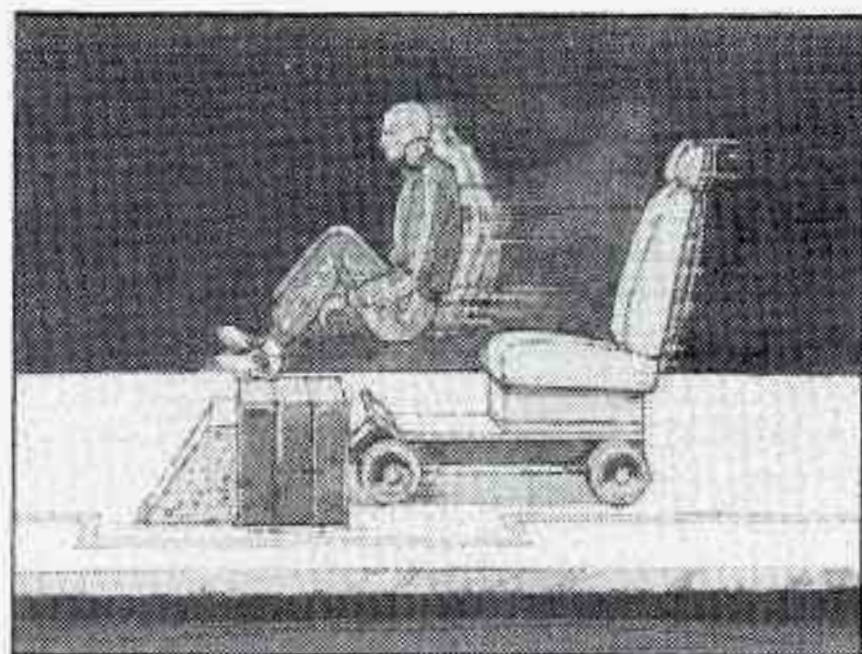

Get it up to speed. Then stop the vehicle. The rider doesn't stop.





The person keeps going until stopped by something.  
In a real vehicle, it could be the windshield ...

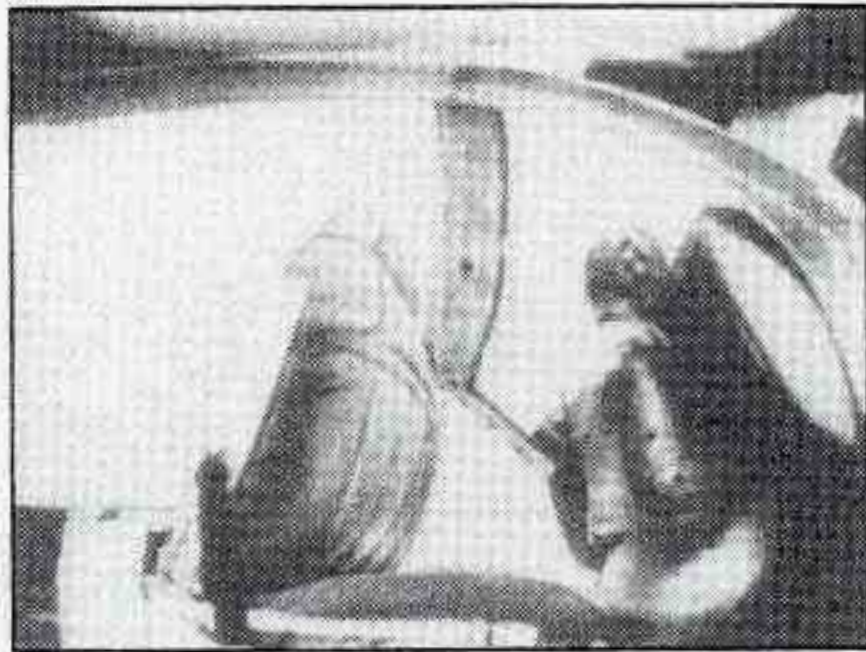

or the instrument panel ...



or the safety belts!

With safety belts, you slow down as the vehicle does. You get more time to stop. You stop over more distance, and your strongest bones take the forces. That's why safety belts make such good sense.

## Here Are Questions Many People Ask About Safety Belts -- and the Answers

**Q:** Won't I be trapped in the vehicle after an accident if I'm wearing a safety belt?

**A:** You *could* be -- whether you're wearing a safety belt or not. But you can unbuckle a safety belt, even if you're upside down. And your chance of being conscious during and after an accident, so you *can* unbuckle and get out, is *much* greater if you are belted.

**Q:** If my vehicle has air bags, why should I have to wear safety belts?

**A:** Air bags are in many vehicles today and will be in most of them in the future. But they are supplemental systems only; so they work *with* safety belts -- not instead of them. Every air bag system ever offered for sale has required the use of safety belts. Even if you're in a vehicle that has air bags, you still have to buckle up to get the most protection. That's true not only in frontal collisions, but especially in side and other collisions.

**Q:** If I'm a good driver, and I never drive far from home, why should I wear safety belts?

**A:** You may be an excellent driver, but if you're in an accident -- even one that isn't your fault -- you and your passengers can be hurt. Being a good driver doesn't protect you from things beyond your control, such as bad drivers.

Most accidents occur within 25 miles (40 km) of home. And the greatest number of serious injuries and deaths occur at speeds of less than 40 mph (65 km/h).

Safety belts are for everyone.

## How to Wear Safety Belts Properly

### Adults

This part is only for people of adult size.

Be aware that there are special things to know about safety belts and children. And there are different rules for smaller children and babies. If a child will be riding in your vehicle, see the part of this manual called "Children." Follow those rules for everyone's protection.

First, you'll want to know which restraint systems your vehicle has.

We'll start with the driver position.

### Driver Position

This part describes the driver's restraint system.



## Lap-Shoulder Belt

The driver has a lap-shoulder belt. Here's how to wear it properly.

1. Close and lock the door.
2. Adjust the seat (to see how, see "Seats" in the Index) so you can sit up straight.



3. Pick up the latch plate and pull the belt across you. Don't let it get twisted.
4. Push the latch plate into the buckle until it clicks.

Pull up on the latch plate to make sure it is secure. If the belt isn't long enough, see "Safety Belt Extender" at the end of this section.

Make sure the release button on the buckle is positioned so you would be able to unbuckle the safety belt quickly if you ever had to.

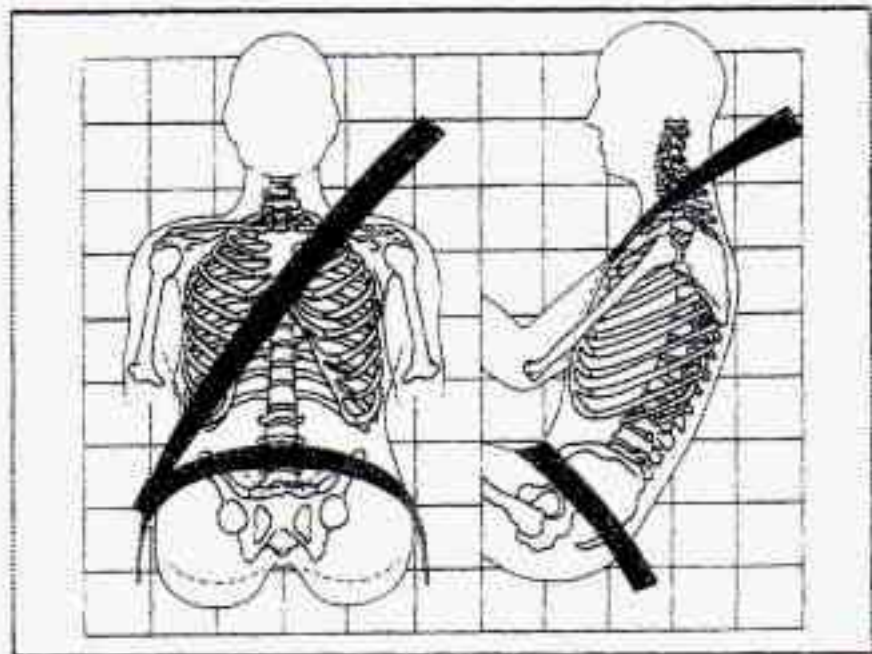

The lap part of the belt should be worn low and snug on the hips, just touching the thighs. In a crash, this applies force to the strong pelvic bones. And you'd be less likely

to slide under the lap belt. If you slid under it, the belt would apply force at your abdomen. This could cause serious or even fatal injuries. The shoulder belt should go over the shoulder and across the chest. These parts of the body are best able to take belt restraining forces.

The safety belt locks if there's a sudden stop or crash.

#### Shoulder Belt Height Adjuster

When you move a front seat head restraint, the shoulder belt height changes. See "Head Restraints" in the Index.

**Q:** What's wrong with this?

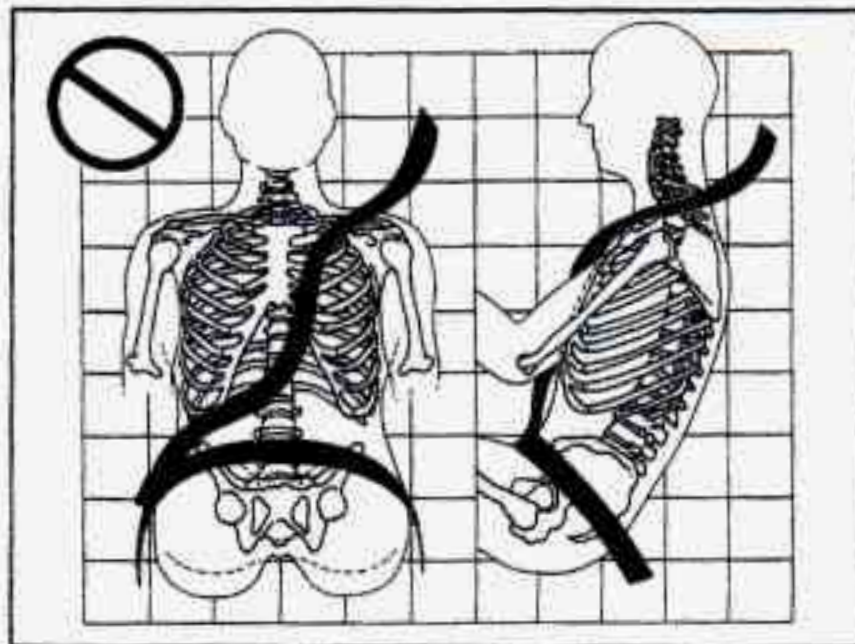

**A:** The shoulder belt is too loose. It won't give nearly as much protection this way.



**CAUTION:**

You can be seriously hurt if your shoulder belt is too loose. In a crash, you would move forward too much, which could increase injury. The shoulder belt should fit against your body.



**Q:** What's wrong with this?

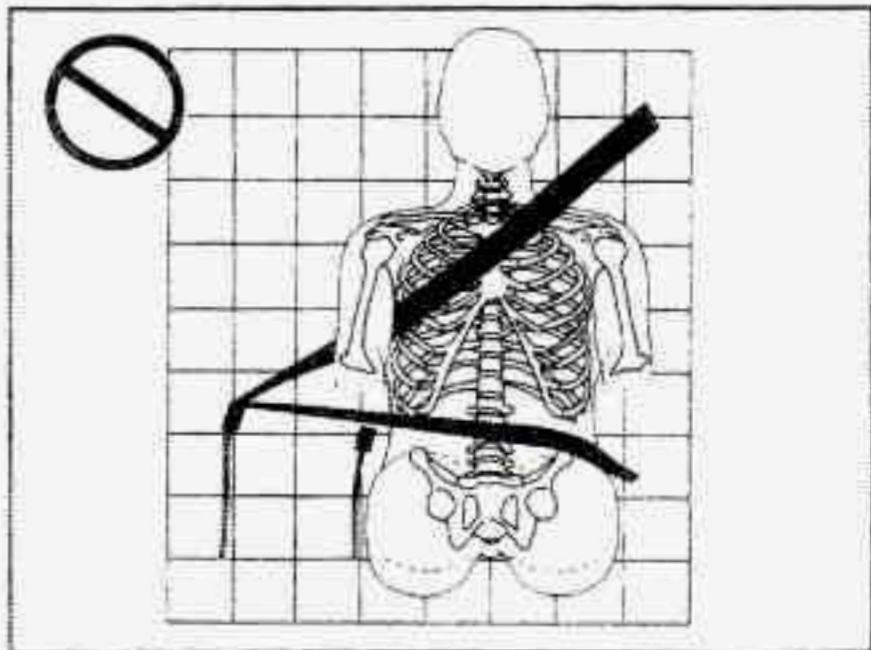

**A:** The belt is buckled in the wrong place.



**CAUTION:**

You can be seriously injured if your belt is buckled in the wrong place like this. In a crash, the belt would go up over your abdomen. The belt forces would be there, not at the pelvic bones. This could cause serious internal injuries. Always buckle your belt into the buckle nearest you.

**Q:** What's wrong with this?

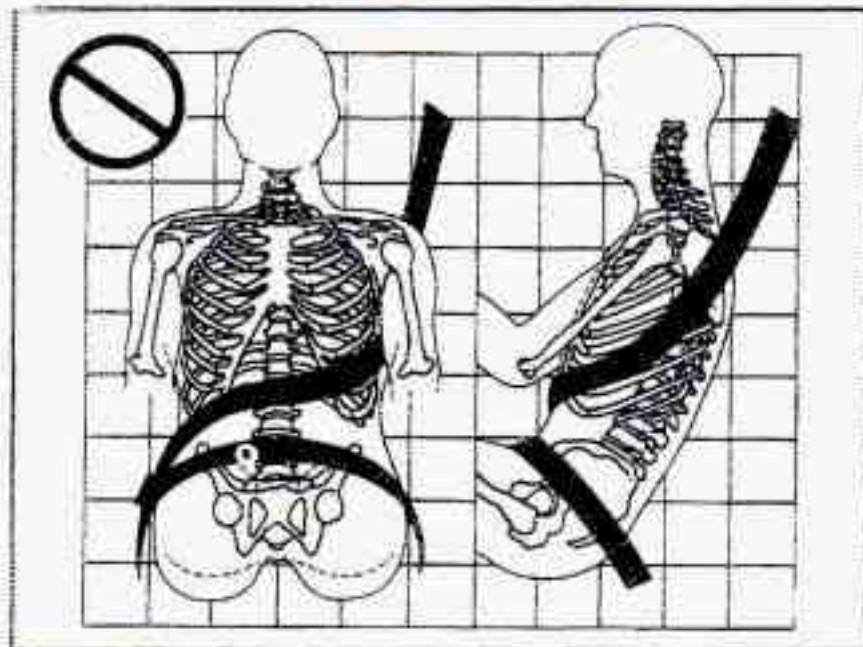

**A:** The shoulder belt is worn under the arm. It should be worn over the shoulder at all times.

 **CAUTION:**

You can be seriously injured if you wear the shoulder belt under your arm. In a crash, your body would move too far forward, which would increase the chance of head and neck injury. Also, the belt would apply too much force to the ribs, which aren't as strong as shoulder bones. You could also severely injure internal organs like your liver or spleen.

**Q:** What's wrong with this?

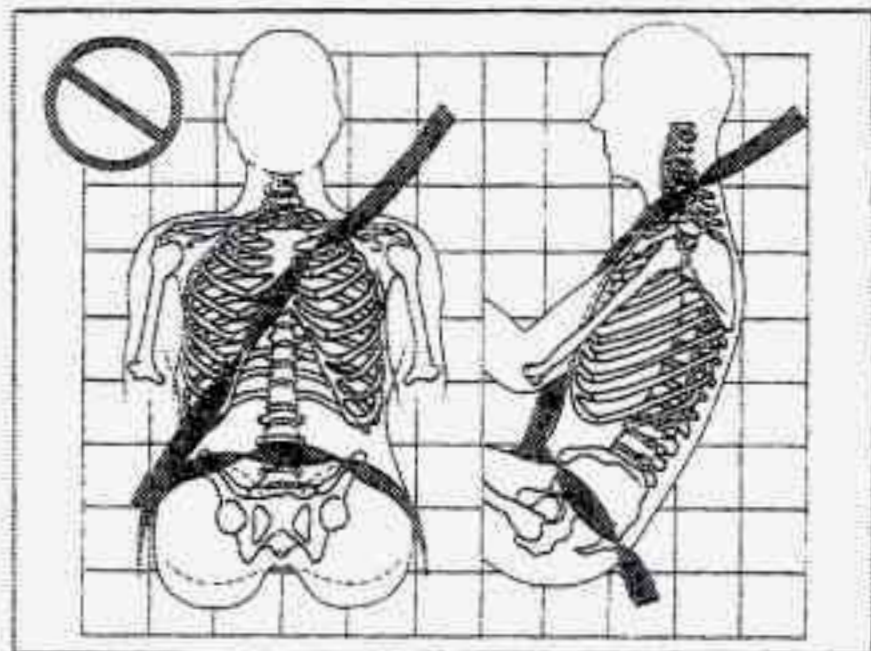

**A:** The belt is twisted across the body.

**CAUTION:**

You can be seriously injured by a twisted belt. In a crash, you wouldn't have the full width of the belt to spread impact forces. If a belt is twisted, make it straight so it can work properly, or ask your dealer to fix it.





To unlatch the belt, just push the button on the buckle. The belt should go back out of the way.

Before you close the door, be sure the belt is out of the way. If you slam the door on it, you can damage both the belt and your vehicle.

## Safety Belt Use During Pregnancy

Safety belts work for everyone, including pregnant women. Like all occupants, they are more likely to be seriously injured if they don't wear safety belts.

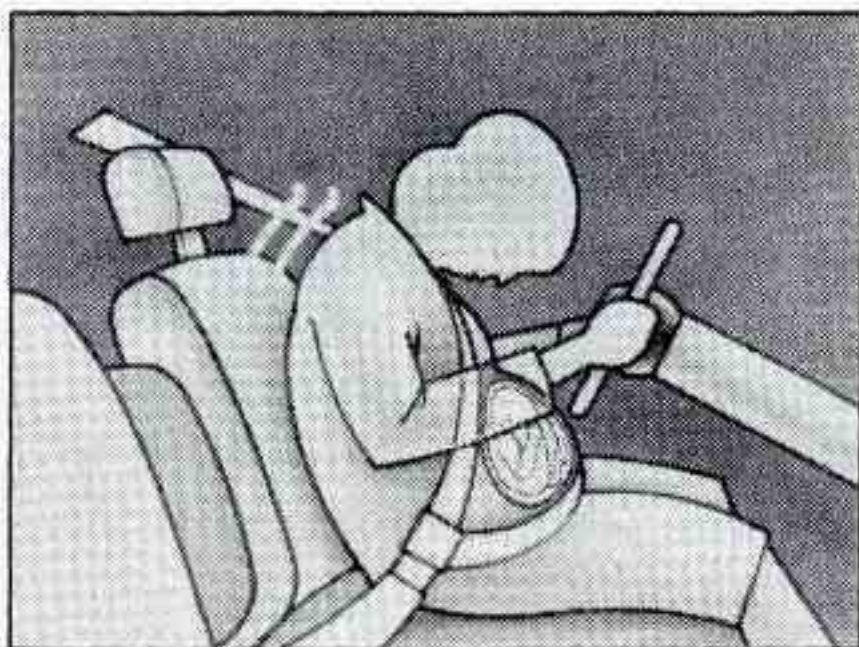

A pregnant woman should wear a lap-shoulder belt, and the lap portion should be worn as low as possible, below the rounding, throughout the pregnancy.

The best way to protect the fetus is to protect the mother. When a safety belt is worn properly, it's more likely that the fetus won't be hurt in a crash. For pregnant women, as for anyone, the key to making safety belts effective is wearing them properly.

### Right Front Passenger Position

To learn how to wear the right front passenger's safety belt properly, see "Driver Position" earlier in this section.

The right front passenger's safety belt works the same way as the driver's safety belt -- except for one thing. If you ever pull the lap portion of the belt out all the way, you will engage the child restraint locking feature. If this happens, just let the belt go back all the way and start again.

If your vehicle has a center passenger position, be sure to use the correct buckle when buckling your lap-shoulder belt. If you find that the latch plate will not go fully into the buckle, see if you are using the buckle for the center passenger position.

### Supplemental Restraint System (SRS)

This part explains the Supplemental Restraint System (SRS) or air bag system.

Your vehicle has "Next Generation" reduced-force frontal air bags -- one air bag for the driver and another air bag for the right front passenger. Reduced-force frontal air bags are designed to help reduce the risk of injury from the force of an inflating frontal air bag. But even these air bags must inflate very quickly if they are to do their job and comply with federal regulations.

Here are the most important things to know about the air bag system:



#### CAUTION:

**You can be severely injured or killed in a crash if you aren't wearing your safety belt -- even if you have air bags. Wearing your safety belt during a crash helps reduce your chance of hitting things inside the vehicle or being ejected from it. Air bags are "supplemental restraints" to the safety belts. All air bags -- even reduced-force air bags -- are designed to work with safety belts but don't replace them.**

**CAUTION: (Continued)**



**CAUTION: (Continued)**

Air bags are designed to work only in moderate to severe crashes where the front of your vehicle hits something. They aren't designed to inflate at all in rollover, rear, side or low-speed frontal crashes. And, for unrestrained occupants, reduced-force air bags may provide less protection in frontal crashes than more forceful air bags have provided in the past. Everyone in your vehicle should wear a safety belt properly -- whether or not there's an air bag for that person.

 **CAUTION:**

Air bags inflate with great force, faster than the blink of an eye. If you're too close to an inflating air bag, it could seriously injure you. This is true even with reduced-force frontal air bags. Safety  
**CAUTION: (Continued)**

**CAUTION: (Continued)**

belts help keep you in position before and during a crash. Always wear your safety belt, even with reduced-force air bags. The driver should sit as far back as possible while still maintaining control of the vehicle.

 **CAUTION:**

Children who are up against, or very close to, an air bag when it inflates can be seriously injured or killed. This is true even though your vehicle has reduced-force frontal air bags. Air bags plus lap-shoulder belts offer the best protection for adults, but not for young children and infants. Neither the vehicle's safety belt system nor its air bag system is designed for them.

**CAUTION: (Continued)**



**CAUTION: (Continued)**

**Young children and infants need the protection that a child restraint system can provide. Always secure children properly in your vehicle. To read how, see the part of this manual called "Children" and see the caution labels on the sunvisors and the right front passenger's safety belt.**

**AIR  
BAG**

There is an air bag readiness light on the instrument panel, which shows AIR BAG.

The system checks the air bag electrical system for malfunctions. The light tells you if there is an electrical problem. See "Air Bag Readiness Light" in the Index for more information.

## How the Air Bag System Works



### Where are the air bags?

The driver's air bag is in the middle of the steering wheel.



The right front passenger's air bag is in the instrument panel on the passenger's side.

**⚠ CAUTION:**

**If something is between an occupant and an air bag, the bag might not inflate properly or it might force the object into that person. The path of an inflating air bag must be kept clear. Don't put anything between an occupant and an air bag, and don't attach or put anything on the steering wheel hub or on or near any other air bag covering.**

**When should an air bag inflate?**

An air bag is designed to inflate in a moderate to severe frontal or near-frontal crash. The air bag will inflate only if the impact speed is above the system's designed "threshold level." If your vehicle goes straight into a wall that doesn't move or deform, the threshold level is about 9 to 15 mph (14 to 24 km/h). The threshold level can vary, however, with specific vehicle design, so that it can be somewhat above or below this range. If your vehicle strikes something that will move or deform, such as a parked car, the threshold level will be higher. The air bag is not designed to inflate in rollovers, side impacts or rear impacts, because inflation would not help the occupant.



In any particular crash, no one can say whether an air bag should have inflated simply because of the damage to a vehicle or because of what the repair costs were. Inflation is determined by the angle of the impact and how quickly the vehicle slows down in frontal or near-frontal impacts.

### **What makes an air bag inflate?**

In an impact of sufficient severity, the air bag sensing system detects that the vehicle is in a crash. The sensing system triggers a release of gas from the inflator, which inflates the air bag. The inflator, air bag and related hardware are all part of the air bag modules inside the steering wheel and in the instrument panel in front of the right front passenger.

### **How does an air bag restrain?**

In moderate to severe frontal or near-frontal collisions, even belted occupants can contact the steering wheel or the instrument panel. Air bags supplement the protection provided by safety belts. Air bags distribute the force of the impact more evenly over the occupant's upper body, stopping the occupant more gradually. But air bags would not help you in many types of collisions, including rollovers, rear impacts and side impacts, primarily because an occupant's motion is not toward those air bags. Air bags should never be regarded as anything more than a supplement to safety belts, and then only in moderate to severe frontal or near-frontal collisions.

### **What will you see after an air bag inflates?**

After an air bag inflates, it quickly deflates, so quickly that some people may not even realize the air bag inflated. Some components of the air bag module -- the steering wheel hub for the driver's air bag, or the instrument panel for the right front passenger's bag -- will be hot for a short time. The parts of the bag that come into contact with you may be warm, but not too hot to touch. There will be some smoke and dust coming from vents in the deflated air bags. Air bag inflation doesn't prevent the driver from seeing or from being able to steer the vehicle, nor does it stop people from leaving the vehicle.



### **CAUTION:**

**When an air bag inflates, there is dust in the air. This dust could cause breathing problems for people with a history of asthma or other breathing trouble. To avoid this, everyone in the vehicle should get out as soon as it is safe to do so. If you have breathing problems but can't get out of the vehicle after an air bag inflates, then get fresh air by opening a window or door.**



- Air bags are designed to inflate only once. After they inflate, you'll need some new parts for your air bag system. If you don't get them, the air bag system won't be there to help protect you in another crash. A new system will include air bag modules and possibly other parts. The service manual for your vehicle covers the need to replace other parts.
- Your vehicle is equipped with a crash sensing and diagnostic module, which records information about the air bag system. The module records information about the readiness of the system, when the sensors are activated and driver's safety belt usage at deployment.
- Let only qualified technicians work on your air bag system. Improper service can mean that your air bag system won't work properly. See your dealer for service.

## **NOTICE:**

**If you damage the covering for the driver's or the right front passenger's air bag, the bag may not work properly. You may have to replace the air bag module in the steering wheel or both the air bag module and the instrument panel for the right front passenger's air bag. Do not open or break the air bag coverings.**

### **Servicing Your Air Bag-Equipped Vehicle**

Air bags affect how your vehicle should be serviced. There are parts of the air bag system in several places around your vehicle. You don't want the system to inflate while someone is working on your vehicle. Your dealer and the Park Avenue Service Manual have information about servicing your vehicle and the air bag system. To purchase a service manual, see "Service and Owner Publications" in the Index.

**⚠ CAUTION:**

For up to 10 seconds after the ignition key is turned off and the battery is disconnected, an air bag can still inflate during improper service. You can be injured if you are close to an air bag when it inflates. Avoid yellow connectors. They are probably part of the air bag system. Be sure to follow proper service procedures, and make sure the person performing work for you is qualified to do so.

The air bag system does not need regular maintenance.

### Center Passenger Position

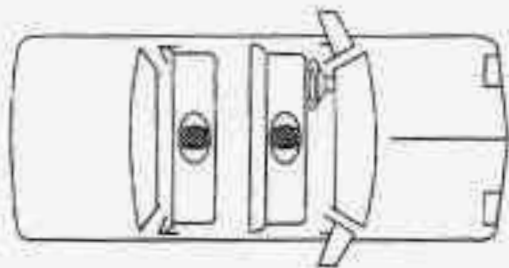

### Lap Belt

If your vehicle has a front split seat and a rear bench seat, someone can sit in the center positions.

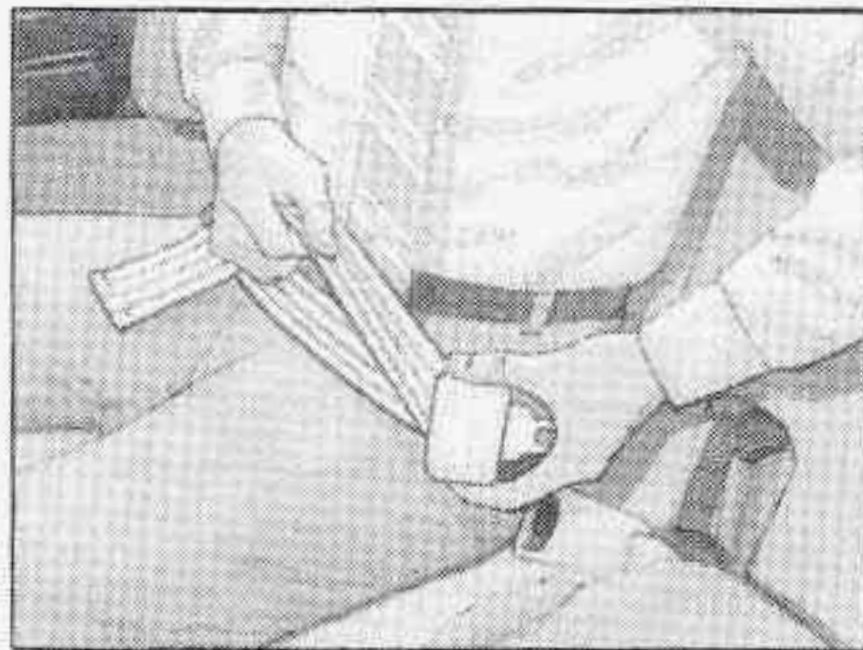

When you sit in a center seating position, you have a lap safety belt, which has no retractor. To make the belt longer, tilt the latch plate and pull it along the belt.

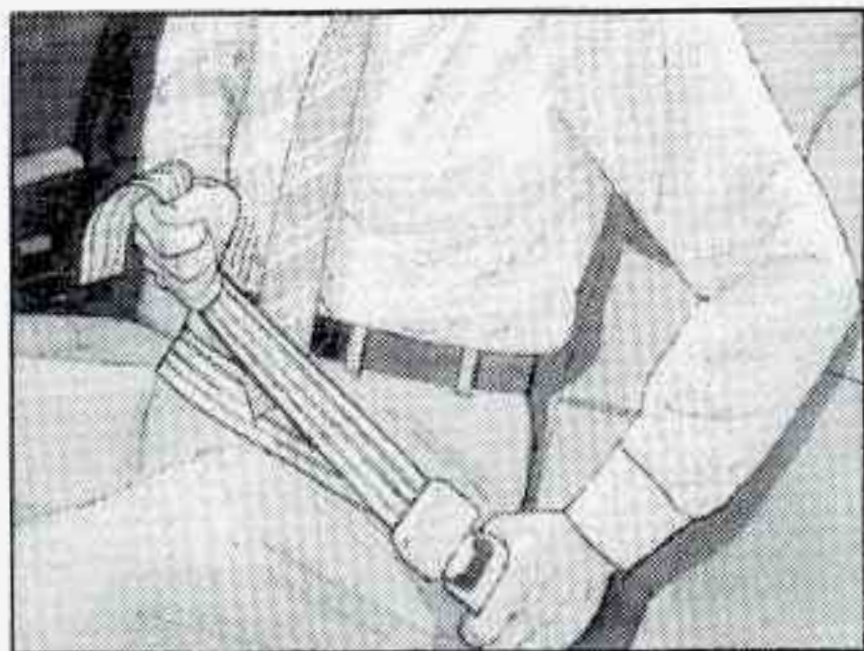

To make the belt shorter, pull its free end as shown until the belt is snug.

Buckle, position and release it the same way as the lap part of a lap-shoulder belt. If the belt isn't long enough, see "Safety Belt Extender" at the end of this section.

Make sure the release button on the buckle is positioned so you would be able to unbuckle the safety belt quickly if you ever had to.

## Rear Seat Passengers

It's very important for rear seat passengers to buckle up! Accident statistics show that unbelted people in the rear seat are hurt more often in crashes than those who are wearing safety belts.

Rear passengers who aren't safety belted can be thrown out of the vehicle in a crash. And they can strike others in the vehicle who are wearing safety belts.

## Rear Seat Outside Passenger Positions

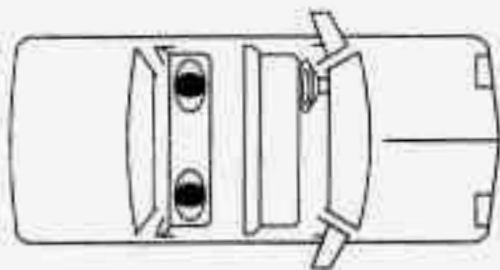



## Lap-Shoulder Belt

The positions next to the windows have lap-shoulder belts. Here's how to wear one properly.

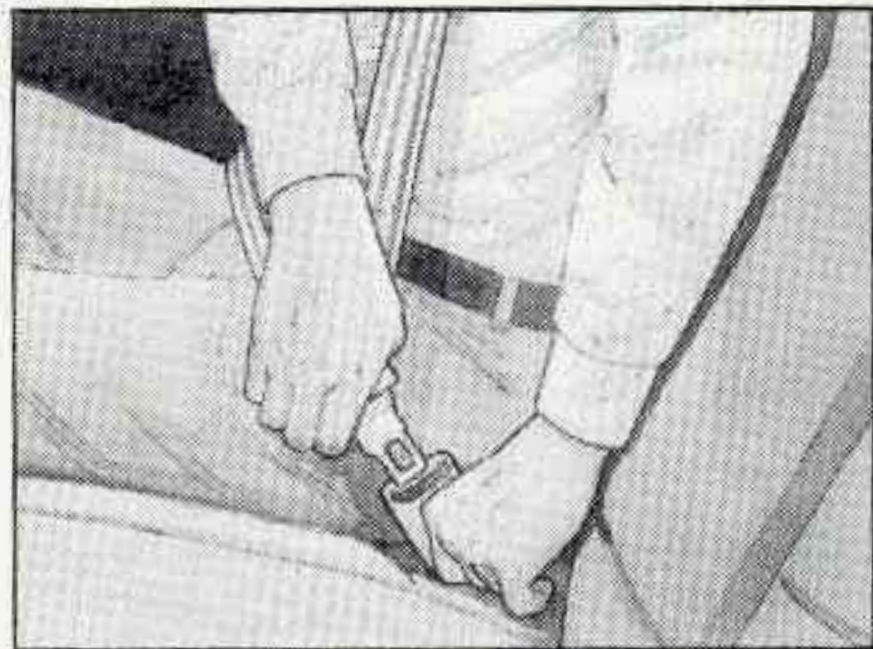

1. Pick up the latch plate and pull the belt across you. Don't let it get twisted.
2. Push the latch plate into the buckle until it clicks.

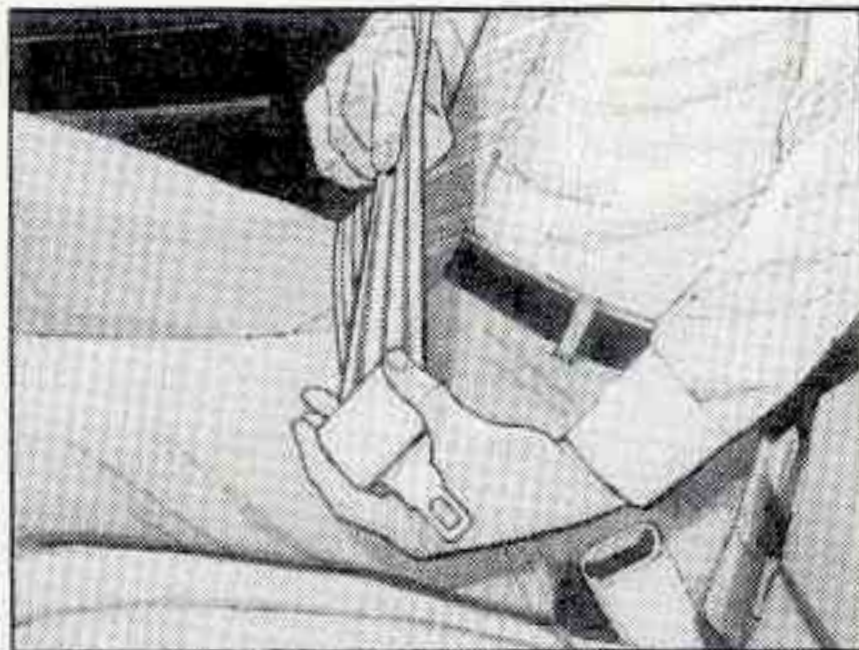

If the belt stops before it reaches the buckle, tilt the latch plate and keep pulling until you can buckle it.

Pull up on the latch plate to make sure it is secure.

If the belt is not long enough, see "Safety Belt Extender" at the end of this section. Make sure the release button on the buckle is positioned so you would be able to unbuckle the safety belt quickly if you ever had to.

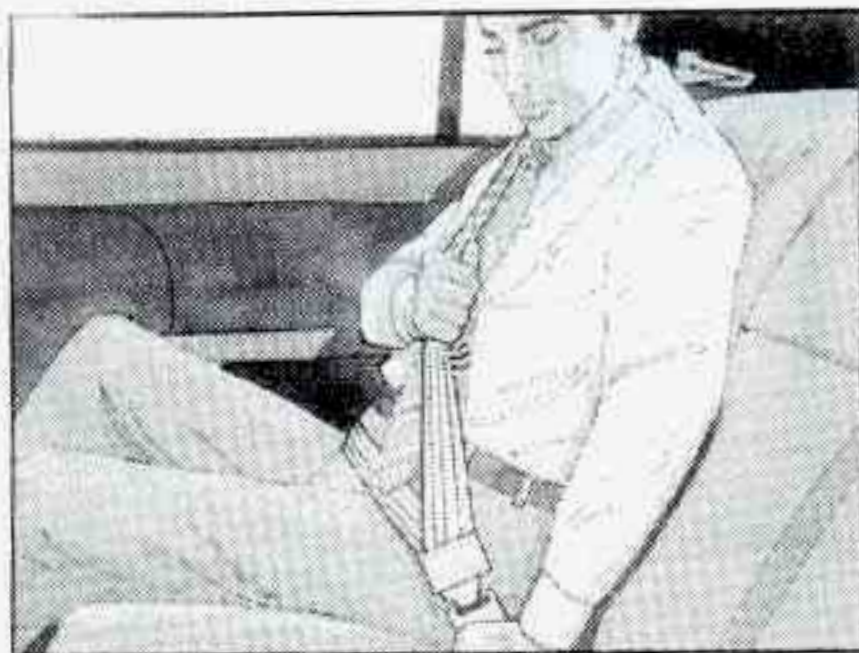

3. To make the lap part tight, pull down on the buckle end of the belt as you pull up on the shoulder part.

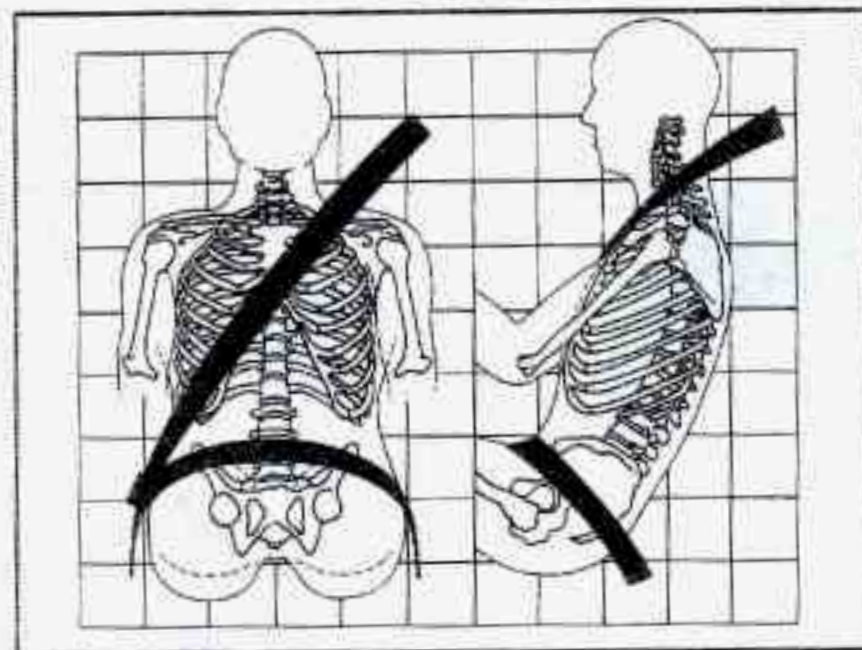

The lap part of the belt should be worn low and snug on the hips, just touching the thighs. In a crash, this applies force to the strong pelvic bones. And you'd be less likely to slide under the lap belt. If you slid under it, the belt would apply force at your abdomen. This could cause serious or even fatal injuries. The shoulder belt should go over the shoulder and across the chest. These parts of the body are best able to take belt restraining forces.

The safety belt locks if there's a sudden stop or a crash.



**⚠ CAUTION:**

**You can be seriously hurt if your shoulder belt is too loose. In a crash, you would move forward too much, which could increase injury. The shoulder belt should fit against your body.**



To unlatch the belt, just push the button on the buckle.



## Rear Safety Belt Comfort Guides for Children and Small Adults

Rear shoulder belt comfort guides will provide added safety belt comfort for children who have outgrown child restraints and for small adults. When installed on a shoulder belt, the comfort guide pulls the belt away from the neck and head.

There is one guide for each outside passenger position in the rear seat. To provide added safety belt comfort for children who have outgrown child restraints and for smaller adults, the comfort guides may be installed on the shoulder belts. Here's how to install a comfort guide and use the safety belt:



1. Remove the guide from its storage pocket on the side of the seatback.

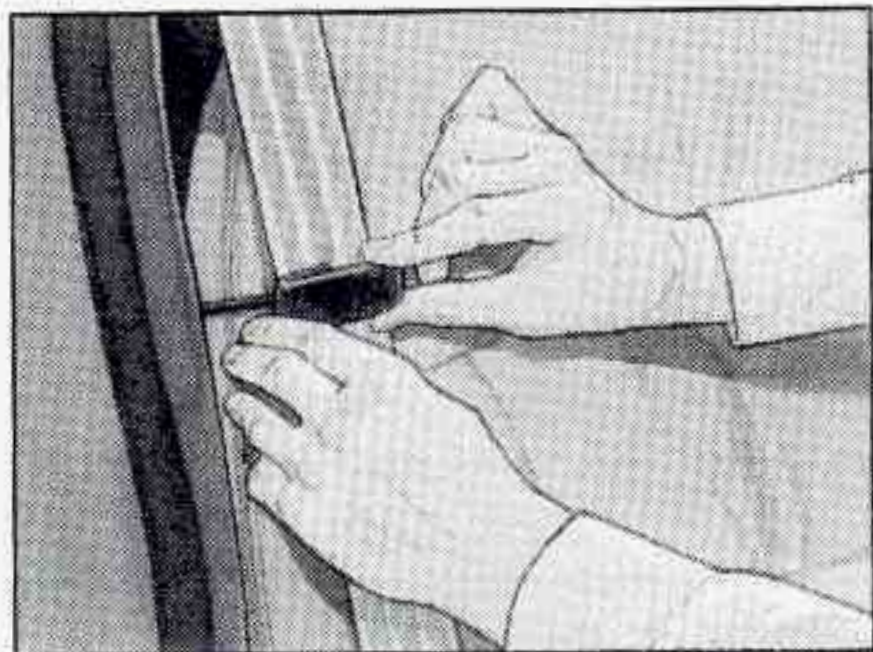

2. Slide the guide under and past the belt. The elastic cord must be under the belt. Then, place the guide over the belt, and insert the two edges of the belt into the slots of the guide.

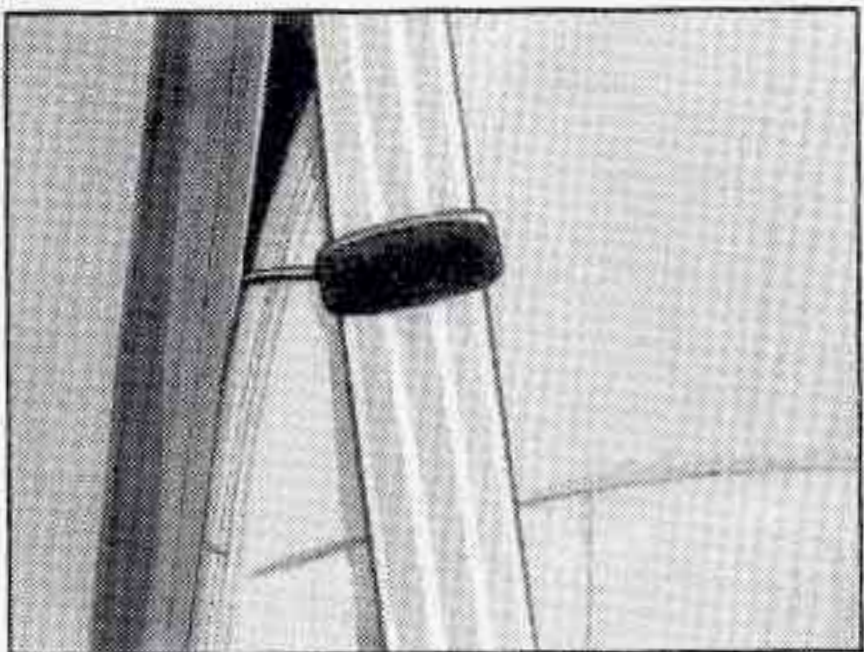

3. Be sure that the belt is not twisted and it lies flat. The elastic cord must be under the belt and the guide on top.





4. Buckle, position and release the safety belt as described in "Rear Seat Outside Passenger Positions" earlier in this section. Make sure that the shoulder belt crosses the shoulder.

To remove and store the comfort guides, squeeze the belt edges together so that you can take them out from the guides. Slide the guide into its storage pocket on the side of the seatback.

## Children

Everyone in a vehicle needs protection! That includes infants and all children smaller than adult size. Neither the distance traveled nor the age and size of the traveler changes the need, for everyone, to use safety restraints. In fact, the law in every state in the United States and in every Canadian province says children up to some age must be restrained while in a vehicle.

### Smaller Children and Babies

#### CAUTION:

**Children who are up against, or very close to, any air bag when it inflates can be seriously injured or killed. This is true even though your vehicle has reduced-force frontal air bags. Air bags plus lap-shoulder belts offer the best protection for adults, but not for young children and infants. Neither the vehicle's safety belt system nor its air bag system is designed for them. Young children and infants need the protection that a child restraint system can provide. Always secure children properly in your vehicle.**



 **CAUTION:**

**Smaller children and babies should always be restrained in a child or infant restraint. The instructions for the restraint will say whether it is the right type and size for your child. A very young child's hip bones are so small that a regular belt might not stay low on the hips, as it should. Instead, the belt will likely be over the child's abdomen. In a crash, the belt would apply force right on the child's abdomen, which could cause serious or fatal injuries. So, be sure that any child small enough for one is always properly restrained in a child or infant restraint.**

Infants need complete support, including support for the head and neck. This is necessary because an infant's neck is weak and its head weighs so much compared with the rest of its body. In a crash, an infant in a rear-facing restraint settles into the restraint, so the crash forces can be distributed across the strongest part of the infant's body, the back and shoulders. A baby should be secured in an appropriate infant restraint. This is so important that many hospitals today won't release a newborn infant to its parents unless there is an infant restraint available for the baby's first trip in a motor vehicle.



**⚠ CAUTION:**

**Never hold a baby in your arms while riding in a vehicle. A baby doesn't weigh much -- until a crash. During a crash a baby will become so heavy you can't hold it. For example, in a crash**

**CAUTION: (Continued)**

**CAUTION: (Continued)**

**at only 25 mph (40 km/h), a 12-lb. (5.5 kg) baby will suddenly become a 240-lb. (110 kg) force on your arms. The baby would be almost impossible to hold.**

**Secure the baby in an infant restraint.**

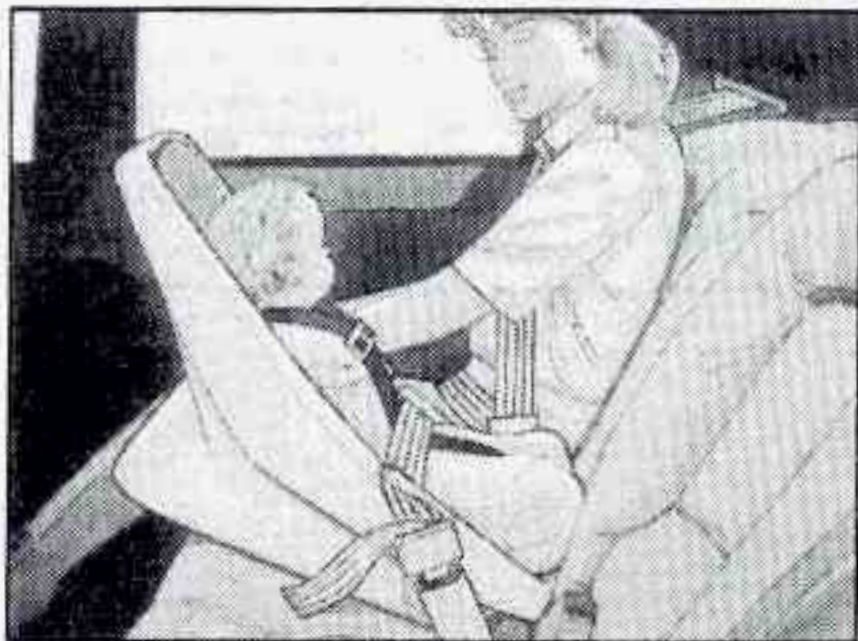

## Child Restraints

Every time infants and young children ride in vehicles, they should have protection provided by appropriate restraints.

**Q:** What are the different types of add-on child restraints?

**A:** Add-on child restraints are available in four basic types. When selecting a child restraint, take into consideration not only the child's weight and size, but also whether or not the restraint will be compatible with the motor vehicle in which it will be used.

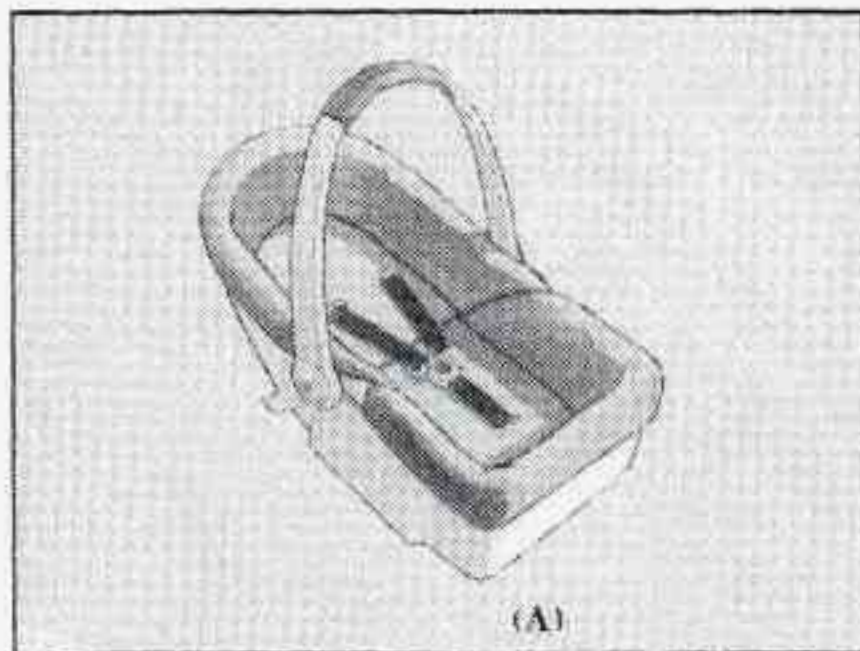

An infant car bed (A) is a special bed made for use in a motor vehicle. It's an infant restraint system designed to restrain or position a child on a continuous flat surface. With an infant car bed, make sure that the infant's head rests toward the center of the vehicle.



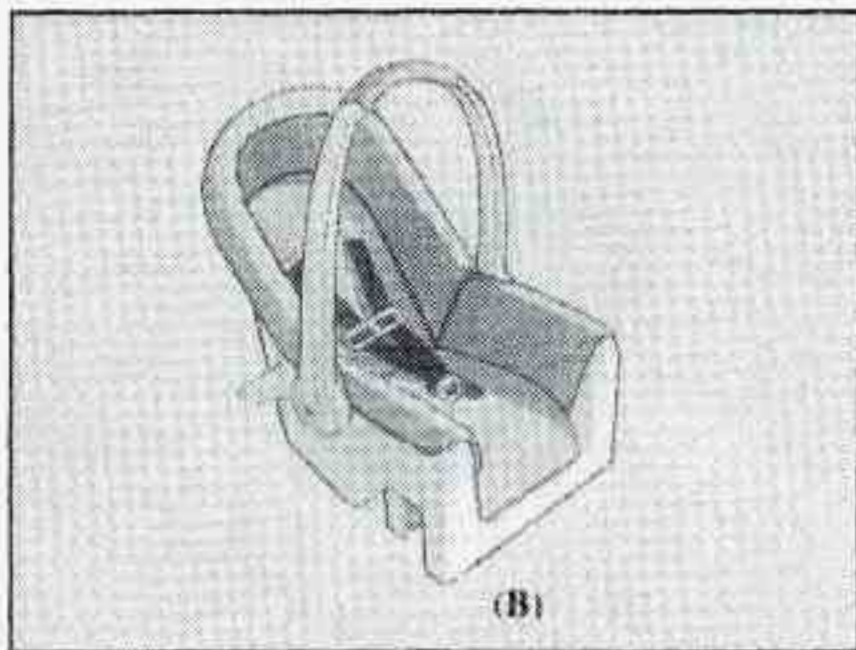

A rear-facing infant restraint (B) positions an infant to face the rear of the vehicle. Rear-facing infant restraints are designed for infants of up to about 20 lbs. (9 kg) and about one year of age. This type of restraint faces the rear so that the infant's head, neck and body can have the support they need in a crash. Some infant seats come in two parts -- the base stays secured in the vehicle and the seat part is removable.



A forward-facing child restraint (C-E) positions a child upright to face forward in the vehicle. These forward-facing restraints are designed to help protect children who are from 20 to 40 lbs. (9 to 18 kg) and about 26 to 40 inches (66 to 102 cm) in height, or up to around four years of age. One type, a convertible restraint, is designed to be used either as a rear-facing infant seat or a forward-facing child seat.

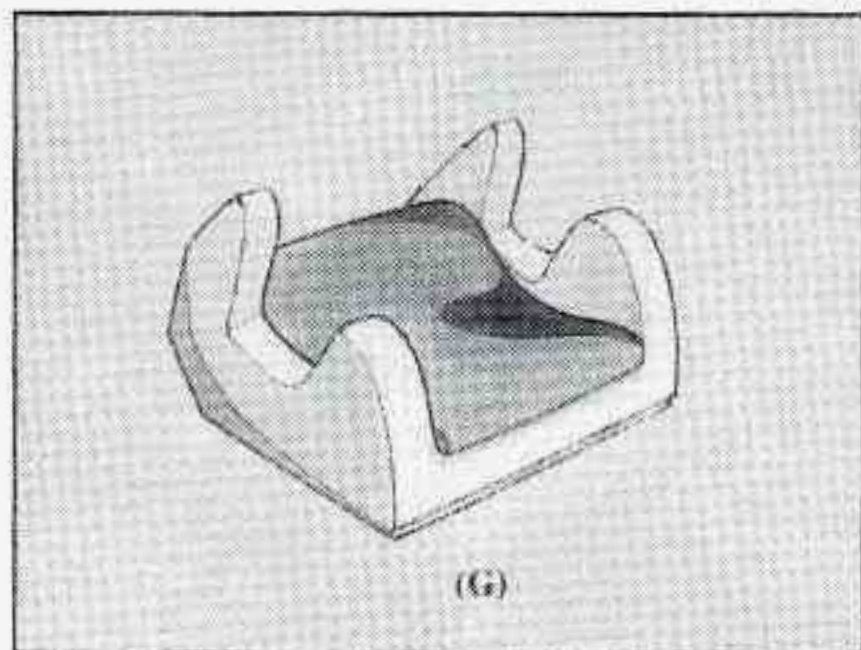
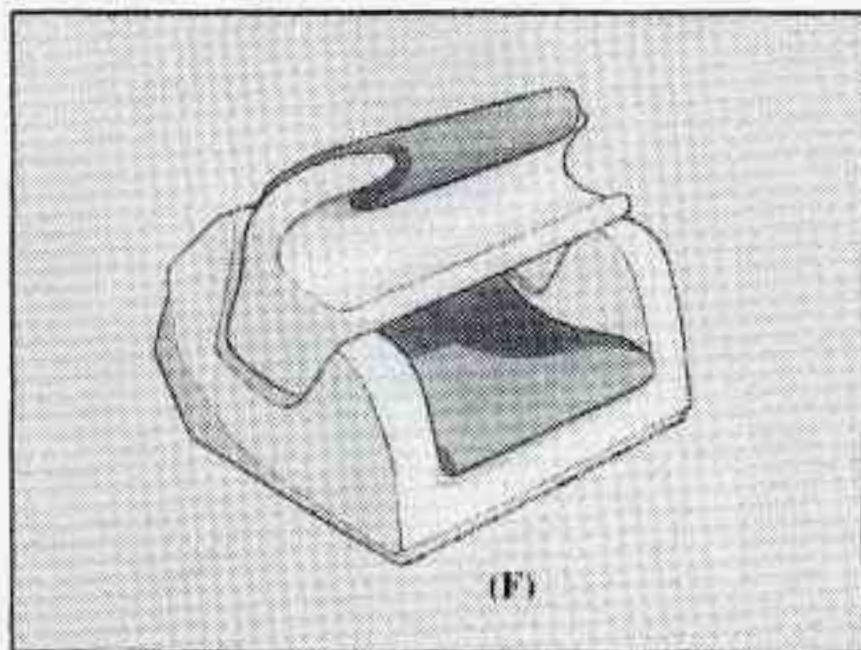

A booster seat (F, G) is designed for children who are about 40 to 60 lbs. (18 to 27 kg) and about four to eight years of age. It's designed to improve the fit of the vehicle's safety belt system. Booster seats with shields use lap-only belts; however, booster seats without shields use lap-shoulder belts. Booster seats can also help a child to see out the window.



When choosing a child restraint, be sure the child restraint is designed to be used in a vehicle. If it is, it will have a label saying that it meets Federal Motor Vehicle Safety Standards.

Then follow the instructions for the restraint. You may find these instructions on the restraint itself or in a booklet, or both. These restraints use the belt system in your vehicle, but the child also has to be secured within the restraint to help reduce the chance of personal injury. The instructions that come with the infant or child restraint will show you how to do that. Both the owner's manual and the child restraint instructions are important, so if either one of these is not available, obtain a replacement copy from the manufacturer.

## Where to Put the Restraint

Accident statistics show that children are safer if they are restrained in the rear rather than the front seat. We at General Motors therefore recommend that you put your child restraint in the rear seat. *Never* put a rear-facing child restraint in the front passenger seat. Here's why:



### CAUTION:

**A child in a rear-facing child restraint can be seriously injured if the right front passenger's air bag inflates even though your vehicle has reduced-force frontal air bags. This is because the back of the rear-facing child restraint would be very close to the inflating air bag. Always secure a rear-facing child restraint in a rear seat.**

**You may secure a forward-facing child restraint in the right front seat, but before you do, always move the front passenger seat as far back as it will go. It is better to secure the child restraint in the rear seat.**

**⚠ CAUTION:**

**A child in a child restraint in the center front seat can be badly injured or killed by the right front passenger air bag if it inflates, even though your vehicle has reduced-force frontal air bags. Never secure a child restraint in the center front seat. It's always better to secure a child restraint in the rear seat. You may secure a forward-facing child restraint in the right front passenger seat, but before you do, always move the front passenger seat as far back as it will go. It is better to secure the child restraint in the rear seat.**

Wherever you install it, be sure to secure the child restraint properly.

Keep in mind that an unsecured child restraint can move around in a collision or sudden stop and injure people in the vehicle. Be sure to properly secure any child restraint in your vehicle -- even when no child is in it.

### Top Strap

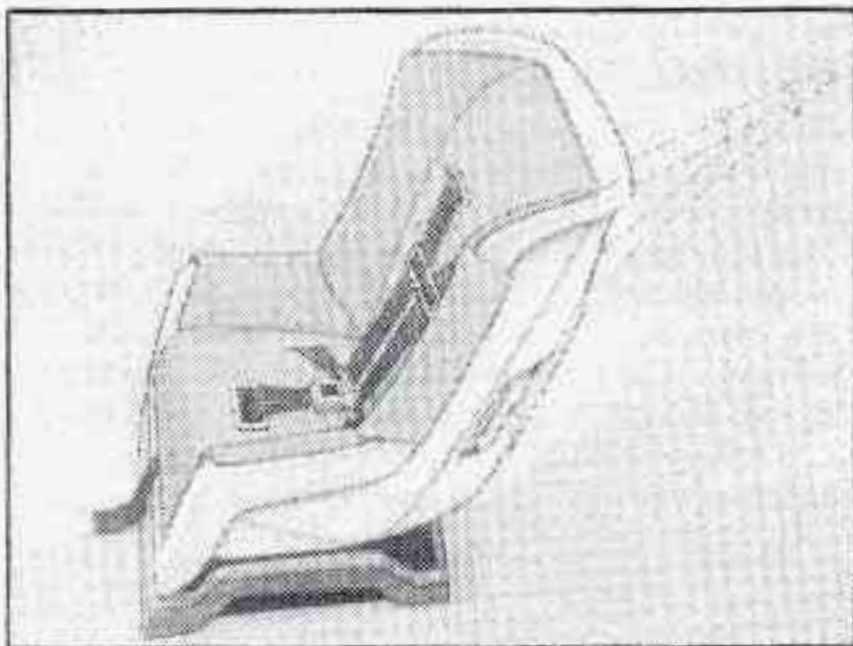

If your child restraint has a top strap, it should be anchored. If you need to have an anchor installed, you can ask your Buick dealer to put it in for you. If you want to install an anchor yourself, your dealer can tell you how to do it.

Canadian law requires that child restraints have a top strap, and that the strap be anchored.



If your child restraint has a top strap, your dealer can obtain a kit with anchor hardware and installation instructions specifically designed for this vehicle. The dealer can then install the anchor for you. In Canada, this work will be done for you free of charge. Or, you may install the anchor yourself using the instructions provided in the kit.

### Securing a Child Restraint in a Rear Outside Seat Position

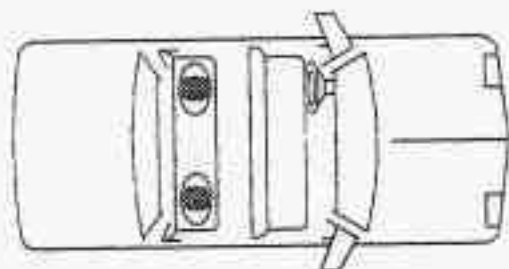

You'll be using the lap-shoulder belt. See the earlier part about the top strap if the child restraint has one. Be sure to follow the instructions that came with the child restraint. Secure the child in the child restraint when and as the instructions say.

1. Put the restraint on the seat.

2. Pick up the latch plate, and run the lap and shoulder portions of the vehicle's safety belt through or around the restraint. The child restraint instructions will show you how.

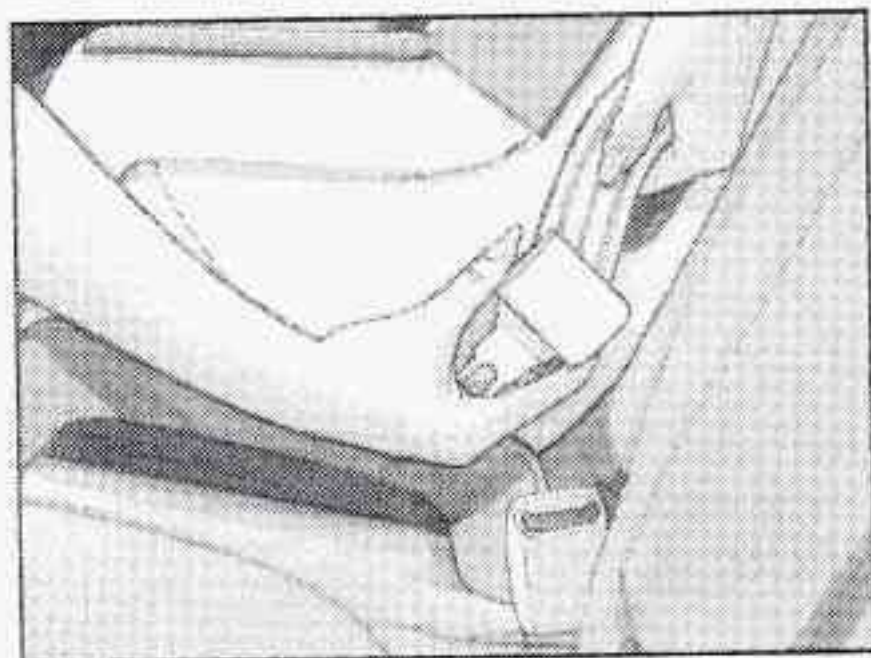

3. Tilt the latch plate to adjust the belt if needed.  
If the shoulder belt goes in front of the child's face or neck, put it behind the child restraint.





4. Buckle the belt. Make sure the release button is positioned so you would be able to unbuckle the safety belt quickly if you ever had to.

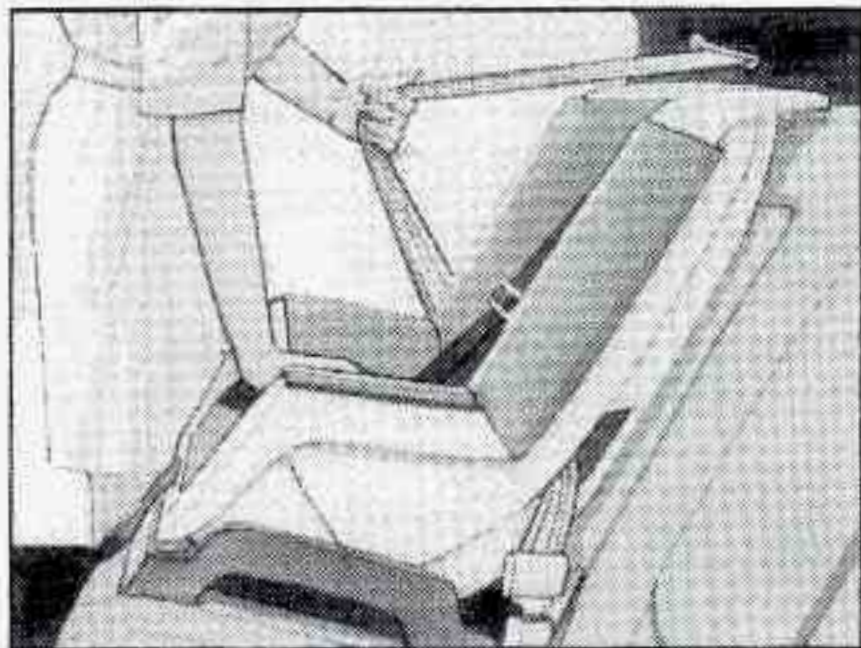

5. To tighten the belt, pull up on the shoulder belt while you push down on the child restraint. If you're using a forward-facing child restraint, you may find it helpful to use your knee to push down on the child restraint as you tighten the belt.
6. Push and pull the child restraint in different directions to be sure it is secure.

To remove the child restraint, just unbuckle the vehicle's safety belt and let it go back all the way. The safety belt will move freely again and be ready to work for an adult or larger child passenger.

## Securing a Child Restraint in the Center Rear Seat Position

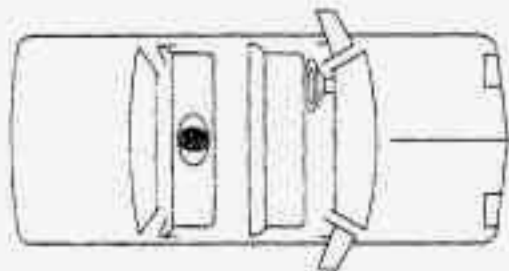

You'll be using the lap belt. Be sure to follow the instructions that came with the child restraint. Secure the child in the child restraint when and as the instructions say.



### CAUTION:

**A child in a child restraint in the center front seat can be badly injured or killed by the right front passenger air bag if it inflates, even though your vehicle has reduced-force frontal air bags. Never secure a child restraint in the center front seat. It's always better to secure a child restraint in the rear seat. You may secure a forward-facing child restraint in the right front passenger seat, but before you do, always move the front passenger seat as far back as it will go. It's better to secure the child restraint in a rear seat.**

See the earlier part about the top strap if the child restraint has one.





1. Make the belt as long as possible by tilting the latch plate and pulling it along the belt.
2. Put the restraint on the seat.
3. Run the vehicle's safety belt through or around the restraint. The child restraint instructions will show you how.



4. Buckle the belt. Make sure the release button is positioned so you would be able to unbuckle the safety belt quickly if you ever had to.
5. To tighten the belt, pull its free end while you push down on the child restraint. If you're using a forward-facing child restraint, you may find it helpful to use your knee to push down on the child restraint as you tighten the belt.



6. Push and pull the child restraint in different directions to be sure it is secure.

To remove the child restraint, just unbuckle the vehicle's safety belt. It will be ready to work for an adult or larger child passenger.

### Securing a Child Restraint in the Right Front Seat Position

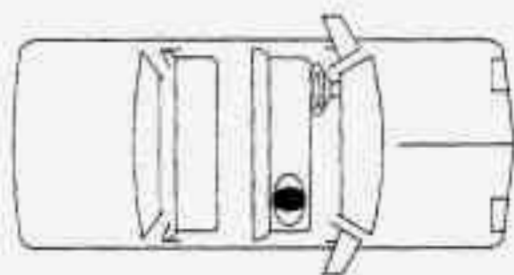

Your vehicle has a right front passenger air bag. *Never* put a rear-facing child restraint in this seat. Here's why:



### CAUTION:

**A child in a rear-facing child restraint can be seriously injured or killed if the right front passenger's air bag inflates, even though your vehicle has reduced-force frontal air bags. This is because the back of a rear-facing child restraint would be very close to the inflating air bag. Always secure a rear-facing child restraint in the rear seat.**

You'll be using the lap-shoulder belt. See the earlier part about the top strap if the child restraint has one. Be sure to follow the instructions that came with the child restraint. Secure the child in the child restraint when and as the instructions say.

1. Because your vehicle has a right front passenger air bag, always move the seat as far back as it will go before securing a forward-facing child restraint. (See "Seats" in the Index.)
2. Put the restraint on the seat.
3. Pick up the latch plate, and run the lap and shoulder portions of the vehicle's safety belt through or around the restraint. The child restraint instructions will show you how.

If the shoulder belt goes in front of the child's face or neck, put it behind the child restraint.



4. Buckle the belt. Make sure the release button is positioned so you would be able to unbuckle the safety belt quickly if you ever had to.



5. Pull the rest of the lap belt all the way out of the retractor to set the lock.





6. To tighten the belt, feed the lap belt back into the retractor while you push down on the child restraint. You may find it helpful to use your knee to push down on the child restraint as you tighten the belt.
7. Push and pull the child restraint in different directions to be sure it is secure.

To remove the child restraint, just unbuckle the vehicle's safety belt and let it go back all the way. The safety belt will move freely again and be ready to work for an adult or larger child passenger.

## Larger Children



Children who have outgrown child restraints should wear the vehicle's safety belts.

If you have the choice, a child should sit next to a window so the child can wear a lap-shoulder belt and get the additional restraint a shoulder belt can provide.



Accident statistics show that children are safer if they are restrained in the rear seat. But they need to use the safety belts properly.

- Children who aren't buckled up can be thrown out in a crash.
- Children who aren't buckled up can strike other people who are.



 **CAUTION:**

**Never do this.**

Here two children are wearing the same belt. The belt can't properly spread the impact forces. In a crash, the two children can be crushed together and seriously injured. A belt must be used by only one person at a time.

**Q:** What if a child is wearing a lap-shoulder belt, but the child is so small that the shoulder belt is very close to the child's face or neck?

**A:** Move the child toward the center of the vehicle, but be sure that the shoulder belt still is on the child's shoulder, so that in a crash the child's upper body would have the restraint that belts provide. If the child is sitting in a rear seat outside position, see "Rear Safety Belt Comfort Guides" in the Index. If the child is so small that the shoulder belt is still very close to the child's face or neck, you might want to place the child in the center seat position, the one that has only a lap belt.



 **CAUTION:**

**Never do this.**

**Here a child is sitting in a seat that has a lap-shoulder belt, but the shoulder part is behind the child. If the child wears the belt in this way, in a crash the child might slide under the belt. The belt's force would then be applied right on the child's abdomen. That could cause serious or fatal injuries.**

Wherever the child sits, the lap portion of the belt should be worn low and snug on the hips, just touching the child's thighs. This applies belt force to the child's pelvic bones in a crash.



## Safety Belt Extender

If the vehicle's safety belt will fasten around you, you should use it.

But if a safety belt isn't long enough to fasten, your dealer will order you an extender. It's free. When you go in to order it, take the heaviest coat you will wear, so the extender will be long enough for you. The extender will be just for you, and just for the seat in your vehicle that you choose. Don't let someone else use it, and use it only for the seat it is made to fit. To wear it, just attach it to the regular safety belt.

## Checking Your Restraint Systems

Now and then, make sure the safety belt reminder light and all your belts, buckles, latch plates, retractors and anchorages are working properly. Look for any other loose or damaged safety belt system parts. If you see anything that might keep a safety belt system from doing its job, have it repaired.

Torn or frayed safety belts may not protect you in a crash. They can rip apart under impact forces. If a belt is torn or frayed, get a new one right away.

Also look for any opened or broken air bag covers, and have them repaired or replaced. (The air bag system does not need regular maintenance.)

## Replacing Restraint System Parts After a Crash

If you've had a crash, do you need new belts?

After a very minor collision, nothing may be necessary. But if the belts were stretched, as they would be if worn during a more severe crash, then you need new belts.

If belts are cut or damaged, replace them. Collision damage also may mean you will need to have safety belt or seat parts repaired or replaced. New parts and repairs may be necessary even if the belt wasn't being used at the time of the collision.

If an air bag inflates, you'll need to replace air bag system parts. See the part on the air bag system earlier in this section.









## Section 2 Features and Controls

---

Here you can learn about the many standard and optional features on your vehicle, and information on starting, shifting and braking. Also explained are the instrument panel and the warning systems that tell you if everything is working properly -- and what to do if you have a problem.

2-2	Keys	2-32	Engine Exhaust
2-4	Door Locks	2-32	Running Your Engine While You're Parked
2-8	Remote Keyless Entry System	2-33	Windows
2-14	Trunk	2-34	Tilt Wheel
2-15	Theft	2-35	Turn Signal/Multifunction Lever
2-16	Content Theft Deterrent	2-44	Exterior Lamps
2-18	PASS-Key <sup>®</sup> III	2-47	Interior Lamps
2-20	New Vehicle "Break-In"	2-50	Mirrors
2-20	Ignition Positions	2-56	Storage Compartments
2-22	Starting Your Engine	2-65	Astrorooft (If Equipped)
2-23	Engine Coolant Heater (If Equipped)	2-66	Universal Transmitter (If Equipped)
2-24	Automatic Transaxle Operation	2-70	Instrument Panel
2-27	Parking Brake	2-75	Warning Lights, Gages and Indicators
2-28	Shifting Into PARK (P)	2-84	Head-Up Display (HUD) (If Equipped)
2-31	Shifting Out of PARK (P)	2-86	Driver Information Center (DIC) (If Equipped)
2-31	Parking Over Things That Burn		



## Keys

### CAUTION:

Leaving young children in a vehicle with the ignition key is dangerous for many reasons. A child or others could be badly injured or even killed.

They could operate power windows or other controls or even make the vehicle move. Don't leave the keys in a vehicle with young children.



Your vehicle has a two key system. One key is the master and the other is a valet key.



The master key is used for the ignition, as well as all door locks and storage compartments.



The valet key is used for the ignition and the two side doors only. It will not open the trunk or glove box. This is a theft-deterrent feature. The valet key should always be used when valet parking your vehicle.

When a new vehicle is delivered, the dealer removes the plugs from the keys, and gives them to the first owner. However, if the ignition key does not have a plug, there may be a bar-coded key tag instead.

Each plug has a code on it that tells your dealer or a qualified locksmith how to make extra keys. Keep the plugs in a safe place. If you lose your keys, you'll be able to have new ones made easily using these plugs or the tag. If your ignition keys don't have plugs, go to your dealer for the correct key code if you need a new ignition key.

### **NOTICE:**

**Your vehicle has a number of features that can help prevent theft. But you can have a lot of trouble getting into your vehicle if you ever lock your keys inside. You may even have to damage your vehicle to get in. So be sure you have extra keys.**

## Door Locks

### CAUTION:

**Unlocked doors can be dangerous.**

**Passengers -- especially children -- can easily open the doors and fall out. When a door is locked, the inside handle won't open it.**

**Outsiders can easily enter through an unlocked door when you slow down or stop your vehicle.**

**This may not be so obvious: You increase the chance of being thrown out of the vehicle in a crash if the doors aren't locked. Wear safety belts properly, lock your doors, and you will be far better off whenever you drive your vehicle.**

There are several ways to lock and unlock your vehicle.

From the outside, use your door key or remote keyless entry transmitter.

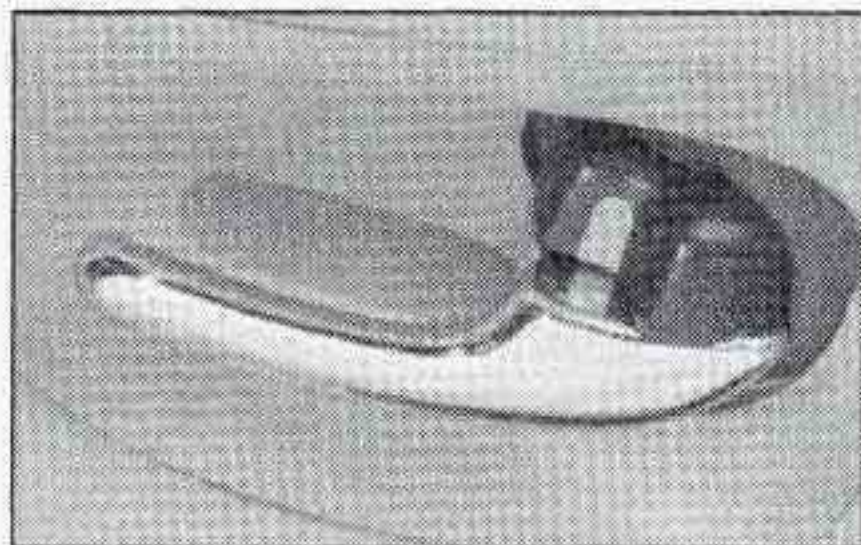

To lock the door from the inside, move the lock control on the door handle forward.

To unlock the door, move the lock control on the door handle toward the rear of the vehicle.



## Central Door Unlocking System

From outside the vehicle, if the driver's door key is held in the unlock position for more than two seconds, or, if the key is turned to the unlock position twice within three seconds, all doors will unlock.

## Power Door Locks



With power door locks, you can lock or unlock all doors of your vehicle by using either the driver or front passenger power door lock switch.

## Door Ajar Reminder (If Equipped)

If your vehicle is equipped with the Driver Information Center (DIC), and a door is not fully closed, the DIC will display a DOOR AJAR message. See "Driver Information Center" in the Index.

## Memory Door Locks

Close the doors and turn on the ignition. Every time you move the shift lever out of PARK (P), all of the doors will lock. And, every time you stop and move the shift lever into PARK (P), the doors will unlock. If someone needs to get out while you're not in PARK (P), have that person use the manual or power lock. When the door is closed again, it will not lock automatically. Just use the manual or power lock to lock the door again. If you need to lock the doors before shifting out of PARK (P), just use the manual or power lock button to lock the doors.

## Customizing Your Memory Door Locks Feature

You can program the memory door locks feature to change to the following modes:

<b>Mode</b>	<b>Operation</b>
0	No automatic door lock or unlock.
1	All doors automatically lock when shifted out of PARK (P). No automatic door unlock.
2	All doors automatically lock when shifted out of PARK (P). Only the driver's door automatically unlocks when shifted into PARK (P).
3	All doors automatically lock when shifted out of PARK (P). All doors automatically unlock when shifted into PARK (P).

Vehicles are delivered programmed in Mode 3; however, each remote keyless entry transmitter can be programmed to a different mode according to the user's preference.

To change modes:

1. Close all the doors and turn the ignition on. Keep all doors closed throughout this procedure.
2. Press and hold LOCK on the power door lock switch on the driver's door through Step 4.
3. Press the LOCK button on the remote keyless entry transmitter to enter the programming mode. The memory door lock mode will remain in the current mode.
4. Press the LOCK button on the transmitter again. Each time the transmitter's LOCK button is pressed, the mode will advance by one, going from mode 3 to mode 0 to mode 1, etc.

For each press of the LOCK button, the door locks will activate in the same manner they would activate in the corresponding memory door lock mode. For example, pressing the LOCK button on the transmitter to advance to mode 2 would result in all doors locking and then, only the driver's door would unlock. For Mode 0, no locking or unlocking will occur.

5. Release the power door lock switch and turn the ignition off. The automatic door locks will remain in the most recent mode selected.

You can also program the memory door locks feature using the Driver Information Center. See “Driver Information Center Personal Choice Programming” in the Index.

## Rear Door Security Locks

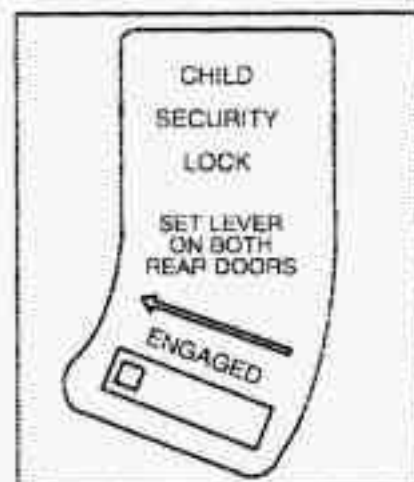

Your vehicle is equipped with rear door security locks that help prevent passengers from opening the rear doors of your vehicle from the inside.

To use one of these locks:

1. Open one of the rear doors.
2. Move the lever on the door all the way up to the **ENGAGED** position.

3. Close the door.
4. Do the same thing to the other rear door lock.

The rear doors of your vehicle cannot be opened from the inside when this feature is in use.

To open a rear door when the security lock is on:

1. Unlock the door from the inside.
2. Then open the door from the outside. If you don't cancel the security lock feature, adults or older children who ride in the rear won't be able to open the rear door from the inside. You should let adults and older children know how these security locks work, and how to cancel the locks.

To cancel the rear door security lock:

1. Unlock the door from the inside and open the door from the outside.
2. Move the lever all the way down.
3. Do the same thing for the other rear door.

The rear door locks will now work normally.



## Lockout Protection

The power door locks will not work if the key is left in the ignition, the ignition is turned to OFF and the driver's door is open. You can override this feature by holding the power door lock switch for more than three seconds.

## Leaving Your Vehicle

If you are leaving the vehicle, take your keys, open your door and set the locks from inside, then get out and close the door.

## Remote Keyless Entry System

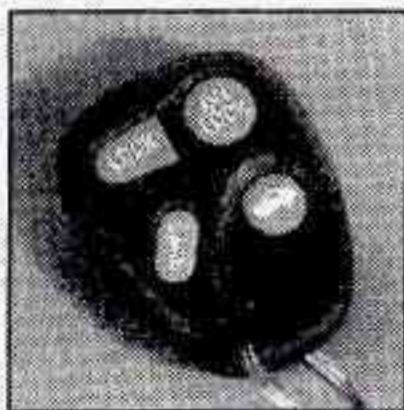

With the remote keyless entry system, you can lock and unlock your doors or unlock your trunk from about 3 feet (1 m) up to 30 feet (9 m) away using the remote keyless entry transmitter supplied with your vehicle.

Your remote keyless entry system operates on a radio frequency subject to Federal Communications Commission (FCC) Rules and with Industry Canada.

This device complies with Part 15 of the FCC Rules. Operation is subject to the following two conditions: (1) this device may not cause harmful interference, and (2) this device must accept any interference received, including interference that may cause undesired operation.

This device complies with RSS-210 of Industry Canada. Operation is subject to the following two conditions: (1) this device may not cause interference, and (2) this device must accept any interference received, including interference that may cause undesired operation of the device.

Changes or modifications to this system by other than an authorized service facility could void authorization to use this equipment.

This system has a range of about 3 feet (1 m) up to 30 feet (9 m). At times you may notice a decrease in range. This is normal for any remote keyless entry system. If the transmitter does not work or if you have to stand closer to your vehicle for the transmitter to work, try this:

- Check to determine if battery replacement is necessary. See the instructions that follow.
- Check the distance. You may be too far from your vehicle. You may need to stand closer during rainy or snowy weather.
- Check the location. Other vehicles or objects may be blocking the signal. Take a few steps to the left or right, hold the transmitter higher, and try again.
- If you're still having trouble, see your dealer or a qualified technician for service.

## Operation

The driver's door will unlock when UNLOCK is pressed. If pressed again within five seconds, all doors will unlock. Pressing any button will also illuminate the interior lamps (see "Illuminated Entry" in the Index). All doors will lock when LOCK is pressed.

The trunk will unlock when the trunk button is pressed, and the ignition is in LOCK or OFF. The trunk button will also work when the ignition is on, but only while in PARK (P).

## Instant Alarm

When the button with the horn symbol on the remote keyless entry transmitter is pressed, the horn will sound and the headlamps and taillamps will flash for up to 30 seconds. This can be turned off by pressing the instant alarm button again or by turning the ignition on.

If your vehicle is equipped with the Content Theft-Deterrent feature, you may also turn off the instant alarm by unlocking the vehicle with a key.

### Synchronization

If only the instant alarm button works, the transmitter needs to be resynchronized to the receiver. Do this by pressing and holding both the LOCK and UNLOCK buttons on the transmitter for about eight seconds. You must be within range of the vehicle.

Once the transmitter has been resynchronized, the horn will chirp and the exterior lamps will flash once. The system should now operate properly.

### Theft-Deterrent System

The remote keyless entry transmitter will arm the theft-deterrent system whenever the doors are closed and you push the LOCK button when the ignition is off. It will disarm the system when you push UNLOCK.

### Personal Choice Features (If Equipped)

Each remote keyless entry transmitter can be programmed to the driver's preference for memory door locks, security feedback, delayed locking, memory seats, perimeter lighting, parallel park assist mirror and window lockout. See each feature in the Index. You can also personalize your comfort control temperature, mode and fan settings. See "Comfort Controls Personal Choice" in the Index.

If your vehicle is equipped with the Driver Information Center (DIC), you can also program these features through the DIC. See "Driver Information Center" in the Index.



## Security Feedback

This provides feedback to the driver when the vehicle receives a command from the remote keyless entry transmitter. The following modes may be selected:

<b>Mode</b>	<b>Security Feedback</b>
0	No feedback when locking or unlocking vehicle.
1	No feedback when locking; exterior lamps flash when unlocking vehicle.
2	Exterior lamps flash when locking; no feedback when unlocking vehicle.
3	Exterior lamps flash when locking and when unlocking vehicle.
4	Exterior lamps flash and horn chirps when locking; no feedback when unlocking vehicle.
5	Exterior lamps flash and horn chirps when locking; exterior lamps flash when unlocking vehicle.

Vehicles are delivered programmed in Mode 5; however, each remote keyless entry transmitter can be programmed to a different mode according to the user's preference. To change to another mode:

1. Press and hold **LOCK** on the power door lock switch on the door throughout the procedure.
2. Press the trunk button on the transmitter. The horn will chirp and the transmitter will remain in its current mode.
3. Press the trunk button again. Each time the trunk button is pressed, the horn will chirp and the transmitter will advance to the next mode.
4. Release the power door lock switch.

If your vehicle is equipped with the Driver Information Center (DIC), you can also program these features through the DIC. See "Driver Information Center" in the Index.

## Delayed Locking

This feature lets the driver delay the actual locking of the vehicle. When the power door lock switch is pressed with the key removed from the ignition and the driver's door open, a chime will sound three times to signal that the lock delay mode is active. When all doors have been closed, the doors will lock automatically after five seconds. If any door is opened before this, the five-second timer will reset itself once all the doors have been closed again.

Pressing the door lock switch twice within two seconds will override this feature.

The delayed locking feature can be turned on or off for each remote keyless entry transmitter.

To turn the feature on:

1. Press and hold LOCK on the power door lock switch on the door throughout this procedure. All the doors will lock.
2. Press the UNLOCK button on the transmitter to enter the programming mode. The lock delay is still off and all doors will remain locked.
3. Press the UNLOCK button on the transmitter again. Lock delay is now active and all doors will unlock.
4. Release the power door lock switch.

To turn this feature off, repeat the above procedure.

If your vehicle is equipped with the Driver Information Center (DIC), you can also program these features through the DIC. See "Driver Information Center" in the Index.

## Matching Transmitter(s) To Your Vehicle

Each remote keyless entry transmitter is coded to prevent another transmitter from unlocking your vehicle. If a transmitter is lost or stolen, a replacement can be purchased through your dealer. Remember to bring any remaining transmitters with you when you go to your dealer. When the dealer matches the replacement transmitter to your vehicle, any remaining transmitters must also be matched. Once your dealer has coded the new transmitter, the lost transmitter will not unlock your vehicle. Each vehicle can have only four transmitters matched to it.

See your dealer to match additional transmitters to your vehicle.

## Battery Replacement

Under normal use, the battery in your remote keyless entry transmitter should last about four years.

You can tell the battery is weak if the transmitter won't work at the normal range in any location. If you have to get close to your vehicle before the transmitter works, it's probably time to change the battery.



For battery replacement, use a Duracell® battery, type DL-2032, or a similar type.

## NOTICE:

**When replacing the battery, use care not to touch any of the circuitry. Static from your body transferred to these surfaces may damage the transmitter.**

To replace the battery:

1. Insert a coin into the notch near the key ring. Turn the coin to the left to separate the two halves of the transmitter.
2. Once the transmitter is separated, use a pencil eraser to remove the old battery. Do not use a metal object.
3. Remove and replace the battery as the instructions under the cover indicate.
4. Snap the transmitter back together tightly to be sure no moisture can enter.
5. Resynchronize the transmitter by pressing and holding the LOCK and UNLOCK buttons for about eight seconds within range of the vehicle. Once the transmitter is resynchronized, the horn will chirp and the exterior lamps will flash once.



## Trunk

### Trunk Lock Release

To unlock the trunk from the outside, insert the master door/ignition key and turn it.

### Remote Trunk Release

Press the TRUNK release button located to the left of the steering column to release the trunk lid.

The trunk will open if the transaxle is in PARK (P) or NEUTRAL (N) and the trunk release lockout is in the unlocked position.

The remote keyless entry system will also unlock your trunk if the ignition is off, or if the ignition is on and the transaxle is in PARK (P).

### Remote Trunk Release Lockout

The remote trunk release lockout button allows you to secure items in the trunk.

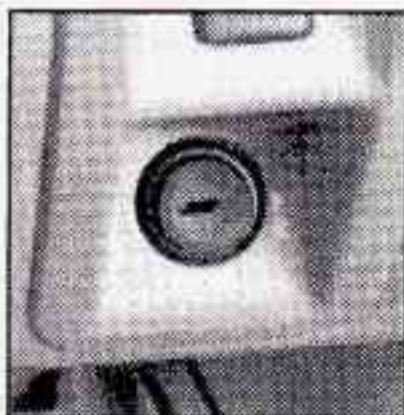

Insert the ignition key into the trunk release button. Turn the key one-quarter of a turn to the right then remove it from the button.

This will disable the trunk release button from opening the trunk.

### Trunk Security Override

The remote keyless entry transmitter will open the trunk when the ignition is on or off and the vehicle is in PARK, even if the trunk release lockout is activated.

 **CAUTION:**

**It can be dangerous to drive with the trunk lid open because carbon monoxide (CO) gas can come into your vehicle. You can't see or smell CO. It can cause unconsciousness and even death.**

**If you must drive with the trunk lid open or if electrical wiring or other cable connections must pass through the seal between the body and the trunk lid:**

- **Make sure all windows are shut.**
- **Turn the fan on your heating or cooling system to its highest speed with the setting on any airflow selection except RECIRC. That will force outside air into your vehicle. See "Comfort Controls" in the Index.**
- **If you have air outlets on or under the instrument panel, open them all the way. See "Engine Exhaust" in the Index.**

## Theft

Vehicle theft is big business, especially in some cities. Although your vehicle has a number of theft-deterrent features, we know that nothing we put on it can make it impossible to steal. However, there are ways you can help.

### Key in the Ignition

If you leave your vehicle with the keys inside, it's an easy target for joy riders or professional thieves -- so don't do it.

With the ignition off and the driver's door open, you'll hear a chime reminding you to remove your key from the ignition and take it with you. Always do this. Your ignition and transaxle will be locked. And remember to lock the doors.

### Parking at Night

Park in a lighted spot, close all windows and lock your vehicle. Remember to keep your valuables out of sight. Put them in a storage area, or take them with you.

## Parking Lots

If you park in a lot where someone will be watching your vehicle, it's best to lock it up and take your keys. But what if you have to leave your ignition key?

- If possible, park in a busy, well lit area.
- Put your valuables in a storage area, like your trunk or glove box. Be sure to close and lock the storage area.
- Close all windows.
- Lock the glove box.
- Lock all doors except the driver's.
- Give the valet key to the valet. Then take the master key and remote keyless entry transmitter with you.

## Content Theft-Deterrent



Your vehicle is equipped with a Content Theft-Deterrent alarm system. With this system, the SECURITY light will flash as you open the door (if your ignition is off).

This light reminds you to activate the theft-deterrent system. Here's how to do it:

1. Open the door.
2. Lock the door with the power door lock switch or the remote keyless entry transmitter. The SECURITY light should come on and stay on.
3. Close all doors. The SECURITY light should go off after approximately 30 seconds. The alarm is not armed until the SECURITY light goes off.



If a door is opened without the key or the remote keyless entry transmitter, the alarm will go off. Your vehicle's lamps will flash and the horn will sound for 30 seconds, then will turn off to save battery power.

Remember, the theft-deterrent system won't activate if you lock the doors with a key or use the manual door lock. It activates only if you use a power door lock switch with the door open, or with the remote keyless entry transmitter. You should also remember that you can start your vehicle with the correct ignition key if the alarm has been set off.

Here's how to avoid setting off the alarm by accident:

- If you don't want to activate the theft-deterrent system, the vehicle should be locked with the door key *after* the doors are closed.
- Always unlock a door with a key, or use the remote keyless entry transmitter. Unlocking a door any other way will set off the alarm.

If you set off the alarm by accident, unlock any door with your key. You can also turn off the alarm by pressing UNLOCK on the remote keyless entry transmitter. The alarm won't stop if you try to unlock a door any other way.

## Testing the Alarm

The alarm can be tested by following these steps:

1. From inside the vehicle, roll down the driver's window and open the driver's door.
2. Activate the system by locking the doors with the power door lock switch while the door is open, or with the remote keyless entry transmitter.
3. Get out of the car, close the door and wait for the SECURITY light to go out.
4. Then reach in through the window, unlock the door with the manual door lock and open the door. This should set off the alarm.

If the alarm does not sound when it should but the vehicle's lamps flash, check to see if the horn works. The horn fuse may be blown. To replace the fuse, see "Fuses and Circuit Breakers" in the Index.

If the alarm does not sound or the vehicle's lamps do not flash, the vehicle should be serviced by an authorized service center.

## PASS-Key<sup>®</sup> III



Your vehicle is equipped with the PASS-Key III (Personalized Automotive Security System) theft-deterrent system. PASS-Key III is a passive theft-deterrent system. This means you don't have to do anything different to arm or disarm the system. It works when you insert or remove the key from the ignition.

Your PASS-Key III system operates on a radio frequency subject to Federal Communications Commission (FCC) Rules and with Industry Canada.

This device complies with Part 15 of the FCC Rules. Operation is subject to the following two conditions: (1) this device may not cause harmful interference, and (2) this device must accept any interference received, including interference that may cause undesired operation.

This device complies with RSS-210 of Industry Canada. Operation is subject to the following two conditions: (1) this device may not cause interference, and (2) this device must accept any interference received, including interference that may cause undesired operation of the device.

Changes or modifications to this system by other than an authorized service facility could void authorization to use this equipment.

PASS-Key III uses a radio frequency transponder in the key that matches a decoder in your vehicle.

When the PASS-Key III system senses that someone is using the wrong key, it shuts down the vehicle's starter and fuel systems. The starter will not work and fuel will stop being delivered to the engine. Anyone using a trial-and-error method to start the vehicle will be discouraged because of the high number of electrical key codes.

When trying to start the vehicle if the engine does not start and the SECURITY light comes on, the key may have a damaged transponder. Turn the ignition off and try again.

If the engine still does not start, and the key appears to be undamaged, try another ignition key. At this time, you may also want to check the fuse (see "Fuses and Circuit Breakers" in the Index). If the engine still does not start with the other key, your vehicle needs service. If your vehicle does start, the first key may be faulty. See your dealer or a locksmith who can service the PASS-Key III to have a new key made.

It is possible for the PASS-Key III decoder to learn the transponder value of a new or replacement key. Up to ten additional keys may be programmed for the vehicle. This procedure is for learning additional keys only. If all the currently programmed keys are lost or do not operate, you must see your dealer or a locksmith who can service PASS-Key III to have keys made and programmed to the system.

See your dealer or a locksmith who can service PASS-Key III to get a new key blank that is a cut exactly as a current black colored driver's key that operates the system. Do not use a gray colored valet key for this procedure.

To program the new key:

1. Insert the current driver's key (black in color) in the ignition and start the engine. If the engine will not start see your dealer for service.
2. After the engine has started, turn the key to the off position, and remove the key.
3. Insert the key to be programmed and turn it to the run position within ten seconds of removing the previous key.
4. The SECURITY telltale light will turn off once the key has been programmed. It may not be apparent that the SECURITY light went on due to how quickly the key is programmed.
5. Repeat steps 1 through 4 if additional keys are to be programmed.

If you are ever driving and the SECURITY light comes on and stays on, you will be able to restart your engine if you turn it off. Your PASS-Key III system, however, is not working properly and must be serviced by your dealer. Your vehicle is not protected by the PASS-Key III system at this time.

If you lose or damage a PASS-Key III key, see your dealer or a locksmith who can service PASS-Key III to have a new key made.



## New Vehicle "Break-In"

### NOTICE:

Your vehicle doesn't need an elaborate "break-in." But it will perform better in the long run if you follow these guidelines:

- Don't drive at any one speed -- fast or slow -- for the first 500 miles (805 km). Don't make full-throttle starts.
- Avoid making hard stops for the first 200 miles (322 km) or so. During this time your new brake linings aren't yet broken in. Hard stops with new linings can mean premature wear and earlier replacement. Follow this breaking-in guideline every time you get new brake linings.
- Don't tow a trailer during break-in. See "Towing a Trailer" in the Index for more information.

## Ignition Positions

With the ignition key in the ignition switch, you can turn the switch to five different positions.

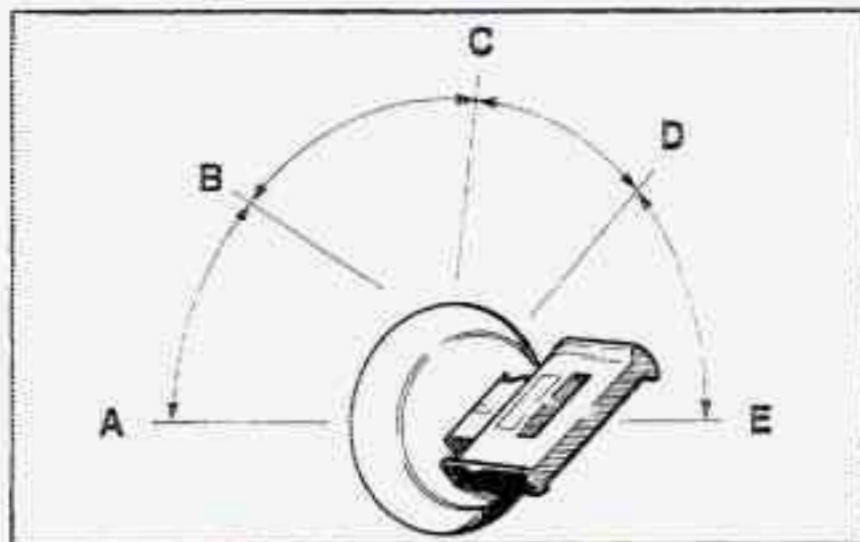

**ACCESSORY (A):** In this position you can operate your electrical power accessories. Press in the ignition switch as you turn the top of it toward you.

**LOCK (B):** This is the only position from which you can remove the key. This position locks your ignition, steering wheel and transaxle. It's a theft-deterrent feature.

**OFF (C):** This position lets you turn off the engine but still turn the steering wheel. It doesn't lock the steering wheel like LOCK and it doesn't send any electrical power to the accessories. The instrument panel cluster will remain powered in OFF to illuminate the gear shift indicator. The cluster will also activate the parking brake light when the parking brake is set. Use OFF if you must have your vehicle in motion while the engine is not running.

**RUN (D):** This is the position that the switch returns to after you start your engine and release the switch. This is the position for driving. Even when the engine is not running, you can use RUN to operate your electrical power accessories and to display some instrument panel warning lights.

**START (E):** This position starts your engine. When the engine starts, release the key. The ignition switch will return to RUN for normal driving.

## **NOTICE:**

**If your key seems stuck in LOCK and you can't turn it, be sure you are using the correct key; if so, is it all the way in? If it is, then turn the steering wheel left and right while you turn the key hard. But turn the key only with your hand. Using a tool to force it could break the key or the ignition switch. If none of this works, then your vehicle needs service.**

### **Key Reminder Warning**

If you leave your key in the ignition, with the engine off, you will hear a warning chime when you open the driver's door.

### **Retained Accessory Power**

After you turn the ignition off and even remove the key, you will still have electrical power to such accessories as the radio, astrorooftop and power windows for up to 10 minutes. Power is shut off if you open a door.

## Starting Your Engine

Move your shift lever to PARK (P) or NEUTRAL (N). Your engine won't start in any other position -- that's a safety feature. To restart when you're already moving, use NEUTRAL (N) only.

### **NOTICE:**

**Don't try to shift to PARK (P) if your Buick is moving. If you do, you could damage the transaxle. Shift to PARK (P) only when your vehicle is stopped.**

1. Without pushing the accelerator pedal, turn your ignition key to START. When the engine starts, let go of the key. The idle speed will go down as your engine gets warm.

### **NOTICE:**

**Holding your key in START for longer than 15 seconds at a time will cause your battery to be drained much sooner. And the excessive heat can damage your starter motor.**

2. If it doesn't start right away, hold your key in START for about three to five seconds at a time until your engine starts. Wait about 15 seconds between each try to help avoid draining your battery or damaging your starter.
3. If your engine still won't start (or starts but then stops), it could be flooded with too much gasoline. Try pushing your accelerator pedal all the way to the floor and holding it there as you hold the key in START for about three seconds. If the vehicle starts briefly but then stops again, do the same thing, but this time keep the pedal down for five or six seconds. This clears the extra gasoline from the engine. After waiting about 15 seconds, repeat the normal starting procedure.



## **NOTICE:**

**Your engine is designed to work with the electronics in your vehicle. If you add electrical parts or accessories, you could change the way the engine operates. Before adding electrical equipment, check with your dealer. If you don't, your engine might not perform properly.**

**If you ever have to have your vehicle towed, see the part of this manual that tells how to do it without damaging your vehicle. See "Towing Your Vehicle" in the Index.**

## **Engine Coolant Heater (If Equipped)**

In very cold weather, 0°F (-18°C) or colder, the engine coolant heater can help. You'll get easier starting and better fuel economy during engine warm-up. Usually, the coolant heater should be plugged in a minimum of four hours prior to starting your vehicle.

## **To Use the Engine Coolant Heater**

1. Turn off the engine.
2. Open the hood and unwrap the electrical cord.
3. Plug it into a normal, grounded 110-volt AC outlet.



## **CAUTION:**

**Plugging the cord into an ungrounded outlet could cause an electrical shock. Also, the wrong kind of extension cord could overheat and cause a fire. You could be seriously injured. Plug the cord into a properly grounded three-prong 110-volt AC outlet. If the cord won't reach, use a heavy-duty three-prong extension cord rated for at least 15 amps.**

4. Before starting the engine, be sure to unplug and store the cord as it was before to keep it away from moving engine parts. If you don't, it could be damaged.

How long should you keep the coolant heater plugged in? The answer depends on the outside temperature, the kind of oil you have, and some other things. Instead of trying to list everything here, we ask that you contact your dealer in the area where you'll be parking your vehicle. The dealer can give you the best advice for that particular area.

## Automatic Transaxle Operation

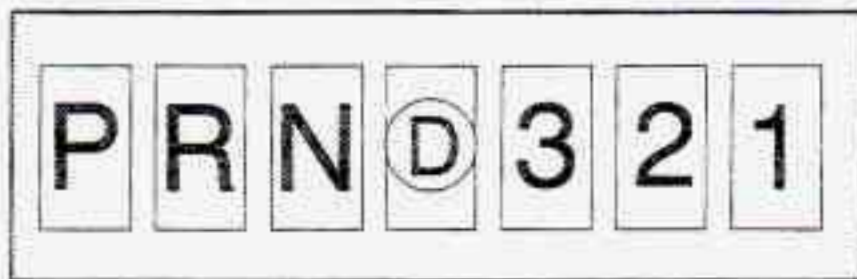

Your automatic transaxle has a shift lever located on the steering column.

There are several different positions for your shift lever.

**PARK (P):** This locks your front wheels. It's the best position to use when you start your engine because your vehicle can't move easily.



## CAUTION:

It is dangerous to get out of your vehicle if the shift lever is not fully in **PARK (P)** with the parking brake firmly set. Your vehicle can roll.

Don't leave your vehicle when the engine is running unless you have to. If you have left the engine running, the vehicle can move suddenly. You or others could be injured. To be sure your vehicle won't move, even when you're on fairly level ground, always set your parking brake and move the shift lever to **PARK (P)**.

See "Shifting Into **PARK (P)**" in the Index. If you're pulling a trailer, see "Towing a Trailer" in the Index.

Ensure the shift lever is fully in PARK (P) range before starting the engine. Your vehicle has a brake-transaxle shift interlock. You have to fully *apply* your regular brakes *before* you can shift from PARK (P) when the ignition key is in RUN. If you cannot shift out of PARK (P), ease pressure on the shift lever -- push the shift lever all the way into PARK (P) as you maintain brake application. Then move the shift lever into the gear you wish. See "Shifting Out of PARK (P)" in the Index.

**REVERSE (R):** Use this gear to back up.

### **NOTICE:**

**Shifting to REVERSE (R) while your vehicle is moving forward could damage your transaxle. Shift to REVERSE (R) only after your vehicle is stopped.**

To rock your vehicle back and forth to get out of snow, ice or sand without damaging your transaxle, see "Stuck: In Sand, Mud, Ice or Snow" in the Index.

**NEUTRAL (N):** In this position, your engine doesn't connect with the wheels. To restart when you're already moving, use NEUTRAL (N) only. Also, use NEUTRAL (N) when your vehicle is being towed.

### **CAUTION:**

**Shifting out of PARK (P) or NEUTRAL (N) while your engine is "racing" (running at high speed) is dangerous. Unless your foot is firmly on the brake pedal, your vehicle could move very rapidly. You could lose control and hit people or objects. Don't shift out of PARK (P) or NEUTRAL (N) while your engine is racing.**

### **NOTICE:**

**Damage to your transaxle caused by shifting out of PARK (P) or NEUTRAL (N) with the engine racing isn't covered by your warranty.**



**AUTOMATIC OVERDRIVE (Ⓢ):** This position is for normal driving. If you need more power for passing, and you're:

- Going less than about 35 mph (55 km/h), push your accelerator pedal about halfway down.
- Going about 35 mph (55 km/h) or more, push the accelerator all the way down.

You'll shift down to the next gear and have more power.

**THIRD (3):** This position is also used for normal driving, however, it offers more power and lower fuel economy than AUTOMATIC OVERDRIVE (Ⓢ).

Here are some times you might choose THIRD (3) instead of AUTOMATIC OVERDRIVE (Ⓢ):

- When driving on hilly, winding roads,
- When towing a trailer, so there is less shifting between gears, or
- When going down a steep hill.

**SECOND (2):** This position gives you more power but lower fuel economy. You can use SECOND (2) on hills. It can help control your speed as you go down steep mountain roads, but then you would also want to use your brakes off and on.

### **NOTICE:**

**Don't drive in SECOND (2) for more than 5 miles (8 km), or at speeds over 55 mph (88 km/h), or you can damage your transaxle. Use AUTOMATIC OVERDRIVE (Ⓢ) or THIRD (3) as much as possible.**

**Don't shift into SECOND (2) unless you are going slower than 65 mph (105 km/h), or you can damage your engine.**

**FIRST (1):** This position gives you even more power (but lower fuel economy) than **SECOND (2)**. You can use it on very steep hills, or in deep snow or mud. If the selector lever is put in **FIRST (1)**, the transaxle won't shift into first gear until the vehicle is going slowly enough.

## **NOTICE:**

**If your front wheels can't rotate, don't try to drive. This might happen if you were stuck in very deep sand or mud or were up against a solid object. You could damage your transaxle.**

**Also, if you stop when going uphill, don't hold your vehicle there with only the accelerator pedal. This could overheat and damage the transaxle. Use your brakes or shift into **PARK (P)** to hold your vehicle in position on a hill.**

## **Parking Brake**



Your vehicle has a **PUSH TO RELEASE** parking brake pedal. To set the parking brake, hold the regular brake pedal down with your right foot. Push down the parking brake pedal with your left foot.

Whether the ignition key is in **RUN** or **OFF**, the brake system warning light stays on while the parking brake is set.

The parking brake uses the brakes on the rear wheels.

To release the parking brake, hold the regular brake pedal down and push the parking brake pedal with your left foot. This will unlock the pedal. When you lift your left foot, the parking brake pedal will follow it to the release position.

If you try to drive (approximately 20 feet (6.1 m)) with the parking brake on, the brake light stays on and a continuous chime sounds until you release the parking brake.

### **NOTICE:**

Driving with the parking brake on can cause your rear brakes to overheat. You may have to replace them, and you could also damage other parts of your vehicle.

If you are towing a trailer and are parking on any hill, see "Towing a Trailer" in the Index. That part shows what to do first to keep the trailer from moving.

## Shifting Into PARK (P)



### **CAUTION:**

It can be dangerous to get out of your vehicle if the shift lever is not fully in PARK (P) with the parking brake firmly set. Your vehicle can roll. If you have left the engine running, the vehicle can move suddenly. You or others could be injured. To be sure your vehicle won't move, even when you're on fairly level ground, use the steps that follow. If you're pulling a trailer, see "Towing a Trailer" in the Index.

1. Hold the brake pedal down with your right foot and set the parking brake.



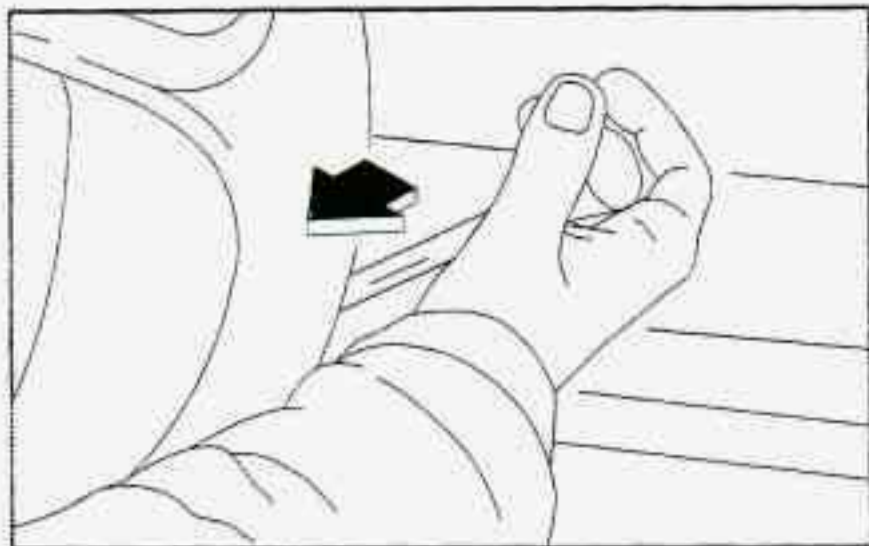

2. Move the shift lever into PARK (P) as follows:

- Pull the lever toward you.

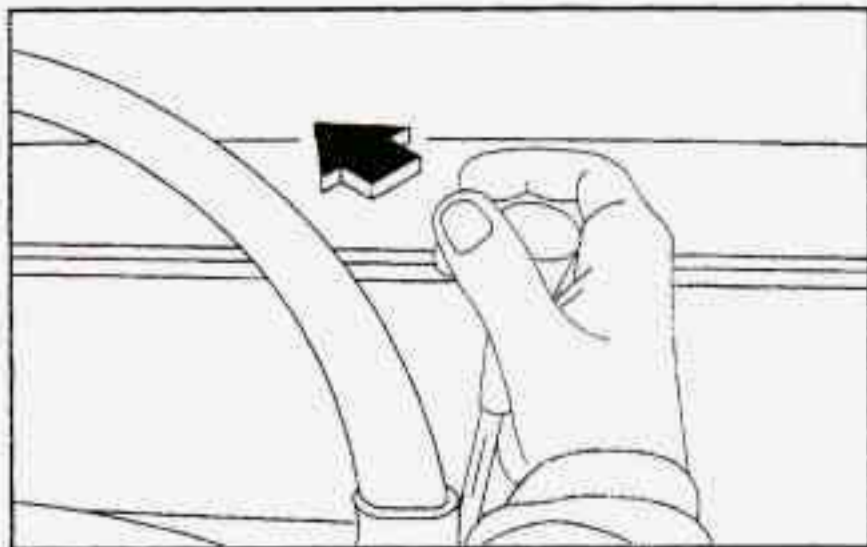

- Move the lever up as far as it will go.

3. Move the ignition key to LOCK.
4. Remove the key and take it with you. If you can leave your vehicle with the ignition key in your hand, your vehicle is in PARK (P).

## Leaving Your Vehicle With the Engine Running

### CAUTION:

**It can be dangerous to leave your vehicle with the engine running. Your vehicle could move suddenly if the shift lever is not fully in PARK (P) with the parking brake firmly set. And, if you leave the vehicle with the engine running, it could overheat and even catch fire. You or others could be injured. Don't leave your vehicle with the engine running unless you have to.**

If you have to leave your vehicle with the engine running, be sure your vehicle is in PARK (P) and your parking brake is firmly set before you leave it. After you've moved the shift lever into the PARK (P) position, hold the regular brake pedal down. Then, see if you can move the shift lever away from PARK (P) without first pulling it toward you. If you can, it means that the shift lever wasn't fully locked into PARK (P).

## Torque Lock

If you are parking on a hill and you don't shift your transaxle into PARK (P) properly, the weight of the vehicle may put too much force on the parking pawl in the transaxle. You may find it difficult to pull the shift lever out of PARK (P). This is called "torque lock." To prevent torque lock, set the parking brake and then shift into PARK (P) properly before you leave the driver's seat. To find out how, see "Shifting Into PARK (P)" in the Index.

When you are ready to drive, move the shift lever out of PARK (P) *before* you release the parking brake.

If torque lock does occur, you may need to have another vehicle push yours a little uphill to take some of the pressure from the parking pawl in the transaxle, so you can pull the shift lever out of PARK (P).

## Shifting Out of PARK (P)

Your vehicle has a brake-transaxle shift interlock. You have to fully *apply* your regular brake *before* you can shift from PARK (P) when the ignition is in RUN. See "Automatic Transaxle" in the Index.

If you cannot shift out of PARK (P), ease pressure on the shift lever -- push the shift lever all the way into PARK (P) as you maintain brake application. Then move the shift lever into the gear you want.

If you ever hold the brake pedal down but still can't shift out of PARK (P), try this:

1. Turn the key to OFF. Open and close the driver's door to turn off the retained-accessory power feature.
2. Apply and hold the brake until the end of Step 4.
3. Shift to NEUTRAL (N).
4. Start the vehicle and then shift to the drive gear you want.
5. Have the vehicle fixed as soon as you can.

## Parking Over Things That Burn



### CAUTION:

Things that can burn could touch hot exhaust parts under your vehicle and ignite. Don't park over papers, leaves, dry grass or other things that can burn.



## Engine Exhaust

### CAUTION:

Engine exhaust can kill. It contains the gas carbon monoxide (CO), which you can't see or smell. It can cause unconsciousness and death.

You might have exhaust coming in if:

- Your exhaust system sounds strange or different.
- Your vehicle gets rusty underneath.
- Your vehicle was damaged in a collision.
- Your vehicle was damaged when driving over high points on the road or over road debris.
- Repairs weren't done correctly.
- Your vehicle or exhaust system had been modified improperly.

If you ever suspect exhaust is coming into your vehicle:

- Drive it only with all the windows down to blow out any CO; and
- Have your vehicle fixed immediately.

## Running Your Engine While You're Parked

It's better not to park with the engine running. But if you ever have to, here are some things to know.

### CAUTION:

Idling the engine with the climate control system off could allow dangerous exhaust into your vehicle (see the earlier Caution under "Engine Exhaust").

Also, idling in a closed-in place can let deadly carbon monoxide (CO) into your vehicle even if the fan switch is at the highest setting. One place this can happen is a garage. Exhaust -- with CO -- can come in easily. NEVER park in a garage with the engine running.

Another closed-in place can be a blizzard. (See "Blizzard" in the Index.)

**⚠ CAUTION:**

**It can be dangerous to get out of your vehicle if the shift lever is not fully in PARK (P) with the parking brake firmly set. Your vehicle can roll. Don't leave your vehicle when the engine is running unless you have to. If you've left the engine running, the vehicle can move suddenly. You or others could be injured. To be sure your vehicle won't move, even when you're on fairly level ground, always set your parking brake and move the shift lever to PARK (P).**

Follow the proper steps to be sure your vehicle won't move. See "Shifting Into PARK (P)" in the Index.

If you are parking on a hill and if you're pulling a trailer, also see "Towing a Trailer" in the Index.

## Windows

### Power Windows



Switches on the driver's armrest control each of the windows while the ignition is on or retained accessory power is active. In addition, each passenger door has a switch for its own window.

### Express-Down Window

The switch for the driver's window has an express-down feature. Pull the switch back all the way, release it and the window will lower automatically. To stop the window from lowering, pull the switch again. To partially open the window, pull the switch back half way. When the switch is released, the window will stop moving. To raise the window, press and hold the switch forward.

### Window Lock

Press the window lock switch on the driver's armrest to disable all passenger window switches, or just the rear passenger switches. The middle of the switch will light to indicate the window lockout is active.

The driver's window controls will still be operable. This is a useful feature when you have children as passengers.

Press the window lock switch a second time to allow passengers to use their window controls again. The light in the center of the switch will go off to indicate that the feature is disabled.

Vehicles are delivered programmed to lock out all passenger windows. If you have the optional DIC, you can choose to lock out only the rear windows. See "Personal Choice Features" or "Driver Information Center" in the Index for programming instructions. If you do not have the DIC feature, see your dealer if you choose to have this setting changed to lock out only the rear windows.

### Horn

Nearly the entire surface of the center pad of the steering wheel is an active horn switch. Press anywhere on the pad to sound the horn.



## Tilt Wheel



A tilt steering wheel allows you to adjust the steering wheel before you drive.

You can also raise it to the highest level to give your legs more room when you exit and enter the vehicle.

To tilt the wheel, hold the steering wheel and pull the lever toward you. Move the steering wheel to a comfortable position, then release the lever to lock the wheel in place.

## Turn Signal/Multifunction Lever

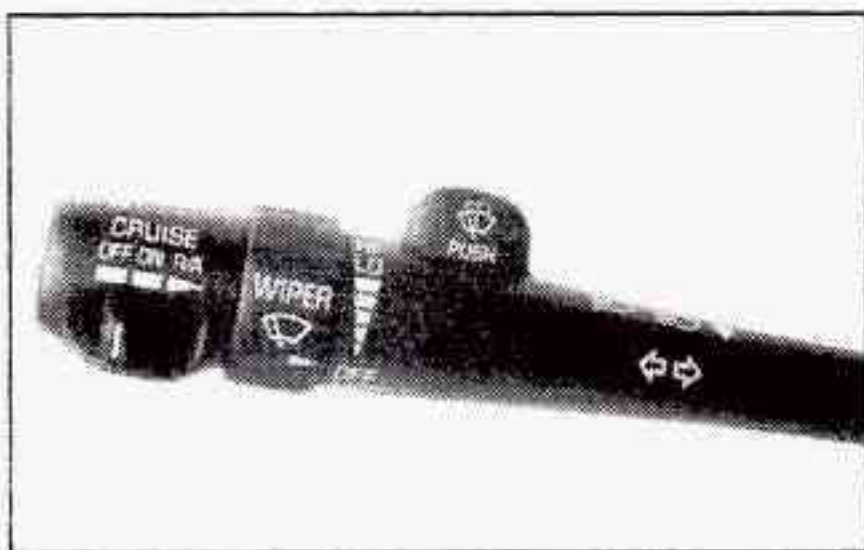

The lever on the left side of the steering column includes your:

- Turn Signal and Lane Change Indicator
- Headlamp High/Low Beam Changer
- Windshield Wipers and Washer
- Cruise Control
- Flash-to-Pass

## Turn Signal and Lane Change Indicator

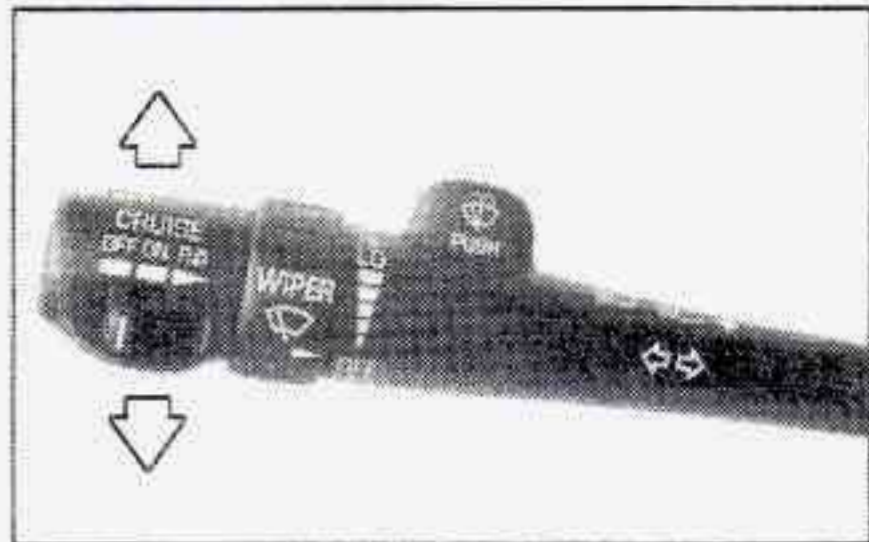

The turn signal has two upward (for right) and two downward (for left) positions. These positions allow you to signal a turn or a lane change.

To signal a turn, move the lever all the way up or down. When the turn is finished, the lever will return automatically.

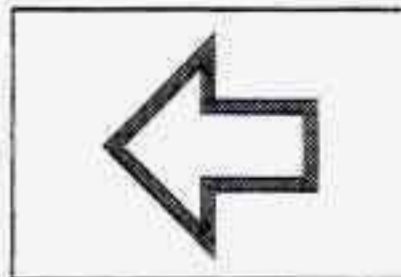

An arrow on the instrument panel will flash in the direction of the turn or lane change. If your vehicle is equipped with the Head-Up Display (HUD), an arrow will also appear in the display area to indicate the direction of the turn or lane change.

To signal a lane change, just raise or lower the lever until the arrow starts to flash. Hold it there until you complete your lane change. The lever will return by itself when you release it.

As you signal a turn or a lane change, if the arrows flash at twice the normal rate, this may indicate that a signal bulb may be burned out and other drivers won't see your turn signal.

If a bulb is burned out, replace it to help avoid an accident. If the arrows don't go on at all when you signal a turn, check the fuse (see "Fuses and Circuit Breakers" in the Index) and for burned-out bulbs.

If you have a trailer towing option with added wiring for the trailer lamps, the signal indicator will flash even if a turn signal bulb is burned out. Check the front and rear turn signal lamps regularly to make sure they are working. Note: You do not need to add a different flasher.

### Turn Signal On Chime

If your turn signal is left on for more than 3/4 of a mile (1.2 km), a chime will sound at each flash of the turn signal. To turn off the chime, move the turn signal lever to the off position.

### Headlamp High/Low Beam Changer

To change the headlamps from low beam to high or high to low, pull the turn signal lever toward you, then release it.



When the high beams are on, a light on the instrument panel will also be on. If your vehicle is equipped with HUD, this light will also appear in the display area.

### Flash-To-Pass Feature

This feature lets you use your high-beam headlamps to signal a driver in front of you that you want to pass. It works even if your headlamps are off.

To use it, pull the turn signal lever toward you, but not so far that you hear a click.

If your headlamps are off or on low beam, your high-beam headlamps will turn on. They'll stay on as long as you hold the lever toward you and the high-beam indicator on the dash will come on. Release the lever to turn the high-beam headlamps off.



## Windshield Wipers

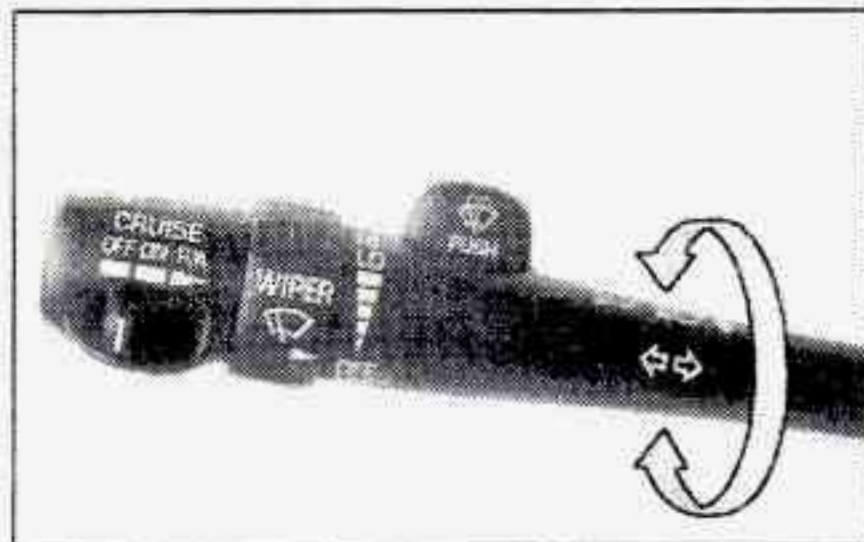

You control the windshield wipers by turning the band marked WIPER.

For a single wiping cycle, turn the band to MIST. Hold it there until the wipers start, then let go. The wipers will stop after one cycle. If you want more cycles, hold the band on MIST longer.

You can set the wiper speed for a long or short delay between wipes. This can be very useful in light rain or snow. Turn the band to choose the delay time. The closer to LO, the shorter the delay between wipes.

For steady wiping at low speed, turn the band away from you to the LO position. For high-speed wiping, turn the band further, to HI. To stop the wipers, move the band to OFF.

Remember that damaged wiper blades may prevent you from seeing well enough to drive safely. To avoid damage, be sure to clear ice and snow from the wiper blades before using them. If they're frozen to the windshield, carefully loosen or thaw them. If your blades become damaged, get new blades or blade inserts.

Heavy snow or ice can overload your wiper motor. A circuit breaker will stop the motor until it cools. Clear away snow or ice to prevent an overload.

## Moisture-Sensing Delay Windshield Wipers (If Equipped)

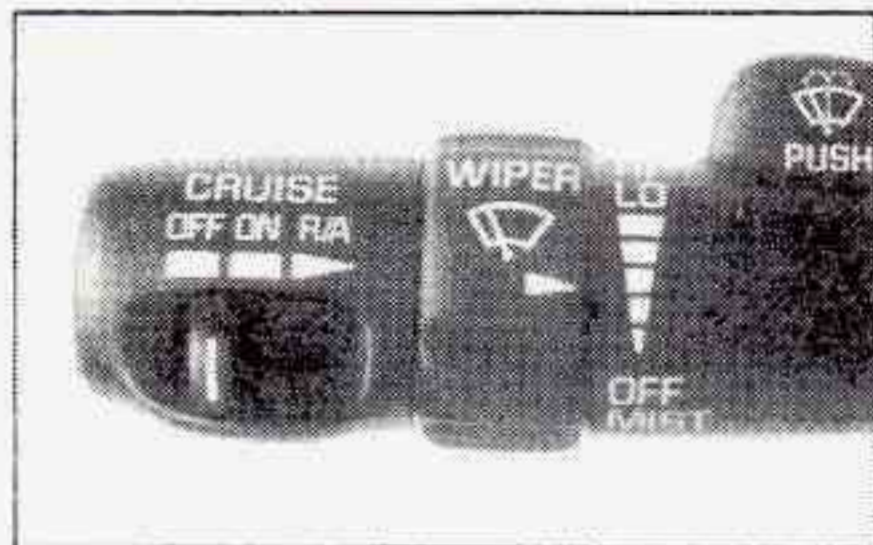

The moisture sensor is mounted on the passenger's interior side of the windshield behind the rearview mirror and is used to automatically operate the wipers by monitoring the amount of moisture on the windshield.

The moisture-sensing system is activated by turning the wiper control band to one of the five sensitivity levels within the DELAY area. The DELAY position closest to OFF/MIST is the lowest sensitivity setting. This allows more water to collect on the windshield between wipes.

You can increase the sensitivity of the system and the frequency of wipes by rotating the wiper control band away from you to the other DELAY settings. A single wipe will occur each time you turn the wiper control band to a higher sensitivity level.

An initial wipe occurs when you turn the ignition on as a reminder that the rain sense feature is active.

The moisture-sensing wipers operate in a delay mode as well as a continuous low or high speed, depending on the amount of moisture on the windshield and the sensitivity setting. The MIST and wash cycles operate as normal and are not effected by the moisture-sensing function.

### **NOTICE:**

**Turn the wiper band to OFF to avoid wiper damage when going through an automatic car wash.**

It is important to note that the moisture-sensing delay wiping feature can be overridden at any time by manually turning the wiper band to LO or HI speed.

If the windshield on your vehicle ever needs replacement, make sure that the new windshield is moisture-sensing delay compatible.

### Windshield Washer

At the top of the multifunction lever there is a paddle with the word PUSH on it. For "programmed" operation, press and release the paddle. The washer will provide a measured amount of fluid to the windshield and the wiper will either stop or return to your original wiping speed. For "demand" operation, press and hold the paddle for at least two seconds. Release the paddle when you have enough fluid and the wipers will either stop or return to your original wiping speed.



### CAUTION:

**In freezing weather, don't use your washer until the windshield is warmed. Otherwise the washer fluid can form ice on the windshield, blocking your vision.**

If your vehicle is equipped with a DIC, a WINDSHIELD WASHER FLUID LOW message will appear on the display when the vehicle is low on washer fluid.

### Cruise Control

With cruise control, you can maintain a speed of about 25 mph (40 km/h) or more without keeping your foot on the accelerator. This can really help on long trips.

Cruise control does not work at speeds below about 25 mph (40 km/h).

When you apply your brakes, the cruise control shuts off.



**⚠ CAUTION:**

- Cruise control can be dangerous where you can't drive safely at a steady speed. So, don't use your cruise control on winding roads or in heavy traffic.
- Cruise control can be dangerous on slippery roads. On such roads, fast changes in tire traction can cause needless wheel spinning, and you could lose control. Don't use cruise control on slippery roads.

If your vehicle is in cruise control when the optional traction control system begins to limit wheel spin, the cruise control will automatically disengage. (See "Traction Control System" in the Index.) When road conditions allow you to safely use it again, you may turn the cruise control back on.

### Setting Cruise Control

**⚠ CAUTION:**

If you leave your cruise control switch on when you're not using cruise, you might hit a button and go into cruise when you don't want to. You could be startled and even lose control. Keep the cruise control switch off until you want to use it.



1. Move the cruise control switch to ON.

2. Get up to the speed you want.



3. Push in the SET button at the end of the lever and release it. The CRUISE light on the instrument panel will come on.

4. Take your foot off the accelerator pedal.

### Resuming a Set Speed

Setting the cruise control at a desired speed and then applying the brake will end the cruise control function.



Once you're going about 25 mph (40 km/h) or more, you can move the cruise control switch from ON to R/A (Resume/Accelerate) for about half a second to reset. This returns you to your desired preset speed.

Remember, if you hold the switch at R/A longer than half a second, the vehicle will accelerate until you release the switch or apply the brake. So unless you want to go faster, don't hold the switch at R/A.

### Increasing Speed While Using Cruise Control

There are two ways to go to a higher speed:



- Use the accelerator pedal to go to a higher speed. Push the button at the end of the lever, then release the button and the accelerator pedal. You'll now cruise at the higher speed.

- Move the cruise switch from ON to R/A. Hold it there until you reach a desired speed and then release the switch. To increase your speed in very small amounts, move the switch to R/A for less than half a second and then release it.

Each time you do this, your vehicle will go about 1 mph (1.6 km/h) faster.

The accelerate feature will only work after you have set the cruise control speed by pushing the SET button.

### Reducing Speed While Using Cruise Control

There are two ways to reduce your speed while using cruise control:



- Push in the button at the end of the lever until you reach a desired lower speed then release it.

- To slow down in very small amounts, push the button for less than half a second. Each time you do this, you'll go 1 mph (1.6 km/h) slower.



## Passing Another Vehicle While Using Cruise Control

Use the accelerator pedal to increase your speed. When you take your foot off the pedal, your vehicle will slow down to the cruise control speed you set earlier.

## Using Cruise Control on Hills

How well your cruise control will work on hills depends upon your speed, load and the steepness of the hills. When going up steep hills, you may have to step on the accelerator pedal to maintain your speed. When going downhill, you may have to brake or shift to a lower gear to keep your speed down. Of course, applying the brake takes you out of cruise control. Many drivers find this to be too much trouble and don't use cruise control on steep hills.

## Ending Cruise Control

There are two ways to turn off the cruise control:

- Step lightly on the brake pedal, or
- Move the cruise switch to OFF. The CRUISE light will also go out.

## Erasing Speed Memory

When you turn off the cruise control or the ignition, your cruise control set speed memory is erased.

## Exterior Lamps

### Headlamps



This knob controls these systems:

- Headlamps
- Taillamps
- Parking Lamps
- License Lamps
- Sidemarkers Lamps
- Instrument Panel Lights
- Interior Courtesy Lamps

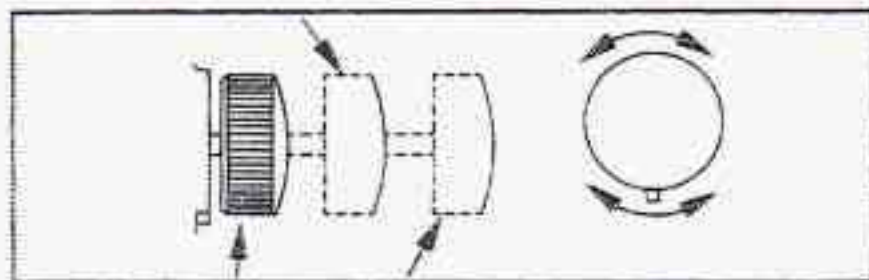

Pull the headlamp knob out to the first indent to turn on the parking lamps. Pull the knob out further, to the second indent to turn on the headlamps. Push the knob all the way back in to turn off the parking and headlamps.

### Lamps On Reminder

If you leave the manual headlamp or parking lamp switch on, remove the key from the ignition and open the driver's door, you will hear a continuous warning chime. The chime will turn off when the lamps are turned off.

### Daytime Running Lamps

Daytime Running Lamps (DRL) can make it easier for others to see the front of your vehicle during the day. DRL can be helpful in many different driving conditions, but they can be especially helpful in the short periods after dawn and before sunset.

A light sensor on top of the instrument panel monitors the exterior light level for the operation of DRL and twilight sentinel, so be sure it isn't covered.

The DRL system will make your high-beam headlamps come on at reduced brightness in daylight when:

- The ignition is on,
- The headlamp switch is off and
- The transaxle is not in PARK (P).

When DRL are on, only your high-beam headlamps will be on. The parking lamps, taillamps, sidemarker and other lamps won't be on. Your instrument panel won't be lit up either.

When it's dark enough outside, your high-beam headlamps will change to low-beam headlamps at full brightness. The other lamps that turn on with your headlamps will also turn on. When it's bright enough outside, the regular lamps will turn off, and your high-beam headlamps change to the reduced brightness of DRL.

To idle your vehicle with the DRL off, shift the transaxle into PARK (P). The DRL will stay off until you shift out of PARK (P).

To turn off all exterior lighting at night when you are parked, turn off the headlamps and move the twilight sentinel control to the left into the detent in the slider control. When released, the control will return to the Twilight Sentinel minimum delay position and the lights will turn off.

As with any vehicle, you should turn on the regular headlamp system when you need it.

### Cornering Lamps

The cornering lamps are designed to come on when you signal a turn. This will provide more light for cornering at night.

### Twilight Sentinel



Twilight Sentinel turns your headlamps on and off by sensing how dark it is outside.

To operate this feature, slide the control to any position to vary the lamp timeout.

If you move the control all the way to MAX, your lamps will remain on for three minutes after you turn off your engine. If you move the control almost all the way in the other direction, so it's just on, the lamps will go off quickly when you turn off your engine. You can set this delay time from only a few seconds to three minutes.

### Light Sensor

Your twilight sentinel and daytime running lamps work with the light sensor on top of the instrument panel. Don't cover it up. If you do it will read "dark" and the headlamps will come on.



## Interior Lamps

### Instrument Panel Intensity Control

Instrument panel light brightness can be adjusted by rotating the headlamp knob to the left and right.

### Courtesy Lamps

When any door is opened, several lamps go on. They make it easy for you to enter and leave the car. You can also turn these lamps on by rotating the headlamp knob clockwise all the way past the detent.

### Delayed Entry Lighting

When you open the door, the interior lamps will come on. When you close the door with the ignition off, the interior lamps will stay on for 25 seconds or until the ignition is turned to an on position. Please note that locking the doors with the power door lock switch will override the delayed entry lighting feature and the lamps will turn off right away.

**NOTE:** Using the remote keyless entry transmitter to lock the door will not cancel delayed lighting.

### Theater Dimming

This feature allows for a three to five-second fade out of the courtesy lamps instead of immediate turn off.

### Parade Dimming

This feature prohibits the dimming of your instrument panel displays during daylight while your headlamps are on. This feature operates with the light sensor for the twilight sentinel and is fully automatic. When the light sensor reads darkness outside, you will be able to dim your instrument panel displays once again.

### Delayed Exit Lighting

With this feature, the interior lamps will come on for 25 seconds after you remove the key from the ignition. This will give you time to find the door pull handle or lock switches.

### Illuminated Entry System

When you open either front door or press the UNLOCK button on the remote keyless entry transmitter, the lamps inside your vehicle will turn on. These lamps will turn off after about 40 seconds. These lamps will also turn off if you start the engine or activate the power door locks.

## Perimeter Lighting

When the UNLOCK button on the remote keyless entry transmitter is pressed, the daytime running lamps (high beams at reduced intensity), parking lamps and back-up lamps will come on if it is dark enough outside according to the twilight sentinel.

This feature will only be activated when the security feedback feature is programmed to be in Modes 1, 3 or 5 on the transmitter. Modes 0, 2 and 4 do not respond with exterior lights flashing when unlocking the vehicle so perimeter lighting will not be active.

This feature can be programmed on or off for each transmitter.

To turn the feature off:

1. Press and hold LOCK on the door lock switch on the door throughout this procedure. All doors will lock.
2. Press the instant alarm button on the transmitter to enter the programming mode. Perimeter lighting remains on at this time and the horn will chirp two times.

3. Press the instant alarm button on the key transmitter again. Perimeter lighting is disabled and the horn will chirp one time.
4. Release the door lock switch. The perimeter lighting feature is now off.

Pressing the UNLOCK button repeatedly may cause the back-up lamps to turn on.

To turn the feature on:

1. Press and hold LOCK on the door lock switch on the door throughout this procedure. All doors will lock.
2. Press the instant alarm button on the key transmitter to enter the programming mode. Perimeter lighting remains off at this time and the horn will chirp one time.
3. Press the instant alarm button on the transmitter again. Perimeter lighting is now enabled and the horn will chirp two times.
4. Release the door lock switch. The perimeter lighting feature is now on.

Perimeter lighting can also be activated through the optional Driver Information Center (DIC). See "Personal Choice Features" or "Driver Information Center" in the Index.

## Front Reading Lamps

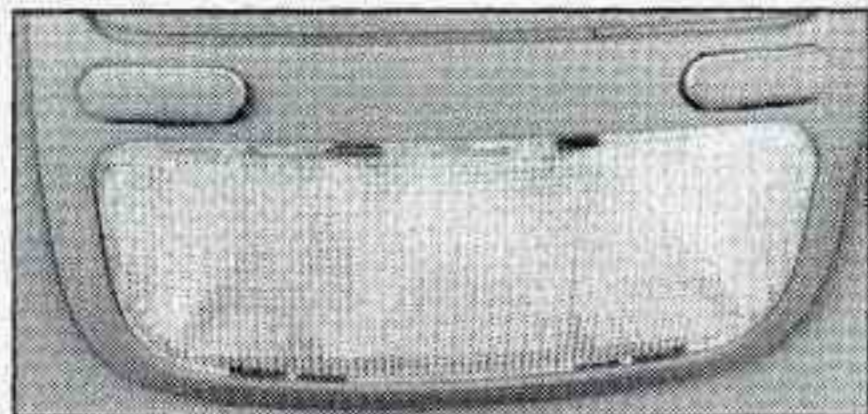

These lamps and the interior courtesy lamps will come on when you open a door. They will turn off when you turn on the ignition.

To turn on the front seat reading lamps when the doors are closed, press the button behind the lamp you want on. Press it again to turn the lamp off.

These lamps work even when the ignition is off. To avoid draining your vehicle's battery, be sure to turn off all front and rear reading lamps when leaving your vehicle.

## Rear Reading Lamps

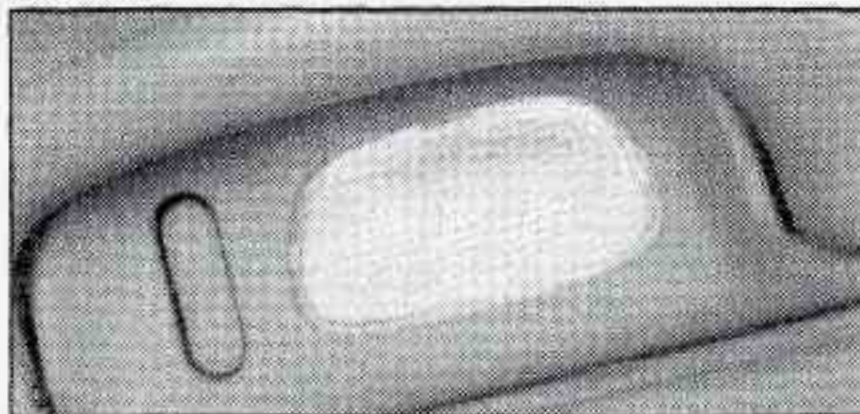

To turn on a rear seat reading lamp, press the switch above that rear door. To turn off the reading lamp, press the switch again.



## Trunk Lamp

When you open the trunk to its full open position, a lamp will come on inside the trunk. This lamp will automatically turn off when the trunk is closed.

## Glove Box Lamp

When you open the glove box, a lamp will come on inside the glove box. This will automatically turn off when the glove box is closed.

## Battery Rundown Protection

This feature shuts off all lamps that are left on for more than 10 minutes when the ignition is off. This will keep your battery from running down.

## Mirrors

### Inside Manual Day/Night Rearview Mirror



When you are sitting in a comfortable driving position, adjust the mirror so you can see clearly behind your vehicle. Grip the mirror in the center to move it up or down and side to side. The day/night adjustment allows you to adjust the mirror to avoid glare from the lamps behind you. Pull the tab forward for daytime use; push it back for night use.

## Electrochromic Day/Night Rearview Mirror (If Equipped)

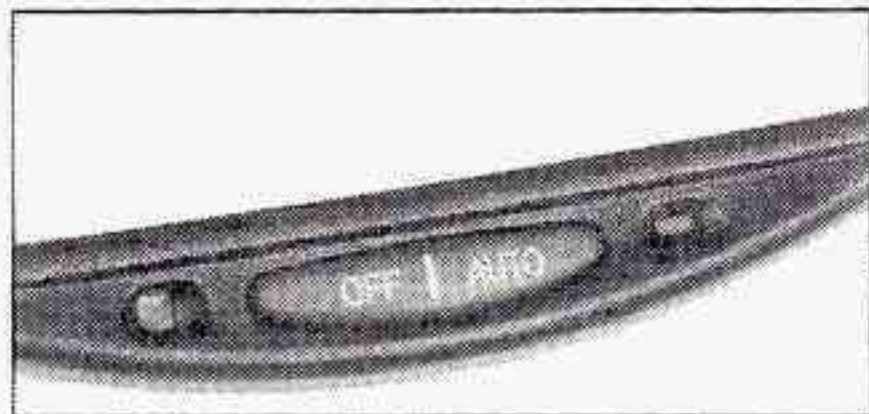

Your vehicle may have an automatic electrochromic day/night rearview mirror.

When this feature is turned on, the mirror automatically changes to reduce glare from headlamps behind you. A photocell on the mirror senses when it is becoming dark outside. Another photocell built into the mirror face, senses when headlamps are behind you.

At night, when the glare is too high, the mirror will gradually darken to reduce glare (this change may take a few seconds). The mirror will return to its clear daytime state when the glare is reduced.

## Mirror Operation

To turn on the automatic dimming feature, press AUTO. To turn off automatic dimming, press OFF. The green indicator light will be illuminated when this feature is active.

## Time Delay

The automatic mirror has a time delay feature which prevents unnecessary switching from the night back to the day position. This delay prevents rapid changing of the mirror as you drive under lights and through traffic.

## Cleaning the Photocells

Use a cotton swab and glass cleaner to clean the photocells when necessary.

## Electrochromic Day/Night Rearview Mirror with Compass (If Equipped)

Your vehicle may have an electrochromic inside rearview mirror with a compass.

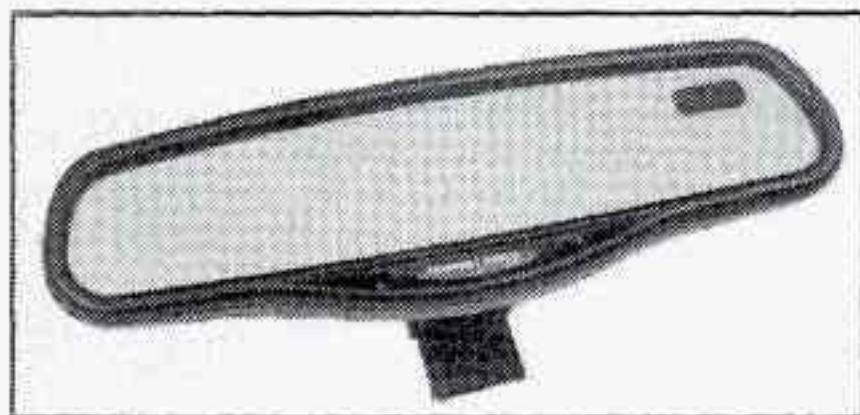

When set in the MIRROR position, this mirror automatically changes to reduce glare from headlamps behind you. A time delay feature prevents rapid changing from the day to night positions while driving under lights and through traffic.

The mirror also includes an eight-point compass display in the upper right corner of the mirror face. When on, the compass automatically calibrates as the vehicle is driven.

When cleaning the mirror, use a paper towel or similar material dampened with glass cleaner. Do not spray glass cleaner directly on the mirror as that may cause the liquid cleaner to enter the mirror housing. Use a cotton swab and glass cleaner to clean the photocells when necessary.



## Mirror Operation

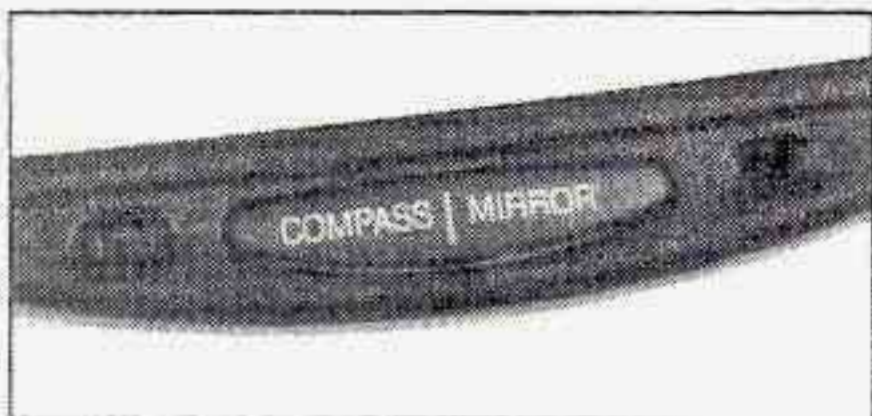

The right side of the switch located at the bottom of the mirror turns the electrochromic mirror on and off. To turn on the automatic dimming feature, press MIRROR. To turn off automatic dimming, press MIRROR again. The green indicator light will be illuminated when this feature is active.

## Compass Operation

Press the COMPASS switch once to turn the compass on or off.

When the ignition and the compass feature are on, the compass will show two character boxes for approximately two seconds. After two seconds, the mirror will display the compass heading.

If, after two seconds, the display does not show a compass heading ("N" for North, for example), there may be a strong magnetic field interfering with the compass. Such interference may be caused by a magnetic antenna mount, magnetic note pad holder or a similar magnetic item.

## Compass Variance

The mirror is set in zone eight upon leaving the factory. It will be necessary to adjust the compass to compensate for compass variance if you live outside zone eight. Under certain circumstances, as during a long distance cross-country trip, it will be necessary to adjust for compass variance. Compass variance is the difference between earth's magnetic north and true geographic north. If not adjusted to account for compass variance, your compass could give false readings.

To adjust for compass variance:

1. Press and hold the COMPASS button located at the bottom of the mirror until a zone number appears in the display.
2. Find your current location and variance zone number on the following zone map.

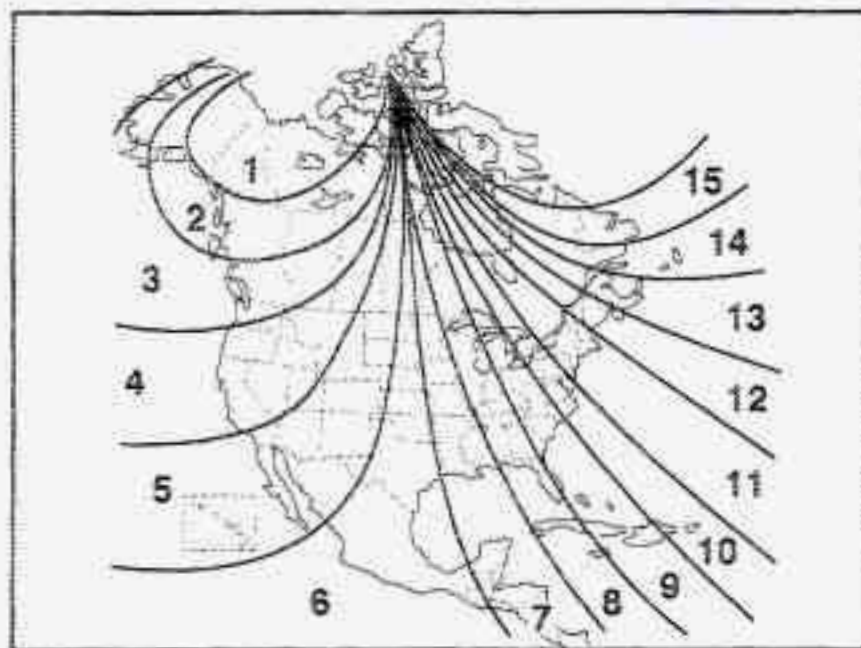

3. Press the COMPASS button on the bottom of the mirror until the new zone number appears in the display. After you stop pressing the button, the display will show a compass direction within a few seconds. (This is the automatic calibration mode. Drive in a circle to calibrate the mirror. See "Compass Calibration" following.)

### Compass Calibration

If the letter "C" should ever appear in the compass window, the mirror may need calibration.

The mirror can be calibrated in one of two ways:

- Drive the vehicle in circles at 5 mph (8 km/h) or less until the display reads a direction, or
- Drive the vehicle on your everyday routine.



## Power Remote Control Mirror

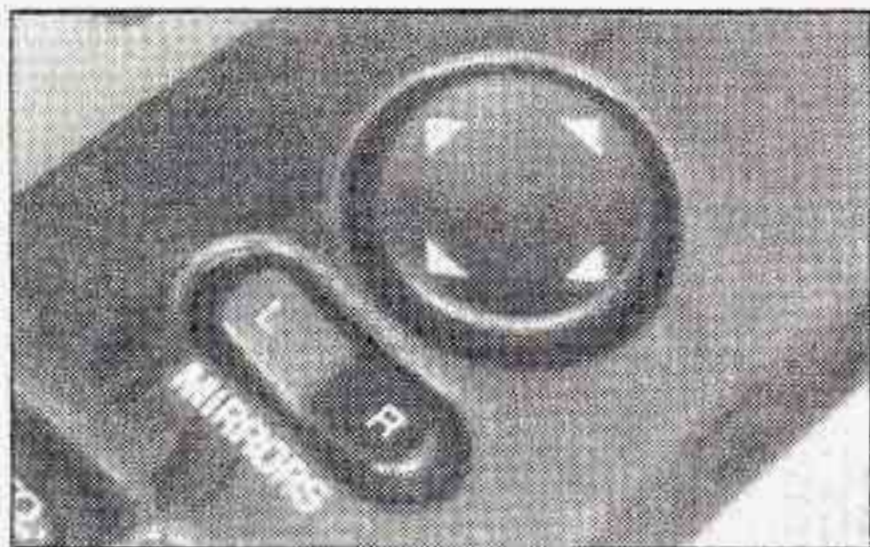

Your vehicle has an electric mirror control located on the driver's door armrest.

Move the switch below the control to choose the right or left mirror. If you place the switch in the center position, no movement of the mirror will occur. To adjust the mirror, push the arrow control in the direction you want the mirror to go.

Adjust each mirror so you can just see the side of your vehicle and the area behind your vehicle.

If your vehicle is equipped with the optional memory seat and mirrors feature, these mirror positions, along with the driver's seat position can be stored in memory. See "Memory Seat and Mirrors" in the Index.

## Parallel Park Assist Mirror (If Equipped)

If you have the optional DIC feature, the passenger's outside rearview mirror also includes a tilt-down feature that operates when the shift lever is in REVERSE (R). When the vehicle is shifted out of REVERSE (R), the passenger mirror will return to its original position after a five second delay. This delay prevents movement of the mirror if multiple gear transitions (reverse to drive to reverse) occur during a parallel parking maneuver. This feature can be programmed on or off through the Personal Choice selection menu. See "Driver Information Center" or "Personal Choice Features" in the Index for programming instructions. This feature assists the driver with improved rear obstacle detection.



## Convex Outside Mirror

Your passenger's side mirror is convex. A convex mirror's surface is curved so you can see more from the driver's seat.



### CAUTION:

**A convex mirror can make things (like other vehicles) look farther away than they really are. If you cut too sharply into the right lane, you could hit a vehicle on your right. Check your inside mirror or glance over your shoulder before changing lanes.**

## Automatic Dimming/Heated Outside Rearview Mirror (If Equipped)

If you have this option, the driver's side outside mirror will adjust for the glare of headlamps behind you. This feature is controlled by the on and off settings on the automatic electrochromic day/night rearview mirror. See "Automatic Electrochromic Day/Night Rearview Mirror" earlier in this section.

If you have this feature, the left and right outside mirrors are also heated when you activate the rear window defogger.

Both outside mirrors can be folded forward or rearward. In the rearward position, they will fold flush with the vehicle. This feature is particularly useful in automatic car washes.

## Storage Compartments

### Glove Box

The glove box is directly in front of the front passenger's seat. Use the door key to lock and unlock the glove box. To open the glove box, pull the handle upward until the latch opens.

## Installing a Garage Door Opener

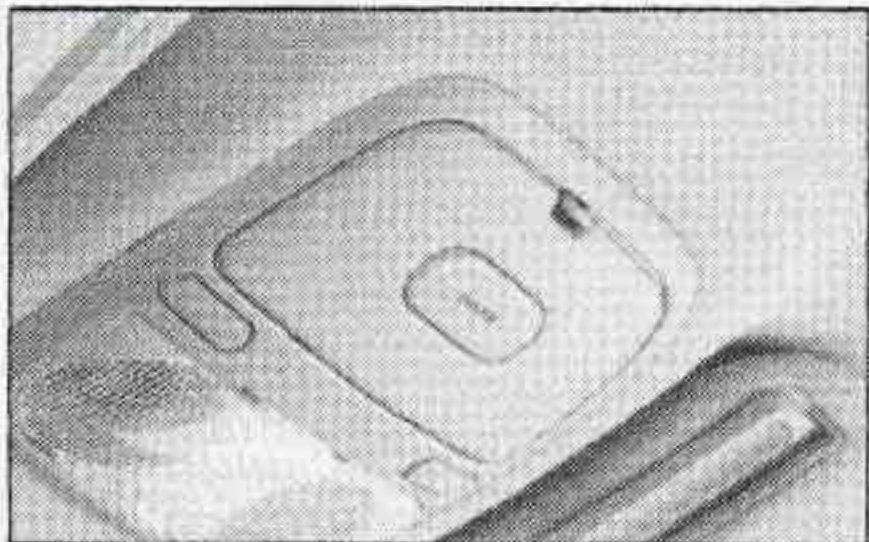

The garage door opener storage area is located in the headliner near the reading lamps. The following chart and instructions will help you install your garage door opener in the overhead storage area.

1. Push the extended tab (above the **GARAGE** button) or insert a screwdriver between the tab and outer edge of the cover. The garage door opener cover will flip down.

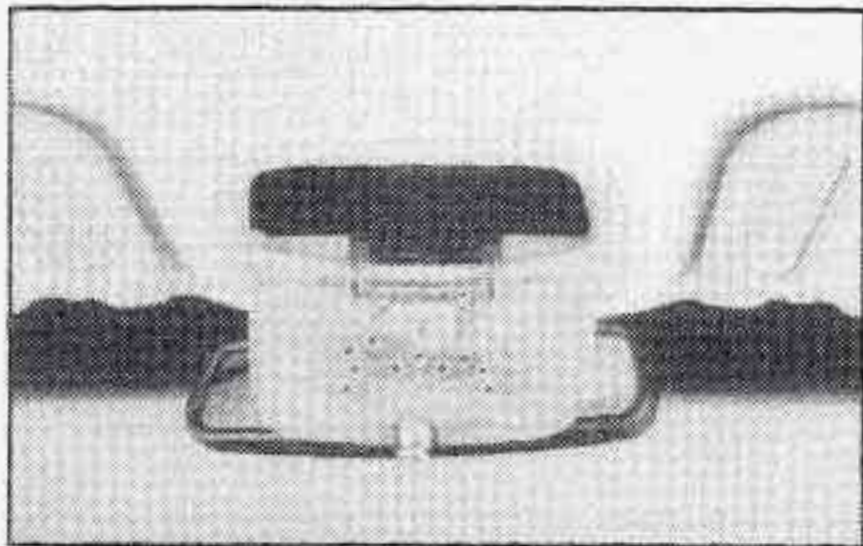

2. Remove the square height adapters from the cover. Refer to the chart to determine the number and location of the height adapters for your garage door opener. If your unit does not appear on the chart, you will have to try different adapter number and location combinations.

Your Garage Door Transmitter			Vehicle Console Door	
Name	Model	Button	Position For Adapter(s)	Number Of Adapter(s)
CHAMBERLAIN	G-3684	1	5	4
CRUSADER	1-BUTTON	1	9	3
GENIE	AT85P	1	3	3
GENIE	AT85	1	5	4
GENIE	AT90	1	5	4
GENIE	MAT85	1	6	4
GENIE	MAT90	1	6	4
GENIE	AT285P	1	10	3
		2	1	3
GENIE	AT95	1	10	3
		2	3	3
		3	1	3
LIFTMASTER	G3446	1	2	3
LIFTMASTER	G3456	1	2	3
LINEAR	DT2A	1	6	3
		2	6	3
LINEAR	D22A	1	4	3
LINEAR	EK-11/H	1	4	2
LINEAR	ET-2	1	6	4
LINEAR	D22B	1	6	3
		2	6	3

Your Garage Door Transmitter			Vehicle Console Door	
Name	Model	Button	Position For Adapter(s)	Number Of Adapter(s)
LINEAR	DT4	1	10	3
		2	8	3
		3	3	3
		4	1	3
LINEAR	D4B	1	10	3
		2	8	3
		3	3	3
		4	1	3
MICOM	ESP-T-9R	1	6	3
MICOM	ESP-T-6	1	6	3
MULTIELMAC	3010	1	6	3
MULTIELMAC	3088	1	4	3
MULTIELMAC	3070	1	6	4
MULTIELMAC	3032	1	6	3
		2	6	3
MULTIELMAC	1054	1	6	3
MULTIELMAC	3034	1	—	—
		2	6	3
		3	6	3
		4	—	—



Your Garage Door Transmitter			Vehicle Console Door	
Name	Model	Button	Position For Adapter(s)	Number Of Adapter(s)
MULTIELMAC	3033	1	—	—
		2	6	3
		3	6	3
		4	—	—
MULTIELMAC	1048	1	4	2
MULTIELMAC	1087	1	5	2
MULTIELMAC	3060	1	6	4
MULTIELMAC	1098	1	5	2
		2	7	2
OVERHEAD DOOR	1-BTN 223	1	1 OR 10	3
OVERHEAD DOOR	2-BTN 265	1	10	3
		2	1	3
OVERHEAD DOOR	3-BTN 242	1	10	3
		2	10	3
		3	1	3
OVERHEAD DOOR	4-BTN 232	1	10	3
		2	10	3
		3	1	3
		4	1	3
PULSAR	921	1	4	3
PULSAR	931	1	4	3

Your Garage Door Transmitter			Vehicle Console Door	
Name	Model	Button	Position For Adapter(s)	Number Of Adapter(s)
PULSAR	832	1	9	3
		2	3	3
PULSAR	833	1	9	3
		2	3	3
PULSAR	832C	1	4	3
		2	3	3
		3	1	3
PULSAR	833B	1	5	4
PULSAR	PDX-9921	1	4	3
SEARS	9B53738	1	6	4
SEARS	9B53708	1	2	2
SHIMA	RT-18	1	4	3
STANLEY	1047	1	5	3
STANLEY	1050	1	6	3
STANLEY	1076	1	6	3
		2	6	3
STANLEY	1079	1	6	3
		2	6	3
STANLEY	1075	1	6	3
		2	6	3
STANLEY	331-1052	1	6	4

- Place the height adapters on the proper peg using the suggested combinations or by lining up the height adapters and the transmitter button on your garage door opener.

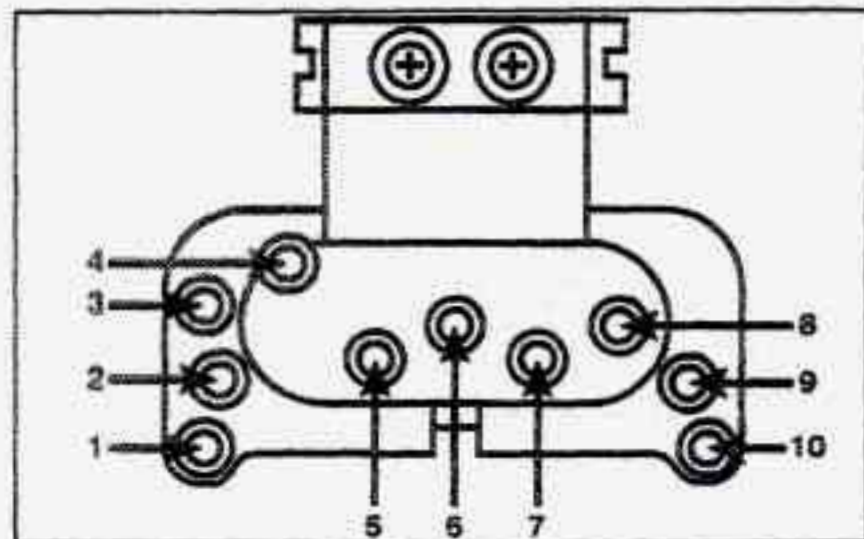

- Use the Velcro<sup>®</sup> found in the storage area and attach the garage door opener securely inside the console. Line up the transmitter button with the height adapters.
- Close the cover and test the GARAGE button.  
If your garage door opener doesn't work after it is installed, try another combination.

## Front Storage Armrest

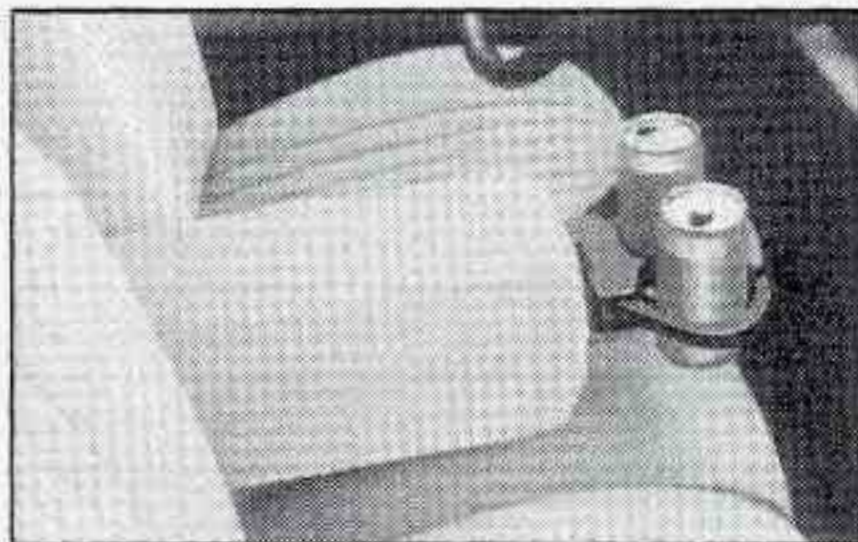

You may have a fold-down armrest between the front seats that opens into a storage area. To open it, pull up on the lever at the front edge. Inside are cupholders that can be rotated forward for use with the armrest cover closed. There is also a removable coinholder and a storage area for cassette tapes and compact discs.



### Front Center Console (Option)

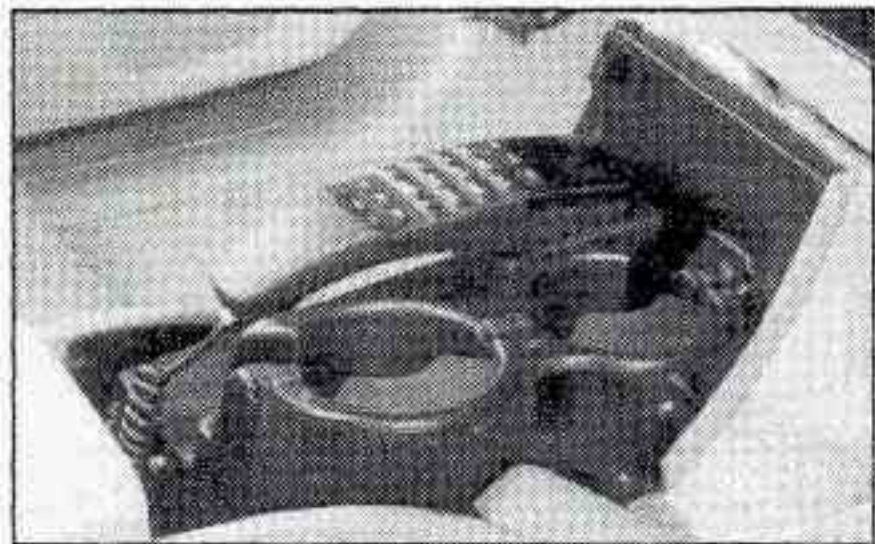

Your vehicle may have a center console that opens to two storage compartments. This console has two cupholders that can be unfolded for use. Flip the console forward to use the built-in writing surface on top of the lid.

You will also find an auxiliary power outlet located inside the storage compartment and one on the lower front edge of the console. These outlets can be used for accessories requiring electrical power, such as a cellular phone or fax machine. See "Auxiliary Power Outlets" in the Index.

The console also contains a removeable coinholder as well as storage for cassette tapes and compact discs.

### Rear Storage Armrest



Your vehicle's rear seat armrest may contain two cupholders. To access the cupholders, pull the armrest down from the rear seatback.

Some models may also include a storage area inside the armrest. To open it, pull up on the lever at the front edge of the armrest.



## Rear Seat Pass Through

Your vehicle is equipped with a rear storage armrest with a pass through feature that allows for trunk access. Pull the rear armrest down, then push down on the trunk access panel latch to open the panel. To close, push the access panel until it latches.

## Convenience Net

Your vehicle has a convenience net. You'll see it just inside the back wall of the trunk.

Put small loads, like grocery bags, behind the net. It can help keep them from falling over during sharp turns or quick starts and stops.

The net isn't for larger, heavier loads. Store them in the trunk as far forward as you can.

You can unhook the net so that it will lie flat when you're not using it.

## Ashtrays and Cigarette Lighter

### Front Ashtray

The front ashtray may be removed for cleaning. To remove, grasp the sides and pull forward.

### Rear Ashtray

The rear ashtrays are located on each rear door panel. To remove the rear ashtray, open the lid and ease the ashtray upward until the edge can be grasped to pull the ashtray up and out.

### **NOTICE:**

**Don't put papers or other flammable things into your ashtrays. Hot cigarettes or other smoking materials could ignite them, causing a damaging fire.**

## Cigarette Lighter

There are cigarette lighters near the front and rear ashtrays. To use one, push it in all the way and let go. When it's ready, it will pop back by itself.

### **NOTICE:**

**If you hold a cigarette lighter in with your hand while it is heating, it won't be able to back away from the heating element when it's ready. That can make it overheat, damaging the lighter and the heating element.**

## Sun Visors

### Illuminated Visor Vanity Mirror

Your vehicle has illuminated visor vanity mirrors. When you open the visor vanity mirror by pulling up, the lamps turn on.

The brightness of the lamps can be adjusted by sliding the switch. Your vehicle may also have visor vanity mirrors for the rear seat passengers.

To block out glare, swing down the visors. The larger sun visor can be removed from the center mount and moved to the side, while the auxiliary sun visor remains to block glare from the front.

The front side of the driver's sun visor also contains a pocket for map storage.

## Auxiliary Power Outlets

Your vehicle may have one or two power outlets depending on the type of front seat you have. If your front seat has a fold-down armrest, the power outlet is located in the center of the front seat below the cushion. If your vehicle has front bucket seats with a center console, you will find one outlet inside the storage compartment and the other on the lower front edge of the console.

These power outlets can be used to plug in electrical equipment such as a cellular telephone or CB radio. Follow the proper installation instructions that are included with the equipment you install.

## Garment Hooks

For your convenience, you will find a two-hanger capacity garment hook above each rear door near the reading lamps.

## Cellular Phone Readiness Package (Option)

If you have this option, your vehicle has been prewired for dealer installation of a GM portable phone. This system will have steering wheel controls for volume only and information output through the DIC. Voice activation and hands-free operation are standard features. For more information, contact your dealer. A user's guide will be provided with the telephone completion kit.

NOTE: Installation of aftermarket equipment is possible, however, the features described above will not be compatible with any portable phone other than the GM cellular available from your dealer.



## OnStar System (Option)

This system may be ordered if you have the optional fixed cellular telephone. The following services are available 24 hours a day:

- Roadside Service with Location
- Emergency Services Button
- Remote Door Unlock
- Theft Detection/Notification and Stolen-Vehicle Tracking
- Automatic Notification of Air Bag Deployment
- Concierge/Customer Conveniences Services

For more information, contact your dealer.

## AstrorooF (If Equipped)



If you have the express-open astrorooF option, the switch is on the roof between the sun visors. It will open the astrorooF when in retained accessory power or when the ignition is on.

The sunroof switch can be operated in four directions to control sunroof movement. To open the glass panel and sunshade, press the switch rearward and release. The astrorooF will open automatically to the full-open position. To stop the panel in a partially-open position, press the switch again at the desired point. To continue to open fully, press the switch rearward again and release. The sunshade can also be opened manually.

To close the glass panel, press and hold the switch forward. The sunshade must be manually closed.

Once the astroroof is closed, it can be opened to a vent position. Push the switch upward to vent. To close, pull the switch downward. The sunshade must be opened and closed manually for vent operation.

### Assist Straps

An assist strap over each rear door and the front passenger's door can be used to help you get in or out of your vehicle.

### Universal Transmitter (If Equipped)

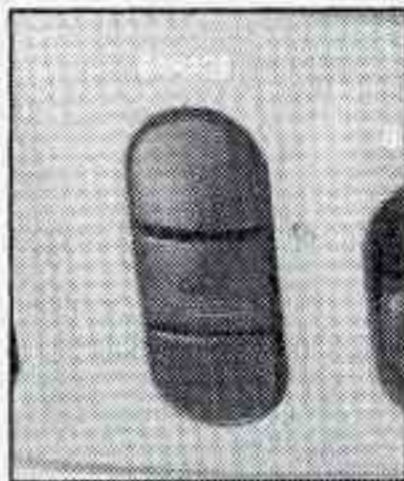

This transmitter allows you to consolidate the functions of up to three individual hand-held transmitters.

It will operate garage doors and gates, or other devices controlled by radio frequency such as home/office lighting systems.

The transmitter will learn and transmit the frequencies of most current transmitters and is powered by your vehicle's battery and charging system.

This device complies with Part 15 of the FCC Rules. Operation is subject to the following two conditions: (1) this device may not cause harmful interference, and (2) this device must accept any interference received, including interference that may cause undesired operation.

This device complies with RSS-210 of Industry Canada. Operation is subject to the following two conditions: (1) this device may not cause interference, and (2) this device must accept any interference, including interference that may cause undesired operation of the device.

Changes and modifications to this system by other than an authorized service facility could void authorization to use this equipment.

## Programming the Transmitter

Do not use the universal transmitter with any garage door opener that does not have the "stop and reverse" safety feature. This includes any garage door opener model manufactured before April 1, 1982.

*Be sure that people and objects are clear of the garage door you are programming!*

Your vehicle's engine should be turned off while programming your transmitter. Follow these steps to program up to three channels:

1. If you have previously programmed a universal transmitter channel, proceed to Step 2. Otherwise, hold down the two outside buttons on the universal transmitter until the red light begins to flash rapidly (approximately 20 seconds). Then release the buttons. This procedure initializes the memory and erases any previous settings for all three channels.
2. Hold the end of your hand-held transmitter against the bottom surface of the universal transmitter so that you can still see the red light.



3. Decide which one of the three channels you want to program. Using both hands, press the hand-held transmitter button and the desired button on the universal transmitter. Continue to hold both buttons through Step 4.
4. Hold down both buttons until you see the red light on the universal transmitter first flash slowly, then rapidly. The rapid flashing, which could take up to 90 seconds, indicates that the universal transmitter has been programmed. Release both buttons once the light starts to flash rapidly.

If you have trouble programming the universal transmitter, make sure that you have followed the directions exactly as described and that the batteries in the hand-held transmitter are not dead. If you still cannot program it, rotate your hand-held transmitter end over end and try again. The universal transmitter may not be compatible with a limited number of older installations due to legislated changes in transmission frequencies. If you cannot program the transmitter after repeated attempts, consult your dealer.

Be sure to keep your original hand-held transmitter in case you need to erase and reprogram the universal transmitter.

**Note to Canadian Owners:** During programming, your hand-held transmitter may stop transmitting after one or two seconds. If you are programming from one of these transmitters, you should press and re-press the button on the hand-held transmitter every two seconds without ever releasing the button on the universal transmitter. Release both buttons when the red light on the universal transmitter begins to flash rapidly.

### Operating the Transmitter

Press and hold the appropriate button on the universal transmitter. The red light comes on while the signal is being transmitted.

Note that the effective transmission range of the universal transmitter may differ from your hand-held transmitter and from one channel to another.

### Training a Garage Door Opener Equipped with "Rolling Codes"

If you programmed the universal transmitter, but the garage door will not open, and if your garage door opener was manufactured after 1995, your garage door may have a security feature that changes the "code" of your garage door opener every time it is opened or closed.

To determine if your garage door opener has this rolling code feature, press and hold the appropriate button on the universal transmitter that was programmed. If the red light flashes rapidly for one to two seconds, then turns solid, your garage door opener has this feature.

To program a garage door opener with the rolling code feature, do the following:

1. Program your hand-held transmitter to the universal transmitter by following the steps provided under "Programming the Transmitter" earlier.
2. Locate the training button on the garage door opener receiver. The exact location and color will vary among brands. Refer to your garage door opener manufacturer's owner's manual to locate the training button.
3. Press the training button on the garage door opener receiver for one to two seconds.
4. Return to your vehicle and press the programmed button on the universal transmitter until the red light flashes rapidly (about two seconds).
5. Release the button, then press it again to confirm it was programmed to the garage door opener receiver.

You may now use either the universal transmitter or the hand-held transmitter to open your garage door. If you still have difficulty in programming and require assistance, please call your dealer.

### Erasing Channels

To erase all three programmed channels, hold down the two outside buttons until the red light begins to flash. Individual channels cannot be erased, but can be reprogrammed using the procedure for programming the transmitter explained earlier.

### Accessories

Accessories for your universal transmitter are available from the manufacturer of the unit. If you would like additional information, please call 1-800-355-3515.

## Instrument Panel

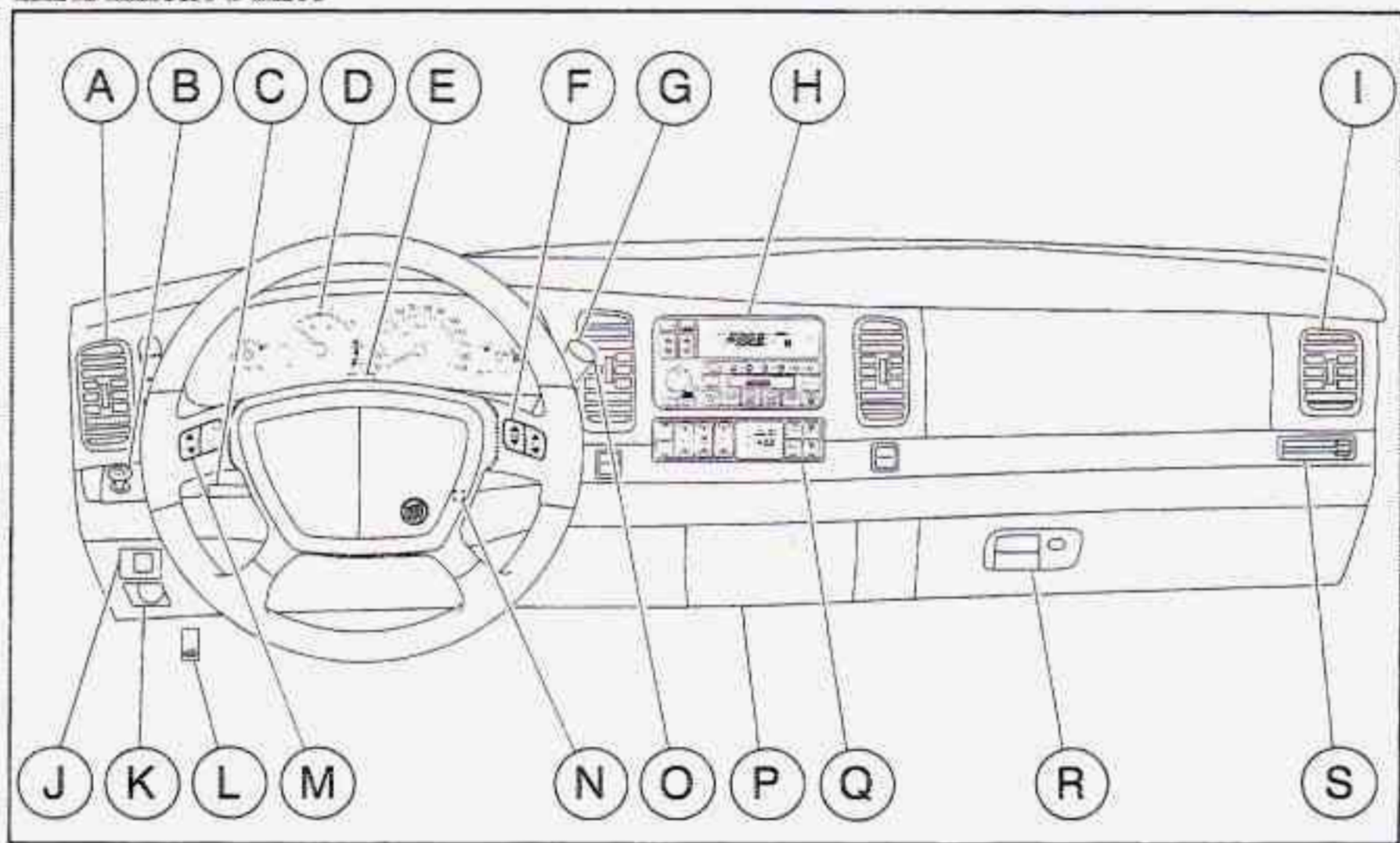



- A. Air Outlet
- B. Headlamps/Parking Lamps Switch
- C. Turn Signal/Multifunction Lever
- D. Instrument Cluster/Gages
- E. Hazard Warning Flasher Switch
- F. Climate Control System Steering Wheel Controls
- G. Gearshift Lever
- H. Audio System
- I. Air Outlet
- J. Fuel Button
- K. Trunk Release and Lockout Button
- L. Hood Release
- M. Audio System Steering Wheel Controls
- N. Ignition Switch
- O. Traction Control Switch
- P. Ashtray and Cigarette Lighter
- Q. Climate Control System
- R. Glove Box
- S. Passenger Climate Control

## Instrument Panel Cluster

Your vehicle is equipped with one of the following instrument panel clusters. It includes indicator warning lights and gages that are explained on the following pages. Be sure to read about those that apply to the instrument cluster for your vehicle.

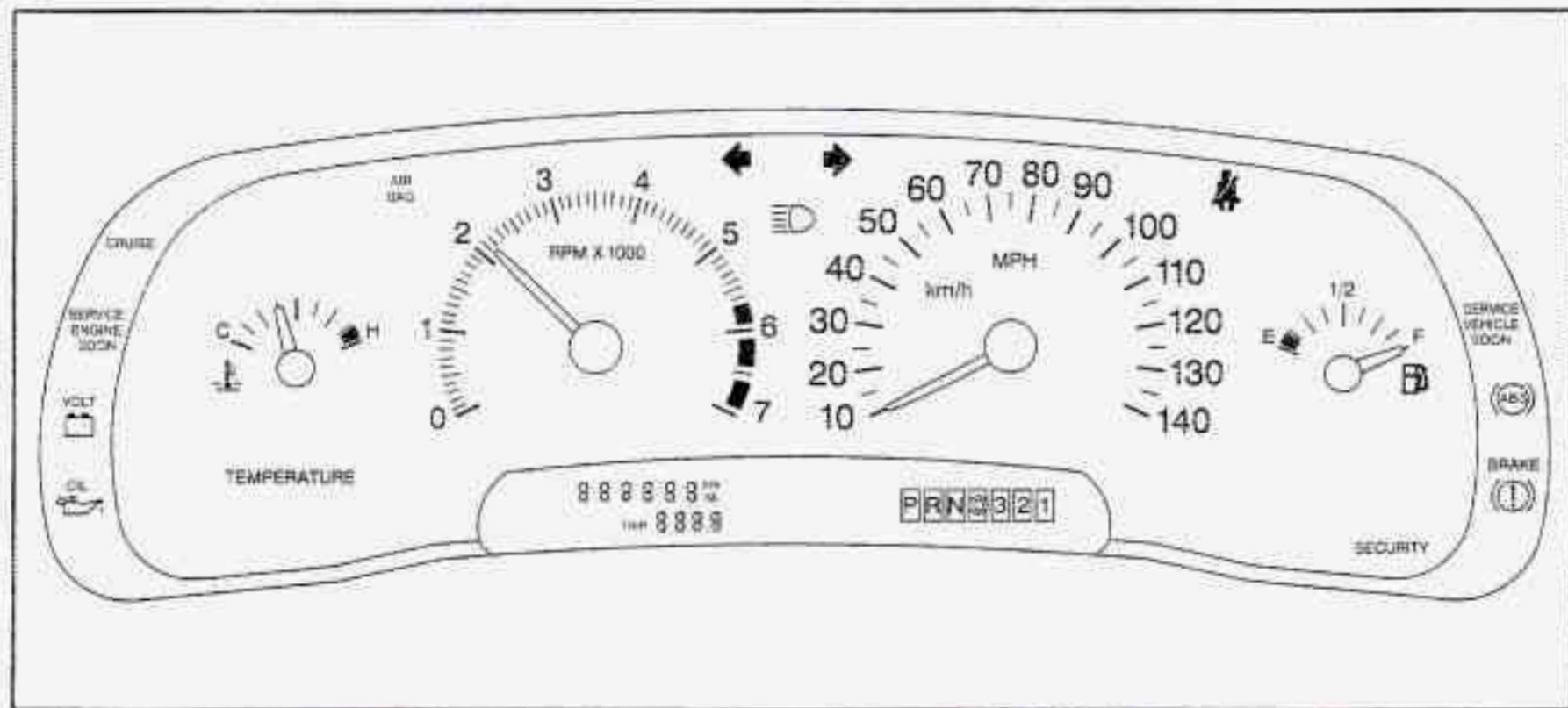

**Standard Cluster (United States version shown, Canada similar)**

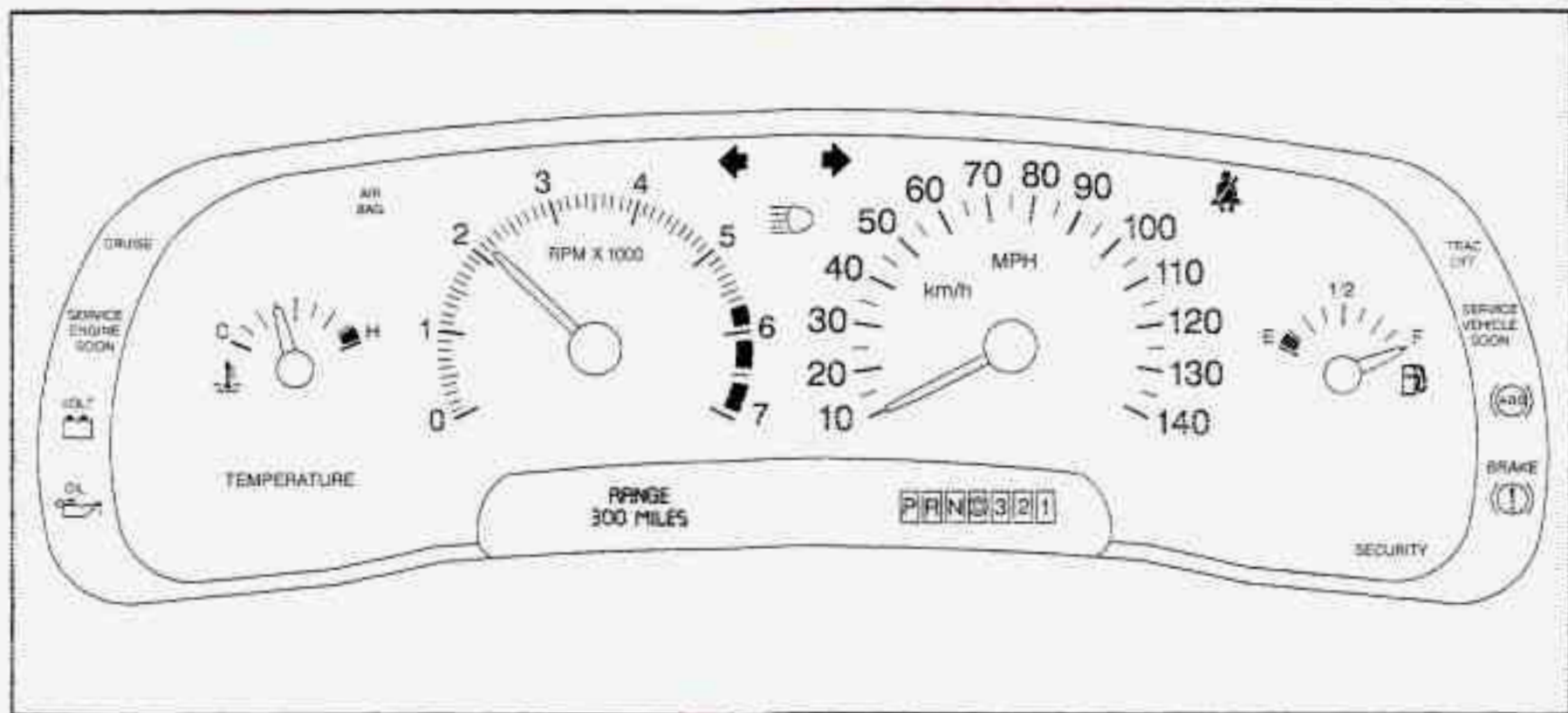

**Cluster With DIC (United States version shown, Canada similar)**



## Speedometer and Odometer

Your speedometer lets you see your speed in both miles per hour (mph) and kilometers per hour (km/h). Your odometer shows how far your vehicle has been driven, in either miles (used in the United States) or kilometers (used in Canada).

Your vehicle has a tamper-resistant odometer. You may wonder what happens if your vehicle needs a new odometer installed. If possible, the new one has to be set to the same reading the old one had. If it can't be, then it's set at zero and a label must be put on the driver's door to show the old mileage reading and when the new odometer was installed.

### Trip Odometer

A trip odometer can tell how far you've driven since you last set it back to zero. To reset it, push the RESET button. The trip odometer is reset through the DIC if your vehicle is equipped with this feature.

## Tachometer



The tachometer tells you how fast the engine is running. It displays engine speed in thousands of revolutions per minute (rpm).

### **NOTICE:**

**Do not operate the engine with the tachometer in the red area, or engine damage may occur.**

## Warning Lights, Gages and Indicators

This part describes the warning lights and gages that may be on your vehicle. The pictures will help you locate them.

Warning lights and gages can signal that something is wrong before it becomes serious enough to cause an expensive repair or replacement. Paying attention to your warning lights and gages could also save you or others from injury.

Warning lights come on when there may be or is a problem with one of your vehicle's functions. As you will see in the details on the next few pages, some warning lights come on briefly when you start the engine just to let you know they're working. If you are familiar with this section, you should not be alarmed when this happens.

Gages can indicate when there may be or is a problem with one of your vehicle's functions. Often gages and warning lights work together to let you know when there's a problem with your vehicle.

When one of the warning lights comes on and stays on when you are driving, or when one of the gages shows there may be a problem, check the section that tells you what to do about it. Please follow this manual's advice. Waiting to do repairs can be costly -- and even dangerous. So please get to know your warning lights and gages. They're a big help.

Your vehicle may also have a driver information system that works along with the warning lights and gages. See "Driver Information System" in the Index.

### Safety Belt Reminder Light

When the key is turned to RUN or START, a chime will come on for about eight seconds to remind people to fasten their safety belts, unless the driver's safety belt is already buckled.



The safety belt light will also come on and stay on for about 20 seconds, then it will flash for about 55 seconds. If the driver's belt is already buckled, neither the chime nor the light will come on.

## Air Bag Readiness Light

There is an air bag readiness light on the instrument panel, which shows AIR BAG. The system checks the air bag's electrical system for malfunctions. The light tells you if there is an electrical problem. The system check includes the air bag sensors, the air bag modules, the wiring and the crash sensing and diagnostic module. For more information on the air bag system, see "Air Bag" in the Index.



This light will come on when you start your engine, and it will flash for a few seconds. Then the light should go out. This means the system is ready.

If the air bag readiness light stays on after you start the engine or comes on when you are driving, your air bag system may not work properly. Have your vehicle serviced right away.

The air bag readiness light should flash for a few seconds when you turn the ignition key to RUN. If the light doesn't come on then, have it fixed so it will be ready to warn you if there is a problem.

## Battery Warning Light

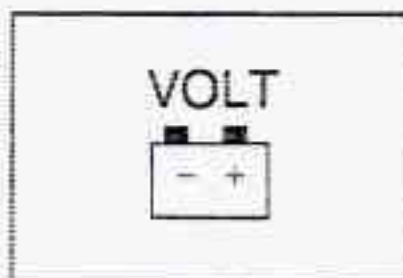

When you turn the key to RUN, this light will come on briefly, to show the battery charging system is working.

When the light goes off and stays off, the charging system is working.

If the light stays on, a chime will sound indicating you need service, and you should take your vehicle to the dealer at once. To save your battery until you get there, turn off all accessories and turn off your climate control system.

When a large number of electrical accessories are operating in the vehicle and the engine is left at an idle for an extended period, the engine may idle at a higher RPM than normal to ensure the battery does not run down. This may occur when several of the following are on: parking lamps, high-beam headlamps, rear window defogger, heated seats and engine cooling fans, etc. It may take longer for the rear window defogger to clear the glass, and the heated seats may not feel as warm as normal.



## Brake System Warning Light

Your vehicle's hydraulic brake system is divided into two parts. If one part isn't working, the other part can still work and stop you. For good braking, though, you need both parts working well.

If the warning light comes on, there could be a brake problem. Have your brake system inspected right away.



This light should come on when you turn the key to RUN. If it doesn't come on then, have it fixed so it will be ready to warn you if there's a problem.

If the light and chime come on while you are driving, pull off the road and stop carefully. You may notice that the pedal is harder to push. Or, the pedal may go closer to the floor. It may take longer to stop. If the light is still on, have the vehicle towed for service. (See "Towing Your Vehicle" in the Index.)

## CAUTION:

**Your brake system may not be working properly if the brake system warning light is on. Driving with the brake system warning light on can lead to an accident. If the light is still on after you've pulled off the road and stopped carefully, have the vehicle towed for service.**

When the ignition is on, the brake system warning light will also come on when you set your parking brake. The light will stay on if your parking brake doesn't release fully. If you try to drive off with the parking brake set, a chime will also come on until you release the parking brake. If the light and chime stay on after your parking brake is fully released, it means you have a brake problem.

## Anti-Lock Brake System Warning Light



With the anti-lock brake system, the light(s) will come on when you start your engine and may stay on for several seconds. That's normal.

If the light stays on and the chime sounds, turn the ignition to OFF. Or, if the light comes on and the chime sounds when you're driving, stop as soon as possible and turn the ignition off. Then start the engine again to reset the system. If the light still stays on and the chime sounds, or the light comes on again while you're driving, your vehicle needs service. If the regular brake system warning light isn't on, you still have brakes, but you don't have anti-lock brakes. If the regular brake system warning light is also on, you don't have anti-lock brakes and there's a problem with your regular brakes. See "Brake System Warning Light" earlier in this section.

The anti-lock brake system warning light should come on briefly when you turn the ignition key to RUN. If the light doesn't come on then, have it fixed so it will be ready to warn you if there is a problem.

## Traction Control System Warning Light (If Equipped)



This warning light should come on briefly as you start the engine. If the warning light doesn't come on then, have it fixed so it will be ready to warn you if there's a problem.

If it stays on, or comes on when you're driving, there may be a problem with your traction control system and your vehicle may need service. When this warning light is on, the system will not limit wheel spin. Adjust your driving accordingly.

The traction control system warning light may come on for the following reasons:

- If you turn the system off by pressing the button located on the end of the shift lever, the warning light will come on and stay on. To turn the system back on, press the button again. The warning light should go off. (See "Traction Control System" in the Index for more information.)



- If there's a brake system problem that is specifically related to traction control, the traction control system will turn off, the warning light will come on and the chime will sound.
- If the traction control system is affected by an engine-related problem, the system will turn off, the warning light will come on and the chime will sound.

If the traction control system warning light comes on and stays on for an extended period of time when the system is turned on, your vehicle needs service.

### Engine Coolant Temperature Gage

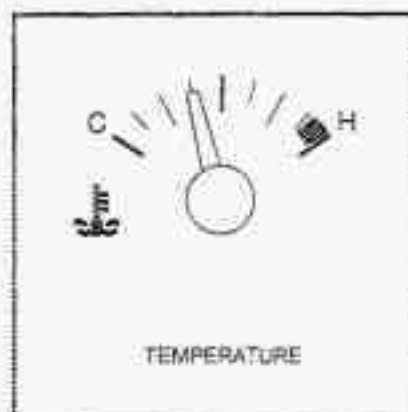

This gage measures the temperature of your engine. If the pointer moves into the red area, your engine is too hot. A temperature indicator light will turn on and a chime will sound.

If you have been operating your vehicle under normal driving conditions, and the temperature indicator light turns on, you should pull off the road, stop your vehicle and turn off the engine as soon as possible.

The section "Problems on the Road," in this manual explains what to do. See "Engine Overheating" in the Index.

### Malfunction Indicator Lamp (Service Engine Soon Light)



Your vehicle is equipped with a computer which monitors operation of the fuel, ignition and emission control systems.

This system is called OBD II (On-Board Diagnostics-Second Generation) and is intended to assure that emissions are at acceptable levels for the life of the vehicle, helping to produce a cleaner environment. The SERVICE ENGINE SOON light comes on and a chime will sound to indicate that there is a problem and service is required. Malfunctions often will be indicated by the system before any problem is apparent. This may prevent more serious damage to your vehicle. This system is also designed to assist your service technician in correctly diagnosing any malfunction.



## NOTICE:

If you keep driving your vehicle with this light on, after a while, your emission controls may not work as well, your fuel economy may not be as good and your engine may not run as smoothly. This could lead to costly repairs that may not be covered by your warranty.

This light should come on, as a check to show you it is working, when the ignition is on and the engine is not running. If the light doesn't come on, have it repaired. This light will also come on during a malfunction in one of two ways:

- **Light Flashing** -- A misfire condition has been detected. A misfire increases vehicle emissions and may damage the emission control system on your vehicle. Dealer or qualified service center diagnosis and service may be required.
- **Light On Steady** -- An emission control system malfunction has been detected on your vehicle. Dealer or qualified service center diagnosis and service may be required.

### If the Light Is Flashing

The following may prevent more serious damage to your vehicle:

- Reducing vehicle speed.
- Avoiding hard accelerations.
- Avoiding steep uphill grades.
- If you are towing a trailer, reduce the amount of cargo being hauled as soon as it is possible.

If the light stops flashing and remains on steady, see "If the Light Is On Steady" following.

If the light continues to flash, when it is safe to do so, *stop the vehicle*. Find a safe place to park your vehicle. Turn the key off, wait at least 10 seconds and restart the engine. If the light remains on steady, see "If the Light Is On Steady" following. If the light is still flashing, follow the previous steps, and drive the vehicle to your dealer or qualified service center for service.

### *If the Light Is On Steady*

You may be able to correct the emission system malfunction by considering the following:

Did you recently put fuel into your vehicle?

If so, reinstall the fuel cap, making sure to fully install the cap. The diagnostic system can determine if the fuel cap has been left off or improperly installed. A loose or missing fuel cap will allow fuel to evaporate into the atmosphere. A few driving trips with the cap properly installed should turn the light off.

Did you just drive through a deep puddle of water?

If so, your electrical system may be wet. The condition will usually be corrected when the electrical system dries out. A few driving trips should turn the light off.

Have you recently changed brands of fuel?

If so, be sure to fuel your vehicle with quality fuel (see "Fuel" in the Index). Poor fuel quality will cause your engine not to run as efficiently as designed. You may notice this as stalling after start-up, stalling when you put the vehicle into gear, misfiring, hesitation on acceleration or stumbling on acceleration. (These conditions may go away once the engine is warmed up.) This will be detected by the system and cause the light to turn on.

If you experience one or more of these conditions, change the fuel brand you use. It will require at least one full tank of the proper fuel to turn the light off.

If none of the above steps have made the light turn off, have your dealer or qualified service center check the vehicle. Your dealer has the proper test equipment and diagnostic tools to fix any mechanical or electrical problems that may have developed.

## Oil Pressure Light



This light tells you if there could be a problem with your engine oil pressure.

The oil pressure light can come on briefly when you turn your key to RUN. It goes off once you turn the key to START. That's just a check to be sure the light works. This is normal and doesn't show a problem. If it doesn't come on and then go off, be sure to have it fixed so it will be there to warn you if something goes wrong.

When this light *comes* on and *stays* on, and a chime sounds, it means oil isn't going through your engine properly. You could be low on oil, or you might have some other oil problem. See your dealer for service.

### CAUTION:

**Don't keep driving if the oil pressure is low. If you do, your engine can become so hot that it catches fire. You or others could be burned. Check your oil as soon as possible and have your vehicle serviced.**

### NOTICE:

**Damage to your engine from neglected oil problems can be costly and is not covered by your warranty.**



## Service Vehicle Soon Light

**SERVICE  
VEHICLE  
SOON**

This light will come on if you have certain non-emission related vehicle problems.

These problems may not be obvious and may affect vehicle performance or durability. Consult a qualified dealership for necessary repairs to maintain top vehicle performance. The light will come on briefly when your ignition is turned on to show that it is working properly.

## Fuel Gage



Your fuel gage shows about how much fuel is in your tank.

It works only when the ignition is on. When the indicator moves to the edge of the low fuel warning band, the low fuel light will turn on and a chime will sound. You still have a little fuel left, but you need to get more fuel right away.

A concern owners have had about the fuel gage is that it takes more (or less) gas to fill up than the gage indicated. For example, the gage may have indicated half full, but it took more (or less) than half of the tank's capacity to fill it. This situation is normal and indicates nothing wrong with the fuel gage.

## Head-Up Display (HUD) (If Equipped)

### CAUTION:

If the HUD image is too bright, or too high in your field of view, it may take you more time to see things you need to see when it's dark outside. Be sure to keep the HUD image dim and placed low in your field of view.

If your vehicle is equipped with the Head-Up Display (HUD), you can see some of the driver information that appears on your instrument cluster.

The information may be displayed in English or metric units and appears as a reflection in the windshield. The HUD consists of the following information:

- Speedometer Reading
- Turn Signal Indicators
- High-Beam Headlamp Indicator
- Check Gages Message

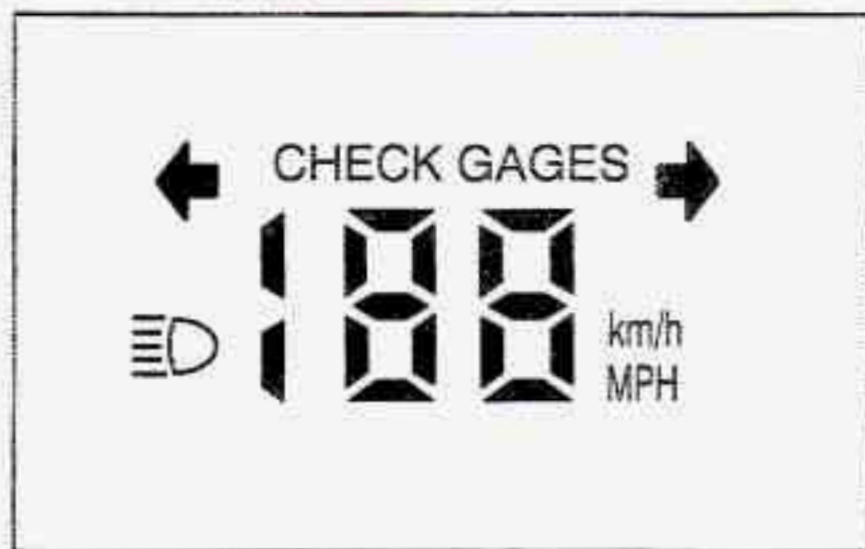

The HUD shows these images when they are lighted on the instrument panel cluster.

Be sure to continue scanning your displays, controls and driving environment just as you would in a vehicle without HUD. If you never look at your instrument panel, you may not see something important, such as a warning light.

## NOTICE:

Although the HUD image appears to be near the front of the vehicle, do not use it as a parking aid. The HUD was not designed for that purpose. If you try to use the display as a marker for the front of your vehicle, such as in a parking lot, you may misjudge distance and hit an obstacle or another vehicle.



The HUD controls are located in the overhead console.

1. Start your engine and slide the HUD dimmer control all the way up.

The brightness of the HUD image is determined by whether the headlamps are on or off, and where you have the HUD dimmer control set.

2. Adjust the seat to your driving position. Slide the image height adjuster control all the way up, raising the image as far as possible.
3. Now slide the image height adjuster control down so the image is as low as possible but still in full view.
4. Slide the dimmer control downward until the HUD image is no brighter than necessary.

To turn the HUD display off, slide the dimmer control all the way down.

If the sun comes out, the sky becomes cloudy, or if you turn your headlamps on, you may need to adjust the HUD brightness using the dimmer control. Polarized sunglasses could make the HUD image harder to see.



To change the display from English to metric units, push the ENG/MET button located to the left of the steering column.

Clean the inside of the windshield as necessary to remove any dirt or film that reduces the sharpness or clarity of the HUD image.

To clean the HUD lens, spray household glass cleaner on a soft, clean cloth. Gently wipe and dry the HUD lens. Do not spray cleaner directly on the lens to avoid cleaner leaking inside the unit.

If the ignition is on and you can't see the HUD image, check to see if:

- The headlamps are on.
- Something is covering the HUD unit.
- The HUD dimmer control is adjusted properly.
- The HUD image is adjusted to the proper height.
- A fuse is blown. See "Fuses and Circuit Breakers" in the Index.

Keep in mind that your windshield is part of the HUD system. If you ever have to have your windshield replaced, be sure to get one that is designed for HUD or your HUD image may look blurred or out of focus.

## Driver Information Center (DIC) (If Equipped)

Your vehicle may be equipped with a Driver Information Center (DIC). The DIC will display information about how your vehicle is functioning, as well as warning messages if a system problem is detected.

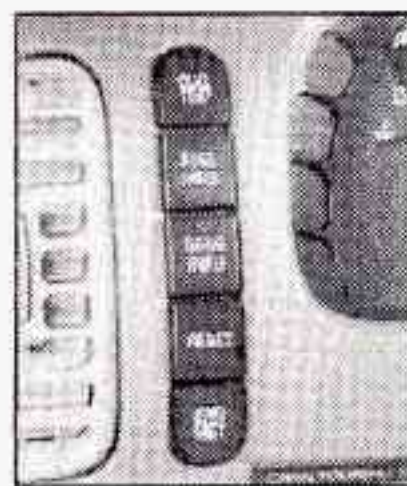

The following buttons are on the DIC control panel which is located to the left of the steering column:

- **ODO/TRIP:** Use this button to display your total and trip miles.

- **FUEL INFO:** Press this button to display fuel information such as, fuel used, fuel range and fuel economy.
- **GAGE INFO:** Use this button to display oil pressure, oil life, coolant temperature, tire pressure and battery information.
- **RESET:** This button, used along with other buttons, will reset system functions.
- **ENG/MET:** Use this button to change the display between English and metric units.

### Personal Choice DIC Display

This feature allows two different drivers to store and recall their own preferred display mode. The personal choice settings displayed on the DIC are determined by the transmitter used to enter the vehicle. After the UNLOCK button of a remote keyless entry transmitter is pressed and the ignition is in RUN, the DIC will display the identified driver. The settings can also be changed by briefly pressing one of the MEMORY buttons located on the driver's door.

The DIC can also be used to program the following personal choice features available with your vehicle:

- Memory Seats
- Memory Door Locks
- Security Feedback
- Delayed Locking
- Perimeter Lighting
- Parallel Park Assist Mirror
- Window Lockout

See "Personal Choice Features" in the Index and "DIC Personal Choice Programming" later in this part. The DIC is used to program information for DRIVER #1 and DRIVER #2. The DIC will identify a person as UNKNOWN DRIVER if they are neither DRIVER #1 nor DRIVER #2.

## Driver Information Center Controls and Displays

There are two lines in the DIC display. The bottom line on the display area is left blank when the DIC displays the driver number identified when entering the vehicle. You can have your dealer program your name to appear on this display line. See your dealer for more information.

When you turn the ignition on, the DIC will display your DRIVER NUMBER. The system will then perform a status check and display any messages if a problem is detected.

If there are no problems detected, the display will return to the mode selected by that driver the last time the ignition was turned off.

If a problem is detected, a diagnostic message will appear in the display. The following pages will show the messages you may see on the DIC display.

The message center is continuously updated with the vehicle's performance status.

## ODO/TRIP

When this button is pressed, the display will show the total mileage, and Trip 1 or Trip 2 miles. Trip 1 and Trip 2 will display the miles traveled since the last reset. To reset the trip odometer, press the ODO/TRIP button until the trip miles are shown in the DIC display, then press the RESET button. The trip odometer will now accumulate miles until the next reset.

## FUEL INFO

**Average Fuel Economy:** Press the FUEL button until the display shows FUEL ECONOMY AVERAGE. Average fuel economy is viewed as a long term approximation of your overall driving conditions. To learn the average fuel economy from a new starting point, press the RESET button while the average fuel economy is displayed in the DIC.

**Instantaneous Fuel Economy:** Press the FUEL button until the display shows FUEL ECONOMY INST. Instantaneous fuel economy varies with your driving conditions, such as acceleration, braking and the grade of the road being traveled. The RESET button does not function in this mode.



**Fuel Range:** Press the FUEL button until the display shows FUEL RANGE. The fuel range will calculate the remaining distance you can drive without refueling. This calculation is based on the average fuel economy for the last 25 miles (40.25 km) driven, and the fuel remaining in the fuel tank. The RESET button does not function in this mode.

**Fuel Used:** Press the FUEL button until the display shows FUEL USED. This display will show you how much fuel has been used since the last reset. To learn how much fuel is used from a new starting point, press the RESET button while the fuel used is displayed in the DIC.

## GAGES

**Oil Pressure:** Press the GAGES button until OIL PRESSURE appears in the display. If there are no problems detected with the oil pressure, the display will show OIL PRESSURE NORMAL. If a low oil pressure condition is detected, the display will show OIL PRESSURE LOW. If you see the OIL PRESSURE LOW message, you could be low on oil or your oil is not going through the engine properly. See your dealer for service.

**Coolant Temperature:** Press the GAGES button until COOLANT TEMP appears in the display. If there are no problems detected with the temperature, COOLANT TEMP NORMAL will appear in the display. If the temperature is too high, COOLANT TEMP HOT will appear in the display. If you see the COOLANT TEMP HOT message, your engine is overheated. You should pull off the road, stop your vehicle and turn off your engine as soon as possible. This manual explains what to do. See "Engine Overheating" in the Index.

**Battery Volts:** Press the GAGES button until the display shows BATTERY STATE. If the voltage is normal the display will show BATTERY STATE NORMAL. If the voltage drops below 10.5 volts, the display will show BATTERY STATE LOW. If the voltage is above 16 volts, the display will show BATTERY STATE HIGH. If the display shows the high or low message, you need to have your battery checked.

**Oil Life Monitor (Index):** Press the GAGES button until OIL LIFE INDEX appears in the display. The OIL LIFE INDEX NORMAL display will show an estimate of the oil's remaining useful life. When the oil life index is less than 10%, the display will show OIL LIFE INDEX CHANGE OIL. When you have the oil changed according to the maintenance schedule (see "Maintenance Schedule" in the Index), you will have to reset the oil life monitor. To do this, press and hold the RESET button for more than five seconds while the oil life index is being displayed on the DIC. The oil life will change to 100%.

**Tire Pressure Status:** Press the GAGES button until TIRE PRESSURE appears in the display. TIRE PRESSURE NORMAL is displayed when the Check Tire Pressure System believes your vehicle's tire pressures are normal. If a potential tire pressure problem is detected, the display will show TIRE PRESSURE LOW: CHECK TIRES. If you see the TIRE PRESSURE LOW: CHECK TIRES message, you should stop as soon as you can and check all your tires for damage. (If a tire is flat, see "If a Tire Goes Flat" in the Index.) Also check the tire pressure in all four tires as soon as you can. See "Inflation - Tire Pressure" and "Check Tire Pressure System" in the Index.

There are times when you will have to reset (calibrate) the Check Tire Pressure System. See "Check Tire Pressure System" in the Index.

#### *DIC Warnings and Messages*

Other messages or warnings may appear in the DIC display such as:

- WINDSHIELD WASHER FLUID LOW
- ENG COOLANT LOW - CHECK LEVEL
- ENGINE OIL LOW - CHECK LEVEL
- CHANGE ENGINE OIL SOON
- TRACTION CONTROL SYSTEM ACTIVE
- DOOR AJAR
- TRUNK AJAR

Pressing any of the DIC control buttons will remove the above messages or warnings from the DIC display.

## Driver Information Center Personal Choice Programming

The DIC can be used to program the following personal choice features available with your vehicle:

- Memory Seats
- Memory Door Locks
- Security Feedback
- Delayed Locking
- Perimeter Lighting
- Parallel Park Assist Mirror
- Window Lockout

See "Personal Choice Features" in the Index.

The DIC is used to program the personal choices of two drivers. The driver's are recognized by DRIVER #1 and DRIVER #2. You will let the DIC know which driver you are by using your remote keyless entry transmitter or by pressing the appropriate memory seat control button located on the driver's door. The remote transmitter was pre-programmed to belong to DRIVER #1 or DRIVER #2.

The last driver number remembered by the DIC will show on the display each time the UNLOCK button on the same transmitter is pressed, and the ignition is turned on.

When you press UNLOCK on your transmitter, the DIC will automatically change driver numbers and the vehicle will recall the personal choice settings that were last made to correspond to your transmitter.

If you unlock the vehicle using your door key instead of your transmitter, the DIC will not change drivers and will recall the information from the last transmitter use or the last driver change using the memory seat controls. If this happens and you were not the last driver of the vehicle, simply press your correct driver number on the memory seat controls or press the UNLOCK button on your transmitter.



See the following steps for personal choice programming instructions.

1. Turn the ignition on and keep the transaxle in PARK (P).
2. Inform the DIC which driver you are by pressing the UNLOCK button on your transmitter or the appropriate memory seat control.
3. Press and hold the ENG/MET button for five seconds. WELCOME TO BUICK OPTION FEATURE will appear in the display.

The next display will be your driver number. You are now in the selection mode and the DIC is ready to program your personal choices in memory.

4. Use the ENG/MET button to select options. Use the RESET button to save the selection and advance to the next option.

Each feature that can be personalized will appear in the display. Once you have made a selection for a feature, the DIC will move on to the next personal choice feature.

If you would like to exit the selection mode without moving through each of the personal choice features, simply press a different button on the DIC or turn off the ignition. Whatever personal choices you made will still be retained, even without passing through each of the features.

If you happen to move past a selection you would like to make a personal choice for, press UNLOCK on your transmitter or press the appropriate driver number on the seat control. This will return you to the beginning of the option feature programming mode.

#### Parallel Park Assist

The parallel park assist mirror, which tips the passenger mirror while the vehicle is in REVERSE (R), can be made active or inactive through the DIC. When PARALLEL PARK-OFF-ON appears on the display, use the ENG/MET button to toggle the arrow between OFF and ON. When you have made your choice, press the RESET button to record your selection. For more information on this feature, see "Mirrors" in the Index.

## Memory Door Locks

The memory door lock modes when shifting in and out of PARK (P), can be changed through the DIC. You can change these modes by different selections of the following DIC displays:

- AUTO DOOR LOCKS - OFF/ON
- UNLOCK IN PARK - OFF/ON

If you choose OFF for AUTO DOOR LOCKS, your door locks will operate normally with no automatic feature.

If you choose ON for AUTO DOOR LOCKS, and ON for UNLOCK IN PARK, your doors will lock every time you shift out of PARK (P), and the doors will unlock every time you stop and shift into PARK (P).

If you choose ON for AUTO DOOR LOCKS, and OFF for UNLOCK IN PARK, your door locks will lock every time you shift out of PARK (P), and there will be no automatic door unlock when shifting back into PARK (P).

To change modes:

1. Move the arrow on the display between ON and OFF by pressing the ENG/MET button.
2. Once you have made your selection, press the RESET button and your choice will be retained in memory.

See "Memory Door Locks" in the Index for more information about this feature.

## Delayed Locking

The delayed locking feature, which delays the actual locking of the vehicle, can be made active or inactive through the DIC. When DELAYED LOCKING - OFF - ON appears on the display, use the ENG/MET button to toggle the arrow between OFF and ON. When you have made your choice, press the RESET button to record your selection.

For more information on this feature, see "Delayed Locking" in the Index.

## Security Feedback

By choosing different combinations of these selections, you can choose the type of transmitter activated feedback when locking and unlocking your vehicle with your transmitter. Each time you make a selection by pressing the ENG/MET button, press the RESET button to record your choice.

- LOCK FEEDBACK - OFF/ON
- LOCK FEEDBACK - LIGHTS/LIGHTS + HORN
- UNLOCK FEEDBACK - OFF/LIGHTS

If you choose ON for LOCK FEEDBACK you will also need to choose LIGHTS or LIGHTS + HORN.

You can select the following modes:

- If you choose OFF for LOCK FEEDBACK and OFF for UNLOCK FEEDBACK, you will receive no security feedback when locking or unlocking your vehicle.
- If you choose OFF for LOCK FEEDBACK and LIGHTS for UNLOCK FEEDBACK, you will receive no security feedback when locking your vehicle and the exterior lamps will flash when unlocking your vehicle.

- If you choose LIGHTS for LOCK FEEDBACK and OFF for UNLOCK FEEDBACK, your exterior lamps will flash when locking your vehicle and you will receive no security feedback when unlocking your vehicle.
- If you choose LIGHTS for LOCK FEEDBACK and LIGHTS for UNLOCK FEEDBACK, your exterior lamps will flash when locking and when unlocking your vehicle.
- If you choose LIGHTS + HORN for LOCK FEEDBACK and OFF for UNLOCK FEEDBACK, your exterior lamps will flash and the horn will chirp when locking your vehicle and you will receive no security feedback when unlocking your vehicle.
- If you choose LIGHTS + HORN for LOCK FEEDBACK and LIGHTS for UNLOCK FEEDBACK, your exterior lamps will flash and the horn will chirp when locking your vehicle and your exterior lamps will flash when unlocking your vehicle.

For more information on this feature, see "Security Feedback" in the Index.



### Perimeter Lighting

When the UNLOCK button on the transmitter is pressed, the DRL lamps (high-beams at reduced intensity), parking lamps and back-up lamps will turn on if it is dark enough according to the twilight sentinel.

You can control activation of this feature by choosing OFF or ON when the PERIMETER LIGHTS choice is displayed on the DIC. Make your choice by pressing the ENG/MET button and record your choice by pressing the RESET button.

**NOTE:** If you want to choose PERIMETER LIGHTS ON, you must also choose LIGHTS for UNLOCK FEEDBACK while making the security feedback choices.

For more information on this feature, see "Perimeter Lighting" in the Index.

### Memory Seat Recall

This feature recalls the position of your seat. When this feature is active, the memory seat and mirror positions will be recalled for the identified driver when the remote keyless entry transmitter is used to enter the vehicle.

You can program this feature to be active by choosing ON when the SEAT RECALL choice appears, or inactive by choosing OFF when the SEAT RECALL choice appears on the DIC. Make your choices by pressing the ENG/MET button and store them to memory by pressing the RESET button.

You can also program this feature to recall your memory seat position or the exit seat position.

- **Memory Position:** Choose ON when the SEAT RECALL choice appears, and then choose MEMORY when the RECALL POSITION choice appears.
- **Exit Position:** Choose ON when the SEAT RECALL choice appears, and then choose EXIT when the RECALL POSITION choice appears and your seat will move all the way down and back for easy exit. The seat will also move when you enter the vehicle after unlocking it with a remote keyless entry transmitter. This will allow for easy entry as well.

For more information on this feature, see "Memory Seats" in the Index.

### Window Lockout

The number of passenger windows locked out by the WINDOW LOCK switch can be programmed through the DIC.

If you choose ALL PASS, all three passenger window switches will be inactive when the WINDOW LOCK switch is enabled.

If you choose REAR, only the two rear passenger window switches will be locked out when the WINDOW LOCK switch is enabled.

To change modes:

1. Move the arrow on the display between ALL PASS and REAR by pressing the ENG/MET button.
2. Once you have made your selection, press the RESET button. Your choice will be retained in memory.

For more information on this feature, see "Window Lock" in the Index.

 NOTES

---

---

---

---

---

---

---

---

---

---

---

---

---

---

---

---

---

---

---

---

---

---

---

---

---

---

---

---

---

---



## NOTES

---

---

---

---

---

---

---

---

---

---

---

---

---

---

---

---

---

---

---

---

---

---

---



## Section 3 Comfort Controls and Audio Systems

---

In this section, you'll find out how to operate the comfort control and audio systems offered with your vehicle. Be sure to read about the particular systems supplied with your vehicle.

- |      |   |      |   |
|------|---|------|---|
| 3-2  | Comfort Controls  | 3-14 | AM-FM Stereo with Cassette Tape Player and Automatic Tone Control (If Equipped)                   |
| 3-2  | Personal Choice Comfort Controls (If Equipped)            | 3-18 | AM-FM Stereo with Compact Disc Player and Automatic Tone Control (If Equipped)                    |
| 3-2  | Dual Automatic ComforTemp Climate Control                 | 3-21 | AM-FM Stereo with Cassette Tape and Compact Disc Player with Automatic Tone Control (If Equipped) |
| 3-5  | Air Conditioning  | 3-27 | Trunk Mounted CD Changer (If Equipped)  |
| 3-5  | Heating   | 3-30 | Personal Choice Radio Controls (If Equipped)  |
| 3-6  | Ventilation System  | 3-30 | Theft-Deterrent Feature   |
| 3-7  | Passenger Compartment Air Filter                          | 3-33 | Audio Steering Wheel Controls (If Equipped)   |
| 3-8  | Defogging and Defrosting                                  | 3-34 | Understanding Radio Reception   |
| 3-8  | Rear Window Defogger                                      | 3-34 | Tips About Your Audio System  |
| 3-9  | Passenger Climate Control                                 | 3-35 | Care of Your Cassette Tape Player   |
| 3-9  | Steering Wheel Controls for Climate Control (If Equipped) | 3-36 | Care of Your Compact Discs  |
| 3-10 | Setting the Clock   | 3-36 | Care of Your Compact Disc Player  |
| 3-10 | AM-FM Stereo with Cassette Tape Player (If Equipped)      | 3-36 | Heated Backlite Antenna   |

## Comfort Controls

This section tells you how to operate your comfort controls. Your comfort control system uses ozone-friendly R-134a refrigerant.

With these systems, you can control the heating, cooling and ventilation in your vehicle. Your vehicle also has a flow-through ventilation system described later in this section.

### Personal Choice Comfort Controls (If Equipped)

This feature allows two different drivers to store and recall their own climate control settings for temperature, air delivery mode, fan and passenger climate control (on/off) status. The Personal Choice settings recalled are determined by the transmitter used to enter the vehicle. After the UNLOCK button of a remote keyless entry transmitter is pressed, and the ignition is in RUN, the climate control will adjust to the last settings of the identified driver. The settings can also be changed by briefly pressing one of the MEMORY seat switches located on the driver's door panel. When adjustments are made, the new settings are automatically saved for the driver.

## Dual Automatic ComforTemp Climate Control

Your vehicle has the dual automatic comfortemp climate control system. The following information tells you how it works.

You will hear a beep each time a button is pushed and a small light on the button will indicate which buttons are active. The lights are on all buttons except TEMP, FAN and AIR FLOW. The display will show fan speed, comfort level setting and airflow direction for a few seconds whenever any button, except for the rear defog, is pushed, and then it will display the outside temperature. The outside temperature reading is most accurate when the vehicle is moving.

During stops, when driving slow, or when the engine is first started after a short trip, the outside temperature reading can be affected by road or engine heat. In order to ensure proper automatic climate control operation, the outside temperature display may not update as quickly as expected.



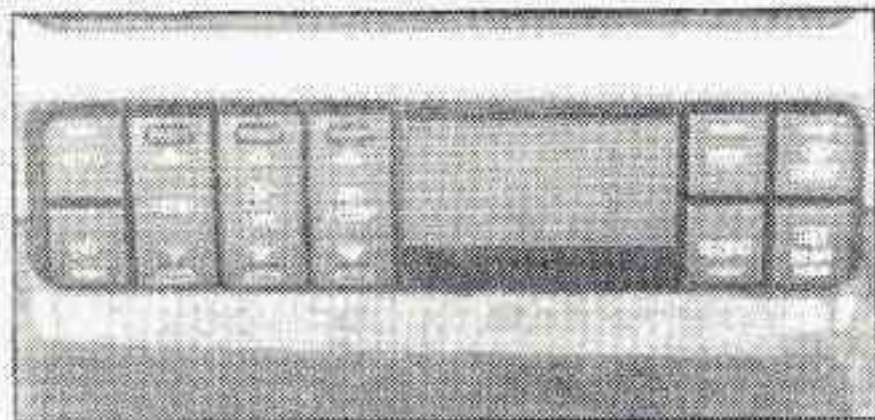

Sun and temperature sensors automatically adjust the air temperature, the airflow direction and the fan speed to maintain your comfort setting. The system may supply cooler air to the side toward the sun. Be careful not to put anything over the sensors on top of the dash.

#### Temperature Button

To adjust the comfort level you want maintained inside the vehicle, push the TEMP button. If you want a warmer comfort level, push the red arrow. If you want a cooler comfort level, push the blue arrow. Your comfort setting is shown in the display.

#### Fan Button

The speed of the blower fan is controlled automatically if you have the system set for AUTO. Pressing the FAN button will display and hold the current blower fan setting.

If you want the blower fan to run at a lower speed, push the bottom of the FAN button. The fan speed will decrease with every push of the button until the lowest speed is reached. If you want to increase the fan speed, push the top of the FAN button. Notice the fan indicators on the display.

#### Mode Controls

Press the AIR FLOW button to deliver air through the floor, middle or windshield outlets. The system will stay in the selected mode until the AUTO button is pushed. Press the up or down arrow on the AIR FLOW button to cycle through the available modes.

#### Automatic Operation

Press the AUTO button when you want the system to automatically adjust to changes in the temperature inside the vehicle, the outside temperature and the sun load on the vehicle. When the system is set for automatic operation, air will come from the floor, middle or windshield outlets depending on the temperature inside the vehicle, the outside temperature and sun load. Fan speed will vary as the system gets to and maintains the comfort setting you have selected through the use of the TEMP button.

To find your comfort setting, start with the system in AUTO mode and the TEMP button adjusted to a display of 75°F (24°C), give the vehicle about 20 minutes to stabilize, and adjust your comfort setting if necessary, by using the TEMP button. The display will show the comfort setting, fan speed and airflow direction for a few seconds, and then it will display the outside temperature.

In cold weather, the system will delay turning the fan on high, to avoid blowing cold air. The length of the delay depends on the engine coolant temperature and the outside temperature. Pushing the FAN, AIR FLOW or FRONT buttons will override this delay, turn off the AUTO setting and change the fan speed.

### Manual Operation

You may also manually adjust the air delivery or fan speed.

**AIR FLOW:** This button is used to change the direction of the airflow. The airflow choices available are FLOOR, FLOOR-MID, MID and WINDSHIELD-FLOOR. If the system is set for AUTO, pressing the AIR FLOW button will display the current airflow direction, the comfort setting and the fan speed. Press the AIR FLOW up or down button again to change the direction of the airflow.

If the AIR FLOW up button is selected while in the FRONT defrost mode, the system will direct the air toward the mid-position. If the AIR FLOW down button is selected while in the FRONT defrost mode, the system will direct the air toward the FLOOR, and the FRONT defrost mode will cancel. Notice the arrows in the display.

**OFF:** If the passenger comfort control is turned on, it can be turned off by pressing the OFF button once. Pressing the OFF button a second time will turn off the main system. Turning off the main system causes the fan to turn off and the airflow to be directed to the FLOOR. The system will still try to keep the interior of the vehicle at the previous chosen comfort setting. The outside temperature will show on the display when the system is off.

The ventilation system always allows fresh air to flow through your vehicle when the vehicle is moving even with the system in the OFF mode.

**VENT:** The VENT button allows outside air to flow through your vehicle without the air conditioning compressor working. Selecting VENT and the AUTO button at the same time allows the system to control automatically without the use of the air conditioning compressor or the use of the RECIRC mode. To turn off the VENT selection, push the VENT button again.



**RECIRC:** When RECIRC is selected, the system will limit the amount of outside air entering your vehicle. This is helpful when you are trying to cool the interior of the vehicle quickly or limit the amount of outside air entering your vehicle for some other reason. RECIRC and AUTO may be selected at the same time. The system will remain in RECIRC until the ignition is turned off. The system will return back to the previously selected mode when the car is turned back on. RECIRC can be selected in all manual airflow modes except FRONT defrost. RECIRC cannot be selected with the VENT button.

 **FRONT:** This selection is used to defrost the windshield by directing the airflow toward the windshield.

If FRONT is selected while in the AUTO mode, the fan speed and the air temperature from the front defroster will vary. If a manual fan speed setting is selected, the fan speed will remain at that selection until another fan speed selection is made or the AUTO mode is selected. To turn off FRONT, press the AUTO or AIR FLOW button.

FRONT defrost will work better if any ice or snow is cleared from the hood and the air inlet area between the base of the windshield and the hood.

## Air Conditioning

On hot days, open the windows long enough to let hot inside air escape. This reduces the time it takes for your vehicle to cool down. Then keep your windows closed for the air conditioner to work its best.

On very hot days, the system will automatically enter the RECIRC mode and the temperature door will be positioned at the full cold position for maximum cooling. If the system is not in the AUTO mode, RECIRC should be selected to provide maximum cooling. You can choose the extreme comfort setting of 60°F (16°C), but the system will not cool any faster by choosing the extreme comfort setting.

## Heating

Press AUTO and adjust the temperature by pressing the TEMP up or down arrow. You may also adjust the dual automatic comfortemp system manually by pressing the AIR FLOW button until FLOOR appears. Again, adjust the temperature by pressing the TEMP up or down arrow.

Outside air will be brought in and sent through the floor outlets. The heater works best if you keep your windows closed.



## Ventilation System

For mild outside temperatures when little heating or cooling is needed, use VENT to direct outside air through your vehicle. Air will flow through any of the outlets depending on outside temperatures and comfort level settings.

Your vehicle's flow-through ventilation system supplies outside air into the vehicle when it's moving. When the vehicle is not moving, you can get outside air to flow through by selecting any air choice (except the rear window defogger) and any fan speed.

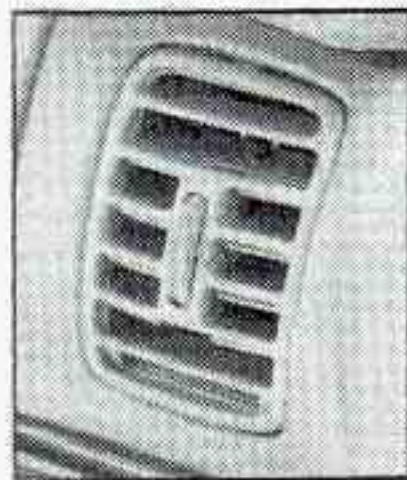

Adjust the direction of airflow by moving the louvered vents.

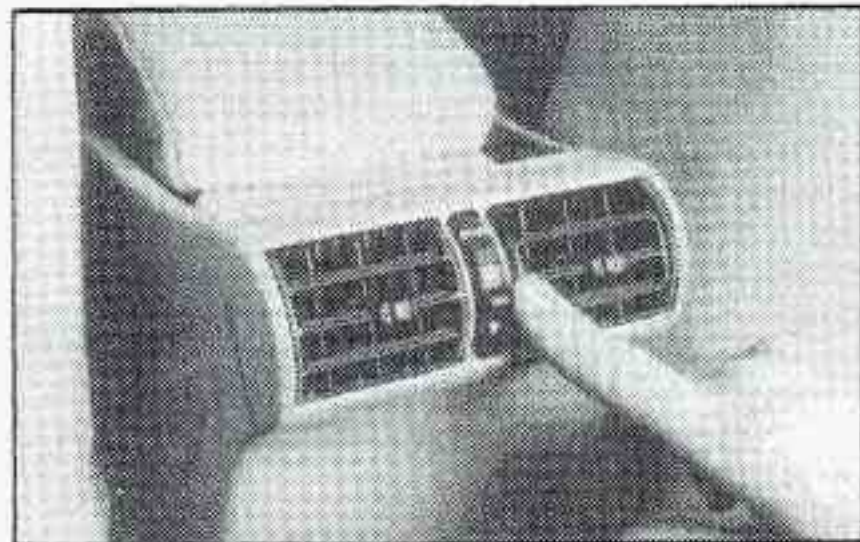

You have rear passenger comforttemp outlets that you can use to adjust the direction of the airflow to the rear seating area. The temperature is controlled by the front passenger setting.

### Ventilation Tips

- Keep the hood and front air inlet free of ice, snow or any other obstruction such as leaves. The heater and defroster will work better, reducing the chance of fogging your windows.
- Keep the air path under the front seats clear of objects. This helps air to circulate throughout your vehicle.

### Passenger Compartment Air Filter

Passenger compartment air, both outside air and recirculated air, is routed through a passenger compartment filter, which is part of a three piece filter system. The filter removes certain particles from the air, including pollen and dust particles. Reductions in airflow, which may occur more quickly in dusty areas, indicate that the filter needs to be replaced early.

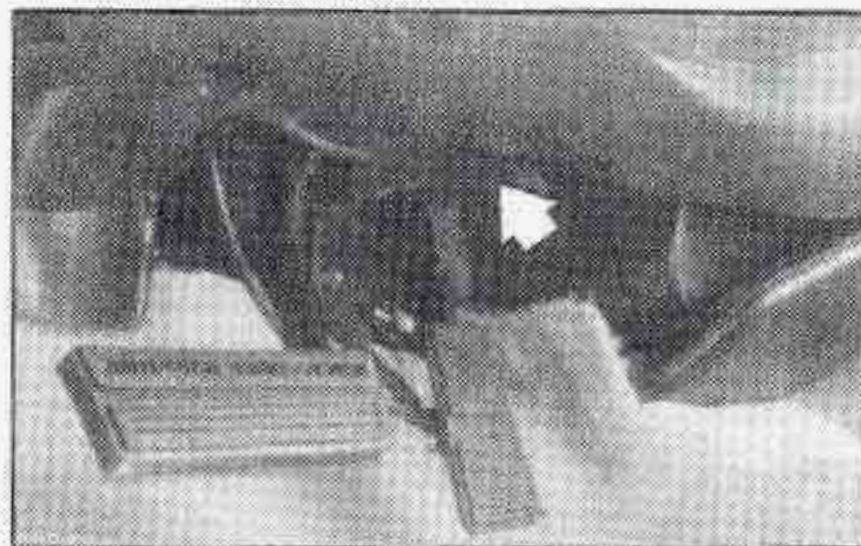

The particle filter is located inside the air control module with an access panel underneath the instrument panel near the accelerator pedal. The filter should be replaced as part of routine scheduled maintenance. See "Maintenance Schedule" in the Index for replacement intervals. See your dealer for details on changing the filter.

Once you remove your filter, if you choose not to replace it, it will not damage your vehicle. However, the air will no longer be filtered.



## Defogging and Defrosting

On cool but humid days, use **FRONT** to keep the windshield and side windows clear and to quickly remove fog, frost or ice from the windshield.

The fan speed will vary while in the **AUTO** mode. If a manual fan speed setting is selected, the fan speed will remain at that selection until the engine is turned off or another selection has been made. To turn off **FRONT**, press **AUTO** or **AIR FLOW**.

## Rear Window Defogger

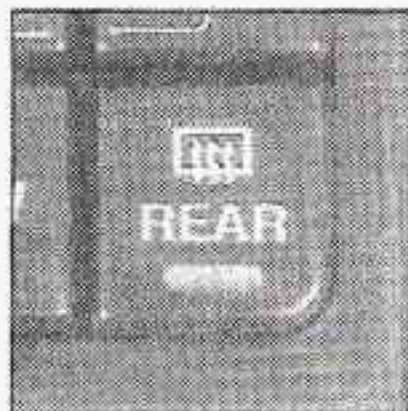

The lines you see on the rear window warm the glass. Press this button to start warming your window.

At speeds above 30 mph (48 km/h), the rear defogger will stay on until you press the **REAR** button again. After 10 minutes of driving below 30 mph (48 km/h), the defogger will turn off automatically. If you need additional warming time, push the button again. The system will then operate for five minutes before going off by itself.

Do not attach a temporary vehicle license, tape or decals across the defogger grid on the rear window.

### **NOTICE:**

**Don't use a razor blade or something else sharp on the inside of the rear window. If you do, you could cut or damage the warming grid or the integrated rear window antenna, and the repairs wouldn't be covered by your warranty.**



## Passenger Climate Control



The front seat passenger can control the air temperature in their seating area. This can be set up to 5°F (-15°C) cooler or warmer than the primary setting. You can activate this feature by sliding the lever located on the instrument panel toward warm or cool.

If the passenger control has been turned on, it can be turned off by pressing the OFF button once. Pressing the OFF button a second time will turn off the main system.

## Steering Wheel Controls for Climate Control (If Equipped)



If your vehicle has this feature, you can control the temperature function by using the button on your steering wheel. Press the TEMP up arrow to increase the temperature and the TEMP down arrow to decrease the temperature.

## Audio Systems

Your Delco Electronics audio system has been designed to operate easily and give years of listening pleasure. You will get the most enjoyment out of it if you acquaint yourself with it first. Find out what your Delco Electronics system can do and how to operate all its controls, to be sure you're getting the most out of the advanced engineering that went into it.

### Setting the Clock

Press and hold HRS until the correct hour appears. Press and hold MIN until the correct minute appears.

You may set the clock with the ignition off if you press RECALL first and follow the same procedure described above.

## AM-FM Stereo with Cassette Tape Player (If Equipped)



### Playing the Radio

**VOLUME:** This knob turns the system on and off and controls the volume. To increase volume and turn the radio on, turn the knob to the right. Turn it to the left to decrease volume.

**RECALL:** Press the upper knob briefly to recall the station being played or to display the clock. To change what is normally shown on the display (station or time), press the knob until you see the display you want, then hold the knob until the display flashes. If you press the knob when the ignition is off, the clock will show for a few seconds.

### Finding a Station

**AM-FM:** Press the lower knob to switch between AM, FM1 and FM2. The display shows your selection.

**TUNE:** Turn the lower knob to choose radio stations.

**SEEK:** Press the right or left arrow to go to the next higher or lower station and stay there. The sound will mute while seeking.

**SCAN:** Press one of the **SEEK** arrows for two seconds, and **SCAN** will appear on the display. Use **SCAN** to listen to stations for a few seconds. The radio will go to a station, stop for a few seconds, then go on to the next station. Press one of the **SEEK** arrows again to stop scanning. The sound will mute while scanning.

**PUSHBUTTONS:** The six numbered pushbuttons let you return to your favorite stations. You can set up to 18 stations (six AM, six FM1 and six FM2). Just:

1. Turn the radio on.
2. Press AM-FM to select the band.
3. Tune in the desired station.
4. Press and hold one of the six numbered buttons. The sound will mute. When it returns, release the button. Whenever you press that numbered button, the station you set will return.
5. Repeat the steps for each pushbutton.

**P SCAN:** Press this button to listen to each of your preset stations for a few seconds. The radio will go to the first preset station, stop for a few seconds, then go on to the next preset station. Press **P SCAN** again to stop scanning. The radio will not stop at a preset if the station is weak.



### Setting the Tone

**BASS:** Press this knob lightly so it extends. Turn the knob to increase or decrease bass.

**TREB:** Press this knob lightly so it extends. Turn the knob to increase or decrease treble. If a station is weak or noisy, you may want to decrease the treble.

Push these knobs back into their stored positions when you're not using them.

### Adjusting the Speakers

**BAL:** Turn the control behind the upper knob to move the sound to the left or right speakers. The middle position balances the sound between the speakers.

**FADE:** Turn the control behind the lower knob to move the sound to the front or rear speakers. The middle position balances the sound between the speakers.

### Playing a Cassette Tape

The longer side with the tape visible should face to the right. If the ignition and the radio are on, the tape can be inserted and will begin playing. If you hear nothing or hear a garbled sound, the tape may not be in squarely. Press EJECT to remove the tape and start over.

While the tape is playing, use the VOLUME, FADE, BAL, BASS and TREB controls just as you do for the radio. Other controls may have different functions when a tape is inserted. The display will show an arrow to show which side of the tape is playing.

If you want to insert a tape when the ignition or radio is off, first press EJECT or RECALL. Note that the cassette tape adapter kits for portable compact disc players will work in your cassette tape player.

Your tape bias is set automatically.

If E and a number appear on the radio display, the tape won't play because of an error.

- **E10:** The tape is tight and the player can't turn the tape hubs. Remove the tape. Hold the tape with the open end down and try to turn the right hub to the left with a pencil. Turn the tape over and repeat. If the hubs do not turn easily, your tape may be damaged and should not be used in the player. Try a new tape to make sure your player is working properly.
- **E11:** The tape is broken. Try a new tape.

If any error occurs repeatedly or if an error can't be corrected, please contact your dealer. If your radio displays an error number, write it down and provide it to your dealer when reporting the problem.

**PREV (1):** Press this button to search for the previous selection on the tape. Your tape must have at least three seconds of silence between each selection for PREV to work. The sound will mute while seeking.

**NEXT (2):** Press this button to search for the next selection on the tape. Your tape must have at least three seconds of silence between each selection for NEXT to work. The sound will mute while seeking.

The SEEK left and right arrows will also find the previous and next selections on the tape.

**◀◀ (3):** Press this button to reverse the tape rapidly. Press it again to return to playing speed. The radio will play while the tape reverses.

**▶▶ (4):** Press this button to advance quickly to another part of the tape. Press the button again to return to playing speed. The radio will play while the tape advances.

**SIDE (5):** Press this button to change the side of the tape that is playing.

**□□ (6):** Press this button to reduce background noise. The display will show either OFF or ON for a few seconds when you press the button.

Dolby Noise Reduction is manufactured under a license from Dolby Laboratories Licensing Corporation. Dolby and the double-D symbol are trademarks of Dolby Laboratories Licensing Corporation.

**EJECT:** Press this button to remove the tape. The radio will play.

**CLN:** If this message appears on the display, the cassette tape player needs to be cleaned. It will still play tapes, but you should clean it as soon as possible to prevent damage to the tapes and player. See "Care of Your Cassette Tape Player" in the Index. After you clean the player, press and hold EJECT for five seconds to reset the CLN indicator. The radio will display --- to show the indicator was reset.

## AM-FM Stereo with Cassette Tape Player and Automatic Tone Control (If Equipped)



### Playing the Radio

**VOLUME:** Press this knob to turn the system on and off. To increase volume, turn the knob to the right. Turn it to the left to decrease the volume.

**RECALL:** Press this button briefly to recall the station being played or to display the clock. To change what is normally shown on the display (station or time), press this button until you see the display you want, then hold the button until the display flashes. If you press the button when the ignition is off, the clock will show for a few seconds.

### Finding a Station

**AM-FM:** Press this button to switch between AM, FM1 and FM2. The display shows your selection.

**TUNE:** Press the up or down arrow to choose radio stations.

**SEEK:** Press the up or down arrow to go to the next higher or lower station and stay there. The sound will mute while seeking.

**SCAN:** Press one of the SEEK arrows for two seconds and SCAN will appear on the display. Use SCAN to listen to stations for a few seconds. The radio will go to a station, stop for a few seconds, then go on to the next station. Press one of the SEEK buttons again to stop scanning. The sound will mute while scanning.



**PUSHBUTTONS:** The six numbered pushbuttons let you return to your favorite stations. You can set up to 18 stations (six AM, six FM1 and six FM2). Just:

1. Turn the radio on.
2. Press AM-FM to select the band.
3. Tune in the desired station.
4. Press TONE to select the setting you prefer.
5. Press and hold one of the six numbered buttons. The sound will mute. When it returns, release the button. Whenever you press that numbered button, the station you set will return and the tone you selected will be automatically selected for that button.
6. Repeat the steps for each pushbutton.

**P SCAN:** Press this button to listen to each of your preset stations for a few seconds. The radio will go to the first preset station, stop for a few seconds, then go on to the next preset station. Press P SCAN again to stop scanning. If a preset station has weak reception, the radio will not stop at the preset station.

**AUTO SET:** Press this button and the system will seek and set the 12 strongest FM or the 6 strongest AM stations on your preset buttons (depending on which

band (AM or FM) you are listening to). AUTO SET will flash while seeking and will remain on until this function is complete. To return to the stations you manually set, press AUTO SET again.

#### Setting the Tone

**BASS:** Press this knob lightly so it extends. Turn the knob to increase or decrease bass.

**TREB:** Press this knob lightly so it extends. Turn the knob to increase or decrease treble. If a station is weak or noisy, you may want to decrease the treble.

Push these knobs back into their stored positions when you're not using them.

**TONE:** This feature allows you to choose preset bass and treble equalization settings designed for classical, pop, rock, jazz, talk and country/western stations. CLASS will appear on the display when you first press TONE. Each time you press it, another setting will appear on the display. Press it again after C & W appears and MANUAL will appear. Tone control will return to the BASS and TREB knobs. Also, if you use the BASS and TREB knobs, control will return to them and MANUAL will appear.

### Adjusting the Speakers

**BAL:** Press this knob lightly so it extends. Turn the knob to move the sound to the left or right speakers. The middle position balances the sound between the speakers.

**FADE:** Press this knob lightly so it extends. Turn the knob to move the sound to the front or rear speakers. The middle position balances the sound between the speakers.

Push these knobs back into their stored positions when you're not using them.

### Playing a Cassette Tape

The longer side with the tape visible should face to the right. If the ignition and the radio are on, the tape can be inserted and will begin playing. If you hear nothing or hear a garbled sound, the tape may not be in squarely. Press EJECT to remove the tape and start over.

While the tape is playing, use the VOLUME, FADE, BAL, BASS and TREB controls just as you do for the radio. Other controls may have different functions when a tape is inserted. The display will show an arrow to show which side of the tape is playing.

If you want to insert a tape when the ignition or radio is off, first press EJECT or RECALL. Note that the cassette tape adapter kits for portable compact disc players will work in your cassette tape player.

Your tape bias is set automatically.

If E and a number appear on the radio display, the tape won't play because of an error.

- **E10:** The tape is tight and the player can't turn the tape hubs. Remove the tape. Hold the tape with the open end down and try to turn the right hub to the left with a pencil. Turn the tape over and repeat. If the hubs do not turn easily, your tape may be damaged and should not be used in the player. Try a new tape to make sure your player is working properly.
- **E11:** The tape is broken. Try a new tape.

If any error occurs repeatedly or if an error can't be corrected, please contact your dealer. If your radio displays an error number, write it down and provide it to your dealer when reporting the problem.



**PREV (1):** Press this button to search for the previous selection on the tape. Your tape must have at least three seconds of silence between each selection for PREV to work. The sound will mute while seeking.

**NEXT (2):** Press this button to search for the next selection on the tape. Your tape must have at least three seconds of silence between each selection for NEXT to work. The sound will mute while seeking.

The SEEK up and down arrows will also find the previous and next selections on the tape.

**◀◀ (3):** Press this button to reverse the tape rapidly. Press it again to return to playing speed. The radio will play while the tape reverses.

**▶▶ (4):** Press this button to advance quickly to another part of the tape. Press the button again to return to playing speed. The radio will play while the tape advances.

**SIDE (5):** Press this button to change the side of the tape that is playing.

**□□ (6):** Press this button to reduce background noise. The double-D symbol will appear on the display.

Dolby Noise Reduction is manufactured under a license from Dolby Laboratories Licensing Corporation. Dolby and the double-D symbol are trademarks of Dolby Laboratories Licensing Corporation.

**AM-FM:** Press this button to play the radio when a tape is in the player.

**SOURCE:** Press this button to change to the tape function when the radio is on. TAPE PLAY with an arrow will appear on the display when the tape is active.

**EJECT:** Press this button to remove the tape. The radio will play.

**CLN:** If this message appears on the display, the cassette tape player needs to be cleaned. It will still play tapes, but you should clean it as soon as possible to prevent damage to the tapes and player. See "Care of Your Cassette Tape Player" in the Index. After you clean the player, press and hold EJECT for five seconds to reset the CLN indicator. The radio will display --- to show the indicator was reset.



## AM-FM Stereo with Compact Disc Player and Automatic Tone Control (If Equipped)



### Playing the Radio

**VOLUME:** Press this knob to turn the system on and off. To increase volume, turn the knob to the right. Turn it to the left to decrease the volume.

**RECALL:** Press this button briefly to recall the station being played or to display the clock. To change what is normally shown on the display (station or time), press the button until you see the display you want, then hold the button until the display flashes. If you press the button when the ignition is off, the clock will show for a few seconds.

### Finding a Station

**AM-FM:** Press this button to switch between AM, FM1 and FM2. The display shows your selection.

**TUNE:** Press the up or down arrow to choose radio stations.

**SEEK:** Press the up or down arrow to go to the next higher or lower station and stay there. The sound will mute while seeking.

**SCAN:** Press one of the SEEK arrows for two seconds and SCAN will appear on the display. Use SCAN to listen to stations for a few seconds. The radio will go to a station, stop for a few seconds, then go on to the next station. Press one of the SEEK arrows again to stop scanning. The sound will mute while scanning.

**PUSHBUTTONS:** The six numbered pushbuttons let you return to your favorite stations. You can set up to 18 stations (six AM, six FM1 and six FM2). Just:

1. Turn the radio on.
2. Press AM-FM to select the band.
3. Tune in the desired station.
4. Press TONE to select the setting you prefer.
5. Press and hold one of the six numbered buttons. The sound will mute. When it returns, release the button. Whenever you press that numbered button, the station you set will return and the tone you selected will be automatically selected for that button.
6. Repeat the steps for each pushbutton.

**P SCAN:** Press this button to listen to each of your preset stations for a few seconds. The radio will go to the first preset station, stop for a few seconds, then go on to the next preset station. Press P SCAN again to stop scanning. If a preset station has weak reception, the radio will not stop at the preset station.

**AUTO SET:** Press this button and the system will seek and set the 12 strongest FM or the 6 strongest AM stations on your preset buttons (depending on which

band (AM or FM) you are listening to). AUTO SET will flash while seeking and will remain on until this function is complete. To return to the stations you manually set, press AUTO SET again.

#### Setting the Tone

**BASS:** Press this knob lightly so it extends. Turn the knob to increase or decrease bass.

**TREB:** Press this knob lightly so it extends. Turn the knob to increase or decrease treble. If a station is weak or noisy, you may want to decrease the treble.

Push these knobs back into their stored positions when you're not using them.

**TONE:** This feature allows you to choose preset bass and treble equalization settings designed for classical, pop, rock, jazz, talk and country/western stations. CLASS will appear on the display when you first press TONE. Each time you press it, another setting will appear on the display. Press it again after C & W appears and MANUAL will appear. Tone control will return to the BASS and TREB knobs. Also, if you use the BASS and TREB knobs, control will return to them and MANUAL will appear.



## Adjusting the Speakers

**BAL:** Press this knob lightly so it extends.

Turn this knob to move the sound to the left or right speakers. The middle position balances the sound between the speakers.

**FADE:** Press this knob lightly so it extends. Turn this knob to move the sound to the front or rear speakers. The middle position balances the sound between the speakers.

Push these knobs back into their stored positions when you're not using them.

## Playing a Compact Disc

Insert a disc partway into the slot, label side up. The player will pull it in. The disc should begin playing.

If you want to insert a CD while the ignition or the radio is off, first press **EJECT** or **RECALL**.

If you're driving on a very rough road or if it's very hot, the disc may not play and an error code may appear on the display. When things get back to normal, the disc should play. If the disc comes out, it could be that:

- **E20:** The disc is upside down.
- **E20:** It is dirty, scratched or wet.

- **E20:** There's too much moisture in the air. (Wait about an hour and try again.)

If any error occurs repeatedly or if an error can't be corrected, please contact your dealer. If your radio displays an error number, write it down and provide it to your dealer when reporting the problem.

**PREV (1):** Press this button to go to the start of the current track if more than eight seconds have played. If you hold the button or press it more than once, the player will continue moving back through the disc. The sound will mute while seeking.

**NEXT (2):** Press this button to go to the next track. If you hold the button or press it more than once, the player will continue moving forward through the disc. The sound will mute while seeking.

The **SEEK** down and up arrows will also find the previous and next selections on the disc.

**◀◀ (3):** Press and hold this button to quickly reverse within a track. You will hear sound.

**▶▶ (4):** Press and hold this button to quickly advance within a track. You will hear sound.

**RAND (6):** Press this button to hear the tracks in random, rather than sequential, order. Press **RAND** again to turn off random play.



**RECALL:** Press this button to see which track is playing. Press it again within five seconds to see how long it has been playing. To change what is normally shown on the display (track or elapsed time), press the button until you see the display you want, then hold the button until the display flashes.

**AM-FM:** Press this button to play the radio when a disc is in the player.

**SOURCE:** Press this button to change to the disc function when the radio is on. When a disc is inserted, the disc will play until you press AM-FM. Then the disc will stop playing and the radio will play. Press SOURCE again to play a disc again. CD PLAY will show on the display.

**EJECT:** Press this button to remove the disc. The radio will play.

If you turn off the ignition or radio with a disc in the player, it will stay in the player. When you turn on the ignition or system, the disc will start playing where it stopped, if it was the last-selected audio source.

## AM-FM Stereo with Cassette Tape and Compact Disc Player with Automatic Tone Control (If Equipped)



### Playing the Radio

**VOLUME:** Press this knob to turn the system on and off. To increase volume, turn the knob to the right. Turn it to the left to decrease volume.

**RECALL:** Press this button briefly to recall the station being played or to display the clock. To change what is normally shown on the display (station or time), press the RECALL button until you see the display you want, then hold the RECALL button until the display flashes. If you press the button when the ignition is off, the clock will show for a few seconds.

### Finding a Station

**AM-FM:** Press this button to switch between AM, FM1 and FM2. The display shows your selection.

**TUNE:** Press the up or down arrow to choose radio stations.

**SEEK:** Press the up or down arrow to go to the next higher or lower station and stay there. The sound will mute while seeking.

**SCAN:** Press one of the SEEK arrows for two seconds and SCAN will appear on the display. Use SCAN to listen to stations for a few seconds. The radio will go to a station, stop for a few seconds, then go on to the next station. Press one of the SEEK arrows again to stop scanning. The sound will mute while scanning.

**PUSHBUTTONS:** The six numbered pushbuttons let you return to your favorite stations. You can set up to 18 stations (six AM, six FM1 and six FM2). Just:

1. Turn the radio on.
2. Press AM-FM to select the band.
3. Tune in the desired station.
4. Press TONE to select the setting you prefer.
5. Press and hold one of the six numbered buttons. The sound will mute. When it returns, release the button. Whenever you press that numbered button, the station you set will return and the tone you selected will be automatically selected for that button.
6. Repeat the steps for each pushbutton.

**P SCAN:** Press this button to listen to each of your preset stations for a few seconds. The radio will go to the first preset station, stop for a few seconds, then go on to the next preset station. Press P SCAN again to stop scanning. If a preset station has weak reception, the radio will not stop at the preset station.

**AUTO SET:** Press this button and the system will seek and set the 12 strongest FM or the 6 strongest AM stations on your preset buttons. AUTO SET will flash while seeking and will remain on until this function is complete. To return to the stations you manually set, press AUTO SET again.

### Setting the Tone

**BASS:** Press this knob lightly so it extends. Turn the knob to increase or decrease bass.

**TREB:** Press this knob lightly so it extends. Turn the knob to increase or decrease treble. If a station is weak or noisy, you may want to decrease the treble.

Push these knobs back into their stored positions when you're not using them.

**TONE:** This feature allows you to choose preset bass and treble equalization settings designed for classical, pop, rock, jazz, talk and country/western stations. CLASS will appear on the display when you first press TONE. Each time you press it, another setting will appear on the display. Press it again after C & W appears and MANUAL will appear. Tone control will return to the BASS and TREB knobs. Also, if you use the BASS and TREB knobs, control will return to them and MANUAL will appear.

### Adjusting the Speakers

**BAL:** Press this knob lightly so it extends. Turn the knob to move the sound to the left or right speakers. The middle position balances the sound between the speakers.

**FADE:** Press this knob lightly so it extends. Turn the knob to move the sound to the front or rear speakers. The middle position balances the sound between the speakers.

Push these knobs back into their stored positions when you're not using them.

### Playing a Cassette Tape

The longer side with the tape visible should face to the right. If the ignition and the radio are on, the tape can be inserted and will begin playing. If you hear nothing or hear a garbled sound, the tape may not be in squarely. Press EJECT to remove the tape and start over.

While the tape is playing, use the VOLUME, FADE, BAL, BASS and TREB controls just as you do for the radio. Other controls may have different functions when a tape is inserted. The display will show an arrow to show which side of the tape is playing.

If you want to insert a tape when the ignition or radio is off, first press EJECT or RECALL.



Your tape bias is set automatically.

If E and a number appear on the radio display, the tape won't play because of an error.

- **E10:** The tape is tight and the player can't turn the tape hubs. Remove the tape. Hold the tape with the open end down and try to turn the right hub to the left with a pencil. Turn the tape over and repeat. If the hubs do not turn easily, your tape may be damaged and should not be used in the player. Try a new tape to make sure your player is working properly.

- **E11:** The tape is broken. Try a new tape.

If any error occurs repeatedly or if an error can't be corrected, please contact your dealer. If your radio displays an error number, write it down and provide it to your dealer when reporting the problem.

**PREV (1):** Press this button to search for the previous selection on the tape. Your tape must have at least three seconds of silence between each selection for PREV to work. The sound will mute while seeking.

**NEXT (2):** Press this button to search for the next selection on the tape. Your tape must have at least three seconds of silence between each selection for NEXT to work. The sound will mute while seeking.

The SEEK down and up arrows will also find the previous and next selections on the tape.

◀◀ **(3):** Press this button to reverse the tape rapidly. Press it again to return to playing speed. The radio will play while the tape reverses.

▶▶ **(4):** Press this button to advance quickly to another part of the tape. Press the button again to return to playing speed. The radio will play while the tape advances.

**SIDE (5):** Press this button to change the side of the tape that is playing.

**RAND (6):** Press this button to reduce background noise. The double-D symbol will appear in the display.

Dolby Noise Reduction is manufactured under a license from Dolby Laboratories Licensing Corporation. Dolby and the double-D symbol are trademarks of Dolby Laboratories Licensing Corporation.

**SOURCE:** Press this button to change to the tape or disc function when the radio is on. If both a tape and a disc are installed, the system will first go to tape play; TAPE SIDE and an arrow will appear on the display. If SOURCE is pressed again, the system will go to disc play; CD PLAY will appear on the display.

**EJECT:** The system has two EJECT buttons. Press the button near the CD slot to remove a disc. Press the button near the tape slot to remove a tape and the radio will play.

**CLN:** If this message appears on the display, the cassette tape player needs to be cleaned. It will still play tapes, but you should clean it as soon as possible to prevent damage to the tapes and player. See "Care of Your Cassette Tape Player" in the Index. After you clean the player, press and hold EJECT for five seconds to reset the CLN indicator. The radio will display --- to show the indicator was reset.

Your cassette tape player automatically reduces background noise from tapes encoded with Dolby NR. You may turn Dolby off by pressing the number six preset.

### Playing a Compact Disc

Insert a disc partway into the slot, label side up. The player will pull it in. The disc should begin playing.

If you want to insert a CD while the ignition or the radio is off, first press EJECT or RECALL.

If you're driving on a very rough road or if it's very hot, the disc may not play and an error code may appear on the display. When things get back to normal, the disc should play. If the disc comes out, it could be that:

- **E20:** The disc is upside down.
- **E20:** It is dirty, scratched or wet.
- **E20:** There's too much moisture in the air. (Wait about an hour and try again.)

If any error occurs repeatedly or if an error can't be corrected, please contact your dealer. If your radio displays an error number, write it down and provide it to your dealer when reporting the problem.

**PREV (1):** Press this button to go to the start of the current track, if more than eight seconds have played. If you hold the button or press it more than once, the player will continue moving back through the disc. The sound will mute while seeking.

**NEXT (2):** Press this button to go to the next track. If you hold the button or press it more than once, the player will continue moving forward through the disc. The sound will mute while seeking.

The SEEK down and up arrows will also find the previous and next selections on the disc.

**◀◀ (3):** Press and hold this button to quickly reverse within a track. You will hear sound.

**▶▶ (4):** Press and hold this button to quickly advance within a track. You will hear sound.

**RAND (6):** Press this button to hear the tracks in random, rather than sequential, order. Press RAND again to turn off random play.

**RECALL:** Press this button to see which track is playing. Press it again within five seconds to see how long it has been playing. To change what is normally shown on the display (track or elapsed time), press the RECALL button until you see the display you want, then hold the RECALL button until the display flashes.

**AM-FM:** Press this button to play the radio when a disc is in the player.

**SOURCE:** Press this button to change to the disc function when the radio is on. When a disc is inserted, the disc will play until you press AM-FM. Then the disc will stop playing and the radio will play. Press SOURCE again to play a disc again. CD PLAY will show on the display.

**EJECT:** Press this button to remove the disc. The radio will play.

If you turn off the ignition or radio with a disc in the player, it will stay in the player. When you turn on the ignition or system, the disc will start playing where it stopped, if it was the last-selected audio source.

Also, as a protection feature, if a CD is ejected and left in the player, it will be pulled back in the player with the ignition on or off.



### Trunk Mounted CD Changer (If Equipped)

With the optional compact disc changer, you can play up to 12 discs continuously. Normal size discs may be played using the trays supplied in the magazine.

The small discs (8 cm) can be played only with specially designed trays.

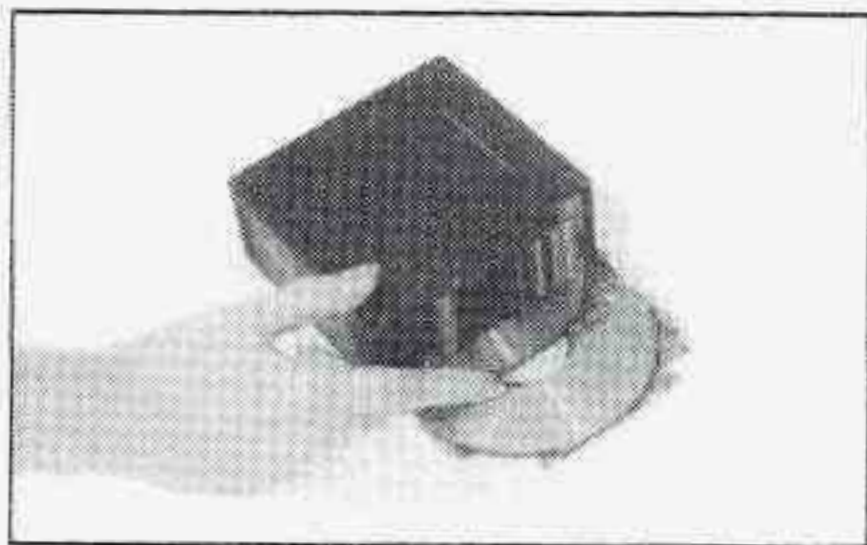

You must first load the magazine with discs before you can play a compact disc. Each of the 12 trays holds one disc. Press the button on the back of the magazine and pull gently on one of the trays. Load the trays from bottom to top, placing a disc on the tray label side down.

If you load a disc with the label side up, the disc will not play and an error will occur. Gently push the tray back into the magazine slot. Repeat this procedure for loading up to 12 discs in the magazine.

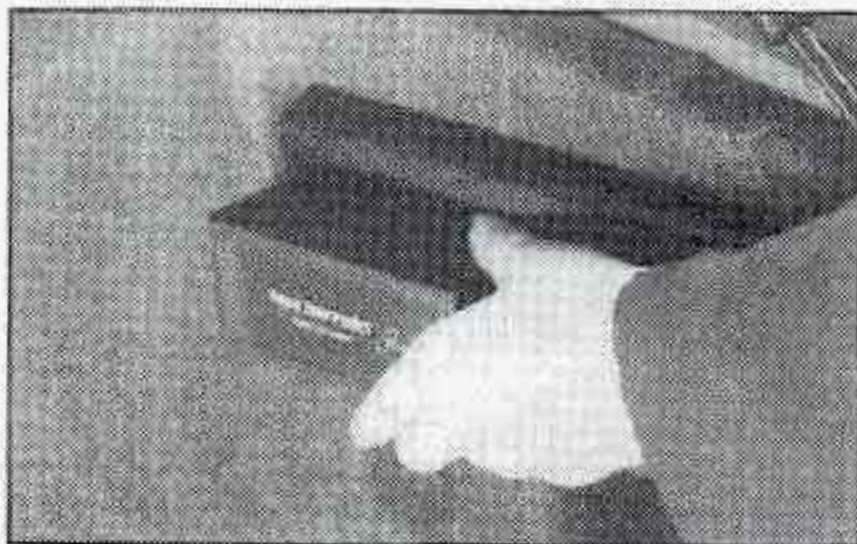

Once you have loaded the discs in the magazine, slide open the door of the compact disc (CD) changer. Push the magazine into the changer in the direction of the arrow marked on top of the magazine.

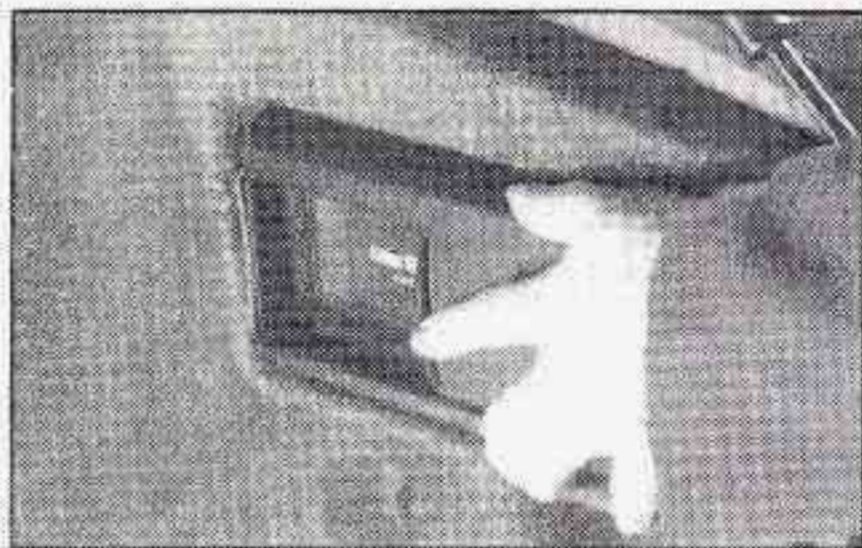

Close the door by sliding it all the way to the left. If the door is left partially open, the changer will not operate and an error will occur. When the door is closed, the changer will begin checking for discs in the magazine. This will continue for up to two minutes depending on the number of discs loaded.

To eject the magazine from the player, slide the CD changer door all the way open. The magazine will automatically eject. Remember to keep the door closed whenever possible to keep dirt and dust from getting inside the changer.

All of the CD functions are controlled by the radio buttons except for ejecting the magazine. Whenever a CD magazine with discs is loaded in the changer, the compact disc symbol will appear on the radio display. If the CD changer is checking the magazine for CDs, the compact disc symbol will flash on the display until the changer is ready to play. When a CD begins playing, the disc and track number will be displayed. The disc numbers are listed on the front of the magazine.

#### Compact Disc Changer Errors

If E and a number appear on the display, an error has occurred and the compact disc temporarily cannot play.

The CD changer will send an error message to the receiver to indicate:

- **E30:** Disc Loaded Incorrectly (Label Side Up)
- **E34:** CD Changer Door Open
- **E35:** CD Changer Cartridge Empty

If the error occurred while trying to play a CD in the compact disc player or changer, the following conditions may have caused the error:

- The road is too rough. The disc should play when the road is smoother.
- The disc is dirty, scratched, wet or upside down.



- The air is very humid. If so, wait about an hour and try again.
- The CD changer door is open. Completely close the door to restore normal operation.
- An empty magazine is inserted in the CD changer. Try the magazine again with a disc loaded on one of the trays.

If any error occurs repeatedly or if an error cannot be corrected, please contact your dealer. If your radio displays an error number other than the error codes listed previously, write it down and provide it to your dealer when reporting the problem.

### Playing a Compact Disc

**PREV (1):** Press this button to go to the start of the current track, if more than eight seconds have played. If you hold the button or press it more than once, the player will continue moving back through the disc to the previous track. The sound will mute while seeking.

**NEXT (2):** Press this button to go to the next track on the disc. If you hold the button or press it more than once, the player will continue moving forward through the disc to the next track. The sound will mute while seeking.

**◀◀ (3):** Press and hold this button to quickly reverse within a track. You will hear sound.

**▶▶ (4):** Press and hold this button to quickly advance within a track. You will hear sound.

**SIDE (5):** Press this button to select the next disc in the magazine. Each time you press SIDE, the disc number on the radio display will go to the next available CD. If a CD cannot be played, its number will be skipped when selecting discs while using the SIDE button.

**RAND (6):** Press this button to enter the random play mode. RAND will appear on the display. While in this mode, tracks and discs will be played in random order. Press the button again to turn off the random feature and return to normal operation.

**RECALL:** Press this button to see what track is currently playing. Press RECALL again within five seconds to see how long the track has been playing. EL TM will appear on the display when in elapsed time mode. When a new track starts to play, the track number will also appear. Press RECALL a third time and the time of day will be displayed.

**SOURCE:** Press this button to play a CD if you have a magazine loaded in the changer and the radio is playing. To return to the radio while a CD is playing, press AM-FM. You can also press this button to switch between a cassette tape, CD or the CD changer if all three are loaded.



## Personal Choice Radio Controls (If Equipped)

With this feature, your vehicle will recall the latest radio settings as adjusted the last time your vehicle was operated. This feature allows two different drivers to store and recall their own radio settings for AM and FM presets, last tuned station, volume, tone and audio source (radio, cassette or CD). The settings recalled by the radio are determined by which transmitter ("1" or "2") was used to enter the vehicle. The number on the back of the transmitter corresponds to driver 1 or to driver 2. After the UNLOCK button is pressed on the transmitter and the ignition is in RUN, the radio settings will automatically adjust to where they were last set by the identified driver. The settings can also be changed by briefly pressing one of the MEMORY seat buttons (1 or 2) located on the driver's door. When changes are made, the new settings will be saved for the driver.

## Theft-Deterrent Feature

THEFTLOCK™ is designed to discourage theft of your radio. It works by using a secret code to disable all radio functions whenever battery power is removed.

If THEFTLOCK is active, the THEFTLOCK indicator will flash when the ignition is off.

The THEFTLOCK feature for the radio may be used or ignored. If ignored, the system plays normally and the radio is not protected by the feature. If THEFTLOCK is activated, your radio will not operate if stolen.

When THEFTLOCK is activated, the radio will display LOC to indicate a locked condition anytime battery power is removed. If your battery loses power for any reason, you must unlock the radio with the secret code before it will operate.

### Activating the Theft-Deterrent Feature

The instructions which follow explain how to enter your secret code to activate the THEFTLOCK system. It is recommended that you read through all nine steps before starting the procedure.

**NOTE:** If you allow more than 15 seconds to elapse between any steps, the radio automatically reverts to time and you must start the procedure over at Step 4.

1. Write down any three or four-digit number from 000 to 1999 and keep it in a safe place separate from the vehicle.
2. Turn the ignition to ACCESSORY or RUN.
3. Turn the radio off.
4. Press the 1 and 4 buttons together. Hold them down until --- shows on the display. Next you will use the secret code number which you have written down.
5. Press MIN and 000 will appear on the display.
6. Press MIN again to make the last two digits agree with your code.
7. Press HRS to make the first one or two digits agree with your code.
8. Press AM-FM after you have confirmed that the code matches the secret code you have written down. The display will show REP to let you know that you need to repeat Steps 5 through 7 to confirm your secret code.
9. Press AM-FM and this time the display will show SEC to let you know that your radio is secure.

### Unlocking the Theft-Deterrent Feature After a Power Loss

Enter your secret code as follows; pause no more than 15 seconds between steps:

1. LOC appears when the ignition is on.
2. Press MIN and 000 will appear on the display.
3. Press MIN again to make the last two digits agree with your code.
4. Press HRS to make the first one or two digits agree with your code.
5. Press AM-FM after you have confirmed that the code matches the secret code you have written down. The display will show SEC, indicating the radio is now operable and secure.

If you enter the wrong code eight times, INOP will appear on the display. You will have to wait an hour with the ignition on before you can try again. When you try again, you will only have three more chances (eight tries per chance) to enter the correct code before INOP appears.

If you lose or forget your code, contact your dealer.

### Disabling the Theft-Deterrent Feature

Enter your secret code as follows; pause no more than 15 seconds between steps:

1. Turn the ignition to ACCESSORY or RUN.
2. Turn the radio off.
3. Press the 1 and 4 buttons together. Hold them down until SEC shows on the display.
4. Press MIN and 000 will appear on the display.
5. Press MIN again to make the last two digits agree with your code.
6. Press HRS to make the first one or two digits agree with your code.
7. Press AM-FM after you have confirmed that the code matches the secret code you have written down. The display will show ---, indicating that the radio is no longer secured.

If the code entered is incorrect, SEC will appear on the display. The radio will remain secured until the correct code is entered.

When battery power is removed and later applied to a secured radio, the radio won't turn on and LOC will appear on the display.



To unlock a secured radio see "Unlocking the Theft-Deterrent Feature After a Power Loss" earlier in this section.

### Audio Steering Wheel Controls (If Equipped)

If your vehicle has this feature, you can control certain radio functions using the buttons on your steering wheel.

Some steering wheel controls may operate climate controls. See "Steering Wheel Controls for Climate Control" earlier in this section.



**SEEK:** Press this button to go to the next higher or lower radio station.

**SCAN:** Press this button to scan the stations preset on your radio pushbuttons. This feature works like your radio's P SCAN button and allows you to listen to each of your preset stations for a few seconds. The radio will go to the first preset station, stop for a few seconds, then go on to the next preset station. Press SCAN again to stop scanning. If a preset station has weak reception, the radio will not stop at the preset station.

**AM-FM:** Press this button to choose AM, FM1 or FM2.

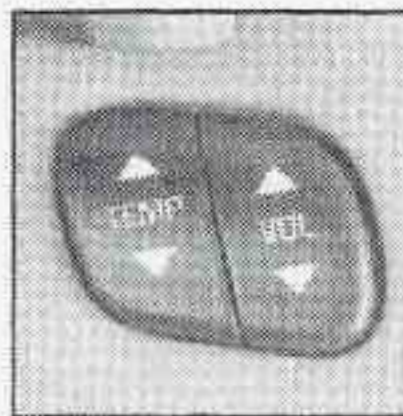

**VOL:** Press the up or down arrow to increase or decrease volume.

## Understanding Radio Reception

### AM

The range for most AM stations is greater than for FM, especially at night. The longer range, however, can cause stations to interfere with each other. AM can pick up noise from things like storms and power lines. Try reducing the treble to reduce this noise if you ever get it.

### FM Stereo

FM stereo will give you the best sound, but FM signals will reach only about 10 to 40 miles (16 to 65 km). Tall buildings or hills can interfere with FM signals, causing the sound to come and go.

### Tips About Your Audio System

Hearing damage from loud noise is almost undetectable until it is too late. Your hearing can adapt to higher volumes of sound. Sound that seems normal can be loud and harmful to your hearing. Take precautions by adjusting the volume control on your radio to a safe sound level before your hearing adapts to it.

To help avoid hearing loss or damage:

- Adjust the volume control to the lowest setting.
- Increase volume slowly until you hear comfortably and clearly.

### **NOTICE:**

**Before you add any sound equipment to your vehicle -- like a tape player, CB radio, mobile telephone or two-way radio -- be sure you can add what you want. If you can, it's very important to do it properly. Added sound equipment may interfere with the operation of your vehicle's engine, Delco Electronics radio or other systems, and even damage them. Your vehicle's systems may interfere with the operation of sound equipment that has been added improperly.**

**So, before adding sound equipment, check with your dealer and be sure to check Federal rules covering mobile radio and telephone units.**

## Care of Your Cassette Tape Player

A tape player that is not cleaned regularly can cause reduced sound quality, ruined cassettes or a damaged mechanism. Cassette tapes should be stored in their cases away from contaminants, direct sunlight and extreme heat. If they aren't, they may not operate properly or may cause failure of the tape player.

Your tape player should be cleaned regularly after every 50 hours of use. Your radio may display CLN to indicate that you have used your tape player for 50 hours without resetting the tape clean timer. If this message appears on the display, your cassette tape player needs to be cleaned. It will still play tapes, but you should clean it as soon as possible to prevent damage to your tapes and player. If you notice a reduction in sound quality, try a known good cassette to see if it is the tape or the tape player at fault. If this other cassette has no improvement in sound quality, clean the tape player.

Cleaning may be done with a scrubbing action, non-abrasive cleaning cassette with pads which scrub the tape head as the hubs of the cleaner cassette turn. A scrubbing action cleaning cassette is available through your dealership.

You may also choose a non-scrubbing action, wet-type cleaner which uses a cassette with a fabric belt to clean the tape head. This type of cleaning cassette may not clean as thoroughly as the scrubbing type cleaner.

After you clean the player, press and hold EJECT for five seconds to reset the CLN indicator. The radio will display --- to show the indicator was reset.

Cassettes are subject to wear and the sound quality may degrade over time. Always make sure the cassette tape is in good condition before you have your tape player serviced.



## Care of Your Compact Discs

Handle discs carefully. Store them in their original cases or other protective cases and away from direct sunlight and dust. If the surface of a disc is soiled, dampen a clean, soft cloth in a mild, neutral detergent solution and clean it, wiping from the center to the edge.

Be sure never to touch the signal surface when handling discs. Pick up discs by grasping the outer edges or the edge of the hole and the outer edge.

## Care of Your Compact Disc Player

The use of CD lens cleaner discs is not advised, due to the risk of contaminating the lens of the CD optics with lubricants internal to the CD mechanism.

## Heated Backlite Antenna

Your AM-FM antenna is integrated with your rear window defogger, located in the rear window. Be sure that the inside surface of the rear window is not scratched and that the lines on the glass are not damaged. If the inside surface is damaged, it could interfere with radio reception. Do not apply aftermarket glass tinting. The metallic film in some tinting materials will interfere with or distort the incoming radio reception.

## NOTICE:

**Do not try to clear frost or other material from the inside of the rear window with a razor blade or anything else that is sharp. This may damage the rear defogger grid and affect your radio's ability to pick up stations clearly. The repairs wouldn't be covered by your warranty.**

If, when you turn on your rear window defogger, you hear static on your radio station, it means a defogger grid line has been damaged and must be repaired. (Your radio is not at fault.)

If you choose to add a cellular telephone to your vehicle, and the antenna needs to be attached to the glass, be sure that you do not damage the grid lines for the AM-FM antenna.

## NOTES

---

---

---

---

---

---

---

---

---

---

---

---

---

---

---

---

---

---

---

---

---

---

---

---

## NOTES





## Section 4 Your Driving and the Road

---

Here you'll find information about driving on different kinds of roads and in varying weather conditions. We've also included many other useful tips on driving.

- |      |                      |      |                                  |
|------|----------------------|------|----------------------------------|
| 4-2  | Defensive Driving    | 4-18 | Driving in Rain and on Wet Roads |
| 4-3  | Drunken Driving      | 4-20 | City Driving                     |
| 4-5  | Control of a Vehicle | 4-21 | Freeway Driving                  |
| 4-6  | Braking              | 4-23 | Before Leaving on a Long Trip    |
| 4-10 | Steering             | 4-24 | Highway Hypnosis                 |
| 4-13 | Off-Road Recovery    | 4-24 | Hill and Mountain Roads          |
| 4-13 | Passing              | 4-26 | Winter Driving                   |
| 4-15 | Loss of Control      | 4-30 | Loading Your Vehicle             |
| 4-16 | Driving at Night     | 4-32 | Towing a Trailer                 |



## Defensive Driving

The best advice anyone can give about driving is:  
Drive defensively.

Please start with a very important safety device in your Buick: Buckle up. (See "Safety Belts" in the Index.)

Defensive driving really means "be ready for anything." On city streets, rural roads or freeways, it means "always expect the unexpected."

Assume that pedestrians or other drivers are going to be careless and make mistakes. Anticipate what they might do. Be ready for their mistakes.

Rear-end collisions are about the most preventable of accidents. Yet they are common. Allow enough following distance. It's the best defensive driving maneuver, in both city and rural driving. You never know when the vehicle in front of you is going to brake or turn suddenly.

Defensive driving requires that a driver concentrate on the driving task. Anything that distracts from the driving task -- such as concentrating on a cellular telephone call, reading, or reaching for something on the floor -- makes proper defensive driving more difficult and can even cause a collision, with resulting injury. Ask a passenger to help do things like this, or pull off the road in a safe place to do them yourself. These simple defensive driving techniques could save your life.

## Drunken Driving

Death and injury associated with drinking and driving is a national tragedy. It's the number one contributor to the highway death toll, claiming thousands of victims every year.

Alcohol affects four things that anyone needs to drive a vehicle:

- Judgment
- Muscular Coordination
- Vision
- Attentiveness.

Police records show that almost half of all motor vehicle-related deaths involve alcohol. In most cases, these deaths are the result of someone who was drinking and driving. In recent years, over 17,000 annual motor vehicle-related deaths have been associated with the use of alcohol, with more than 300,000 people injured.

Many adults -- by some estimates, nearly half the adult population -- choose never to drink alcohol, so they never drive after drinking. For persons under 21, it's against the law in every U.S. state to drink alcohol. There are good medical, psychological and developmental reasons for these laws.

The obvious way to solve this highway safety problem is for people never to drink alcohol and then drive. But what if people do? How much is "too much" if the driver plans to drive? It's a lot less than many might think. Although it depends on each person and situation, here is some general information on the problem.

The Blood Alcohol Concentration (BAC) of someone who is drinking depends upon four things:

- The amount of alcohol consumed
- The drinker's body weight
- The amount of food that is consumed before and during drinking
- The length of time it has taken the drinker to consume the alcohol.

According to the American Medical Association, a 180-lb. (82 kg) person who drinks three 12-ounce (355 ml) bottles of beer in an hour will end up with a BAC of about 0.06 percent. The person would reach the same BAC by drinking three 4-ounce (120 ml) glasses of wine or three mixed drinks if each had 1-1/2 ounces (45 ml) of a liquor like whiskey, gin or vodka.



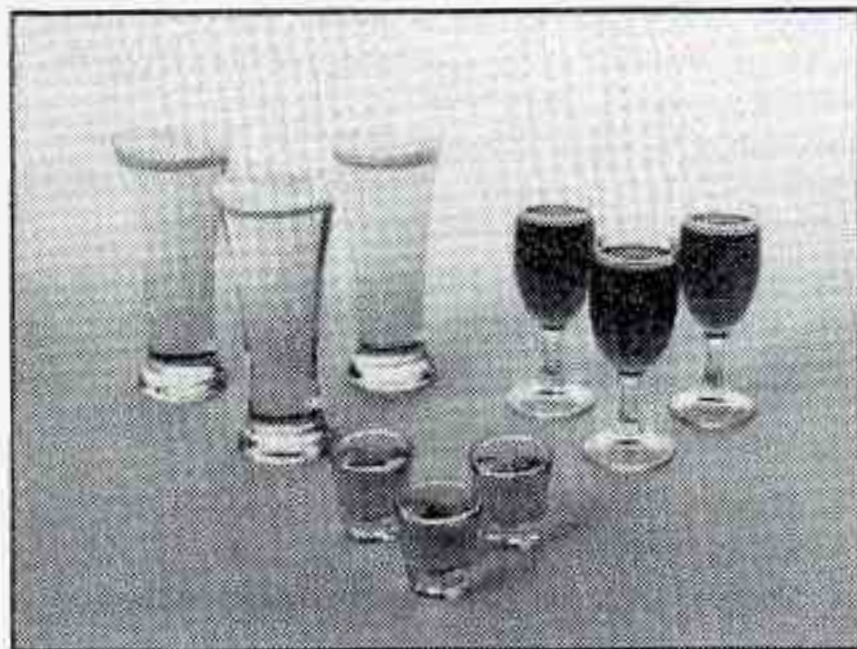

It's the amount of alcohol that counts. For example, if the same person drank three double martinis (3 ounces or 90 ml of liquor each) within an hour, the person's BAC would be close to 0.12 percent. A person who consumes food just before or during drinking will have a somewhat lower BAC level.

There is a gender difference, too. Women generally have a lower relative percentage of body water than men.

Since alcohol is carried in body water, this means that a woman generally will reach a higher BAC level than a man of her same body weight when each has the same number of drinks.

The law in many U.S. states sets the legal limit at a BAC of 0.10 percent. In a growing number of U.S. states, and throughout Canada, the limit is 0.08 percent. In some other countries, it's even lower. The BAC limit for all commercial drivers in the United States is 0.04 percent.

The BAC will be over 0.10 percent after three to six drinks (in one hour). Of course, as we've seen, it depends on how much alcohol is in the drinks, and how quickly the person drinks them.

But the ability to drive is affected well below a BAC of 0.10 percent. Research shows that the driving skills of many people are impaired at a BAC approaching 0.05 percent, and that the effects are worse at night. All drivers are impaired at BAC levels above 0.05 percent. Statistics show that the chance of being in a collision increases sharply for drivers who have a BAC of 0.05 percent or above. A driver with a BAC level of 0.06 percent has doubled his or her chance of having a collision. At a BAC level of 0.10 percent, the chance of this driver having a collision is 12 times greater; at a level of 0.15 percent, the chance is 25 times greater!

The body takes about an hour to rid itself of the alcohol in one drink. No amount of coffee or number of cold showers will speed that up. "I'll be careful" isn't the right answer. What if there's an emergency, a need to take sudden action, as when a child darts into the street? A person with even a moderate BAC might not be able to react quickly enough to avoid the collision.

There's something else about drinking and driving that many people don't know. Medical research shows that alcohol in a person's system can make crash injuries worse, especially injuries to the brain, spinal cord or heart. This means that when anyone who has been drinking -- driver or passenger -- is in a crash, that person's chance of being killed or permanently disabled is higher than if the person had not been drinking.



## CAUTION:

**Drinking and then driving is very dangerous. Your reflexes, perceptions, attentiveness and judgment can be affected by even a small amount of alcohol. You can have a serious -- or even fatal -- collision if you drive after drinking. Please don't drink and drive or ride with a driver who has been drinking. Ride home in a cab; or if you're with a group, designate a driver who will not drink.**

## Control of a Vehicle

You have three systems that make your vehicle go where you want it to go. They are the brakes, the steering and the accelerator. All three systems have to do their work at the places where the tires meet the road.



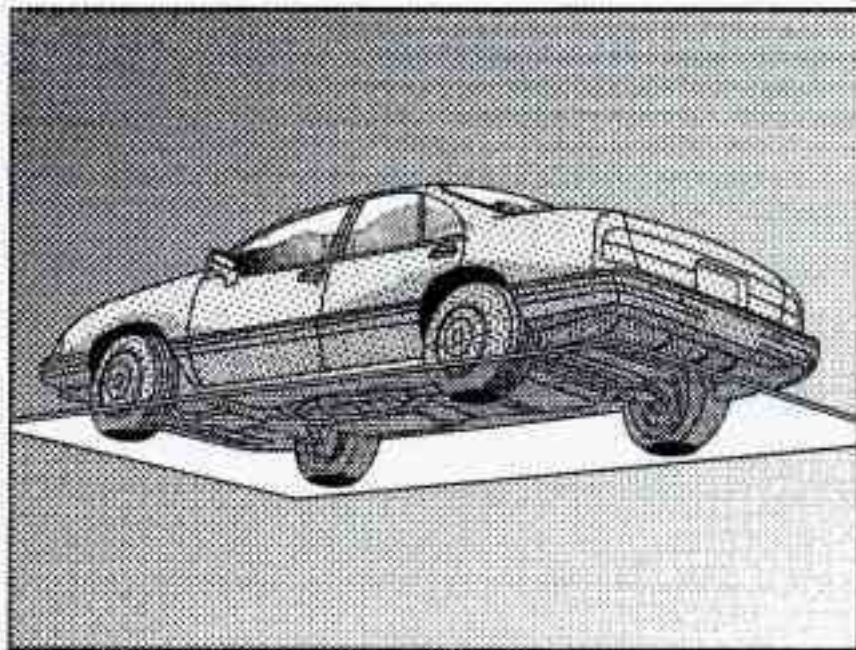

Sometimes, as when you're driving on snow or ice, it's easy to ask more of those control systems than the tires and road can provide. That means you can lose control of your vehicle.

## Braking

Braking action involves *perception time* and *reaction time*.

First, you have to decide to push on the brake pedal. That's *perception time*. Then you have to bring up your foot and do it. That's *reaction time*.

Average *reaction time* is about  $3/4$  of a second. But that's only an average. It might be less with one driver and as long as two or three seconds or more with another. Age, physical condition, alertness, coordination and eyesight all play a part. So do alcohol, drugs and frustration. But even in  $3/4$  of a second, a vehicle moving at 60 mph (100 km/h) travels 66 feet (20 m). That could be a lot of distance in an emergency, so keeping enough space between your vehicle and others is important.

And, of course, actual stopping distances vary greatly with the surface of the road (whether it's pavement or gravel); the condition of the road (wet, dry, icy); tire tread; the condition of your brakes; the weight of the vehicle and the amount of brake force applied.



Avoid needless heavy braking. Some people drive in spurts -- heavy acceleration followed by heavy braking -- rather than keeping pace with traffic. This is a mistake. Your brakes may not have time to cool between hard stops. Your brakes will wear out much faster if you do a lot of heavy braking. If you keep pace with the traffic and allow realistic following distances, you will eliminate a lot of unnecessary braking. That means better braking and longer brake life.

If your engine ever stops while you're driving, brake normally but don't pump your brakes. If you do, the pedal may get harder to push down. If your engine stops, you will still have some power brake assist. But you will use it when you brake. Once the power assist is used up, it may take longer to stop and the brake pedal will be harder to push.

## Anti-Lock Brakes

Your vehicle has anti-lock brakes (ABS). ABS is an advanced electronic braking system that will help prevent a braking skid.

When you start your engine, or when you begin to drive away, your anti-lock brake system will check itself. You may hear a momentary motor or clicking noise while this test is going on, and you may even notice that your brake pedal moves or pulses a little. This is normal.

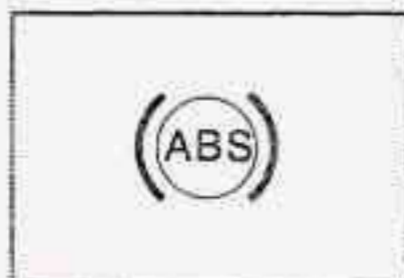

If there's a problem with the anti-lock brake system, this warning light will stay on. See "Anti-Lock Brake System Warning Light" in the Index.

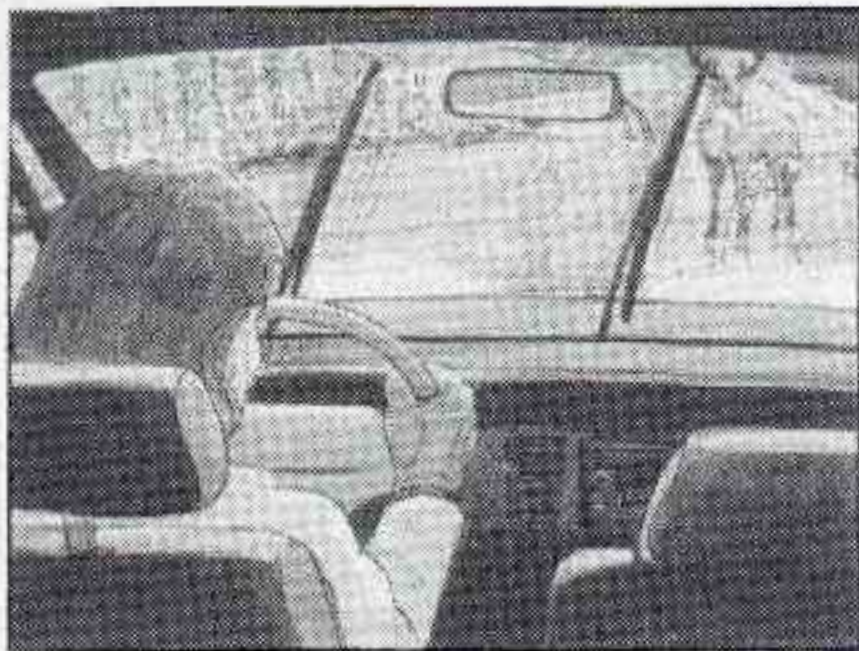

Here's how anti-lock works. Let's say the road is wet. You're driving safely. Suddenly an animal jumps out in front of you.

You slam on the brakes. Here's what happens with ABS.

A computer senses that wheels are slowing down. If one of the wheels is about to stop rolling, the computer will separately work the brakes at each front wheel and at both rear wheels.

The anti-lock system can change the brake pressure faster than any driver could. The computer is programmed to make the most of available tire and road conditions.

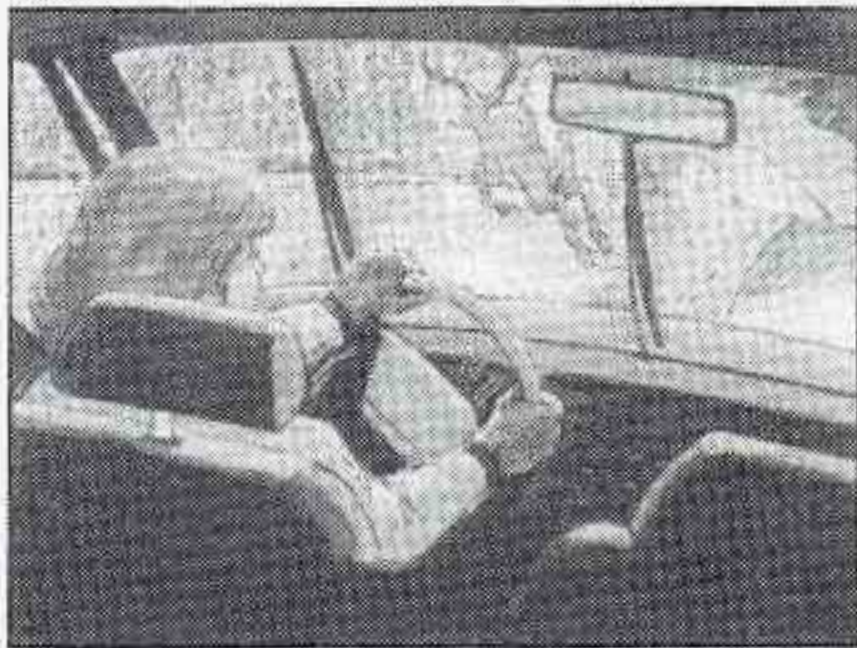

You can steer around the obstacle while braking hard.

As you brake, your computer keeps receiving updates on wheel speed and controls braking pressure accordingly.



Remember: Anti-lock doesn't change the time you need to get your foot up to the brake pedal or always decrease stopping distance. If you get too close to the vehicle in front of you, you won't have time to apply your brakes if that vehicle suddenly slows or stops. Always leave enough room up ahead to stop, even though you have anti-lock brakes.

### Using Anti-Lock

Don't pump the brakes. Just hold the brake pedal down firmly and let anti-lock work for you. You may feel a slight brake pedal pulsation or notice some noise, but this is normal.

### Traction Control System (If Equipped)

Your vehicle may have a traction control system that limits wheel spin. This is especially useful in slippery road conditions. The system operates only if it senses that one or both of the front wheels are spinning or beginning to lose traction. When this happens, the system works the front brakes and reduces engine power to limit wheel spin.

You may feel or hear the system working, but this is normal.

If your vehicle is in cruise control when the traction control system begins to limit wheel spin, the cruise control will automatically disengage. When road conditions allow you to safely use it again, you may reengage the cruise control. (See "Cruise Control" in the Index.)



This light should come on briefly when you start the engine. If it stays on or comes on while you are driving, there's a problem with your traction control system.

See "Traction Control System Warning Light" in the Index. When this warning light is on, the system will not limit wheel spin. Adjust your driving accordingly.

The traction control system automatically comes on whenever you start your vehicle. To limit wheel spin, especially in slippery road conditions, you should always leave the system on. But you can turn the traction control system off if you ever need to. (You should turn the system off if your vehicle ever gets stuck in sand, mud, ice or snow. See "Rocking Your Vehicle" in the Index.)





To turn the system off, press the button located at the end of the shift lever.

The traction control system warning light will come on and stay on. If the system is limiting wheel spin when you press the button, the warning light will come on -- but the system won't turn off right away. It will wait until there's no longer a current need to limit wheel spin.

You can turn the system back on at any time by pressing the button again. The traction control system warning light should go off.

## Braking in Emergencies

With anti-lock, you can steer and brake at the same time. In many emergencies, steering can help you more than even the very best braking.

## Steering

### Power Steering

If you lose power steering assist because the engine stops or the system is not functioning, you can steer but it will take much more effort.

### Magnasteer (If Equipped)

Your vehicle may be equipped with GM Magnasteer™, a steering system that continuously adjusts the effort you feel when steering at all vehicle speeds. It provides ease when parking yet a firm, solid feel at highway speeds. Your steering can be adjusted for an easier or more firm setting. See your dealer for information.

## Steering Tips

### Driving on Curves

It's important to take curves at a reasonable speed.

A lot of the "driver lost control" accidents mentioned on the news happen on curves. Here's why:

Experienced driver or beginner, each of us is subject to the same laws of physics when driving on curves. The traction of the tires against the road surface makes it possible for the vehicle to change its path when you turn the front wheels. If there's no traction, inertia will keep the vehicle going in the same direction. If you've ever tried to steer a vehicle on wet ice, you'll understand this.

The traction you can get in a curve depends on the condition of your tires and the road surface, the angle at which the curve is banked, and your speed. While you're in a curve, speed is the one factor you can control.

Suppose you're steering through a sharp curve. Then you suddenly accelerate. Both control

systems -- steering and acceleration -- have to do their work where the tires meet the road. Adding the sudden acceleration can demand too much of those places. You can lose control. Refer to "Traction Control" in the Index.

What should you do if this ever happens? Ease up on the accelerator pedal, steer the vehicle the way you want it to go, and slow down.

Speed limit signs near curves warn that you should adjust your speed. Of course, the posted speeds are based on good weather and road conditions. Under less favorable conditions you'll want to go slower.

If you need to reduce your speed as you approach a curve, do it before you enter the curve, while your front wheels are straight ahead.

Try to adjust your speed so you can "drive" through the curve. Maintain a reasonable, steady speed. Wait to accelerate until you are out of the curve, and then accelerate gently into the straightaway.

## Steering in Emergencies

There are times when steering can be more effective than braking. For example, you come over a hill and find a truck stopped in your lane, or a car suddenly pulls out from nowhere, or a child darts out from between parked cars and stops right in front of you. You can avoid these problems by braking -- if you can stop in time. But sometimes you can't; there isn't room. That's the time for evasive action -- steering around the problem.

Your vehicle can perform very well in emergencies like these. First apply your brakes. (See "Braking in Emergencies" earlier in this section.) It is better to remove as much speed as you can from a possible collision. Then steer around the problem, to the left or right depending on the space available.



An emergency like this requires close attention and a quick decision. If you are holding the steering wheel at the recommended 9 and 3 o'clock positions, you can turn it a full 180 degrees very quickly without removing either hand. But you have to act fast, steer quickly, and just as quickly straighten the wheel once you have avoided the object.

The fact that such emergency situations are always possible is a good reason to practice defensive driving at all times and wear safety belts properly.



## Off-Road Recovery

You may find that your right wheels have dropped off the edge of a road onto the shoulder while you're driving.

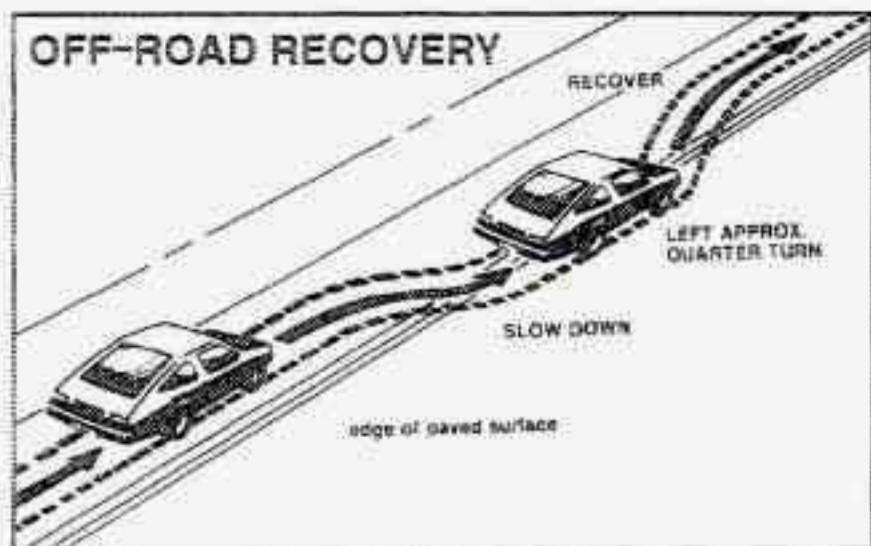

If the level of the shoulder is only slightly below the pavement, recovery should be fairly easy. Ease off the accelerator and then, if there is nothing in the way, steer so that your vehicle straddles the edge of the pavement. You can turn the steering wheel up to one-quarter turn until the right front tire contacts the pavement edge. Then turn your steering wheel to go straight down the roadway.

## Passing

The driver of a vehicle about to pass another on a two-lane highway waits for just the right moment, accelerates, moves around the vehicle ahead, then goes back into the right lane again. A simple maneuver?

Not necessarily! Passing another vehicle on a two-lane highway is a potentially dangerous move, since the passing vehicle occupies the same lane as oncoming traffic for several seconds. A miscalculation, an error in judgment, or a brief surrender to frustration or anger can suddenly put the passing driver face to face with the worst of all traffic accidents -- the head-on collision.

So here are some tips for passing:

- "Drive ahead." Look down the road, to the sides and to crossroads for situations that might affect your passing patterns. If you have any doubt whatsoever about making a successful pass, wait for a better time.
- Watch for traffic signs, pavement markings and lines. If you can see a sign up ahead that might indicate a turn or an intersection, delay your pass. A broken center line usually indicates it's all right to pass (providing the road ahead is clear). Never cross a solid line on your side of the lane or a double solid line, even if the road seems empty of approaching traffic.

- Do not get too close to the vehicle you want to pass while you're awaiting an opportunity. For one thing, following too closely reduces your area of vision, especially if you're following a larger vehicle. Also, you won't have adequate space if the vehicle ahead suddenly slows or stops. Keep back a reasonable distance.
- When it looks like a chance to pass is coming up, start to accelerate but stay in the right lane and don't get too close. Time your move so you will be increasing speed as the time comes to move into the other lane. If the way is clear to pass, you will have a "running start" that more than makes up for the distance you would lose by dropping back. And if something happens to cause you to cancel your pass, you need only slow down and drop back again and wait for another opportunity.
- If other cars are lined up to pass a slow vehicle, wait your turn. But take care that someone isn't trying to pass you as you pull out to pass the slow vehicle. Remember to glance over your shoulder and check the blind spot.
- Check your mirrors, glance over your shoulder, and start your left lane change signal before moving out of the right lane to pass. When you are far enough ahead of the passed vehicle to see its front in your inside mirror, activate your right lane change signal and move back into the right lane. (Remember that your right outside mirror is convex. The vehicle you just passed may seem to be farther away from you than it really is.)
- Try not to pass more than one vehicle at a time on two-lane roads. Reconsider before passing the next vehicle.
- Don't overtake a slowly moving vehicle too rapidly. Even though the brake lamps are not flashing, it may be slowing down or starting to turn.
- If you're being passed, make it easy for the following driver to get ahead of you. Perhaps you can ease a little to the right.

## Loss of Control

Let's review what driving experts say about what happens when the three control systems (brakes, steering and acceleration) don't have enough friction where the tires meet the road to do what the driver has asked.

In any emergency, don't give up. Keep trying to steer and constantly seek an escape route or area of less danger.

### Skidding

In a skid, a driver can lose control of the vehicle. Defensive drivers avoid most skids by taking reasonable care suited to existing conditions, and by not "overdriving" those conditions. But skids are always possible.

The three types of skids correspond to your vehicle's three control systems. In the braking skid, your wheels aren't rolling. In the steering or cornering skid, too much speed or steering in a curve causes tires to slip and lose cornering force. And in the acceleration skid, too much throttle causes the driving wheels to spin.

A cornering skid is best handled by easing your foot off the accelerator pedal.

If you have the traction control system, remember: It helps avoid only the acceleration skid.

If you do not have traction control, or if the system is off, then an acceleration skid is also best handled by easing your foot off the accelerator pedal.

If your vehicle starts to slide, ease your foot off the accelerator pedal and quickly steer the way you want the vehicle to go. If you start steering quickly enough, your vehicle may straighten out. Always be ready for a second skid if it occurs.

Of course, traction is reduced when water, snow, ice, gravel or other material is on the road. For safety, you'll want to slow down and adjust your driving to these conditions. It is important to slow down on slippery surfaces because stopping distance will be longer and vehicle control more limited.

While driving on a surface with reduced traction, try your best to avoid sudden steering, acceleration or braking (including engine braking by shifting to a lower gear). Any sudden changes could cause the tires to slide. You may not realize the surface is slippery until your vehicle is skidding. Learn to recognize warning clues -- such as enough water, ice or packed snow on the road to make a "mirrored surface" -- and slow down when you have any doubt.

Remember: Any anti-lock brake system (ABS) helps avoid only the braking skid.



## Driving at Night

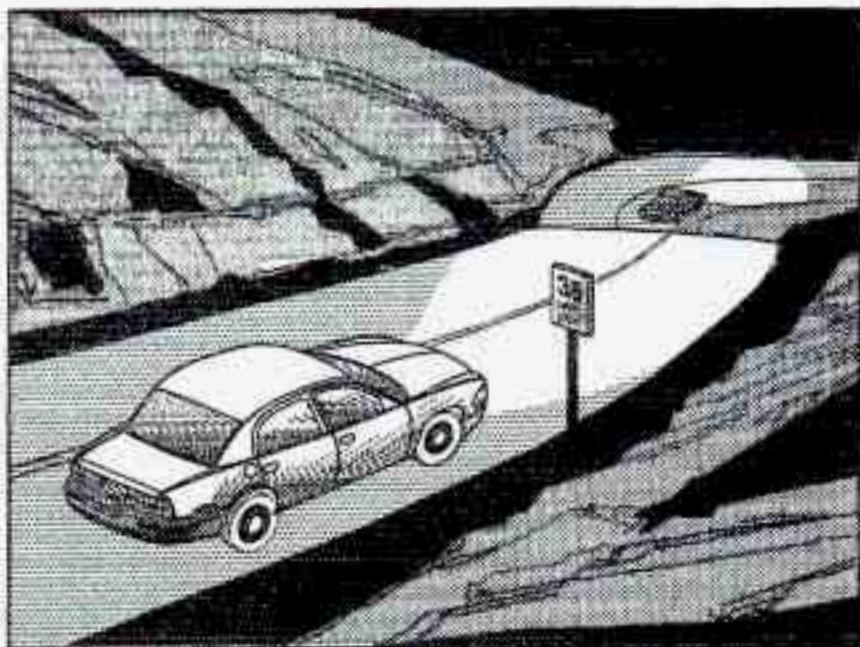

Night driving is more dangerous than day driving. One reason is that some drivers are likely to be impaired -- by alcohol or drugs, with night vision problems, or by fatigue.

Here are some tips on night driving.

- Drive defensively.
- Don't drink and drive.
- Adjust your inside rearview mirror to reduce the glare from headlamps behind you.
- Since you can't see as well, you may need to slow down and keep more space between you and other vehicles.
- Slow down, especially on higher speed roads. Your headlamps can light up only so much road ahead.
- In remote areas, watch for animals.
- If you're tired, pull off the road in a safe place and rest.

## Night Vision

No one can see as well at night as in the daytime. But as we get older these differences increase. A 50-year-old driver may require at least twice as much light to see the same thing at night as a 20-year-old.

What you do in the daytime can also affect your night vision. For example, if you spend the day in bright sunshine you are wise to wear sunglasses. Your eyes will have less trouble adjusting to night. But if you're driving, don't wear sunglasses at night. They may cut down on glare from headlamps, but they also make a lot of things invisible.

You can be temporarily blinded by approaching headlamps. It can take a second or two, or even several seconds, for your eyes to readjust to the dark. When you are faced with severe glare (as from a driver who doesn't lower the high beams, or a vehicle with misaimed headlamps), slow down a little. Avoid staring directly into the approaching headlamps.

Keep your windshield and all the glass on your vehicle clean -- inside and out. Glare at night is made much worse by dirt on the glass. Even the inside of the glass can build up a film caused by dust. Dirty glass makes lights dazzle and flash more than clean glass would, making the pupils of your eyes contract repeatedly.

Remember that your headlamps light up far less of a roadway when you are in a turn or curve. Keep your eyes moving; that way, it's easier to pick out dimly lighted objects. Just as your headlamps should be checked regularly for proper aim, so should your eyes be examined regularly. Some drivers suffer from night blindness -- the inability to see in dim light -- and aren't even aware of it.

## Driving in Rain and on Wet Roads

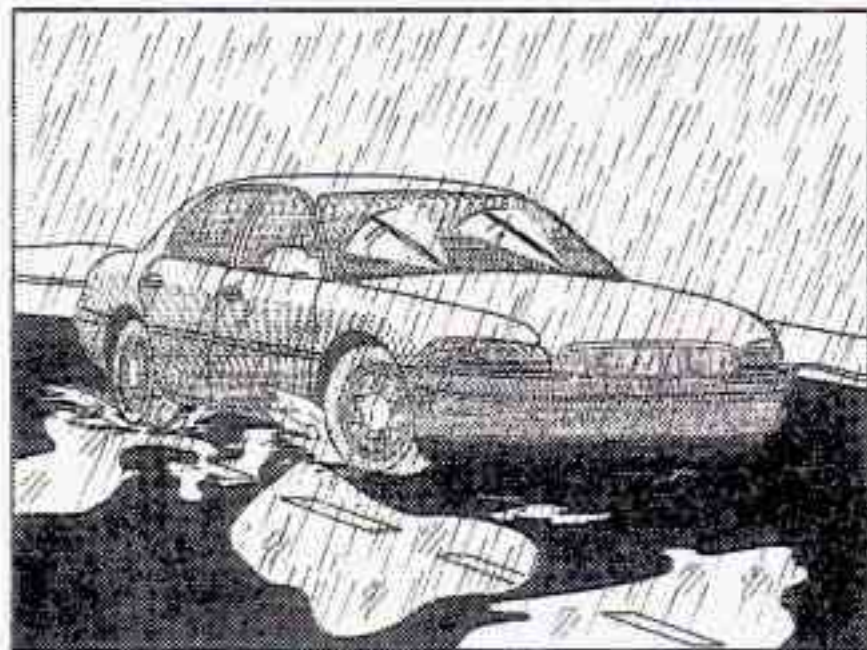

Rain and wet roads can mean driving trouble. On a wet road, you can't stop, accelerate or turn as well because your tire-to-road traction isn't as good as on dry roads. And, if your tires don't have much tread left, you'll get even less traction. It's always wise to go slower and be cautious if rain starts to fall while you are driving. The surface may get wet suddenly when your reflexes are tuned for driving on dry pavement.

The heavier the rain, the harder it is to see. Even if your windshield wiper blades are in good shape, a heavy rain can make it harder to see road signs and traffic signals, pavement markings, the edge of the road and even people walking.

It's wise to keep your windshield wiping equipment in good shape and keep your windshield washer tank filled with washer fluid. Replace your windshield wiper inserts when they show signs of streaking or missing areas on the windshield, or when strips of rubber start to separate from the inserts.



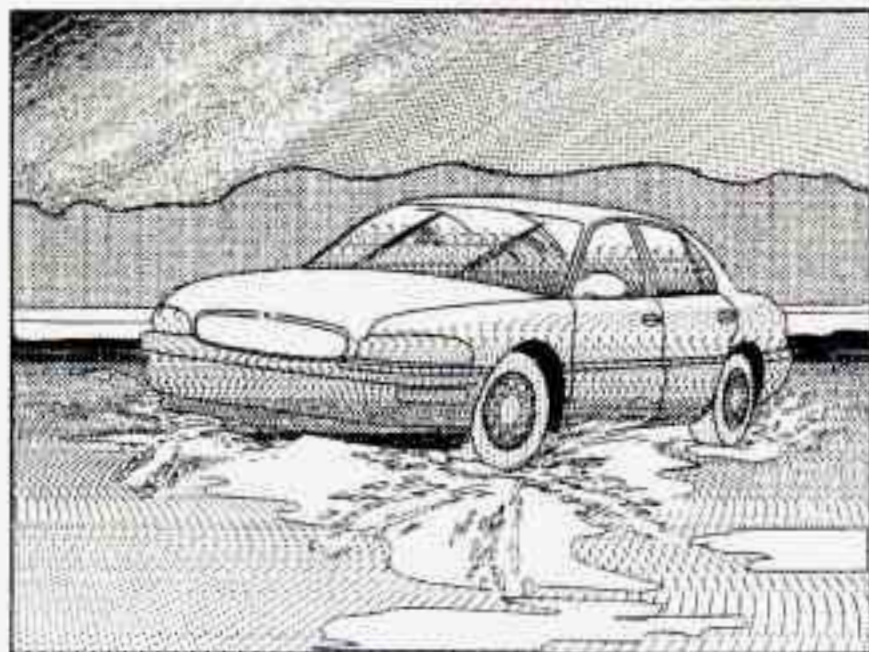

Driving too fast through large water puddles or even going through some car washes can cause problems, too. The water may affect your brakes. Try to avoid puddles. But if you can't, try to slow down before you hit them.



## CAUTION:

**Wet brakes can cause accidents. They won't work as well in a quick stop and may cause pulling to one side. You could lose control of the vehicle.**

**After driving through a large puddle of water or a car wash, apply your brake pedal lightly until your brakes work normally.**

### Hydroplaning

Hydroplaning is dangerous. So much water can build up under your tires that they can actually ride on the water. This can happen if the road is wet enough and you're going fast enough. When your vehicle is hydroplaning, it has little or no contact with the road.

Hydroplaning doesn't happen often. But it can if your tires do not have much tread or if the pressure in one or more is low. It can happen if a lot of water is standing on the road. If you can see reflections from trees, telephone poles or other vehicles, and raindrops "dimple" the water's surface, there could be hydroplaning.

Hydroplaning usually happens at higher speeds. There just isn't a hard and fast rule about hydroplaning. The best advice is to slow down when it is raining.

### Driving Through Deep Standing Water

#### **NOTICE:**

**If you drive too quickly through deep puddles or standing water, water can come in through your engine's air intake and badly damage your engine. Never drive through water that is slightly lower than the underbody of your vehicle. If you can't avoid deep puddles or standing water, drive through them very slowly.**

### Some Other Rainy Weather Tips

- Besides slowing down, allow some extra following distance. And be especially careful when you pass another vehicle. Allow yourself more clear room ahead, and be prepared to have your view restricted by road spray.
- Have good tires with proper tread depth. (See "Tires" in the Index.)

### City Driving



One of the biggest problems with city streets is the amount of traffic on them. You'll want to watch out for what the other drivers are doing and pay attention to traffic signals.



Here are ways to increase your safety in city driving:

- Know the best way to get to where you are going. Get a city map and plan your trip into an unknown part of the city just as you would for a cross-country trip.
- Try to use the freeways that rim and crisscross most large cities. You'll save time and energy. (See the next part, "Freeway Driving.")
- Treat a green light as a warning signal. A traffic light is there because the corner is busy enough to need it. When a light turns green, and just before you start to move, check both ways for vehicles that have not cleared the intersection or may be running the red light.

## Freeway Driving

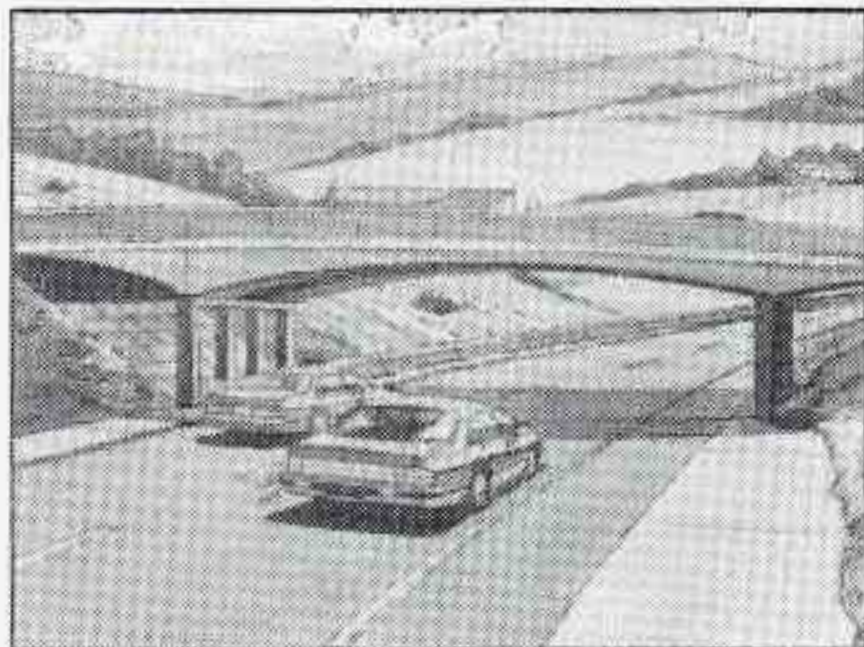

Mile for mile, freeways (also called thruways, parkways, expressways, turnpikes or superhighways) are the safest of all roads. But they have their own special rules.

The most important advice on freeway driving is: Keep up with traffic and keep to the right. Drive at the same speed most of the other drivers are driving. Too-fast or too-slow driving breaks a smooth traffic flow. Treat the left lane on a freeway as a passing lane.



At the entrance, there is usually a ramp that leads to the freeway. If you have a clear view of the freeway as you drive along the entrance ramp, you should begin to check traffic. Try to determine where you expect to blend with the flow. Try to merge into the gap at close to the prevailing speed. Switch on your turn signal, check your mirrors and glance over your shoulder as often as necessary. Try to blend smoothly with the traffic flow.

Once you are on the freeway, adjust your speed to the posted limit or to the prevailing rate if it's slower. Stay in the right lane unless you want to pass.

Before changing lanes, check your mirrors. Then use your turn signal.

Just before you leave the lane, glance quickly over your shoulder to make sure there isn't another vehicle in your "blind" spot.

Once you are moving on the freeway, make certain you allow a reasonable following distance. Expect to move slightly slower at night.

When you want to leave the freeway, move to the proper lane well in advance. If you miss your exit, do not, under any circumstances, stop and back up. Drive on to the next exit.

The exit ramp can be curved, sometimes quite sharply.

The exit speed is usually posted.

Reduce your speed according to your speedometer, not to your sense of motion. After driving for any distance at higher speeds, you may tend to think you are going slower than you actually are.

## Before Leaving on a Long Trip

Make sure you're ready. Try to be well rested. If you must start when you're not fresh -- such as after a day's work -- don't plan to make too many miles that first part of the journey. Wear comfortable clothing and shoes you can easily drive in.

Is your vehicle ready for a long trip? If you keep it serviced and maintained, it's ready to go. If it needs service, have it done before starting out. Of course, you'll find experienced and able service experts in Buick dealerships all across North America. They'll be ready and willing to help if you need it.

Here are some things you can check before a trip:

- *Windshield Washer Fluid:* Is the reservoir full? Are all windows clean inside and outside?
- *Wiper Blades:* Are they in good shape?

- *Fuel, Engine Oil, Other Fluids:* Have you checked all levels?
- *Lamps:* Are they all working? Are the lenses clean?
- *Tires:* They are vitally important to a safe, trouble-free trip. Is the tread good enough for long-distance driving? Are the tires all inflated to the recommended pressure?
- *Weather Forecasts:* What's the weather outlook along your route? Should you delay your trip a short time to avoid a major storm system?
- *Maps:* Do you have up-to-date maps?

## Highway Hypnosis

Is there actually such a condition as “highway hypnosis”? Or is it just plain falling asleep at the wheel? Call it highway hypnosis, lack of awareness, or whatever.

There is something about an easy stretch of road with the same scenery, along with the hum of the tires on the road, the drone of the engine, and the rush of the wind against the vehicle that can make you sleepy. Don't let it happen to you! If it does, your vehicle can leave the road in *less than a second*, and you could crash and be injured.

What can you do about highway hypnosis? First, be aware that it can happen.

Then here are some tips:

- Make sure your vehicle is well ventilated, with a comfortably cool interior.
- Keep your eyes moving. Scan the road ahead and to the sides. Check your rearview mirrors and your instruments frequently.
- If you get sleepy, pull off the road into a rest, service or parking area and take a nap, get some exercise, or both. For safety, treat drowsiness on the highway as an emergency.

## Hill and Mountain Roads



Driving on steep hills or mountains is different from driving in flat or rolling terrain.



If you drive regularly in steep country, or if you're planning to visit there, here are some tips that can make your trips safer and more enjoyable.

- Keep your vehicle in good shape. Check all fluid levels and also the brakes, tires, cooling system and transaxle. These parts can work hard on mountain roads.
- Know how to go down hills. The most important thing to know is this: let your engine do some of the slowing down. Shift to a lower gear when you go down a steep or long hill.

 **CAUTION:**

**If you don't shift down, your brakes could get so hot that they wouldn't work well. You would then have poor braking or even none going down a hill. You could crash. Shift down to let your engine assist your brakes on a steep downhill slope.**

 **CAUTION:**

**Coasting downhill in NEUTRAL (N) or with the ignition off is dangerous. Your brakes will have to do all the work of slowing down. They could get so hot that they wouldn't work well. You would then have poor braking or even none going down a hill. You could crash. Always have your engine running and your vehicle in gear when you go downhill.**

- Know how to go uphill. Drive in the highest gear possible.
- Stay in your own lane when driving on two-lane roads in hills or mountains. Don't swing wide or cut across the center of the road. Drive at speeds that let you stay in your own lane.
- As you go over the top of a hill, be alert. There could be something in your lane, like a stalled car or an accident.
- You may see highway signs on mountains that warn of special problems. Examples are long grades, passing or no-passing zones, a falling rocks area or winding roads. Be alert to these and take appropriate action.

## Winter Driving

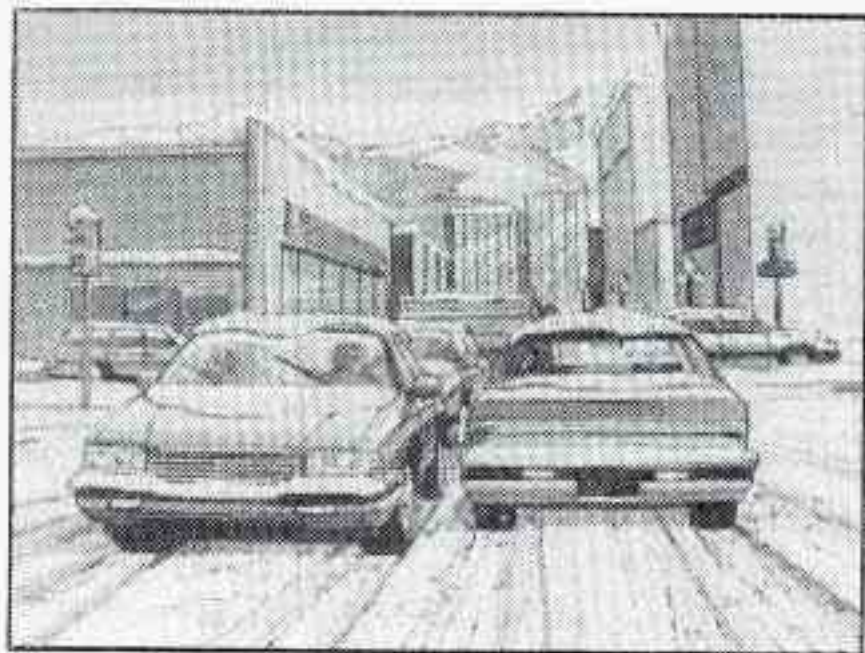

Here are some tips for winter driving:

- Have your vehicle in good shape for winter.
- You may want to put winter emergency supplies in your trunk.

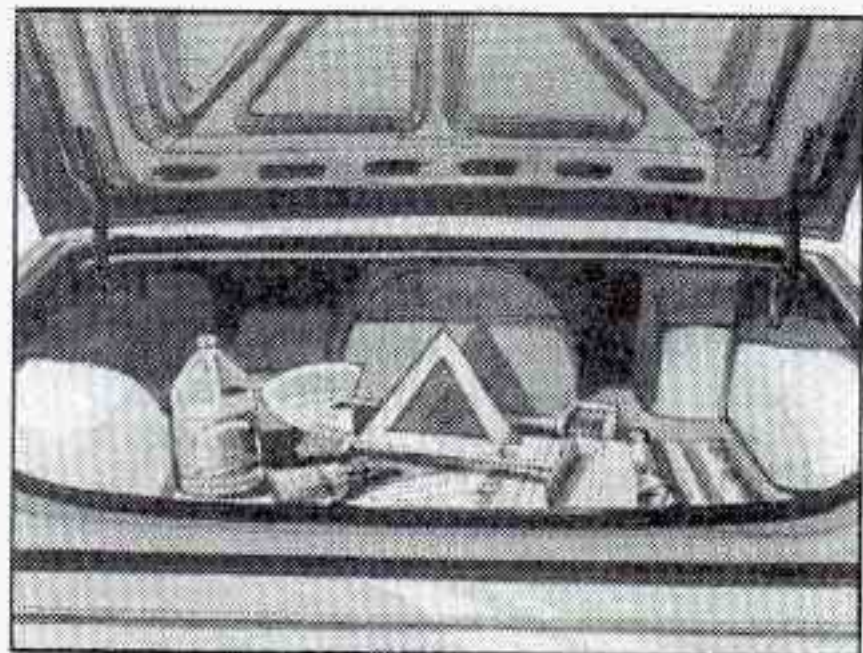

Include an ice scraper, a small brush or broom, a supply of windshield washer fluid, a rag, some winter outer clothing, a small shovel, a flashlight, a red cloth and a couple of reflective warning triangles. And, if you will be driving under severe conditions, include a small bag of sand, a piece of old carpet or a couple of burlap bags to help provide traction. Be sure you properly secure these items in your vehicle.



## Driving on Snow or Ice

Most of the time, those places where your tires meet the road probably have good traction.

However, if there is snow or ice between your tires and the road, you can have a very slippery situation. You'll have a lot less traction or "grip" and will need to be very careful.



What's the worst time for this? "Wet ice." Very cold snow or ice can be slick and hard to drive on. But wet ice can be even more trouble because it may offer the least traction of all. You can get wet ice when it's about freezing (32°F; 0°C) and freezing rain begins to fall. Try to avoid driving on wet ice until salt and sand crews can get there.

Whatever the condition -- smooth ice, packed, blowing or loose snow -- drive with caution.

If you have traction control, keep the system on. It will improve your ability to accelerate when driving on a slippery road. Even though your vehicle has a traction control system, you'll want to slow down and adjust your driving to the road conditions. See "Traction Control System" in the Index.

If you don't have the traction control system, accelerate gently. Try not to break the fragile traction. If you accelerate too fast, the drive wheels will spin and polish the surface under the tires even more.



Your anti-lock brakes improve your vehicle's stability when you make a hard stop on a slippery road. Even though you have the anti-lock braking system, you'll want to begin stopping sooner than you would on dry pavement. See "Anti-Lock" in the Index.

- Allow greater following distance on any slippery road.
- Watch for slippery spots. The road might be fine until you hit a spot that's covered with ice. On an otherwise clear road, ice patches may appear in shaded areas where the sun can't reach: around clumps of trees, behind buildings or under bridges. Sometimes the surface of a curve or an overpass may remain icy when the surrounding roads are clear. If you see a patch of ice ahead of you, brake before you are on it. Try not to brake while you're actually on the ice, and avoid sudden steering maneuvers.

## If You're Caught in a Blizzard

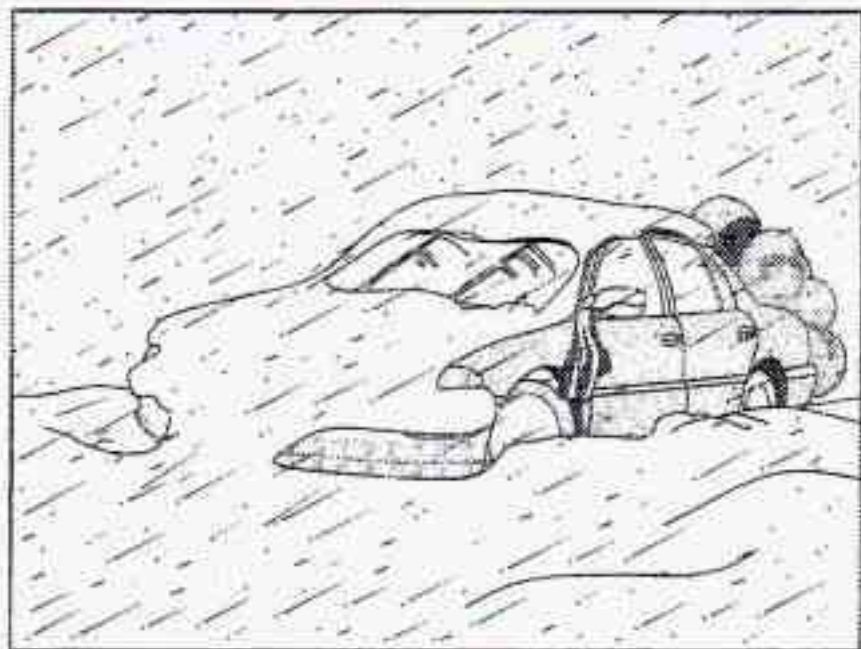

If you are stopped by heavy snow, you could be in a serious situation. You should probably stay with your vehicle unless you know for sure that you are near help and you can hike through the snow. Here are some things to do to summon help and keep yourself and your passengers safe:

- Turn on your hazard flashers.

- Tie a red cloth to your vehicle to alert police that you've been stopped by the snow.
- Put on extra clothing or wrap a blanket around you. If you have no blankets or extra clothing, make body insulators from newspapers, burlap bags, rags, floor mats -- anything you can wrap around yourself or tuck under your clothing to keep warm.



You can run the engine to keep warm, but be careful.



## CAUTION:

Snow can trap exhaust gases under your vehicle. This can cause deadly CO (carbon monoxide) gas to get inside. CO could overcome you and kill you. You can't see it or smell it, so you might not know it is in your vehicle. Clear away snow from around the base of your vehicle, especially any that is blocking your exhaust pipe. And check around again from time to time to be sure snow doesn't collect there.

Open a window just a little on the side of the vehicle that's away from the wind. This will help keep CO out.



Run your engine only as long as you must. This saves fuel. When you run the engine, make it go a little faster than just idle. That is, push the accelerator slightly. This uses less fuel for the heat that you get and it keeps the battery charged. You will need a well-charged battery to restart the vehicle, and possibly for signaling later on with your headlamps. Let the heater run for a while.

Then, shut the engine off and close the window almost all the way to preserve the heat. Start the engine again and repeat this only when you feel really uncomfortable from the cold. But do it as little as possible. Preserve the fuel as long as you can. To help keep warm, you can get out of the vehicle and do some fairly vigorous exercises every half hour or so until help comes.

## Loading Your Vehicle

TIRE-LOADING INFORMATION					
OCCUPANTS			VEHICLE CAP. WT.		
FRT.	CTR.	RR.	TOTAL	LBS.	KG.
MAX. LOADING & GVWR SAME AS VEHICLE					
CAPACITY WEIGHT			XXX	COLD TIRE	
TIRE SIZE			SPEED	PRESSURE	
			RTG	PSI/KPa	
FRT.					
RR.					
SPA.					
IF TIRES ARE HOT, ADD 4PSI/28KPa					
SEE OWNER'S MANUAL FOR ADDITIONAL INFORMATION					

Two labels on your vehicle show how much weight it may properly carry. The Tire Loading Information label found on the rear edge of the driver's door tells you the proper size, speed rating and recommended inflation pressures for the tires on your vehicle. It also gives you important information about the number of people that can be in your vehicle and the total weight that you can carry. This weight is called the Vehicle Capacity Weight and includes the weight of all occupants, cargo, and all nonfactory-installed options.





MFD BY GENERAL MOTORS CORP  
DATE GVWR GAWR FRT GAWR RR

THIS VEHICLE CONFORMS TO ALL APPLICABLE U.S. FEDERAL MOTOR VEHICLE SAFETY, BUMPER, AND THEFT PREVENTION STANDARDS IN EFFECT ON THE DATE OF MANUFACTURE SHOWN ABOVE.

The other label is the Certification Label, found on the rear edge of the driver's door. It tells you the gross weight capacity of your vehicle, called the Gross Vehicle Weight Rating (GVWR). The GVWR includes the weight of the vehicle, all occupants, fuel and cargo. Never exceed the GVWR for your vehicle, or the Gross Axle Weight Rating (GAWR) for either the front or rear axle.

And, if you do have a heavy load, you should spread it out. Don't carry more than 176 pounds (80 kilograms) in your trunk.



## CAUTION:

Do not load your vehicle any heavier than the GVWR, or either the maximum front or rear GAWR. If you do, parts on your vehicle can break, or it can change the way your vehicle handles. These could cause you to lose control. Also, overloading can shorten the life of your vehicle.

## NOTICE:

Your warranty does not cover parts or components that fail because of overloading.

If you put things inside your vehicle -- like suitcases, tools, packages, or anything else -- they will go as fast as the vehicle goes. If you have to stop or turn quickly, or if there is a crash, they'll keep going.

 **CAUTION:**

Things you put inside your vehicle can strike and injure people in a sudden stop or turn, or in a crash.

- Put things in the trunk of your vehicle. In a trunk, put them as far forward as you can. Try to spread the weight evenly.
- Never stack heavier things, like suitcases, inside the vehicle so that some of them are above the tops of the seats.
- Don't leave an unsecured child restraint in your vehicle.
- When you carry something inside the vehicle, secure it whenever you can.

### Electronic Level Control

This feature keeps the rear of your vehicle level as the load changes. It's automatic -- you don't need to adjust anything.

### Towing a Trailer

 **CAUTION:**

If you don't use the correct equipment and drive properly, you can lose control when you pull a trailer. For example, if the trailer is too heavy, the brakes may not work well -- or even at all. You and your passengers could be seriously injured. You may also damage your vehicle; the resulting repairs would not be covered by your warranty. Pull a trailer only if you have followed all the steps in this section. Ask your dealer for advice and information about towing a trailer with your vehicle.

Your vehicle can tow a trailer if it is equipped with the proper trailer towing equipment. To identify what the vehicle trailering capacity is for your vehicle, you should read the information in "Weight of the Trailer" that appears later in this section. But trailering is different than just driving your vehicle by itself. Trailering means changes in handling, durability and fuel economy. Successful, safe trailering takes correct equipment, and it has to be used properly.

That's the reason for this part. In it are many time-tested, important trailering tips and safety rules. Many of these are important for your safety and that of your passengers. So please read this section carefully before you pull a trailer.

Load-pulling components such as the engine, transaxle, wheel assemblies and tires are forced to work harder against the drag of the added weight. The engine is required to operate at relatively higher speeds and under greater loads, generating extra heat. What's more, the trailer adds considerably to wind resistance, increasing the pulling requirements.

### **If You Do Decide To Pull A Trailer**

If you do, here are some important points:

- There are many different laws, including speed limit restrictions, having to do with trailering. Make sure your rig will be legal, not only where you live but also where you'll be driving. A good source for this information can be state or provincial police.

- Consider using a sway control. You can ask a hitch dealer about sway controls.
- Don't tow a trailer at all during the first 1,000 miles (1 600 km) your new vehicle is driven. Your engine, axle or other parts could be damaged.
- Then, during the first 500 miles (800 km) that you tow a trailer, don't drive over 50 mph (80 km/h) and don't make starts at full throttle. This helps your engine and other parts of your vehicle wear in at the heavier loads.
- Obey speed limit restrictions when towing a trailer. Don't drive faster than the maximum posted speed for trailers (or no more than 55 mph (90 km/h)) to save wear on your vehicle's parts.

Three important considerations have to do with weight:

- the weight of the trailer,
- the weight of the trailer tongue
- and the total weight on your vehicle's tires.



## Weight of the Trailer

How heavy can a trailer safely be?

It should never weigh more than 1,000 pounds (450 kg). But even that can be too heavy.

It depends on how you plan to use your rig. For example, speed, altitude, road grades, outside temperature and how much your vehicle is used to pull a trailer are all important. And, it can also depend on any special equipment that you have on your vehicle.

You can ask your dealer for our trailering information or advice, or you can write us at:

Buick Motor Division  
Customer Relations Center  
902 E. Hamilton Avenue  
Flint, MI 48550

In Canada, write to:

General Motors of Canada Limited  
Customer Communication Centre  
1908 Colonel Sam Drive  
Oshawa, Ontario L1H 8P7

## Weight of the Trailer Tongue

The tongue load (A) of any trailer is an important weight to measure because it affects the total or gross weight of your vehicle. The Gross Vehicle Weight (GVW) includes the curb weight of the vehicle, any cargo you may carry in it, and the people who will be riding in the vehicle. And if you tow a trailer, you must add the tongue load to the GVW because your vehicle will be carrying that weight, too. See "Loading Your Vehicle" in the Index for more information about your vehicle's maximum load capacity.

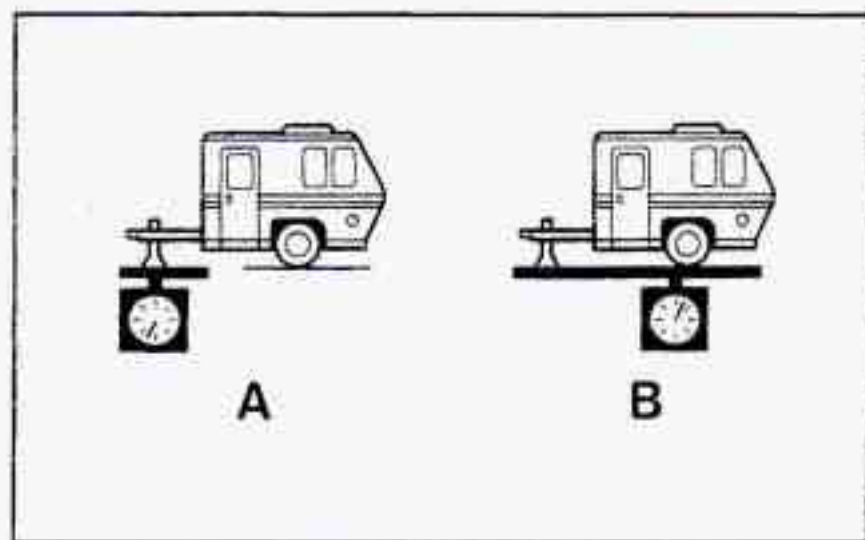

If you're using a weight-carrying hitch, the trailer tongue (A) should weigh 10 percent of the total loaded trailer weight (B). If you have a weight-distributing hitch, the trailer tongue (A) should weigh 12 percent of the total loaded trailer weight (B).

After you've loaded your trailer, weigh the trailer and then the tongue, separately, to see if the weights are proper. If they aren't, you may be able to get them right simply by moving some items around in the trailer.

### Total Weight on Your Vehicle's Tires

Be sure your vehicle's tires are inflated to the upper limit for cold tires. You'll find these numbers on the Tire-Loading Information label at the rear edge of the driver's door or see "Loading Your Vehicle" in the Index. Then be sure you don't go over the GVW limit for your vehicle, including the weight of the trailer tongue.

### Hitches

It's important to have the correct hitch equipment. Crosswinds, large trucks going by and rough roads are a few reasons why you'll need the right hitch. Here are some rules to follow:

- The rear bumper on your vehicle is not intended for hitches. Do not attach rental hitches or other bumper-type hitches to it. Use only a frame-mounted hitch that does not attach to the bumper.
- Will you have to make any holes in the body of your vehicle when you install a trailer hitch? If you do, then be sure to seal the holes later when you remove the hitch. If you don't seal them, deadly carbon monoxide (CO) from your exhaust can get into your vehicle (see "Carbon Monoxide" in the Index). Dirt and water can, too.

### Safety Chains

You should always attach chains between your vehicle and your trailer. Cross the safety chains under the tongue of the trailer so that the tongue will not drop to the road if it becomes separated from the hitch. Instructions about safety chains may be provided by the hitch manufacturer or by the trailer manufacturer. Follow the manufacturer's recommendation for attaching safety chains and do not attach them to the bumper. Always leave just enough slack so you can turn with your rig. And, never allow safety chains to drag on the ground.

## Trailer Brakes

Be sure to read and follow the instructions for the trailer brakes so you'll be able to install, adjust and maintain them properly.

Because you have anti-lock brakes, do not try to tap into your vehicle's brake system. If you do, both brake systems won't work well, or at all.

## Driving with a Trailer

Towing a trailer requires a certain amount of experience. Before setting out for the open road, you'll want to get to know your rig. Acquaint yourself with the feel of handling and braking with the added weight of the trailer. And always keep in mind that the vehicle you are driving is now a good deal longer and not nearly as responsive as your vehicle is by itself.

Before you start, check the trailer hitch and platform (and attachments), safety chains, electrical connector, lamps, tires and mirror adjustment. If the trailer has electric brakes, start your vehicle and trailer moving and then apply the trailer brake controller by hand to be sure the brakes are working. This lets you check your electrical connection at the same time.

During your trip, check occasionally to be sure that the load is secure, and that the lamps and any trailer brakes are still working.

## Following Distance

Stay at least twice as far behind the vehicle ahead as you would when driving your vehicle without a trailer. This can help you avoid situations that require heavy braking and sudden turns.

## Passing

You'll need more passing distance up ahead when you're towing a trailer. And, because you're a good deal longer, you'll need to go much farther beyond the passed vehicle before you can return to your lane.

## Backing Up

Hold the bottom of the steering wheel with one hand. Then, to move the trailer to the left, just move that hand to the left. To move the trailer to the right, move your hand to the right. Always back up slowly and, if possible, have someone guide you.



## Making Turns

### **NOTICE:**

**Making very sharp turns while trailering could cause the trailer to come in contact with the vehicle. Your vehicle could be damaged. Avoid making very sharp turns while trailering.**

When you're turning with a trailer, make wider turns than normal. Do this so your trailer won't strike soft shoulders, curbs, road signs, trees or other objects. Avoid jerky or sudden maneuvers. Signal well in advance.

### Turn Signals When Towing a Trailer

The green arrows on your instrument panel will flash whenever you signal a turn or lane change. Properly hooked up, the trailer lamps will also flash, telling other drivers you're about to turn, change lanes or stop.

When towing a trailer, the green arrows on your instrument panel will flash for turns even if the bulbs on the trailer are burned out. Thus, you may think drivers behind you are seeing your signal when they are not. It's important to check occasionally to be sure the trailer bulbs are still working.

Your vehicle has bulb warning lights. When you plug a trailer lighting system into your vehicle's lighting system, its bulb warning lights may not let you know if one of your lamps goes out. So, when you have a trailer lighting system plugged in, be sure to check your vehicle and trailer lamps from time to time to be sure they're all working. Once you disconnect the trailer lamps, the bulb warning lights again can tell you if one of your vehicle lamps is out.

### Driving On Grades

Reduce speed and shift to a lower gear *before* you start down a long or steep downgrade. If you don't shift down, you might have to use your brakes so much that they would get hot and no longer work well.

On a long uphill grade, shift down to THIRD (3) and reduce your speed to around 45 mph (70 km/h) to reduce the possibility of engine and transaxle overheating.

## Parking on Hills

You really should not park your vehicle, with a trailer attached, on a hill. If something goes wrong, your rig could start to move. People can be injured, and both your vehicle and the trailer can be damaged.

But if you ever have to park your rig on a hill, here's how to do it:

1. Apply your regular brakes, but don't shift into PARK (P) yet.
2. Have someone place chocks under the trailer wheels.
3. When the wheel chocks are in place, release the regular brakes until the chocks absorb the load.
4. Reapply the regular brakes. Then apply your parking brake, and then shift to PARK (P).
5. Release the regular brakes.

## When You Are Ready to Leave After Parking on a Hill

1. Apply your regular brakes and hold the pedal down while you:
  - Start your engine;
  - Shift into a gear; and
  - Release the parking brake.

2. Let up on the brake pedal.
3. Drive slowly until the trailer is clear of the chocks.
4. Stop and have someone pick up and store the chocks.

## Maintenance When Trailer Towing

Your vehicle will need service more often when you're pulling a trailer. See the Maintenance Schedule for more on this. Things that are especially important in trailer operation are automatic transaxle fluid (don't overfill), engine oil, belts, cooling system and brake adjustment. Each of these is covered in this manual, and the Index will help you find them quickly. If you're trailering, it's a good idea to review these sections before you start your trip.

Check periodically to see that all hitch nuts and bolts are tight.

## Engine Cooling When Trailer Towing

Your cooling system may temporarily overheat during severe operating conditions. See "Engine Overheating" in the Index.



## Section 5 Problems on the Road

---

Here you'll find what to do about some problems that can occur on the road.

5-2 Hazard Warning Flashers  
5-2 Other Warning Devices  
5-3 Jump Starting  
5-7 Towing Your Vehicle  
5-12 Engine Overheating

5-21 If a Tire Goes Flat  
5-22 Changing a Flat Tire  
5-31 Compact Spare Tire  
5-32 If You're Stuck: In Sand, Mud, Ice or Snow



## Hazard Warning Flashers

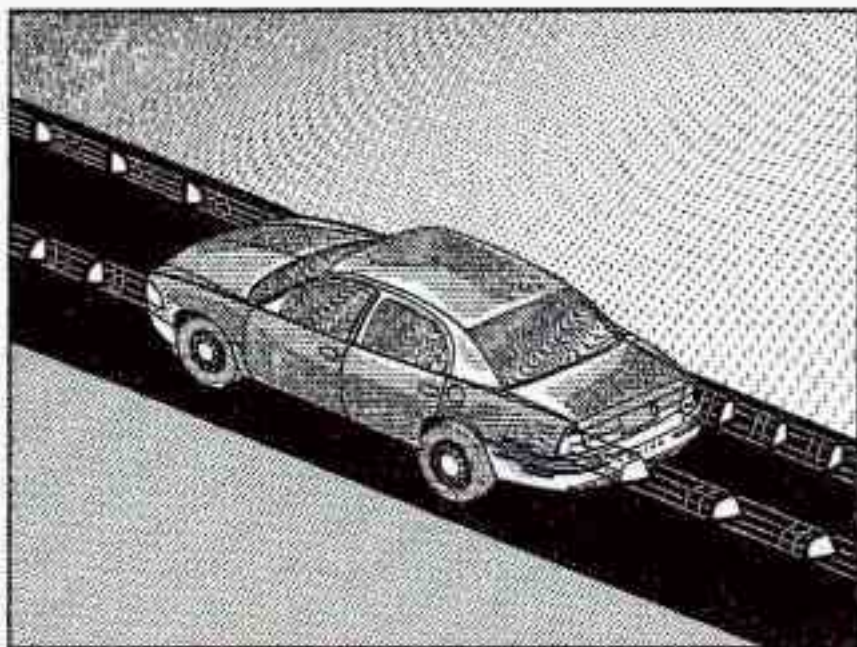

Your hazard warning flashers let you warn others. They also let police know you have a problem. Your front and rear turn signal lamps will flash on and off.



Press the button in to make your front and rear turn signal lamps flash on and off.

Your hazard warning flashers work no matter what position your key is in, and even if the key isn't in.

To turn off the flashers, press down on the button again. When the hazard warning flashers are on, your turn signals won't work.

## Other Warning Devices

If you carry reflective triangles, you can set one up at the side of the road about 300 feet (100 m) behind your vehicle.

## Jump Starting

If your battery has run down, you may want to use another vehicle and some jumper cables to start your vehicle. But please follow the steps in this part to do it safely.

### CAUTION:

**Batteries can hurt you. They can be dangerous because:**

- They contain acid that can burn you.
- They contain gas that can explode or ignite.
- They contain enough electricity to burn you.

**If you don't follow these steps exactly, some or all of these things can hurt you.**

### NOTICE:

**Ignoring these steps could result in costly damage to your vehicle that wouldn't be covered by your warranty.**

**NOTICE: (Continued)**

### NOTICE: (Continued)

**Trying to start your vehicle by pushing or pulling it won't work, and it could damage your vehicle.**

1. Check the other vehicle. It must have a 12-volt battery with a negative ground system.

### NOTICE:

**If the other system isn't a 12-volt system with a negative ground, both vehicles can be damaged.**

2. Get the vehicles close enough so the jumper cables can reach, but be sure the vehicles aren't touching each other. If they are, it could cause a ground connection you don't want. You wouldn't be able to start your vehicle, and the bad grounding could damage the electrical systems.

To avoid the possibility of the vehicles rolling, set the parking brake firmly on both vehicles involved. Put an automatic transaxle in PARK (P) before setting the parking brake.



3. Turn off the ignition on both vehicles. Turn off the radios and all lamps that aren't needed. This will avoid sparks and help save both batteries. It could save your radio!

### **NOTICE:**

If you leave your radio on, it could be badly damaged. The repairs wouldn't be covered by your warranty.

4. Open the hood and locate the batteries.

### **CAUTION:**

An electric fan can start up even when the engine is not running and can injure you. Keep hands, clothing and tools away from any underhood electric fan.

5. Find the positive (+) and negative (-) terminals on each battery.

### **CAUTION:**

Using a match near a battery can cause battery gas to explode. People have been hurt doing this, and some have been blinded. Use a flashlight if you need more light.

Be sure the battery has enough water. You don't need to add water to the ACDeico Freedom<sup>®</sup> battery installed in every new GM vehicle. But if a battery has filler caps, be sure the right amount of fluid is there. If it is low, add water to take care of that first. If you don't, explosive gas could be present.

Battery fluid contains acid that can burn you. Don't get it on you. If you accidentally get it in your eyes or on your skin, flush the place with water and get medical help immediately.



6. Check that the jumper cables don't have loose or missing insulation. If they do, you could get a shock and the vehicles could be damaged.

Before you connect the cables, here are some basic things you should know. Positive (+) will go to positive (+) and negative (-) will go to a metal engine part. Don't connect positive (+) to negative (-) or you'll get a short that would damage the battery and maybe other parts, too.



8. Don't let the other end touch metal. Connect it to the positive (+) terminal of the good battery. Use a remote positive (+) terminal if the vehicle has one.

9. Now connect the black negative (-) cable to the good battery's negative (-) terminal.

Don't let the other end touch anything until the next step. The other end of the negative cable *doesn't* go to the dead battery. It goes to a heavy unpainted metal part on the engine of the vehicle with the dead battery.

**⚠ CAUTION:**

**Fans or other moving engine parts can injure you badly. Keep your hands away from moving parts once the engine is running.**

7. Connect the red positive (+) cable to the positive (+) terminal of the vehicle with the dead battery. Use a remote positive (+) terminal if the vehicle has one.

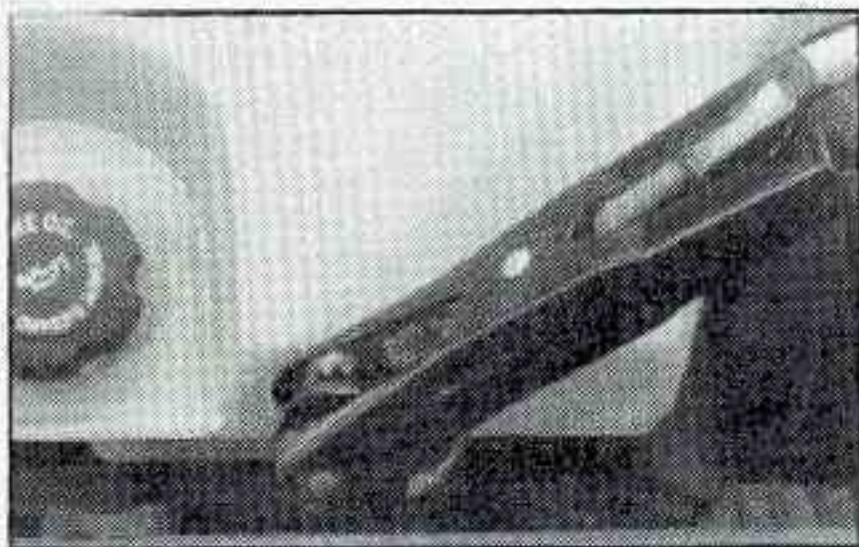

10. Attach the cable at least 18 inches (45 cm) away from the dead battery, but not near engine parts that move. The electrical connection is just as good there, but the chance of sparks getting back to the battery is much less.
11. Now start the vehicle with the good battery and run the engine for a while.
12. Try to start the vehicle with the dead battery.  
If it won't start after a few tries, it probably needs service.

13. Remove the cables in reverse order to prevent electrical shorting. Take care that they don't touch each other or any other metal.

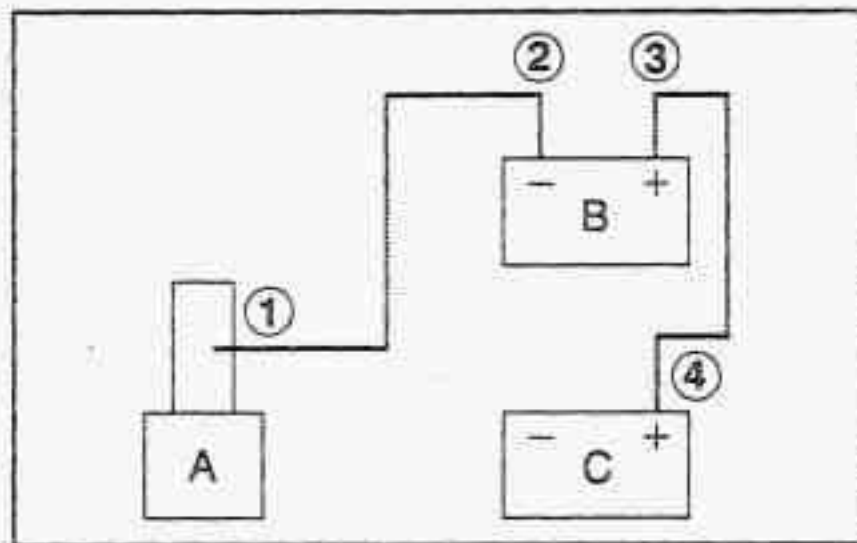

- A. Heavy Metal Engine Part
- B. Good Battery
- C. Dead Battery



## Towing Your Vehicle

Try to have your dealer or a professional towing service tow your vehicle. See "Roadside Assistance" in the Index.

If your vehicle has been changed or modified since it was factory-new by adding after-market items like fog lamps, aero skirting, or special tires and wheels, these instructions and illustrations may not be correct.

Before you do anything, turn on the hazard warning flashers.

When you call, tell the towing service:

- That your vehicle can only be towed with certain equipment, as described later in this section.
- That your vehicle has front-wheel drive.
- The make, model and year of your vehicle.
- Whether you can still move the shift lever.
- If there was an accident, what was damaged.

When the towing service arrives, let the tow operator know that this manual contains detailed towing instructions and illustrations. The operator may want to see them.

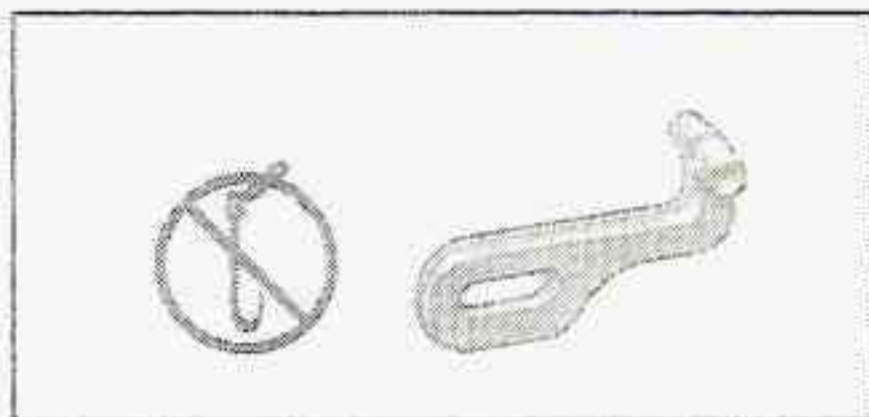

### CAUTION:

To help avoid injury to you or others:

- Never let passengers ride in a vehicle that is being towed.
- Never tow faster than safe or posted speeds.
- Never tow with damaged parts not fully secured.
- Never get under your vehicle after it has been lifted by the tow truck.
- Always secure the vehicle on each side with separate safety chains when towing it.
- Never use J-hooks. Use T-hooks instead.





## CAUTION:

**A vehicle can fall from a car carrier if it isn't adequately secured. This can cause a collision, serious personal injury and vehicle damage. The vehicle should be tightly secured with chains or steel cables before it is transported.**

**Don't use substitutes (ropes, leather straps, canvas webbing, etc.) that can be cut by sharp edges underneath the towed vehicle. Always use T-hooks inserted in the T-hook slots. Never use J-hooks. They will damage drivetrain and suspension components.**

When your vehicle is being towed, have the ignition key in OFF. The steering wheel should be clamped in a straight-ahead position, with a clamping device designed for towing service. Do not use the vehicle's steering column lock for this. The transaxle should be in NEUTRAL (N) and the parking brake released.

Don't have your vehicle towed on the front wheels, unless you must. If the vehicle must be towed on the front wheels, be sure to follow the speed and distance restrictions later in this section or your transaxle will be damaged. If these limits must be exceeded, then the front wheels have to be supported on a dolly.

## Front Towing



Attach T-hook chains behind the front wheels into the bottom slots of the cradle rails on both sides.

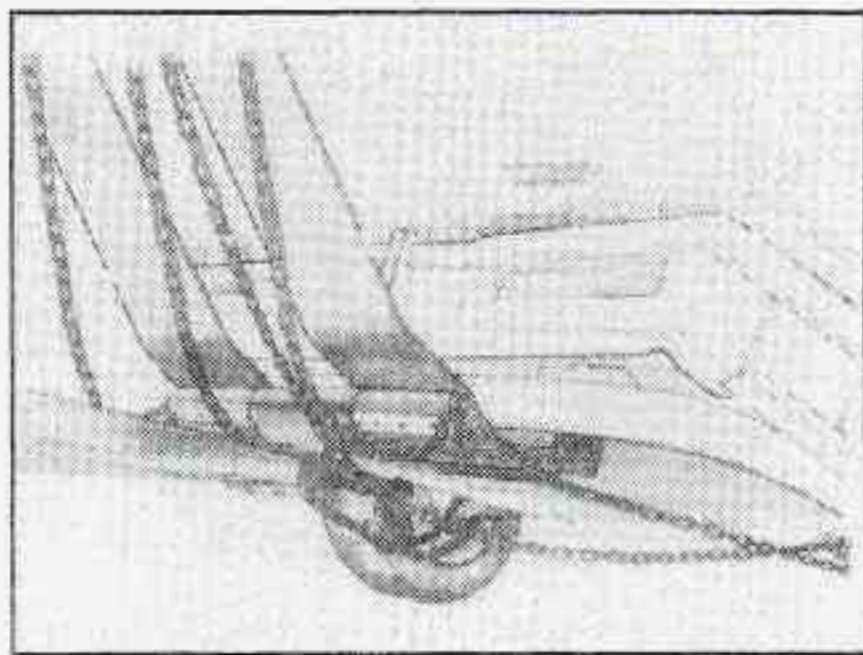

Position a 4" x 4" wood beam across the sling chains contacting the bottom of the cradle support. Position the lower sling crossbar just behind the rear edge of the front bumper.

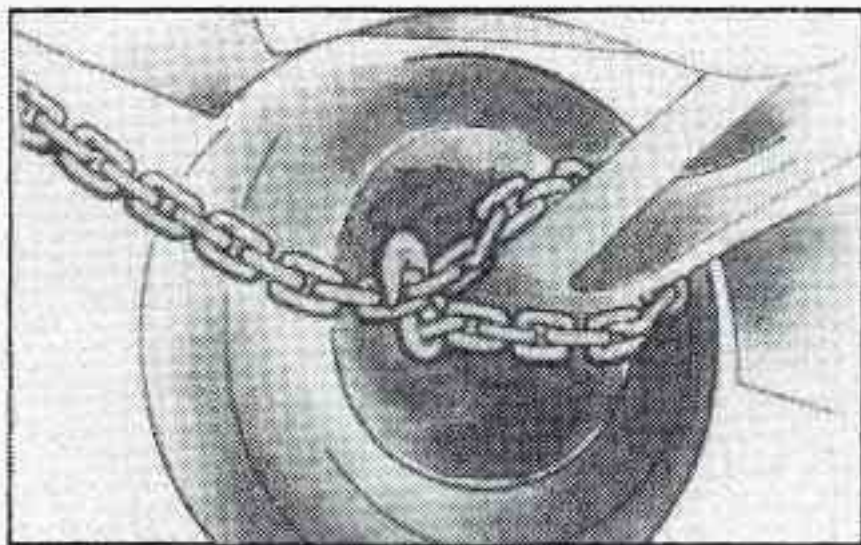

Attach a separate safety chain around the outboard end of each control arm.

## Rear Towing

*Tow Limits -- 55 mph (88 km/h), 500 miles (800 km)*

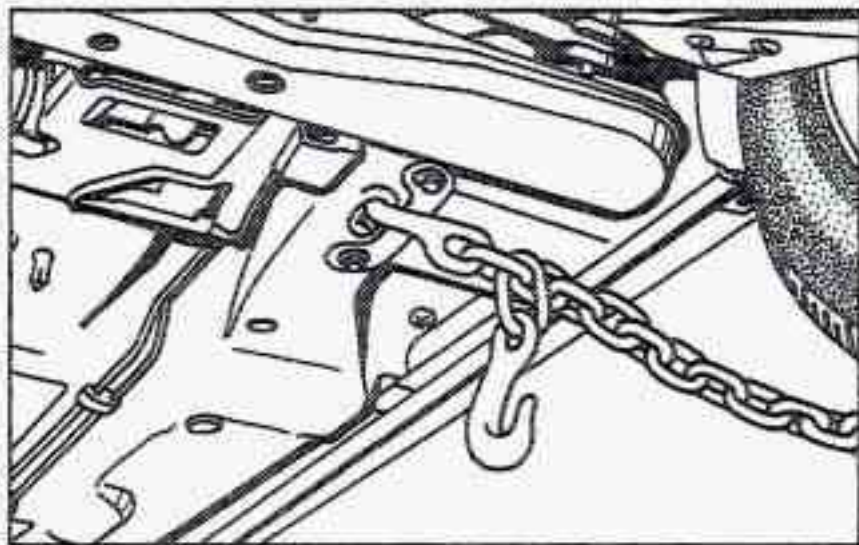

Attach T-hook chains on both sides in the slotted holes in the floor pan support rails just ahead of the rear wheels.



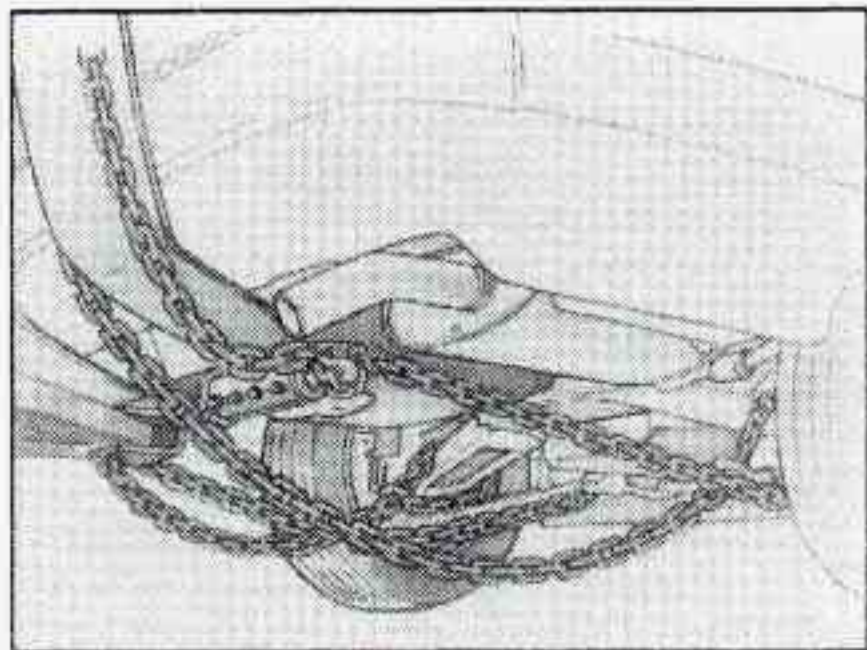

Position the lower sling crossbar in front of the rear bumper.

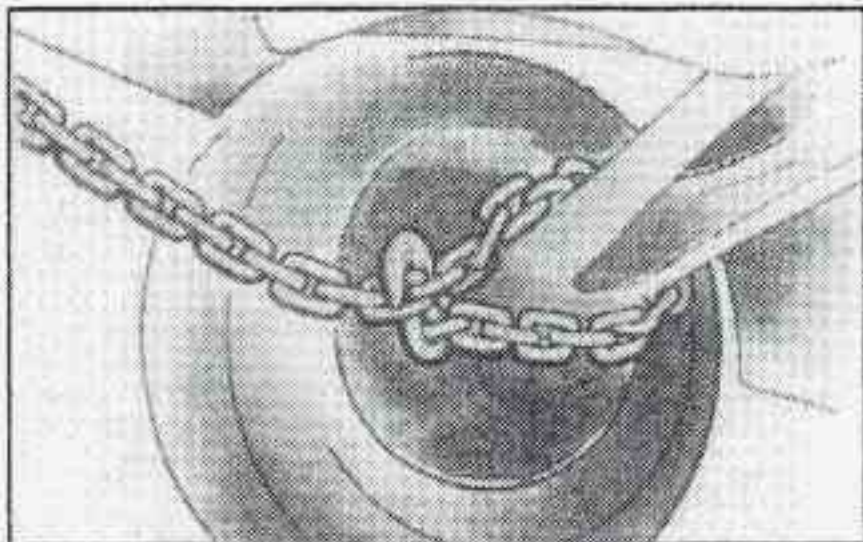

Attach a separate safety chain around the outboard end of each control arm.

## Engine Overheating

You will find a warning light about a hot engine, as well as a coolant temperature gage, on your instrument panel. If your vehicle is equipped with the optional Driver Information Center, an Engine Coolant Low warning will appear on the display.

### If Steam Is Coming From Your Engine

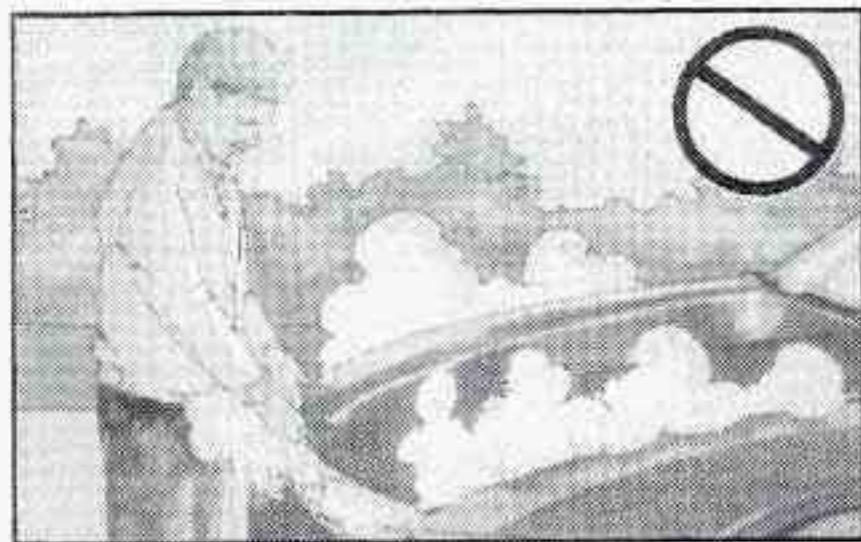

### CAUTION:

Steam from an overheated engine can burn you badly, even if you just open the hood. Stay away from the engine if you see or hear steam coming from it. Just turn it off and get everyone away from the vehicle until it cools down. Wait until there is no sign of steam or coolant before you open the hood.

If you keep driving when your engine is overheated, the liquids in it can catch fire. You or others could be badly burned. Stop your engine if it overheats, and get out of the vehicle until the engine is cool.

### NOTICE:

If your engine catches fire because you keep driving with no coolant, your vehicle can be badly damaged. The costly repairs would not be covered by your warranty.

## IF No Steam Is Coming From Your Engine

If you get the overheat warning but see or hear no steam, the problem may not be too serious. Sometimes the engine can get a little too hot when you:

- Climb a long hill on a hot day.
- Stop after high-speed driving.
- Idle for long periods in traffic.
- Tow a trailer.

If you get the overheat warning with no sign of steam, try this for a minute or so:

1. Turn off your air conditioner.
2. Turn on your heater to full hot at the highest fan speed and open the window as necessary.
3. If you're in a traffic jam, shift to NEUTRAL (N); otherwise, shift to the highest gear while driving -- AUTOMATIC OVERDRIVE (Ⓢ) or THIRD (3).

If you no longer have the overheat warning, you can drive. Just to be safe, drive slower for about 10 minutes. If the warning doesn't come back on, you can drive normally.

If the warning continues, pull over, stop, and park your vehicle right away.

If there's still no sign of steam, you can idle the engine for two or three minutes while you're parked, to see if the warning stops. But then, if you still have the warning, *turn off the engine and get everyone out of the vehicle* until it cools down.

You may decide not to lift the hood but to get service help right away.



## Cooling System

When you decide it's safe to lift the hood, here's what you'll see:

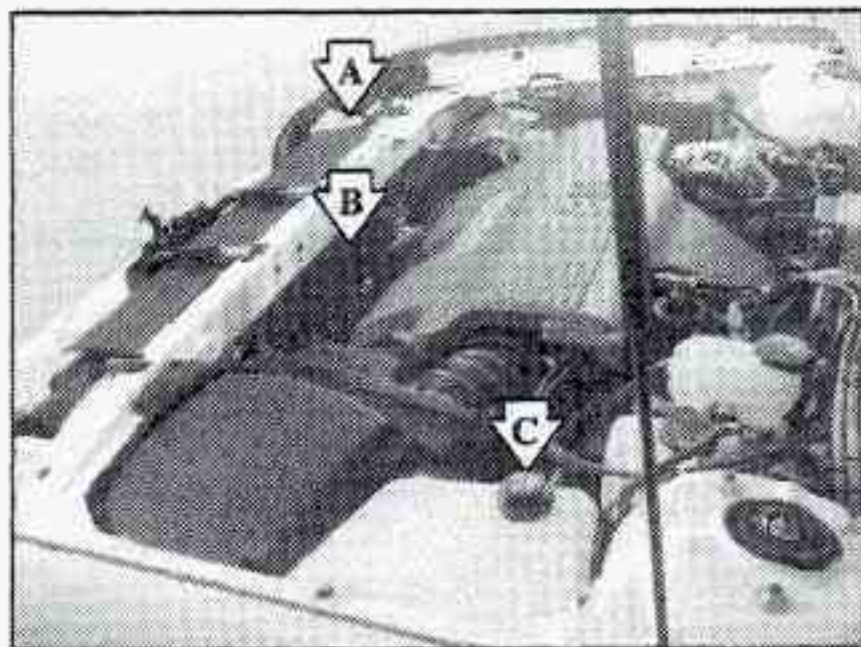

- A. Radiator Pressure Cap
- B. Electric Engine Fans
- C. Coolant Recovery Tank

### CAUTION:

An electric engine cooling fan under the hood can start up even when the engine is not running and can injure you. Keep hands, clothing and tools away from any underhood electric fan.

If the coolant inside the coolant recovery tank is boiling, don't do anything else until it cools down.

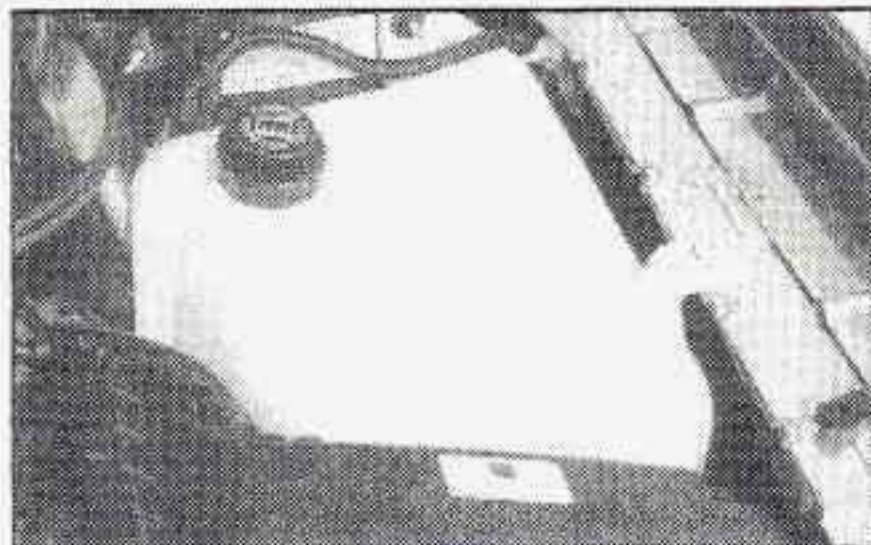

The coolant level should be at or above the **FULL COLD** mark.

If it isn't, you may have a leak in the radiator hoses, heater hoses, radiator, water pump or somewhere else in the cooling system.



## **CAUTION:**

**Heater and radiator hoses, and other engine parts, can be very hot. Don't touch them. If you do, you can be burned.**

**Don't run the engine if there is a leak. If you run the engine, it could lose all coolant. That could cause an engine fire, and you could be burned. Get any leak fixed before you drive the vehicle.**

## **NOTICE:**

**Engine damage from running your engine without coolant isn't covered by your warranty.**

If there seems to be no leak, with the engine on, check to see if the electric engine cooling fans are running. If the engine is overheating, both fans should be running. If they aren't, your vehicle needs service.

## How to Add Coolant to the Coolant Recovery Tank

If you haven't found a problem yet, but the coolant level isn't at or above the FULL COLD mark, add a 50/50 mixture of *clean water* (preferably distilled) and DEX-COOL<sup>®</sup> engine coolant at the coolant recovery tank. (See "Engine Coolant" in the Index for more information.)

### CAUTION:

**Adding only plain water to your cooling system can be dangerous. Plain water, or some other liquid like alcohol, can boil before the proper coolant mixture will. Your vehicle's coolant warning system is set for the proper coolant mixture. With plain water or the wrong mixture, your engine could get too hot but you wouldn't get the overheat warning. Your engine could catch fire and you or others could be burned. Use a 50/50 mixture of clean water and DEX-COOL<sup>®</sup> coolant.**

### NOTICE:

**In cold weather, water can freeze and crack the engine, radiator, heater core and other parts. Use the recommended coolant and the proper coolant mixture.**



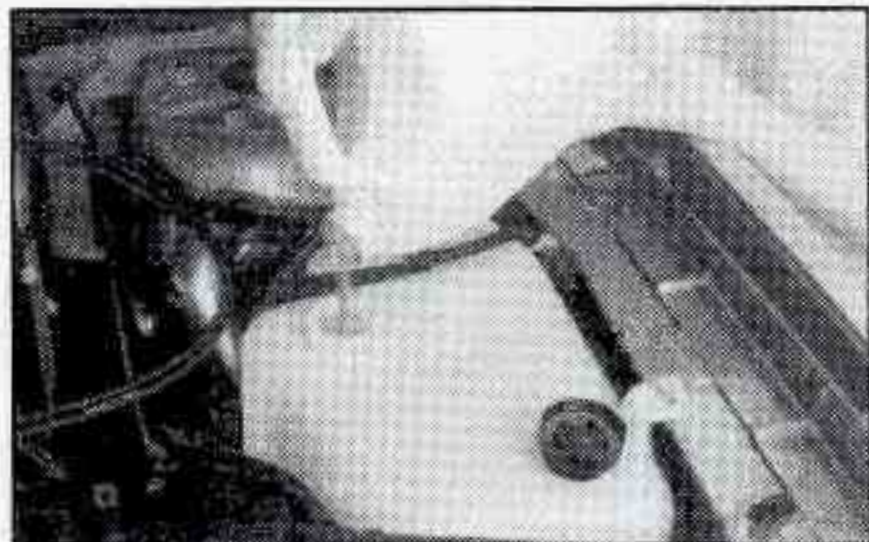

## CAUTION:

**You can be burned if you spill coolant on hot engine parts. Coolant contains ethylene glycol and it will burn if the engine parts are hot enough. Don't spill coolant on a hot engine.**

When the coolant in the coolant recovery tank is at or above the FULL COLD mark, start your vehicle.

If the overheat warning continues, there's one more thing you can try. You can add the proper coolant mixture directly to the radiator but be sure the cooling system is cool before you do it.

 **CAUTION:**

Steam and scalding liquids from a hot cooling system can blow out and burn you badly. They are under pressure, and if you turn the radiator pressure cap -- even a little -- they can come out at high speed. Never turn the cap when the cooling system, including the radiator pressure cap, is hot. Wait for the cooling system and radiator pressure cap to cool if you ever have to turn the pressure cap.

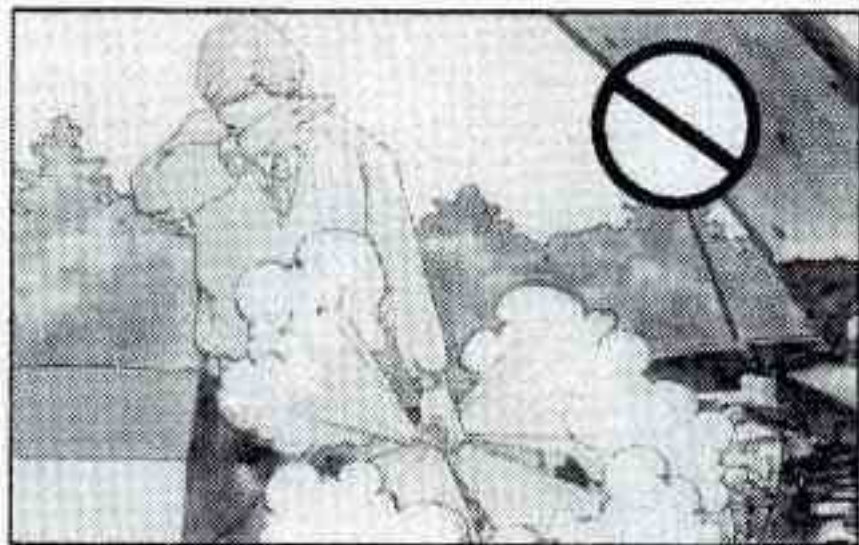

## How to Add Coolant to the Radiator

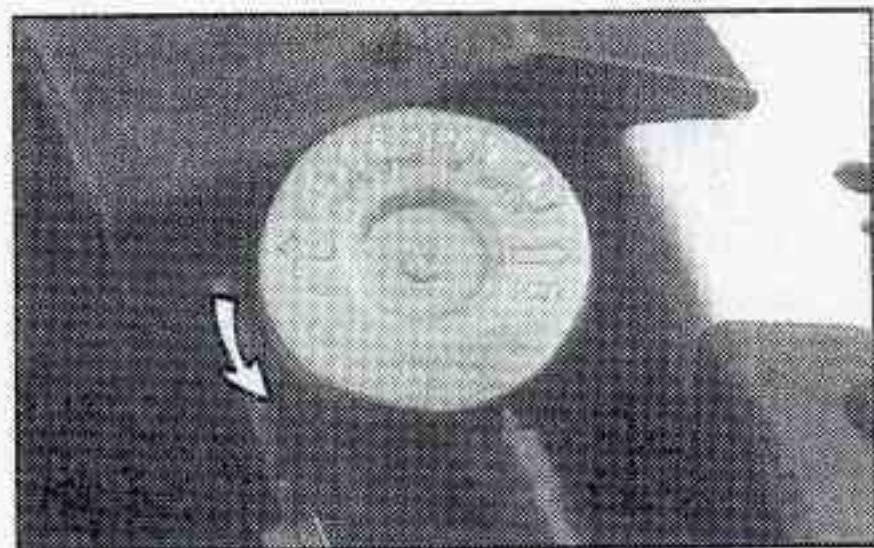

1. You can remove the radiator pressure cap when the cooling system, including the radiator pressure cap and upper radiator hose, is no longer hot. Turn the pressure cap slowly counterclockwise until it first stops. (Don't press down while turning the pressure cap.)

If you hear a hiss, wait for that to stop. A hiss means there is still some pressure left.

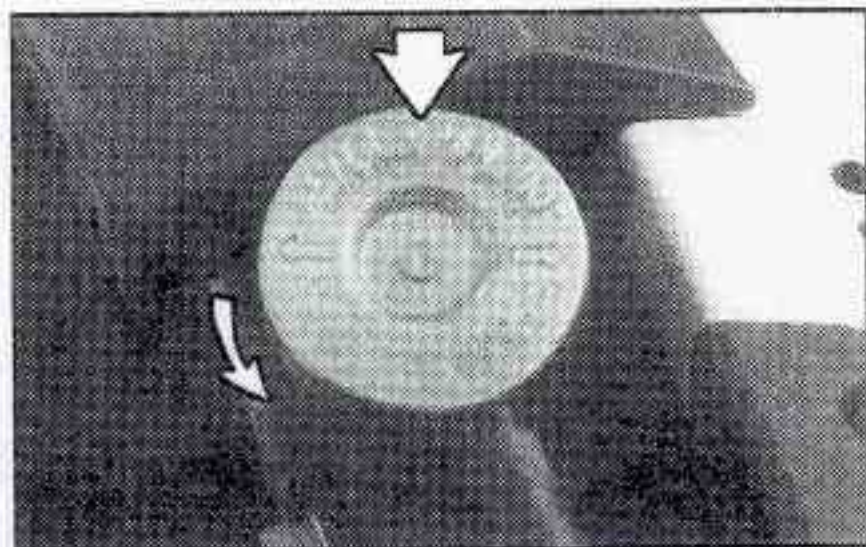

2. Then keep turning the pressure cap, but now push down as you turn it. Remove the pressure cap.





3. Fill the radiator with the proper DEX-COOL<sup>®</sup> coolant mixture, up to the base of the filler neck. (See "Engine Coolant" in the Index for more information about the proper coolant mixture.)
4. Then fill the coolant recovery tank to the FULL COLD mark.
5. Put the cap back on the coolant recovery tank, but leave the pressure cap off.

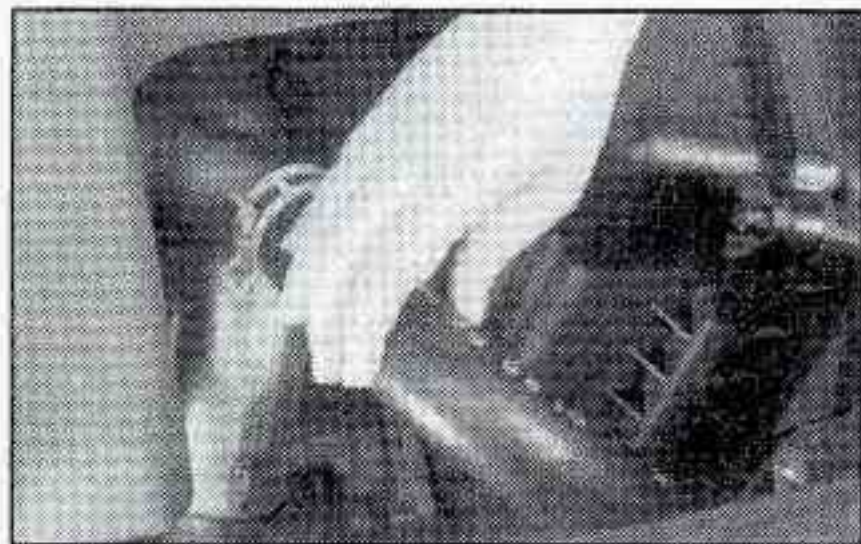

6. Start the engine and let it run until you can feel the upper radiator hose getting hot. Watch out for the engine cooling fans.
7. By this time, the coolant level inside the radiator filler neck may be lower. If the level is lower, add more of the proper DEX-COOL<sup>®</sup> coolant mixture through the filler neck until the level reaches the base of the filler neck.

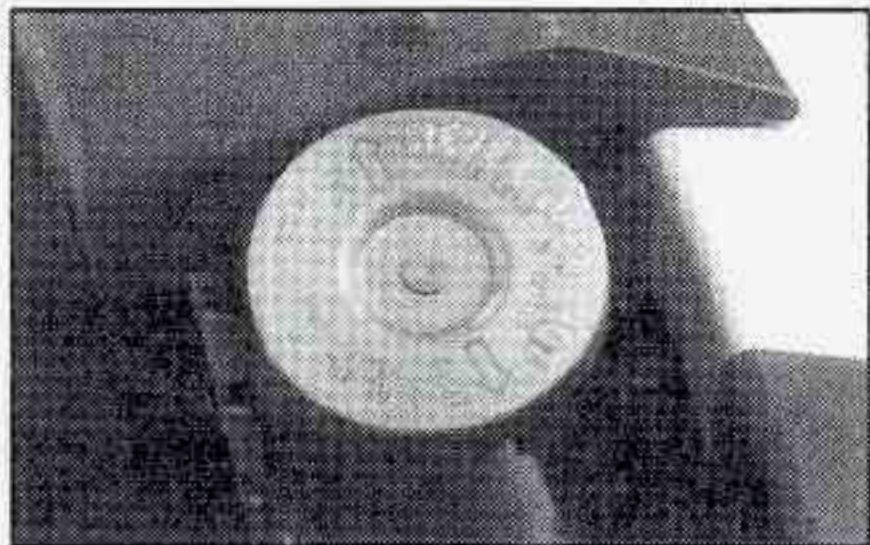

8. Then replace the pressure cap. At any time during this procedure if coolant begins to flow out of the filler neck, reinstall the pressure cap. Be sure the arrows on the pressure cap line up like this.

## If a Tire Goes Flat

It's unusual for a tire to "blow out" while you're driving, especially if you maintain your tires properly. If air goes out of a tire, it's much more likely to leak out slowly. But if you should ever have a "blowout," here are a few tips about what to expect and what to do:

If a front tire fails, the flat tire will create a drag that pulls the vehicle toward that side. Take your foot off the accelerator pedal and grip the steering wheel firmly. Steer to maintain lane position, and then gently brake to a stop well out of the traffic lane.

A rear blowout, particularly on a curve, acts much like a skid and may require the same correction you'd use in a skid. In any rear blowout, remove your foot from the accelerator pedal. Get the vehicle under control by steering the way you want the vehicle to go. It may be very bumpy and noisy, but you can still steer. Gently brake to a stop — well off the road if possible.

If a tire goes flat, the next part shows how to use your jacking equipment to change a flat tire safely.



## Changing a Flat Tire

If a tire goes flat, avoid further tire and wheel damage by driving slowly to a level place. Turn on your hazard warning flashers.



### CAUTION:

Changing a tire can cause an injury. The vehicle can slip off the jack and roll over you or other people. You and they could be badly injured. Find a level place to change your tire. To help prevent the vehicle from moving:

1. Set the parking brake firmly.
2. Put the shift lever in PARK (P).
3. Turn off the engine.

To be even more certain the vehicle won't move, you can put blocks at the front and rear of the tire farthest away from the one being changed. That would be the tire on the other side of the vehicle, at the opposite end.

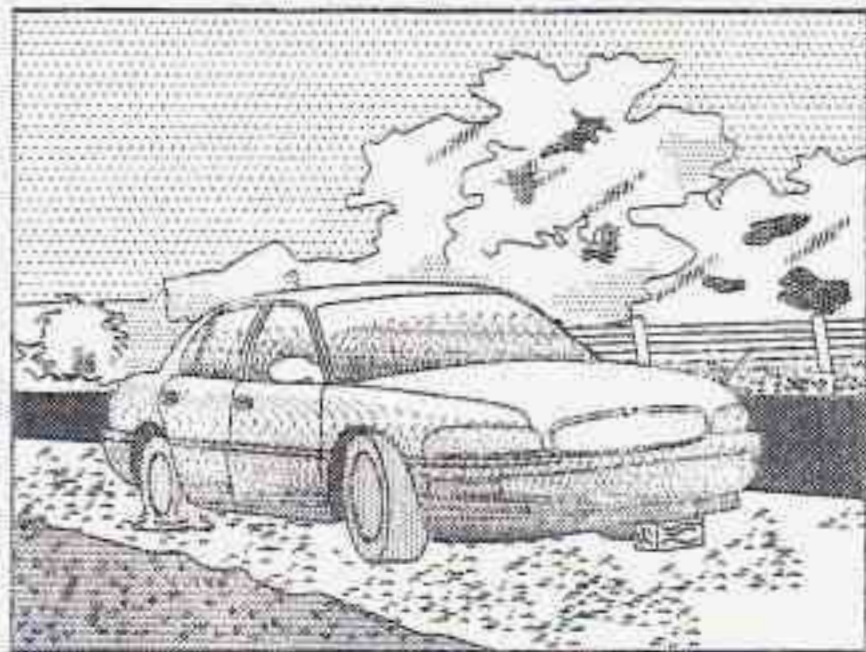

The following steps will tell you how to use the jack and change a tire.



## Removing the Spare Tire and Tools

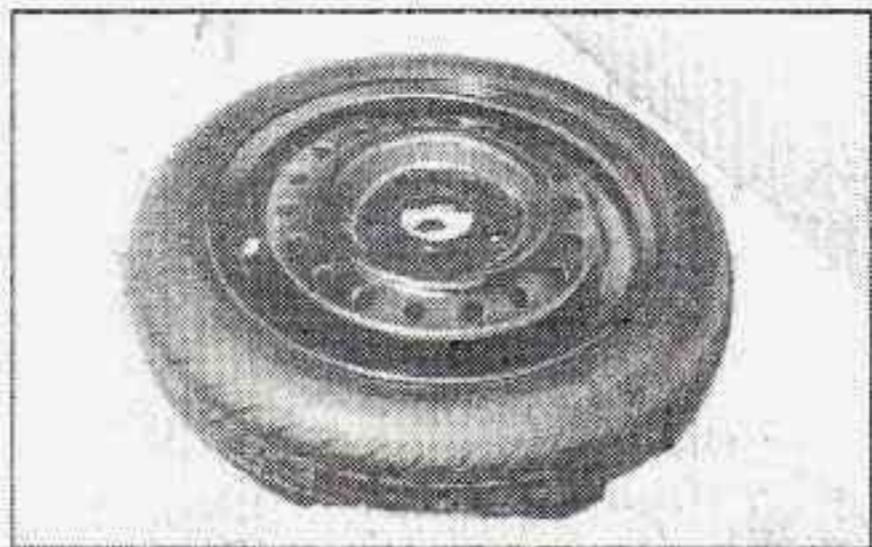

The equipment you'll need is in the trunk.

Instructions for changing your tires are on the inside of the tire cover. You can rest the cover near you for easy reference while you change the tire.

Lift the tire cover to gain access to the spare tire and jacking equipment.

Remove the wheel wrench and jack from the jack container.

Remove the spare tire from the trunk. See "Compact Spare Tire" later in this section for more information about the compact spare.

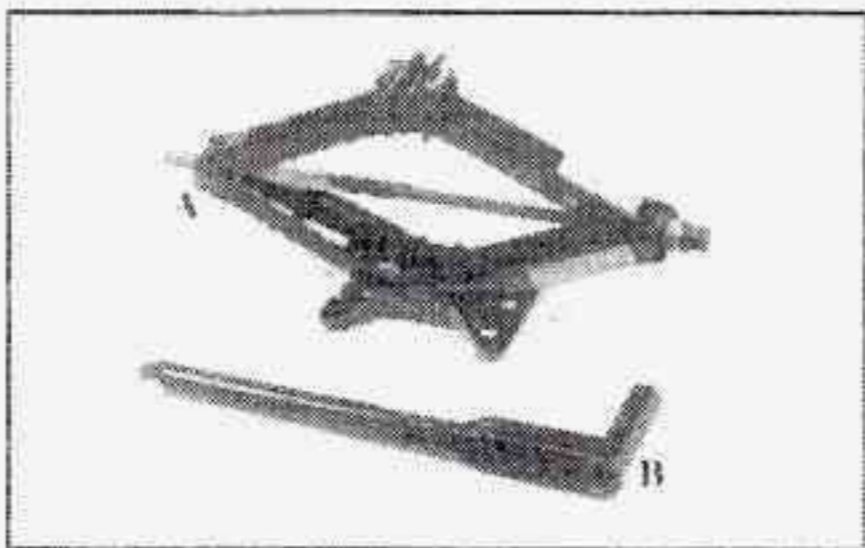

The tools you'll be using include the jack (A) and the wheel wrench (B).

## Wheel Covers

The following steps are necessary if you have the alloy (aluminum) wheel with a center cover that conceals the wheel nuts.

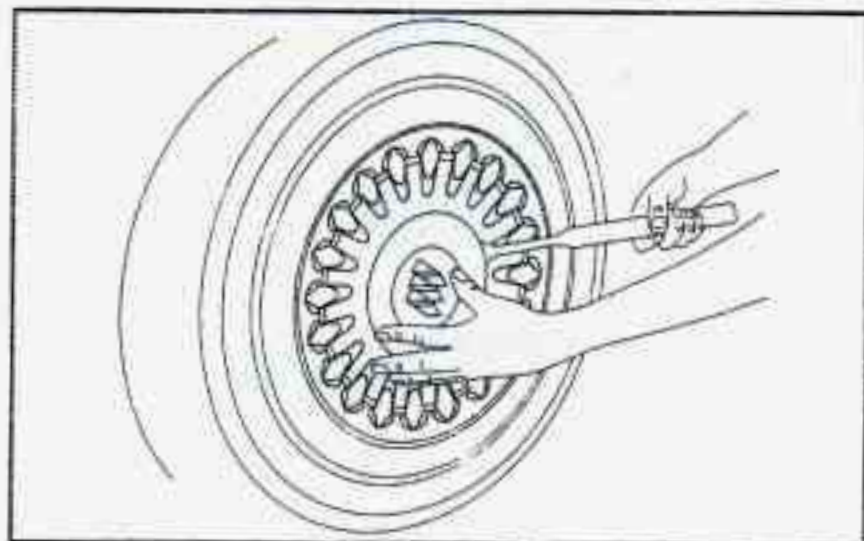

1. Insert the flat end of the wheel wrench in the notch and pry off the center cover. Do not drop the cover or lay it face down, as it could be scratched or damaged.

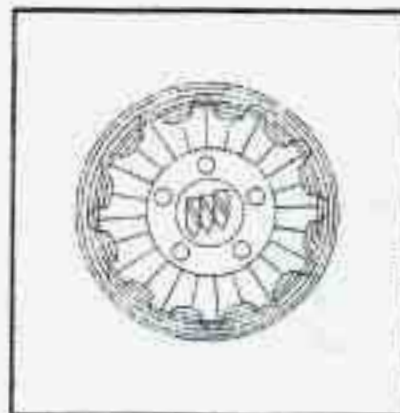

2. If your vehicle has this aluminum wheel, you may have plastic wheel nut caps. Use the wheel nut wrench to remove the wheel nut caps and to loosen the wheel nuts.

3. When reinstalling the decorative nut caps, tighten the caps snugly with the wheel wrench, then continue one-eighth of a turn for steel caps and one-quarter of a turn for plastic caps.

It is not required to remove the center cover on this wheel; however, if it should be necessary, it should be removed from the back side by pushing out with a blunt tool and not pried off from the front.

When reinstalling the cap, there is a plastic alignment pin which must be aligned with the notch in the wheel to assure proper installation.

4. After the wheel is put back on the vehicle, replace the cover. Apply pressure around the edge of the cover to snap it in place. Do not use a hammer or mallet to install the cover.

## Removing the Flat Tire and Installing the Spare Tire

1. Use the wheel wrench to loosen the wheel nuts, but don't remove them yet.



2. The jack has a bolt at the end. Attach the wheel wrench to the bolt to create a jack handle.

3. Rotate the wheel wrench to the left to lower the jack head until it fits under the vehicle.

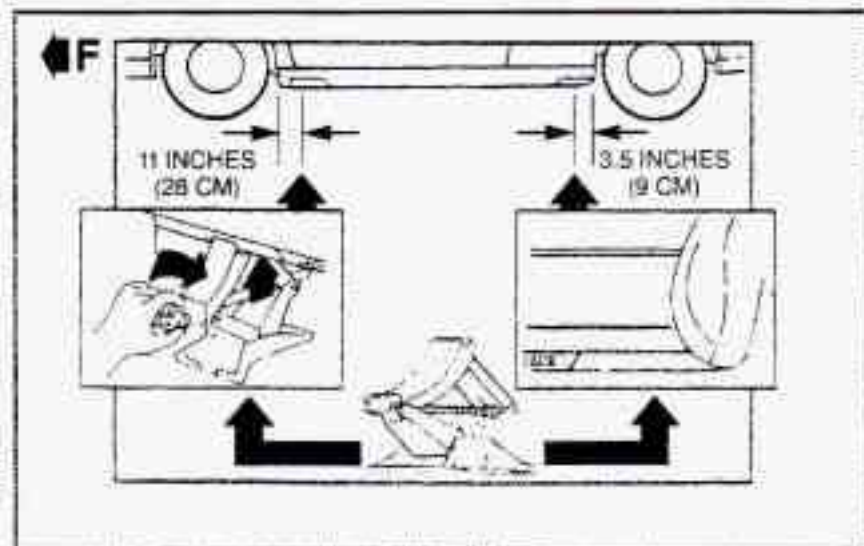

4. Near each wheel well is a notch in the plastic trim panel to position the jack head. You'll find the word JACK and an arrow stamped into the plastic near each notch. Position the jack under the vehicle and raise the jack head until it fits firmly against the sheet metal next to the word JACK. Do not raise the vehicle yet. Put the compact spare tire near you.



**⚠ CAUTION:**

Getting under a vehicle when it is jacked up is dangerous. If the vehicle slips off the jack, you could be badly injured or killed. Never get under a vehicle when it is supported only by a jack.

**⚠ CAUTION:**

Raising your vehicle with the jack improperly positioned can damage the vehicle and even make the vehicle fall. To help avoid personal injury and vehicle damage, be sure to fit the jack lift head into the proper location before raising the vehicle.

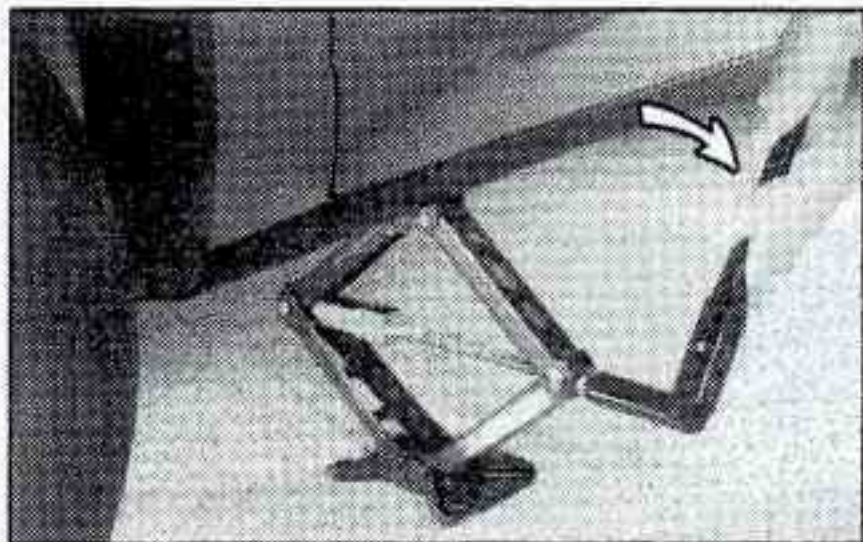

5. Raise the vehicle by rotating the wheel wrench to the right in the jack. Raise the vehicle far enough off the ground so there is enough room for the spare tire to fit.
6. Remove all the wheel nuts and take off the flat tire.

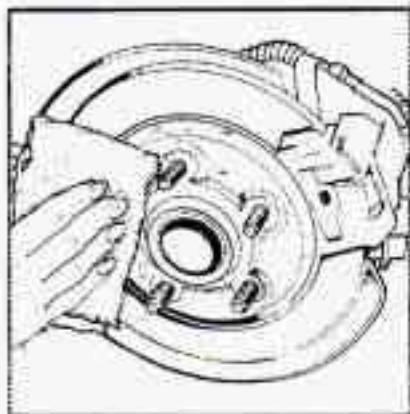

7. Remove any rust or dirt from the wheel bolts, mounting surfaces and spare wheel.



### CAUTION:

Never use oil or grease on studs or nuts. If you do, the nuts might come loose. Your wheel could fall off, causing a serious accident.



### CAUTION:

Rust or dirt on the wheel, or on the parts to which it is fastened, can make the wheel nuts become loose after a time. The wheel could come off and cause an accident. When you change a wheel, remove any rust or dirt from the places where the wheel attaches to the vehicle. In an emergency, you can use a cloth or a paper towel to do this; but be sure to use a scraper or wire brush later, if you need to, to get all the rust or dirt off.

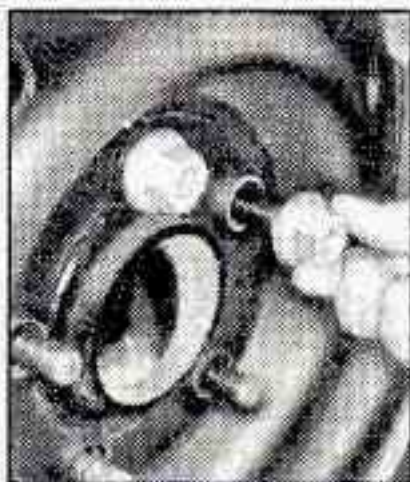

8. Install the compact spare tire on the wheel-mounting surface. Then replace the wheel nuts with the rounded end of the nuts toward the wheel. Tighten each nut by hand until the wheel is held against the hub.



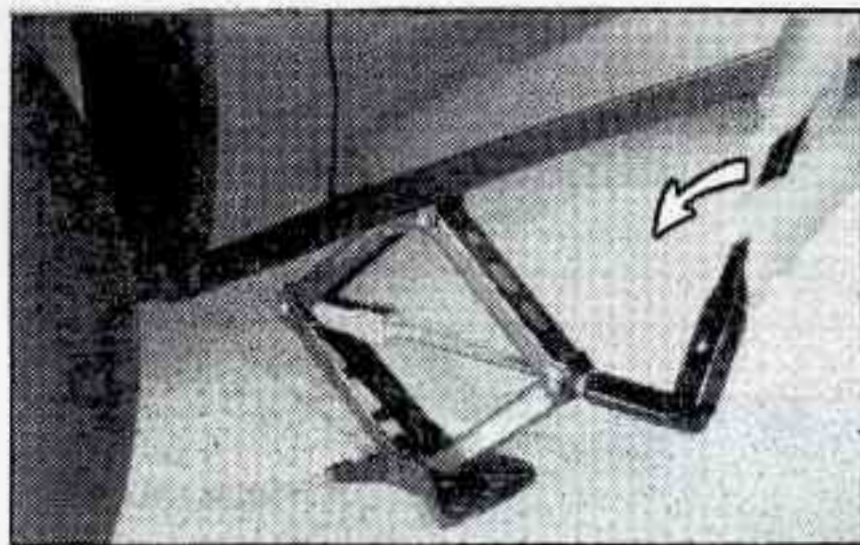

9. Lower the vehicle by rotating the wheel wrench to the left. Lower the jack completely.

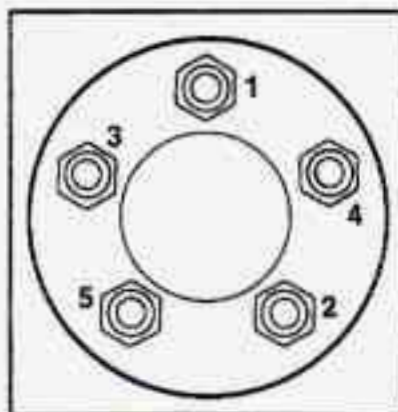

10. Using the wheel wrench, tighten the wheel nuts firmly in a crisscross sequence.

**⚠ CAUTION:**

**Incorrect wheel nuts or improperly tightened wheel nuts can cause the wheel to become loose and even come off. This could lead to an accident. Be sure to use the correct wheel nuts. If you have to replace them, be sure to get new GM original equipment wheel nuts.**

**Stop somewhere as soon as you can and have the nuts tightened with a torque wrench to 100 lb-ft (140 N·m).**



## **NOTICE:**

Improperly tightened wheel nuts can lead to brake pulsation and rotor damage. To avoid expensive brake repairs, evenly tighten the wheel nuts in the proper sequence and to the proper torque specification.

Don't try to put a wheel cover on your compact spare tire. It won't fit. Store the wheel cover in the trunk until you have the flat tire repaired or replaced.

## **NOTICE:**

Wheel covers won't fit on your compact spare. If you try to put a wheel cover on your compact spare, you could damage the cover or the spare.

## Storing the Flat Tire and Tools



## **CAUTION:**

Storing a jack, a tire or other equipment in the passenger compartment of the vehicle could cause injury. In a sudden stop or collision, loose equipment could strike someone. Store all these in the proper place.

After you've put the compact spare tire on your vehicle, you'll need to store the flat tire in your trunk. Use the following procedure to secure the flat tire in the trunk.

Store the flat tire as far forward in the trunk as possible. Store the jack and wheel wrench in their compartment in the trunk.

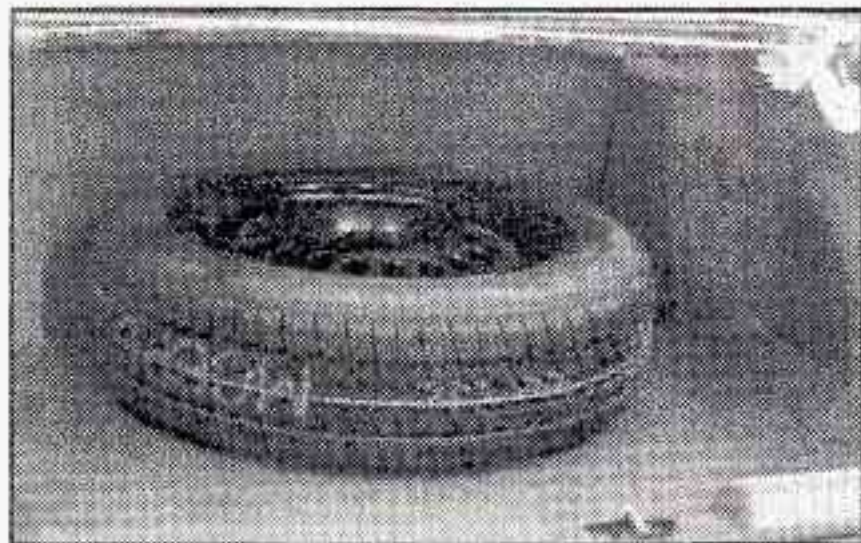

## Storing the Spare Tire and Tools

### CAUTION:

Storing a jack, a tire or other equipment in the passenger compartment of the vehicle could cause injury. In a sudden stop or collision, loose equipment could strike someone. Store all these in the proper place.

Store the compact spare tire and tools as shown in the diagram.

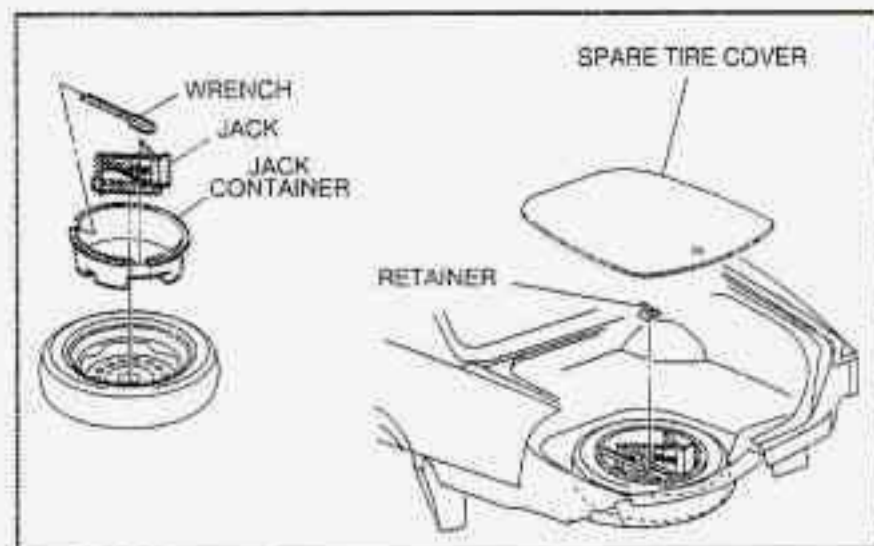

The compact spare tire is for temporary use only. Replace the compact spare tire with a full-size tire as soon as you can. See "Compact Spare Tire" later in this section.

## Compact Spare Tire

Although the compact spare tire was fully inflated when your vehicle was new, it can lose air after a time. Check the inflation pressure regularly. It should be 60 psi (420 kPa).

After installing the compact spare on your vehicle, you should stop as soon as possible and make sure your spare tire is correctly inflated. The compact spare is made to perform well at speeds up to 65 mph (105 km/h) for distances up to 1,000 miles (1,600 km), so you can finish your trip and have your full-size tire repaired or replaced where you want. You must calibrate the Check Tire Pressure System after installing or removing the compact spare. See "Check Tire Pressure System" in the Index. Of course, it's best to replace your spare with a full-size tire as soon as you can. Your spare will last longer and be in good shape in case you need it again.



## **NOTICE:**

When the compact spare is installed, don't take your vehicle through an automatic car wash with guide rails. The compact spare can get caught on the rails. That can damage the tire and wheel, and maybe other parts of your vehicle.

Don't use your compact spare on other vehicles.

And don't mix your compact spare tire or wheel with other wheels or tires. They won't fit. Keep your spare tire and its wheel together.

## **NOTICE:**

Tire chains won't fit your compact spare. Using them can damage your vehicle and can damage the chains too. Don't use tire chains on your compact spare.

## **If You're Stuck: In Sand, Mud, Ice or Snow**

What you don't want to do when your vehicle is stuck is to spin your wheels too fast. The method known as "rocking" can help you get out when you're stuck, but you must use caution.



## **CAUTION:**

If you let your tires spin at high speed, they can explode, and you or others could be injured. And, the transaxle or other parts of the vehicle can overheat. That could cause an engine compartment fire or other damage. When you're stuck, spin the wheels as little as possible. Don't spin the wheels above 35 mph (55 km/h) as shown on the speedometer.

## **NOTICE:**

**Spinning your wheels can destroy parts of your vehicle as well as the tires. If you spin the wheels too fast while shifting your transaxle back and forth, you can destroy your transaxle.**

For information about using tire chains on your vehicle, see "Tire Chains" in the Index.

## **Rocking Your Vehicle To Get It Out**

First, turn your steering wheel left and right. That will clear the area around your front wheels. If your vehicle has traction control, you should turn the system off. (See "Traction Control System" in the Index.) Then shift back and forth between REVERSE (R) and a forward gear, spinning the wheels as little as possible. Release the accelerator pedal while you shift, and press lightly on the accelerator pedal when the transaxle is in gear. If that doesn't get you out after a few tries, you may need to be towed out. If you do need to be towed out, see "Towing Your Vehicle" in the index.







## Section 6 Service and Appearance Care

---

Here you will find information about the care of your vehicle. This section begins with service and fuel information, and then it shows how to check important fluid and lubricant levels. There is also technical information about your vehicle, and a part devoted to its appearance care.

6-2	Service	6-55	Appearance Care
6-3	Fuel	6-55	Cleaning the Inside of Your Vehicle
6-9	Checking Things Under the Hood	6-59	Cleaning the Outside of Your Vehicle
6-12	Engine Oil	6-61	Underbody Maintenance
6-17	Air Cleaner	6-61	Chemical Paint Spotting
6-19	Supercharger Oil	6-62	Appearance Care Materials Chart
6-20	Automatic Transaxle Fluid	6-63	Vehicle Identification Number (VIN)
6-23	Engine Coolant	6-64	Electrical System
6-27	Radiator Pressure Cap	6-70	Removing the Rear Seat Cushion
6-28	Windshield Washer Fluid	6-71	Replacement Bulbs
6-29	Brakes	6-72	Capacities and Specifications
6-32	Battery	6-73	Air Conditioning Refrigerants
6-33	Bulb Replacement	6-73	Engine Specifications
6-45	Windshield Wiper Blade Replacement	6-74	Vehicle Dimensions
6-46	Tires	6-74	Normal Maintenance Replacement Parts

## Service

Your dealer knows your vehicle best and wants you to be happy with it. We hope you'll go to your dealer for all your service needs. You'll get genuine GM parts and GM-trained and supported service people.

We hope you'll want to keep your GM vehicle all GM. Genuine GM parts have one of these marks:

***ACDelco***

---

Genuine

**GM**

---

**GM**

**Goodwrench**

## Doing Your Own Service Work

If you want to do some of your own service work, you'll want to use the proper Buick Service Manual. It tells you much more about how to service your vehicle than this manual can. To order the proper service manual, see "Service and Owner Publications" in the Index.

Your vehicle has an air bag system. Before attempting to do your own service work, see "Servicing Your Air Bag-Equipped Vehicle" in the Index.

You should keep a record with all parts receipts and list the mileage and the date of any service work you perform. See "Maintenance Record" in the Index.

 **CAUTION:**

**You can be injured and your vehicle could be damaged if you try to do service work on a vehicle without knowing enough about it.**

- **Be sure you have sufficient knowledge, experience, the proper replacement parts and tools before you attempt any vehicle maintenance task.**
- **Be sure to use the proper nuts, bolts and other fasteners. "English" and "metric" fasteners can be easily confused. If you use the wrong fasteners, parts can later break or fall off. You could be hurt.**

### Adding Equipment to the Outside of Your Vehicle

Things you might add to the outside of your vehicle can affect the airflow around it. This may cause wind noise and affect windshield washer performance. Check with your dealer before adding equipment to the outside of your vehicle.

## Fuel

The 8th digit of your vehicle identification number (VIN) shows the code letter for your engine. You will find the VIN at the top left of your instrument panel. (See "Vehicle Identification Number" in the Index.)

If you have the 3800 engine (VIN Code K), use regular unleaded gasoline rated at 87 octane or higher. If you're using fuel rated at the recommended octane or higher and you hear heavy knocking, your engine needs service. But don't worry if you hear a little pinging noise when you're accelerating or driving up a hill. That's normal, and you don't have to buy a higher octane fuel to get rid of pinging. It's the heavy, constant knock that means you have a problem.

If you have the 3800 Supercharged engine (VIN Code 1), use premium unleaded gasoline rated at 91 octane or higher. With the 3800 Supercharged engine, in an emergency, you may be able to use a lower octane -- as low as 87 -- if heavy knocking does not occur. If you are using 91 or higher octane unleaded gasoline and you hear heavy knocking, your engine needs service.



At a minimum, the gasoline you use should meet specifications ASTM D4814 in the United States and CGSB 3.5-M93 in Canada. Improved gasoline specifications have been developed by the American Automobile Manufacturers Association (AAMA) for better vehicle performance and engine protection. Gasolines meeting the AAMA specification could provide improved driveability and emission control system protection compared to other gasolines.

Be sure the posted octane for premium is at least 91 (at least 89 for middle grade and 87 for regular). If the octane is less than 87, you may get a heavy knocking noise when you drive. If it's bad enough, it can damage your engine.

If your vehicle is certified to meet California Emission Standards (indicated on the underhood emission control label), it is designed to operate on fuels that meet California specifications. If such fuels are not available in states adopting California emissions standards, your vehicle will operate satisfactorily on fuels meeting federal specifications, but emission control system performance may be affected. The malfunction indicator lamp on your instrument panel may turn on and/or your vehicle may fail a smog-check test. If this occurs, return to your authorized Buick dealer for diagnosis to

determine the cause of failure. In the event it is determined that the cause of the condition is the type of fuels used, repairs may not be covered by your warranty.

Some gasolines that are not reformulated for low emissions contain an octane-enhancing additive called methylcyclopentadienyl manganese tricarbonyl (MMT); ask your service station operator whether or not his fuel contains MMT. General Motors does not recommend the use of such gasolines. If fuels containing MMT are used, spark plug life may be reduced and your emission control system performance may be affected. The malfunction indicator lamp on your instrument panel may turn on. If this occurs, return to your authorized Buick dealer for service.

To provide cleaner air, all gasolines in the United States are now required to contain additives that will help prevent deposits from forming in your engine and fuel system, allowing your emission control system to function properly. Therefore, you should not have to add anything to the fuel. In addition, gasolines containing oxygenates, such as ethers and ethanol, and reformulated gasolines may be available in your area to help clean the air. General Motors recommends that you use these gasolines if they comply with the specifications described earlier.

## NOTICE:

Your vehicle was not designed for fuel that contains methanol. Don't use it. It can corrode metal parts in your fuel system and also damage plastic and rubber parts. That damage wouldn't be covered under your warranty.

## Fuels in Foreign Countries

If you plan on driving in another country outside the United States or Canada, the proper fuel may be hard to find. Never use leaded gasoline or any other fuel not recommended in the previous text on fuel. Costly repairs caused by use of improper fuel wouldn't be covered by your warranty.

To check on fuel availability, ask an auto club, or contact a major oil company that does business in the country where you'll be driving.

You can also write us at the following address for advice. Just tell us where you're going and give your Vehicle Identification Number (VIN).

General Motors Overseas Distribution Corporation  
1908 Colonel Sam Drive  
Oshawa, Ontario L1H 8P7

## Filling Your Tank

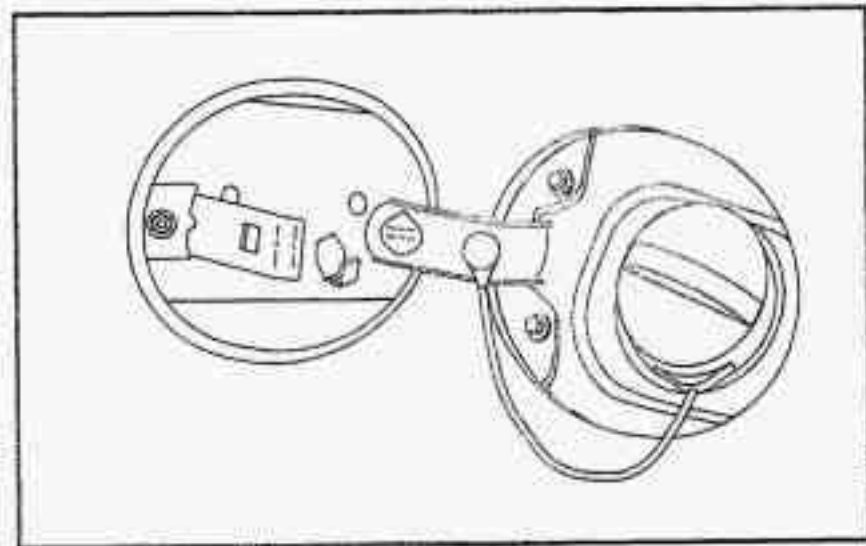

The cap is behind a hinged door on the driver's side of your vehicle.



**⚠ CAUTION:**

**Gasoline vapor is highly flammable. It burns violently, and that can cause very bad injuries. Don't smoke if you're near gasoline or refueling your vehicle. Keep sparks, flames and smoking materials away from gasoline.**

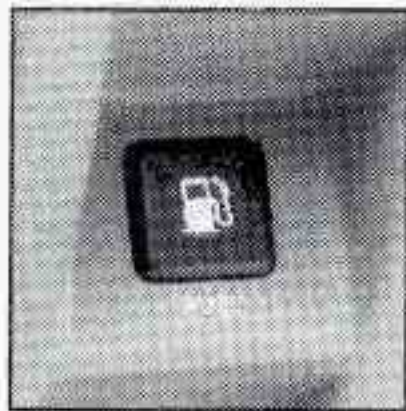

The release button for the fuel door is to the left of the steering column.



There is also a manual fuel door release. This mechanism is located in the top of the trunk compartment, on the driver's side of the vehicle. Pull the white tab to release the fuel door.



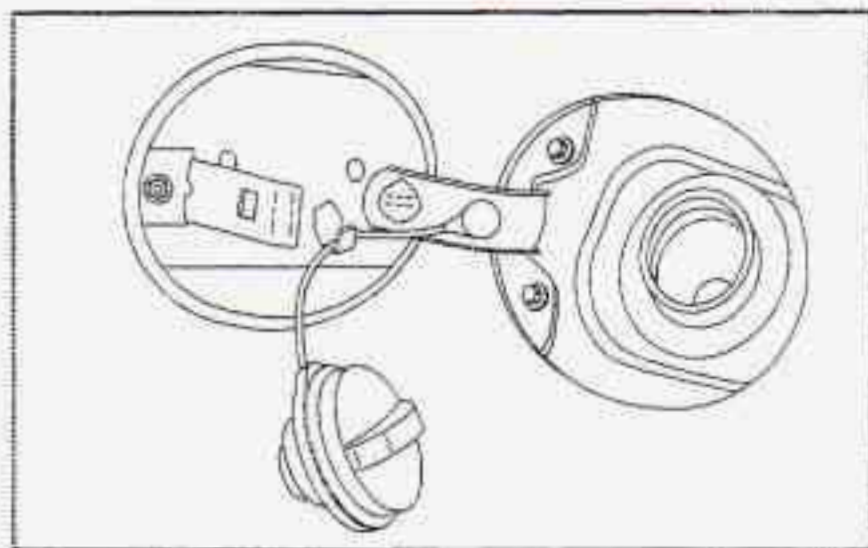

While refueling, hang the tethered cap on the fuel door latch. To remove the cap, turn it slowly to the left. The cap has a spring in it; if you let go of the cap too soon, it will spring back to the right.

**⚠ CAUTION:**

If you get gasoline on yourself and then something ignites it, you could be badly burned. Gasoline can spray out on you if you open the fuel filler cap too quickly. This spray can happen if your tank is nearly full, and is more likely in hot weather. Open the fuel filler cap slowly and wait for any “hiss” noise to stop. Then unscrew the cap all the way.

Be careful not to spill gasoline. Clean gasoline from painted surfaces as soon as possible. See “Cleaning the Outside of Your Vehicle” in the Index.

When you put the cap back on, turn it to the right until you hear a clicking sound. Make sure you fully install the cap. The diagnostic system can determine if the fuel cap has been left off or improperly installed. This would allow fuel to evaporate into the atmosphere. See "Malfunction Indicator Lamp" in the Index.

### **NOTICE:**

If you need a new cap, be sure to get the right type. Your dealer can get one for you. If you get the wrong type, it may not fit properly. This may cause your malfunction indicator lamp to light and your fuel tank and emissions system may be damaged. See "Malfunction Indicator Lamp" in the Index.

## Filling a Portable Fuel Container

### **CAUTION:**

Never fill a portable fuel container while it is in your vehicle. Static electricity discharge from the container can ignite the gasoline vapor. You can be badly burned and your vehicle damaged if this occurs. To help avoid injury to you and others:

- Dispense gasoline only into approved containers.
- Do not fill a container while it is inside a vehicle, in a vehicle's trunk, pickup bed or on any surface other than the ground.
- Bring the fill nozzle in contact with the inside of the fill opening before operating the nozzle. Contact should be maintained until the filling is complete.
- Don't smoke while pumping gasoline.

## Checking Things Under the Hood

### CAUTION:

An electric fan under the hood can start up and injure you even when the engine is not running. Keep hands, clothing and tools away from any underhood electric fan.

### CAUTION:

Things that burn can get on hot engine parts and start a fire. These include liquids like gasoline, oil, coolant, brake fluid, windshield washer and other fluids, and plastic or rubber. You or others could be burned. Be careful not to drop or spill things that will burn onto a hot engine.

## Hood Release



To open the hood, pull the handle inside the vehicle. It is located on the lower left side of the instrument panel.



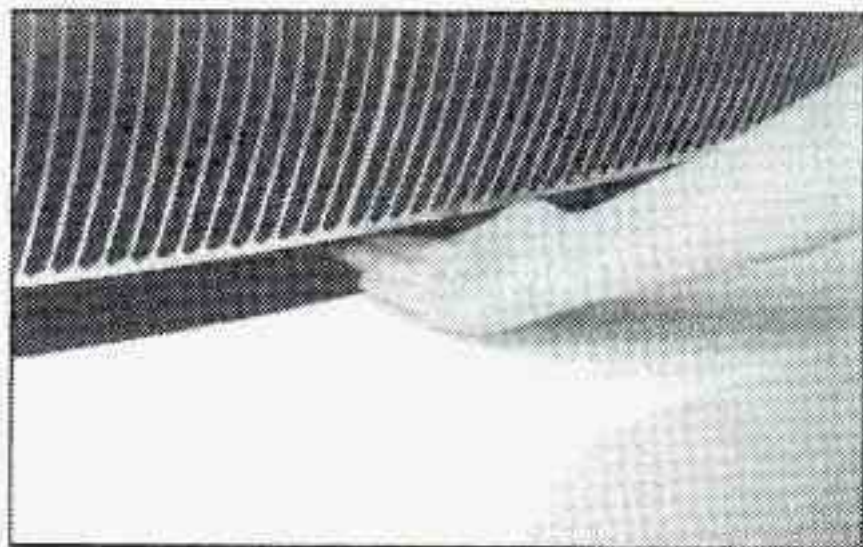

Then go to the front of the vehicle and locate the secondary hood release. It is under the front edge of the grille.

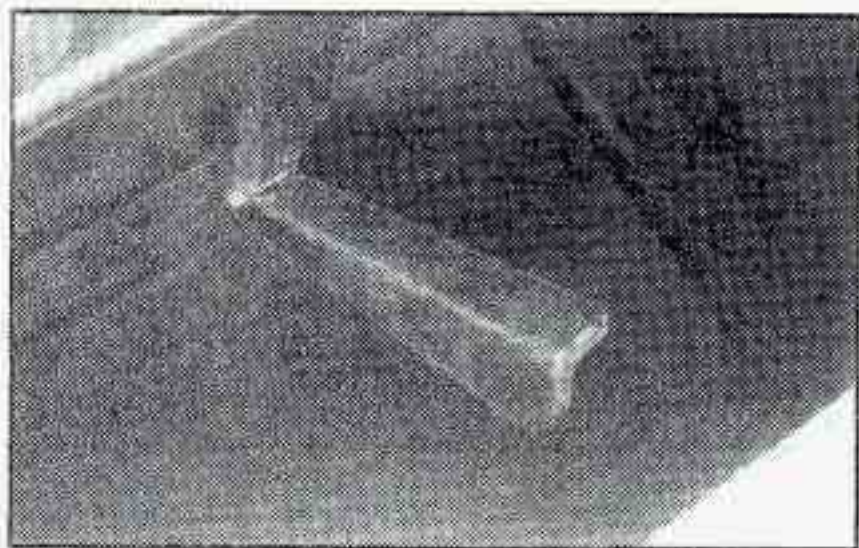

Lift up on this black lever as you lift up the hood.  
Before closing the hood, be sure all the filler caps are on properly. Then pull the hood down and close it firmly.

## 3800 Series II (Code K) Engine (L36)

When you open the hood on the 3800 (L36) engine, here's what you will see (3800 Supercharged (L67) engine similar):

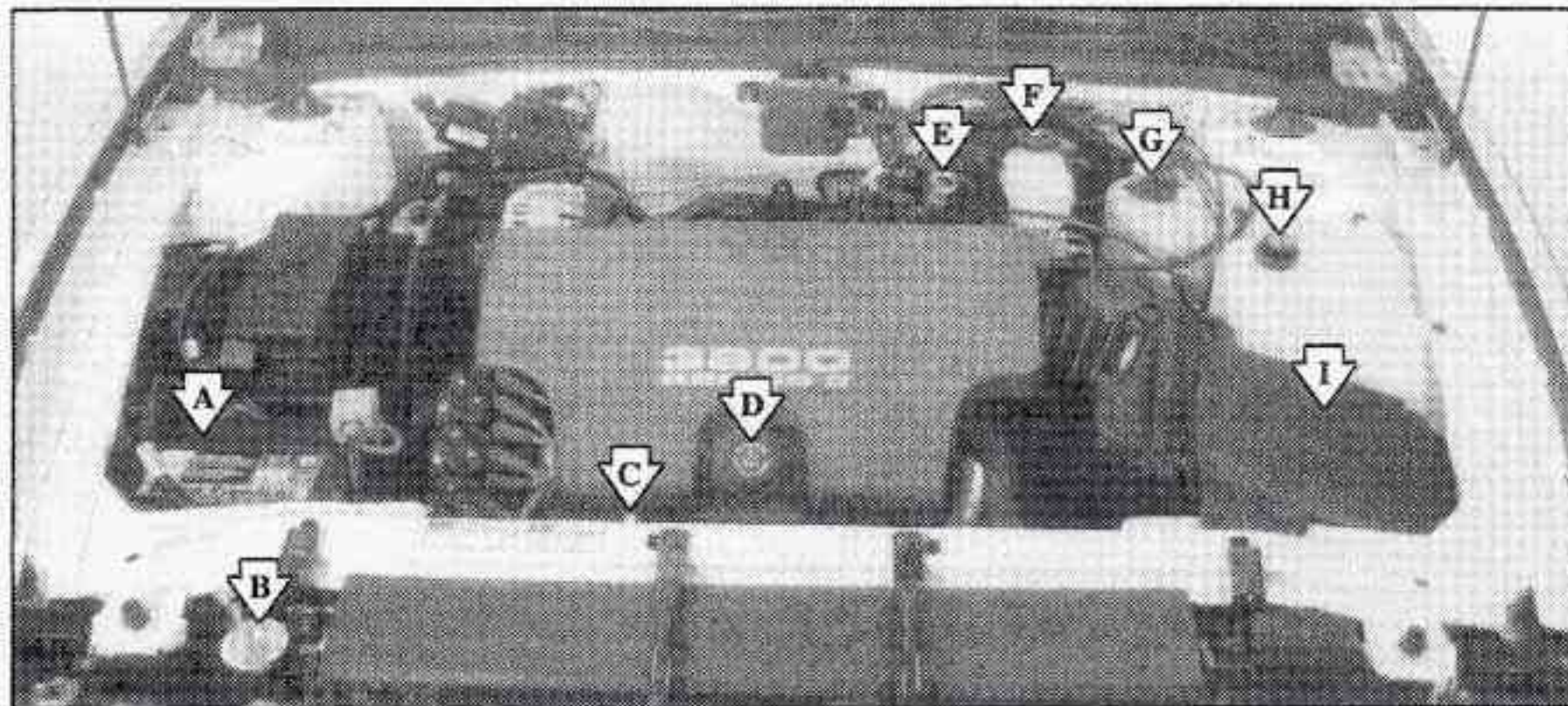

A. Battery

B. Radiator Pressure Cap

C. Engine Oil Dipstick

D. Engine Oil Fill Cap

E. Automatic Transaxle Fluid  
Dipstick

F. Brake Master Cylinder

G. Windshield Washer Fluid Reservoir

H. Engine Coolant Recovery Tank

I. Air Cleaner



Your vehicle may have a 3800 Supercharged engine. Supercharging, rather than turbocharging, emphasizes smooth, refined power.

The supercharger is a device which is designed to pump more air into the engine than it would normally use. This air mixed with fuel creates increased engine power. Since the supercharger is a pump and is driven from an engine accessory drive belt, increased pressure is available at all driving conditions.

The Powertrain Control Module (PCM) works with a vacuum control to regulate the increased pressure required during specific driving conditions. When this increased pressure or boost is not desired, such as during idling and light throttle cruising, the excess air that the supercharger is pumping is routed through a bypass. All of these controls working together provide high performance character and fuel efficiency in the 3800 V6 Supercharged engine.

The power steering pump and reservoir are mounted on the rear (driver's side) of the engine block. See "Maintenance Schedule" in the Index for when you should check the fluid.

## Engine Oil

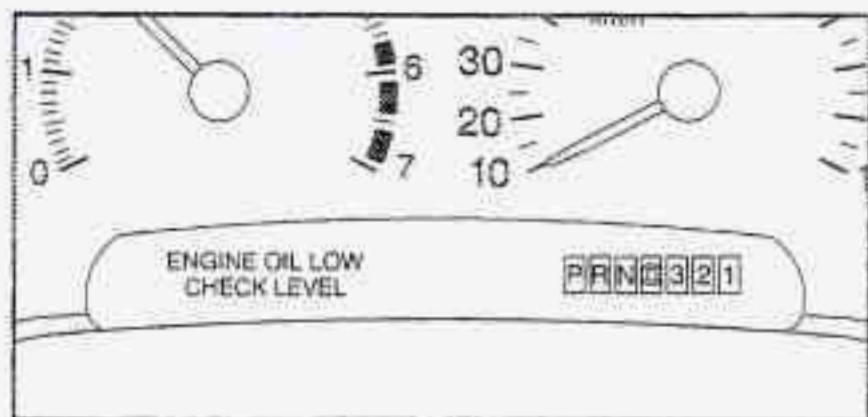

If you have the Driver Information Center, an ENGINE OIL LOW-CHECK LEVEL message will appear when the engine oil is approximately 1 quart (1L) low. If the message is displayed, check the dipstick level and add oil as needed.



It's a good idea to check your engine oil every time you get fuel. In order to get an accurate reading, the oil must be warm and the vehicle must be on level ground.



Turn off the engine and give the oil a few minutes to drain back into the oil pan. If you don't, the oil dipstick might not show the actual level.

### Checking Engine Oil

Pull out the dipstick and clean it with a paper towel or cloth, then push it back in all the way. Remove it again, keeping the tip down, and check the level.



## When to Add Engine Oil

If the oil is at or below the ADD mark, then you'll need to add at least one quart of oil. But you must use the right kind. This part explains what kind of oil to use. For crankcase capacity, see "Capacities and Specifications" in the Index.

### **NOTICE:**

**Don't add too much oil.** If your engine has so much oil that the oil level gets above the cross-hatched area that shows the proper operating range, your engine could be damaged.

Add engine oil at the engine oil fill cap next to the oil dipstick.

Be sure to fill it enough to put the level somewhere in the proper operating range. Push the dipstick all the way back in when you're through.

## What Kind of Engine Oil to Use

Oils recommended for your vehicle can be identified by looking for the "Starburst" symbol. This symbol indicates that the oil has been certified by the American Petroleum Institute (API). Do not use any oil which does not carry this Starburst symbol.



If you change your own oil, be sure you use oil that has the Starburst symbol on the front of the oil container. If you have your oil changed for you, be sure the oil put into your engine is American Petroleum Institute certified for gasoline engines.

You should also use the proper viscosity oil for your vehicle, as shown in the following chart:

### RECOMMENDED SAE VISCOSITY GRADE ENGINE OILS

FOR BEST FUEL ECONOMY AND COLD STARTING, SELECT THE LOWEST SAE VISCOSITY GRADE OIL FOR THE EXPECTED TEMPERATURE RANGE.

HOT  
WEATHER

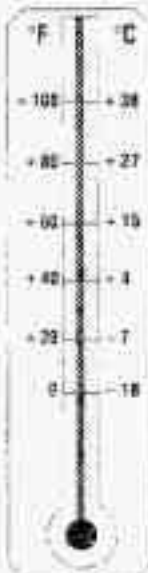

LOOK  
FOR THIS  
SYMBOL



SAE 5W-30

SAE 10W-30  
PREFERRED  
above 0°F  
(-18°C)

COLD  
WEATHER

DO NOT USE SAE 20W-50 OR ANY  
OTHER GRADE OIL. NOT RECOMMENDED

As shown in the chart, SAE 10W-30 is best for your vehicle. However, you can use SAE 5W-30 if it's going to be colder than 60°F (16°C) before your next oil change. When it's very cold, you should use SAE 5W-30. These numbers on an oil container show its viscosity, or thickness. Do not use other viscosity oils, such as SAE 20W-50.

### NOTICE:

Use only engine oil with the American Petroleum Institute Certified For Gasoline Engines "Starburst" symbol. Failure to use the recommended oil can result in engine damage not covered by your warranty.

GM Goodwrench<sup>®</sup> oil meets all the requirements for your vehicle.

If you are in an area where the temperature falls below -20°F (-29°C), consider using either an SAE 5W-30 synthetic oil or an SAE 0W-30 oil. Both will provide easier cold starting and better protection for your engine at extremely low temperatures.



## Engine Oil Additives

Don't add anything to your oil. Your dealer is ready to advise if you think something should be added.

## When to Change Engine Oil

If any one of these is true for you, use the short trip/city maintenance schedule:

- Most trips are less than 5 to 10 miles (8 to 16 km). This is particularly important when outside temperatures are below freezing.
- Most trips include extensive idling (such as frequent driving in stop-and-go traffic).
- Most trips are through dusty areas.
- You frequently tow a trailer or use a carrier on top of your vehicle.
- The vehicle is used for delivery service, police, taxi or other commercial application.

Driving under these conditions causes engine oil to break down sooner. If any one of these is true for your vehicle, then you need to change your oil and filter every 3,000 miles (5 000 km) or 3 months -- whichever occurs first. (See Engine Oil Life Monitor (Index) in the Index.)

If none of them is true, use the long trip/highway maintenance schedule. Change the oil and filter every 7,500 miles (12 500 km) or 12 months -- whichever occurs first. Driving a vehicle with a fully warmed engine under highway conditions causes engine oil to break down slower.

## What to Do with Used Oil

Did you know that used engine oil contains certain elements that may be unhealthy for your skin and could even cause cancer? Don't let used oil stay on your skin for very long. Clean your skin and nails with soap and water, or a good hand cleaner. Wash or properly throw away clothing or rags containing used engine oil. (See the manufacturer's warnings about the use and disposal of oil products.)

Used oil can be a real threat to the environment. If you change your own oil, be sure to drain all free-flowing oil from the filter before disposal. Don't ever dispose of oil by putting it in the trash, pouring it on the ground, into sewers, or into streams or bodies of water. Instead, recycle it by taking it to a place that collects used oil. If you have a problem properly disposing of your used oil, ask your dealer, a service station or a local recycling center for help.

## Air Cleaner

The air cleaner is in the front right section of the engine compartment.

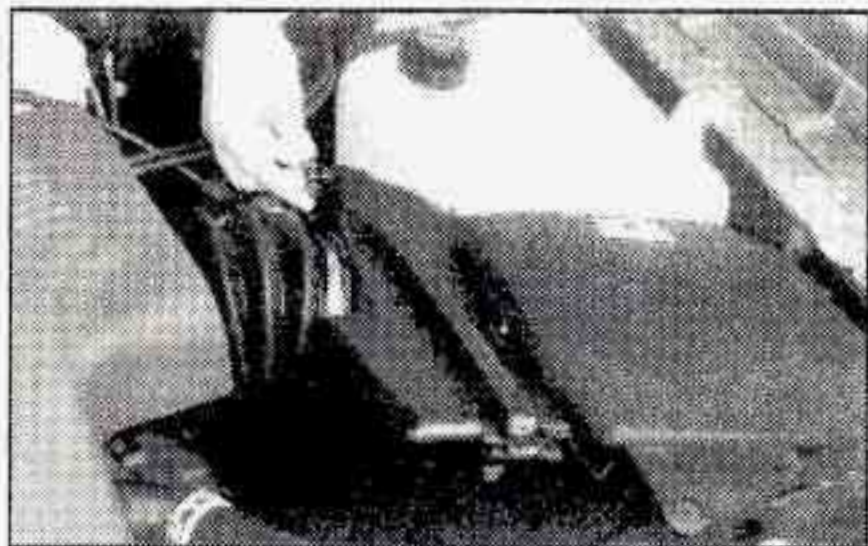
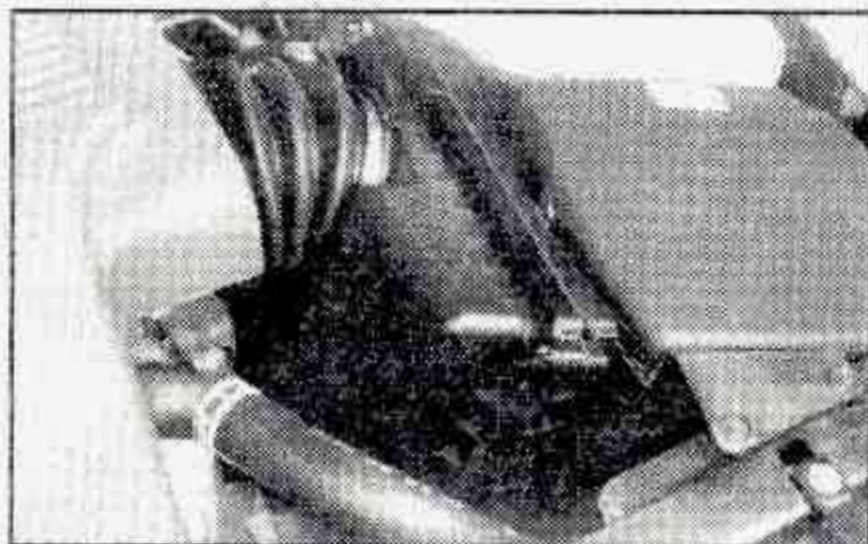

1. Remove the wing nuts on the air cleaner housing cover.



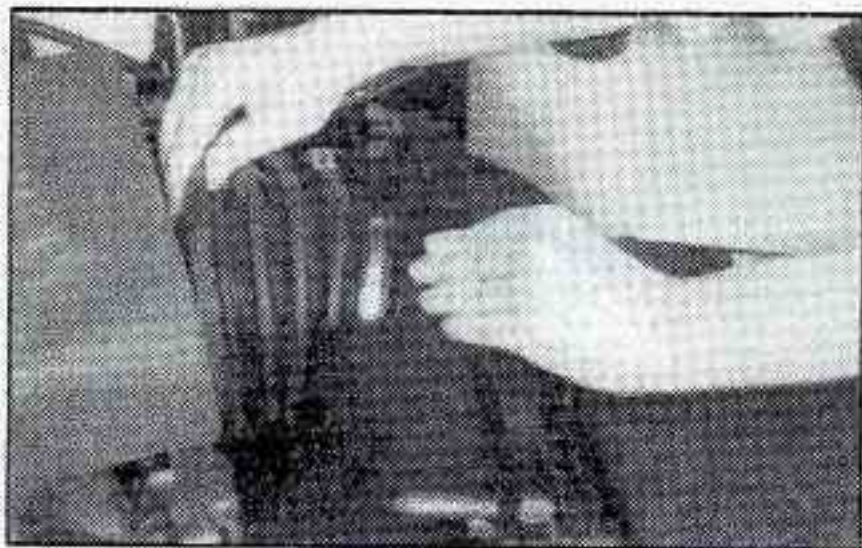

2. Remove the air intake hose that snaps over the throttle body by pulling the hose upward and away from the throttle body. As you are detaching the hose, remove the air cleaner housing cover by pulling upward and rearward.

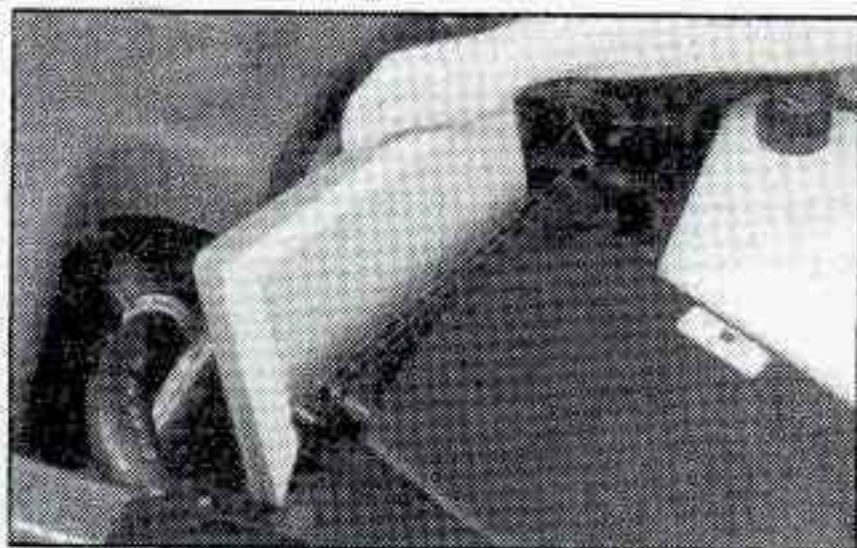

3. Replace the air filter.
4. Reattach the air intake hose.
5. Reinstall the air cleaner housing cover.

Refer to the Maintenance Schedule to determine when to replace the air filter.

See "Scheduled Maintenance Services" in the Index.



## CAUTION:

Operating the engine with the air cleaner off can cause you or others to be burned. The air cleaner not only cleans the air, it stops flame if the engine backfires. If it isn't there, and the engine backfires, you could be burned. Don't drive with it off, and be careful working on the engine with the air cleaner off.

## NOTICE:

If the air cleaner is off, a backfire can cause a damaging engine fire. And, dirt can easily get into your engine, which will damage it. Always have the air cleaner in place when you're driving.

## Supercharger Oil



Unless you are technically qualified and have the proper tools, you should let your dealer or a qualified service center perform this maintenance.

### When to Check

Check oil level every 30,000 miles (50,000 km) or every 36 months, whichever occurs first.

### What Kind of Oil to Use

See "Recommended Fluids and Lubricants" in the Index and use only the recommended oil.

## How to Check and Add Oil

Check oil only when the engine is cold. Allow the engine to cool two to three hours after running.



### CAUTION:

**If you remove the supercharger oil fill plug while the engine is hot, pressure may cause hot oil to blow out of the oil fill hole. You may be burned. Do not remove the plug until the engine cools.**

1. Clean the area around the oil fill plug before removing it.
2. Remove the oil fill plug using a 3/16 inch Allen wrench.
3. The oil level is correct when it just reaches the bottom of the threads of the inspection hole.
4. Replace the oil plug with the O-ring in place. Torque to 88 lb-in (10 N·m).

## Automatic Transaxle Fluid

### When to Check and Change

A good time to check your automatic transaxle fluid level is when the engine oil is changed.

Change both the fluid and filter every 50,000 miles (83 000 km) if the vehicle is mainly driven under one or more of these conditions:

- In heavy city traffic where the outside temperature regularly reaches 90°F (32°C) or higher.
- In hilly or mountainous terrain.
- When doing frequent trailer towing.
- Uses such as found in taxi, police or delivery service.

If you do not use your vehicle under any of these conditions, the fluid and filter do not require changing.

See "Scheduled Maintenance Services" in the Index.

## How to Check

Because this operation can be a little difficult, you may choose to have this done at your Buick dealership Service Department.

If you do it yourself, be sure to follow all the instructions here, or you could get a false reading on the dipstick.

### **NOTICE:**

**Too much or too little fluid can damage your transaxle. Too much can mean that some of the fluid could come out and fail on hot engine parts or exhaust system parts, starting a fire. Be sure to get an accurate reading if you check your transaxle fluid.**

Wait at least 30 minutes before checking the transaxle fluid level if you have been driving:

- When outside temperatures are above 90°F (32°C).
- At high speed for quite a while.
- In heavy traffic -- especially in hot weather.
- While pulling a trailer.

To get the right reading, the fluid should be at normal operating temperature, which is 180°F to 200°F (82°C to 93°C).

Get the vehicle warmed up by driving about 15 miles (24 km) when outside temperatures are above 50°F (10°C). If it's colder than 50°F (10°C), you may have to drive longer.

### Checking the Fluid Level

- Park your vehicle on a level place. Keep the engine running.
- With the parking brake applied, place the shift lever in PARK (P).
- With your foot on the brake pedal, move the shift lever through each gear range, pausing for about three seconds in each range. Then, position the shift lever in PARK (P).
- Let the engine run at idle for three to five minutes.



Then, without shutting off the engine, follow these steps:



1. The transaxle fluid dipstick top is a round, red loop and is next to the brake master cylinder behind the engine block. Pull out the dipstick and wipe it with a clean rag or paper towel.

2. Push it back in all the way, wait three seconds and then pull it back out again.

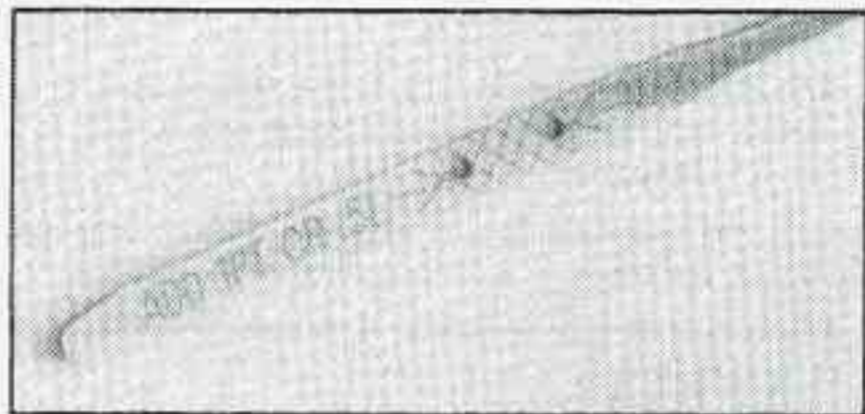

3. Check both sides of the dipstick, and read the lower level. The fluid level must be in the cross-hatched area.
4. If the fluid level is in the acceptable range, push the dipstick back in all the way.

## How to Add Fluid

Refer to the Maintenance Schedule to determine what kind of transaxle fluid to use. See "Recommended Fluids and Lubricants" in the Index.

If the fluid level is low, add only enough of the proper fluid to bring the level into the cross-hatched area on the dipstick.

1. Pull out the dipstick.
2. Using a long-neck funnel, add enough fluid at the dipstick hole to bring it to the proper level.

It doesn't take much fluid, generally less than one pint (0.5 L). *Don't overfill.*

### **NOTICE:**

**We recommend you use only fluid labeled DEXRON®-III, because fluid with that label is made especially for your automatic transaxle. Damage caused by fluid other than DEXRON-III is not covered by your new vehicle warranty.**

3. After adding fluid, recheck the fluid level as described under "How to Check."
4. When the correct fluid level is obtained, push the dipstick back in all the way.

## Engine Coolant

The cooling system in your vehicle is filled with DEX-COOL® engine coolant. This coolant is designed to remain in your vehicle for 5 years or 150,000 miles (240 000 km), whichever occurs first, if you add only DEX-COOL® extended life coolant.

The following explains your cooling system and how to add coolant when it is low. If you have a problem with engine overheating, see "Engine Overheating" in the Index.

A 50/50 mixture of water and DEX-COOL® coolant will:

- Give freezing protection down to -34°F (-37°C).
- Give boiling protection up to 265°F (129°C).
- Protect against rust and corrosion.
- Help keep the proper engine temperature.
- Let the warning lights and gages work as they should.

## NOTICE:

When adding coolant, it is important that you use only DEX-COOL<sup>®</sup> (silicate-free) coolant.

If coolant other than DEX-COOL is added to the system, premature engine, heater core or radiator corrosion may result. In addition, the engine coolant will require change sooner -- at 30,000 miles (50 000 km) or 24 months, whichever occurs first. Damage caused by the use of coolant other than DEX-COOL<sup>®</sup> is not covered by your new vehicle warranty.

## What to Use

Use a mixture of one-half *clean water* (preferably distilled) and one-half DEX-COOL<sup>®</sup> coolant which won't damage aluminum parts. If you use this mixture, you don't need to add anything else.



## CAUTION:

Adding only plain water to your cooling system can be dangerous. Plain water, or some other liquid like alcohol, can boil before the proper coolant mixture will. Your vehicle's coolant warning system is set for the proper coolant mixture. With plain water or the wrong mixture, your engine could get too hot but you wouldn't get the overheat warning. Your engine could catch fire and you or others could be burned. Use a 50/50 mixture of clean water and DEX-COOL<sup>®</sup> coolant.



## **NOTICE:**

If you use an improper coolant mixture, your engine could overheat and be badly damaged. The repair cost wouldn't be covered by your warranty. Too much water in the mixture can freeze and crack the engine, radiator, heater core and other parts.

If you have to add coolant more than four times a year, have your dealer check your cooling system.

## **NOTICE:**

If you use the proper coolant, you don't have to add extra inhibitors or additives which claim to improve the system. These can be harmful.

## Checking Coolant

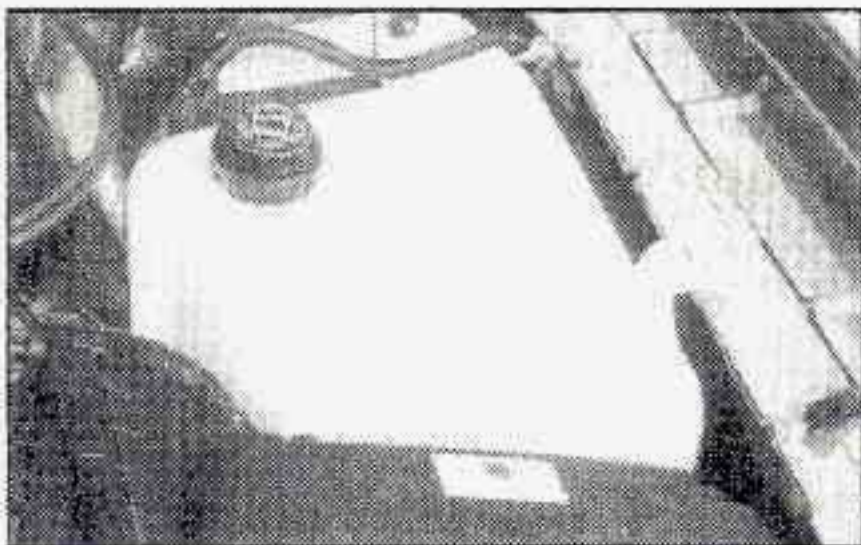

The coolant recovery tank is located on the driver's side of the engine compartment.

When your engine is cold, the coolant level should be at **FULL COLD** or a little higher. When your engine is warm, the level should be up to **FULL HOT** or a little higher.

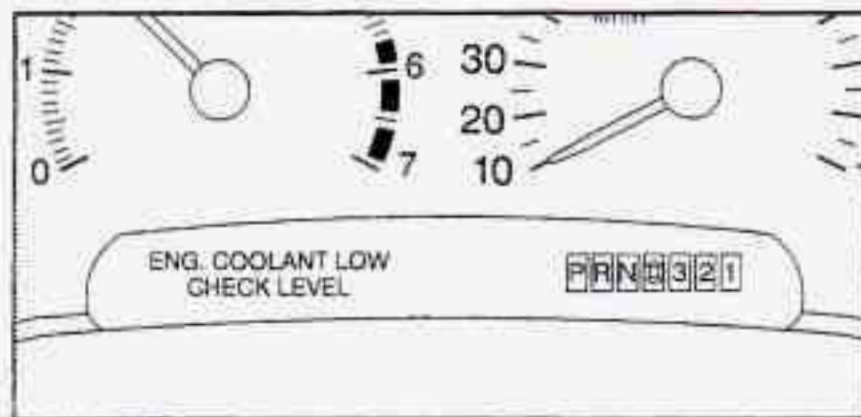

If this ENG. COOLANT LOW-CHECK LEVEL message comes on, it means you're low on engine coolant.

#### Adding Coolant

If you need more coolant, add the proper DEX-COOL<sup>®</sup> coolant mixture *at the coolant recovery tank*, but be careful not to spill it.

#### CAUTION:

Turning the radiator pressure cap when the engine and radiator are hot can allow steam and scalding liquids to blow out and burn you badly. With the coolant recovery tank, you will almost never have to add coolant at the radiator. Never turn the radiator pressure cap -- even a little -- when the engine and radiator are hot.

#### CAUTION:

You can be burned if you spill coolant on hot engine parts. Coolant contains ethylene glycol, and it will burn if the engine parts are hot enough. Don't spill coolant on a hot engine.

## Radiator Pressure Cap

### **NOTICE:**

Your radiator pressure cap is a 15 psi (105 kPa) pressure-type cap and must be tightly installed to prevent coolant loss and possible engine damage from overheating. Be sure the arrows on the cap line up with the overflow tube on the radiator filler neck.

When you replace your radiator pressure cap, an AC<sup>®</sup> cap is recommended.

## Thermostat

Engine coolant temperature is controlled by a thermostat in the engine coolant system. The thermostat stops the flow of coolant through the radiator until the coolant reaches a preset temperature.

When you replace your thermostat, an AC<sup>®</sup> thermostat is recommended.

## Power Steering Fluid



## When to Check Power Steering Fluid

It is not necessary to regularly check power steering fluid unless you suspect there is a leak in the system or you hear an unusual noise. A fluid loss in this system could indicate a problem. Have the system inspected and repaired.

The power steering fluid reservoir on the L36 and L67 engine is located below the generator and behind the accessory drive belt on the driver's side toward the rear of the engine.



## How To Check Power Steering Fluid

When the engine compartment is cool, wipe the cap and the top of the reservoir clean, then unscrew the cap and wipe the dipstick with a clean rag. Replace the cap and completely tighten it. Then remove the cap again and look at the fluid level on the dipstick.

The level should be at the FULL COLD mark. If necessary, add only enough fluid to bring the level up to the mark.

### What to Use

To determine what kind of fluid to use, see "Recommended Fluids and Lubricants" in the Index. Always use the proper fluid. Failure to use the proper fluid can cause leaks and damage hoses and seals.

## Windshield Washer Fluid

### What to Use

When you need windshield washer fluid, be sure to read the manufacturer's instructions before use. If you will be operating your vehicle in an area where the temperature may fall below freezing, use a fluid that has sufficient protection against freezing.

## Adding Washer Fluid

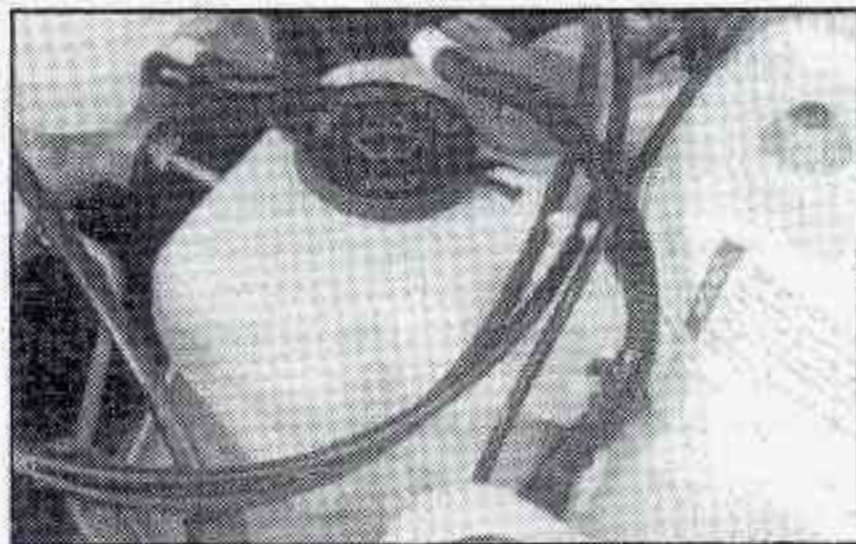

The windshield washer fluid reservoir is located by the coolant recovery tank on the driver's side of the engine compartment.

Open the cap labeled WASHER FLUID ONLY. Add washer fluid until the tank is full.

## NOTICE:

- When using concentrated washer fluid, follow the manufacturer's instructions for adding water.
- Don't mix water with ready-to-use washer fluid. Water can cause the solution to freeze and damage your washer fluid tank and other parts of the washer system. Also, water doesn't clean as well as washer fluid.
- Fill your washer fluid tank only three-quarters full when it's very cold. This allows for expansion if freezing occurs, which could damage the tank if it is completely full.
- Don't use engine coolant (antifreeze) in your windshield washer. It can damage your washer system and paint.

## Brakes

### Brake Fluid



Your brake master cylinder reservoir is here. It is filled with DOT-3 brake fluid.

There are only two reasons why the brake fluid level in the reservoir might go down. The first is that the brake fluid goes down to an acceptable level during normal brake lining wear. When new linings are put in, the fluid level goes back up. The other reason is that fluid is leaking out of the brake system. If it is, you should have your brake system fixed, since a leak means that sooner or later your brakes won't work well, or won't work at all.



So, it isn't a good idea to "top off" your brake fluid. Adding brake fluid won't correct a leak. If you add fluid when your linings are worn, then you'll have too much fluid when you get new brake linings. You should add (or remove) brake fluid, as necessary, only when work is done on the brake hydraulic system.



### CAUTION:

If you have too much brake fluid, it can spill on the engine. The fluid will burn if the engine is hot enough. You or others could be burned, and your vehicle could be damaged. Add brake fluid only when work is done on the brake hydraulic system.

When your brake fluid falls to a low level, your brake warning light will come on. A chime will sound if you try to drive with this warning light on. See "Brake System Warning Light" in the Index.

### What to Add

When you do need brake fluid, use only DOT-3 brake fluid -- such as Delco Supreme 11<sup>®</sup> (GM Part No. 12377967). Use new brake fluid from a sealed container only.

Always clean the brake fluid reservoir cap and the area around the cap before removing it. This will help keep dirt from entering the reservoir.



### CAUTION:

With the wrong kind of fluid in your brake system, your brakes may not work well, or they may not even work at all. This could cause a crash. Always use the proper brake fluid.



## **NOTICE:**

- Using the wrong fluid can badly damage brake system parts. For example, just a few drops of mineral-based oil, such as engine oil, in your brake system can damage brake system parts so badly that they'll have to be replaced. Don't let someone put in the wrong kind of fluid.
- If you spill brake fluid on your vehicle's painted surfaces, the paint finish can be damaged. Be careful not to spill brake fluid on your vehicle. If you do, wash it off immediately. See "Appearance Care" in the Index.

## **Brake Wear**

Your vehicle has four-wheel disc brakes.

Disc brake pads have built-in wear indicators that make a high-pitched warning sound when the brake pads are worn and new pads are needed. The sound may come and go or be heard all the time your vehicle is moving (except when you are pushing on the brake pedal firmly).



## **CAUTION:**

**The brake wear warning sound means that soon your brakes won't work well. That could lead to an accident. When you hear the brake wear warning sound, have your vehicle serviced.**

## **NOTICE:**

**Continuing to drive with worn-out brake pads could result in costly brake repair.**

Some driving conditions or climates may cause a brake squeal when the brakes are first applied or lightly applied. This does not mean something is wrong with your brakes.

Properly torqued wheel nuts are necessary to help prevent brake pulsation. When tires are rotated, inspect brake pads for wear and evenly torque wheel nuts in the proper sequence to GM specifications.

Brake linings should always be replaced as complete axle sets.

See "Brake System Inspection" in Section 7 of this manual under Part C "Periodic Maintenance Inspections."

### Brake Pedal Travel

See your dealer if the brake pedal does not return to normal height, or if there is a rapid increase in pedal travel. This could be a sign of brake trouble.

### Brake Adjustment

Every time you apply the brakes, with or without the vehicle moving, your brakes adjust for wear.

### Replacing Brake System Parts

The braking system on a modern vehicle is complex. Its many parts have to be of top quality and work well together if the vehicle is to have really good braking. Your vehicle was designed and tested with top-quality GM brake parts. When you replace parts of your braking system -- for example, when your brake linings wear down and you have to have new ones put in -- be sure you get new approved GM replacement parts. If you don't, your brakes may no longer work properly. For example, if someone puts in brake linings that are wrong for your vehicle, the balance between your front and rear brakes can change -- for the worse. The braking performance you've come to expect can change in many other ways if someone puts in the wrong replacement brake parts.

### Battery

Every new Buick has an ACDelco Freedom<sup>®</sup> battery. You never have to add water to one of these. When it's time for a new battery, we recommend an ACDelco Freedom battery. Get one that has the replacement number shown on the original battery's label.

## Vehicle Storage

If you're not going to drive your vehicle for 25 days or more, remove the black, negative (-) cable from the battery. This will help keep your battery from running down.

### CAUTION:

**Batteries have acid that can burn you and gas that can explode. You can be badly hurt if you aren't careful. See "Jump Starting" in the Index for tips on working around a battery without getting hurt.**

Contact your dealer to learn how to prepare your vehicle for longer storage periods.

Also, for your audio system, see "Theft-Deterrent Feature" in the Index.

## Bulb Replacement

The following procedure tells you how to replace your headlamp bulbs.

## Halogen Bulbs

### CAUTION:

**Halogen bulbs have pressurized gas inside and can burst if you drop or scratch the bulb. You or others could be injured. Be sure to read and follow the instructions on the bulb package.**



## Headlamps

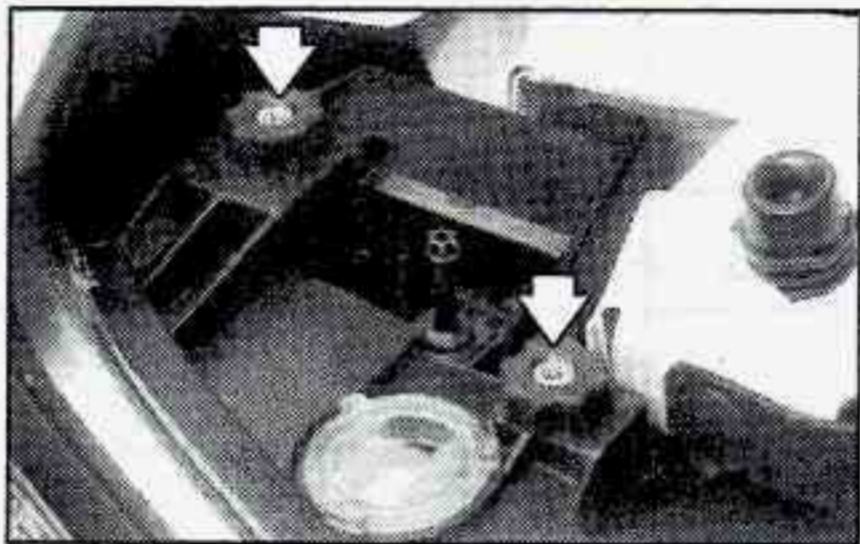

Each headlamp is attached by thumb screws.

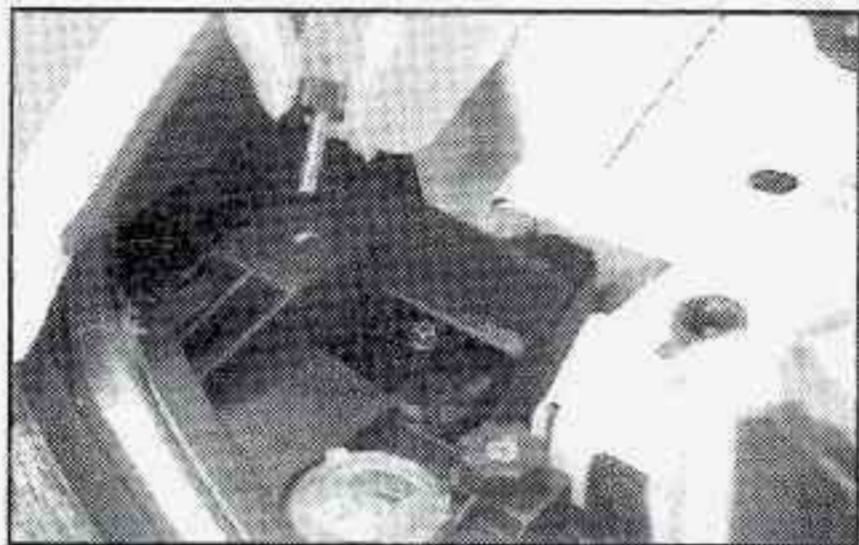

1. Remove the thumb screws by turning them to the left.

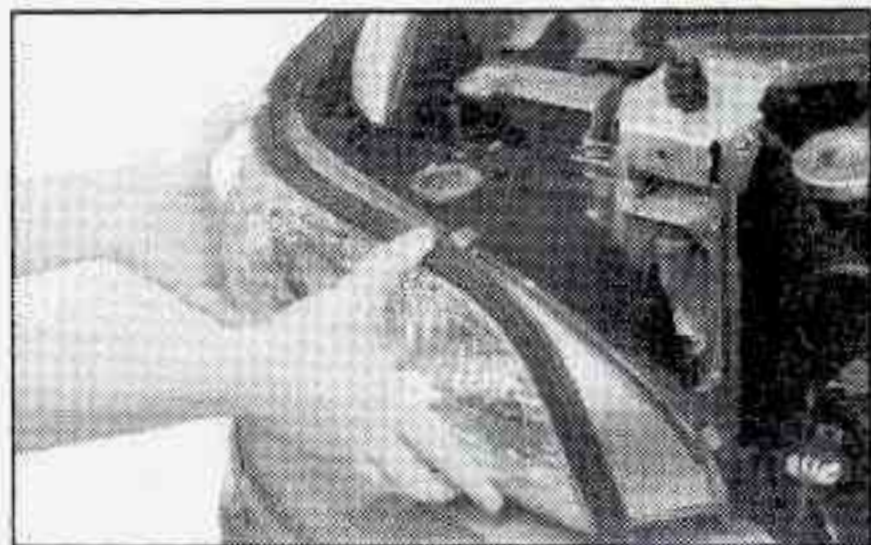

2. Pull the headlamp away from the car.

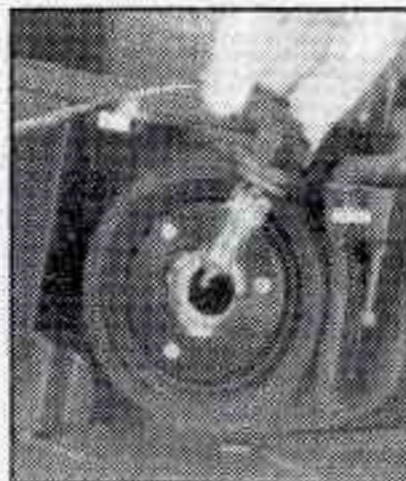

3. Remove the bulb socket by turning it one-quarter of a turn to the left, while pressing it firmly, then pull it out. Note: You can use pliers to remove the bulb socket if you are unable to do it by hand.
4. Remove the wire connector from the bulb by lifting the lock tab and pulling it away from the plastic base.

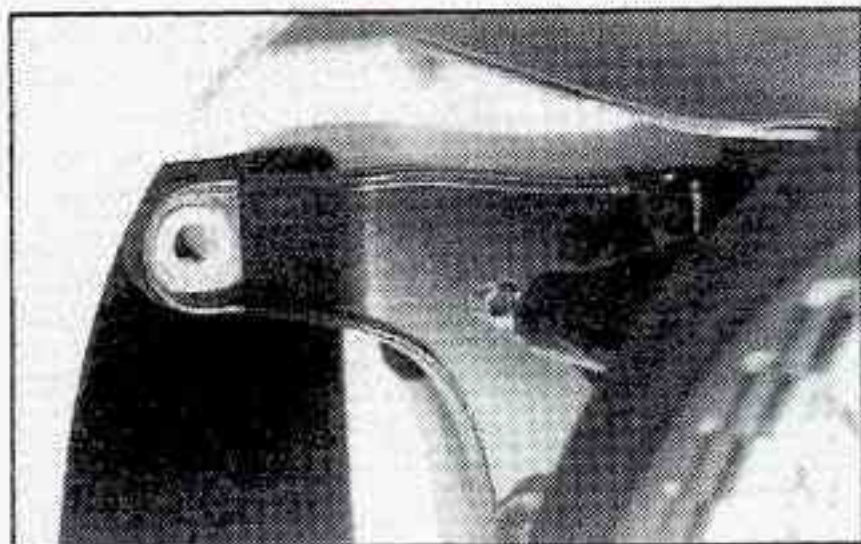

5. Reverse the above steps to reassemble the lamp assembly.

When reassembling the lamp, make sure to align the pin at the outboard edge of the headlamp assembly to the plastic retainer at the outboard edge of the vehicle.

## Front Turn Signal

The front turn signal bulbs can be accessed by removing the headlamp assembly as described in the previous procedure.



Once the headlamp assembly has been removed, reach down from the top of the vehicle and, while pressing the lock tab on the socket, turn the socket one-quarter of a turn and pull it out.

Remove the old bulb by pulling it straight out of the socket. Replace the bulb and turn the bulb assembly back into place.



## Headlamp Aiming

Your vehicle has the composite headlamp system. These headlamps have horizontal and vertical aim indicators. The aim has been pre-set at the factory and should need no further adjustment.

If your vehicle is damaged in an accident and the headlamp aim seems to be affected, see your dealer. Headlamps on damaged vehicles may require recalibration of the horizontal aim by your dealer.

To check the aim, the vehicle should be properly prepared as follows:

- The vehicle must have all four tires on a perfectly level surface. If necessary, pads may be used on an uneven surface.
- The vehicle should not have any snow, ice or mud attached to it.

- The vehicle should be fully assembled and all other work stopped while headlamp aiming is being done.
- There should not be any cargo or loading of the vehicle, except it should have a full tank of gas and one person or 160 lbs. (75 kg) on the driver's seat.
- Tires should be properly inflated.
- Rock the vehicle to stabilize the suspension.

### **NOTICE:**

**To make sure your headlamps are aimed properly, read all the instructions before beginning. Failure to follow these instructions could cause damage to headlamp parts.**

For the vertical adjustment, state inspection stations generally will allow a reading of plus 0.76 degrees or minus 0.76 degrees from the center of the bubble.

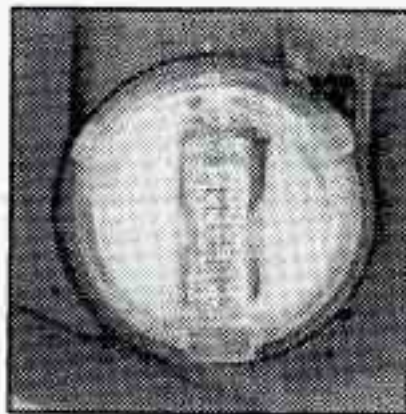

It is recommended that the upper limit not exceed plus 0.4 degrees from the center of the bubble. Other drivers may flash their high beams at you if your adjustment is much above plus 0.4 degrees.

The headlamp aiming device is under the hood, directly behind the headlamps.

If you find that the headlamp aiming needs adjustment, follow these steps:

Start with the vertical headlamp aim. Adjustment screws can be turned with an E8 Torx<sup>®</sup> socket or T15 Torx screwdriver.

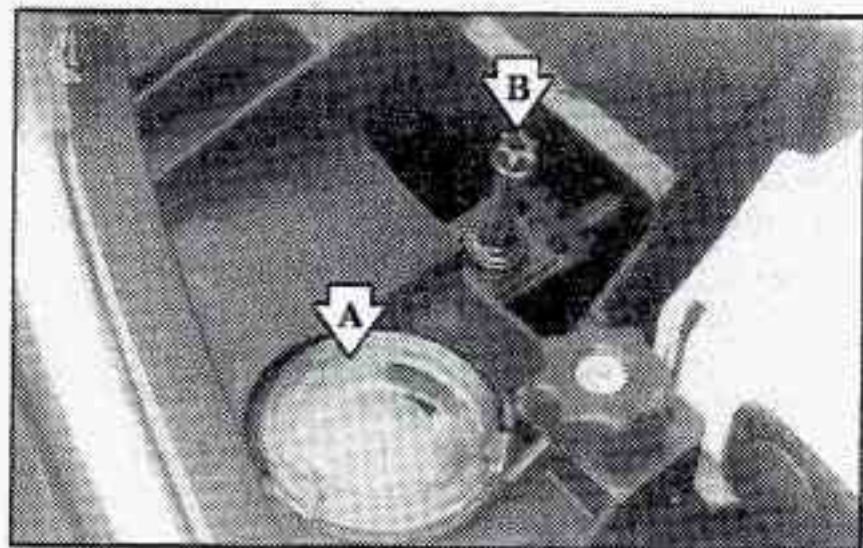

1. Check the vertical aim for each headlamp (A). The vehicle must be on a level surface. Turn the vertical aiming screw (B) until the bubble in the level is lined up with the 0 (zero).

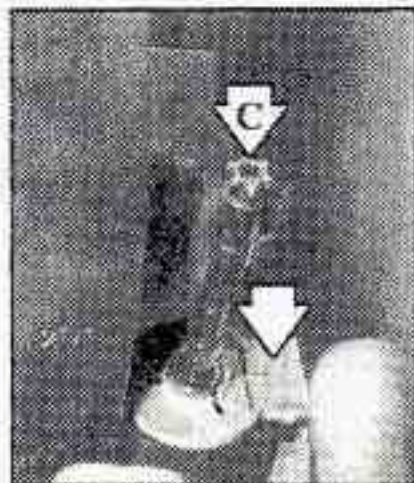

2. Now adjust the horizontal aim (C). The horizontal aiming device is located on the inboard side of each headlamp assembly, down lower from the vertical aiming device.

Check the horizontal aim and adjust it as necessary. There is a round dial located on the horizontal adjuster, with an alignment notch on it. Turn the horizontal aiming screw until the zero is lined up with the notch.

3. Now, visually recheck the vertical aim, to make sure it is still correct after the horizontal aim adjustment. Readjust, if necessary.

## Exterior Rear Bulbs

For the type of bulb to use, see "Replacement Bulbs" in the Index.

## Rear Turn Signal/Stoplamp

1. Open the trunk. On either side of the rear of the trunk is a plastic retainer that holds the cargo net and taillamp assembly in place.

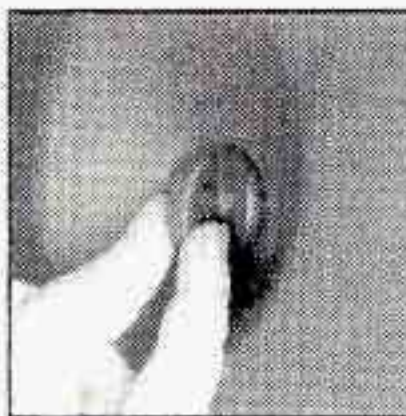

2. Unhook the cargo net from the cargo net retainer and remove the retainer by turning it to the left.

3. Pull back the trunk trim panel.



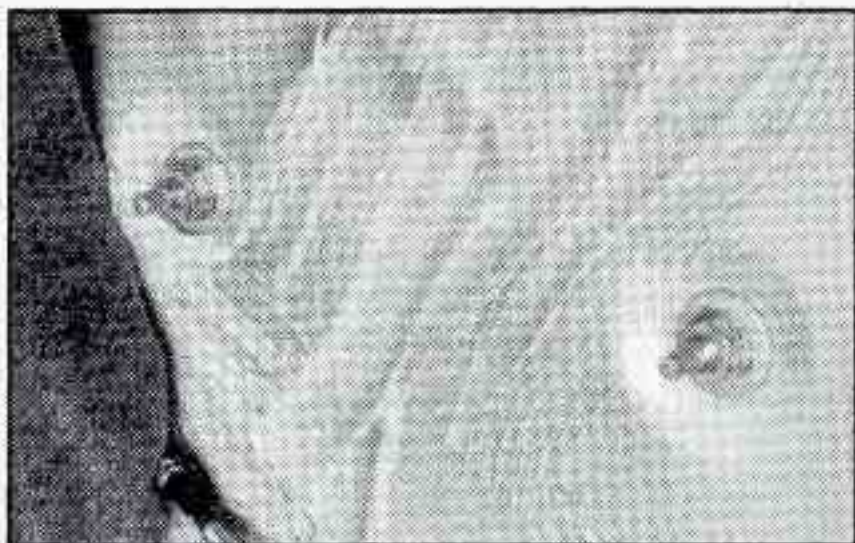

4. Beneath the trim panel are three nuts that secure the taillamp assembly. Remove these nuts with a 10 mm wrench. Remove the nuts from only the side you want to access. The turn signal and a stoplamp can now be accessed.

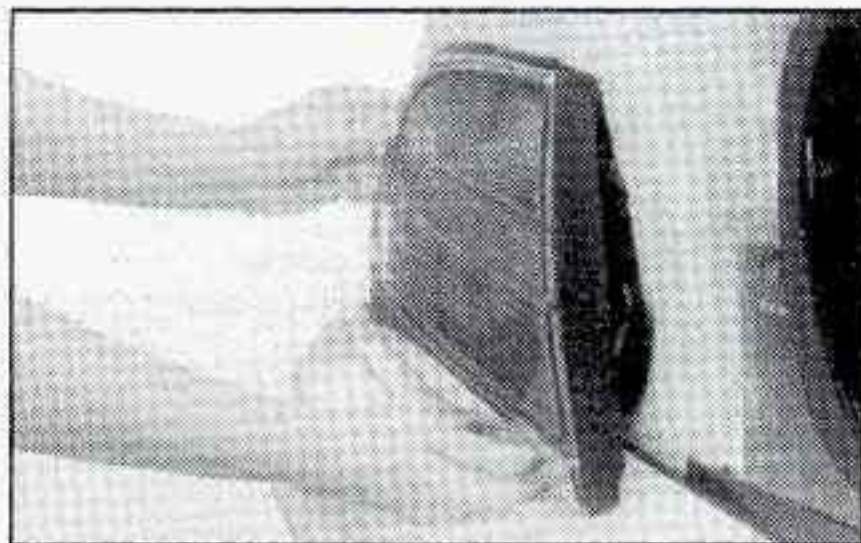

5. Pull the taillamp assembly away from the vehicle.



6. Remove the bulb socket assembly by turning the socket one-quarter of a turn to the left and pulling it out.



7. Once the socket has been removed, pull the bulb straight out to remove it from the socket.

8. Reverse the above steps to replace the taillamp assembly.

### Rear Turn Signals/Stoplamps/Back-Up Lamps



Turn lamps, stoplamps and back-up bulbs are located behind the taillamp assembly along the trunk lid. The following instructions explain how to access these bulbs.





1. There are four studs located at the edge of the trunk lid. Remove the protective vinyl caps from the studs.

2. Use a 10 mm wrench to remove the nuts from the studs.

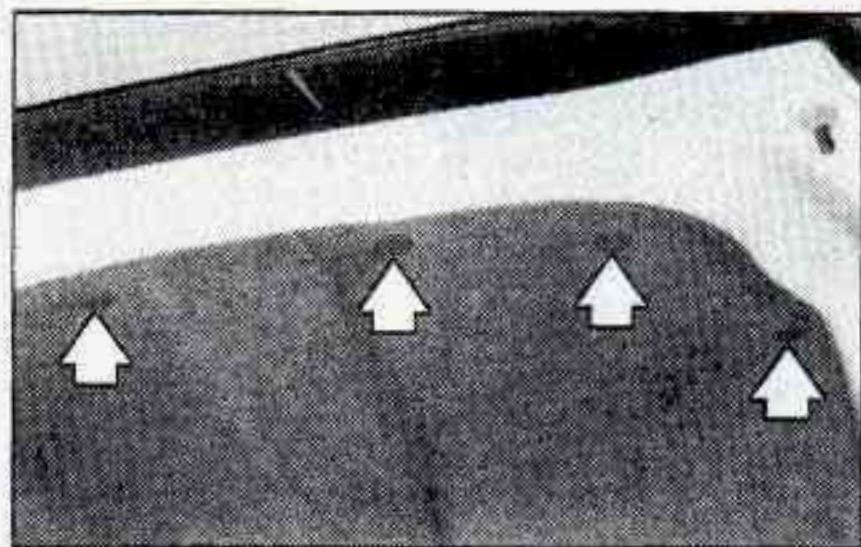

3. Next, there are eight fasteners along the top of the trunk lid (four on each side), holding the trunk trim in place. Remove these fasteners.



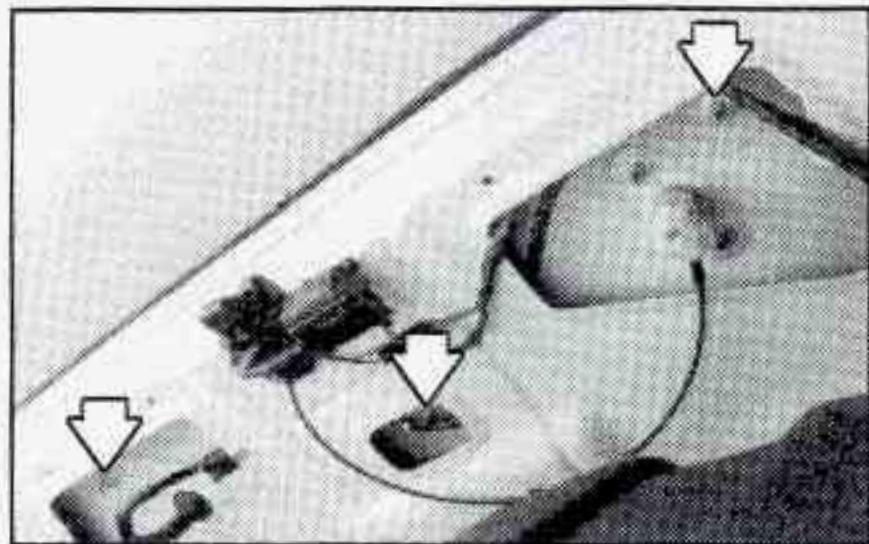

4. Hold the trunk trim back to expose the three remaining nuts holding the taillamp assembly in place.

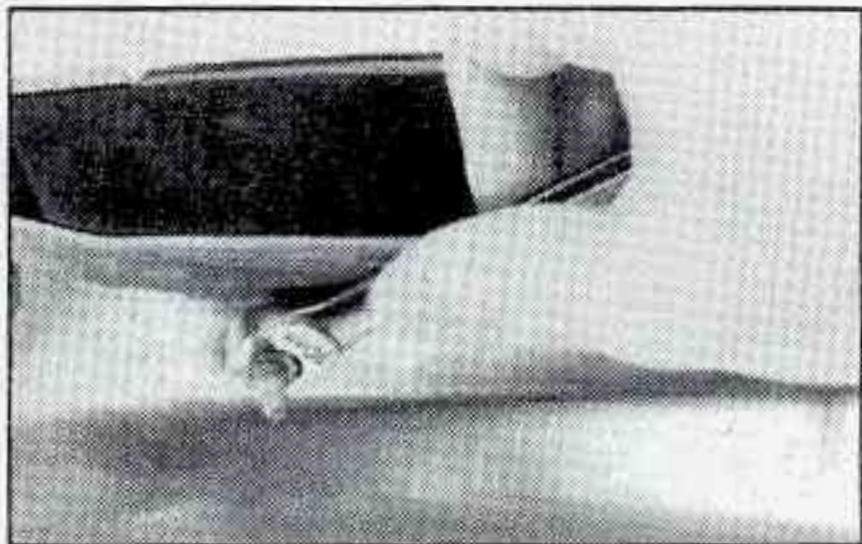

5. From inside the trunk compartment, use a 10 mm wrench to remove the nuts from the studs.

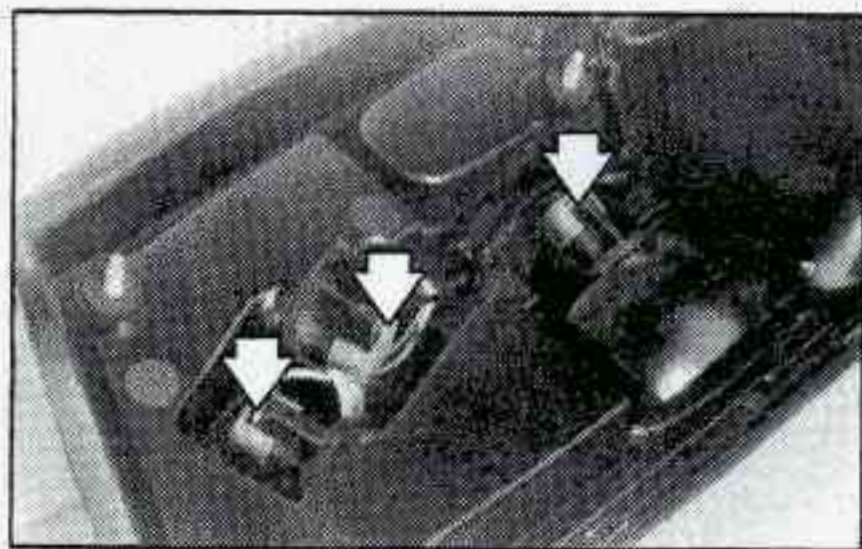

6. Pull the taillamp assembly away from the trunk lid. The bulbs are located on the back side of the assembly.



7. Turn the bulb socket one-quarter of a turn to the left and pull it out. Note: You can use pliers to remove the bulb socket if you are unable to do it by hand.



8. Once the socket has been removed, pull the bulb straight out to remove it from the socket.

9. Reverse the above steps to replace the taillamp assembly.

## Windshield Wiper Blade Replacement

Replacement blades come in different types and are removed in different ways.

To replace the wiper blade assembly:

1. Position the wipers on the windshield in the "mid" wipe position.
2. Lift the windshield wiper arm away from the windshield. Note: The windshield wiper does not have a locking upright position feature.

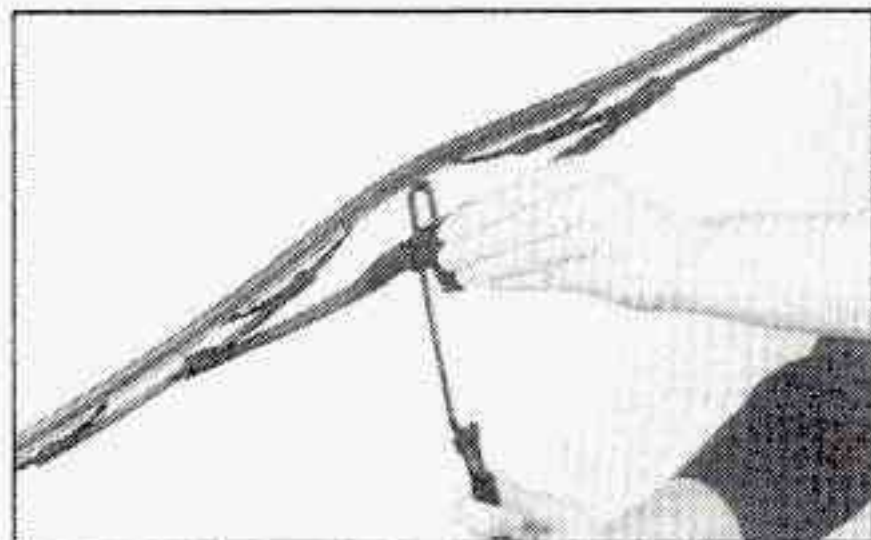

3. Push the tab on the wiper blade assembly and pull the assembly down enough to release it from the "U" hooked end of the wiper arm. Slide the assembly away from the arm.
4. Replace the blade.
5. To reinstall the wiper blade assembly, slide it over the wiper arm to engage the "U" hooked end on the wiper blade assembly. Pull up on the assembly to lock it into place.

For the correct windshield wiper blade replacement length and type, see "Normal Maintenance Replacement Parts" in the Index.



## Tires

Your new vehicle comes with high-quality tires made by a leading tire manufacturer. If you ever have questions about your tire warranty and where to obtain service, see your Buick Warranty booklet for details.



### CAUTION:

Poorly maintained and improperly used tires are dangerous.

- **Overloading your tires can cause overheating as a result of too much friction. You could have an air-out and a serious accident. See "Loading Your Vehicle" in the Index.**
- **Underinflated tires pose the same danger as overloaded tires. The resulting accident could cause serious injury. Check all tires frequently to maintain the recommended pressure. Tire pressure should be checked when your tires are cold.**

**CAUTION: (Continued)**

### CAUTION: (Continued)

- **Overinflated tires are more likely to be cut, punctured or broken by a sudden impact -- such as when you hit a pothole. Keep tires at the recommended pressure.**
- **Worn, old tires can cause accidents. If your tread is badly worn, or if your tires have been damaged, replace them.**

### Inflation -- Tire Pressure

The Tire-Loading Information label, which is located on the rear edge of the driver's door shows the correct inflation pressures for your tires when they're cold. "Cold" means your vehicle has been sitting for at least three hours or driven no more than 1 mile (1.6 km).

## NOTICE:

Don't let anyone tell you that underinflation or overinflation is all right. It's not. If your tires don't have enough air (underinflation), you can get the following:

- Too much flexing
- Too much heat
- Tire overloading
- Bad wear
- Bad handling
- Bad fuel economy.

If your tires have too much air (overinflation), you can get the following:

- Unusual wear
- Bad handling
- Rough ride
- Needless damage from road hazards.

### When to Check

Check your tires once a month or more.

Don't forget your compact spare tire. It should be at 60 psi (420 kPa).

### How to Check

Use a good quality pocket-type gage to check tire pressure. You can't tell if your tires are properly inflated simply by looking at them. Radial tires may look properly inflated even when they're underinflated.

Be sure to put the valve caps back on the valve stems. They help prevent leaks by keeping out dirt and moisture.

### Check Tire Pressure System (If Equipped)

The check tire pressure system can alert you to a large change in the pressure of one tire. The system won't alert you before you drive that a tire is low or flat. You must begin driving before the system will work properly.

The TIRE PRESSURE LOW: CHECK TIRES message will appear on the Driver Information Center (DIC) if pressure in one tire becomes at least 10 psi (69 kPa) lower or higher than the other three tires. The check tire pressure system won't alert you if more than one tire is low or high, or if the system is not calibrated properly. It also won't tell you which tire is low or high.

If the anti-lock brake system warning light comes on, the check tire pressure system may not be working properly. See your dealer for service. (Also, see "Anti-Lock Brake System Warning Light" in the Index.)



The check tire pressure system detects differences in tire rotation speeds that are caused by changes in tire pressure. The system can alert you about a low tire -- but it doesn't replace normal tire maintenance. See "Tires" in the Index.

When the TIRE PRESSURE LOW: CHECK TIRES message appears on the Driver Information Center, you should stop as soon as you can and check all your tires for damage. (If a tire is flat, see "If a Tire Goes Flat" in the Index.) Also check the tire pressure in all four tires as soon as you can. See "Inflation-Tire Pressure" in the Index.

Any time you adjust a tire's pressure or have one or more tires repaired or replaced, you'll need to reset (calibrate) the check tire pressure system. You'll also need to reset the system whenever you rotate the tires, buy new tires, install or remove the compact spare, and whenever the vehicle's battery has been disconnected.

Don't reset the check tire pressure system without first correcting the cause of the problem and checking and adjusting the pressure in all four tires. If you reset the system when the tire pressures are incorrect, the check tire pressure system will not work properly and may not alert you when a tire is low or high.

To reset (calibrate) the system:

1. Turn the ignition switch to RUN.
2. Press the GAGES button on the DIC until TIRE PRESSURE appears on the display.
3. Press and hold the DIC RESET button for about five seconds. After five seconds, the display will show TIRE PRESSURE RESET. If TIRE PRESSURE RESET does not appear on the display after about five seconds, see your dealer for service. After you release the DIC RESET button, TIRE PRESSURE NORMAL will appear on the display.

The system completes the calibration process during driving. During the first 10 to 25 miles (15 to 40 km) of driving, the system will not alert you if a tire is high or low. After 25 to 100 miles (40 to 160 km), the system will only alert you about pressure differences of 12 psi (85 kPa) or more. After about 100 miles (160 km) of driving, the system will alert you if one tire is 10 psi (69 kPa) different from the other three tires.



## Tire Inspection and Rotation

Tires should be rotated every 6,000 to 8,000 miles (10 000 to 13 000 km). Any time you notice unusual wear, rotate your tires as soon as possible and check wheel alignment. Also check for damaged tires or wheels. See "When It's Time for New Tires" and "Wheel Replacement" later in this section for more information.

The purpose of regular rotation is to achieve more uniform wear for all tires on the vehicle. The first rotation is the most important. See "Scheduled Maintenance Services" in the Index for scheduled rotation intervals.

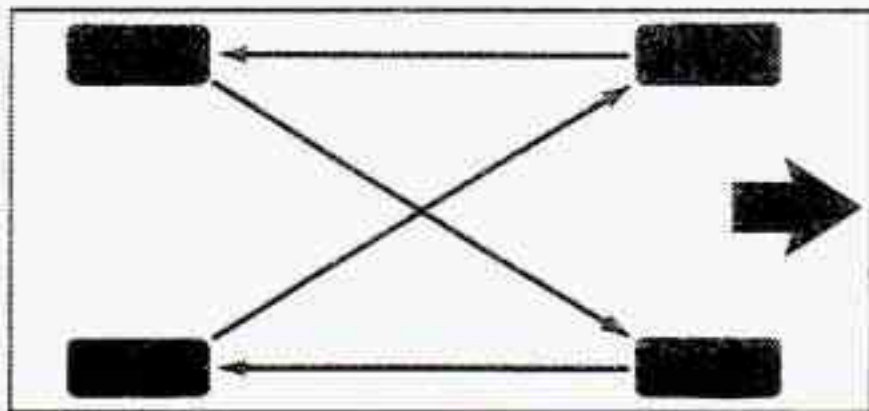

When rotating your tires, always use the correct rotation pattern shown here.

Don't include the compact spare tire in your tire rotation.

After the tires have been rotated, adjust the front and rear inflation pressures as shown on the Tire-Loading Information label. Make certain that all wheel nuts are properly tightened. See "Wheel Nut Torque" in the Index.



### CAUTION:

**Rust or dirt on a wheel, or on the parts to which it is fastened, can make wheel nuts become loose after a time. The wheel could come off and cause an accident. When you change a wheel, remove any rust or dirt from places where the wheel attaches to the vehicle. In an emergency, you can use a cloth or a paper towel to do this; but be sure to use a scraper or wire brush later, if you need to, to get all the rust or dirt off. (See "Changing a Flat Tire" in the Index.)**

## When It's Time for New Tires

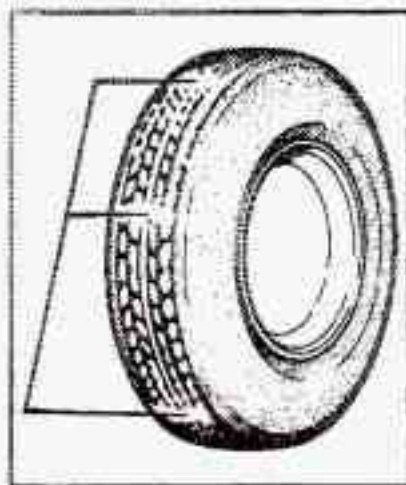

One way to tell when it's time for new tires is to check the treadwear indicators, which will appear when your tires have only 1/16 inch (1.6 mm) or less of tread remaining.

You need a new tire if any of the following statements are true:

- You can see the indicators at three or more places around the tire.
- You can see cord or fabric showing through the tire's rubber.
- The tread or sidewall is cracked, cut or snagged deep enough to show cord or fabric.

- The tire has a bump, bulge or split.
- The tire has a puncture, cut or other damage that can't be repaired well because of the size or location of the damage.

## Buying New Tires

To find out what kind and size of tires you need, look at the Tire-Loading Information label.

The tires installed on your vehicle when it was new had a Tire Performance Criteria Specification (TPC Spec) number on each tire's sidewall. When you get new tires, get ones with that same TPC Spec number. That way your vehicle will continue to have tires that are designed to give proper endurance, handling, speed rating, traction, ride and other things during normal service on your vehicle. If your tires have an all-season tread design, the TPC number will be followed by an "MS" (for mud and snow).

If you ever replace your tires with those not having a TPC Spec number, make sure they are the same size, load range, speed rating and construction type (bias, bias-belted or radial) as your original tires.

 **CAUTION:**

**Mixing tires could cause you to lose control while driving. If you mix tires of different sizes or types (radial and bias-belted tires), the vehicle may not handle properly, and you could have a crash. Using tires of different sizes may also cause damage to your vehicle. Be sure to use the same size and type tires on all wheels.**

**It's all right to drive with your compact spare, though. It was developed for use on your vehicle.**

 **CAUTION:**

**If you use bias-ply tires on your vehicle, the wheel rim flanges could develop cracks after many miles of driving. A tire and/or wheel could fail suddenly, causing a crash. Use only radial-ply tires with the wheels on your vehicle.**

## Uniform Tire Quality Grading

The following information relates to the system developed by the United States National Highway Traffic Safety Administration, which grades tires by treadwear, traction and temperature performance. (This applies only to vehicles sold in the United States.) The grades are molded on the sidewalls of most passenger car tires. The Uniform Tire Quality Grading system does not apply to deep tread, winter-type snow tires, space-saver or temporary use spare tires, tires with nominal rim diameters of 10 to 12 inches (25 to 30 cm), or to some limited-production tires.

While the tires available on General Motors passenger cars and light trucks may vary with respect to these grades, they must also conform to Federal safety requirements and additional General Motors Tire Performance Criteria (TPC) standards.



### Treadwear

The treadwear grade is a comparative rating based on the wear rate of the tire when tested under controlled conditions on a specified government test course. For example, a tire graded 150 would wear one and a half (1 1/2) times as well on the government course as a tire graded 100. The relative performance of tires depends upon the actual conditions of their use, however, and may depart significantly from the norm due to variations in driving habits, service practices and differences in road characteristics and climate.

### Traction -- A, B, C

The traction grades, from highest to lowest, are A, B, and C, and they represent the tire's ability to stop on wet pavement as measured under controlled conditions on specified government test surfaces of asphalt and concrete. A tire marked C may have poor traction performance.

Warning: The traction grade assigned to this tire is based on braking (straight ahead) traction tests and does not include cornering (turning) traction.

### Temperature -- A, B, C

The temperature grades are A (the highest), B, and C, representing the tire's resistance to the generation of

heat and its ability to dissipate heat when tested under controlled conditions on a specified indoor laboratory test wheel. Sustained high temperature can cause the material of the tire to degenerate and reduce tire life, and excessive temperature can lead to sudden tire failure. The grade C corresponds to a level of performance which all passenger car tires must meet under the Federal Motor Vehicle Safety Standard No. 109. Grades B and A represent higher levels of performance on the laboratory test wheel than the minimum required by law.

Warning: The temperature grade for this tire is established for a tire that is properly inflated and not overloaded. Excessive speed, underinflation, or excessive loading, either separately or in combination, can cause heat buildup and possible tire failure.

### Wheel Alignment and Tire Balance

The wheels on your vehicle were aligned and balanced carefully at the factory to give you the longest tire life and best overall performance.

Scheduled wheel alignment and wheel balancing are not needed. However, if you notice unusual tire wear or your vehicle pulling one way or the other, the alignment may need to be reset. If you notice your vehicle vibrating when driving on a smooth road, your wheels may need to be rebalanced.

## Wheel Replacement

Replace any wheel that is bent, cracked, or badly rusted or corroded. If wheel nuts keep coming loose, the wheel, wheel bolts and wheel nuts should be replaced. If the wheel leaks air, replace it (except some aluminum wheels, which can sometimes be repaired). See your dealer if any of these conditions exist.

Your dealer will know the kind of wheel you need.

Each new wheel should have the same load-carrying capacity, diameter, width, offset and be mounted the same way as the one it replaces.

If you need to replace any of your wheels, wheel bolts or wheel nuts, replace them only with new GM original equipment parts. This way, you will be sure to have the right wheel, wheel bolts and wheel nuts for your Buick model.



### CAUTION:

Using the wrong replacement wheels, wheel bolts or wheel nuts on your vehicle can be dangerous. It could affect the braking and handling of your vehicle, make your tires lose air and make you lose control. You could have a collision in which you or others could be injured. Always use the correct wheel, wheel bolts and wheel nuts for replacement.

### NOTICE:

The wrong wheel can also cause problems with bearing life, brake cooling, speedometer or odometer calibration, headlamp aim, bumper height, vehicle ground clearance and tire or tire chain clearance to the body and chassis.

See "Changing a Flat Tire" in the Index for more information.

## Used Replacement Wheels

### CAUTION:

Putting a used wheel on your vehicle is dangerous. You can't know how it's been used or how far it's been driven. It could fail suddenly and cause an accident. If you have to replace a wheel, use a new GM original equipment wheel.

## Tire Chains

### NOTICE:

Use tire chains only where legal and only when you must. Use only SAE Class "S" type chains that are the proper size for your tires. Install them on the front tires and tighten them as tightly as possible with the ends securely fastened. Drive slowly and follow the chain manufacturer's instructions. If you can hear the chains contacting your vehicle, stop and retighten them. If the contact continues, slow down until it stops. Driving too fast or spinning the wheels with chains on will damage your vehicle.



## Appearance Care

Remember, cleaning products can be hazardous. Some are toxic. Others can burst into flame if you strike a match or get them on a hot part of the vehicle. Some are dangerous if you breathe their fumes in a closed space. When you use anything from a container to clean your vehicle, be sure to follow the manufacturer's warnings and instructions. And always open your doors or windows when you're cleaning the inside.

*Never* use these to clean your vehicle:

- Gasoline
- Benzene
- Naphtha
- Carbon Tetrachloride
- Acetone
- Paint Thinner
- Turpentine
- Lacquer Thinner
- Nail Polish Remover

They can all be hazardous -- some more than others -- and they can all damage your vehicle, too.

Don't use any of these unless this manual says you can. In many uses, these will damage your vehicle:

- Alcohol
- Laundry Soap
- Bleach
- Reducing Agents

## Cleaning the Inside of Your Vehicle

Use a vacuum cleaner often to get rid of dust and loose dirt. Wipe vinyl, leather, plastic and painted surfaces with a clean, damp cloth.

Your dealer has two cleaners, Multi-Purpose Interior Cleaner and Capture Non-Solvent Dry Spot and Soil Remover for cleaning fabric and carpet. They will clean normal spots and stains very well. You can get GM-approved cleaning products from your dealer. (See "Appearance Care and Materials" in the Index.)

Here are some cleaning tips:

- Always read the instructions on the cleaner label.
- Clean up stains as soon as you can -- before they set.
- Carefully scrape off any excess stain.
- Use a clean cloth or sponge, and change to a clean area often. A soft brush may be used if stains are stubborn.
- If a ring forms after spot cleaning, clean the entire area immediately or it will set.

## Using Multi-Purpose Interior Cleaner on Fabric

1. Vacuum and brush the area to remove any loose dirt.
2. Always clean a whole trim panel or section. Mask surrounding trim along stitch or welt lines.
3. Mix powdered cleaner following the directions on the container label to form thick suds.
4. Use suds only and apply with a clean sponge. Don't saturate the material and don't rub it roughly.
5. As soon as you've cleaned the section, use a sponge to remove the suds.
6. Wipe cleaned area with a clean, damp towel or cloth.
7. Wipe with a clean cloth and let dry.

## Special Fabric Cleaning Problems

Stains caused by such things as catsup, coffee (black), egg, fruit, fruit juice, milk, soft drinks, vomit, urine and blood can be removed as follows:

1. Carefully scrape off excess stain, then sponge the soiled area with cool water.
2. If a stain remains, follow the multi-purpose interior cleaner instructions described earlier.
3. If an odor lingers after cleaning vomit or urine, treat the area with a water/baking soda solution:  
1 teaspoon (5 ml) of baking soda to 1 cup (250 ml) of lukewarm water.
4. Let dry.

Stains caused by candy, ice cream, mayonnaise, chili sauce and unknown stains can be removed as follows:

1. Carefully scrape off excess stain.
2. First, clean with cool water and allow to dry completely.
3. If a stain remains, follow instructions for Multi-Purpose Interior Cleaner.

## Cleaning Vinyl

Use warm water and a clean cloth.

- Rub with a clean, damp cloth to remove dirt. You may have to do it more than once.
- Things like tar, asphalt and shoe polish will stain if you don't get them off quickly. Use a clean cloth and a vinyl/leather cleaner. See your dealer for this product.

## Cleaning Leather

Use a soft cloth with lukewarm water and a mild soap or saddle soap and wipe dry with a soft cloth. Then, let the leather dry naturally. Do not use heat to dry.

- For stubborn stains, use a leather cleaner. See your dealer for this product.
- *Never* use oils, varnishes, solvent-based or abrasive cleaners, furniture polish or shoe polish on leather.
- Soiled or stained leather should be cleaned immediately. If dirt is allowed to work into the finish, it can harm the leather.

## Cleaning the Top of the Instrument Panel

Use only mild soap and water to clean the top surfaces of the instrument panel. Sprays containing silicones or waxes may cause annoying reflections in the windshield and even make it difficult to see through the windshield under certain conditions.

## Cleaning Interior Plastic Components

Use only a mild soap and water solution on a soft cloth or sponge. Commercial cleaners may affect the surface finish.

## Cleaning Speaker Covers

Vacuum around a speaker cover gently, so that the speaker won't be damaged. Clean spots with just water and mild soap.



## Care of Safety Belts

Keep belts clean and dry.



### CAUTION:

**Do not bleach or dye safety belts. If you do, it may severely weaken them. In a crash, they might not be able to provide adequate protection. Clean safety belts only with mild soap and lukewarm water.**

## Cleaning Glass Surfaces

Glass should be cleaned often. GM Glass Cleaner (GM Part No. 1050427) or a liquid household glass cleaner will remove normal tobacco smoke and dust films on interior glass.

Don't use abrasive cleaners on glass, because they may cause scratches. Avoid placing decals on the inside rear window, since they may have to be scraped off later. If abrasive cleaners are used on the inside of the rear window, an electric defogger element may be damaged. Any temporary license should not be attached across the defogger grid.

## Cleaning the Outside of the Windshield and Wiper Blades

If the windshield is not clear after using the windshield washer, or if the wiper blade chatters when running, wax, sap or other material may be on the blade or windshield.

Clean the outside of the windshield with GM Windshield Cleaner, Bon Ami<sup>®</sup> Powder (non-scratching glass cleaning powder), GM Part No. 1050011. The windshield is clean if beads do not form when you rinse it with water.

Grime from the windshield will stick to the wiper blades and affect their performance. Clean the blade by wiping vigorously with a cloth soaked in full-strength windshield washer solvent. Then rinse the blade with water.

Check the wiper blades and clean them as necessary; replace blades that look worn.

## Weatherstrips

Silicone grease on weatherstrips will make them last longer, seal better, and not stick or squeak. Apply silicone grease with a clean cloth at least every six months. During very cold, damp weather more frequent application may be required. (See "Recommended Fluids and Lubricants" in the Index.)

## Cleaning the Outside of Your Vehicle

The paint finish on your vehicle provides beauty, depth of color, gloss retention and durability.

### Washing Your Vehicle

The best way to preserve your vehicle's finish is to keep it clean by washing it often with lukewarm or cold water.

Don't wash your vehicle in the direct rays of the sun. Don't use strong soaps or chemical detergents. Use liquid hand, dish or car washing (mild detergent) soaps. You can get GM-approved cleaning products from your dealer. (See "Appearance Care and Materials" in the Index.) Don't use cleaning agents that are petroleum based, or that contain acid or abrasives. All cleaning

agents should be flushed promptly and not allowed to dry on the surface, or they could stain. Dry the finish with a soft, clean chamois or an all-cotton towel to avoid surface scratches and water spotting.

High pressure car washes may cause water to enter your vehicle.

### Cleaning Exterior Lamps/Lenses

Use lukewarm or cold water, a soft cloth and a liquid hand, dish or car washing (mild detergent) soap to clean exterior lamps and lenses. Follow instructions under "Washing Your Vehicle."

### Finish Care

Occasional waxing or mild polishing of your vehicle by hand may be necessary to remove residue from the paint finish. You can get GM-approved cleaning products from your dealer. (See "Appearance Care and Materials" in the Index.)

Your Buick has a "basecoat/clearcoat" paint finish. The clearcoat gives more depth and gloss to the colored basecoat. Always use waxes and polishes that are non-abrasive and made for a basecoat/clearcoat paint finish.



## **NOTICE:**

**Machine compounding or aggressive polishing on a basecoat/clearcoat paint finish may dull the finish or leave swirl marks.**

Foreign materials such as calcium chloride and other salts, ice melting agents, road oil and tar, tree sap, bird droppings, chemicals from industrial chimneys, etc., can damage your vehicle's finish if they remain on painted surfaces. Wash the vehicle as soon as possible. If necessary, use non-abrasive cleaners that are marked safe for painted surfaces to remove foreign matter.

Exterior painted surfaces are subject to aging, weather and chemical fallout that can take their toll over a period of years. You can help to keep the paint finish looking new by keeping your vehicle garaged or covered whenever possible.

### **Cleaning Aluminum or Chrome Wheels (If Equipped)**

Keep your wheels clean using a soft clean cloth with mild soap and water. Rinse with clean water. After

rinsing thoroughly, dry with a soft clean towel. A wax may then be applied.

The surface of these wheels is similar to the painted surface of your vehicle. Don't use strong soaps, chemicals, abrasive polishes, abrasive cleaners or abrasive cleaning brushes on them because you could damage the surface. You may use chrome polish on chrome wheels, but avoid any painted surface of the wheel, and buff off immediately after application.

Don't take your vehicle through an automatic car wash that has silicon carbide tire cleaning brushes. These brushes can also damage the surface of these wheels.

### **Cleaning Tires**

To clean your tires, use a stiff brush with a tire cleaner.

## **NOTICE:**

**When applying a tire dressing always take care to wipe off any overspray or splash from all painted surfaces on the body or wheels of the vehicle. Petroleum-based products may damage the paint finish.**



## Sheet Metal Damage

If your vehicle is damaged and requires sheet metal repair or replacement, make sure the body repair shop applies anti-corrosion material to the parts repaired or replaced to restore corrosion protection.

## Finish Damage

Any stone chips, fractures or deep scratches in the finish should be repaired right away. Bare metal will corrode quickly and may develop into a major repair expense.

Minor chips and scratches can be repaired with touch-up materials available from your dealer or other service outlets. Larger areas of finish damage can be corrected in your dealer's body and paint shop.

## Underbody Maintenance

Chemicals used for ice and snow removal and dust control can collect on the underbody. If these are not removed, accelerated corrosion (rust) can occur on the underbody parts such as fuel lines, frame, floor pan and exhaust system even though they have corrosion protection.

At least every spring, flush these materials from the underbody with plain water. Clean any areas where mud and other debris can collect. Dirt packed in closed areas of the frame should be loosened before being flushed. Your dealer or an underbody car washing system can do this for you.

## Chemical Paint Spotting

Some weather and atmospheric conditions can create a chemical fallout. Airborne pollutants can fall upon and attack painted surfaces on your vehicle. This damage can take two forms: blotchy, ringlet-shaped discolorations, and small irregular dark spots etched into the paint surface.

Although no defect in the paint job causes this, Buick will repair, at no charge to the owner, the surfaces of new vehicles damaged by this fallout condition within 12 months or 12,000 miles (20 000 km) of purchase, whichever occurs first.

## Appearance Care Materials Chart

PART NUMBER	SIZE	DESCRIPTION	USAGE
994954	23 in. x 25 in.	Polishing Cloth – Wax Treated	Exterior polishing cloth
1050172	16 oz. (0.473 L)	Tar and Road Oil Remover	Removes tar, road oil and asphalt
1050173	16 oz. (0.473 L)	Chrome Cleaner and Polish	Use on chrome, stainless steel, nickel, copper and brass
1050174	16 oz. (0.473 L)	White Sidewall Tire Cleaner	Removes soil and black marks from whitewalls
1050214	32 oz. (0.946 L)	Vinyl Cleaner	Cleans vinyl tops, upholstery and convertible tops
1050427	23 oz. (0.680 L)	Glass Cleaner	Removes dirt, grime, smoke and fingerprints
1052870	16 oz. (0.473 L)	Wash Wax Concentrate	Cleans and lightly waxes
1052918**	8 oz. (0.237 L)	Armor All™ Protectant	Protects leather, wood, acrylics, Plexiglas™, plastic, rubber and vinyl
1052925	16 oz. (0.473 L)	Multi-Purpose Interior Cleaner	Cleans carpets, seats, interior trim, door panels and floor mats
1052929	16 oz. (0.473 L)	Wheel Cleaner	Spray on and rinse with water
1052930	8 oz. (0.237 L)	Capture Dry Spot Remover	Attracts, absorbs and removes soils
12345002	16 oz. (0.473 L)	Armor All™ Cleaner	Cleans and shines a variety of surface types
12345721	2.5 sq. ft.	Synthetic Chamois	Shines vehicle without scratching
12345725	12 oz. (0.354 L)	Silicone Tire Shine	Spray on tire shine
12377964	16 oz. (0.473 L)	Finish Enhancer	Removes dust, fingerprints and surface contaminants
12377966	16 oz. (0.473 L)	Cleaner Wax	Removes light scratches and oxidation and protects finish
12377984	16 oz. (0.473 L)	Surface Cleaner	Removes contaminants, blemishes and swirl marks
See your General Motors Parts Department for these products. See "Fluids and Lubricants" in the Index.			** Not recommended for use on instrument panel vinyl.

## Vehicle Identification Number (VIN)

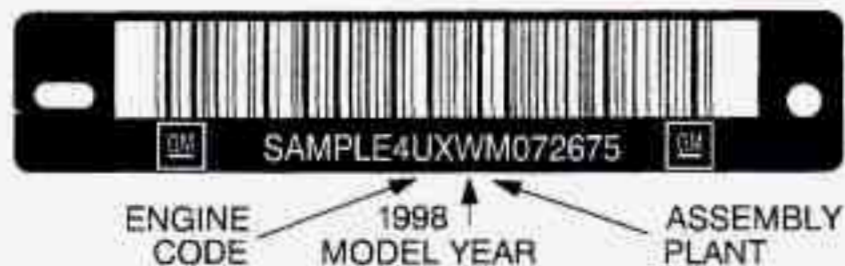

This is the legal identifier for your vehicle. It appears on a plate in the front corner of the instrument panel, on the driver's side. You can see it if you look through the windshield from outside your vehicle. The VIN also appears on the Vehicle Certification and Service Parts labels and the certificates of title and registration.

## Engine Identification

The 8th character in your VIN is the engine code. This code will help you identify your engine, specifications and replacement parts.

## Service Parts Identification Label

You'll find this label on the spare tire cover. It's very helpful if you ever need to order parts. On this label is:

- your VIN,
- the model designation,
- paint information and
- a list of all production options and special equipment.

Be sure that this label is not removed from the vehicle.



## Electrical System

### Add-On Electrical Equipment

#### **NOTICE:**

**Don't add anything electrical to your vehicle unless you check with your dealer first. Some electrical equipment can damage your vehicle and the damage wouldn't be covered by your warranty. Some add-on electrical equipment can keep other components from working as they should.**

Your vehicle has an air bag system. Before attempting to add anything electrical to your vehicle, see "Servicing Your Air Bag-Equipped Vehicle" in the Index.

### Maxifuse<sup>®</sup>/Relay Center



To check the fuses in this underhood fuse center, turn the knob to the left and remove the cover. There is a chart inside the cover that explains the features and controls governed by each fuse and relay.

## Fuses and Circuit Breakers

The wiring circuits in your vehicle are protected from short circuits by a combination of fuses and circuit breakers. This greatly reduces the chance of damage caused by electrical problems.

Look at the silver-colored band inside the fuse. If the band is broken or melted, replace the fuse. Be sure you replace a bad fuse with a new one of the identical size and rating.

There are three fuse blocks in your vehicle: the Instrument Panel Fuse Block located under the instrument panel, the Underhood Fuse Block located on the passenger's side engine compartment and the Rear Fuse Block, located under the rear seat.

### Instrument Panel Fuse Block

The right side fuse panel is located under the instrument panel.

Remove the hush panel on the lower right to reveal the fuses. To remove the panel, do the following:

1. Remove the two 7 mm screws located along the front edge of the panel.
2. Lower the hush panel. The fuse block is a rectangular covered box located on the far right side under the instrument panel.
3. Remove the cover. Now you can see the fuses and replace them.
4. Place the wide end of the fuse puller over the plastic end of the fuse.
5. Squeeze the ends over the fuse and pull it out.

Spare fuses are located in the empty slots shown on the following chart.

When finished, replace the hush panel. Replace lamps, connectors, and HVAC duct temperature sensors if they were removed.



Fuse	Usage
SBM	Intr Lamps
PASSMOL	PDM Module
A/C	HVAC Motor, HVAC Mix Motors
IGN SEN	EC Mirror, Driver HTS Seat, Rear Defog Relay, MEM Module, Cool LVL Sensor, Pass Heated Seat

Fuse	Usage
ELC	HVAC Flat Pk Mtrs, ELC Sensor, ELC Sensor (R Bee)
ABS	Anti-Lock Brake System Module
HVAC	HVAC Main Con Head, HVAC Programmer, IPC
CR CONT	Stepper Motor CR, Cruise Switch
HUD	HUD Switch, HUD Display
CSTR/SBM	HVAC Programmer, IPC (Cluster), SBM (275 to LCM) (1135 to BTSI SL)
LP PK L	Underhood LP, L PK/Side Mkr, L PK/Turn Lmp, SBM, L Tail Sig Lmp, L Tail Stop Lmp, L Rear Side Mkr
LP PK R	Rt PK/Side Mkr Lmp, Rt PK/Turn Lamp, Rt Tail/Sign Lamp, Rt Tail/Stoplamp, Rt Rear Sidemarker, Stop/Tail Lamp, Tail/Sig Lamp, License Lamp, RFA
RUN	Run/Acsry
WSW	Wiper Motor
EMPTY	Not Used
RFARSEN	Wiper Switch, Rfa, Rain Sense
B/U LP	E/C Mirror, Back-up Lamps



## Underhood Fuse Block

There are additional fuses located on the passenger's side of the engine compartment.

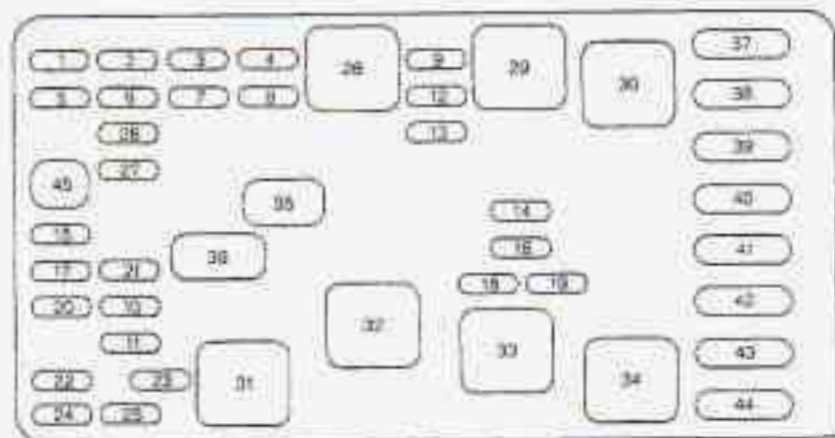

Position	Circuitry
1	Not Used
2	RFA, SBM, IPC, LCM
3	Turn Signal, Hazard Switch
4	Pre Oxygen Sensor, Post Oxygen Sensor

Position	Circuitry
5	SDM-R Module
6	PCM, MAF Sensor
7	AC Clutch Relay
8	Brake Switch, Trans Shift, PCM/EGR Ref. Lin EGR, Cnstr Purge Sol, Cnstr Purge SW
9	Horn Relay
10	Not Used
11	Not Used
12	Injectors #1-6
13	Ignition Module
14	Rt Hi Beam
15	Not Used
16	Lt Hi Beam
17	Not Used
18	Rt Low Beam
19	Lt Low Beam

Position	Circuitry
20	Turn Signal, Stepper Mtr, Brake Lmp, CHMSL
21	Fuel Pump Relay (Wire in BEC)
22	Ign Switch
23	In Key Module, PCM
24	To IP BEC-B/U Lamp
25	Flasher Module
26	Not Used
27	Not Used
28	Relay--Ign
29	Relay--Horn
30	Relay--Cooling Fan #2
31	Relay--Theft 1

Position	Circuitry
32	Relay--Theft 2
33	Relay--Cooling Fan S/P
34	Relay--Cooling Fan #1
35	Relay--A/C CLU micro
36	Relay--Fuel Pump micro
37	IP BEC
38	HVAC Blower Motor
39	Low Speed Fan Relay
40	LCM Module
41	To Rear BEC-Seats
42	To IP BEC "Run"
43	Starter Relays
44	High Speed Fan Rly

## Rear Fuse Block

Additional fuses are located in the fuse center, under the rear seat.

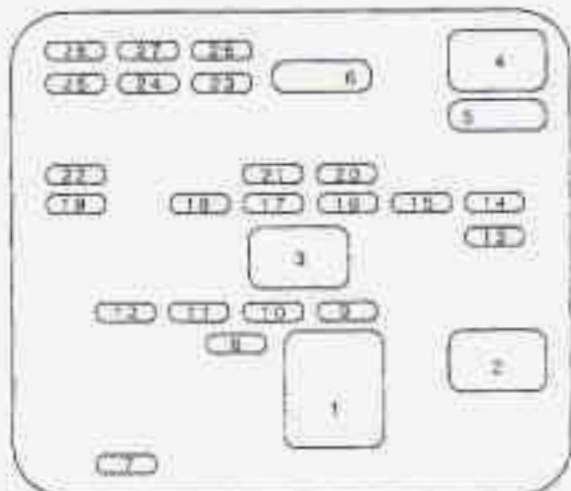

### Position    Circuitry

- |   |                                |
|---|--------------------------------|
| 1 | Relay--Htd Bklite to Rear Grid |
| 2 | Relay--Rap                     |
| 3 | Relay--Trunk Rel to Solenoid   |
| 4 | Relay--ELC to Compressor       |

### Position    Circuitry

- |    |   |
|----|---|
| 5  | Mem Seat Module, Driver Seat Switch, Driver Lumbar SW |
| 6  | ELC Sensor, ELC Cmpr Solenoid                         |
| 7  | SBM   |
| 8  | Aux Outlet (2 in Cn), Aux Outlet (1 in St)            |
| 9  | In-Key Module   |
| 10 | SBM Module  |
| 11 | Radio   |
| 12 | Sunroof   |
| 13 | Not Used  |
| 14 | Cel Phone Handset, Cel Phone Booster, CD Changer      |
| 15 | Driver Door Module                                    |
| 16 | Not Used  |
| 17 | Amp, Radio Head                                       |
| 18 | Dr Htd Seat Module                                    |
| 19 | Rear Door Mod (2 LD)                                  |
| 20 | Fuel Door Rel Sol, Trunk Rel Relay, DLC               |



Position	Circuitry
21	Not Used
22	IP Ashtray Cig Ltr
23	Not Used
24	Not Used
25	Pass Htd Seat Mod
26	Rt Rear Cig Ltr
27	Lt Rear Cig Ltr
28	RFA, Mem Seat Module, Driver Seat Switch

## Removing the Rear Seat Cushion

### NOTICE:

A fuse center is located under the rear seat cushion. To help avoid damage to the fuse center, be careful when removing or reinstalling the seat cushion.

### To Remove the Rear Seat Cushion

1. Pull up on the front of the cushion to release the front hooks.
2. Pull the cushion up and out toward the front of the vehicle.

### To Reinstall the Rear Seat Cushion

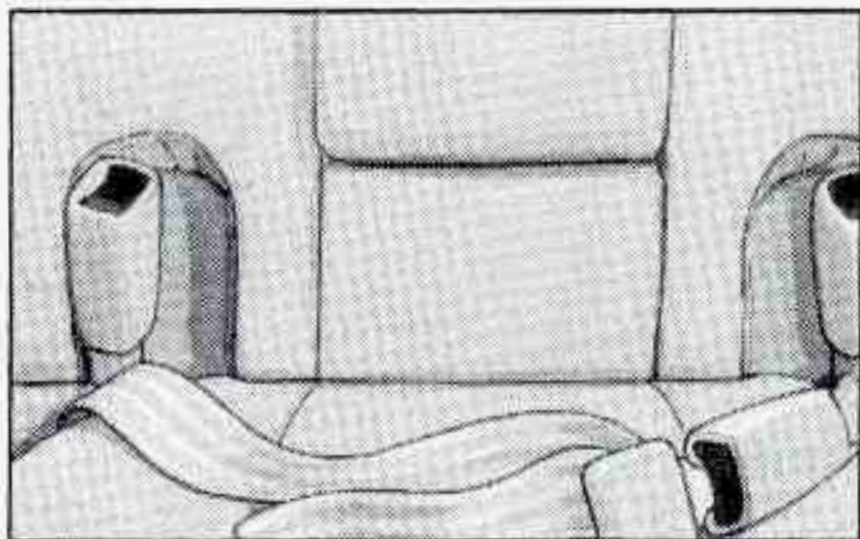

 **CAUTION:**

**A safety belt that isn't properly routed through the seat cushion or is twisted won't provide the protection needed in a crash. If the safety belt hasn't been routed through the seat cushion at all, it won't be there to work for the next passenger. The person sitting in that position could be badly injured. After reinstalling the seat cushion, always check to be sure that the safety belts are properly routed and are not twisted.**

1. Buckle the center passenger position safety belt, then route the safety belts through the proper slots in the seat cushion. Don't let the safety belts get twisted.
2. Slide the rear of the cushion up and under the seatback so the rear locating guides hook into the wire loops on the back frame.
3. With the seat cushion lowered, push rearward and then press down on the seat cushion until the spring locks on both ends engage.

4. Check to make sure the safety belts are properly routed and that no portion of any safety belt is trapped under the seat. Also make sure the seat cushion is secured.

## Replacement Bulbs

### EXTERIOR

### BULB

Headlamp	
High-Beam .....	9005
Low-Beam .....	9006
Park/Turn, Front .....	3057
Back-up .....	3057
Tail/Turn .....	3057
Tail/Stop .....	3057

For service information on other bulbs, contact your dealer's service department.

## Capacities and Specifications

The following approximate capacities are given in English and metric conversions. Please refer to "Recommended Fluids and Lubricants" in the Index for more information.

### Automatic Transaxle AT (Overdrive)

Pan Removal and Replacement .....	6 quarts (5.6 L)
After Complete Overhaul .....	11 quarts (10.4 L)

*When draining or replacing torque converter, more fluid may be needed.*

### Belt Tensions

Automatically controlled by a Self-Tension idler pulley. Tension adjustment should never be necessary.

Cooling System .....	13 quarts (12.3 L)
----------------------	--------------------

### Engine Crankcase

Oil change with filter change .....	4.5 quarts (4.3 L)
-------------------------------------	--------------------

Fuel Tank .....	18.5 gallons (70 L)
-----------------	---------------------

### Power Steering

Pump Only .....	1 pint (0.5 L)
-----------------	----------------

Complete System .....	1 1/2 pints (0.7 L)
-----------------------	---------------------

### Tire Pressure

See the Tire-Loading Information label on the rear edge of the driver's door.

Wheel Nut Torque .....	100 lb-ft (140 N-m)
------------------------	---------------------

R-134a Air Conditioning .....	See refrigerant charge label under the hood.
-------------------------------	--

NOTE: All capacities are approximate. When adding, be sure to fill to the appropriate level, as recommended in this manual.



## Air Conditioning Refrigerants

Not all air conditioning refrigerants are the same. If the air conditioning system in your vehicle needs refrigerant, be sure the proper refrigerant is used. If you're not sure, ask your dealer.

## Engine Specifications

<b>Engine</b>	<b>3800 Engine</b>	<b>3800 Supercharged Engine</b>
VIN Engine Code .....	K .....	1 .....
Type .....	V6 .....	V6 .....
Displacement .....	3.8L .....	3.8L .....
Compression Ratio .....	9:4:1 .....	8:5:1 .....
Horsepower .....	205 .....	240 .....
Firing Order .....	1-6-5-4-3-2 .....	1-6-5-4-3-2 .....
Thermostat Temperature Specification .....	195°F (91°C) .....	195°F (91°C) .....

## Vehicle Dimensions

### Overall

Length .....	206.8 inches (525.3 cm)
Width .....	74.7 inches (189.7 cm)
Height .....	58.1 inches (147.6 cm)
Wheelbase .....	113.8 inches (289.1 cm)
Front Tread .....	62.7 inches (159.3 cm)
Rear Tread .....	62.3 inches (158.2 cm)

## Normal Maintenance Replacement Parts

Air Cleaner Element .....	AC Type A-1096C
Engine Oil Filter .....	AC Type PF-47
Fuel Filter .....	AC Type GF-627
Spark Plugs .....	AC Type 41-921
	Gap: 0.060 inch (.152 cm)

### Windshield Wiper Blades

Type .....	Hook Style
Length .....	22 inches (56 cm)

### Passenger Compartment Air

Filter (HVAC air filter) .....	GM Part No. 52472175
--------------------------------	----------------------

## Engine Accessory Belt (L36)

The 3800 (L36) engine uses an engine accessory belt. This diagram shows the features connected by the belt routing. See "Maintenance Schedule" in the Index for when to check the belt.

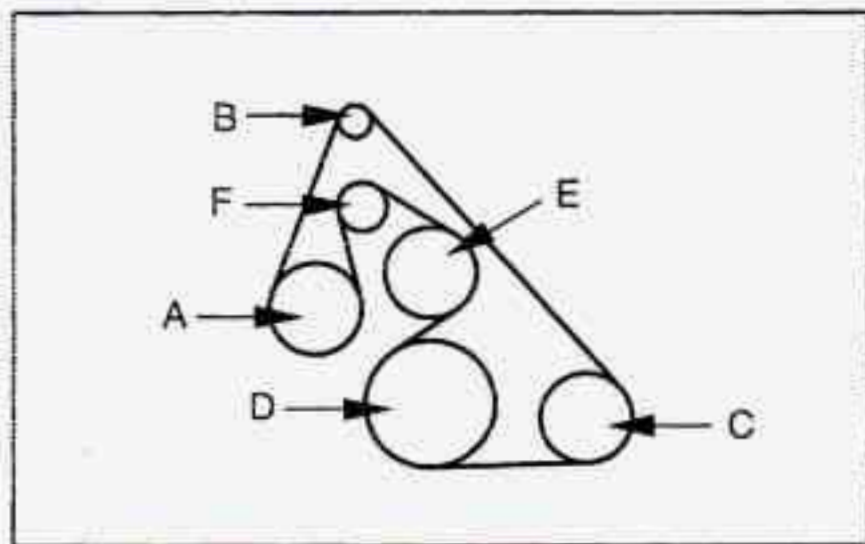

A. Power Steering

B. Generator

C. Air Conditioning

D. Crank

E. Coolant Pump

F. Tensioner

## Supercharged Engine Accessory Belt (L67)

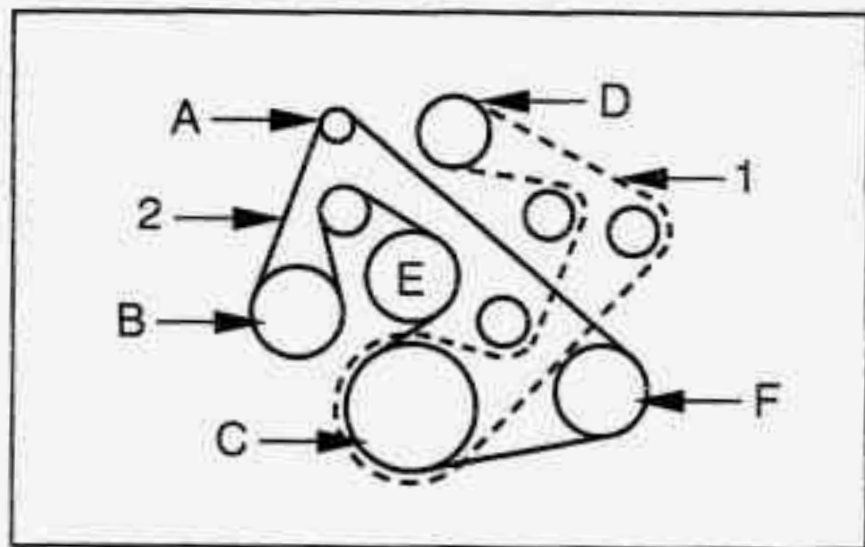

- |                   |                     |
|-------------------|---------------------|
| 1. Front Belt     | C. Crank            |
| 2. Back Belt      | D. Supercharger     |
| A. Generator      | E. Coolant Pump     |
| B. Power Steering | F. Air Conditioning |

The Supercharged 3800 engine uses two accessory drive belts. One belt drives the generator, power steering pump, coolant pump and air conditioning compressor. The second belt drives the supercharger. Each belt has its own tensioner and idler pulley. See "Maintenance Schedule" in the Index for when to check the accessory drive belts and supercharger oil level. Have your dealer check the oil level in the supercharger.







## Section 7 Maintenance Schedule

---

This section covers the maintenance required for your Buick. Your vehicle needs these services to retain its safety, dependability and emission control performance.

7-2	Introduction	7-31	At Least Once a Month
7-3	How This Section is Organized	7-32	At Least Twice a Year
7-4	Part A: Scheduled Maintenance Services	7-32	At Least Once a Year
7-4	Using Your Maintenance Schedule	7-35	Part C: Periodic Maintenance Inspections
7-4	Selecting the Right Schedule	7-36	Part D: Recommended Fluids and Lubricants
7-31	Part B: Owner Checks and Services	7-38	Part E: Maintenance Record
7-31	At Each Fuel Fill		

**IMPORTANT:  
KEEP ENGINE OIL  
AT THE PROPER  
LEVEL AND CHANGE AS  
RECOMMENDED.**



***Protection  
Plan***

*Have you purchased the GM Protection Plan? The Plan supplements your new vehicle warranties. See your Warranty and Owner Assistance booklet, or your Buick dealer for details.*

## Introduction

### Your Vehicle and the Environment

Proper vehicle maintenance not only helps to keep your vehicle in good working condition, but also helps the environment. All recommended maintenance procedures are important. Improper vehicle maintenance can even affect the quality of the air we breathe. Improper fluid levels or the wrong tire inflation can increase the level of emissions from your vehicle. To help protect our environment, and to keep your vehicle in good condition, please maintain your vehicle properly.



## How This Section is Organized

The remainder of this section is divided into five parts:

**“Part A: Scheduled Maintenance Services”** shows what to have done and how often. Some of these services can be complex, so unless you are technically qualified and have the necessary equipment, you should let your dealer’s service department or another qualified service center do these jobs.

### CAUTION:

**Performing maintenance work on a vehicle can be dangerous. In trying to do some jobs, you can be seriously injured. Do your own maintenance work only if you have the required know-how and the proper tools and equipment for the job. If you have any doubt, have a qualified technician do the work.**

If you are skilled enough to do some work on your vehicle, you will probably want to get the service information. See “Service and Owner Publications” in the Index.

**“Part B: Owner Checks and Services”** tells you what should be checked and when. It also explains what you can easily do to help keep your vehicle in good condition.

**“Part C: Periodic Maintenance Inspections”** explains important inspections that your dealer’s service department or another qualified service center should perform.

**“Part D: Recommended Fluids and Lubricants”** lists some recommended products to help keep your vehicle properly maintained. These products, or their equivalents, should be used whether you do the work yourself or have it done.

**“Part E: Maintenance Record”** provides a place for you to record the maintenance performed on your vehicle. Whenever any maintenance is performed, be sure to write it down in this part. This will help you determine when your next maintenance should be done. In addition, it is a good idea to keep your maintenance receipts. They may be needed to qualify your vehicle for warranty repairs.

## Part A: Scheduled Maintenance Services

### Using Your Maintenance Schedule

We at General Motors want to help you keep your vehicle in good working condition. But we don't know exactly how you'll drive it. You may drive very short distances only a few times a week. Or you may drive long distances all the time in very hot, dusty weather. You may use your vehicle in making deliveries. Or you may drive it to work, to do errands or in many other ways.

Because of all the different ways people use their vehicles, maintenance needs vary. You may even need more frequent checks and replacements than you'll find in the schedules in this section. So please read this section and note how you drive. If you have any questions on how to keep your vehicle in good condition, see your Buick dealer.

This part tells you the maintenance services you should have done and when you should schedule them. If you go to your dealer for your service needs, you'll know that GM-trained and supported service people will perform the work using genuine GM parts.

The proper fluids and lubricants to use are listed in Part D. Make sure whoever services your vehicle uses these. All parts should be replaced and all necessary repairs done before you or anyone else drives the vehicle.

These schedules are for vehicles that:

- carry passengers and cargo within recommended limits. You will find these limits on your vehicle's Tire-Loading Information label. See "Loading Your Vehicle" in the Index.
- are driven on reasonable road surfaces within legal driving limits.
- use the recommended fuel. See "Fuel" in the Index.

### Selecting the Right Schedule

First you'll need to decide which of the two schedules is right for your vehicle. Here's how to decide which schedule to follow:

## Maintenance Schedule

### Short Trip/City Definition

Follow the Short Trip/City Maintenance Schedule if any one of these conditions is true for your vehicle:

- Most trips are less than 5 to 10 miles (8 to 16 km). This is particularly important when outside temperatures are below freezing.
- Most trips include extensive idling (such as frequent driving in stop-and-go traffic).
- Most trips are through dusty areas.
- You frequently tow a trailer or use a carrier on top of your vehicle.
- If the vehicle is used for delivery service, police, taxi or other commercial application.

*One of the reasons you should follow this schedule if you operate your vehicle under any of these conditions is that these conditions cause engine oil to break down sooner.*

### Short Trip/City Intervals

**Every 3,000 Miles (5 000 km):** Engine Oil and Filter Change (or 3 months, whichever occurs first).

**Every 6,000 Miles (10 000 km):** Chassis Lubrication (or 6 months, whichever occurs first). Tire Rotation.

**Every 12,000 Miles (20 000 km):** Passenger Compartment Air Filter Replacement.

**Every 15,000 Miles (25 000 km):** Air Cleaner Filter Inspection, if driving in dusty conditions.

**Every 30,000 Miles (50 000 km):** Air Cleaner Filter Replacement. Fuel Tank, Cap and Lines Inspection. Supercharger Oil Check (or every 36 months, whichever occurs first) (3.8L Code 1 engine only).

**Every 50,000 Miles (83 000 km):** Automatic Transaxle Service (severe conditions only).

**Every 60,000 Miles (100 000 km):** Engine Accessory Drive Belt Inspection.

**Every 100,000 Miles (166 000 km):** Spark Plug Wire Inspection. Spark Plug Replacement.

**Every 150,000 Miles (240 000 km):** Cooling System Service (or every 60 months, whichever occurs first).

*These intervals only summarize maintenance services. Be sure to follow the complete maintenance schedule on the following pages.*



## Maintenance Schedule

### Long Trip/Highway Definition

Follow this maintenance schedule *only* if none of the conditions from the Short Trip/City Maintenance Schedule is true. Do not use this schedule if the vehicle is used for trailer towing, driven in a dusty area or used off paved roads. Use the Short Trip/City schedule for these conditions.

*Driving a vehicle with a fully warmed engine under highway conditions causes engine oil to break down slower.*

### Long Trip/Highway Intervals

**Every 7,500 Miles (12 500 km):** Engine Oil and Filter Change (or every 12 months, whichever occurs first). Chassis Lubrication (or every 12 months, whichever occurs first). Tire Rotation.

**Every 15,000 Miles (25 000 km):** Passenger Compartment Air Filter Replacement.

**Every 30,000 Miles (50 000 km):** Supercharger Oil Check (or every 36 months, whichever occurs first) (3.8L Code 1 engine only). Air Cleaner Filter Replacement. Fuel Tank, Cap and Lines Inspection.

**Every 50,000 Miles (83 000 km):** Automatic Transaxle Service (severe conditions only).

**Every 60,000 Miles (100 000 km):** Engine Accessory Drive Belt Inspection.

**Every 100,000 Miles (166 000 km):** Spark Plug Wire Inspection. Spark Plug Replacement.

**Every 150,000 Miles (240 000 km):** Cooling System Service (or every 60 months, whichever occurs first).

*These intervals only summarize maintenance services. Be sure to follow the complete maintenance schedule on the following pages.*

## Short Trip/City Maintenance Schedule

The services shown in this schedule up to 100,000 miles (166 000 km) should be performed after 100,000 miles (166 000 km) at the same intervals. The services shown at 150,000 miles (240 000 km) should be performed at the same interval after 150,000 miles (240 000 km).

See "Owner Checks and Services" and "Periodic Maintenance Inspections" following.

### Footnotes

† The U.S. Environmental Protection Agency or the California Air Resources Board has determined that the failure to perform this maintenance item will not nullify the emission warranty or limit recall liability prior to the completion of the vehicle's useful life. We, however, urge that all recommended maintenance services be performed at the indicated intervals and the maintenance be recorded.

# Lubricate the transaxle shift linkage, parking brake cable guides and the underbody contact points and linkage.

\* If your vehicle has an Engine Oil Life Monitor (Index), the monitor will show you when to change the oil -- usually between 3,000 miles (5 000 km) and 7,500 miles (12 500 km) since your last oil change. Under severe conditions, the indicator may come on before 3,000 miles (5 000 km). Never drive your vehicle more than 7,500 miles (12 500 km) or 12 months, (whichever occurs first), without an oil change.

The system won't detect dust in the oil. So if you drive in a dusty area be sure to change your oil every 3,000 miles (5 000 km) or sooner if the CHANGE OIL message appears. Remember to reset the Oil Life Monitor when the oil has been changed. For more information, see "Engine Oil Life Monitor (Index)" in the Index.

+ A good time to check your brakes is during tire rotation. See "Brake System Inspection" under "Periodic Maintenance Inspections" in Part C of this schedule.

## Short Trip/City Maintenance Schedule

### 3,000 Miles (5 000 km)

- Change engine oil and filter (or every 3 months, whichever occurs first).  
*An Emission Control Service. (See footnote \*.)*

DATE	
ACTUAL MILEAGE	SERVICED BY:

### 6,000 Miles (10 000 km)

- Change engine oil and filter (or every 3 months, whichever occurs first).  
*An Emission Control Service. (See footnote \*.)*
- Lubricate chassis components (or every 6 months, whichever occurs first).  
(See footnote #.)
- Rotate tires. See "Tire Inspection and Rotation" in the Index for proper rotation pattern and additional information. (See footnote +.)

DATE	
ACTUAL MILEAGE	SERVICED BY:

### 9,000 Miles (15 000 km)

- Change engine oil and filter (or every 3 months, whichever occurs first).  
*An Emission Control Service. (See footnote \*.)*

DATE	
ACTUAL MILEAGE	SERVICED BY:

### 12,000 Miles (20 000 km)

- Change engine oil and filter (or every 3 months, whichever occurs first).  
*An Emission Control Service. (See footnote \*.)*
- Lubricate chassis components (or every 6 months, whichever occurs first).  
(See footnote #.)

DATE	
ACTUAL MILEAGE	SERVICED BY:



## Short Trip/City Maintenance Schedule

- Replace passenger compartment air filter.
- Rotate tires. See "Tire Inspection and Rotation" in the Index for proper rotation pattern and additional information. (See footnote +.)

### 15,000 Miles (25 000 km)

- Change engine oil and filter (or every 3 months, whichever occurs first).  
*An Emission Control Service. (See footnote \*.)*
- Inspect air cleaner filter if you are driving in dusty conditions. Replace filter if necessary.  
*An Emission Control Service. (See footnote †.)*

### 18,000 Miles (30 000 km)

- Change engine oil and filter (or every 3 months, whichever occurs first).  
*An Emission Control Service. (See footnote \*.)*
- Lubricate chassis components (or every 6 months, whichever occurs first).  
*(See footnote #.)*
- Rotate tires. See "Tire Inspection and Rotation" in the Index for proper rotation pattern and additional information. (See footnote +.)

DATE	
ACTUAL MILEAGE	SERVICED BY:

DATE	
ACTUAL MILEAGE	SERVICED BY:

## Short Trip/City Maintenance Schedule

### 21,000 Miles (35 000 km)

- Change engine oil and filter (or every 3 months, whichever occurs first).  
*An Emission Control Service. (See footnote \*.)*

DATE	
ACTUAL MILEAGE	SERVICED BY:

### 24,000 Miles (40 000 km)

- Change engine oil and filter (or every 3 months, whichever occurs first).  
*An Emission Control Service. (See footnote \*.)*
- Lubricate chassis components (or every 6 months, whichever occurs first).  
*(See footnote #.)*
- Replace passenger compartment air filter.
- Rotate tires. See "Tire Inspection and Rotation" in the Index for proper rotation pattern and additional information. *(See footnote +.)*

DATE	
ACTUAL MILEAGE	SERVICED BY:

### 27,000 Miles (45 000 km)

- Change engine oil and filter (or every 3 months, whichever occurs first).  
*An Emission Control Service. (See footnote \*.)*

DATE	
ACTUAL MILEAGE	SERVICED BY:

## Short Trip/City Maintenance Schedule

### 30,000 Miles (50 000 km)

- Change engine oil and filter (or every 3 months, whichever occurs first).  
*An Emission Control Service. (See footnote \*.)*
- Lubricate chassis components (or every 6 months, whichever occurs first).  
*(See footnote #.)*
- Replace air cleaner filter.  
*An Emission Control Service.*
- Inspect fuel tank, cap and lines for damage or leaks. Inspect fuel cap gasket for any damage. Replace parts as needed.  
*An Emission Control Service. (See footnote †.)*
- For supercharged engines only: Check the supercharger oil level and add oil as needed (or every 36 months, whichever occurs first). See "Recommended Fluids and Lubricants" in this section.  
*An Emission Control Service. (See footnote †.)*
- Rotate tires. See "Tire Inspection and Rotation" in the Index for proper rotation pattern and additional information. *(See footnote +.)*

### 33,000 Miles (55 000 km)

- Change engine oil and filter (or every 3 months, whichever occurs first).  
*An Emission Control Service. (See footnote \*.)*

DATE	
ACTUAL MILEAGE	SERVICED BY:

DATE	
ACTUAL MILEAGE	SERVICED BY:



## Short Trip/City Maintenance Schedule

### 36,000 Miles (60 000 km)

- Change engine oil and filter (or every 3 months, whichever occurs first).  
*An Emission Control Service. (See footnote \*.)*
- Lubricate chassis components (or every 6 months, whichever occurs first).  
*(See footnote #.)*
- Replace passenger compartment air filter.
- Rotate tires. See "Tire Inspection and Rotation" in the Index for proper rotation pattern and additional information. *(See footnote +.)*

### 39,000 Miles (65 000 km)

- Change engine oil and filter (or every 3 months, whichever occurs first).  
*An Emission Control Service. (See footnote \*.)*

### 42,000 Miles (70 000 km)

- Change engine oil and filter (or every 3 months, whichever occurs first).  
*An Emission Control Service. (See footnote \*.)*
- Lubricate chassis components (or every 6 months, whichever occurs first).  
*(See footnote #.)*
- Rotate tires. See "Tire Inspection and Rotation" in the Index for proper rotation pattern and additional information. *(See footnote +.)*

DATE	
ACTUAL MILEAGE	SERVICED BY:

DATE	
ACTUAL MILEAGE	SERVICED BY:

DATE	
ACTUAL MILEAGE	SERVICED BY:

## Short Trip/City Maintenance Schedule

### 45,000 Miles (75 000 km)

- Change engine oil and filter (or every 3 months, whichever occurs first).  
*An Emission Control Service. (See footnote \*.)*
- Inspect air cleaner filter if you are driving in dusty conditions. Replace filter if necessary.  
*An Emission Control Service. (See footnote †.)*

### 48,000 Miles (80 000 km)

- Change engine oil and filter (or every 3 months, whichever occurs first).  
*An Emission Control Service. (See footnote \*.)*
- Lubricate chassis components (or every 6 months, whichever occurs first).  
*(See footnote #.)*
- Replace passenger compartment air filter.
- Rotate tires. See "Tire Inspection and Rotation" in the Index for proper rotation pattern and additional information. *(See footnote +.)*

### 50,000 Miles (83 000 km)

- Change automatic transaxle fluid and filter if the vehicle is mainly driven under one or more of these conditions:
  - In heavy city traffic where the outside temperature regularly reaches 90°F (32°C) or higher.
  - In hilly or mountainous terrain.

DATE	
ACTUAL MILEAGE	SERVICED BY:

DATE	
ACTUAL MILEAGE	SERVICED BY:

DATE	
ACTUAL MILEAGE	SERVICED BY:

*(Continued)*

## Short Trip/City Maintenance Schedule

*50,000 Miles (80 000 km) (Continued)*

- When doing frequent trailer towing.
- Uses such as found in taxi, police or delivery service.

*If you do not use your vehicle under any of these conditions, the fluid and filter do not require changing.*

*51,000 Miles (85 000 km)*

- Change engine oil and filter (or every 3 months, whichever occurs first).  
*An Emission Control Service. (See footnote \*.)*

*54,000 Miles (90 000 km)*

- Change engine oil and filter (or every 3 months, whichever occurs first).  
*An Emission Control Service. (See footnote \*.)*
- Lubricate chassis components (or every 6 months, whichever occurs first).  
*(See footnote #.)*
- Rotate tires. See "Tire Inspection and Rotation" in the Index for proper rotation pattern and additional information. *(See footnote +.)*

*57,000 Miles (95 000 km)*

- Change engine oil and filter (or every 3 months, whichever occurs first).  
*An Emission Control Service. (See footnote \*.)*

DATE	
ACTUAL MILEAGE	SERVICED BY:

DATE	
ACTUAL MILEAGE	SERVICED BY:

DATE	
ACTUAL MILEAGE	SERVICED BY:



## Short Trip/City Maintenance Schedule

### 60,000 Miles (100 000 km)

- Change engine oil and filter (or every 3 months, whichever occurs first).  
*An Emission Control Service. (See footnote \*.)*
- Lubricate chassis components (or every 6 months, whichever occurs first).  
*(See footnote #.)*
- Replace passenger compartment air filter.
- Inspect engine accessory drive belt.  
*An Emission Control Service.*
- Replace air cleaner filter.  
*An Emission Control Service.*
- Inspect fuel tank, cap and lines for damage or leaks. Inspect fuel cap gasket for any damage. Replace parts as needed.  
*An Emission Control Service. (See footnote †.)*
- For supercharged engines only: Check the supercharger oil level and add oil as needed (or every 36 months, whichever occurs first). See "Recommended Fluids and Lubricants" in this section.  
*An Emission Control Service. (See footnote ‡.)*
- Rotate tires. See "Tire Inspection and Rotation" in the Index for proper rotation pattern and additional information. *(See footnote +.)*

DATE	
ACTUAL MILEAGE	SERVICED BY:

## Short Trip/City Maintenance Schedule

### *63,000 Miles (105 000 km)*

- Change engine oil and filter (or every 3 months, whichever occurs first).  
*An Emission Control Service. (See footnote \*.)*

DATE	
ACTUAL MILEAGE	SERVICED BY:

### *66,000 Miles (110 000 km)*

- Change engine oil and filter (or every 3 months, whichever occurs first).  
*An Emission Control Service. (See footnote \*.)*
- Lubricate chassis components (or every 6 months, whichever occurs first).  
*(See footnote #.)*
- Rotate tires. See "Tire Inspection and Rotation" in the Index for proper rotation pattern and additional information. *(See footnote +.)*

DATE	
ACTUAL MILEAGE	SERVICED BY:

### *69,000 Miles (115 000 km)*

- Change engine oil and filter (or every 3 months, whichever occurs first).  
*An Emission Control Service. (See footnote \*.)*

DATE	
ACTUAL MILEAGE	SERVICED BY:

### *72,000 Miles (120 000 km)*

- Change engine oil and filter (or every 3 months, whichever occurs first).  
*An Emission Control Service. (See footnote \*.)*
- Lubricate chassis components (or every 6 months, whichever occurs first).  
*(See footnote #.)*

DATE	
ACTUAL MILEAGE	SERVICED BY:

## Short Trip/City Maintenance Schedule

- Replace passenger compartment air filter.
- Rotate tires. See "Tire Inspection and Rotation" in the Index for proper rotation pattern and additional information. (See footnote +.)

### *75,000 Miles (125 000 km)*

- Change engine oil and filter (or every 3 months, whichever occurs first).  
*An Emission Control Service.* (See footnote \*.)
- Inspect air cleaner filter if you are driving in dusty conditions. Replace filter if necessary.  
*An Emission Control Service.* (See footnote †.)

### *78,000 Miles (130 000 km)*

- Change engine oil and filter (or every 3 months, whichever occurs first).  
*An Emission Control Service.* (See footnote \*.)
- Lubricate chassis components (or every 6 months, whichever occurs first).  
(See footnote #.)
- Rotate tires. See "Tire Inspection and Rotation" in the Index for proper rotation pattern and additional information. (See footnote +.)

DATE	
ACTUAL MILEAGE	SERVICED BY:

DATE	
ACTUAL MILEAGE	SERVICED BY:



## Short Trip/City Maintenance Schedule

### 81,000 Miles (135 000 km)

- Change engine oil and filter (or every 3 months, whichever occurs first).  
*An Emission Control Service. (See footnote \*.)*

DATE	
ACTUAL MILEAGE	SERVICED BY:

### 84,000 Miles (140 000 km)

- Change engine oil and filter (or every 3 months, whichever occurs first).  
*An Emission Control Service. (See footnote \*.)*
- Lubricate chassis components (or every 6 months, whichever occurs first).  
*(See footnote #.)*
- Replace passenger compartment air filter.
- Rotate tires. See "Tire Inspection and Rotation" in the Index for proper rotation pattern and additional information. *(See footnote +.)*

DATE	
ACTUAL MILEAGE	SERVICED BY:

### 87,000 Miles (145 000 km)

- Change engine oil and filter (or every 3 months, whichever occurs first).  
*An Emission Control Service. (See footnote \*.)*

DATE	
ACTUAL MILEAGE	SERVICED BY:

## Short Trip/City Maintenance Schedule

### 90,000 Miles (150 000 km)

- Change engine oil and filter (or every 3 months, whichever occurs first).  
*An Emission Control Service. (See footnote \*.)*
- Lubricate chassis components (or every 6 months, whichever occurs first).  
*(See footnote #.)*
- Replace air cleaner filter.  
*An Emission Control Service.*
- Inspect fuel tank, cap and lines for damage or leaks. Inspect fuel cap gasket for any damage. Replace parts as needed.  
*An Emission Control Service. (See footnote †.)*
- For supercharged engines only: Check the supercharger oil level and add oil as needed (or every 36 months, whichever occurs first). See "Recommended Fluids and Lubricants" in this section.  
*An Emission Control Service. (See footnote †.)*
- Rotate tires. See "Tire Inspection and Rotation" in the Index for proper rotation pattern and additional information. *(See footnote +.)*

### 93,000 Miles (155 000 km)

- Change engine oil and filter (or every 3 months, whichever occurs first).  
*An Emission Control Service. (See footnote \*.)*

DATE	
ACTUAL MILEAGE	SERVICED BY:

DATE	
ACTUAL MILEAGE	SERVICED BY:

## Short Trip/City Maintenance Schedule

### *96,000 Miles (160 000 km)*

- Change engine oil and filter (or every 3 months, whichever occurs first).  
*An Emission Control Service. (See footnote \*.)*
- Lubricate chassis components (or every 6 months, whichever occurs first).  
(See footnote #.)
- Replace passenger compartment air filter.
- Rotate tires. See "Tire Inspection and Rotation" in the Index for proper rotation pattern and additional information. (See footnote +.)

### *99,000 Miles (165 000 km)*

- Change engine oil and filter (or every 3 months, whichever occurs first).  
*An Emission Control Service. (See footnote \*.)*

### *100,000 Miles (166 000 km)*

- Inspect spark plug wires.  
*An Emission Control Service.*
- Replace spark plugs.  
*An Emission Control Service.*

DATE	
ACTUAL MILEAGE	SERVICED BY:

DATE	
ACTUAL MILEAGE	SERVICED BY:

DATE	
ACTUAL MILEAGE	SERVICED BY:

*(Continued)*



## Short Trip/City Maintenance Schedule

*100,000 Miles (166 000 km) (Continued)*

- Change automatic transaxle fluid and filter if the vehicle is mainly driven under one or more of these conditions:
- In heavy city traffic where the outside temperature regularly reaches 90°F (32°C) or higher.
  - In hilly or mountainous terrain.
  - When doing frequent trailer towing.
  - Uses such as found in taxi, police or delivery service.

*If you do not use your vehicle under any of these conditions, the fluid and filter do not require changing.*

*150,000 Miles (240 000 km)*

- Drain, flush and refill cooling system (or every 60 months since last service, whichever occurs first). See "Engine Coolant" in the Index for what to use. Inspect hoses. Clean radiator, condenser, pressure cap and neck. Pressure test cooling system and pressure cap.  
*An Emission Control Service.*

DATE	
ACTUAL MILEAGE	SERVICED BY:

DATE	
ACTUAL MILEAGE	SERVICED BY:

## Long Trip/Highway Maintenance Schedule

The services shown in this schedule up to 100,000 miles (166 000 km) should be performed after 100,000 miles (166 000 km) at the same intervals. The services shown at 150,000 miles (240 000 km) should be performed at the same interval after 150,000 miles (240 000 km).

See "Owner Checks and Services" and "Periodic Maintenance Inspections" following.

### Footnotes

† The U.S. Environmental Protection Agency or the California Air Resources Board has determined that the failure to perform this maintenance item will not nullify the emission warranty or limit recall liability prior to the completion of the vehicle's useful life. We, however, urge that all recommended maintenance services be performed at the indicated intervals and the maintenance be recorded.

# Lubricate the transaxle shift linkage, parking brake cable guides and the underbody contact points and linkage.

\* If your vehicle has an Engine Oil Life Monitor (Index), the monitor will show you when to change the engine oil and filter -- usually between 3,000 miles (5 000 km) and 7,500 miles (12 500 km) since your last oil change. Under severe conditions, the indicator may come on before 3,000 miles (5 000 km). Never drive your vehicle more than 7,500 miles (12 500 km) or 12 months without an oil and filter change.

The system won't detect dust in the oil. So if you drive in a dusty area, be sure to change your oil and filter every 3,000 miles (5 000 km) or sooner if the CHANGE OIL message appears. Remember to reset the Oil Life Monitor when the oil has been changed. For more information, see "Engine Oil Life Monitor (Index)" in the Index.

+ A good time to check your brakes is during tire rotation. See "Brake System Inspection" under "Periodic Maintenance Inspections" in Part C of this schedule.

## Long Trip/Highway Maintenance Schedule

### 7,500 Miles (12 500 km)

- Change engine oil and filter (or every 12 months, whichever occurs first).  
*An Emission Control Service.* (See footnote #.)
- Lubricate chassis components (or every 12 months, whichever occurs first).  
(See footnote #.)
- Rotate tires. See "Tire Inspection and Rotation" in the Index for proper rotation pattern and additional information. (See footnote +.)

DATE	
ACTUAL MILEAGE	SERVICED BY:

### 15,000 Miles (25 000 km)

- Change engine oil and filter (or every 12 months, whichever occurs first).  
*An Emission Control Service.* (See footnote #.)
- Lubricate chassis components (or every 12 months, whichever occurs first).  
(See footnote #.)
- Replace passenger compartment air filter.
- Rotate tires. See "Tire Inspection and Rotation" in the Index for proper rotation pattern and additional information. (See footnote +.)

DATE	
ACTUAL MILEAGE	SERVICED BY:

### 22,500 Miles (37 500 km)

- Change engine oil and filter (or every 12 months, whichever occurs first).  
*An Emission Control Service.* (See footnote #.)
- Lubricate chassis components (or every 12 months, whichever occurs first).  
(See footnote #.)

DATE	
ACTUAL MILEAGE	SERVICED BY:

(Continued)



## Long Trip/Highway Maintenance Schedule

### 22,500 Miles (37 500 km) (Continued)

- Rotate tires. See "Tire Inspection and Rotation" in the Index for proper rotation pattern and additional information. (See footnote +.)

### 30,000 Miles (50 000 km)

- Change engine oil and filter (or every 12 months, whichever occurs first).  
*An Emission Control Service. (See footnote \*.)*
- Lubricate chassis components (or every 12 months, whichever occurs first).  
(See footnote #.)
- Replace passenger compartment air filter.
- Rotate tires. See "Tire Inspection and Rotation" in the Index for proper rotation pattern and additional information. (See footnote +.)
- Replace air cleaner filter.  
*An Emission Control Service.*
- Inspect fuel tank, cap and lines for damage or leaks. Inspect fuel cap gasket for any damage. Replace parts as needed.  
*An Emission Control Service. (See footnote †.)*
- For supercharged engines only: Check the supercharger oil level and add oil as needed (or every 36 months, whichever occurs first). See "Recommended Fluids and Lubricants" in this section.  
*An Emission Control Service. (See footnote †.)*

DATE	
ACTUAL MILEAGE	SERVICED BY:

## Long Trip/Highway Maintenance Schedule

### 37,500 Miles (62 500 km)

- Change engine oil and filter (or every 12 months, whichever occurs first).  
*An Emission Control Service. (See footnote \*.)*
- Lubricate chassis components (or every 12 months, whichever occurs first).  
*(See footnote #.)*
- Rotate tires. See "Tire Inspection and Rotation" in the Index for proper rotation pattern and additional information. *(See footnote +.)*

DATE	
ACTUAL MILEAGE	SERVICED BY:

### 45,000 Miles (75 000 km)

- Change engine oil and filter (or every 12 months, whichever occurs first).  
*An Emission Control Service. (See footnote \*.)*
- Lubricate chassis components (or every 12 months, whichever occurs first).  
*(See footnote #.)*
- Replace passenger compartment air filter.
- Rotate tires. See "Tire Inspection and Rotation" in the Index for proper rotation pattern and additional information. *(See footnote +.)*

DATE	
ACTUAL MILEAGE	SERVICED BY:

### 50,000 Miles (83 000 km)

- Change automatic transaxle fluid and filter if the vehicle is mainly driven under one or more of these conditions:
  - In heavy city traffic where the outside temperature regularly reaches 90°F (32°C) or higher.

DATE	
ACTUAL MILEAGE	SERVICED BY:

*(Continued)*

## Long Trip/Highway Maintenance Schedule

### 50,000 Miles (83 000 km) (Continued)

In hilly or mountainous terrain.

- When doing frequent trailer towing.

Uses such as found in taxi, police or delivery service.

*If you do not use your vehicle under any of these conditions, the fluid and filter do not require changing.*

### 52,500 Miles (87 500 km)

- Change engine oil and filter (or every 12 months, whichever occurs first).  
*An Emission Control Service. (See footnote \*.)*
- Lubricate chassis components (or every 12 months, whichever occurs first).  
*(See footnote #.)*
- Rotate tires. See "Tire Inspection and Rotation" in the Index for proper rotation pattern and additional information. *(See footnote +.)*

### 60,000 Miles (100 000 km)

- Change engine oil and filter (or every 12 months, whichever occurs first).  
*An Emission Control Service. (See footnote \*.)*
- Lubricate chassis components (or every 12 months, whichever occurs first).  
*(See footnote #.)*
- Replace passenger compartment air filter.

DATE	
ACTUAL MILEAGE	SERVICED BY:

DATE	
ACTUAL MILEAGE	SERVICED BY:



## Long Trip/Highway Maintenance Schedule

- For supercharged engines only: Check the supercharger oil level and add oil as needed (or every 36 months, whichever occurs first). See "Recommended Fluids and Lubricants" in this section.  
*An Emission Control Service. (See footnote †.)*
- Rotate tires. See "Tire Inspection and Rotation" in the Index for proper rotation pattern and additional information. (See footnote +.)
- Inspect engine accessory drive belt.  
*An Emission Control Service.*
- Replace air cleaner filter.  
*An Emission Control Service.*
- Inspect fuel tank, cap and lines for damage or leaks. Inspect fuel cap gasket for any damage. Replace parts as needed.  
*An Emission Control Service. (See footnote †.)*

### 67,500 Miles (112,500 km)

- Change engine oil and filter (or every 12 months, whichever occurs first).  
*An Emission Control Service. (See footnote \*.)*
- Lubricate chassis components (or every 12 months, whichever occurs first).  
(See footnote #.)
- Rotate tires. See "Tire Inspection and Rotation" in the Index for proper rotation pattern and additional information. (See footnote +.)

DATE	
ACTUAL MILEAGE	SERVICED BY:

## Long Trip/Highway Maintenance Schedule

### 75,000 Miles (125 000 km)

- Change engine oil and filter (or every 12 months, whichever occurs first).  
*An Emission Control Service.* (See footnote \*.)
- Lubricate chassis components (or every 12 months, whichever occurs first).  
(See footnote #.)
- Replace passenger compartment air filter.
- Rotate tires. See "Tire Inspection and Rotation" in the Index for proper rotation pattern and additional information. (See footnote +.)

DATE	
ACTUAL MILEAGE	SERVICED BY:

### 82,500 Miles (137 500 km)

- Change engine oil and filter (or every 12 months, whichever occurs first).  
*An Emission Control Service.* (See footnote \*.)
- Lubricate chassis components (or every 12 months, whichever occurs first).  
(See footnote #.)
- Rotate tires. See "Tire Inspection and Rotation" in the Index for proper rotation pattern and additional information. (See footnote +.)

DATE	
ACTUAL MILEAGE	SERVICED BY:

### 90,000 Miles (150 000 km)

- Change engine oil and filter (or every 12 months, whichever occurs first).  
*An Emission Control Service.* (See footnote \*.)
- Lubricate chassis components (or every 12 months, whichever occurs first).  
(See footnote #.)
- Replace passenger compartment air filter.

DATE	
ACTUAL MILEAGE	SERVICED BY:

## Long Trip/Highway Maintenance Schedule

### 90,000 Miles (150,000 km) (Continued)

- Replace air cleaner filter.  
*An Emission Control Service.*
- Inspect fuel tank, cap and lines for damage or leaks. Inspect fuel cap gasket for any damage. Replace parts as needed.  
*An Emission Control Service. (See footnote †.)*
- For supercharged engines only: Check the supercharger oil level and add oil as needed (or every 36 months, whichever occurs first). See "Recommended Fluids and Lubricants" in this section.  
*An Emission Control Service. (See footnote †.)*
- Rotate tires. See "Tire Inspection and Rotation" in the Index for proper rotation pattern and additional information. (See footnote +.)

### 97,500 Miles (162,500 km)

- Change engine oil and filter (or every 12 months, whichever occurs first).  
*An Emission Control Service. (See footnote \*.)*
- Lubricate chassis components (or every 12 months, whichever occurs first).  
*(See footnote #.)*
- Rotate tires. See "Tire Inspection and Rotation" in the Index for proper rotation pattern and additional information. (See footnote +.)

DATE	
ACTUAL MILEAGE	SERVICED BY:



## Long Trip/Highway Maintenance Schedule

### 100,000 Miles (166 000 km)

- Inspect spark plug wires.  
*An Emission Control Service.*
- Replace spark plugs.  
*An Emission Control Service.*
- Change automatic transaxle fluid and filter if the vehicle is mainly driven under one or more of these conditions:
  - In heavy city traffic where the outside temperature regularly reaches 90°F (32°C) or higher.
  - In hilly or mountainous terrain.
  - When doing frequent trailer towing.
  - Uses such as found in taxi, police or delivery service.

*If you do not use your vehicle under any of these conditions, the fluid and filter do not require changing.*

### 150,000 Miles (240 000 km)

- Drain, flush and refill cooling system (or every 60 months since last service, whichever occurs first). See "Engine Coolant" in the Index for what to use. Inspect hoses. Clean radiator, condenser, pressure cap and neck. Pressure test the cooling system and pressure cap.  
*An Emission Control Service.*

DATE	
ACTUAL MILEAGE	SERVICED BY:

DATE	
ACTUAL MILEAGE	SERVICED BY:

## Part B: Owner Checks and Services

Listed below are owner checks and services which should be performed at the intervals specified to help ensure the safety, dependability and emission control performance of your vehicle.

Be sure any necessary repairs are completed at once. Whenever any fluids or lubricants are added to your vehicle, make sure they are the proper ones, as shown in Part D.

### At Each Fuel Fill

*It is important for you or a service station attendant to perform these underhood checks at each fuel fill.*

#### Engine Oil Level Check

Check the engine oil level and add the proper oil if necessary. See "Engine Oil" in the Index for further details.

#### Engine Coolant Level Check

Check the engine coolant level and add DEX-COOL<sup>®</sup> coolant mixture if necessary. See "Engine Coolant" in the Index for further details.

#### Windshield Washer Fluid Level Check

Check the windshield washer fluid level in the windshield washer tank and add the proper fluid if necessary. See "Windshield Washer Fluid" in the Index for further details.

### At Least Once a Month

#### Tire Inflation Check

Make sure tires are inflated to the correct pressures. See "Tires" in the Index for further details.

#### Cassette Deck Service

Clean cassette deck. Cleaning should be done every 50 hours of tape play. See "Audio Systems" in the Index for further details.

## At Least Twice a Year

### Restraint System Check

Make sure the safety belt reminder light and all your belts, buckles, latch plates, retractors and anchorages are working properly. Look for any other loose or damaged safety belt system parts. If you see anything that might keep a safety belt system from doing its job, have it repaired. Have any torn or frayed safety belts replaced.

Also look for any opened or broken air bag coverings, and have them repaired or replaced. (The air bag system does not need regular maintenance.)

### Wiper Blade Check

Inspect wiper blades for wear or cracking. Replace blade inserts that appear worn or damaged or that streak or miss areas of the windshield. Also see "Wiper Blades, Cleaning" in the Index.

### Automatic Transaxle Check

Check the transaxle fluid level; add if needed. See "Automatic Transaxle" in the Index. A fluid loss may indicate a problem. Check the system and repair if needed.

## At Least Once a Year

### Key Lock Cylinders Service

Lubricate the key lock cylinders with the lubricant specified in Part D.

### Body Lubrication Service

Lubricate all body door hinges. Also lubricate all hinges and latches, including those for the hood, glove box door and console door. Part D tells you what to use. More frequent lubrication may be required when exposed to a corrosive environment.



## Starter Switch Check

### CAUTION:

**When you are doing this check, the vehicle could move suddenly. If it does, you or others could be injured. Follow the steps below.**

1. Before you start, be sure you have enough room around the vehicle.
2. Firmly apply both the parking brake (see "Parking Brake" in the Index if necessary) and the regular brake.

**NOTE:** Do not use the accelerator pedal, and be ready to turn off the engine immediately if it starts.

3. Try to start the engine in each gear. The starter should work only in PARK (P) or NEUTRAL (N). If the starter works in any other position, your vehicle needs service.

## Brake-Transaxle Shift Interlock (BTSI) Check

### CAUTION:

**When you are doing this check, the vehicle could move suddenly. If it does, you or others could be injured. Follow the steps below.**

1. Before you start, be sure you have enough room around the vehicle. It should be parked on a level surface.
2. Firmly apply the parking brake (see "Parking Brake" in the Index if necessary).

**NOTE:** Be ready to apply the regular brake immediately if the vehicle begins to move.

3. With the engine off, turn the key to the RUN position, but don't start the engine. Without applying the regular brake, try to move the shift lever out of PARK (P) with normal effort. If the shift lever moves out of PARK (P), your vehicle's BTSI needs service.

### Ignition Transaxle Lock Check

While parked, and with the parking brake set, try to turn the ignition key to LOCK in each shift lever position.

- The key should turn to LOCK only when the shift lever is in PARK (P).
- The key should come out only in LOCK.

### Parking Brake and Automatic Transaxle PARK (P) Mechanism Check



#### CAUTION:

When you are doing this check, your vehicle could begin to move. You or others could be injured and property could be damaged. Make sure there is room in front of your vehicle in case it begins to roll. Be ready to apply the regular brake at once should the vehicle begin to move.

Park on a fairly steep hill, with the vehicle facing downhill. Keeping your foot on the regular brake, set the parking brake.

- To check the parking brake's holding ability: With the engine running and transaxle in NEUTRAL (N), slowly remove foot pressure from the regular brake pedal. Do this until the vehicle is held by the parking brake only.
- To check the PARK (P) mechanism's holding ability: With the engine running, shift to PARK (P). Then release all brakes.

### Underbody Flushing Service

At least every spring, use plain water to flush any corrosive materials from the underbody. Take care to clean thoroughly any areas where mud and other debris can collect.

## Part C: Periodic Maintenance Inspections

Listed below are inspections and services which should be performed at least twice a year (for instance, each spring and fall). *You should let your dealer's service department or other qualified service center do these jobs. Make sure any necessary repairs are completed at once.*

Proper procedures to perform these services may be found in a service manual. See "Service and Owner Publications" in the Index.

### Steering, Suspension and Front Drive Axle Boot and Seal Inspection

Inspect the front and rear suspension and steering system for damaged, loose or missing parts, signs of wear or lack of lubrication. Inspect the power steering lines and hoses for proper hook-up, binding, leaks, cracks, chafing, etc. Clean and then inspect the drive axle boot seals for damage, tears or leakage. Replace seals if necessary.

### Exhaust System Inspection

Inspect the complete exhaust system. Inspect the body near the exhaust system. Look for broken, damaged, missing or out-of-position parts as well as open seams, holes, loose connections or other conditions which could cause a heat

build-up in the floor pan or could let exhaust fumes into the vehicle. See "Engine Exhaust" in the Index.

### Engine Cooling System Inspection

Inspect the hoses and have them replaced if they are cracked, swollen or deteriorated. Inspect all pipes, fittings and clamps; replace as needed. Clean the outside of the radiator and air conditioning condenser. To help ensure proper operation, a pressure test of the cooling system and pressure cap is recommended at least once a year.

### Throttle System Inspection

Inspect the throttle system for interference or binding, and for damaged or missing parts. Replace parts as needed. Replace any components that have high effort or excessive wear. Do not lubricate accelerator and cruise control cables.

### Brake System Inspection

Inspect the complete system. Inspect brake lines and hoses for proper hook-up, binding, leaks, cracks, chafing, etc. Inspect disc brake pads for wear and rotors for surface condition. Also inspect other brake parts, including calipers, parking brake, etc. Check parking brake adjustment. You may need to have your brakes inspected more often if your driving habits or conditions result in frequent braking.



## Part D: Recommended Fluids and Lubricants

NOTE: Fluids and lubricants identified below by name, part number or specification may be obtained from your dealer.

USAGE	FLUID/LUBRICANT
Engine Oil	Engine Oil with the American Petroleum Institute Certified For Gasoline Engines "Starburst" symbol of the proper viscosity. To determine the preferred viscosity for your vehicle's engine, see "Engine Oil" in the Index.
Engine Coolant	50/50 mixture of clean water (preferably distilled) and use only GM Goodwrench <sup>®</sup> DEX-COOL <sup>®</sup> or Havoline <sup>®</sup> DEX-COOL <sup>®</sup> Coolant. See "Engine Coolant" in the Index.
Hydraulic Brake System	Delco Supreme II <sup>®</sup> Brake Fluid (GM Part No. 12377967 or equivalent DOT-3 Brake Fluid).

USAGE	FLUID/LUBRICANT
Parking Brake Cable Guides	Chassis Lubricant (GM Part No. 12377985 or equivalent) or lubricant meeting requirements of NLGI # 2, Category LB or GC-LB.
Power Steering System	GM Power Steering Fluid (GM Part No. 1052884 - 1 pint, 1050017 - 1 quart, or equivalent).
Automatic Transaxle	DEXRON <sup>®</sup> -III Automatic Transmission Fluid.
Key Lock Cylinders	Multi-Purpose Lubricant, Superlube <sup>®</sup> (GM Part No. 12346241 or equivalent).
Supercharger	Supercharger Oil (GM Part No. 12345982). See "Supercharger Oil" in the Index.
Chassis Lubrication	Chassis Lubricant (GM Part No. 12377985 or equivalent) or lubricant meeting requirements of NLGI # 2, Category LB or GC-LB.

USAGE	FLUID/LUBRICANT
Windshield Washer Solvent	GM Optikleen <sup>®</sup> Washer Solvent (GM Part No. 1051515) or equivalent.
Hood Latch Assembly, Secondary Latch, Pivots, Spring Anchor and Release Pawl	Lubriplate <sup>®</sup> Lubricant Aerosol (GM Part No. 12346293 or equivalent) or lubricant meeting requirements of NLGI # 2, Category LB or GC-LB.

USAGE	FLUID/LUBRICANT
Hood and Door Hinges	Multi-Purpose Lubricant, Superlube <sup>®</sup> (GM Part No. 12346241 or equivalent).
Weatherstrip Conditioning	Dielectric Silicone Grease (GM Part No. 12345579 or equivalent).

## Part B: Maintenance Record

After the scheduled services are performed, record the date, odometer reading and who performed the service in the boxes provided after the maintenance interval.

Any additional information from "Owner Checks and Services" or "Periodic Maintenance" can be added on the following record pages. Also, you should retain all maintenance receipts. Your owner information portfolio is a convenient place to store them.

<b>Maintenance Record</b>			
<b>DATE</b>	<b>ODOMETER READING</b>	<b>SERVICED BY</b>	<b>MAINTENANCE PERFORMED</b>









## Section 8 Customer Assistance Information

---

Here you will find out how to contact Buick if you need assistance. This section also tells you how to obtain service publications and how to report any safety defects.

8-2	Customer Satisfaction Procedure	8-8	Warranty Information
8-4	Customer Assistance for Text Telephone (TTY) Users	8-8	Reporting Safety Defects to the United States Government
8-5	Roadside Assistance	8-9	Reporting Safety Defects to the Canadian Government
8-5	Canadian Roadside Assistance	8-9	Reporting Safety Defects to General Motors
8-6	Courtesy Transportation	8-9	Ordering Service and Owner Publications in Canada
8-7	GM Participation in an Alternative Dispute Resolution Program		



## Customer Satisfaction Procedure



Buick dealers have the facilities, trained technicians and up-to-date information to promptly address any concerns you may have. However, if a concern has not been resolved to your complete satisfaction, take the following steps:

**STEP ONE** -- Discuss your concern with a member of dealership management. Normally, concerns can be quickly resolved at that level. If the matter has already been reviewed with the sales, service or parts manager, contact the owner of the dealership or the general manager.

**STEP TWO** -- If after contacting a member of dealership management, it appears your concern cannot be resolved by the dealership without further help, contact the Buick Customer Relations Center by calling 1-800-521-7300. In Canada, contact GM of Canada Customer Communication Centre in Oshawa by calling 1-800-263-3777 (English) or 1-800-263-7854 (French).

For help outside of the United States and Canada, call the following numbers as appropriate:

- In Mexico: (525) 625-3256
- In Puerto Rico: 1-800-496-9992 (English) or 1-800-496-9993 (Spanish)
- In the U.S. Virgin Islands: 1-800-496-9994
- In the Dominican Republic: 1-800-751-4135 (English) or 1-800-751-4136 (Spanish)
- In the Bahamas: 1-800-389-0009
- In Bermuda, Barbados, Antigua and the British Virgin Islands: 1-800-534-0122
- In all other Caribbean countries: (809) 763-1315
- In other overseas locations, call GM Overseas Distribution Corporation in Canada at: (905) 644-4112.

For prompt assistance, please have the following information available to give the Customer Assistance Representative:

- Your name, address, home and business telephone numbers
- Vehicle Identification Number (This is available from the vehicle registration or title, or the plate at the top left of the instrument panel and visible through the windshield.)
- Dealership name and location
- Vehicle delivery date and present mileage
- Nature of concern

We encourage you to call us so we can give your inquiry prompt attention. However, if you wish to write Buick, address your inquiry to:

Buick Motor Division  
Customer Relations Center  
902 E. Hamilton Avenue  
Flint, MI 48550

In Canada, write to:

General Motors of Canada Limited  
Customer Communication Centre, 163-005  
1908 Colonel Sam Drive  
Oshawa, Ontario L1H 8P7

Refer to your Warranty and Owner Assistance Information booklet for addresses of GM Overseas offices.

When contacting Buick, please remember that your concern will likely be resolved in the dealership, using the dealer's facilities, equipment and personnel. That is why we suggest you follow Step One first if you have a concern.

### Customer Assistance for Text Telephone (TTY) Users

To assist customers who are deaf, hard of hearing, or speech-impaired and who use Text Telephones (TTYs), Buick has TTY equipment available at its Customer Assistance Center. Any TTY user can communicate with Buick by dialing: 1-800-83-BUICK. (TTY users in Canada can dial 1-800-263-3830.)



## Roadside Assistance

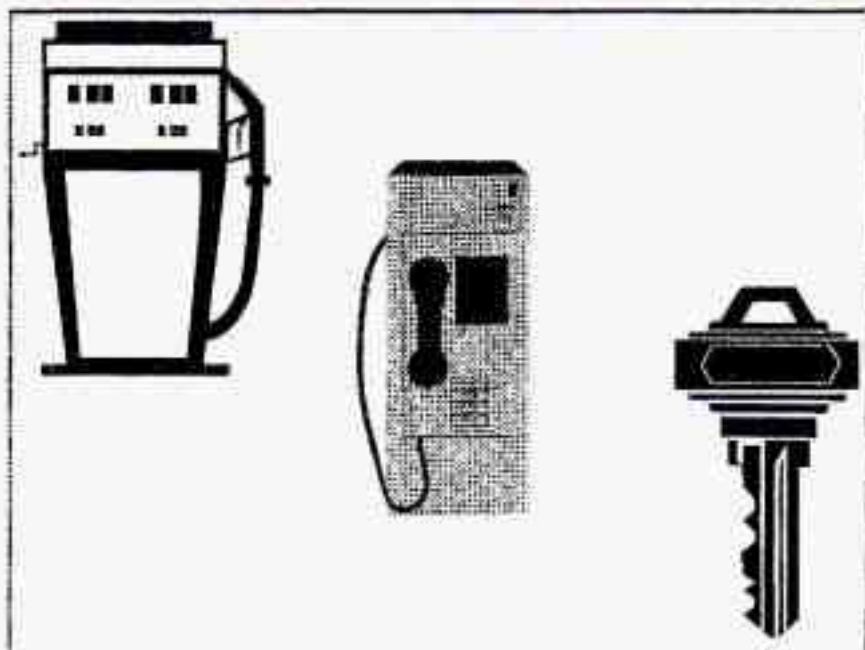

Buick Motor Division is proud to offer Buick Premium Roadside Assistance to customers for vehicles covered under the 3 year/36,000 mile (60 000 km) new car warranty (whichever occurs first).

Our commitment to Buick owners has always included superior service through our network of over 2,800 Buick dealers. Buick Premium Roadside Assistance provides an extra measure of convenience and security.

### BUICK PREMIUM ROADSIDE ASSISTANCE:

- Provides owners with access to minor repairs or towing for disabled vehicles. Although Roadside Assistance is not a repair facility, it is a means of assisting customers in an emergency situation.
- Takes the anxiety out of uncertain situations by providing easy access to service professionals trained to work with Buick owners, 24 hours a day, 365 days a year, including weekends and holidays.

For details on Buick Premium Roadside Assistance, please consult your Buick Premium Roadside Assistance owner booklet included with your owner's manual. For needed assistance, call the Buick Premium Roadside Assistance toll-free hotline: 1-800-252-1112.

### Canadian Roadside Assistance

Vehicles purchased in Canada have an extensive Roadside Assistance program accessible from anywhere in Canada or the United States. Please refer to the separate brochure provided by the dealer or call 1-800-268-6800 for emergency services.

## Courtesy Transportation

To Buick Motor Division, Quality Means Service -- and service means "keeping you on the road."

Included with your Buick new car warranty (3 years/36,000 miles (60 000 km), whichever occurs first), is Courtesy Transportation, a program which will provide Buick retail and lease customers with:

- Reimbursement toward a loaner vehicle, courtesy of Buick Motor Division, up to \$30 a day (five days maximum) for vehicles requiring overnight warranty repairs. Also, reimbursement up to \$30 a day (five days maximum) may be available for the cost of a rental car, bus or even a cab.
- A free one-way shuttle ride or vehicle pick-up from a location up to 10 miles (16 km) from the dealership is available for those whose vehicle only requires same day warranty repairs.

**NOTE:** All Courtesy Transportation arrangements will be administered by your Buick dealer service management.

Courtesy Transportation is Buick's way of extending the Premium Service you've come to expect from Buick and its over 2,800 dealers. Please review the Courtesy Transportation glove box card contained in your vehicle or consult your Buick dealer for details.

Because of uncertain availability, it is frequently not possible to provide customers with the same model loaner vehicle (including optional equipment) as the vehicle the customer owns or leases and has brought in for warranty repair. If a loaner vehicle is required, please consult your dealership for complete program details and loaner car availability in your area.

Some state insurance regulations make it impractical to rent vehicles to people under 21 years of age. If you are under 21 and have difficulty renting a vehicle, Buick will reimburse you up to \$30/day, for any documented transportation you receive. Please consult your dealer for details.

For warranty repairs during the Complete Vehicle Coverage period in the New Vehicle Limited Warranty, interim transportation may be available under the Courtesy Transportation program. Please consult your dealer for details. The Courtesy Transportation program is available only in the United States and Canada.

**In Canada,** please consult your GM dealer for information on Courtesy Transportation.

Buick reserves the right to make any changes or discontinue the Courtesy Transportation program at any time without notification.

## GM Participation in an Alternative Dispute Resolution Program

This program is available in all 50 states and the District of Columbia. Canadian owners refer to your Warranty and Owner Assistance Information booklet for information on the Canadian Motor Vehicle Arbitration Plan (CAMVAP). General Motors reserves the right to change eligibility limitations and/or to discontinue its participation in this program.

Both Buick and your Buick dealer are committed to making sure you are completely satisfied with your new vehicle. Our experience has shown that, if a situation arises where you feel your concern has not been adequately addressed, the Customer Satisfaction Procedure described earlier in this section is very successful.

There may be instances where an impartial third party can assist in arriving at a solution to a disagreement regarding vehicle repairs or interpretation of the New Vehicle Limited Warranty. To assist in resolving these disagreements, Buick voluntarily participates in BBB AUTO LINE.

BBB AUTO LINE is an out-of-court program administered by the Better Business Bureau system to settle automotive disputes. This program is available free of charge to customers who currently own or lease a GM vehicle.

If you are not satisfied after following the Customer Satisfaction Procedure, you may contact the BBB using the toll-free telephone number, or write them at the following address:

BBB AUTO LINE  
Council of Better Business Bureaus, Inc.  
4200 Wilson Boulevard  
Suite 800  
Arlington, VA 22203-1804  
Telephone: 1-800-955-5100

To file a claim, you will be asked to provide your name and address, your Vehicle Identification Number (VIN) and a statement of the nature of your complaint. Eligibility is limited by vehicle age and mileage, and other factors.



We prefer you utilize the Customer Satisfaction Procedure before you resort to AUTO LINE, but you may contact the BBB at any time. The BBB will attempt to resolve the complaint serving as an intermediary. If this mediation is unsuccessful, an informal hearing will be scheduled where eligible customers may present their case to an impartial third-party arbitrator.

The arbitrator will make a decision which you may accept or reject. If you accept the decision, GM will be bound by that decision. The entire dispute resolution procedure should ordinarily take about 40 days from the time you file a claim until a decision is made.

Some state laws may require you to use this program before filing a claim with a state-run arbitration program or in the courts. For further information, contact the BBB at 1-800-955-5100 or the Buick Customer Assistance Center at 1-800-521-7300.

### Warranty Information

Your vehicle comes with a separate warranty booklet that contains detailed warranty information.

## REPORTING SAFETY DEFECTS TO THE UNITED STATES GOVERNMENT

If you believe that your vehicle has a defect which could cause a crash or could cause injury or death, you should immediately inform the National Highway Traffic Safety Administration (NHTSA), in addition to notifying General Motors.

If NHTSA receives similar complaints, it may open an investigation, and if it finds that a safety defect exists in a group of vehicles, it may order a recall and remedy campaign. However, NHTSA cannot become involved in individual problems between you, your dealer or General Motors.

To contact NHTSA, you may either call the Auto Safety Hotline toll-free at 1-800-424-9393 (or 366-0123 in the Washington, D.C. area) or write to:

NHTSA, U.S. Department of Transportation  
Washington, D.C. 20590

You can also obtain other information about motor vehicle safety from the Hotline.

## REPORTING SAFETY DEFECTS TO THE CANADIAN GOVERNMENT

If you live in Canada, and you believe that your vehicle has a safety defect, you should immediately notify Transport Canada, in addition to notifying General Motors of Canada Limited. You may write to:

Transport Canada  
Box 8880  
Ottawa, Ontario K1G 3J2

## REPORTING SAFETY DEFECTS TO GENERAL MOTORS

In addition to notifying NHTSA (or Transport Canada) in a situation like this, we certainly hope you'll notify us. Please call us at 1-800-521-7300, or write:

Buick Motor Division  
Customer Relations Center  
902 E. Hamilton Avenue  
Flint, MI 48550

In Canada, please call us at 1-800-263-3777 (English) or 1-800-263-7854 (French). Or, write:

General Motors of Canada Limited  
Customer Communication Centre, 163-005  
1908 Colonel Sam Drive  
Oshawa, Ontario L1H 8P7

## Ordering Service and Owner Publications in Canada

Service manuals, owner's manuals and other service literature are available for purchase for all current and past model General Motors vehicles.

The toll-free telephone number for ordering information in Canada is 1-800-668-5539.



# 1998 BUICK SERVICE PUBLICATIONS ORDERING INFORMATION

*The following publications covering the operation and servicing of your vehicle can be purchased by filling out the Service Publication Order Form in this book and mailing it in with your check, money order, or credit card information to Helm, Incorporated (address below.)*

## CURRENT PUBLICATIONS FOR 1998 BUICK

### SERVICE MANUALS

Service Manuals have the diagnosis and repair information on engines, transmission, axle, suspension, brakes, electrical, steering, body, etc.

RETAIL SELL PRICE: \$90.00

### TRANSMISSION, TRANSAXLE, TRANSFER CASE UNIT REPAIR MANUAL

This manual provides information on unit repair service procedures, adjustments and specifications for the 1998 GM transmissions, transaxles and transfer cases.

RETAIL SELL PRICE: \$40.00

### SERVICE BULLETINS

Service Bulletins give technical service information needed to knowledgeably service General Motors cars and trucks. Each bulletin contains instructions to assist in the diagnosis and service of your vehicle.

**PLEASE COMPLETE THE ORDER FORM SHOWN ON THE FOLLOWING PAGE AND MAIL TO:**

Helm, Incorporated • P.O. Box 07130 • Detroit, MI 48207

### OWNER'S INFORMATION

Owner publications are written directly for Owners and intended to provide basic operational information about the vehicle. The owner's manual will include the Maintenance Schedule for all models.

In-Portfolio: Includes a Portfolio, Owner's Manual and Warranty Booklet.

RETAIL SELL PRICE: \$15.00

Without Portfolio: Owner's Manual only.

RETAIL SELL PRICE: \$10.00

### CURRENT & PAST MODEL ORDER FORMS

Service Publications are available for current and past model GM vehicles. To request an order form, please specify year and model name of the vehicle.

**OR ORDER TOLL FREE: 1-800-782-4356**

Monday-Friday 8:00 AM - 5:00 PM Eastern Time

For Credit Card Orders Only (VISA-MasterCard-Discover)



**ORDER TOLL FREE***(NOTE: For Credit Card Holders Only)***1-800-782-4356***(Monday-Friday 8:00 AM - 5:00 PM EST)**FAX Orders Only 1-313-865-5927*

Orders will be mailed within 10 days of receipt. Please allow adequate time for postal service. If further information is needed, write to the address shown below or call 1-800-782-4356. Material cannot be returned for credit without packing slip with return information within 30 days of delivery. On returns, a re-stocking fee may be applied against the original order.

PUBLICATION FORM NUMBER	ITEM DESCRIPTION	VEHICLE MODEL		QTY.	PRICE EACH*	TOTAL PRICE
		NAME	YEAR			
	Service Manual		1998		\$90.00	
	Car & Light Truck Transmission Unit Repair		1998		\$40.00	
	Owner's Manual In Portfolio		1998		\$15.00	
	Owner's Manual Without Portfolio		1998		\$10.00	

**NOTE:** Dealers and Companies please provide dealer or company name, and also the name of the person to whose attention the shipment should be sent.

Mail completed order form to:

HELM, INCORPORATED • P.O. Box 07130 • Detroit, MI 48207

For purchases outside U.S.A. please write to the above address for quotation.

(CUSTOMER'S NAME) (ATTENTION)

(STREET ADDRESS—NO P.O. BOX NUMBERS)

(CITY) (STATE) (ZIP CODE)

DAYTIME TELEPHONE NO.

( )  
AREA CODE

**PAYMENT**

Check or Money  
Order payable to  
Helm, Inc. (USA funds  
only — do not send cash.)

MasterCard

VISA

Discover

Account Number:

Expiration Date mo/yr:     Check here if your billing address is different from your shipping address shown

CUSTOMER SIGNATURE

**TOTAL MATERIAL**

Michigan Purchasers  
add 6% sales tax

U.S. Order Processing **\$5.00**

Canadian Postage  
(See Note Below)

**GRAND TOTAL**

ORD98 \*(Prices are subject to change without notice and without incurring obligation. Allow ample time for delivery.)

Note to Canadian Customers: All listed prices are quoted in U.S. funds. Canadian residents are to make checks payable in U.S. funds. To cover Canadian postage, add \$11.50 plus the U.S. order processing.





## Section 9 Index

<b>A</b> ir Bag .....	1-21	Armrest, Storage .....	2-60, 2-61
How Does it Restrain .....	1-25	Ashtrays .....	2-62
How it Works .....	1-23	Assist Straps .....	2-66
Location .....	1-23	AstrorooF .....	2-65
Readiness Light .....	1-22, 2-76	Audio Controls, Steering Wheel Touch Control .....	3-33
Servicing .....	1-26	Audio Equipment, Adding .....	3-34
What Makes it Inflate .....	1-25	Audio Systems .....	3-10
What Will You See After it Inflates .....	1-25	Personal Choice .....	3-30
When Should it Inflate .....	1-24	Automatic Overdrive .....	2-26
Air Cleaner .....	6-17	Automatic Transaxle .....	
Air Conditioning .....	3-5	Check .....	7-32
Air Conditioning Refrigerants .....	6-73	Park Mechanism Check .....	7-34
Air Control, Climate Control System .....	3-3, 3-4	Fluid .....	6-20
Air Filter, Passenger Compartment .....	3-7	Operation .....	2-24
Alarm, Content Theft-Deterrent .....	2-16	Auxiliary Power Outlets .....	2-64
Alarm, Instant, Keyless Entry .....	2-9		
Alignment and Balance, Tire .....	6-52	<b>B</b> attery .....	6-32
Aluminum Wheels, Cleaning .....	6-60	Jump Starting .....	5-3
Antenna, Heated Backlite .....	3-36	Replacement, Keyless Entry .....	2-13
Antifreeze .....	6-23	Rundown Protection .....	2-50
Anti-Lock .....		Warning Light .....	2-76
Brake System Warning Light .....	2-78, 4-7	Warnings .....	5-3, 5-4
Brakes .....	4-7	BBB Auto Line .....	8-7
Anti-Theft, Radio .....	3-30	Belt, Engine Accessory .....	6-74, 6-75
Appearance Care .....	6-55	Better Business Bureau Mediation .....	8-7
Appearance Care Materials .....	6-62	Blizzard, Driving In .....	4-28
Arbitration Program .....	8-7		



Brake			
Adjustment	6-32		
Fluid	6-29		
Master Cylinder	6-29		
Parking	2-27		
Pedal Travel	6-32		
Replacing System Parts	6-32		
System Warning Light	2-77		
Transaxle Shift Interlock	2-31		
Transaxle Shift Interlock Check	7-33		
Wear	6-31		
Trailer	4-36		
Brakes, Anti-Lock	4-7		
Braking	4-6		
Braking in Emergencies	4-10		
Break-In, New Vehicle	2-20		
BTSI	2-31		
BTSI Check	7-33		
Bulb Replacement	6-33		
<b>C</b> anadian Roadside Assistance	8-5		
Capacities and Specifications	6-72		
Carbon Monoxide	2-15, 2-32, 4-29, 4-35		
Cassette Deck Service	7-31		
Cassette Tape Player	3-10, 3-14		
Care	3-35		
Errors	3-12, 3-16		
CD Changer, Trunk Mounted	3-27		
Cellular Phone Readiness Package	2-64		
Center Passenger Position	1-27		
Central Door Unlocking System	2-5		
Certification Label	4-31		
Chains, Safety	4-35		
Chains, Tire	6-54		
Change Engine Oil Soon	6-16		
Changing a Flat Tire	5-22		
Check Engine Light	2-79		
Check Tire Pressure System	6-47		
Checking Your Restraint Systems	1-52		
Chemical Paint Spotting	6-61		
Child Restraints	1-37		
Securing in a Rear Outside Seat Position	1-43		
Securing in the Center Rear Seat Position	1-45		
Securing in the Right Front Seat Position	1-47		
Top Strap	1-42		
Where to Put	1-41		
Chrome Wheels, Cleaning	6-60		
Cigarette Lighter	2-63		
Circuit Breakers and Fuses	6-65		
Cleaner, Air	6-17		
Cleaning			
Aluminum or Chrome Wheels	6-60		
Exterior Lamps/Lenses	6-59		
Fabric	6-56		
Glass	6-58		
Inside of Your Vehicle	6-55		
Instrument Panel	6-57		
Leather	6-57		
Outside of Your Vehicle	6-59		
Speaker Covers	6-57		
Special Problems	6-56		
Stains	6-56		
Tires	6-60		
Vinyl	6-57		
Wheels	6-60		
Windshield and Wiper Blades	6-58		

Climate Control System	3-2	Daytime Running Lamps	2-45
Passenger	3-9	Dead Battery	5-3
Steering Wheel Touch Control	3-9	Defects, Reporting Safety	8-8, 8-9
Clock, Setting the	3-10	Defensive Driving	4-2
Coinholder	2-60	Defogger, Rear Window	3-8
Comfort Controls	3-2	Defogging	3-8
Personal Choice	3-2	Defrosting	3-8
Steering Wheel Touch Control	3-9	Delayed Locking	2-12, 2-93
Compact Disc Player	3-18, 3-21	DIC	2-86
Care	3-36	Dimensions, Vehicle	6-74
Errors	3-20, 3-25, 3-28	Dolby® B Noise Reduction	3-13, 3-17
Compact Spare Tire	5-31	Door	
Compass, Rearview Mirror with	2-52	Ajaz Reminder	2-5, 2-90
Content Theft-Deterrent System	2-16	Central Unlocking System	2-5
Control of a Vehicle	4-5	Locks	2-4
Convenience Net	2-62	Driver Information Center	2-86
Convex Outside Mirror	2-56	Controls and Displays	2-88
Coolant	6-23	Personal Choice Programming	2-91
Heater, Engine	2-23	Warnings and Messages	2-90
Recovery Tank	5-15, 5-16	Driver Position	1-13
Cooling System	5-14	Driving	
Cornering Lamps	2-46	City	4-20
Courtesy Lamps	2-47	Defensive	4-2
Courtesy Transportation	8-6	Drunken	4-3
Cruise Control	2-40	Freeway	4-21
Cupholders	2-60, 2-61	In a Blizzard	4-28
Customer Assistance for Text Telephone Users	8-4	In Foreign Countries	6-5
Customer Assistance Information	8-1	In the Rain	4-18
Customer Satisfaction Procedure	8-2	Night	4-16
		On Curves	4-11
		On Grades While Towing a Trailer	4-37
		On Hill and Mountain Roads	4-24
<b>D</b> amage, Finish	6-61		
Damage, Sheet Metal	6-61		

Driving (Continued)	
On Snow and Ice	4-27
Through Water	4-20
Wet Roads	4-18
Winter	4-26
With a Trailer	4-36
Drunken Driving	4-3
Dual Automatic ComforTemp Climate Control	3-2

<b>E</b> lectrical Equipment, Adding	2-23, 3-34, 6-64
Electrical System	6-64
Electrochromic Day/Night Rearview Mirror	2-51
Electronic Level Control	4-32
Engine	6-11
Accessory Belt	6-74, 6-75
Coolant	6-23
Coolant Heater	2-23
Coolant Level Check	7-31
Coolant Temperature Gage	2-79
Exhaust	2-15, 2-32, 4-29, 4-35
Identification	6-63
Oil Level Check	7-31
Oil Life Monitor (Index)	2-90
Overheating	5-12
Running While Parked	2-32
Specifications	6-73
Starting	2-22
Supercharged	6-12
Engine Oil	6-12
Adding	6-14
Additives	6-16
Change Engine Oil Soon	6-16

Checking	6-13
Pressure Light	2-82
Used	6-16
When to Change	6-16
Entry Lighting, Delayed	2-47
Exhaust, Engine	2-15, 2-32, 4-29, 4-35
Exit Lighting, Delayed	2-47
Express-Down Window	2-34
Express-Open Astrorooft	2-65

<b>F</b> abric Cleaning	6-56
Fan Control, Climate Control System	3-3
Filling a Portable Fuel Container	6-8
Filling Your Tank	6-5
Filter	
Air	6-17
Engine Oil	6-16
Passenger Compartment Air	3-7
Finish Care	6-59
Finish Damage	6-61
First Gear, Automatic Transaxle	2-27
Flashers, Hazard Warning	5-2
Flash-to-Pass Feature	2-37
Flat Tire, Changing	5-22
Fluid Capacities	6-72
Fluids and Lubricants	7-36
Foreign Countries, Fuel	6-5
French Language Manual	ii
Front Center Console	2-61
Front Storage Armrest	2-60
Front Towing	5-9



Fuel	6-3
Canada	6-4
Door Lock	6-7
Filling Your Tank	6-5
Gage	2-83
In Foreign Countries	6-5
Fuse Block	
Instrument Panel	6-65
Rear	6-69
Underhood	6-67
Fuses and Circuit Breakers	6-65

<b>G</b> ages	
Engine Coolant Temperature	2-79
Fuel	2-83
Garage Door Opener	2-57, 2-67
Garment Hooks	2-64
GAWR	4-31
Gear Positions, Automatic Transaxle	2-24
Glove Box	2-56
Lamp	2-50
Gross Axle Weight Rating	4-31
Gross Vehicle Weight Rating	4-31
Guide en Français	ii
GVWR	4-31

<b>H</b> alogen Bulbs	6-33
Hazard Warning Flashers	5-2
Head Restraints	1-7
Headlamps	2-44
Aiming	6-37
Bulb Replacement	6-34
High/Low Beam Changer	2-37
On Reminder	2-45

Head-Up Display	2-84
Hearing Impaired, Customer Assistance	8-4
Heated Backlite Antenna	3-36
Heated Outside Mirror	2-56
Heated Seats	1-5
Heating	3-5
High-Beam Headlamps	2-37
Highway Hypnosis	4-24
Hill and Mountain Roads	4-24
Hitches, Trailer	4-35
Hood	
Checking Things Under	6-9
Release	6-9
Horn	2-34
HUD	2-84
Hydraulic Brake Warning Lights	2-77
Hydroplaning	4-19

<b>I</b> f a Tire Goes Flat	5-21
Ignition Positions	2-20
Ignition Transaxle Lock Check	7-34
Illuminated Entry	2-47
Inflation, Tire Pressure	6-46
Inside Manual Day/Night Rearview Mirror	2-50
Inspections	7-35
Brake System	7-35
Engine Cooling System	7-35
Exhaust System	7-35
Front Drive Axle Boot	7-35
Front Drive Axle Seal	7-35
Steering	7-35
Suspension	7-35
Throttle Linkage	7-35



Maintenance Record .....	7-38	New Vehicle Break-In .....	2-20
Maintenance Schedule .....	7-1	Night Vision .....	4-17
Long Trip/Highway Definition .....	7-6	<b>O</b> dometer .....	2-74
Long Trip/Highway Intervals .....	7-6	Odometer, Trip .....	2-74
Owner Checks and Services .....	7-31	Off-Road Recovery .....	4-13
Periodic Maintenance Inspections .....	7-35	Oil, Engine .....	6-12
Recommended Fluids and Lubricants .....	7-36	Oil Life Monitor (Index) .....	2-90
Scheduled Maintenance Services .....	7-4	Oil Pressure Light .....	2-82
Short Trip/City Definition .....	7-5	Oil, Supercharger .....	6-19
Short Trip/City Intervals .....	7-5	OnStar System .....	2-65
Maintenance, Underbody .....	6-61	Opener, Garage Door .....	2-57, 2-67
Maintenance When Trailer Towing .....	4-38	Outside Mirrors .....	2-55
Malfunction Indicator Lamp .....	2-79	Overdrive, Automatic Transaxle .....	2-26
Maxifuse <sup>®</sup> /Relay Center .....	6-64	Overheating Engine .....	5-12
Memory Door Locks .....	2-5, 2-93	Owner Checks and Services .....	7-31
Memory Seat and Mirrors .....	1-3, 2-10	Owner Publications, Ordering .....	8-10
Memory Seats .....	1-3, 2-91		
Methanol .....	6-5	<b>P</b> aint Spotting, Chemical .....	6-61
Mirrors .....		Parade Dimming .....	2-47
Convex Outside .....	2-56	Parallel Park Assist Mirror .....	2-55, 2-92
Electrochromic Day/Night Rearview .....	2-51	Park .....	
Electrochromic Day/Night Rearview with Compass ..	2-52	Automatic Transaxle .....	2-24
Heated Outside .....	2-56	Shifting Into .....	2-28
Illuminated Visor Vanity .....	2-63	Shifting Out of .....	2-31
Inside Manual Day/Night Rearview .....	2-50	Parking .....	
Parallel Park Assist .....	2-55, 2-92	At Night .....	2-15
Power Remote Control .....	2-55	Brake .....	2-27
MMT .....	6-4	Brake Mechanism Check .....	7-34
Moisture-Sensing Delay Wipers .....	2-39	Lots .....	2-16
Mountain Roads .....	4-24	Over Things That Burn .....	2-31
Multifunction Lever .....	2-35	With a Trailer .....	4-38
<b>N</b> et, Convenience .....	2-62		
Neutral, Automatic Transaxle .....	2-25		



Passenger Climate Control	3-9
Passenger Compartment Air Filter	3-7
Passing	4-13
PASS-Key <sup>®</sup> III	2-18
Perimeter Lighting	2-48, 2-95
Periodic Maintenance Inspections	7-35
Personal Choice Features	2-10
Audio Controls	3-30
Comfort Controls	3-2
Delayed Locking	2-12, 2-93
Memory Door Locks	2-5, 2-93
Memory Seat Recall	1-3, 2-95
Parallel Park Assist Mirror	2-55, 2-92
Perimeter Lighting	2-48, 2-92
Programming, DIC	2-91
Security Feedback	2-11, 2-94
Window Lockout	2-34, 2-96
Power	
Door Locks	2-5
Remote Control Mirror	2-55
Seat	1-2
Seatback Recliner	1-5
Steering	4-10
Steering Fluid	6-27
Windows	2-33
Power, Retained Accessory	2-21
Power Seat	
Lumbar Controls	1-2
Memory Function	1-3
Pregnancy, Use of Safety Belts	1-20
Problems on the Road	5-1
Protection, Lockout	2-8
Publications, Service and Owner	8-10

<b>R</b> adiator	5-19
Radiator Pressure Cap	6-27
Radio Reception	3-34
Radios	3-10, 3-14, 3-18, 3-21
Rain, Driving In	4-18
Reading Lamps	2-49
Rear	
Door Security Locks	2-7
Outside Seat Position	1-28
Safety Belt Comfort Guides	1-32
Seat Pass Through	2-62
Seat Passengers	1-28
Storage Armrest	2-61
Towing	5-10
Window Defogger	3-8
Rear Seat Cushion, Removing	6-70
Rear Seat Pass Through	2-62
Rearview Mirror	
Electrochromic Day/Night	2-51
Electrochromic Day/Night with Compass	2-52
Inside Day/Night	2-50
Reclining Front Seatbacks	1-5
Recovery Tank, Coolant	5-15, 5-16
Refrigerants, Air Conditioning	6-73
Remote	
Fuel Door Release	6-7
Keyless Entry	2-8
Keyless Entry, Instant Alarm	2-9
Keyless Entry, Personal Choice Features	2-10
Keyless Entry, Security Feedback	2-11
Keyless Entry, Synchronization	2-10
Trunk Release	2-14

Replacement	
Bulbs	6-71
Parts	6-74
Wheel	6-53
Replacing Safety Belts	1-52
Reporting Safety Defects	8-8, 8-9
Restraints	
Checking	1-42
Child	1-37
Head	1-7
Replacing Parts After a Crash	1-52
System Check	7-32
Reverse, Automatic Transaxle	2-25
Right Front Passenger Position	1-21
Roadside Assistance	8-5
Canadian	8-5
Rocking Your Vehicle	5-33
Rotation, Tires	6-49
<b>S</b>	
Safety Belt Extender	1-52
Safety Belts	1-8
Adults	1-13
Care	6-58
Center Passenger Position	1-27
Children	1-34
Driver Position	1-13
Extender	1-52
How to Wear Properly	1-13
Incorrect Usage	1-16, 1-50, 1-51
Lap Belt	1-27
Lap-Shoulder	1-14, 1-29
Larger Children	1-49
Questions and Answers	1-12

Rear Comfort Guides	1-32
Rear Seat Outside Passenger Positions	1-28
Rear Seat Passengers	1-28
Reminder Light	1-8, 2-75
Replacing After a Crash	1-52
Right Front Passenger Position	1-21
Shoulder Belt Height Adjuster	1-15
Smaller Children and Babies	1-34
Use During Pregnancy	1-20
Why They Work	1-9
Safety Chains	4-35
Safety Defects, Reporting	8-8, 8-9
Safety Warnings and Symbols	iii
Scheduled Maintenance Services	7-4
Seatback, Power Recliner (From)	1-5
Seats	
Heated	1-5
Lumbar Control	1-2
Memory	1-3
Power	1-2
Restraint Systems	1-1
Seat Controls	1-2
Securing a Child Restraint	1-43, 1-45, 1-47
Second Gear, Automatic Transaxle	2-26
Security Feedback	2-11, 2-94
Security System	2-18
Service	6-2
Bulletins, Ordering	8-10
Manuals, Ordering	8-10
Parts Identification Label	6-63
Publications, Ordering	8-10
Work, Doing Your Own	6-2
Service and Appearance Care	6-1

Service and Owner Publications . . . . .	8-10	Storage, Vehicle . . . . .	6-33
Service Publications . . . . .	8-10	Stuck: In Sand, Mud, Ice or Snow . . . . .	5-32
Service Vehicle Soon Light . . . . .	2-83	Sun Visors . . . . .	2-63
Servicing Your Air Bag-Equipped Vehicle . . . . .	1-26	Supercharged Engine . . . . .	6-12
Sheet Metal Damage . . . . .	6-61	Supercharger Oil . . . . .	6-19
Shift Lever . . . . .	2-24	Supplemental Restraint System . . . . .	1-21
Shifting . . . . .		Symbols, Vehicle . . . . .	v
Automatic Transaxle . . . . .	2-24	<b>T</b> achometer . . . . .	2-74
Into Park (P) . . . . .	2-28	Taillamp Bulb Replacement . . . . .	6-39
Out of Park . . . . .	2-31	Tape Player Care . . . . .	3-35
Shoulder Belt Height Adjuster . . . . .	1-15	Temperature Control, Climate Control System . . . . .	3-3
Signaling Turns . . . . .	2-36	Theater Dimming . . . . .	2-47
Skidding . . . . .	4-15	Theft . . . . .	2-15
Sound Equipment, Adding . . . . .	3-34	Theft-Deterrent . . . . .	2-16
Spare Tire, Compact . . . . .	5-31	Theft-Deterrent Feature . . . . .	3-30
Speaker Covers, Cleaning . . . . .	6-57	THEFTLOCK™ . . . . .	3-30
Specifications and Capacities . . . . .	6-72	Thermostat . . . . .	6-27
Specifications, Engine . . . . .	6-73	Third Gear, Automatic Transaxle . . . . .	2-26
Speech Impaired, Customer Assistance . . . . .	8-4	Tilt Steering Wheel . . . . .	2-35
Speedometer . . . . .	2-74	Time, Setting the . . . . .	3-10
SRS . . . . .	1-21	Tire Chains . . . . .	6-54
Stains, Cleaning . . . . .	6-56	Tire Loading . . . . .	4-30
Starter Switch Check . . . . .	7-33	Tire-Loading Information Label . . . . .	4-30
Starting Your Engine . . . . .	2-22	Tires . . . . .	6-46
Steam . . . . .	5-12	Alignment and Balance . . . . .	6-52
Steering . . . . .	4-10	Buying New . . . . .	6-50
In Emergencies . . . . .	4-12	Chains . . . . .	6-54
Magnasteer™ . . . . .	4-10	Changing a Flat . . . . .	5-22
Power . . . . .	4-10	Cleaning . . . . .	6-60
Tips . . . . .	4-11	Compact Spare . . . . .	5-31
Steering Wheel . . . . .		Inflation . . . . .	6-46
Tilt . . . . .	2-35	Inflation Check . . . . .	7-31
Touch Controls . . . . .	3-9, 3-33		
Storage Areas . . . . .	2-56		



Inspection and Rotation	6-49
Loading	4-30
Pressure	6-46
Temperature	6-52
Traction	6-52
Treadwear	6-52
Uniform Quality Grading	6-51
Wear Indicators	6-50
Wheel Replacement	6-53
When It's Time for New	6-50
Top Strap	1-42
Torque Lock	2-30
Torque, Wheel Nut	5-29, 6-72
Towing a Trailer	4-32
Towing Your Vehicle	5-7
Traction	
Control System	4-9
Control System Warning Light	2-78, 4-9
Trailer	
Brakes	4-36
Driving on Grades	4-37
Driving with	4-36
Hitches	4-35
Maintenance When Towing	4-38
Parking on Hills	4-38
Safety Chains	4-35
Tongue Weight	4-34
Total Weight on Tires	4-35
Towing	4-32
Turn Signals	4-37
Weight	4-34
Transaxle Fluid	
Transaxle Fluid, Automatic	6-20

Transmitters	
Matching to Your Vehicle	2-12
Remote Keyless Entry	2-8
Transportation, Courtesy	8-6
Trip Odometer	2-74
Trunk	
Lamp	2-50
Lock Release	2-14
Rear Seat Pass Through	2-62
Release, Remote	2-14
Security Override	2-14
Trunk Mounted CD Changer	3-27
TTY Users	8-4
Turn Signal and Lane Change Indicator	2-36
Turn Signal On Chime	2-37
Turn Signal/Multifunction Lever	2-35
Turn Signals When Towing a Trailer	4-37
Twilight Sentinel	2-46

<b>U</b> nderbody Flushing Service	7-34
Underbody Maintenance	6-61
Universal Transmitter	2-66

<b>V</b> ehicle	
Control	4-5
Damage Warnings	iv
Dimensions	6-74
Identification Number	6-63
Loading	4-30
Storage	6-33
Ventilation System	3-6

Visor Vanity Mirror, Illuminated .....	2-63	Windows .....	2-33
Visors, Sun .....	2-63	Express-Down .....	2-34
Voltage Indicator .....	2-76	Power .....	2-33
<b>W</b> arning Devices .....	5-2	Windshield Washer	
Warning Lights, Gages and Indicators .....	2-75	Fluid .....	2-38, 6-28
Warranty Information .....	8-8	Fluid Level Check .....	7-31
Washer Fluid, Windshield .....	2-38, 6-28	Windshield Wipers	2-38
Washing Your Vehicle .....	6-59	Blade Check .....	7-32
Weatherstrips .....	6-59	Blade Cleaning .....	6-58
Wheel		Blade Replacement .....	6-45
Alignment .....	6-52	Moisture-Sensing Delay .....	2-39
Nut Torque .....	5-29, 6-72	Winter Driving .....	4-26
Replacement .....	6-53	Wiper Blade Check .....	7-32
Wrench .....	5-23	Wiper Blades, Cleaning .....	6-58
Window Lock .....	2-34	Wrecker Towing .....	5-7
		Wrench, Wheel .....	5-23

















## REPLACEMENT BULBS

*Application*

*Number*

### *Halogen Headlamps*

*High Beam*

9005

*Low Beam*

9006

*Back-up/Taillamps/  
Turn Signals/Park*

3057



## CAPACITIES AND SPECIFICATIONS

### Engine Specifications

#### Displacement

1.36 3.8 L V6 SPI

1.67 3.8 L V6 SC

#### Engine Torque

1.36 230 lb-ft @ 4000 rpm

1.67 280 lb-ft @ 3600 rpm

#### Type

V6

#### Firing Order

1-6-5-4-3-2

#### VIN Engine Code

1.36 K

1.67 1

#### Thermostat Starts to Open

195° F (91° C)

#### Horsepower

1.36 205

1.67 240

## CAPACITIES AND SPECIFICATIONS (CONTINUED)

### Capacities

Transaxle (4T65E)

6 qts. (5.6 L)

Crankcase (Engine Oil  
with Filter Change)

4 qts. (4.26 L)

Engine Cooling System

13 qts. (12.3 L)

Fuel Tank

18.5 gal. (70 L)

### Torque

Wheel Nut Torque

100 lb-ft (140 N·m)

### Vehicle Dimensions

Wheel Base Length

113.8 in. (289.1 cm)

Length

206.8 in. (525.3 cm)

Height

58.1 in. (147.6 cm)

Width

74.7 in. (189.7 cm)

Front Tread

62.7 in. (159.3 cm)

Rear Tread

62.3 in. (158.2 cm)

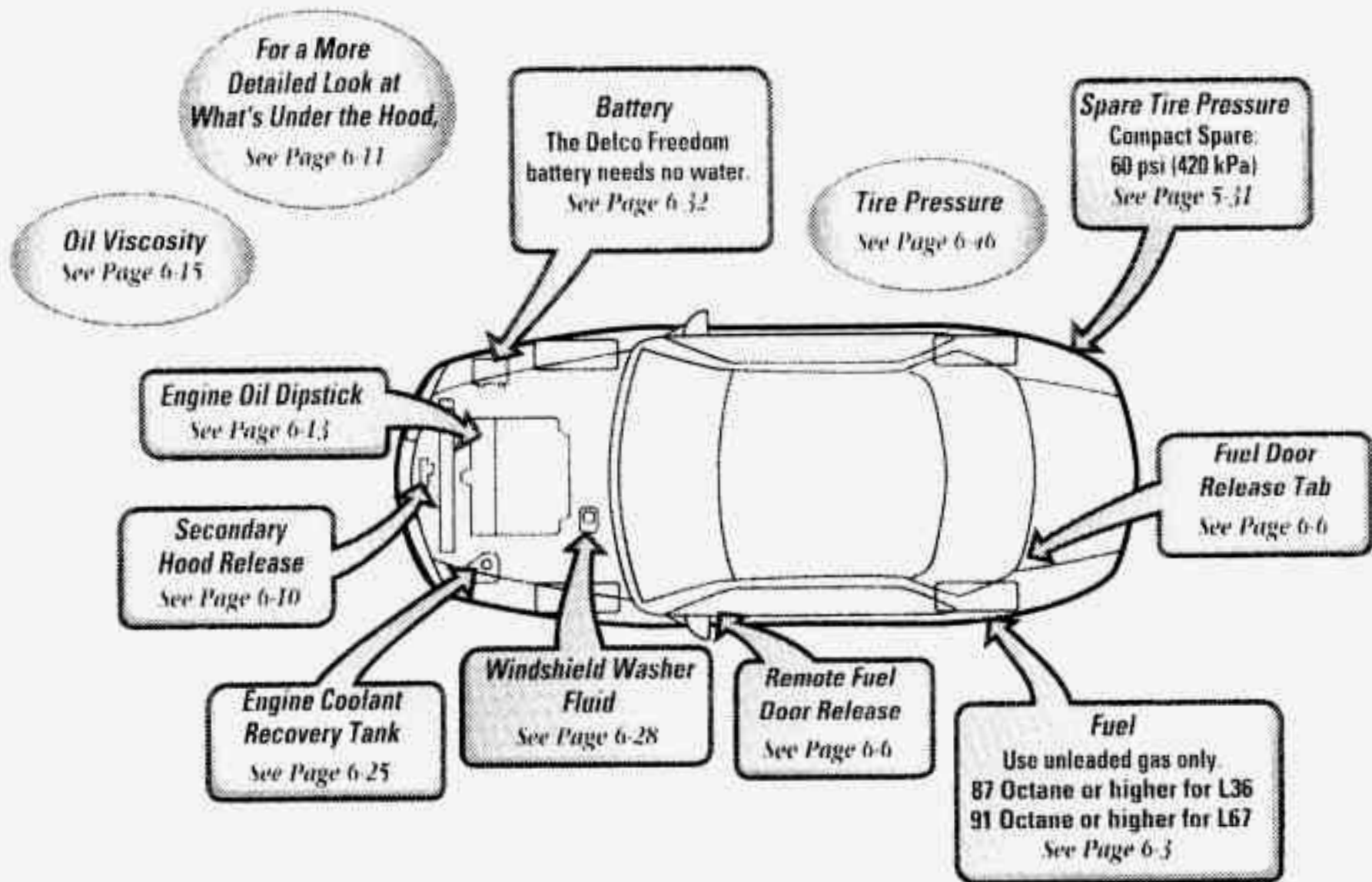







BUICK