



**BUICK**

PREMIUM AMERICAN  
MOTORCARS



**Century**





## The 1993 Buick Century Owner's Manual

Litho in U.S.A.  
Part No. 25603822 B • First Edition

©Copyright General Motors Corporation 1992  
All Rights Reserved



GENERAL MOTORS, GM and the GM Emblem, Buick, and the Buick Emblem are registered trademarks of General Motors Corporation.

This manual includes the latest information at the time it was printed. We reserve the right to make changes in the product after that time without further notice. For vehicles first sold in Canada, substitute the name "General Motors of Canada Limited" for Buick Motor Division whenever it appears in this manual.

Please keep this manual in your Buick, so it will be there if you ever need it when you're on the road. If you sell the vehicle, please leave this manual in it so the new owner can use it.



We support voluntary technician certification.

## For Canadian Owners Who Prefer a French Language Manual:

**Aux propriétaires canadiens:** Vous pouvez vous procurer un exemplaire de ce guide en français chez votre concessionnaire ou au DGN Marketing Services Ltd., 1500 Bonhill Rd., Mississauga, Ontario L5T 1C7.



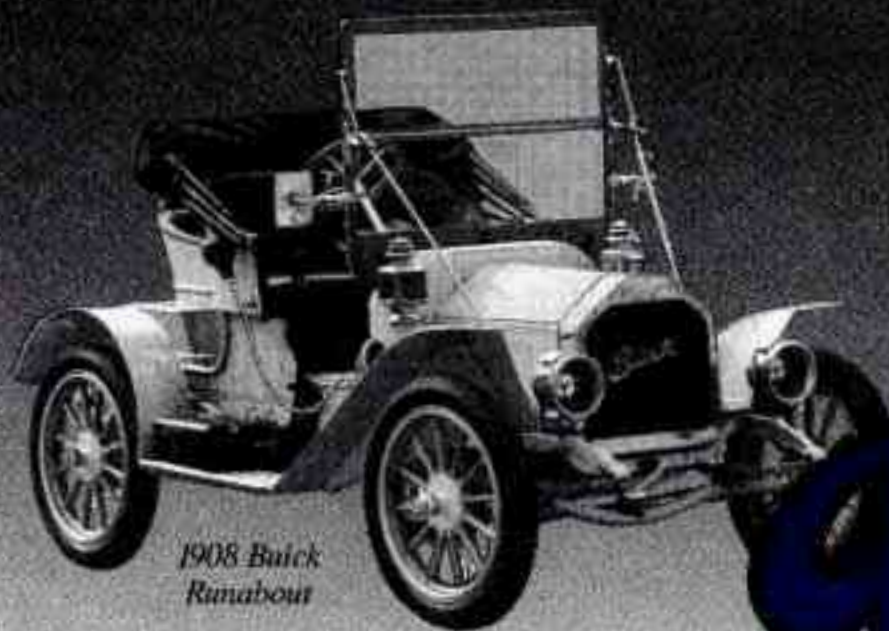

*1908 Buick  
Runabout*

*Buick Motor Division  
provides one of the most dramatic  
and important chapters in the history  
of the American automobile.*

# Buick



*David Dunbar Buick*



*Walter Marr and Thomas Buick*

Buick's chief engineer, Walter L. Marr (left), and Thomas D. Buick, son of founder David Dunbar Buick, drove the first Flint Buick in a successful Flint-Detroit round trip in July 1904.

David Buick was building gasoline engines by 1899, and Marr, his engineer, apparently built the first auto to be called a Buick in 1900. However, Buick traditionally dates its beginnings to 1903. That was the year the company was reorganized, refinanced and moved from Detroit to Flint. Buick has always been a product

innovator. Buick engineers developed the "valve-in-head" engine, a light, powerful and reliable engine which would eventually influence the entire automotive industry.

William C. Durant was instrumental in promoting Buicks across the country using his Durant-Dort Carriage Co. outlets and salespeople as the nucleus of a giant distribution system. He knew the Buick as a "self-seller." If automobiles could be this good, he thought, maybe it was time to switch from the horse and buggy business to automobiles.



*William C. (Billy) Durant*

At the 1905, New York Auto Show, Durant took orders for 1,000 Buicks before the company had built 40. On Buick's success, Durant created a holding company, September 16, 1908. He called it General Motors.



Durant also created a racing team that won 500 racing trophies in 1909 and 1910, including successes at Indianapolis two years before the Indy 500 began.

The success of Buick engines was visible not only on the race track, but in endurance tests across the country and around the world. Buick was the only car to complete a 1,000-mile Chicago-to-New York race in 1906. And a Buick was the first car to travel across South America, driven from Buenos Aires, Argentina, over the Andes to Santiago, Chile in 1914.



*1911 Model 21 Touring Car*

Buick drew plenty of attention because it could climb hills and run through mud like no other car. Buick's endurance and reliability were world famous.

During World War I, Buick built Liberty aircraft engines as well as Red Cross ambulances so successful that one Buick ambulance was awarded the Croix de Guerre by the French government.

As a builder of premier automobiles, Buick was hard hit by the Great Depression. However, new General Manager Harlow H. Curtice created popular new models including the Special and the Roadmaster. Buick sales soon flourished.



*First Buick Factory*

In World War II, Buick built aircraft engines, tanks and other military hardware. This post-war period brought great styling and engineering changes which resulted in increased sales. The torque converter automatic transmission, Dynaflow, was introduced in the 1948 Roadmaster. Buick's famous "portholes" came along in 1949.



*1949 Roadmaster*

A high-compression V-8 engine was introduced in 1953. And Buick's famous vertical pillar "toothy" grille (introduced in 1942), became more massive in the post-war era.



*1953 Skylark*

Motor Trend magazine named the 1962 Buick Special "Car of the Year." The first production V-6 engine was used in the Special.



### *1962 Buick Special*

Built inside the walls of the old buildings in Buick's former Flint complex, which formed the cornerstone of General Motors, Buick City is a state-of-the-art assembly facility with more than 200 robots and other high-tech equipment. It was completed in the fall of 1985.

Buicks are, and will continue to be, premium American motorcars with smooth power, high performance, rich detail and comfortable accommodation.



*Ed Mertz, General Manager, Buick Motor Division*

Our mission is simple:

"Buick will provide Premium American Motorcars backed with services that exceed our customers' expectations, throughout the purchase, ownership, service and repurchase experience."

Buicks are **SUBSTANTIAL.**

Buicks are **DISTINCTIVE.**

Buicks are **POWERFUL.**

Buicks are **MATURE.**



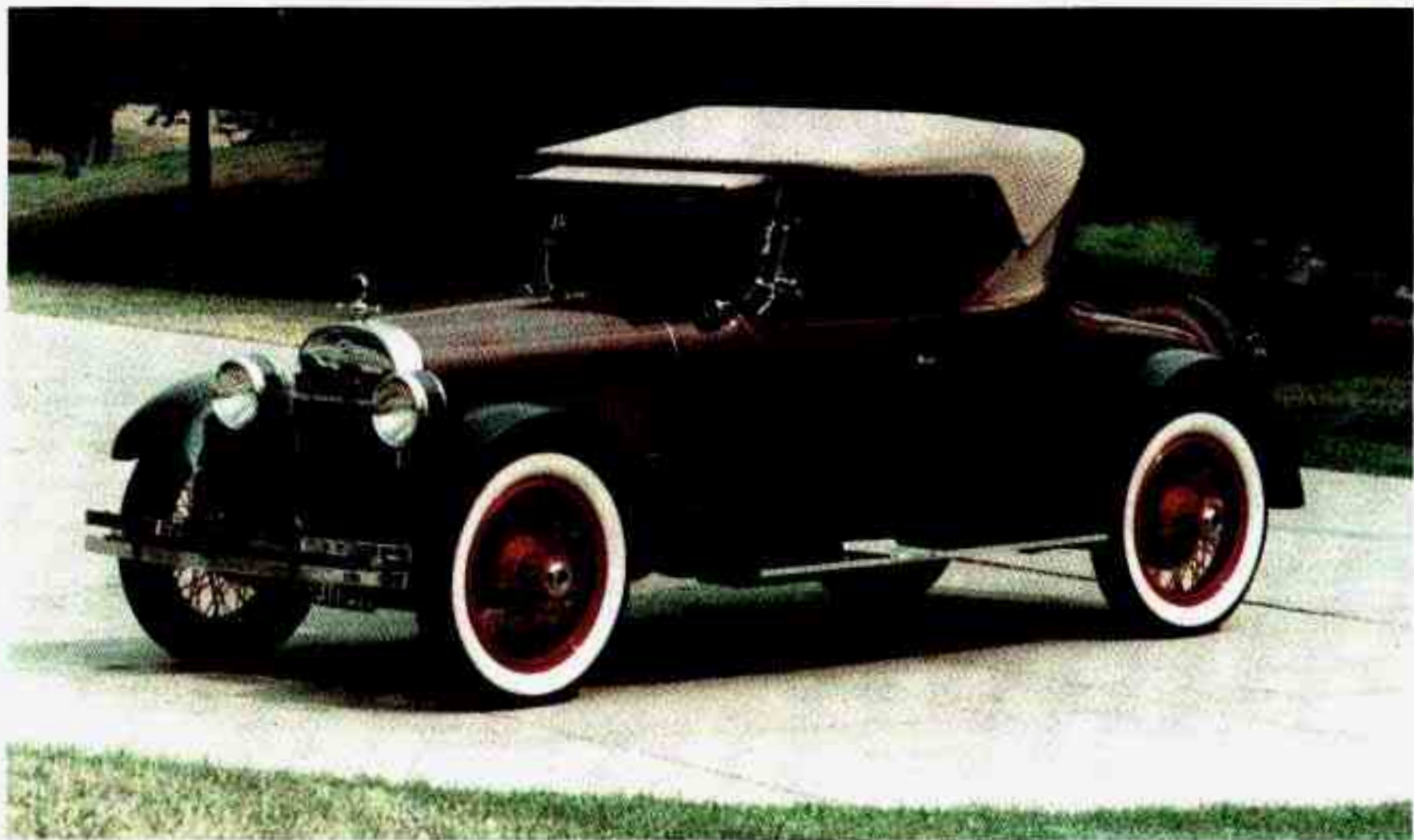

*1923 Buick Sport Roadster*





# Table of Contents

<b>Introduction How to Use this Manual</b> .....	<b>10</b>
This part tells you how to use your manual and includes safety and vehicle damage warnings and symbols.	
<b>Part 1 Seats and Safety Belts</b> .....	<b>13</b>
This part tells you how to use your seats and safety belts properly.	
<b>Part 2 Features &amp; Controls</b> .....	<b>63</b>
This part explains how to start and operate your Buick.	
<b>Part 3 Comfort Controls &amp; Audio Systems</b> .....	<b>113</b>
This part tells you how to adjust the ventilation and comfort controls and how to operate your sound system.	
<b>Part 4 Your Driving and the Road</b> .....	<b>133</b>
Here you'll find helpful information and tips about the road and how to drive under different conditions.	
<b>Part 5 Problems on the Road</b> .....	<b>183</b>
This part tells you what to do if you have a problem while driving, such as a flat tire or engine overheating.	
<b>Part 6 Service &amp; Appearance Care</b> .....	<b>221</b>
Here the manual tells you how to keep your Buick running properly and looking good.	
<b>Part 7 Maintenance Schedule</b> .....	<b>275</b>
This part tells you when to perform vehicle maintenance and what fluids and lubricants to use.	
<b>Part 8 Customer Assistance Information</b> .....	<b>299</b>
This part tells you how to contact Buick for assistance and how to get service publications. It also gives you information on "Reporting Safety Defects on page 302."	
<b>Part 9 Index</b> .....	<b>307</b>
Here's an alphabetical listing of almost every subject in this manual. You can use it to quickly find something you want to read.	

## How to Use this Manual

Many people read their owner's manual from beginning to end when they first receive their new vehicle. This will help you learn about the features and controls for your vehicle. In this manual, you'll find that pictures and words work together to explain things quickly.

**Index:** A good place to look for what you need is the Index in back of the manual. It's an alphabetical list of all that's in the manual, and the page number where you'll find it.

**Part 1-6:** Each part of this manual begins with a brief list of its contents, so you can often find at a glance if a part contains the information you want.

**Part 7:** This part of the manual covers the maintenance required for your vehicle.

**Part 8 Customer Assistance:** This part includes important information about "Reporting Safety Defects." You will also find customer satisfaction phone numbers (including customer satisfaction numbers for the hearing and speech impaired). We've also included ordering information for service publications in this part.

## Safety Warnings and Symbols

You will find a number of safety cautions in this book. We use yellow and the word **CAUTION** to tell you about things that could hurt you if you were to ignore the warning.



In the yellow caution area, we tell you what the hazard is. Then we tell you what to do to help avoid or reduce the hazard. Please read these cautions. If you don't, you or others could be hurt.

You will also find a red circle with a slash through it in this book. This safety symbol means “Don’t,” “Don’t do this,” or “Don’t let this happen.”



## Vehicle Damage Warnings

Also, in this book you will find these blue notices:

### NOTICE:

In the blue notice area, we tell you about something that can damage your vehicle. Many times, this damage would not be covered by your warranty, and it could be costly. But the notice will tell you what to do to help avoid the damage.

When you read other manuals, you might see CAUTION and NOTICE warnings in different colors or in different words. In this manual, we've used the familiar words and colors that Buick has used for years.

You'll also see warning labels on your vehicle. They use the same colors, and the words CAUTION or NOTICE.



## Vehicle Symbols

These are some of the symbols you will find on your vehicle.

For example, these symbols are used on an original battery:

CAUTION  
POSSIBLE  
INJURY



PROTECT  
EYES BY  
SHIELDING



CAUSTIC  
BATTERY  
ACID COULD  
CAUSE  
BURNS



AVOID  
SPARKS OR  
FLAMES



SPARK OR  
FLAME  
COULD  
EXPLODE  
BATTERY



These symbols are important for you and your passengers whenever your vehicle is driven:

DOOR LOCK  
UNLOCK



FASTEN  
SEAT  
BELTS



POWER  
WINDOW



These symbols have to do with your lights:

MASTER  
LIGHTING  
SWITCH



TURN  
SIGNALS

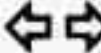

PARKING  
LIGHTS



HAZARD  
WARNING  
FLASHER



LIGHTS OR  
HIGH BEAM



FOG LAMPS



These symbols are on some of your controls:

WINDSHIELD  
WIPER &  
WASHER



WINDSHIELD  
WASHER



WINDSHIELD  
DEFROSTER



REAR  
WINDOW  
DEFOGGER



VENTILATING  
FAN



HEADLAMP  
WASHER  
WIPER



These symbols are used on warning and indicator lights:

ENGINE  
COOLANT  
TEMP



BATTERY  
CHARGING  
SYSTEM



BRAKE



RADIATOR  
COOLANT



FUEL



ENGINE OIL  
PRESSURE



ENGINE OIL  
TEMP

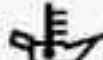

ANTILOCK  
BRAKE



Here are some other symbols you may see:

FUSE



RADIO  
SELECTOR



RADIO  
VOLUME



AIR  
CONDITIONING

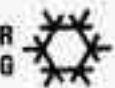

TRUNK  
HATCHBACK  
RELEASE



LIGHTER



HORN



SPEAKER





## Part 1 Seats and Safety Belts

Here you'll find information about the seats in your Buick, your Supplemental Inflatable Restraint ("air bag") system and how to use your safety belts properly. You can also learn about some things you should **not** do with safety belts.

### Part 1 includes:

Seats and Seat Controls .....	14
Folding Rear Seats (Wagon) .....	18
Safety Belts .....	23
How to Wear Safety Belts Properly .....	29
Driver Position .....	30
Supplemental Inflatable Restraint System (Air Bag) .....	35
Safety Belt Use During Pregnancy .....	40
Right Front Passenger Position .....	40
Center Passenger Position and Any Station Wagon Third Seat Passenger Position .....	41
Rear Seat Passengers .....	43
Children .....	45
Smaller Children and Babies .....	46
Child Restraints .....	47
Larger Children .....	58
Safety Belt Extender .....	60
Replacing Safety Belts After a Crash .....	61

## Seats and Seat Controls

This section tells you about the seats—how to adjust them—and also about folding seats, reclining front seatbacks, and head restraints.

### Manual Front Seat

#### CAUTION:

**You can lose control of the vehicle if you try to adjust a manual driver's seat while the vehicle is moving. The sudden movement could startle and confuse you, or make you push a pedal when you don't want to. Adjust the driver's seat only when the vehicle is not moving.**



Move the lever under the front seat to unlock it. Slide the seat to where you want it. Then release the lever and try to move the seat with your body, to make sure the seat is locked into place.



## Power Seat (Option)



The power seat controls are located on the front of the seat.

To adjust the power seat:

**Front Control (F):** Raise the front of the seat by holding the switch up. Hold the switch down to lower the front of the seat.

**Center Control (C):** Move the seat forward or back by holding the control to the right or left. Raise or lower the seat by holding the control up or down.

**Rear Control (R):** Raise the rear of the seat by holding the switch up. Hold the switch down to lower the rear of the seat.

## Reclining Front Seatback



Front seats have this control. It's located on the front of the seat.

**Reclining Front Seatback Control:** To recline the seatback hold the switch up. Hold the switch down to raise the seatback.

But don't have a seatback reclined if your vehicle is moving.

**⚠ CAUTION:**

Sitting in a reclined position when your vehicle is in motion can be dangerous. Even if you buckle up, your safety belts can't do their job when you're reclined like this.



**CAUTION (Continued)**

**CAUTION (Continued)**

The shoulder belt can't do its job because it won't be against your body. Instead, it will be in front of you. In a crash you could go into it, receiving neck or other injuries.

The lap belt can't do its job either. In a crash the belt could go up over your abdomen. The belt forces would be there, not at your pelvic bones. This could cause serious internal injuries.

For proper protection when the vehicle is in motion, have the seatback upright. Then sit well back in the seat and wear your safety belt properly.

## Head Restraints



Slide the head restraint up or down so that the top of the restraint is closest to the top of your ears.

This position reduces the chance of a neck injury in a crash.

## Front Seatback Latches (Two-Door Models)

The front seatback folds forward to let people get into the back seat.

Your seatback will move back and forth freely, unless you come to a sudden stop. Then it will lock in place.

There's one time the seatback may not fold without some help from you. That's if your vehicle is parked facing down a fairly steep hill.



To fold a front seatback forward, push the seatback toward the rear as you lift this latch. Then the seatback will fold forward. The latch must be down for the seat to work properly.



## **Folding Rear Seats (Wagon)**

To add more cargo room, the seatbacks of your rear second and optional rear-facing third seats can be easily folded down. Be sure to check your seatback latches now and then by pushing the seatback back and forth. If they do not latch properly, have them checked by your dealer.

Remember to keep safety belts clear of seat hinges and latches so they are not damaged when you raise and lower the seatbacks.

## **Folding Second Seat**



### **To Lower the Split Second Seatback:**

- 1.** Each seat has its own release button. Press the release button and pull the seatback forward and down.

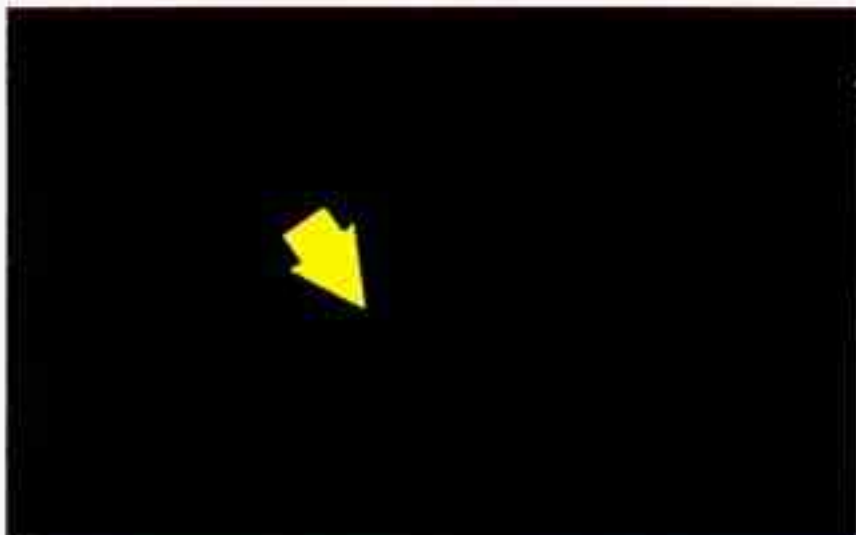

2. Push down on the filler panel and the seatback so they lock into a level position.



**To Raise the Split Second Seatback:**

1. Push down on the front edge of the seatback and pull up the filler panel tab.
2. Lift the seatback until it locks in the upright position. Push back and forth on the seatback to be sure it is locked in place.

## Folding Third Seat (Option)



### To Raise the Rear-Facing Third Seatback:

If your vehicle is equipped with a roll-up cargo cover, it must be removed before raising the seatback.

1. Open the liftgate and lift the storage compartment lid.
2. Fold it forward against the seatback.



3. Press down on the seat release levers (one on each side of the seat), and allow the seatback to pop up.





4. Push the seatback all the way up until it locks in the upright position. Push back and forth on the seatback to be sure it is locked in place.



**To Lower the Rear-Facing Third Seatback:**

1. Open the liftgate and lift the seat release lever located at the lower corner of the storage compartment on the passenger side.



**2. Pull the seatback toward the rear of the vehicle, then push it down into the locked position.**



**3. Lower the storage compartment lid.**

## Safety Belts: They're For Everyone

This part of the manual tells you how to use safety belts properly. It also tells you some things you should not do with safety belts. And it explains the Supplemental Inflatable Restraint, or "air bag" system.



### CAUTION:

Don't let anyone ride where they can't wear a safety belt properly. If you are in a crash and you're not wearing a safety belt, your injuries can be much worse. You can hit things inside the vehicle or be ejected from it. You can be seriously injured or killed. In the same crash, you might not be if you are buckled up. Always fasten your safety belt, and check that your passengers' belts are fastened properly too.



This figure lights up when you turn the key to "Run" or "Start" when your safety belt isn't buckled, and you'll hear a chime, too. It's the reminder to buckle up. In many states and Canadian provinces, the law says to wear safety belts. Here's why: **They work.**



You never know if you'll be in a crash. If you do have a crash, you don't know if it will be a bad one.



A few crashes are very mild. In them, you won't get hurt even if you're not buckled up. And some crashes can be so serious, like being hit by a train, that even buckled up a person wouldn't survive. But most crashes are in between. In many of them, people who buckle up can survive and sometimes walk away. Without belts they could be badly hurt or killed.

After 25 years of safety belts in vehicles, the facts are clear. In most crashes, buckling up does matter... a lot!

## Why Safety Belts Work



When you ride in or on anything, you go as fast as it goes.

For example, if the bike is going 10 mph (16 km/h), so is the child.

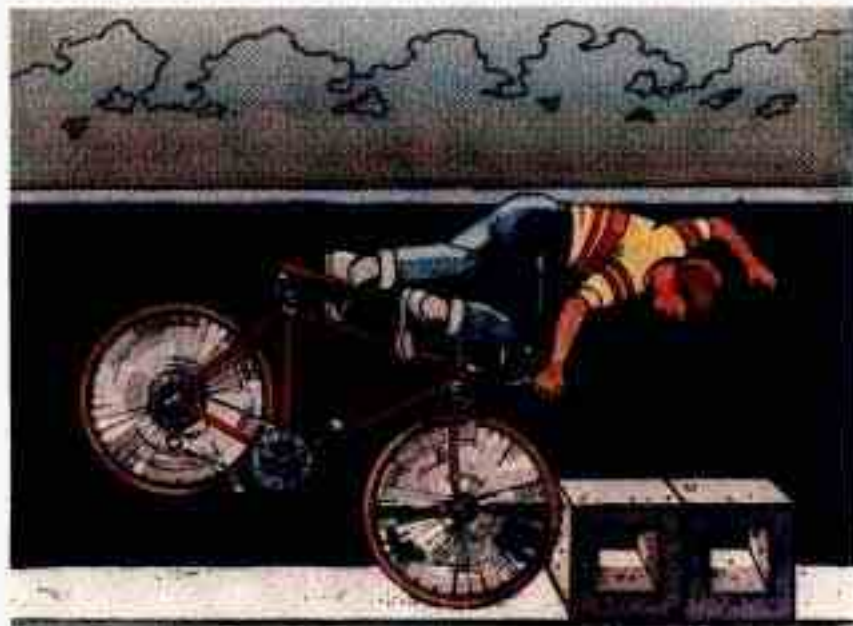

When the bike hits the block, it stops. But the child keeps going!

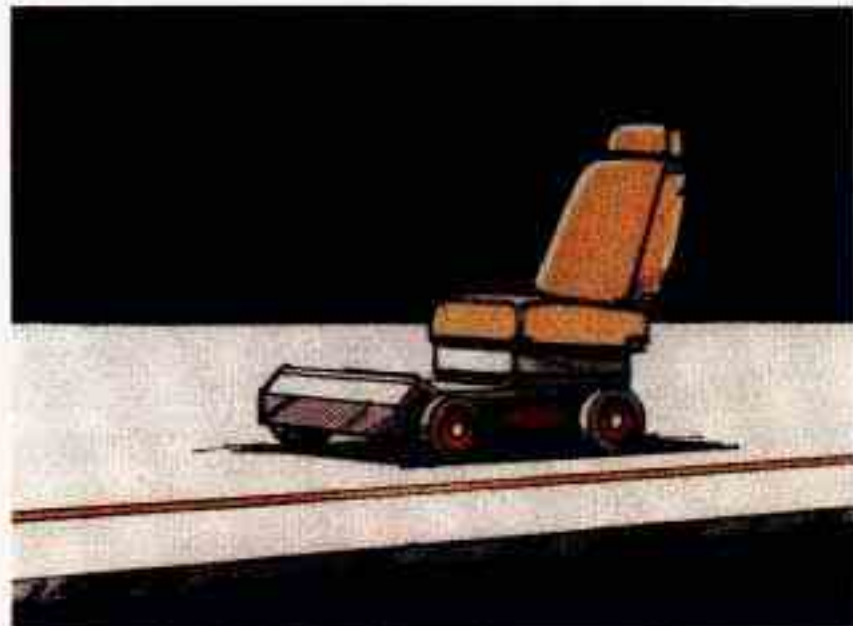

Take the simplest "car." Suppose it's just a seat on wheels.



Put someone on it.



Get it up to speed. Then stop the "car." The rider doesn't stop.





The person keeps going until stopped by something. In a real vehicle, it could be the windshield...



or the instrument panel...



or the safety belts!

With safety belts, you slow down as the vehicle does. You get more time to stop. You stop over more distance, and your strongest bones take the forces. That's why safety belts make such good sense.

## Here Are Questions Many People Ask About Safety Belts—and the Answers

- Q:** Won't I be trapped in the vehicle after an accident if I'm wearing a safety belt?
- A:** You **could** be—whether you're wearing a safety belt or not. But you can easily unbuckle a safety belt, even if you're upside down. And your chance of being conscious during and after an accident, so you **can** unbuckle and get out, is **much** greater if you are belted.
- Q:** Why don't they just put in air bags so people won't have to wear safety belts?
- A:** "Air bags," or Supplemental Inflatable Restraint systems, are in some vehicles today and will be in more of them in the future. But they are supplemental systems only—so they work **with** safety belts, not instead of them. Every "air bag" system ever offered for sale has required the use of safety belts. Even if you're in a vehicle that has "air bags," you still have to buckle up to get the most protection. That's true not only in frontal collisions, but especially in side and other collisions.



**Q:** If I'm a good driver, and I never drive far from home, why should I wear safety belts?

**A:** You may be an excellent driver, but if you're in an accident—even one that isn't your fault—you and your passengers can be hurt. Being a good driver doesn't protect you from things beyond your control, such as bad drivers.

Most accidents occur within 25 miles (40 km) of home. And the greatest number of serious injuries and deaths occur at speeds of less than 40 mph (65 km/h).

Safety belts are for everyone.

### Safety Belt Warning Light



When the key is turned to "Run" or "Start," a chime will come on for about eight seconds to remind people to fasten their safety belts, unless the driver's safety belt is buckled. The safety belt light will also come on and stay on for about 60 seconds or until the driver's belt is buckled.



### CAUTION:

If your safety belt light ever comes on or stays on after the front doors are closed and the driver's belt is buckled, have your vehicle fixed. If you don't, you might not have the protection you'd need in a crash.

## How to Wear Safety Belts Properly

### Adults

This section is only for people of adult size.



### CAUTION:

There are special things to know about safety belts and children. And there are different rules for babies and smaller children. If a child will be riding in your Buick, see the section after this one, called "Children." Follow those rules for everyone's protection.

First, you'll want to know which restraint systems your vehicle has.

We'll start with the driver position.



## Cars First Sold in Canada

Was your Buick first sold, when new, in Canada? (If it was, a sticker on the driver's door will say "conforms to all applicable Canada motor vehicle . . ." etc.) If so, then the rest of Part 1 does not apply to your vehicle.

To learn how to use your safety belts, please read the **Owner's Manual Safety Belt Supplement**. It comes with every new Buick first sold in Canada.

## Driver Position

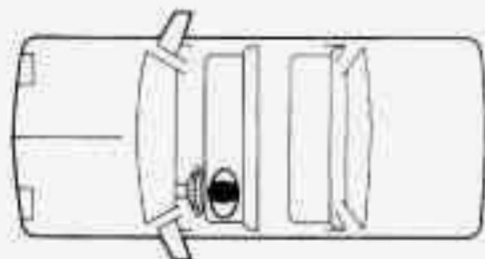

This section describes the driver's restraint system.

## Automatic Lap-Shoulder Belt



This safety belt is called "automatic" because you don't have to buckle up when you get into your vehicle.



And you don't have to unbuckle when you get out.

Just get into your vehicle. Then close and lock the door. Adjust the seat (to see how, see "Seats" in the Index) so you can sit up straight.

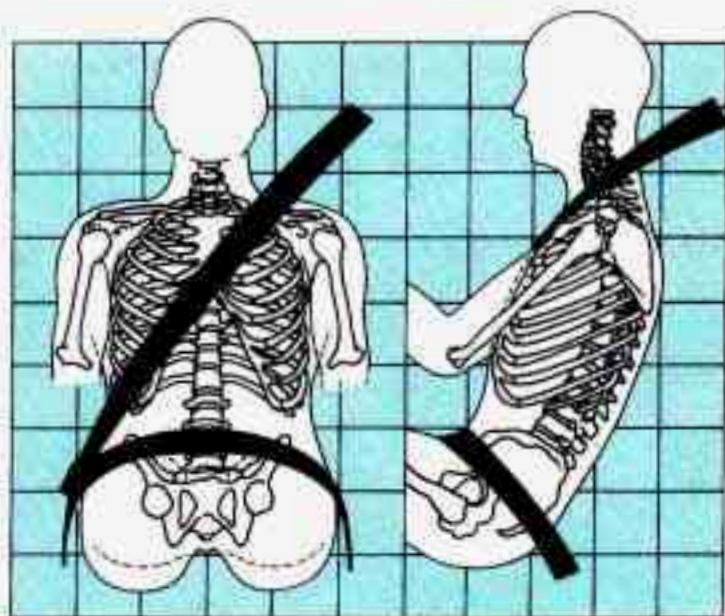

The lap belt should be worn as low on the hips as possible. In a crash, this applies force to the strong pelvic bones. And you'd be less likely to slide under the lap belt. If you slid under it, the belt would apply force at your abdomen. This could cause serious or even fatal injuries. The shoulder belt should go over the shoulder and across the chest. These parts of the body are best able to take belt restraining forces.

The safety belt locks if there's a sudden stop or a crash.

It's possible that an automatic belt could keep you from fully opening a door. That can happen if the door was slammed shut very hard. Just close the door all the way, then slowly open it. If that doesn't fix it, then your Buick needs service.

We hope you'll always keep your automatic belt buckled. However, you may need to unbuckle it in an emergency. And you would need to unbuckle it to let someone get into the center front seat position, if your vehicle has one.



To unbuckle the automatic belt, just push the button on the buckle.





To reattach the automatic belt:

1. Close and lock the door.
2. Adjust the seat (to see how, see "Seats" in the Index) so you can sit up straight.
3. Pick up the latch plate and pull the belt across you. Don't let it get twisted.
4. Push the latch plate into the buckle until it clicks.

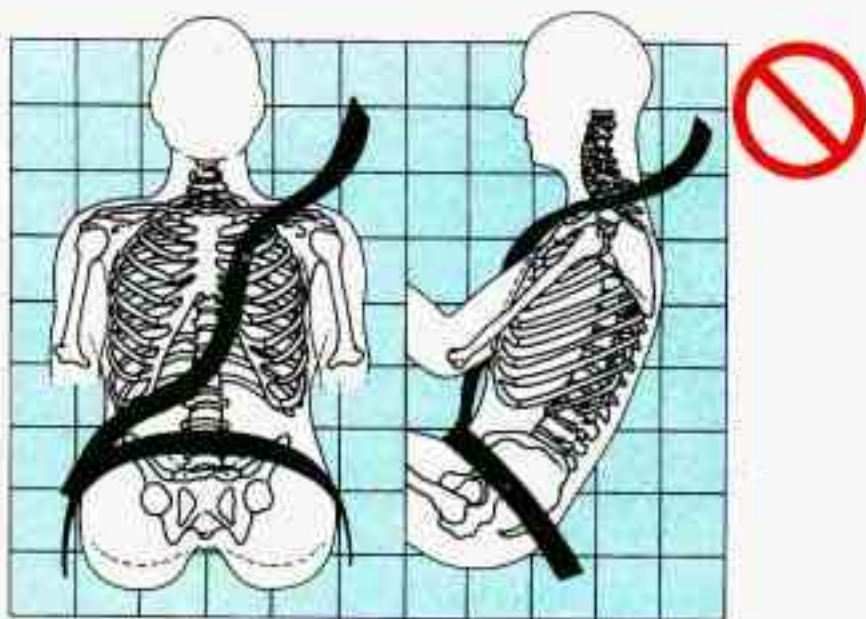

**Q:** What's wrong with this?

**A:** The shoulder belt is too loose. It won't give nearly as much protection this way.



### **CAUTION:**

**You can be seriously hurt if your shoulder belt is too loose. In a crash you would move forward too much, which could significantly increase injury. The shoulder belt should fit against your body.**

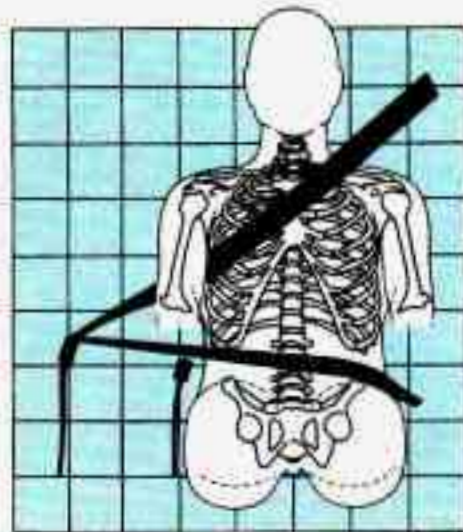

**Q:** What's wrong with this?

**A:** The belt is buckled in the wrong place.

 **CAUTION:**

You can be seriously injured if your belt is buckled in the wrong place like this. In a crash, the belt would go up over your abdomen. The belt forces would be there, not at the pelvic bones. This could cause serious internal injuries. Always buckle your belt into the buckle nearest you.

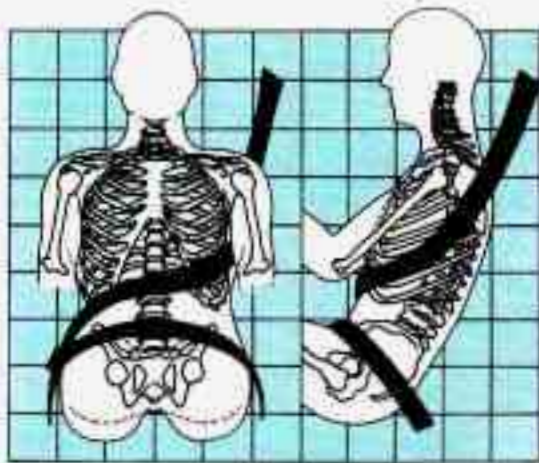

**Q:** What's wrong with this?

**A:** The shoulder belt is worn under the arm. It should be worn over the shoulder at all times.

 **CAUTION:**

You can be seriously injured if you wear the shoulder belt under your arm. In a crash, your body would move too far forward, which would increase the chance of head and neck injury. Also, the belt would apply too much force to the ribs, which aren't as strong as shoulder bones. You could also severely injure internal organs like your liver or spleen.



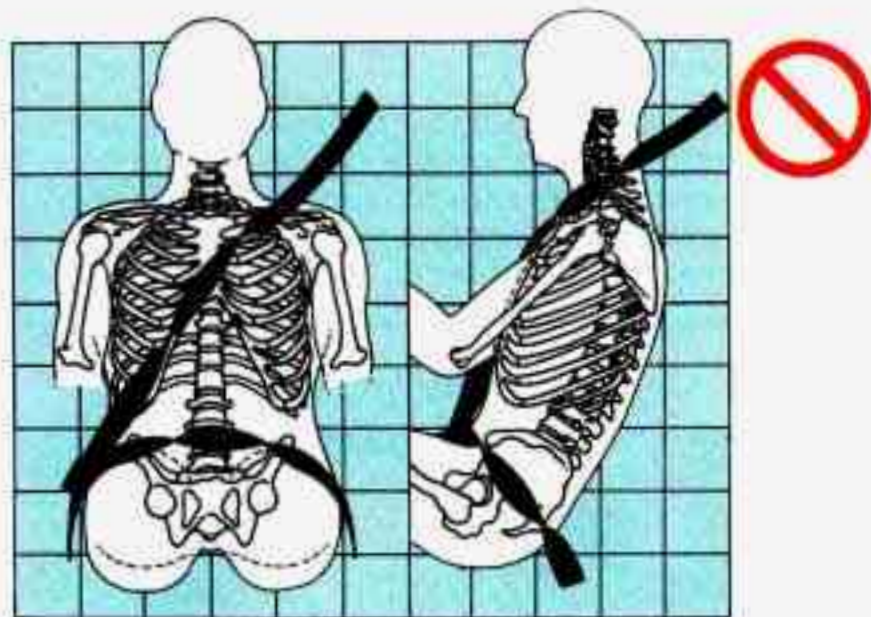

**Q:** What's wrong with this?

**A:** The belt is twisted across the body.

## Supplemental Inflatable Restraint System (Air Bag) (Option)

This section explains the driver's Supplemental Inflatable Restraint (SIR) system, commonly referred to as an air bag. Here are the most important things to know:

### CAUTION:

Even with an air bag, if you're not wearing a safety belt and you're in a crash, your injuries may be much worse. Air bags are not designed to inflate in rollovers or in rear, side or low-speed frontal crashes. You need to wear your safety belt to reduce the chance of hitting things inside the vehicle or being ejected from it. Always wear your safety belt, even with an air bag.

### CAUTION:

You can be seriously injured by a twisted belt. In a crash, you wouldn't have the full width of the belt to take impact forces. If a belt is twisted, make it straight so it can work properly, or ask your dealer to fix it.



## CAUTION:

Air bags inflate with great force, faster than the blink of an eye. If you're too close to an inflating air bag, it could seriously injure you. Safety belts help keep you in position for an air bag inflation in a crash. Always wear your safety belt, even with an air bag, and sit as far back as you can while still maintaining control of your vehicle.

## CAUTION:

If the air bag readiness light doesn't come on when you start your vehicle, or stays on, or comes on when you are driving, your air bag system may not work properly. Have your vehicle serviced right away.

### Air Bag System Light



There is an air bag readiness light on the instrument panel, which shows "AIRBAG." The system checks itself and the light tells you if there is a problem.

You will see this light flash for a few seconds when you turn your ignition to "Run" or "Start." Then the light should go out, which means the system is ready.

### How the Air Bag System Works



**Q:** Where is the air bag?

**A:** The driver's air bag is in the middle of the steering wheel.

**Q:** When is an air bag expected to inflate?

**A:** The air bag is designed to inflate in moderate to severe frontal or near-frontal crashes. The air bag will only inflate if the velocity of the impact is above the designed threshold level. When impacting straight into a wall that does not move or deform, the threshold level for most GM vehicles is between 9 and 14 mph (14 and 23 km/h). However, this velocity threshold depends on the vehicle design and may be several miles-per-hour faster or slower. In addition, this threshold velocity will be considerably higher if the vehicle strikes an object such as a parked car which will move and deform on impact. The air bag is also not designed to inflate in rollovers, side impacts, or rear impacts where the inflation would provide no occupant protection benefit.

In any particular crash, the determination of whether the air bag should have inflated cannot be based solely on the level of damage on the vehicle(s). Inflation is determined by the angle of the impact and the vehicle's deceleration, of which vehicle damage is only one indication. Repair cost is not a good indicator of whether an air bag should have deployed.

**Q:** What makes an air bag inflate?

**A:** In a frontal impact of sufficient severity, sensors strategically located on the vehicle detect that the vehicle is suddenly stopping as a result of a crash. These sensors complete an electrical circuit, triggering a chemical reaction of the sodium azide sealed in the inflator. The reaction produces nitrogen gas, which inflates the cloth bag. The inflator, cloth bag, and related hardware are all part of the air bag inflator module packed inside the steering wheel.



**Q:** How does an air bag restrain?

**A:** In moderate to severe frontal or near-frontal collisions, even belted occupants can contact the steering wheel. The air bag supplements the protection provided by safety belts. Air bags distribute the force of the impact more evenly over the occupant's upper body, stopping the occupant more gradually. But air bags would not provide protection in many types of collisions, including rollovers and rear and side impacts, primarily because an occupant's motion is not toward the air bag. Air bags should never be regarded as anything more than a supplement to safety belt protection in moderate to severe frontal and near-frontal collisions.

**Q:** What will you see after an air bag inflation?

**A:** After the air bag has inflated, it will then quickly deflate. This occurs so quickly that some people may not even realize that the air bag inflated. The air bag will **not** impede the driver's vision or ability to steer the vehicle, nor will it hinder the occupants from exiting the vehicle. There will be small amounts of smoke coming from vents in the deflated air bag. Some components of the air bag module in the steering wheel hub may be hot for a short time, but the portion of the bag that comes into contact with you will not be hot to the touch. The nitrogen gas used to inflate the air bag will have vented into the passenger compartment, and the bag will be deflated within seconds after the collision. Nitrogen makes up about 80% of the air we breathe and is not hazardous. As the nitrogen vents from the bag, small particles are also vented into the passenger compartment.



 **CAUTION:**

Don't attach anything to the steering wheel pad. It might injure the driver if the air bag inflates.

The air bag is designed to inflate only once. After it inflates, you'll need some new parts for your air bag system. If you don't get them, the air bag system won't be there to help protect you in another crash. A new system will include the air bag module and possibly other parts. The service manual has information about the need to replace other parts.

Let only qualified technicians work on your air bag system. Improper service can mean that your air bag system won't work properly. See your dealer for service.

## Service Your Buick with the Air Bag System

Please tell or remind anyone who works on your Buick that it has the air bag system. There are parts of the air bag system in several places around your vehicle. You don't want the system to inflate while someone is working on your vehicle. The air bag system does not

need regular maintenance. Your Buick dealer and the 1993 Century Service Manual have information about the air bag system, including repair or disposal.

 **CAUTION:**

For up to 2 minutes after the ignition key is turned off and the battery disconnected, an air bag can still inflate during improper service. You can be injured if you are close to an air bag when it inflates. Be sure to follow the proper service procedures.

When electrical work is done under the hood or inside your vehicle, the ignition should be in "Lock" if possible.

Avoid wires wrapped with yellow tape, or yellow connectors. They are probably part of the air bag system.

But if the ignition has to be on for electrical work, or if the steering column is to be disassembled, the air bag system must be disconnected. To do this:

- Turn off the ignition.
- Remove the SIR (air bag) fuse (see "Fuses & Circuit Breakers" in the Index).
- Disconnect the yellow connector at the base of the steering column.

When the work is complete, if the air bag system was disconnected, be sure to reattach everything and replace the fuse before turning the ignition on. When you turn the ignition key on, be sure you see the inflatable restraint light on the instrument panel. If you don't see this light flash and then go out as usual, have your air bag system repaired.

### **Safety Belt Use During Pregnancy**

Safety belts work for everyone, including pregnant women. Like all occupants, they are more likely to be seriously injured if they don't wear safety belts.



A pregnant woman should wear a lap-shoulder belt, and the lap portion should be worn as low as possible throughout the pregnancy.

The best way to protect the fetus is to protect the mother. When a safety belt is worn properly, it's more likely that the fetus won't be hurt in a crash. For pregnant women, as for anyone, the key to making safety belts effective is wearing them properly.

### **Right Front Passenger Position**

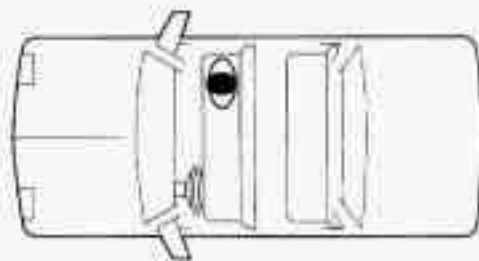

The right front passenger's safety belt works the same way as the driver's safety belt. See "Driver Position," earlier in this part.





Adjust the seat (to see how, see "Seats" in the Index) so you can sit up straight. Move your seat far enough forward that your feet touch the part of the vehicle that is called the "toeboard" (A). That way you'd be less likely to slide under the lap belt in a crash.

## Center Passenger Position and Any Station Wagon Third Seat Passenger Position

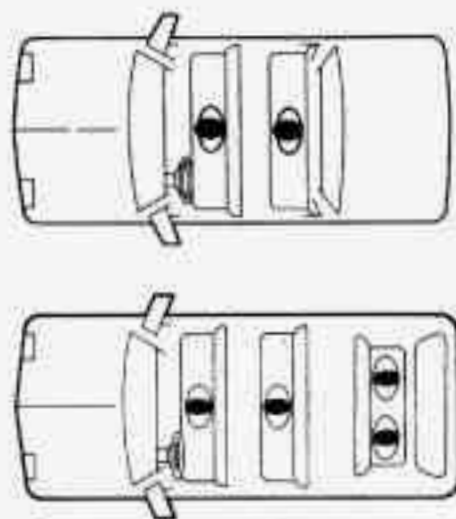

If your vehicle has front and rear bench seats, someone can sit in the center positions.





When you sit in a center seating position, or in a station wagon third seat, you have a lap safety belt, which has no retractor.

To make the belt longer, tilt the latch plate and pull it along the belt.



To make the belt shorter, pull its free end as shown until the belt is snug.

Buckle, position and release it the same way as the lap part of a lap-shoulder belt.

If the belt isn't long enough, see "Safety Belt Extender" at the end of this section.

Make sure the release button on the buckle faces upward or outward so you would be able to unbuckle it quickly if you ever had to.

## Rear Seat Passengers

It's very important for rear seat passengers to buckle up! Accident statistics show that unbelted people in the rear seat are hurt more often in crashes than those who are wearing safety belts.

Rear passengers who aren't safety belted can be thrown out of the vehicle in a crash. And they can strike others in the vehicle who are wearing safety belts.

## Rear Seat Outside Passenger Positions

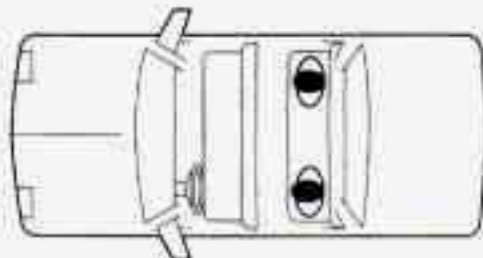

The positions next to the windows have lap-shoulder belts.

Here's how to wear one properly:

1. Pick up the latch plate and pull it across you. Don't let it get twisted.



2. Push the latch plate into the buckle until it clicks. If the belt stops before it reaches the buckle, tilt the latch plate and keep pulling until you can buckle it.

If the belt is not long enough, see "Safety Belt Extender" at the end of this section.

Make sure the release button on the buckle faces upward or outward so you would be able to unbuckle it quickly if you ever had to.





3. To make the lap part tight, pull down on the buckle end of the belt as you pull up on the shoulder part.

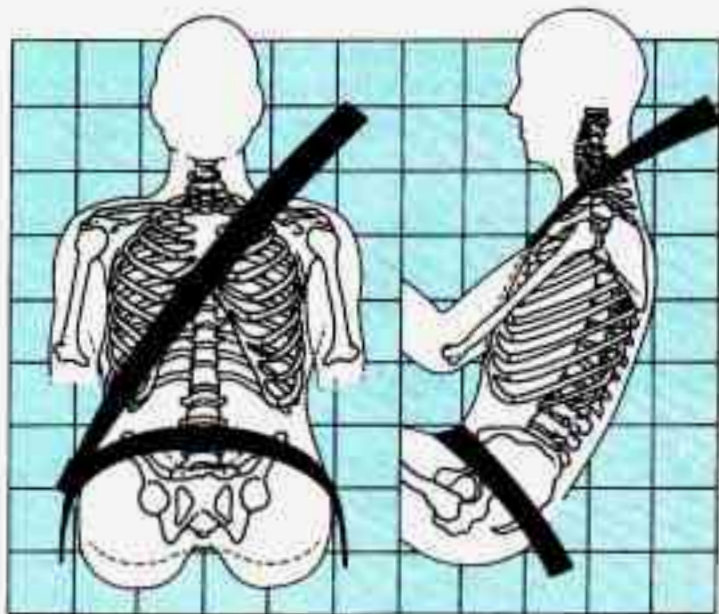

The lap part of the belt should be worn low and snug on the hips, just touching the thighs. In a crash, this applies force to the strong pelvic bones. And you'd be less likely to slide under the lap belt. If you slid under it, the belt would apply force at your abdomen. This could cause serious or even fatal injuries. The shoulder belt should go over the shoulder and across the chest. These parts of the body are best able to take belt restraining forces.

The safety belt locks if there's a sudden stop or a crash.



**⚠ CAUTION:**

You can be seriously hurt if your shoulder belt is too loose. In a crash you would move forward too much, which could increase injury. The shoulder belt should fit against your body.



To unlatch the belt, just push the button on the buckle.

## Children



Everyone in a vehicle needs protection! That includes infants and all children smaller than adult size. In fact, the law in every state and Canadian province says children up to some age must be restrained while in a vehicle.

## Smaller Children and Babies

### CAUTION:

Smaller children and babies should always be restrained in a child or infant restraint. The instructions for the restraint will say whether it is the right type and size for your child. A very young child's hip bones are so small that a regular belt might not stay low on the hips, as it should. Instead, the belt will likely be over the child's abdomen. In a crash the belt would apply force right on the child's abdomen, which could cause serious or fatal injuries. So, be sure that any child small enough for one is always properly restrained in a child or infant restraint.

### CAUTION:

Never hold a baby in your arms while riding in a vehicle. A baby doesn't weigh much—until a crash. During a crash a baby will become so heavy you can't hold it. For example, in a crash at only 25 mph (40 km/h), a 12-pound (5.5 kg) baby will suddenly become a 240-pound (110 kg) force on your arms. The baby would be almost impossible to hold.



CAUTION (Continued)



**CAUTION (Continued)**

**Secure the baby in an infant restraint.**



## **Child Restraints**

Be sure to follow the instructions for the restraint. You may find these instructions on the restraint itself or in a booklet, or both. These restraints use the belt system in your vehicle, but the child also has to be secured within the restraint to help reduce the chance of personal injury. The instructions that come with the infant or child restraint will show you how to do that.

## **Where to Put the Restraint**

Accident statistics show that children are safer if they are restrained in the rear rather than the front seat. We at General Motors therefore recommend that you put your child restraint in the rear seat unless the child is an infant and you're the only adult in the vehicle. In that case, you might want to secure the restraint in the front seat where you can keep an eye on the baby.

Wherever you install it, be sure to secure the child restraint properly.

 **CAUTION:**

**An unsecured child restraint can move around in a collision or sudden stop and injure people in the vehicle. Be sure to properly secure any child restraint in your vehicle—even when no child is in it.**



## Top Strap

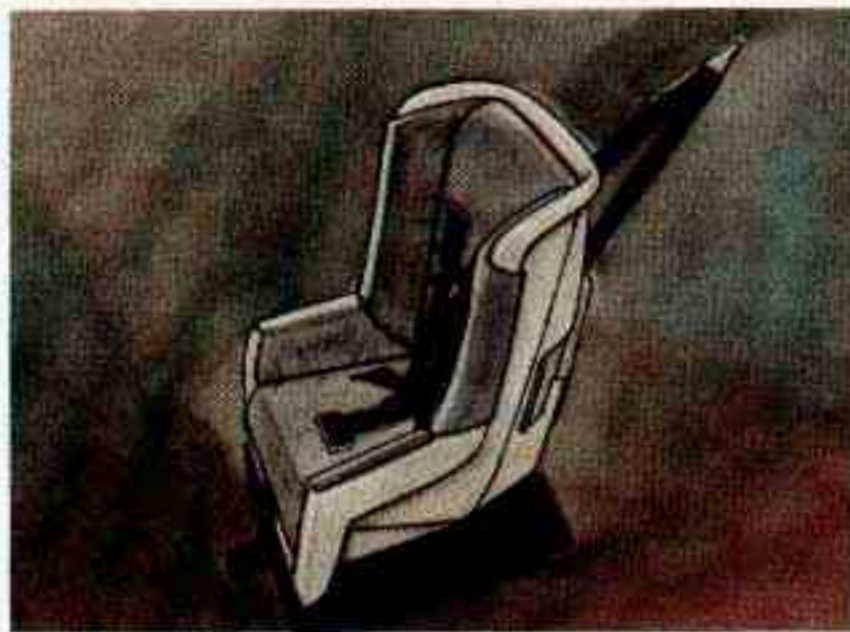

If your child restraint has a top strap, it should be anchored. If you need to have an anchor installed, you can ask your Buick dealer to put it in for you. If you want to install an anchor yourself, your dealer can tell you how to do it.

If you want to use a child restraint with a top strap in the second seat of a station wagon, have your dealer install a combination anchor-tether belt to which the top strap can be hooked.

## Securing a Child Restraint in a Rear Outside Position

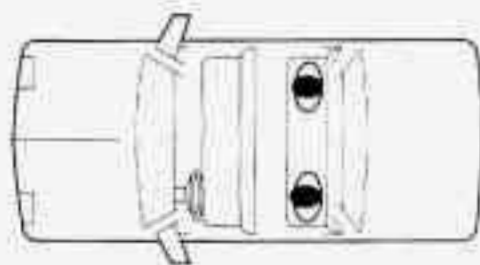

You'll be using the lap-shoulder belt. See the earlier section about the top strap if the child restraint has one.

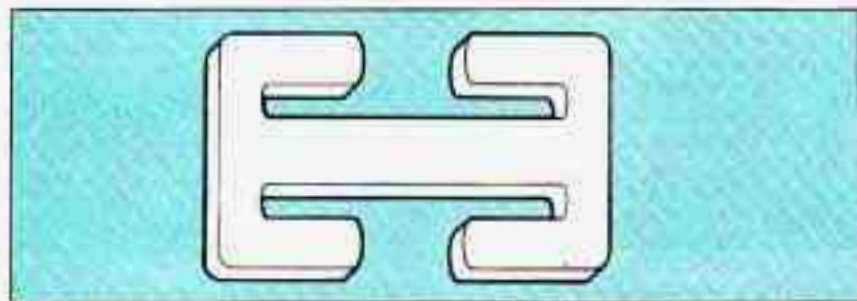

You'll need a safety locking clip to properly secure a child restraint in this position. You can get a locking clip where child restraints are sold, or from your Buick dealer (GM Part Number 94844571). The locking clip must be the same as the one shown here.

Until you have this clip, secure a child restraint only in a seat that has a separate lap belt (and a way to anchor a top strap, if the child restraint has one). See the following section about securing a child restraint in a center position. Once you have the clip, follow these instructions:

1. Put the restraint on the seat. Follow the instructions for the child restraint.
2. Secure the child in the child restraint as the instructions say.
3. Pull out the vehicle's safety belt and run the lap part through or around the restraint. The child restraint instructions will show you how. Tilt the latch plate to adjust the belt if needed. See if the shoulder belt would go in front of the child's face or neck. If so, put it behind the child restraint.



4. Buckle the belt. Make sure the release button faces upward or outward, so you'll be able to unbuckle it quickly if you ever need to.



5. Then thread both the lap and shoulder belt portions through the locking clip.



### **CAUTION:**

If a locking clip is not used or is not installed properly, the child restraint may move or tip over when your vehicle turns or stops quickly. The child or others could be injured. When you secure a child restraint with a lap-shoulder belt, always thread both the lap and shoulder belt portions through a locking clip.





6. Push and pull the child restraint in different directions to be sure it is secure.

To remove the child restraint, just unbuckle the vehicle's safety belt and remove the locking clip. Let the safety belt go back all the way. The safety belt will move freely again and be ready to work for an adult or larger child passenger.

 **CAUTION:**

When not used with a child restraint seat, a safety belt with a child restraint locking clip still attached can cause serious injury in a crash. Always remove the clip when you are not using it with a child restraint.

### Securing a Child Restraint in a Center Seat Position

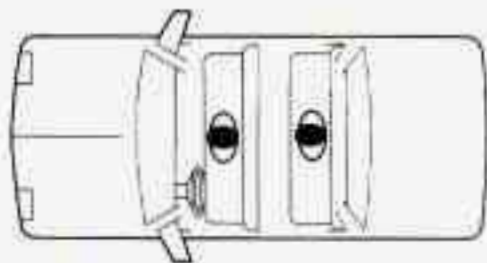

When you secure a child restraint in a center seating position, you'll be using the lap belt.

See the earlier section about the top strap if the child restraint has one.



1. Make the belt as long as possible by tilting the latch plate and pulling it along the belt.
2. Put the restraint on the seat. Follow the instructions for the child restraint.
3. Secure the child in the child restraint as the instructions say.



4. Run the vehicle's safety belt through or around the restraint. The child restraint instructions will show you how.
5. Buckle the belt. Make sure the release button faces upward or outward, so you'll be able to unbuckle it quickly if you ever need to.
6. To tighten the belt, pull its free end while you push down on the child restraint.



7. Push and pull the child restraint in different directions to be sure it is secure. If the child restraint isn't secure, turn the latch plate over and buckle it again. Then see if it is secure. If it isn't, secure the restraint in a different place in the vehicle and contact the child restraint maker for their advice.

To remove the child restraint, just unbuckle the vehicle's safety belt. It will be ready to work for an adult or larger child passenger.

### Securing a Child Restraint in the Right Front Seat

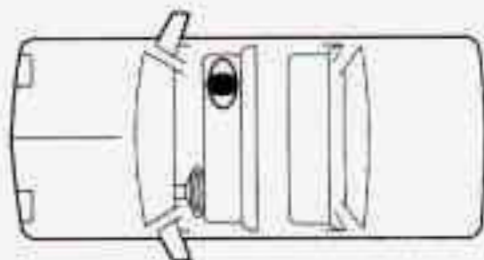

To use a child restraint here, you will need a special infant/child seat attaching belt and the hardware that goes with it. See the earlier section about the top strap if the child restraint has one.



Your dealer can get these and install the hardware for you. It's free. The special belt is GM Part Number 12340286. Your dealer can find the correct hardware in the accessory section of the GM Parts Catalog.



**⚠ CAUTION:**

Don't use the special infant/child seat attaching hardware in another vehicle. If you do, it may not work well and the child may not be protected properly in a crash. The special hardware is for your vehicle only.

Also, don't use the special belt for anything but securing a child restraint in the right front seat. If an adult or older child uses it, the belt won't provide protection and may even increase injury in a crash.



Once the special hardware is installed, please follow the instructions with it and these steps:

1. Unbuckle the automatic lap-shoulder belt by pushing the button on the buckle. It will stay on the door, ready to be rebuckled for use by adults or older children.



- 2.** Snap one hook of the infant/child seat attaching belt near the floor at the door side of the seat.



- 3.** Put the belt's special latch plate into the vehicle's safety belt buckle.





4. You can make the belt longer by tilting the buckle and pulling it along the belt.
5. Put the restraint on the seat. Follow the instructions for the child restraint.
6. Secure the child in the child restraint as the instructions say.
7. Run the belt through or around the child restraint. The child restraint instructions will show you how.



8. Put the hook on the free end through the slot in the latch plate.





9. To make it tight, pull the belt while you push down on the child restraint. If the belt won't stay tight, switch it end for end.
10. Push and pull the child restraint in different directions to be sure it is secure.

**To remove the infant/child seat restraint:**

1. Push the button on the safety belt buckle and remove the special latch plate. Leave the latch plate on the special belt.



2. Push the spring on the hook near the door and remove the special belt.
3. Put the belt away in a safe place in your vehicle, so it won't fly around in a crash and injure someone.
4. Remember to reattach the automatic belt again, once the child restraint is removed. Be sure it isn't twisted.

## Larger Children



Children who have outgrown child restraints should wear the vehicle's safety belts. If you have the choice, a child should sit next to a window so the child can wear a lap-shoulder belt and get the additional restraint a shoulder belt can provide. Accident statistics show that children are safer if they are restrained in the rear seat. But they need to use the safety belts properly.

- Children who aren't buckled up can be thrown out in a crash.



- Children who aren't buckled up can strike other people who are.



 **CAUTION:**

Never do this.



Here two children are wearing the same belt. The belt can't properly spread the impact forces. In a crash, the two children can be crushed together and seriously injured. A belt must be used by only one person at a time.

**Q:** What if a child is wearing a lap-shoulder belt, but the child is so small that the shoulder belt is very close to the child's face or neck?

**A:** Move the child toward the center of the vehicle, but be sure that the shoulder belt still is on the child's shoulder, so that in a crash the child's upper body would have the restraint that belts provide. If the child is so small that the shoulder belt still is very close to the child's face or neck, you might want to place the child in the center seat position, the one that has only a lap belt.



## CAUTION:

Never do this.



Here a child is sitting in a seat that has a lap-shoulder belt, but the shoulder part is behind the child. If the child wears the belt in this way, in a crash the child might slide under the belt. The belt's force would then be applied right on the child's abdomen. That could cause serious or fatal injuries.

Wherever the child sits, the lap portion of the belt should be worn low and snug on the hips, just touching the child's thighs. This applies belt force to the child's pelvic bones in a crash.

### Safety Belt Extender

If the vehicle's safety belt will fasten around you, you should use it. The automatic lap-shoulder belt has plenty of extra length built in, so it will fasten around almost all people.

But if a safety belt isn't long enough to fasten, your dealer will order you an extender. It's free. When you go in to order it, take the heaviest coat you will wear, so the extender will be long enough for you. The extender will be just for you, and just for the seat in your vehicle that you choose. Don't let someone else use it, and use it only for the seat it is made to fit. To wear it, just attach it to the regular safety belt.

### Checking Your Restraint Systems

Now and then, make sure all your belts, buckles, latch plates, retractors, anchorages and reminder systems are working properly. Look for any loose parts or damage. If you see anything that might keep a restraint system from doing its job, have it repaired.

## Replacing Safety Belts After a Crash

If you've had a crash, do you need new belts?

After a very minor collision, nothing may be necessary. But if the belts were stretched, as they would be if worn during a more severe crash, then you need new belts.

If belts are cut or damaged, replace them. Collision damage also may mean you will have to have safety belt parts, like the retractor, replaced or anchorage locations repaired—even if the belt wasn't being used at the time of the collision.

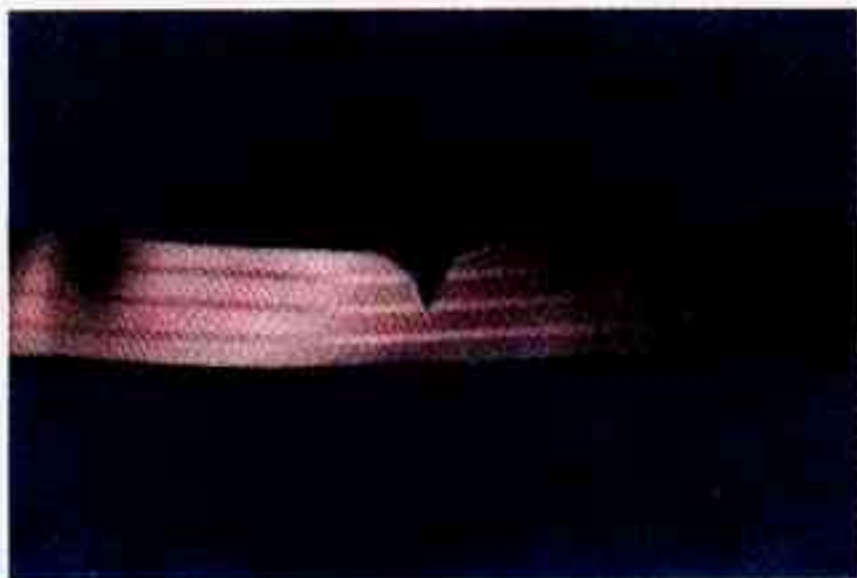

**Q:** What's wrong with this?

**A:** The belt is torn.



### **CAUTION:**

**Torn or frayed belts may not protect you in a crash. They can rip apart under impact forces. If a belt is torn or frayed, get a new one right away.**







## Part 2 Features and Controls

Here you can learn about the many standard and optional features on your Buick, and information on starting, shifting and braking. Also explained are the instrument panel and the warning systems that tell you if everything is working properly—and what to do if you have a problem.

### Part 2 includes:

Keys .....	64
Locks .....	65
Remote Keyless Entry System .....	66
New Vehicle Break-In .....	72
Ignition .....	73
Starting Your Engine .....	74
Shifting the Transaxle .....	77
Parking Brake .....	80
Shifting Into Park .....	81
Windows .....	84
Horn .....	86
Tilt Steering Wheel .....	86
Turn Signal/Headlight Beam Lever .....	86
Windshield Wipers, Washer .....	88
Cruise Control .....	91
Interior Lights .....	95
Headlights .....	95
Mirrors .....	98
Instrument Panel .....	105
Warning Lights, Gages and Indicators .....	106

## Keys

### CAUTION:

Leaving young children in a vehicle with the ignition key is dangerous for many reasons. A child or others could be badly injured or even killed.

They could operate power windows or other controls, or even make the vehicle move. Don't leave the keys in a vehicle with young children.



The ignition keys are for the ignition only.



The door keys are for the doors and all other locks.

When a new Century is delivered, the dealer removes the plugs from the keys, and gives them to the first owner.

Each plug has a code on it that tells your dealer or a qualified locksmith how to make extra keys. Keep the plugs in a safe place. If you lose your keys, you'll be able to have new ones made easily using these plugs.



## **NOTICE:**

**Your Buick has a number of new features that can help prevent theft. But you can have a lot of trouble getting into your vehicle if you ever lock your keys inside. You may even have to damage your vehicle to get in. So be sure you have extra keys.**

## **Door Locks**

### **CAUTION:**

**Unlocked doors can be dangerous.**

**Passengers—especially children—can easily open the doors and fall out. When a door is locked, the inside handle won't open it.**

**Outsiders can easily enter through an unlocked door when you slow down or stop your vehicle.**

**This may not be so obvious: You increase the chance of being thrown out of the vehicle in a crash if the doors aren't locked. Wear safety belts properly, lock your doors, and you will be far better off whenever you drive your vehicle.**



There are several ways to lock and unlock your vehicle:

From the outside: Use your door key or Remote Keyless Entry transmitter, if your vehicle has this option.



From the inside: To lock the door, slide the lock control on the door rearward.

To unlock the door, slide the lock control forward.



## Power Door Locks



Press the power door lock switch on either front door to lock or unlock all the doors at once.

## Automatic Door Locks

Just close your doors and turn on the ignition. All of the doors will lock when you move your shift lever out of "P" (Park) or "N" (Neutral). Each time you close your doors and turn on the ignition, the doors will lock automatically only once. If someone needs to get out while the vehicle is running, have that person use the manual or power lock. When the door is closed again, it will not lock automatically. Just use the manual or power lock to lock the door again.

## Leaving Your Vehicle

If you are leaving the vehicle, open your door and set the locks from inside. Then get out and close the door.

## Remote Keyless Entry System (Option)



If your Buick has this option, you can lock and unlock your doors or unlock your trunk or wagon liftgate from up to 30 feet (9 m) away using the key chain transmitter supplied with your vehicle.

Your Remote Keyless Entry System operates on a radio frequency subject to Federal Communications Commission (FCC) Rules.

This device complies with Part 15 of the FCC Rules. Operation is subject to the following two conditions:  
(1) This device may not cause harmful interference, and  
(2) This device must accept any interference received, including interference that may cause undesired operation.

Should interference to this system occur, try this:

- Check to determine if battery replacement is necessary. See the instructions on battery replacement later in this section.
- Check the distance. You may be too far from your vehicle. This product has a maximum range.
- Check the location. Other vehicles or objects may be blocking the signal.
- See your Buick dealer or a qualified technician for service.

Changes or modifications to this system by other than an authorized service facility could void authorization to use this equipment.

### **Operation**

The driver's door will unlock and the interior lights will go on when "UNLOCK" is pressed. If pressed again within five seconds, all doors will unlock. The interior lights will go out after 40 seconds or when you turn on the ignition.

All doors will lock when "DOOR" is pressed.

The trunk or liftgate will unlock when the opened trunk symbol is pressed, but only when the transaxle is in "P" (Park). On the wagon the ignition must also be in the "Off" position.

### **Matching Transmitter(s) to Your Vehicle**

Each key chain transmitter is coded to prevent another transmitter from unlocking your vehicle. If a transmitter is lost or stolen, a replacement can be purchased through your dealer. Remember to bring the remaining transmitter with you when you go to your dealer. When the dealer matches the replacement transmitter to your vehicle, the remaining transmitter must also be matched. Once the new transmitter is coded, the lost transmitter will not unlock your vehicle.

You can match a transmitter to as many different vehicles as you own, provided they are equipped with **exactly the same model system**. (General Motors offers several different models of these systems on their vehicles.) Each vehicle can have only two transmitters matched to it. See your dealer to match transmitters to another vehicle.

### **Battery Replacement**

Under normal use, the batteries in your key chain transmitter should last about two years.

You can tell the batteries are weak if the transmitter won't work at the normal range in any location. If you have to get close to your vehicle before the transmitter works, it's probably time to change the batteries.





For battery replacement use two Duracell® batteries, type DL-2016, or a similar type.



To replace batteries:

1. Remove the screw from the back cover.
2. Lift off the front cover, bottom half first.
3. Remove and replace the batteries. Put them in following the diagram under the batteries on the inside of the cover.
4. Replace the front cover. Make sure the cover is on tightly, so water won't get in. Replace the screw in the back cover.
5. Check the transmitter operation.



## Trunk/Liftgate

### Remote Electric Trunk Or Liftgate Release (Option)

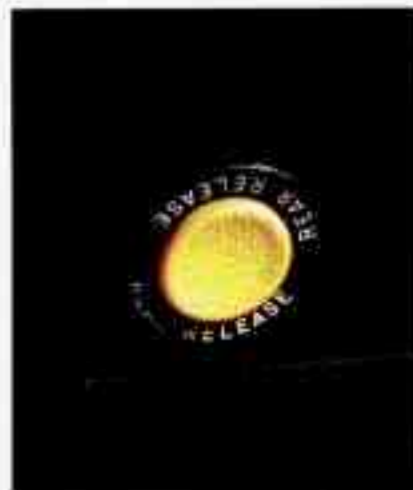

If you have this option, you'll find the button here in the glove box.

### Trunk Lock



To unlock the trunk from the outside, insert the door key and turn it clockwise.

## Wagon Liftgate Operation

The liftgate on your station wagon has two parts: a liftglass and a liftgate.

### NOTICE:

Be sure there are no overhead obstructions before you open the liftgate. You could slam the liftgate into something and break the glass.

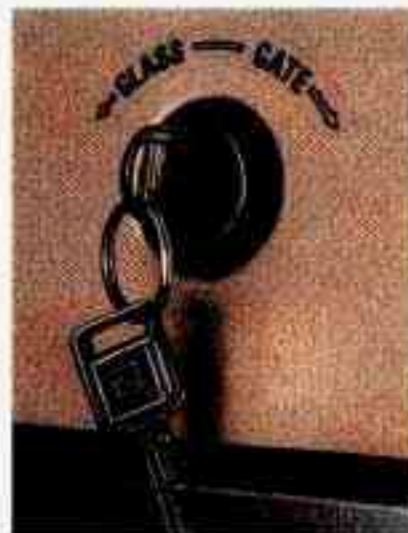

The door key opens the liftgate and the liftglass.



Turn the key to the right to unlatch the liftgate, then pull up on the bottom of the liftgate. To close, pull down on the handle inside the liftgate, then firmly shut the liftgate.



Turn the key to the left to release the liftglass. Then, pull the liftglass up by the handle. To close, lower the liftglass until the latch catches.



## CAUTION:

It can be dangerous to drive with the liftgate or liftglass open. Carbon monoxide (CO) gas can come into your vehicle. You can't see or smell CO. It can cause unconsciousness and even death.

If you must drive with the liftgate or liftglass open:

- Make sure all other windows are shut.
- Turn the fan on your heating or cooling system to its highest speed with the setting on NORM or VENT. That will force outside air into your vehicle. See "Comfort Controls" in the Index.
- If you have air vents on or under the instrument panel, open them all the way.

## Glove Box



Use the door key to lock and unlock the glove box. To open, pinch the latch release.

## Theft

Vehicle theft is big business, especially in some cities. Although your Buick has a number of theft deterrent features, we know that nothing we put on it can make it impossible to steal. However, there are ways you can help.

**Key in the ignition:** If you walk away from your vehicle with the keys inside, it's an easy target for joy riders or professional thieves—so don't do it. When you park your Buick and open the driver's door, you'll hear a chime reminding you to remove your key from the ignition and take it with you. Always do this. Your steering wheel will be locked, and so will your ignition and transaxle. And remember to lock the doors.



**Parking at Night:** Park in a lighted spot, close all windows and lock your vehicle. Remember to keep your valuables out of sight. Put them in a storage area, or take them with you.

**Parking Lots:** If you park in a lot where someone will be watching your vehicle, it's best to lock it up and take your keys. But what if you have to leave your ignition key? What if you have to leave something valuable in your vehicle?

1. Put your valuables in a storage area, like your trunk or glove box, or rear storage area in the wagon.
2. Lock the glove box.
3. Lock all the doors except the driver's.
4. Then take the door key with you.

## New Vehicle "Break-In"

### **NOTICE:**

**Your modern Buick doesn't need an elaborate "break-in." But it will perform better in the long run if you follow these guidelines:**

- **Don't drive at any one speed— fast or slow—for the first 500 miles (804 km). Don't make full-throttle starts.**
- **Avoid making hard stops for the first 200 miles (322 km) or so. During this time your new brake linings aren't yet broken in. Hard stops with new linings can mean premature wear and earlier replacement. Follow this "breaking-in" guideline every time you get new brake linings.**

## Ignition Key Positions

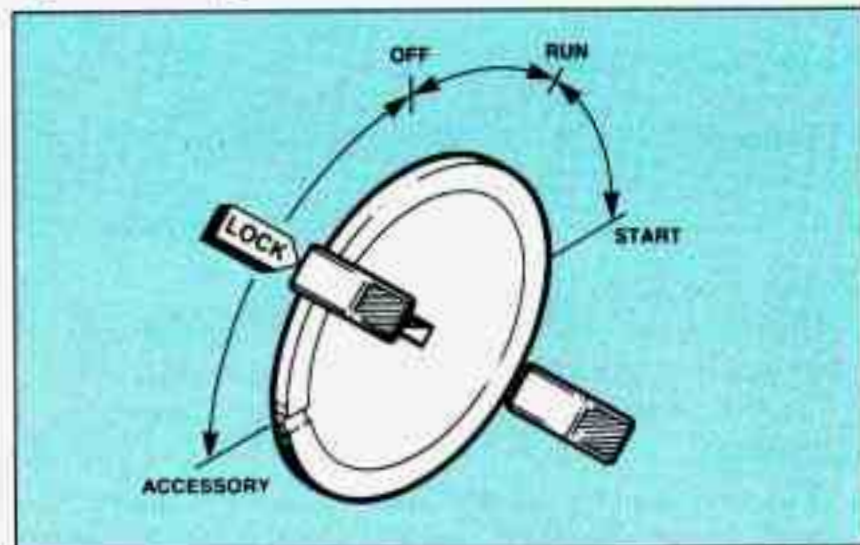

With the ignition key in the ignition switch, you can turn the switch to five positions:

**Accessory:** An "on" position in which you can operate your electrical power accessories. Press in the ignition switch as you turn the top of it toward you.

**Lock:** The only position in which you can remove the key. This locks your steering wheel, ignition and transaxle.

**Off:** Unlocks the steering wheel, ignition, and transaxle, but does not send electrical power to any accessories. Use this position if your vehicle must be pushed or towed, but never try to push-start your vehicle. A warning chime will sound if you open the driver's door when the ignition is off and the key is in the ignition.

**Run:** An "on" position to which the switch returns after you start your engine and release the switch. The switch stays in the "Run" position when the engine is running. But even when the engine is not running, you can use "Run" to operate your electrical power accessories, and to display some instrument panel warning lights.

**Start:** Starts the engine. When the engine starts, release the key. The ignition switch will return to "Run" for normal driving.

Note that even if the engine is not running, the positions "Accessory" and "Run" are "on" positions that allow you to operate your electrical accessories, such as the radio.



## **NOTICE:**

If your key seems stuck in "Lock" and you can't turn it, be sure it is all the way in. If it is, then turn the steering wheel left and right while you turn the key hard. But turn the key only with your hand. Using a tool to force it could break the key or the ignition switch. If none of this works, then your vehicle needs service.

## **Starting Your Engine**

Engines start differently. The 8th digit of your Vehicle Identification Number (VIN) shows the code letter or number for your engine. You will find the VIN at the top left of your instrument panel. (See "Vehicle Identification Number" in the Index.) Follow the proper steps to start the engine.

Move your shift lever to "P" (Park) or "N" (Neutral). Your engine won't start in any other position—that's a safety feature. To restart when you're already moving, use "N" (Neutral) only.

## **NOTICE:**

Don't try to shift to "P" (Park) if your Buick is moving. If you do, you could damage the transaxle. Shift to "P" (Park) only when your vehicle is stopped.

To start your 2.2L I4 (Code 4) engine:

1. Don't push the accelerator pedal before starting your engine. In some other vehicles you might need to do this, but because of your vehicle's computer systems, you don't.
2. Turn your ignition key to "Start." When the engine starts, let go of the key. The idle speed will go down as your engine gets warm.
3. If it doesn't start right away, push the accelerator pedal about one-quarter of the way down while you turn the key to "Start." Do this until the engine starts. As soon as it does, let go of the key and the accelerator pedal.

## **NOTICE:**

Holding your key in "Start" for longer than 15 seconds at a time will cause your battery to be drained much sooner. And the excessive heat can damage your starter motor.



4. If your engine still won't start (or starts but then stops), it could be flooded with too much gasoline. Try pushing your accelerator pedal all the way to the floor and holding it there as you hold the key in "Start" for about three seconds. If the car starts briefly but then stops again, do the same thing, but this time keep the pedal down for five or six seconds. This clears the extra gasoline from the engine.

## **NOTICE:**

**Your engine is designed to work with the electronics in your vehicle. If you add electrical parts or accessories, you could change the way the fuel injection system operates. Before adding electrical equipment, check with your dealer. If you don't, your engine might not perform properly.**

**If you ever have to have your vehicle towed, see the part of this Manual that tells how to do it without damaging your vehicle. See "Towing Your Buick" in the Index.**

## **To start your 3300 V6 (Code N) engine:**

1. Don't push the accelerator pedal before starting your engine. In some other vehicles you might need to do this, but because of your vehicle's computer systems, you don't.
2. Turn your ignition key to "Start." When the engine starts, let go of the key. The idle speed will go down as your engine gets warm.
3. If it doesn't start right away, push the accelerator pedal about one-quarter of the way down while you turn the key to "Start." Do this until the engine starts. As soon as it does, let go of the key and the accelerator pedal.

## **NOTICE:**

**Holding your key in "Start" for longer than 15 seconds at a time will cause your battery to be drained much sooner. And the excessive heat can damage your starter motor.**

4. If your engine still won't start (or starts but then stops), it could be flooded with too much gasoline. Try pushing your accelerator pedal all the way to the floor and holding it there as you hold the key in "Start" for about 15 seconds. This clears the extra gasoline from the engine. Turn the ignition key to "Off." Wait 10 seconds, then repeat Step 3.

## **NOTICE:**

Your engine is designed to work with the electronics in your vehicle. If you add electrical parts or accessories, you could change the way the fuel injection system operates. Before adding electrical equipment, check with your dealer. If you don't, your engine might not perform properly.

If you ever have to have your vehicle towed, see the part of this Manual that tells how to do it without damaging your vehicle. See "Towing Your Buick" in the Index.

## **Driving Through Deep Standing Water**

### **NOTICE:**

If you drive too quickly through deep puddles or standing water, water can come in through your engine's air intake and badly damage your engine. If you can't avoid deep puddles or standing water, drive through them very slowly.

## **Engine Block Heater (Canada Only)**

In very cold weather, 0°F (-18°C) or colder, the engine block heater can help. You'll get easier starting and better fuel economy during engine warm-up.

### **To use the block heater:**

1. Turn off the engine.
2. Open the hood and unwrap the electrical cord.
3. Plug it into a normal, grounded 110-volt outlet.



### **CAUTION:**

Plugging the cord into an ungrounded outlet could cause an electrical shock. Also, the wrong kind of extension cord could overheat and cause a fire. You could be seriously injured. Plug the cord into a properly grounded three-prong 110-volt outlet. If the cord won't reach, use a heavy-duty three-prong extension cord rated for at least 15 amps.



## NOTICE:

After you've used the block heater, be sure to store the cord as it was before, to keep it away from moving engine parts. If you don't, it could be damaged.

How long should you keep the block heater plugged in? The answer depends on the weather, the kind of oil you have, and some other things. Instead of trying to list everything here, we ask that you contact a Buick dealer in the area where you'll be parking your vehicle. The dealer can give you the best advice for that particular area.

## Automatic Transaxle



There are several different positions for your shift lever.

- **P (Park)**

This locks your front wheels. It's the best position to use when you start your engine because your vehicle can't move easily.



## CAUTION:

It is dangerous to get out of your vehicle if the shift lever is not fully in "P" (Park) with the parking brake firmly set. Your vehicle can roll.

Don't leave your vehicle when the engine is running unless you have to. If you have left the engine running, the vehicle can move suddenly. You or others could be injured. To be sure your vehicle won't move, when you're on fairly level ground, always set your parking brake and move the shift lever to "P" (Park).

See "Shifting Into 'P' (Park)" in the Index. If you are parking on a hill, or, if you're pulling a trailer, also see "Parking on Hills" or "Towing a Trailer" in the Index.

- **R (Reverse)**

Use this gear to back up.



## NOTICE:

Shifting to "R" (Reverse) while your vehicle is moving forward could damage your transaxle. Shift to "R" only after your vehicle is stopped.

To rock your vehicle back and forth to get out of snow, ice or sand without damaging your transaxle, see "If You're Stuck: In Sand, Mud, Ice or Snow" in the Index.

### • N (Neutral)

In this position, your engine doesn't connect with the wheels. To restart when you're already moving, use "N" (Neutral) only. Also, use "N" when your vehicle is being towed.

## CAUTION:

Shifting out of "P" (Park) or "N" (Neutral) while your engine is "racing" (running at high speed) is dangerous. Unless your foot is firmly on the brake pedal, your vehicle could move very rapidly. You could lose control and hit people or objects. Don't shift out of "P" (Park) or "N" (Neutral) while your engine is racing.

## NOTICE:

Damage to your transaxle caused by shifting out of "P" (Park) or "N" (Neutral) with the engine racing isn't covered by your warranty.

### • (Automatic Overdrive)

If your automatic transaxle has automatic overdrive, this position is for normal driving. If you need more power for passing, and you're:

- Going less than about 35 mph (56 km/h), push your accelerator pedal about halfway down.
- Going about 35 mph (56 km/h) or more, push the accelerator all the way down. You'll shift down to the next gear and have more power.

### • D (Third Gear)

If your automatic transaxle does not have Overdrive, this position is for normal driving, at all speeds, in most street and highway situations.

If your automatic transaxle has Overdrive, "D" is like "D," but you never go into Overdrive. Here are some times you might choose "D" instead of "D":

- When driving on hilly, winding roads
- When towing a trailer, so there is less shifting between gears
- When going down a steep hill

## • 2 (Second Gear)

This position gives you more power but lower fuel economy. You can use "2" on hills. It can help control your speed as you go down steep mountain roads, but then you would also want to use your brakes off and on.

### **NOTICE:**

Don't drive in "2" (Second Gear) for more than 5 miles (8 km), or at speeds over 55 mph (88 km/h), or you can damage your transaxle. Use "D" ("D" or "D" if your vehicle has Overdrive) as much as possible.

Don't shift into "2" unless you are going slower than 65 mph (105 km/h), or you can damage your engine.

## • 1 (First Gear)

This position gives you even more power (but lower fuel economy) than "2." You can use it on very steep hills, or in deep snow or mud. If the selector lever is put in "1," the transaxle won't shift into first gear until the vehicle is going slowly enough.

### **NOTICE:**

If your front wheels can't rotate, don't try to drive. This might happen if you were stuck in very deep sand or mud or were up against a solid object. You could damage your transaxle.

Also, if you stop when going uphill, don't hold your vehicle there with only the accelerator pedal. This could overheat and damage the transaxle. Use your brakes or shift into "P" (Park) to hold your vehicle in position on a hill.



## Parking Brake

The parking brake uses the brakes on the rear wheels.



**To set the parking brake:** Hold the regular brake pedal down with your right foot. Push down the parking brake pedal with your left foot. If the ignition is on, the brake system warning light will come on.



**To release the parking brake:** Hold the regular brake pedal down. Pull the brake release lever.

## NOTICE:

Driving with the parking brake on can cause your rear brakes to overheat. You may have to replace them, and you could also damage other parts of your vehicle.

**If you are on a hill:** See "Parking on Hills" in the Index. That section shows how to turn your front wheels.

**If you are towing a trailer and are parking on any hill:** See "Towing a Trailer" in the Index. That section shows what to do first to keep the trailer from moving.



## Shifting Into "P" (Park)

### CAUTION:

It can be dangerous to get out of your vehicle if the shift lever is not fully in "P" (Park) with the parking brake firmly set. Your vehicle can roll.

If you have left the engine running, the vehicle can move suddenly. You or others could be injured. To be sure your vehicle won't move, when you're on fairly level ground, use the steps that follow. If you are parking on a hill, or if you're pulling a trailer, also see "Parking on Hills" or "Towing a Trailer" in the Index.

## Steering Column Shift Lever



1. Hold the brake pedal down with your right foot and set the parking brake.
2. Move the shift lever into the "P" (Park) position like this:
  - Pull the lever toward you.



## Leaving Your Vehicle With the Engine Running

### CAUTION:

It can be dangerous to leave your vehicle with the engine running. Your vehicle could move suddenly if the shift lever is not fully in "P" (Park) with the parking brake firmly set. And, if you leave the vehicle with the engine running, it could overheat and even catch fire. You or others could be injured. Don't leave your vehicle with the engine running unless you have to.

- Move the lever up as far as it will go.
3. Move the ignition key to "Lock."
  4. Remove the key and take it with you. If you can walk away from your vehicle with the ignition key in your hand, your vehicle is in "P" (Park).

If you have to leave your vehicle with the engine running, be sure your vehicle is in "P" (Park) and your parking brake is firmly set before you leave it. After you've moved the shift lever into the "P" (Park) position, hold the regular brake pedal down. Then, see if you can move the shift lever away from "P" (Park) without first pulling it toward you.

If you can, it means that the shift lever wasn't fully locked into "P" (Park).



## Parking Over Things That Burn



### CAUTION:

Things that can burn could touch hot exhaust parts under your vehicle and ignite. Don't park over papers, leaves, dry grass or other things that can burn.

## Engine Exhaust

### CAUTION:

Engine exhaust can kill. It contains the gas carbon monoxide (CO), which you can't see or smell. It can cause unconsciousness and death.

You might have exhaust coming in if:

- Your exhaust system sounds strange or different.
- Your vehicle gets rusty underneath.
- Your vehicle was damaged in a collision.
- Your vehicle was damaged when driving over high points on the road or over road debris.
- Repairs weren't done correctly.
- Your vehicle or exhaust system had been modified improperly.

If you ever suspect exhaust is coming into your vehicle:

- Drive it only with all the windows down to blow out any CO; and
- Have it fixed **immediately**.



## Running Your Engine While You're Parked

It's better not to park with the engine running. But if you ever have to, here are some things to know.

### CAUTION:

Idling the engine with the air system control off could allow dangerous exhaust into your vehicle (see the earlier CAUTION under "Engine Exhaust").

Also, idling in a closed-in place can let deadly carbon monoxide (CO) into your vehicle even if the fan switch is at the highest setting. One place this can happen is a garage. Exhaust—with CO—can come in easily. **NEVER** park in a garage with the engine running.

Another closed-in place can be a blizzard. (See "Blizzard" in the Index.)

It can be dangerous to get out of your vehicle if the shift lever is not fully in "P" (Park) with the parking brake firmly set. Your vehicle can roll. Don't leave your vehicle when the engine is running unless you have to. If you've left the engine running, the vehicle can move suddenly. You or others could be injured. To

CAUTION (Continued)

### CAUTION (Continued)

be sure your vehicle won't move, even when you're on fairly level ground, always set your parking brake and move the shift lever to "P" (Park).

Follow the proper steps to be sure your vehicle won't move. See "Shifting Into 'P' (Park)" in the Index.

If you are parking on a hill, or if you're pulling a trailer, also see "Parking On Hills" or "Towing a Trailer" in the Index.

## Windows

On a vehicle with manual windows, use the window crank to open and close each window.

## Power Windows (Option)



With power windows, switches on the driver's armrest control each of the windows when the ignition is on. In addition, each passenger door has a control switch for its own window.

## Flip-Open Rear Vent Windows (Option, Wagon)



To open, pull the latch forward, then push on the center of the latch to swing the window out into the open position.

To close the window, pull the center of the latch and then press the latch into the closed position.



## Horn

You can sound the horn by pressing the horn symbol on your steering wheel.

## Tilt Steering Wheel (Option)



A tilt steering wheel allows you to adjust the steering wheel before you drive. You can also raise it to the highest level to give your legs more room when you exit and enter the vehicle.

To tilt the wheel, hold the steering wheel and pull the lever. Move the steering wheel to a comfortable level, then release the lever to lock the wheel in place.

## The Turn Signal/Headlight Beam Lever



The lever on the left side of the steering column includes your:

- Turn Signal and Lane Change Indicator
- Headlight High-Low Beam
- Windshield Wipers
- Windshield Washer
- Cruise Control (Option)



## Turn Signal and Lane Change Indicator

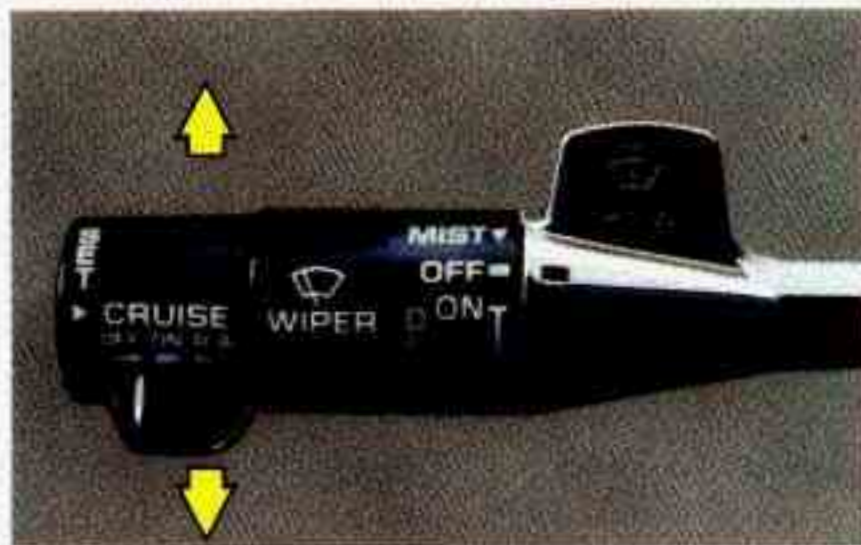

The turn signal has two upward (for Right) and two downward (for Left) positions. These positions allow you to signal a turn or a lane change.

To signal a turn, move the lever all the way up or down. When the turn is finished, the lever will return automatically.



A green arrow on the instrument panel will flash in the direction of the turn or lane change.

To signal a lane change, just raise or lower the lever until the green arrow starts to flash. Hold it there until you complete your lane change. The lever will return by itself when you release it.

As you signal a turn or a lane change, if the arrows don't flash but just stay on, a signal bulb may be burned out and other drivers won't see your turn signal.

If a bulb is burned out, replace it to help avoid an accident. If the green arrows don't go on at all when you signal a turn, check the fuse (see "Fuses & Circuit Breakers" in the Index) and for burned-out bulbs.

### Turn Signal Reminder

If your turn signal is left on for more than  $\frac{3}{4}$  of a mile, a chime will sound. To turn off the chime, move the turn signal lever to the off position.

## Headlight High-Low Beam



To change the headlights from low beam to high, or high to low, pull the turn signal lever all the way toward you. Then release it. When the high beams are on, this blue light on the instrument panel also will be on.

## Windshield Wipers



You control the windshield wipers by turning the band marked "WIPER."

For a single wiping cycle, turn the band to "MIST!" Hold it there until the wipers start, then let go. The wipers will stop after one cycle. If you want more cycles, hold the band on "MIST" longer.

For steady wiping at low speed, turn the band away from you to the "LO" position. For high speed wiping, turn the band further, to "HI." To stop the wipers, move the band to "OFF!"



## Low Speed Delay Wipers (Option)

You can set the wiper speed for a long or short delay between wipes. This can be very useful in light rain or snow. Turn the band to choose the delay time. The closer to "LO," the shorter the delay.

### CAUTION:

**Damaged wiper blades may prevent you from seeing well enough to drive safely. To avoid damage, be sure to clear ice and snow from the wiper blades before using them. If they're frozen to the windshield, carefully loosen or thaw them. If your blades do become damaged, get new blades or blade inserts.**

Heavy snow or ice can overload your wipers. A circuit breaker in the motor will stop them until the motor cools. Clear away snow or ice to prevent an overload.

## Windshield Washer

At the top of the turn signal/headlight beam lever there's a paddle with the word "PUSH" on it. To spray washer fluid on the windshield, push the paddle.

If you push the paddle less than one second, washer fluid will spray three to four times while the wiper blades cycle. If you push the paddle longer than one second, washer fluid will spray as long as the paddle is held. When you release the paddle, the wiper blades will cycle three to four more times.

If you have the standard wipers, the wipers will keep going in "LO" until you turn the wiper control to "OFF."

If you have the optional low speed delay wipers, the wipers will clear the window and then either stop or return to your preset speed.

### CAUTION:

- **Driving without washer fluid can be dangerous. A bad mud splash can block your vision. You could hit another vehicle or go off the road. Check your washer fluid level often.**
- **In freezing weather, don't use your washer until the windshield is warmed. Otherwise the washer fluid can form ice on the windshield, blocking your vision.**



## NOTICE:

- When using concentrated washer fluid, follow the manufacturer's instructions for adding water.
- Don't mix water with ready-to-use washer fluid. Water can cause the solution to freeze and damage your washer fluid tank and other parts of the washer system. Also, water doesn't clean as well as washer fluid.
- Fill your washer fluid tank only  $\frac{3}{4}$  full when it's very cold. This allows for expansion, which could damage the tank if it is completely full.
- Don't use radiator antifreeze in your windshield washer. It can damage your washer system and paint.

## Rear Window Washer/Wiper (Option)

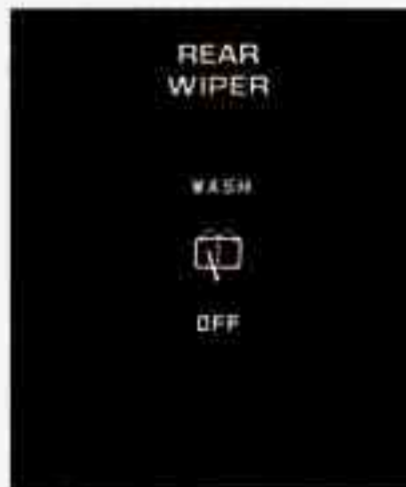

The rear window washer/wiper switch is at the center of the instrument panel. Press the top of the switch labeled "WASH" and the rear wiper will run at a constant speed.

Press the switch further and hold to spray washer fluid while the wiper continues to run. The wiper will continue to run until you press the switch to "OFF".

The rear window washer fluid reservoir is the smaller reservoir next to the coolant reservoir.

## Cruise Control (Option)



With Cruise Control, you can maintain a speed of about 25 mph (40 km/h) or more without keeping your foot on the accelerator. This can really help on long trips. Cruise Control does not work at speeds below about 25 mph (40 km/h).

When you apply your brakes, the Cruise Control shuts off.

### CAUTION:

- Cruise Control can be dangerous where you can't drive safely at a steady speed. So, don't use your Cruise Control on winding roads or in heavy traffic.
- Cruise Control can be dangerous on slippery roads. On such roads, fast changes in tire traction can cause needless wheel spinning, and you could lose control. Don't use Cruise Control on slippery roads.

### To Set Cruise Control



1. Move the Cruise Control switch to "ON"



## CAUTION:

If you leave your Cruise Control switch "ON" when you're not using Cruise, you might hit a button and go into Cruise when you don't want to. You could be startled and even lose control. Keep the Cruise Control switch "OFF" until you want to use it.

2. Get up to the speed you want.



3. Push in the "SET" button at the end of the lever and release it.
4. Take your foot off the accelerator pedal.

## To Resume a Set Speed



Suppose you set your Cruise Control at a desired speed and then you apply the brake. This, of course, shuts off the Cruise Control. But you don't need to reset it. Once you're going about 25 mph (40 km/h) or more, you can move the Cruise Control switch from "ON" to "R/A" (Resume/Accelerate) for about half a second.

You'll go right back up to your chosen speed and stay there.

## CAUTION:

If you hold the switch at "R/A" longer than half a second, the vehicle will keep going faster until you release the switch or apply the brake. You could be startled and even lose control. So unless you want to go faster, don't hold the switch at "R/A."



## To Increase Speed While Using Cruise Control

There are two ways to go to a higher speed. Here's the first:

1. Use the accelerator pedal to get to the higher speed.



2. Push the button at the end of the lever, then release the button and the accelerator pedal. You'll now cruise at the higher speed.



Here's the second way to go to a higher speed:

1. Move the Cruise switch from "ON" to "R/A." Hold it there until you get up to the speed you want, and then release the switch.

2. To increase your speed in very small amounts, move the switch to "R/A" for less than half a second and then release it. Each time you do this, your vehicle will go about 1 mph (1.6 km/h) faster.

## To Reduce Speed While Using Cruise Control

There are two ways to reduce your speed while using Cruise Control:



- Push in the button at the end of the lever until you reach the lower speed you want, then release it.
- To slow down in very small amounts, push the button for less than half a second. Each time you do this, you'll go 1 mph (1.6 km/h) slower.

## Passing Another Vehicle While Using Cruise Control

Use the accelerator pedal to increase your speed. When you take your foot off the pedal, your vehicle will slow down to the Cruise Control speed you set earlier.

## Using Cruise Control on Hills

How well your Cruise Control will work on hills depends upon your speed, load, and the steepness of the hills. When going up steep hills, you may have to step on the accelerator pedal to maintain your speed. When going downhill, you may have to brake or shift to a lower gear to keep your speed down. Of course, applying the brake takes you out of Cruise Control. Many drivers find this to be too much trouble and don't use Cruise Control on steep hills.

## To Get Out of Cruise Control



There are two ways to turn off the Cruise Control:

- Step lightly on the brake pedal; OR



- Move the Cruise switch to "OFF:"

## To Erase Cruise Speed Memory

When you turn off the Cruise Control or the ignition, your Cruise Control set speed memory is erased.



## Lights

### Interior Lights/Instrument Panel Intensity Control

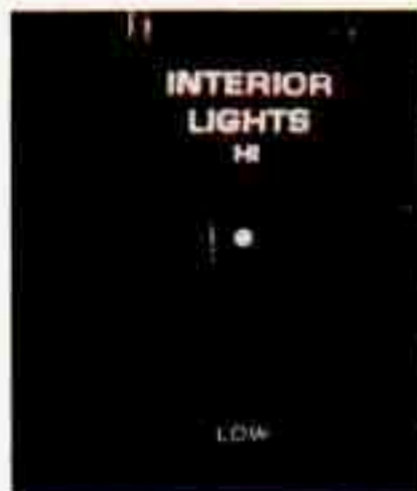

You can brighten or dim the instrument panel lights by rotating the control up or down. To turn on the interior courtesy lights, rotate the control all the way up to "HI."

### Headlights



Press the switch marked "P" to turn on:

- Parking Lights
- Side Marker Lights
- Taillights
- License Plate Lights
- Instrument Panel Lights

Press the  switch to turn on the headlights, together with:

- Parking Lights
- Side Marker Lights
- Taillights
- License Plate Lights
- Instrument Panel Lights

Press "OFF" to turn off the lights.

### Operation of Lights

Although your vehicle's lighting system (headlamps, parking lamps, fog lamps, side marker lamps and tail lamps) meets all applicable federal lighting requirements, certain States and Provinces may apply their own lighting regulations that may require special attention before you operate these lamps. For example, some jurisdictions may require that you operate your lower beam lamps with fog lamps at all times, or that headlamps be turned on whenever you must use your windshield wipers. In addition, most jurisdictions prohibit driving solely with parking lamps, especially at dawn or dusk. It is recommended that you check with your own State or Provincial highway authority for applicable lighting regulations.

## Headlight “On” Warning

If you open the door while leaving the lights on, you will hear a warning chime.

## Daytime Running Lights (Canada Only)

The Canadian Federal Government has decided that “Daytime Running Lights” (DRL) are a useful feature, in that DRL can make your vehicle more visible to pedestrians and other drivers during daylight hours. DRL are required on new vehicles sold in Canada.

Your DRL work with a light sensor on top of the instrument panel. Don’t cover it up. The low beam headlights will come on at reduced brightness in daylight when:

- The ignition is on
- The headlight switch is off, and
- The parking brake is released.

At dusk, the exterior lights will come on automatically and the low beams will change to full brightness. At dawn, the exterior lights will go out and the low beams will change to the reduced brightness of DRL (if the headlight switch is off).

Of course, you may still turn on the headlights any time you need to.

To idle your vehicle with DRL off, set the parking brake while the ignition is in the “Off” or “Lock” position. Then start the vehicle. The DRL will stay off until you release the parking brake.

## Map Light



Press the switch to turn the map light on and off.

### Front Seat Reading Lights (Option)



Press the switch to turn on the front seat reading lights.

To avoid draining your vehicle battery's power, be sure to turn off all front and rear reading lights when leaving your vehicle.

### Rear Reading Light (Wagon)

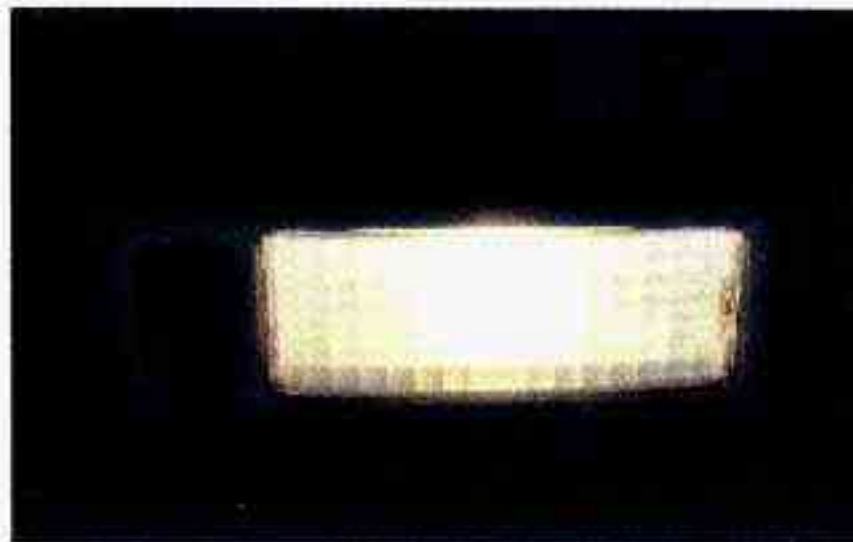

This light will go on when you open the liftgate. To turn on the light when the liftgate is closed, press the switch.

### Interior Lights Delay

When you pull on the driver's outside door handle, the dome and courtesy lights will go on and stay on for about 40 seconds, or until you turn the ignition on.

If you pull on the driver's inside door handle within 30 seconds of switching off the ignition, the interior lights will go on and stay on for about 5 seconds, to allow you to unlock your door(s).



## Courtesy Lights

When any door is opened, several lights go on. These lights are under the instrument panel. Optional lights are on the rear doors. They make it easy for you to enter and leave the vehicle. You also can turn these lights on by rotating the interior lights switch to "HI."

## Mirrors

### Inside Mirror



To reduce glare from lights behind you, pull the lever toward you to the night position.

### Inside Rearview Mirror with Reading Lights (Option)



To reduce glare from lights behind you, pull the lever toward you to the night position.

To turn on the reading lights, press the switches on the front of the mirror.

## Outside Mirrors

### Manual Adjust Mirrors

Both the driver and passenger side outside mirrors should be adjusted so that you just see the side of your vehicle when you are sitting in a comfortable driving position.



Use the remote control knob on the driver's door to adjust the driver's outside mirror. Adjust the passenger's outside mirror by hand.

### Power Remote Control Mirrors (Option)

Both the driver's and optional passenger side outside mirrors can be adjusted with the control lever on the driver's door.



Turn the knob left or right to select the driver's or passenger's mirror. Rotate the knob to adjust the mirror.

Adjust each mirror so that you can just see the side of your vehicle when you are sitting in a comfortable driving position.

### Convex Outside Mirror

Your right side mirror is convex. A convex mirror's surface is curved so you can see more from the driver's seat.



### CAUTION:

If you aren't used to a convex mirror, you can hit another vehicle. A convex mirror can make things (like other vehicles) look farther away than they really are. If you cut too sharply into the right lane, you could hit a vehicle on your right. Check your inside mirror or glance over your shoulder before changing lanes.



## Sun Visors

To block out glare, you can swing down the visors.

## Visor Vanity Mirrors



**Standard Mirror:** Open the cover to expose the vanity mirror.

**Lighted Mirrors:** If your vehicle has the optional lighted vanity mirrors, the lights come on when you open the cover. These can even be used for reading. Close the cover to turn out the lights.

## Luggage Carrier (Option)

If you have the optional luggage carrier, you can load things on top of a wagon, or on the deck lid of your vehicle. The luggage carrier has slats attached to the deck lid, a rear rail, and tiedowns. The wagon has slats attached to the roof, side rails, and adjustable crossrails. The crossrails can be adjusted by loosening the screws. After moving the crossrails, be sure to tighten the screws securely.

### NOTICE:

**Loading cargo that weighs more than 50 pounds (23 kg) for the deck lid or 200 pounds (90 kg) for the roof on the luggage carrier may damage your vehicle. When you carry large things, never let them hang over the rear or the sides of your vehicle. Load your cargo so that it rests on the slats and does not scratch or damage the vehicle. Put the cargo against the rear rail of the deck lid carrier and fasten it securely. On the wagon, put the cargo against the side rails of the roof carrier and fasten it securely.**

Don't exceed the maximum vehicle capacity when loading your Buick. For more information on vehicle capacity and loading, see "Loading Your Vehicle" in the Index.



To prevent damage or loss of cargo as you're driving, check now and then to make sure the luggage carrier and cargo are still securely fastened.

### **Convenience Net (Option, Coupe and Sedan)**



Your vehicle may have a convenience net. You'll see it just inside the back wall of the trunk.

Put small loads, like grocery bags, behind the net. It can help keep them from falling over during sharp turns or quick starts and stops.

The net isn't for larger, heavier loads. Store them in the trunk as far forward as you can. You can unhook the net so that it will lie flat when you're not using it.

You can also purchase a convenience net from your dealer.

### **Cargo Security Cover (Option, Wagon)**

This cover is designed to help conceal articles in the rear storage area. It pulls out and retracts like a window shade.

If you have the optional rear-facing third seat, make sure it is folded down.



#### **CAUTION:**

**An improperly stored cargo cover could be thrown about the vehicle during a collision or sudden maneuver. You or others could be injured. If you remove the cover, remove it from the vehicle. When you put it back, always be sure that it is securely reattached.**



**To Use the Cover:** Grasp the handle and pull the cover over the rear storage area. Insert the ends of the support rod into the slots in the trim panel near the liftgate.

When the cover isn't in use, roll it back onto the roller. Hold the handle and lift the support rod out of the slots. Tug the cover lightly, then let it roll back automatically. Don't release the handle until the cover has rolled back completely.



**To Remove the Cover:** You can remove the cover and roller assembly for extra cargo room. Slide back the end sleeve and lift the assembly out of the notch in the trim panel.

To replace the assembly, reverse the procedure.

### Storage Armrest (Option)



The front armrest opens into a storage area. To open it, press the lever at the front edge. Inside is a coin holder, slots to hold cassettes or CDs and a dual cup holder. To use the cup holder, flip it forward and close the armrest cover.

The cup holder can be removed for cleaning. Flip the cup holder into the armrest storage area. Squeeze the arms inward to release the retainer pins. Remove the cup holder.

The armrest can be raised so that a passenger can sit in the center position.

### Rear Locking Storage Compartment (Option, Wagon)



Use your door key to unlock the storage bin on the driver's side near the liftgate. You can also store items under the foot well cover in the load floor.



## Ashtrays



Reach under the front edge of the ashtray compartment to open it. To clean the ashtray, reach under the ashtray and push up from behind it.



To clean the rear ashtrays, fully open the ashtray. Press down on the snuffer as you pull the ashtray down and out.

### **NOTICE:**

**Don't put papers and other things that burn into your ashtrays. If you do, cigarettes or other smoking materials could set them on fire, causing damage.**

## Cigarette Lighter

To use the lighter, push it in all the way and let go. When it's ready, it will pop back by itself.

### **NOTICE:**

**Don't hold a cigarette lighter in with your hand while it is heating. If you do, it won't be able to back away from the heating element when it's ready. That can make it overheat, damaging the lighter and the heating element.**

## The Instrument Panel: Your Information System



Your instrument panel is designed to let you know at a glance how your vehicle is running. You'll know how fast you're going, how much fuel you're using, and many other things you'll need to drive safely and economically.

## Speedometer and Odometer

Your speedometer lets you see your speed in both miles per hour (mph) and kilometers per hour (km/h). Your odometer shows how far your vehicle has been driven, in either miles (used in the U.S.) or kilometers (used in Canada).

Your Buick has a “tamper-resistant odometer.” If you can see silver lines between the numbers, probably someone has tried to turn it back. The numbers may not be true.

You may wonder what happens if a vehicle has to have a new odometer installed. If possible, the new one has to be set to the same reading the old one had. If it can't be, then it's set at zero, but a label on the driver's door must show the old reading and when the new one was installed.

## Trip Odometer



The trip odometer can tell you how far your vehicle has been driven since you last set the trip odometer to zero.

To set the trip odometer to zero, press the reset knob to the right of the trip odometer.

## Warning Lights, Gages and Indicators

This section describes the warning lights and gages that may be on your vehicle. The pictures will help you locate them.

Warning lights and gages can signal that something is wrong before it becomes serious enough to cause an expensive repair or replacement. Paying attention to your warning lights and gages could also save you or others from injury.

Warning lights go on when there may be or is a problem with one of your vehicle's functions. As you will see in the details on the next few pages, some warning lights come on briefly when you turn the ignition key just to let you know they're working. If you are familiar with this section, you should not be alarmed when this happens.

Gages can indicate when there may be or is a problem with one of your vehicle's functions. Often gages and warning lights work together to let you know when there's a problem with your vehicle.

When one of the warning lights comes on and stays on when you are driving, or when one of the gages shows there may be a problem, check the section that tells you what to do about it. Please follow the manual's advice. Waiting to do repairs can be costly—and even dangerous. So please get to know your warning lights and gages. They're a big help.



## Fuel Gage



Your fuel gage tells you about how much fuel you have left, when the ignition is on. When the indicator nears “E” (Empty), you still have a little fuel left, but you should get more soon.

Here are four things that some owners ask about. None of these show a problem with your fuel gage and are normal operating characteristics:

- At the service station, the gas pump shuts off before the gage reads “F” (Full).
- It takes a little more or less fuel to fill up than the gage indicated. For example, the gage may have indicated

the tank was half full, but it actually took a little more or less than half the tank’s capacity to fill the tank.

- The gage moves a little when you turn a corner, speed up or brake.
- The gage doesn’t go back to “E” when you turn off the ignition.

## Engine Oil Pressure Light



If you have a problem with your oil, this light may stay on after you start your engine, or come on when you are driving. This indicates that oil is not going through your engine quickly enough to keep it lubricated. The engine could be low on oil, or could have some other oil problem. Have it fixed right away.

The oil light could also come on in three other situations:

- When the ignition is on but the engine is not running, the light will come on as a test to show you it is working, but the light will go out when you turn the ignition to “Start.” If it doesn’t come on with the

ignition on, you may have a problem with the fuse or bulb. Have it fixed right away.

- Sometimes when the engine is idling at a stop, the light may blink on and off. This is normal.
- If you make a hard stop, the light may come on for a moment. This is normal.

### CAUTION:

**Don't keep driving if the oil pressure is low. If you do, your engine can become so hot that it catches fire. You or others could be burned. Check your oil as soon as possible and have your vehicle serviced.**

### NOTICE:

**Damage to your engine from neglected oil problems can be costly and is not covered by your warranty.**

## Battery Light



The battery warning light will come on briefly when you turn on the ignition, but the engine is not running, as a check to show you it is working. Then it should go out. If it stays on, or comes on while you are driving, you may have a problem with the electrical charging system. It could indicate that you have a loose generator drive belt or another electrical

problem. Have it checked right away. Driving while this light is on could drain your battery.

If you must drive a short distance with the light on, be certain to turn off all your accessories, such as the radio and air conditioner.

## Volts Gage (Option)



When your engine is not running, but the ignition is on (in the "Run" position), the gage shows your battery's state of charge in DC volts. When the engine is running, the gage shows the condition of the charging system. Readings between the red warning zones indicate the normal operating range.

Readings in either red warning zone indicate a possible problem in the electrical system. Have your vehicle serviced immediately.

## Brake System Warning Light



Your Buick's hydraulic brake system is divided into two parts. If one part isn't working, the other part can still work and stop you. For good braking, though, you need both parts working well. If the warning light goes on, there could be a brake problem. Have your brake system inspected right away.

This light should come on as you start the vehicle. If it doesn't come on then, have it fixed so it will be ready to warn you if there's a problem.

This light will also come on when you set your parking brake, and will stay on if your parking brake doesn't release fully. If it stays on after your parking brake is fully released, it means you have a brake problem.

If the light comes on while driving, pull off the road and stop carefully. You may notice that the pedal is harder to push. Or, the pedal may go closer to the floor. It may take longer to stop. If the light is still on, have the vehicle towed for service. (See "Towing Your Buick" in the Index.)



## CAUTION:

Your brake system may not be working properly if the brake warning light is on. Driving with the brake warning light on can lead to an accident. If the light is still on after you've pulled off the road and stopped carefully, have the vehicle towed for service.

## Engine Coolant Temperature Warning Light



This light tells you that your engine coolant has overheated or your radiator cooling fan is not working. If you have been operating your vehicle under normal driving conditions, you should pull off the road, stop your vehicle and turn the engine off as soon as possible.

**HOT COOLANT CAN BURN YOU BADLY!**

In "Problems on the Road," this manual shows what to do. See "Engine Overheating" in the Index.

## Engine Coolant Temperature Gage (Option)



If you have the Gage Cluster, you have a gage that shows the engine coolant temperature. If the gage pointer moves into the red area, your engine is too hot! That reading means the same thing as the warning light. It means that your engine coolant has overheated. If you have been operating your vehicle under normal driving

conditions, you should pull off the road, stop your vehicle and turn off the engine as soon as possible.

Also, the temperature symbol on the gage will come on when your engine is too hot.

**HOT COOLANT CAN BURN YOU BADLY!**

In "Problems on the Road," this manual shows what to do. See "Engine Overheating" in the Index.

## Malfunction Indicator Lamp (Service Engine Soon Light)



A computer monitors operation of your fuel, ignition and emission control systems. This light should come on when the ignition is on, but the engine is not running, as a check to show you it is working. If it does not come on at all, have it fixed right away. If it stays on, or it comes on while you are driving, the computer is

indicating that you have a problem. You should take your vehicle in for service soon.

### **NOTICE:**

**If you keep driving your vehicle with this light on, after a while the emission controls won't work as well, your fuel economy won't be as good and your engine may not run as smoothly. This could lead to costly repairs not covered by your warranty.**

## Liftgate Ajar Warning Light (Wagon)



The "TAILGATE AJAR" light on your instrument panel will come on if your liftgate is not completely closed.







## Part 3 Comfort Controls and Audio Systems

In this part you'll find out how to operate the comfort control systems and audio systems offered with your Buick. Be sure to read about the particular system supplied with your vehicle.

### Part 3 includes:

Comfort Control System .....	114
Air Conditioner .....	114
Ventilation .....	115
Heater and Defroster .....	115
Rear Window Defogger .....	115
Audio Systems .....	116
Radio Controls .....	118
Tape Player Controls .....	120
CD Player Controls .....	123
Care of Cassette Tape Player & Tapes .....	129
Care of Compact Discs .....	130
Power Antenna Mast Care .....	131

## Your Buick Comfort Control System



The air conditioner and heater work best if you keep your windows closed while using them. Your vehicle also has the flow-through ventilation system described later in this section.

**Lever Controls:** The upper lever changes the functions of your system. The lower lever changes the temperature of the air coming through the system.

 : Selects the force of air you want.

To turn the fan off, move the upper lever to the **OFF** position.

## Air Conditioning

The upper lever has three air conditioner settings. On very hot days, open the windows long enough to let hot inside air escape. This reduces the amount of work your air conditioner's compressor will have to do, which should help fuel economy.

**MAX:** Provides maximum cooling with the least amount of work. This setting recirculates much of the air inside your vehicle so it maximizes your air conditioner's performance and fuel economy.

**NORM (Normal):** Use for normal cooling on hot days. This setting cools outside air and directs it through the instrument panel outlets.

**BI-LEV (Bi-Level):** Use this on cool, but sunny days. This setting brings in the outside air, but directs it in two ways. The cool air is directed to the upper portion of your body through the instrument panel outlets, but warmed air is directed through the heater ducts and defroster vents. At times this temperature difference may be more apparent than others.

The air conditioner compressor operates in all **AIR COND** positions, and in **DEF** (Defrost) when the outside temperature is above about 40°F (4.5°C).

## Ventilation

For mild outside temperatures, when little heating or cooling is needed, slide the upper lever to **VENT**. Air flow is through the instrument panel outlets. Rotate the control next to the outlets to turn on, adjust or turn off the air flow. Adjust the lower lever on the control panel to the temperature desired.

## Heating

When outside temperatures are cold, sliding the upper lever to **HEATER** and the lower lever to **HOT** will send heated air through the heater ducts, and some through the defroster vents. **VENT** and **HEATER** are labeled **ECONOMY** positions because the air conditioner compressor doesn't run in these two settings. This reduces engine load, resulting in improved fuel economy. If either setting fails to keep you comfortable, or causes your windows to fog up, slide the upper lever to one of the **AIR COND** positions, or to **DEF** (Defrost).

## Defrosting

The **DEF** setting directs most of the air through the defroster vents, and some through the heater ducts.

## Defogging Windows with Four Season Climate Control

To quickly defog the windshield, set the upper lever to **DEF** and move the fan switch to **HI**. Slide the lower lever to **HOT**.

In damp, cool weather (temperatures about 45°-65°F, 7°-18°C), you can use **BI-LEV** to defog the side windows. Set the upper lever to **BI-LEV** and the fan switch to **HI**. Aim the side vents toward the side windows. For increased air flow to the side vents, close the center vents.

## Rear Window Defogger (Option)



The rear window defogger uses a warming grid to remove fog from the rear window. In winter, it can also keep ice from forming on the rear window.

Press the **ON** portion of the switch. The indicator light will glow. The rear window defogger will turn off automatically after about 10 minutes of use. You can also turn it off by turning

off the ignition or pressing the **OFF** portion of the switch.



Do not attach a temporary vehicle license across the defogger grid on the rear window.

## NOTICE:

**Don't use a razor blade or something else sharp on the inside of the rear window. If you do, you could cut or damage the warming grid, and the repairs wouldn't be covered by your warranty.**

## Flow-Through Ventilation System

Your Buick's flow-through ventilation system supplies outside air into the vehicle when it is moving. Outside air will also enter the vehicle when the heater or the air conditioning fan is running.

### Ventilation Tips

- Keep the hood and front air inlet free of ice, snow, or any other obstruction (such as leaves). The heater and defroster will work far better, reducing the chance of fogging the inside of your windows.
- When you enter a vehicle in cold weather, turn the blower fan to **HI** for a few moments before driving off. This helps clear the intake ducts of snow and moisture, and reduces the chance of fogging the inside of your windows.

- Keep the air path under the front seats clear of objects. This helps air to circulate throughout your vehicle.

## Audio Systems

The following pages describe the audio systems available for your Buick, and how to get the best performance from them. Please read about the system in your vehicle.



## CAUTION:

**Hearing damage from loud noise is almost undetectable until it is too late. Your hearing can adapt to higher volumes of sound. Sound that seems normal can be loud and harmful to your hearing. Take precautions by adjusting the volume control on your radio to a safe sound level before your hearing adapts to it.**

**To help avoid hearing loss or damage:**

- 1. Adjust the volume control to the lowest setting.**
- 2. Increase volume slowly until you hear comfortably and clearly.**

## **NOTICE:**

**Before you add any sound equipment to your vehicle—like a tape player, CB radio, mobile telephone or two-way radio—be sure you can add what you want. If you can, it's very important to do it properly. Added sound equipment may interfere with the operation of your vehicle's engine, Delco® radio or other systems, and even damage them. And, your vehicle's systems may interfere with the operation of sound equipment that has been added improperly.**

**So, before adding sound equipment, check with your dealer and be sure to check Federal rules covering mobile radio and telephone units.**

## **FM Stereo**

FM Stereo will give you the best sound, but FM signals will reach only about 10 to 40 miles (16 to 65 km). Tall buildings or hills can interfere with FM signals, causing the sound to come and go.

## **AM**

The range for most AM stations is greater than for FM, especially at night. The longer range, however, can cause stations to interfere with each other. AM can also pick up noise from things like storms and power lines. To lower this noise, try reducing the treble level.

## **AM Stereo**

Your Delco® system may be able to receive C-Quam® stereo broadcasts. Many AM stations around the country use C-Quam® to produce stereo, though some do not. C-Quam® is a registered trademark of Motorola, Inc. If your Delco® system can get C-Quam® signals, your stereo indicator light will come on when you are receiving it.



## AM/FM Stereo Radio



The digital display indicates information on time or radio station frequency, the AM or FM radio band, whether the station is in stereo, and other radio functions.

**PWR (Power):** Press to turn the radio on and off when the ignition is on.

**Upper Knob (VOL):** This knob does two things:

- Rotate it to control the volume.
- When the ignition is off, press the knob to display the time.

**BAL (Balance):** The control ring behind the upper knob adjusts the left/right speaker balance.

**Lower Knob (TUNE):** This knob does two things:

- Rotate it to tune in radio stations.
- Press it to change between the AM and FM bands.

**FADE:** The control ring behind the lower knob adjusts the front/rear speaker balance.

**TREBLE:** Slide this lever up to increase treble, or down to decrease it. If a station is weak or noisy, reduce the treble.

**BASS:** Slide this lever up to increase bass, or down to decrease it.



**SCAN:** Press to listen for a few seconds to the next station on the AM or FM band; the scan will continue every few seconds until you press **SCAN** again to stop on a particular station.

**SEEK:** Each time you press **SEEK**, you will tune in the next station on the AM or FM radio band.

#### **To Set the Clock:**

1. With the radio on or off, press **SET**. The **SET** indicator will appear on the digital display for five seconds.
2. You must begin to set the clock to the correct hour and minute during those five seconds. Press and hold **SCAN** until the correct hour appears on the display.
3. Press and hold **SEEK** until the correct minute appears on the display.

#### **To Preset Radio Stations:**

1. Use the lower knob (**TUNE**) to tune in the station you want.
2. Press **SET**. The **SET** indicator will appear on the digital screen for five seconds.
3. While the **SET** indicator is displayed, press one of the four pushbuttons.
4. Repeat steps 1-3 for each of four AM and four FM stations.

Up to three additional stations on each band may be preset by "pairing" pushbuttons:

1. Tune in the desired station.
2. Press **SET**, and within five seconds press any two adjacent pushbuttons at the same time.
3. The station can be tuned in when the same two pushbuttons are pressed at the same time.

## AM/FM Stereo Radio with Cassette Player



The digital display indicates information on time or radio station frequency, the AM or FM radio band, whether the station is in stereo, and other radio functions.

**PWR (Power):** Press to turn the unit on and off when the ignition is on.

**Upper Knob (VOL):** This knob does three things:

- Rotate it to control the volume.
- When the ignition is off, press the knob to display the time.
- When a tape is playing, press the knob to hear the other side of the tape.

**BAL (Balance):** The control ring behind the upper knob adjusts the left/right speaker balance.

**Lower Knob (TUNE):** This knob does two things:

- Rotate it to tune in radio stations.
- Press it to change between the AM and FM bands.

**FADE:** The control ring behind the lower knob adjusts the front/rear speaker balance.

**TREBLE:** Slide this lever up to increase treble, or down to decrease it. If a station is weak or noisy, reduce the treble.

**BASS:** Slide this lever up to increase bass, or down to decrease it.

**SCAN:** Press to listen for a few seconds to the next station on the AM or FM band; the scan will continue every few seconds until you press **SCAN** again to stop on a particular station.

**SEEK:** Each time you press **SEEK**, you will tune in the next station on the AM or FM radio band.

### To Set the Clock:

1. With the radio on or off, press **SET**. The **SET** indicator will appear on the digital display for five seconds.
2. You must begin to set the clock to the correct hour and minute during those five seconds. Press and hold **SCAN** until the correct hour appears on the display.
3. Press and hold **SEEK** until the correct minute appears on the display.

### To Preset Radio Stations:

1. Use the lower knob (**TUNE**) to tune in the station you want.
2. Press **SET**. The **SET** indicator will appear on the digital screen for five seconds.
3. While the **SET** indicator is displayed, press one of the five pushbuttons.
4. Repeat steps 1-3 for each of five AM and five FM stations.

Up to three additional stations on each band may be preset by "pairing" pushbuttons:

1. Tune in the desired station.
2. Press **SET**, and within five seconds press any two adjacent pushbuttons at the same time.
3. The station can be tuned in when the same two pushbuttons are pressed at the same time.



**DNR® (Dynamic Noise Reduction):** Press this button to select the Dynamic Noise Reduction system that reduces background hiss on AM and FM radio broadcasts, as well as on cassette tapes.

It's recommended to keep the **DNR®** button depressed for all listening situations.

**To Play a Cassette Tape:**

With the power switch on, insert a tape into the cassette door. Using tapes that are longer than 90 minutes (45 minutes on each side) is not recommended.

When the right indicator arrow is lit, selections listed on the bottom side of the cassette are playing. When the left arrow is lit, selections listed on the top side of the cassette are playing. To change sides of the tape, press the upper control knob (**VOL**) while the cassette is playing. The tape player automatically begins playing the other side when it reaches the end of the tape.

► **(Fast Forward):** To rapidly advance the tape, press the button with the arrow pointing in the same direction the tape is playing. To stop fast forward, lightly press the **STOP-EJECT** button.

◄ **(Reverse):** To rapidly reverse the tape, press the button with the arrow pointing in the opposite direction the tape is playing. To stop reverse, lightly press the **STOP-EJECT** button.

**STOP-EJECT:** To stop playing a tape, fully press this button. The cassette will be partially ejected, and the radio will begin playing.

## AM/FM Stereo with Compact Disc Player



The digital display indicates information on time or radio station frequency, the AM or FM radio band, whether the station is in stereo, and other radio functions.

**PWR (Power):** Turns the unit on and off when the ignition is on.

**Upper Knob (VOL):** This knob does two things:

- Rotate it slightly to the left or right to control the volume.
- Press it to mute the radio or tape player. Press again to listen.

**Balance:** The control ring behind the upper knob adjusts the left/right speaker balance.

**Lower Knob (TUNE):** This knob does two things:

- Rotate it slightly to the left or right to tune in radio stations. If you hold it to the left or right, it will tune rapidly.
- Press to change between the AM and FM bands. The band you select will appear on the digital display.

**Fade:** The control ring behind the lower knob adjusts the front/rear speaker balance.

**◀SEEK▶:** Press to seek and stop on the next station higher or lower on the radio band.

**SCAN:** Press this button to listen to stations for a few seconds. Press it again to stop scanning.

**RCL (Recall):** Press to alternate the display between the time and station frequency. When the ignition is off, press to display the time.

**BASS:** Press this button up or down to increase or decrease the bass level. Press the center of the button for the factory preset level.

**TREB (Treble):** Press this button up or down to increase or decrease the treble level. Press the center of the button for the factory preset level. If a station is weak or noisy, reduce the treble.

#### **To Set the Clock:**

1. With the radio on or off, press **SET**. The **SET** indicator will appear on the digital display for five seconds.
2. Within those five seconds, press and hold **SCAN** until the correct hour appears on the display.
3. Before another five seconds pass, press and hold **◀SEEK** or **SEEK▶** until the correct minute appears on the display.



### To Preset Radio Stations:

The five pushbuttons at the lower right can be used to preset up to ten radio stations (five AM and five FM). The buttons have other uses when you are playing a compact disc.

1. Tune the digital display to the station you want.
2. Press **SET**. The **SET** indicator will appear on the digital screen for five seconds.
3. While the **SET** indicator is displayed, press one of the five pushbuttons.
4. Repeat steps 1-3 for each of five AM and five FM stations.

### To Play a Compact Disc:

Many of the controls for the radio also have functions for the compact disc player, as explained here.

Don't use mini-discs that are called singles. They won't eject. Use only full-size compact discs.

1. Press **PWR** to turn the radio on.
2. Insert a disc part-way into the slot, with the label side up. The player will pull it in. In a few seconds, the disc should play.

If the disc comes back out and/or **Err** appears on the display:

- The disc may be upside down.
- The disc may be dirty, scratched or wet.
- There may be too much moisture in the air (wait about one hour and try again).
- The player may be too hot, or the road may be too rough for the disc to play. As soon as things get back to normal, the disc should play.

While a disc is playing, the **CD** indicator is displayed on the digital screen, as is the clock.

**RCL (Recall):** Press once to see which track is playing. Press again within five seconds to see how long your selection has been playing. The track number also will be displayed when the volume is changed or a new track starts to play.

**COMP (Compression):** Depressing this button makes soft and loud passages more equal in volume. Press again to resume normal play.

**RDM (Random):** Press to play tracks in random, rather than sequential, order.

Press the button again to play tracks sequentially.

**REV (Reverse):** Press and hold to rapidly back up to a favorite passage. Release to resume playing.

**FWD (Fast Forward):** Press and hold to rapidly advance the disc. Release to resume playing.

**PREV (Previous):** Press to play a track again. If you hold or keep pressing the **PREV** button, the disc will keep backing up to previous tracks.

**NEXT:** Press when you want to hear the next track. If you hold or keep pressing the **NEXT** button, the disc will keep advancing to other tracks.

**SCAN:** Press this button to sample each track for approximately ten seconds. **SCAN** will continue until **SCAN** is pressed again or another button is pressed.

### **When Finished with the Compact Disc Player:**

If you press **PWR** or turn off the ignition, the disc will stay in the player and start again when you turn on the ignition or power switch. The disc will begin playing at the point where it had been stopped.

**ST/PL (Stop/Play):** Press to stop the disc player; the radio will play. Press again to play the disc (the player will start playing the disc where it was stopped earlier).

**EJCT (Eject):** Press to eject the disc; the radio will play. You can also eject the disc with the radio or ignition off.

### **CD Player Anti-Theft Feature**

Delco LOC II is a security feature for the compact disc player. It can be used or ignored. If ignored, the system plays normally. If it is used, your player won't be usable if it is ever stolen, because it will go to **LOC** mode any time battery power is removed. Until an **unLOC** code is entered, it will not turn on.

The instructions below tell you how to enter a secret code into the system. If your vehicle loses battery power for any reason, you must unlock the system with the secret code before the radio will turn on.

1. Write down any six-digit number and keep it in a safe place.
2. Turn the ignition to the "Accessory" or "Run" position.
3. Press the **PWR** button to turn the radio off.
4. Press the **1** and **4** buttons together. Hold them down until "--" shows on the display. You are ready to enter your secret code.



**NOTE:** If you allow more than 15 seconds between steps, you may have to start the procedure over at step 4.

5. Press **SET** and **000** will appear on the display.
6. Press the **SEEK▶** button to make the first number appear.
7. Rotate the **TUNE** knob right or left to make the last two numbers agree with your code.
8. Press the lower (**BAND**) knob and **000** will appear again. Now you are ready to enter the last three digits of your code.
9. Repeat steps 6 and 7 for the last three digits of your code.
10. Press the lower (**BAND**) knob and **rEP** will appear for five seconds and then **000** will appear.
11. Repeat steps 6 through 10. This time **SEC** will appear, indicating that the radio is secure.

#### **To Unlock the System After a Power Loss:**

When battery power is reapplied to a secured radio, the radio won't turn on and **LOC** will appear on the display. Enter your secret code as follows; pause no more than 15 seconds between steps.

1. Turn the ignition on. (Radio off.)
2. Press the **SET** button. The display will show **000**.
3. Enter the six digits of the code following steps 6-9 above. The display will show the numbers as entered.
4. Press the lower (**BAND**) knob and **SEC** appears, then the time, indicating that the disabling sequence was successful.

### Disabling the Anti-Theft System:

1. Press the **1** and **4** buttons together for five seconds with ignition on and radio power off. The display will show **SEC**, indicating the unit is in the secure mode.
2. Press the **SET** button. The display will show **000**.
3. Enter the first three digits of the code following step 6 of the preceding paragraphs. The display will show the numbers as entered.
4. Press the lower (**BAND**) knob. The radio will display **000**.
5. Enter the second three digits of the code. The display will show the numbers as entered.
6. Press the lower (**BAND**) knob. If the display shows "-- --," the disabling sequence was successful (the numbers matched the user-selected code or the factory back-up code) and the unit is in the **UNSECURED** mode. If the display shows **SEC**, the disabling sequence was unsuccessful and the numbers did not match either of the codes and the unit will remain in the **SECURED** mode.

### Care of Your Cassette Tape Player



A tape player that is not cleaned regularly can cause reduced sound quality, ruined cassettes, or a damaged mechanism. Cassette tapes should be stored in their cases away from contaminants, direct sunlight, and extreme heat. If they aren't, they may not operate properly or cause failure of the tape player.

Your tape player should be cleaned regularly each month or after every 15 hours of use. If you notice a reduction in sound quality, try a known good cassette to see if the tape or the tape player is at fault. If this other cassette has no improvement in sound quality, clean the tape player.

Clean your tape player with a wiping-action, non-abrasive cleaning cassette, and follow the directions provided with it.

Cassettes are subject to wear and the sound quality may degrade over time. Always make sure that the cassette tape is in good condition before you have the tape player serviced.

### Care of Your Compact Discs



Handle discs carefully. Store them in their original cases or other protective cases and away from direct sunlight and dust. If the surface of a disc is soiled, dampen a clean, soft cloth in a mild, neutral detergent solution and clean it, wiping from the center to the edge.

Be sure never to touch the signal surface when handling discs. Pick up discs by grasping the outer edges or the edge of the hole and the outer edge.

### Fixed Mast Antenna

The fixed mast antenna can withstand most car washes without being damaged. If the mast should ever become slightly bent, you can straighten it out by hand. If the mast is badly bent, as it might be by vandals, you should replace it.

Check every once in a while to be sure the mast is still tightened to the fender.



## Power Antenna Mast Care (Option)

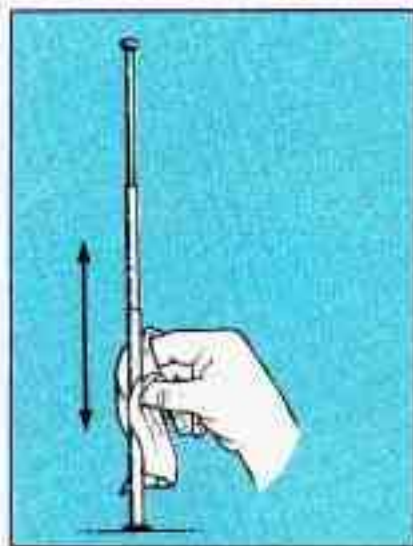

Your power antenna will look its best and work well if it's cleaned from time to time.

### To Clean the Antenna Mast:

1. Turn on the ignition and radio to raise the antenna to full mast extension.
2. Dampen a clean cloth with mineral spirits or equivalent solvent.
3. Wipe the cloth over the mast sections, removing any dirt.
4. Wipe dry with a clean cloth before retracting.
5. Make the antenna go up and down by turning the radio or ignition on and off.
6. Then repeat if necessary.

### NOTICE:

Don't lubricate the power antenna. Lubrication could damage it.

### NOTICE:

Before entering an automatic car wash, turn off your radio to make the power antenna go down. This will prevent the mast from possibly getting damaged. If the antenna does not go down when you turn the radio off, it may be damaged or need to be cleaned. In either case, lower the antenna by hand by carefully pressing the antenna down.





## Part 4 Your Driving and the Road

Here you'll find information about driving on different kinds of roads and in varying weather conditions. We've also included many other useful tips on driving.

### Part 4 includes:

Road Signs .....	134
Defensive Driving .....	142
Drunken Driving .....	143
Control of a Vehicle	
Braking .....	146
Steering Tips .....	150
Steering in Emergencies .....	151
Passing .....	152
Loss of Control .....	154
Driving at Night .....	155
Driving in the Rain .....	158
Driving in Fog, Mist and Haze .....	160
City Driving .....	162
Freeway Driving .....	163
Driving a Long Distance .....	164
Hill and Mountain Roads .....	166
Parking on Hills .....	168
Winter Driving .....	171
Towing a Trailer .....	175



## Road Signs

The road signs you see everywhere are coded by color, shape and symbols. It's a good idea to know these codes so that you can quickly grasp the basic meaning or intent of the sign even before you have a chance to read it.

### Color of Road Signs



STOP

DO NOT  
ENTER

WRONG  
WAY

**RED** means **STOP**. It may also indicate that some movement is not allowed. Examples are **DO NOT ENTER** and **WRONG WAY**.



RR ADVANCE  
CROSSING

NARROW  
BRIDGE

NO PASSING  
ZONE

**YELLOW** indicates a general warning. Slow down and be careful when you see a yellow sign. It may signal a railroad crossing ahead, a no passing zone, or some other potentially dangerous situation. Likewise, a yellow solid line painted on the road means "Don't Cross."



LOW  
SHOULDER

WORKERS  
AHEAD

FLAGGER  
AHEAD

**ORANGE** indicates road construction or maintenance. You'll want to slow down when you see an orange sign, as part of the road may be closed off or torn up. And there may be workers and maintenance vehicles around, too.



**GREEN** is used to guide the driver. Green signs may indicate upcoming freeway exits or show the direction you should turn to reach a particular place.



HOSPITAL INFORMATION

**BLUE** signs with white letters show motorists' services.



CANOEING SWIMMING

**BROWN** signs point out recreation areas or points of historic or cultural interest.



## Shape of Road Signs

The shape of the sign will tell you something, too.



An **OCTAGONAL** (eight-sided) sign means **STOP**. It is always red with white letters.



A **DIAMOND-SHAPED** sign is a warning of something ahead—for example, a curve, steep hill, soft shoulder, or a narrow bridge.



A **TRIANGLE**, pointed downward, indicates **YIELD**. It assigns the right-of-way to traffic on certain approaches to an intersection.



A **TRIANGULAR** sign also is used on two-lane roads to indicate a **NO PASSING ZONE**. This sign will be on the left side of the roadway.

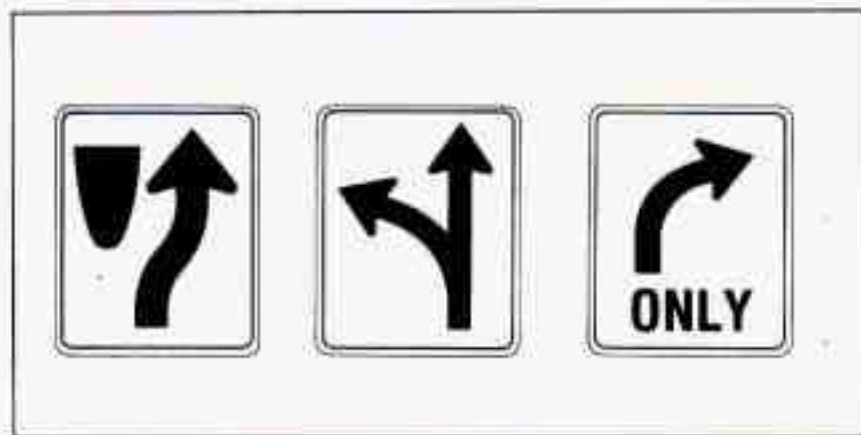

KEEP  
RIGHT

LEFT OR  
THROUGH

RIGHT TURN  
ONLY

**RECTANGULAR** (square or oblong) signs show speed limits, parking regulations, give directions, and such information as distances to cities.

## Symbols on Road Signs



There are many international road signs in use today.





NO U  
TURN

NO  
PARKING

NO  
BICYCLES

The basic message of many of these signs is in pictures or graphic symbols. A picture within a circle with a diagonal line across it shows what **not** to do.

## Traffic Lights

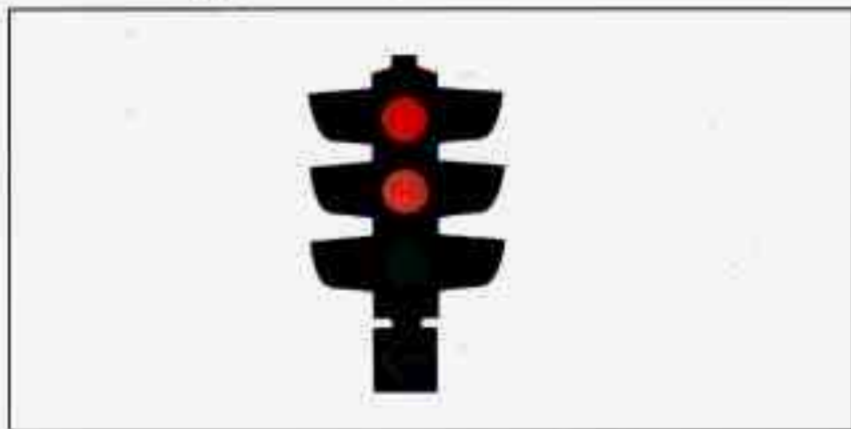

We're all familiar with traffic lights or stop lights. Often green arrows are being used in the lights for improved traffic control. On some multilane roads, green arrows light up, indicating that traffic in one or more lanes can move or make a turn. Green arrows don't mean "go no matter what." You'll still need to proceed with caution, yielding the right of way to pedestrians and sometimes to other vehicles.

Some traffic lights also use red arrows to signify that you must stop before turning on red.

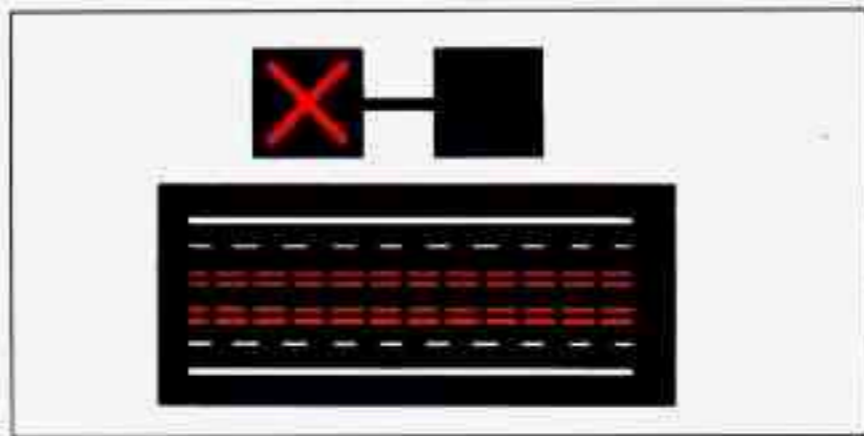

#### REVERSIBLE LANE ON MULTILANE ROADWAY

Many city roads and expressways, and even bridges, use reversible-lane traffic control during rush hours. A red X light above a lane means no driving in that lane at that time. A green arrow means you may drive in that lane. Look for the signs posted to warn drivers what hours and days these systems are in effect.

#### Pavement Markings

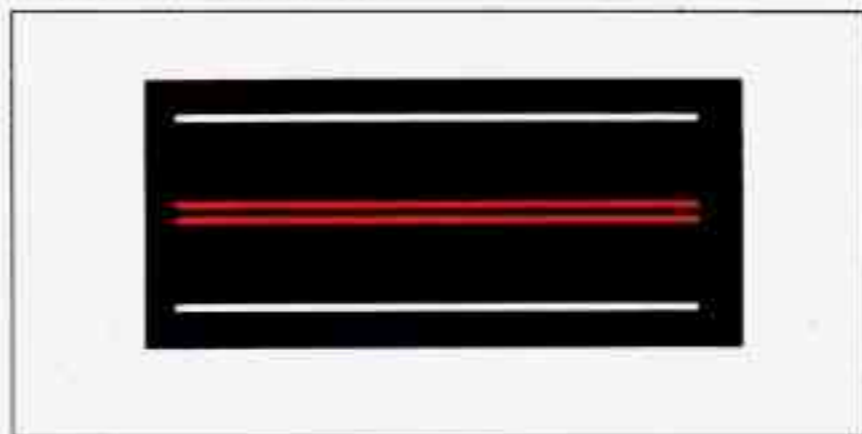

#### NO PASSING ZONE

Pavement markings add to traffic signs and signals. They give information to drivers without taking attention from the roadway. A solid yellow line on your side of the road or lane means "Don't Cross."

#### Your Own Signals

Drivers signal to others, too. It's not only more polite, it's safer to let other drivers know what you are doing. And in some places the law requires driver signals.

**Turn and lane change signals.** Always signal when you plan to turn or change lanes.

If necessary, you can use hand signals out the window: Left arm straight out for a left turn, down for slow or about-to-stop, and up for a right turn.

**Slowing down.** If time allows, tap the brake pedal once or twice in advance of slowing or stopping. This warns the driver behind you.

**Disabled.** Your four-way flashers signal that your vehicle is disabled or is a hazard. See “Hazard Warning Flashers” in the Index.

## Traffic Officer

The traffic police officer is also a source of important information. The officer’s signals govern, no matter what the traffic lights or other signs say.

The next section discusses some of the road conditions you may encounter.

## Defensive Driving

The best advice anyone can give about driving is: Drive defensively.

Please start with a very important safety device in your Buick: Buckle up. (See “Safety Belts” in the Index.)

Defensive driving really means “be ready for anything.” On city streets, rural roads, or freeways, it means “always expect the unexpected.”

Assume that pedestrians or other drivers are going to be careless and make mistakes. Anticipate what they might do. Be ready for their mistakes.

Expect children to dash out from behind parked cars, often followed by other children. Expect occupants in parked cars to open doors into traffic. Watch for movement in parked cars—someone may be about to open a door.

Expect other drivers to run stop signs when you are on a through street. Be ready to brake if necessary as you go through intersections. You may not have to use the brake, but if you do, you will be ready.

If you’re driving through a shopping center parking lot where there are well-marked lanes, directional arrows, and designated parking areas, expect some drivers to ignore all these markings and dash straight toward one part of the lot.

Pedestrians can be careless. Watch for them. In general, you must give way to pedestrians even if you know you have the right of way.

Rear-end collisions are about the most preventable of accidents. Yet they are common. Allow enough following distance. It’s the best defensive driving maneuver, in both city and rural driving. You never know when the vehicle in front of you is going to brake or turn suddenly.

Here’s a final bit of information about defensive driving. The most dangerous time for driving in the U.S. is very



early on Sunday morning. In fact, GM Research studies show that the most and the least dangerous times for driving, every week, fall on the same day. That day is Sunday. The most dangerous time is Sunday from 3 a.m. to 4 a.m. The safest time is Sunday from 10 a.m. to 11 a.m. Driving the same distance on a Sunday at 3 a.m. isn't just a little more dangerous than it is at 10 a.m. It's about 134 times more dangerous!

That leads to the next section.

## **Drunken Driving**

Death and injury associated with drinking and driving is a national tragedy. It's the number one contributor to the highway death toll, claiming thousands of victims every year. Alcohol takes away three things that anyone needs to drive a vehicle:

- Judgment
- Muscular Coordination
- Vision

Police records show that half of all motor vehicle-related deaths involve alcohol—a driver, a passenger or someone else, such as a pedestrian, had been drinking. In most cases, these deaths are the result of someone who was drinking and driving. Over 25,000 motor vehicle-related deaths occur each year because of alcohol, and thousands of people are injured.

Just how much alcohol is too much if a person plans to drive? Ideally, no one should drink alcohol and then drive. But if one does, then what's "too much"? It can be a lot less than many might think.

Although it depends on each person and situation, here is some general information on the problem.

The Blood Alcohol Content (BAC) of someone who is drinking depends upon four things:

- How much alcohol is in the drink.
- The drinker's body weight.
- The amount of food that is consumed before and during drinking.
- The length of time it has taken the drinker to consume the alcohol.



## DRINKING THAT WILL RESULT IN A BAC OF .05% IN THE TIME SHOWN

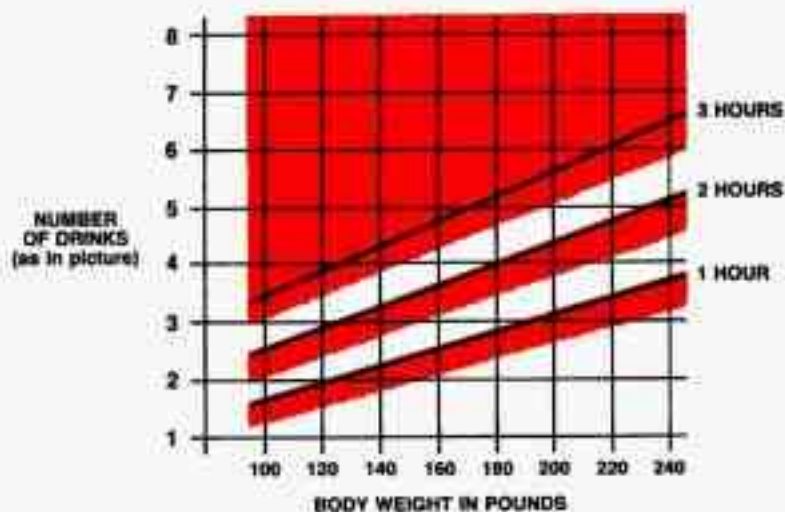

According to the American Medical Association, a 180-pound (82 kg) person who drinks three 12-ounce (355 ml) bottles of beer in an hour will end up with a BAC of about 0.06 percent. The person would reach the same BAC by drinking three 4-ounce (120 ml) glasses of wine or three mixed drinks if each had 1½ ounces (45 ml) of a liquor like whiskey, gin or vodka.

It's the amount of alcohol that counts. For example, if the same person drank three double martinis (3 ounces or 90 ml of liquor each) within an hour, the person's BAC would

be close to 0.12 percent. A person who consumes food just before or during drinking will have a slightly lower BAC level.

The law in most U.S. states sets the legal limit at a BAC of 0.10 percent. In Canada the limit is 0.08 percent, and in some other countries it's lower than that. The BAC will be over 0.10 percent after three to six drinks (in one hour).

Of course, as we've seen, it depends on how much alcohol is in the drinks, and how quickly the person drinks them.



But it's very important to keep in mind that the ability to drive is affected well below a BAC of 0.10 percent. Research shows that the driving skills of many people are impaired at a BAC approaching 0.05 percent, and that the effects are worse at night. All drivers are impaired at BAC levels above 0.05 percent. Statistics show that the chance of being in an accident increases sharply for drivers who have a BAC of 0.05 percent or above. A driver with a BAC level of 0.06 percent (three beers in one hour for a 180-pound or 82 kg person) has doubled his or her chance of having an accident. At a BAC level of 0.10 percent, the chance of that driver having an accident is six times greater; at a level of 0.15 percent, the chances are twenty-five times greater! And, the body takes about an hour to rid itself of the alcohol in one drink. No amount of coffee or number of cold showers will speed that up.

"I'll be careful" isn't the right answer. What if there's an emergency, a need to take sudden action, as when a child darts into the street? A person with a higher BAC might not be able to react quickly enough to avoid the collision.

There's something else about drinking and driving that many people don't know. Medical research shows that alcohol in a person's system can make crash injuries worse. That's especially true for brain, spinal cord and heart injuries. That means that if anyone who has been drinking—driver or passenger—is in a crash, the chance of being killed or permanently disabled is higher than if

that person had not been drinking. And we've already seen that the chance of a crash itself is higher for drinking drivers.



### **CAUTION:**

**Drinking and then driving is very dangerous. Your reflexes, perceptions, and judgment will be affected by even a small amount of alcohol. You could have a serious—or even fatal—accident if you drive after drinking. Please don't drink and drive or ride with a driver who has been drinking. Ride home in a cab; or if you're with a group, designate a driver who will not drink.**



## Control of a Vehicle



You have three systems that make your vehicle go where you want it to go. They are the brakes, the steering and the accelerator. All three systems have to do their work at the places where the tires meet the road.

Sometimes, as when you're driving on snow or ice, it's easy to ask more of those control systems than the tires and road can provide. That means you can lose control of your vehicle.

## Braking

Braking action involves **perception time** and **reaction time**.

First, you have to decide to push on the brake pedal. That's **perception time**. Then you have to bring up your foot and do it. That's **reaction time**.

Average **reaction time** is about  $\frac{3}{4}$  of a second. But that's only an average. It might be less with one driver and as long as two or three seconds or more with another. Age, physical condition, alertness, coordination and eyesight all play a part. So do alcohol, drugs and frustration. But even in  $\frac{3}{4}$  of a second, a vehicle moving at 60 mph (100 km/h) travels 66 feet (20 m). That could be a lot of distance in an emergency, so keeping enough space between your vehicle and others is important.

And, of course, actual stopping distances vary greatly with the surface of the road (whether it's pavement or gravel); the condition of the road (wet, dry, icy); tire tread; and the condition of your brakes.

Most drivers treat their brakes with care. Some, however, overwork the braking system with poor driving habits.

- Avoid needless heavy braking. Some people drive in spurts—heavy acceleration followed by heavy braking—rather than keeping pace with traffic. This is a mistake. Your brakes may not have time to cool between hard stops. Your brakes will wear out much faster if you do a lot of heavy braking.



- Don't "ride" the brakes by letting your left foot rest lightly on the brake pedal while driving.

**⚠ CAUTION:**

"Riding" your brakes can cause them to overheat to the point that they won't work well. You might not be able to stop your vehicle in time to avoid an accident. If you "ride" your brakes, they will get so hot they will require a lot of pedal force to slow you down. Avoid "riding" the brakes.

**NOTICE:**

"Riding" the brakes wears them out much faster. You would need costly brake replacement much sooner than normal, and it also reduces fuel economy.



If you keep pace with the traffic and allow realistic following distances, you will eliminate a lot of unnecessary braking. That means better braking and longer brake life.

- If your engine ever stops while you're driving, brake normally but don't pump your brakes. If you do, the pedal may get harder to push down. If your engine stops, you will still have some power brake assist. But you will use it when you brake. Once the power assist is used up, it may take longer to stop and the brake pedal will be harder to push.

### **Disc Brake Wear Indicators**

Your Buick has front disc brakes and rear drum brakes.

Disc brake pads have built-in wear indicators that make a high-pitched warning sound when the brake pads are worn and new pads are needed. The sound may come and go or be heard all the time your vehicle is moving (except when you are pushing on the brake pedal firmly).



### **CAUTION:**

**The brake wear warning sound means that sooner or later your brakes won't work well. That could lead to an accident. When you hear the brake wear warning sound, have your vehicle serviced.**

### **NOTICE:**

**Continuing to drive with worn-out brake pads could result in costly brake repair.**

Some driving conditions or climates may cause a brake squeal when the brakes are first applied or lightly applied. This does not mean something is wrong with your brakes.



## Rear Drum Brakes

Your rear drum brakes don't have wear indicators, but if you ever hear a rear brake rubbing noise, have the rear brake linings inspected. Also, the rear brake drums should be removed and inspected each time the tires are removed for rotation or changing. When you have the front brakes replaced, have the rear brakes inspected, too.

Brake linings should always be replaced as complete axle sets.

## Brake Pedal Travel

See your dealer if the brake pedal does not return to normal height, or if there is a rapid increase in pedal travel. This could be a sign of brake trouble.

## Brake Adjustment

Every time you make a moderate brake stop, your disc brakes adjust for wear. If you rarely make a moderate or heavier stop, then your brakes might not adjust correctly. If you drive in that way, then—very carefully—make a few moderate brake stops about every 1,000 miles (1 600 km), so your brakes will adjust properly.

If your brake pedal goes down farther than normal, your rear drum brakes may need adjustment. Adjust them by backing up and firmly applying the brakes a few times.

## Braking In Emergencies

At some time, nearly every driver gets into a situation that requires hard braking. Your first reaction—to hit the brake pedal hard and hold it down—may be the wrong thing to do. Your wheels can stop rolling. Once they do, the vehicle can't respond to your steering. Momentum will carry it in whatever direction it was headed when the wheels stopped rolling. That could be off the road, into the very thing you were trying to avoid, or into traffic.

Use a "squeeze" braking technique. This will give you maximum braking while maintaining steering control. You do this by pushing on the brake pedal with steadily increasing pressure.

In an emergency you will probably want to "squeeze" the brakes hard without locking the wheels. If you hear or feel the wheels sliding, ease off the brake pedal. This will help you retain steering control.

In many emergencies, steering can help you more than even the very best braking.

## Steering

### Power Steering

If you lose power steering assist because the engine stops or the system fails to function, you can steer but it will take much more effort.

## Steering Tips

### Driving on Curves

It's important to take curves at a reasonable speed.

A lot of the "driver lost control" accidents mentioned on the news happen on curves. Here's why:

Experienced driver or beginner, each of us is subject to the same laws of physics when driving on curves. The traction of the tires against the road surface makes it possible for the vehicle to change its path when you turn the front wheels. If there's no traction, inertia will keep the vehicle going in the same direction. If you've ever tried to steer a vehicle on wet ice, you'll understand this.

The traction you can get in a curve depends on the condition of your tires and the road surface, the angle at which the curve is banked, and your speed. While you're in a curve, speed is the one factor you can control.

Suppose you're steering through a sharp curve. Then you suddenly apply the brakes. Both control systems—steering and braking—have to do their work where the

tires meet the road. Adding the hard braking can demand too much at those places. You can lose control.

The same thing can happen if you're steering through a sharp curve and you suddenly accelerate. Those two control systems—steering and acceleration—can overwhelm those places where the tires meet the road and make you lose control.

What should you do if this ever happens? Let up on the brake or accelerator pedal, steer the vehicle the way you want it to go, and slow down.

Speed limit signs near curves warn that you should adjust your speed. Of course, the posted speeds are based on good weather and road conditions. Under less favorable conditions you'll want to go slower.

If you need to reduce your speed as you approach a curve, do it before you enter the curve, while your front wheels are straight ahead. Try to adjust your speed so you can "drive" through the curve. Maintain a reasonable, steady speed. Wait to accelerate until you are out of the curve, and then accelerate gently into the straightaway.

When you drive into a curve at night, it's harder to see the road ahead of you because it bends away from the straight beams of your lights. This is one good reason to drive slower.



## Steering in Emergencies



There are times when steering can be more effective than braking. For example, you come over a hill and find a truck stopped in your lane, or a car suddenly pulls out from nowhere, or a child darts out from between parked cars and stops right in front of you. You can avoid these problems by braking—if you can stop in time. But sometimes you can't; there isn't room. That's the time for evasive action—steering around the problem.

Your Buick can perform very well in emergencies like these. First apply your brakes, but not enough to lock your wheels. It is better to remove as much speed as you can from a possible collision. Then steer around the problem, to the left or right depending on the space available.

An emergency like this requires close attention and a quick decision. If you are holding the steering wheel at the recommended 9 and 3 o'clock positions, you can turn it a full 180 degrees very quickly without removing either hand. But you have to act fast, steer quickly, and just as quickly straighten the wheel once you have avoided the object. You must then be prepared to steer back to your original lane and then brake to a controlled stop.

Depending on your speed, this can be rather violent for an unprepared driver. This is one of the reasons driving experts recommend that you use your safety belts and keep both hands on the steering wheel.

The fact that such emergency situations are always possible is a good reason to practice defensive driving at all times.



## Off-Road Recovery

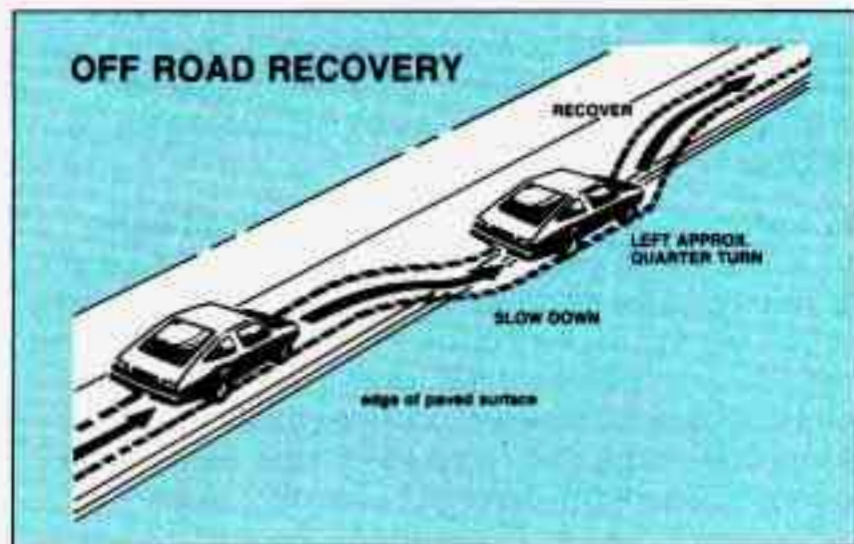

You may find sometime that your right wheels have dropped off the edge of a road onto the shoulder while you're driving.

If the level of the shoulder is only slightly below the pavement, recovery should be fairly easy. Ease off the accelerator and then, if there is nothing in the way, steer so that your vehicle straddles the edge of the pavement. You can turn the steering wheel up to  $\frac{1}{4}$  turn until the right front tire contacts the pavement edge. Then turn your steering wheel to go straight down the roadway.

If the shoulder appears to be about four inches (100 mm) or more below the pavement, this difference can cause problems. If there is not enough room to pull entirely onto the shoulder and stop, then follow the same procedures. But if the right front tire scrubs against the side of the pavement, do **NOT** steer more sharply. With too much steering angle, the vehicle may jump back onto the road with so much steering input that it crosses over into the oncoming traffic before you can bring it back under control.

Instead, ease off again on the accelerator and steering input, straddle the pavement once more, then try again.

## Passing

The driver of a vehicle about to pass another on a two-lane highway waits for just the right moment, accelerates, moves around the vehicle ahead, then goes back into the right lane again. A simple maneuver?

Not necessarily! Passing another vehicle on a two-lane highway is a potentially dangerous move, since the passing vehicle occupies the same lane as oncoming traffic for several seconds. A miscalculation, an error in judgment, or a brief surrender to frustration or anger can suddenly put the passing driver face to face with the worst of all traffic accidents—the head-on collision.

So here are some tips for passing:

- “Drive ahead.” Look down the road, to the sides, and to crossroads for situations that might affect your passing patterns. If you have any doubt whatsoever about making a successful pass, wait for a better time.
- Watch for traffic signs, pavement markings, and lines. If you can see a sign up ahead that might indicate a turn or an intersection, delay your pass. A broken center line usually indicates it’s all right to pass (providing the road ahead is clear). Never cross a solid line on your side of the lane or a double solid line, even if the road seems empty of approaching traffic.
- If you suspect that the driver of the vehicle you want to pass isn’t aware of your presence, tap the horn a couple of times before passing.
- Do not get too close to the vehicle you want to pass while you’re awaiting an opportunity. For one thing, following too closely reduces your area of vision, especially if you’re following a larger vehicle. Also, you won’t have adequate space if the vehicle ahead suddenly slows or stops. Keep back a reasonable distance.
- When it looks like a chance to pass is coming up, start to accelerate but stay in the right lane and don’t get too close. Time your move so you will be increasing speed as the time comes to move into the other lane. If the way is clear to pass, you will have a “running start” that more than makes up for the distance you would lose by dropping back. And if something happens to cause you to cancel your pass, you need only slow down and drop back again and wait for another opportunity.
- If other cars are lined up to pass a slow vehicle, wait your turn. But take care that someone isn’t trying to pass you as you pull out to pass the slow vehicle. Remember to glance over your shoulder and check the blind spot.
- Check your mirrors, glance over your shoulder, and start your left lane change signal before moving out of the right lane to pass. When you are far enough ahead of the passed vehicle to see its front in your inside mirror, activate your right lane change signal and move back into the right lane. (Remember that your right outside mirror is convex. The vehicle you just passed may seem to be farther away from you than it really is.)
- Try not to pass more than one vehicle at a time on two-lane roads. Reconsider before passing the next vehicle.



- Don't overtake a slowly moving vehicle too rapidly. Even though the brake lights are not flashing, it may be slowing down or starting to turn.
- If you're being passed, make it easy for the following driver to get ahead of you. Perhaps you can ease a little to the right.

## Loss of Control

Let's review what driving experts say about what happens when the three control systems (brakes, steering and acceleration) don't have enough friction where the tires meet the road to do what the driver has asked.

In any emergency, don't give up. Keep trying to steer and constantly seek an escape route or area of less danger.

## Skidding

In a skid, a driver can lose control of the vehicle. Defensive drivers avoid most skids by taking reasonable care suited to existing conditions, and by not "overdriving" those conditions. But skids are always possible.

The three types of skids correspond to your Buick's three control systems. In the braking skid your wheels aren't rolling. In the steering or cornering skid, too much speed or steering in a curve causes tires to slip and lose cornering force. And in the acceleration skid too much throttle causes the driving wheels to spin.

A cornering skid and an acceleration skid are best handled by easing your foot off the accelerator pedal. If your vehicle starts to slide (as when you turn a corner on a wet, snow- or ice-covered road), ease your foot off the accelerator pedal as soon as you feel the vehicle start to slide. Quickly steer the way you want the vehicle to go. If you start steering quickly enough, your vehicle will straighten out. As it does, straighten the front wheels.

Of course, traction is reduced when water, snow, ice, gravel, or other material is on the road. For safety, you'll want to slow down and adjust your driving to these conditions. It is important to slow down on slippery surfaces because stopping distance will be longer and vehicle control more limited.

While driving on a surface with reduced traction, try your best to avoid sudden steering, acceleration, or braking (including engine braking by shifting to a lower gear). Any sudden changes could cause the tires to slide. You may not realize the surface is slippery until your vehicle is skidding. Learn to recognize warning clues—such as enough water, ice or packed snow on the road to make a "mirrored surface"—and slow down when you have any doubt.



In a braking skid (where the wheels are no longer rolling), release enough pressure on the brakes to get the wheels rolling again. This restores steering control. Push the brake pedal down steadily when you have to stop suddenly. As long as the wheels are rolling, you will have steering control. Steer the way you want to go.

## Driving at Night



Night driving is more dangerous than day driving. One reason is that some drivers are likely to be impaired—by alcohol or drugs, with night vision problems, or by fatigue.

Here are some tips on night driving.

- Drive defensively. Remember, this is the most dangerous time.
- Don't drink and drive. (See "Drunken Driving" in the Index for more on this problem.)
- Adjust your inside rearview mirror to reduce the glare from headlights behind you.
- Since you can't see as well, you may need to slow down and keep more space between you and other vehicles. It's hard to tell how fast the vehicle ahead is going just by looking at its taillights.
- Slow down, especially on higher speed roads. Your headlights can light up only so much road ahead.
- In remote areas, watch for animals.
- If you're tired, pull off the road in a safe place and rest.

## Night Vision

No one can see as well at night as in the daytime, but as we get older these differences increase. A 50-year-old driver may require at least twice as much light to see the same thing at night as a 20-year-old.

What you do in the daytime can also affect your night vision. For example, if you spend the day in bright sunshine you are wise to wear sunglasses. Your eyes will have less trouble adjusting to night.

But if you're driving, don't wear sunglasses at night. They may cut down on glare from headlights, but they also make a lot of things invisible that should remain visible—such as parked cars, obstacles, pedestrians, or even trains blocking railway crossings. You may want to put on your sunglasses after you have pulled into a brightly-lighted service or refreshment area. Eyes shielded from that glare may adjust more quickly to darkness back on the road. But be sure to remove your sunglasses before you leave the service area.

You can be temporarily blinded by approaching lights. It can take a second or two, or even several seconds, for your eyes to readjust to the dark. When you are faced with severe glare (as from a driver who doesn't lower the high beams, or a vehicle with misaimed headlights) slow down a little. Avoid staring directly into the approaching lights. If there is a line of opposing traffic, make occasional glances over the line of headlights to make certain that one of the vehicles isn't starting to move into your lane. Once you are past the bright lights, give your eyes time to readjust before resuming speed.

## High Beams

If the vehicle approaching you has its high beams on, signal by flicking yours to high and then back to low beam. This is the usual signal to lower the headlight beams. If the other driver still doesn't lower the beams, resist the temptation to put your high beams on. This only makes two half-blinded drivers.

On a freeway, use your high beams only in remote areas where you won't impair approaching drivers. In some places, like cities, using high beams is illegal.

When you follow another vehicle on a freeway or highway, use low beams. True, most vehicles now have day-night mirrors that enable the driver to reduce glare. But outside mirrors are not of this type and high beams from behind can bother the driver ahead.

## A Few More Night Driving Suggestions

Keep your windshield and all the glass on your vehicle clean—inside and out. Glare at night is made much worse by dirt on the glass. Even the inside of the glass can build up a film caused by dust. Tobacco smoke also makes inside glass surfaces very filmy and can be a vision hazard if it's left there.

Dirty glass makes lights dazzle and flash more than clean glass would, making the pupils of your eyes contract repeatedly. You might even want to keep a cloth and some glass cleaner in your vehicle if you need to clean your glass frequently.

Remember that your headlights light up far less of a roadway when you are in a turn or curve.

Keep your eyes moving; that way, it's easier to pick out dimly lighted objects.

Just as your headlights should be checked regularly for proper aim, so should your eyes be examined regularly. Some drivers suffer from night blindness—the inability to see in dim light—and aren't even aware of it.



## Driving in the Rain



Rain and wet roads can mean driving trouble. On a wet road you can't stop, accelerate or turn as well because your tire-to-road traction isn't as good as on dry roads. And, if your tires don't have much tread left, you'll get even less traction.

It's always wise to go slower and be cautious if rain starts to fall while you are driving. The surface may get wet suddenly when your reflexes are tuned for driving on dry pavement.

The heavier the rain, the harder it is to see. Even if your windshield wiper blades are in good shape, a heavy rain can make it harder to see road signs and traffic signals, pavement markings, the edge of the road, and even people walking. Road spray can often be worse for vision than rain, especially if it comes from a dirty road.

So it is wise to keep your wiping equipment in good shape and keep your windshield washer tank filled. Replace your windshield wiper inserts when they show signs of streaking or missing areas on the windshield, or when strips of rubber start to separate from the inserts.



Driving too fast through large water puddles or even going through some car washes can cause problems, too. The water may affect your brakes. Try to avoid puddles. But if you can't, try to slow down before you hit them.

 **CAUTION:**

**Wet brakes can cause accidents. They won't work well in a quick stop and may cause pulling to one side. You could lose control of the vehicle.**

**After driving through a large puddle of water or a car wash, apply your brake pedal lightly until your brakes work normally.**

## Hydroplaning

Hydroplaning is dangerous. So much water can build up under your tires that they can actually ride on the water. This can happen if the road is wet enough and you're going fast enough. When your vehicle is hydroplaning, it has little or no contact with the road.

You might not be aware of hydroplaning. You could drive along for some time without realizing your tires aren't in constant contact with the road. You could find out the hard way: when you have to slow, turn, move out to pass—or if you get hit by a gust of wind. You could suddenly find yourself out of control.

Hydroplaning doesn't happen at higher speeds. But it can if your tires haven't much tread or if the pressure in one or more is low. It can happen if a lot of water is standing on the road. If you can see reflections from trees, telephone poles, or other vehicles, and raindrops "dimple" the water's surface, there could be hydroplaning.

Hydroplaning usually happens at higher speeds. There just isn't a hard and fast rule about hydroplaning. The best advice is to slow down when it is raining, and be careful.



## Some Other Rainy Weather Tips

- Turn on your headlights—not just your parking lights—to help make you more visible to others.
- Look for hard-to-see vehicles coming from behind. You may want to use your headlights even in daytime if it's raining hard.
- Besides slowing down, allow some extra following distance. And be especially careful when you pass another vehicle. Allow yourself more clear room ahead, and be prepared to have your view restricted by road spray. If the road spray is so heavy you are actually blinded, drop back. Don't pass until conditions improve. Going more slowly is better than having an accident.
- Use your defogger if it helps.
- Have good tires with proper tread depth. (See "Tires" in the Index.)

## Driving in Fog, Mist and Haze



Fog can occur with high humidity or heavy frost. It can be so mild that you can see through it for several hundred feet (meters). Or it might be so thick that you can see only a few feet (meters) ahead. It may come suddenly to an otherwise clear road. And it can be a major hazard.

When you drive into a fog patch, your visibility will be reduced quickly. The biggest dangers are striking the vehicle ahead or being struck by the one behind. Try to "read" the fog density down the road. If the vehicle



ahead starts to become less clear or, at night, if the taillights are harder to see, the fog is probably thickening. Slow down to give traffic behind you a chance to slow down. Everybody then has a better chance to avoid hitting the vehicle ahead.

A patch of dense fog may extend only for a few feet (meters) or for miles (kilometers); you can't really tell while you're in it. You can only treat the situation with extreme care.

One common fog condition—sometimes called mist or ground fog—can happen in weather that seems perfect, especially at night or in the early morning in valley and low, marshy areas. You can be suddenly enveloped in thick, wet haze that may even coat your windshield. You can often spot these fog patches or mist layers with your headlights. But sometimes they can be waiting for you as you come over a hill or dip into a shallow valley. Start your windshield wipers and washer, to help clear accumulated road dirt. Slow down carefully.

## **Tips on Driving in Fog**

If you get caught in fog, turn your headlights on low beam, even in daytime. You'll see—and be seen—better.

Don't use your high beams. The light will bounce off the water droplets that make up fog and reflect back at you.

Use your defogger. In high humidity, even a light buildup of moisture on the inside of the glass will cut down on your already limited visibility. Run your windshield wipers and washer occasionally. Moisture can build up on the outside glass, and what seems to be fog may actually be moisture on the outside of your windshield.

Treat dense fog as an emergency. Try to find a place to pull off the road. Of course you want to respect another's property, but you might need to put something between you and moving vehicles—space, trees, telephone poles, a private driveway, anything that removes you from other traffic.

If visibility is near zero and you must stop but are unsure whether you are away from the road, turn your lights on, start your hazard warning flashers, and sound your horn at intervals or when you hear approaching traffic.

Pass other vehicles in fog only if you can see far enough ahead to pass safely. Even then, be prepared to delay your pass if you suspect the fog is worse up ahead. If other vehicles try to pass you, make it easy for them.

## City Driving



One of the biggest problems with city streets is the amount of traffic on them. You'll want to watch out for what the other drivers are doing and pay attention to traffic signals.

Here are ways to increase your safety in city driving:

- Know the best way to get to where you are going. Try not to drive around trying to pick out a familiar street or landmark. Get a city map and plan your trip into an unknown part of the city just as you would for a cross-country trip.

- Try to use the freeways that rim and crisscross most large cities. You'll save time and energy. (See the next section, "Freeway Driving.")
- Treat a green light as a warning signal. A traffic light is there because the corner is busy enough to need it. When a light turns green, and just before you start to move, check both ways for vehicles that have not cleared the intersection or may be running the red light.
- Obey all posted speed limits. But remember that they are for ideal road, weather and visibility conditions. You may need to drive below the posted limit in bad weather or when visibility is especially poor.
- Pull to the right (with care) and stop clear of intersections when you see or hear emergency vehicles.



## Freeway Driving



Mile for mile, freeways (also called thruways, parkways, expressways, turnpikes, or superhighways) are the safest of all roads. But they have their own special rules.

The most important advice on freeway driving is: Keep up with traffic and keep to the right. Drive at the same speed most of the other drivers are driving. Too-fast or too-slow driving breaks a smooth traffic flow. Treat the left lane on a freeway as a passing lane.

## Entering the Freeway

At the entrance there is usually a ramp that leads to the freeway. If you have a clear view of the freeway as you drive along the entrance ramp, you should begin to check traffic. Try to determine where you expect to blend with the flow. If traffic is light, you may have no problem. But if it is heavy, find a gap as you move along the entering lane and time your approach. Try to merge into the gap at close to the prevailing speed. Switch on your turn signal, check your rearview mirrors as you move along, and glance over your shoulder as often as necessary. Try to blend smoothly with the traffic flow.

## Driving on the Freeway

Once you are on the freeway, adjust your speed to the posted limit or to the prevailing rate if it's slower. Stay in the right lane unless you want to pass. If you are on a two-lane freeway, treat the right lane as the slow lane and the left lane as the passing lane.

If you are on a three-lane freeway, treat the right lane as the slower-speed through lane, the middle lane as the higher-speed through lane, and the left lane as the passing lane.

Before changing lanes, check your rearview mirrors. Then use your turn signal. Just before you leave the lane, glance quickly over your shoulder to make sure there isn't another vehicle in your "blind" spot.



If you are moving from an outside to a center lane on a freeway having more than two lanes, make sure another vehicle isn't about to move into the same spot. Look at the vehicles two lanes over and watch for telltale signs: turn signals flashing, an increase in speed, or moving toward the edge of the lane. Be prepared to delay your move.

Once you are moving on the freeway, make certain you allow a reasonable following distance. Expect to move slightly slower at night.

### **Leaving the Freeway**

When you want to leave the freeway, move to the proper lane well in advance. Dashing across lanes at the last minute is dangerous. If you miss your exit do not, under any circumstances, stop and back up. Drive on to the next exit.

At each exit point is a deceleration lane. Ideally it should be long enough for you to enter it at freeway speed (after signaling, of course) and then do your braking before moving onto the exit ramp. Unfortunately, not all deceleration lanes are long enough—some are too short for all the braking. Decide when to start braking. If you must brake on the through lane, and if there is traffic close behind you, you can allow a little extra time and flash your brake lights (in addition to your turn signal) as extra warning that you are about to slow down and exit.

The exit ramp can be curved, sometimes quite sharply. The exit speed is usually posted. Reduce your speed according to your speedometer, not to your sense of motion. After driving for any distance at higher speeds, you may tend to think you are going slower than you actually are. For example, 40 mph (65 km/h) might seem like only 20 mph (30 km/h). Obviously, this could lead to serious trouble on a ramp designed for 20 mph (30 km/h)!

### **Driving a Long Distance**

Although most long trips today are made on freeways, there are still many made on regular highways.

Long-distance driving on freeways and regular highways is the same in some ways. The trip has to be planned and the vehicle prepared, you drive at higher-than-city speeds, and there are longer turns behind the wheel. You'll enjoy your trip more if you and your vehicle are in good shape. Here are some tips for a successful long trip.

### **Before Leaving on a Long Trip**

Make sure you're ready. Try to be well rested. If you must start when you're not fresh—such as after a day's work—don't plan to make too many miles that first part of the journey. Wear comfortable clothing and shoes you can easily drive in.

Is your vehicle ready for a long trip? If you keep it serviced and maintained, it's ready to go. If it needs service, have it done before starting out. Of course, you'll find experienced and able service experts in Buick dealerships all across North America. They'll be ready and willing to help if you need it.

Here are some things you can check before a trip:

- **Windshield Washer Fluid:** Is the reservoir full? Are all windows clean inside and outside?
- **Wiper Blades:** Are they in good shape?
- **Fuel, Engine Oil, Other Fluids:** Have you checked all levels?
- **Lights:** Are they all working? Are the lenses clean?
- **Tires:** They are vitally important to a safe, trouble-free trip. Is the tread good enough for long-distance driving? Are the tires all inflated to the recommended pressure?
- **Weather Forecasts:** What's the weather outlook along your route? Should you delay your trip a short time to avoid a major storm system?
- **Maps:** Do you have up-to-date maps?

## On the Road

Unless you are the only driver, it is good to share the driving task with others. Limit turns behind the wheel to about 100 miles (160 km) or two hours at a sitting. Then, either change drivers or stop for some refreshment like coffee, tea or soft drinks and some limbering up. But do stop and move around. Eat lightly along the way. Heavier meals tend to make some people sleepy.

On two-lane highways or undivided multilane highways that do not have controlled access, you'll want to watch for some situations not usually found on freeways. Examples are: stop signs and signals, shopping centers with direct access to the highway, no passing zones and school zones, vehicles turning left and right off the road, pedestrians, cyclists, parked vehicles, and even animals.

## Highway Hypnosis

Is there actually such a condition as "highway hypnosis"? Or is it just plain falling asleep at the wheel? Call it highway hypnosis, lack of awareness, or whatever.

There is something about an easy stretch of road with the same scenery, along with the hum of the tires on the road, the drone of the engine, and the rush of the wind against the vehicle that can make you sleepy. Don't let it happen to you! If it does, your vehicle can leave the road in **less than a second**, and you could crash and be injured.



What can you do about highway hypnosis? First, be aware that it can happen.

Then here are some tips:

- Make sure your vehicle is well ventilated, with a comfortably cool interior.
- Keep your eyes moving. Scan the road ahead and to the sides. Check your rearview mirrors frequently and your instruments from time to time. This can help you avoid a fixed stare.
- Wear good sunglasses in bright light. Glare can cause drowsiness. But don't wear sunglasses at night. They will drastically reduce your overall vision at the very time you need all the seeing power you have.
- If you get sleepy, pull off the road into a rest, service, or parking area and take a nap, get some exercise, or both. For safety, treat drowsiness on the highway as an emergency.

As in any driving situation, keep pace with traffic and allow adequate following distances.

## Hill and Mountain Roads



Driving on steep hills or mountains is different from driving in flat or rolling terrain. If you drive regularly in steep country, or if you're planning to visit there, here are some tips that can make your trips safer and more enjoyable.

- Keep your vehicle in good shape. Check all fluid levels and also the brakes, tires, cooling system and transaxle. These parts can work hard on mountain roads.



- Know how to go down hills. The most important thing to know is this: let your engine do some of the slowing down. Don't make your brakes do it all. Shift to a lower gear when you go down a steep or long hill.

That way, you will slow down without excessive use of your brakes.

 **CAUTION:**

If you don't shift down, your brakes could get so hot that they wouldn't work well. You would then have poor braking or even none going down a hill. You could crash. Shift down to let your engine assist your brakes on a steep downhill slope.

 **CAUTION:**

Coasting downhill in "N" (Neutral) or with the ignition off is dangerous. Your brakes will have to do all the work of slowing down. They could get so hot that they wouldn't work well. You could crash. Always have your engine running and your vehicle in gear when you go downhill.

- Know how to go uphill. You may want to shift down to a lower gear. The lower gears help cool your engine and transaxle, and you can climb the hill better.
- Stay in your own lane when driving on two-lane roads in hills or mountains. Don't swing wide or cut across the center of the road. Drive at speeds that let you stay in your own lane. That way, you won't be surprised by a vehicle coming toward you in the same lane.
- It takes longer to pass another vehicle when you're going uphill. You'll want to leave extra room to pass. If a vehicle is passing you and doesn't have enough room, slow down to make it easier for the other vehicle to get by.
- As you go over the top of a hill, be alert. There could be something in your lane, like a stalled car or an accident.
- You may see highway signs on mountains that warn of special problems. Examples are long grades, passing or no-passing zones, a falling rocks area, or winding roads. Be alert to these and take appropriate action.
- Winter driving can present special problems. See "Winter Driving" in the Index.

## Parking on Hills



Hills and mountains mean spectacular scenery. But please be careful where you stop if you decide to look at the view or take pictures. Look for pull-offs or parking areas provided for scenic viewing.

Another part of this manual tells how to use your parking brake (see "Parking Brake" in the Index). But on a mountain or steep hill, you can do one more thing. You can turn your front wheels to keep your vehicle from rolling downhill or out into traffic.

Here's how:

## Parking Downhill



Turn your wheels to the right.

You don't have to jam your tires against the curb, if there is a curb. A gentle contact is all you need.



## Parking Uphill



If there is a curb, turn your wheels to the left if the curb is at the right side of your vehicle.



If you're going uphill on a one-way street and you're parking on the left side, your wheels should point to the right.





If there is no curb when you're parking uphill, turn the wheels to the right.

If there is no curb when you're parking uphill on the left side of a one-way street, your wheels should be turned to the left.

## Torque Lock

If you are parking on a hill and you don't shift your transaxle into "P" (Park) properly, the weight of the vehicle may put too much force on the parking pawl in the transaxle. You may find it difficult to pull the shift lever out of "P" (Park). This is called "torque lock." To prevent torque lock, always be sure to shift into "P" (Park) properly before you leave the driver's seat. To find out how, see "Shifting Into 'P' (Park)" in the Index.

When you are ready to drive, move the shift lever out of "P" (Park) BEFORE you release the parking brake.

If "torque lock" does occur, you may need to have another vehicle push yours a little uphill to take some of the pressure from the transaxle, so you can pull the shift lever out of "P" (Park).

## Winter Driving



Here are some tips for winter driving:

- Have your Buick in good shape for winter. Be sure your engine coolant mix is correct.
- Snow tires can help in loose snow, but they may give you less traction on ice than regular tires. If you do not expect to be driving in deep snow, but may have to travel over ice, you may not want to switch to snow tires at all.
- You may want to put winter emergency supplies in your vehicle.



Include an ice scraper, a small brush or broom, a supply of windshield washer fluid, a rag, some winter outer clothing, a small shovel, a flashlight, a red cloth, and a couple of reflective warning triangles. And, if you will be driving under severe conditions, include a small bag of sand, a piece of old carpet or a couple of burlap bags to help provide traction. Be sure you properly secure these items in your vehicle.



## Driving on Snow or Ice

Most of the time, those places where your tires meet the road probably have good traction.

However, if there is snow or ice between your tires and the road, you can have a very slippery situation. You'll have a lot less traction or "grip" and will need to be very careful.



What's the worst time for this? "Wet ice." Very cold snow or ice can be slick and hard to drive on. But wet ice can be even more trouble because it may offer the least

traction of all. You can get "wet ice" when it's about freezing (32°F; 0°C) and freezing rain begins to fall. Try to avoid driving on wet ice until salt and sand crews can get there.

Whatever the condition—smooth ice, packed, blowing or loose snow—drive with caution. Accelerate gently. Try not to break the fragile traction. If you accelerate too fast, the drive wheels will spin and polish the surface under the tires even more. You'll want to brake very gently, too. Begin stopping sooner than you would on dry pavement. If you feel your vehicle begin to slide, let up on the brakes a little. Push the brake pedal down steadily to get the most traction you can.

Remember, if you brake so hard that your wheels stop rolling, you'll just slide. Brake so your wheels always keep rolling and you can still steer.

- Allow greater following distance on any slippery road.
- Watch for slippery spots. The road might be fine until you hit a spot that's covered with ice. On an otherwise clear road, ice patches may appear in shaded areas where the sun can't reach: around clumps of trees, behind buildings, or under bridges. Sometimes the surface of a curve or an overpass may remain icy when the surrounding roads are clear. If you see a patch of ice ahead of you, brake before you are on it. Try not to brake while you're actually on the ice, and avoid sudden steering maneuvers.



## If You're Caught in a Blizzard



If you are stopped by heavy snow, you could be in a serious situation. You should probably stay with your vehicle unless you know for sure that you are near help and you can hike through the snow. Here are some things to do to summon help and keep yourself and your passengers safe:

Turn on your hazard flashers. Tie a red cloth to your vehicle to alert police that you've been stopped by the snow. Put on extra clothing or wrap a blanket around

you. If you have no blankets or extra clothing, make body insulators from newspapers, burlap bags, rags, floor mats—anything you can wrap around yourself or tuck under your clothing to keep warm.

You can run the engine to keep warm, but be careful.



### **CAUTION:**

**Snow can trap exhaust gases under your vehicle. This can cause deadly CO (carbon monoxide) gas to get inside. CO could overcome you and kill you. You can't see it or smell it, so you might not know it is in your vehicle. Clear away snow from around the base of your vehicle, especially any that is blocking your exhaust pipe. And check around again from time to time to be sure snow doesn't collect there.**

**CAUTION (Continued)**

### **CAUTION (Continued)**

**Open a window just a little on the side of the vehicle that's away from the wind. This will help keep CO out.**



Run your engine only as long as you must. This saves fuel. When you run the engine, make it go a little faster than just idle. That is, push the accelerator slightly. This uses less fuel for the heat that you get and it keeps the battery charged. You will need a well-charged battery to restart the vehicle, and possibly for signaling later on with your headlights. Let the heater run for awhile.

Then, shut the engine off and close the window almost all the way to preserve the heat. Start the engine again and repeat this only when you feel really uncomfortable from the cold. But do it as little as possible. Preserve the fuel as long as you can. To help keep warm, you can get out of the vehicle and do some fairly vigorous exercises every half hour or so until help comes.

### **If You're Stuck in Deep Snow**

This manual explains how to get the vehicle out of deep snow without damaging it. See "Rocking Your Vehicle" in the Index.



## Towing a Trailer



### CAUTION:

If you don't use the correct equipment and drive properly, you can lose control when you pull a trailer. For example, if the trailer is too heavy, the brakes may not work well—or even at all. You and your passengers could be seriously injured. Pull a trailer only if you have followed all the steps in this section.

### NOTICE:

Pulling a trailer improperly can damage your vehicle and result in costly repairs not covered by your warranty. To pull a trailer correctly, follow the advice in this section.

Your Buick can tow a trailer. To identify what the vehicle trailering capacity is for your vehicle, you should read the information in “Weight of the Trailer” that appears later in this section. But trailering is different than just driving your vehicle by itself. Trailering means changes in handling, durability, and fuel economy. Successful, safe trailering takes correct equipment, and it has to be used properly.

That's the reason for this section. In it are many time-tested, important trailering tips and safety rules. Many of these are important for your safety and that of your passengers. So please read this section carefully before you pull a trailer.

Load-pulling components such as the engine, transaxle, wheel assemblies, and tires are forced to work harder against the drag of the added weight. The engine is required to operate at relatively higher speeds and under greater loads, generating extra heat. What's more, the trailer adds considerably to wind resistance, increasing the pulling requirements.

All of that means changes in:

- Handling
- Durability
- Fuel economy



## **If You Do Decide to Pull a Trailer**

If you do, here are some important points.

- There are many different laws having to do with trailering. Make sure your rig will be legal, not only where you live but also where you'll be driving. A good source for this information can be state or provincial police.
- You can ask a hitch dealer about sway controls.
- Don't tow a trailer at all during the first 500 miles (800 km) your new vehicle is driven. Your engine, axle or other parts could be damaged.
- Then, during the first 500 miles (800 km) that you tow a trailer, don't drive over 50 mph (80 km/h) and don't make starts at full throttle. This helps your engine and other parts of your vehicle wear in at the heavier loads.
- Three important considerations have to do with weight:

## **Weight of the Trailer**

Your vehicle can tow normally up to 1,000 pounds (450 kg). If your vehicle has a V6 engine with a four-speed automatic transaxle and is equipped with the optional heavy-duty engine cooling system, it can tow up to 2,000 pounds (900 kg).

But even that can be too heavy. It depends on how you plan to use your rig. For example, speed, altitude, road grades, outside temperature and how much your vehicle is used to pull a trailer are all important. And, it can also depend on any special equipment that you have on your vehicle. You can ask your dealer for our trailering information or advice, or you can write us at Buick Motor Division, Customer Assistance Center, 902 E. Hamilton Ave., Flint, MI 48550.

In Canada, write to General Motors of Canada Limited, Customer Assistance Center, 1908 Colonel Sam Drive, Oshawa, Ontario, L1H 8P7.

## Weight of the Trailer Tongue

The tongue load (A) of any trailer is an important weight to measure because it affects the total capacity weight of your vehicle. The capacity weight includes the curb weight of the vehicle, any cargo you may carry in it, and the people who will be riding in the vehicle. And if you will tow a trailer, you must subtract the tongue load from your vehicle's capacity weight because your vehicle will be carrying that weight, too. See "Loading Your Vehicle" in the Index for more information about your vehicle's maximum load capacity.

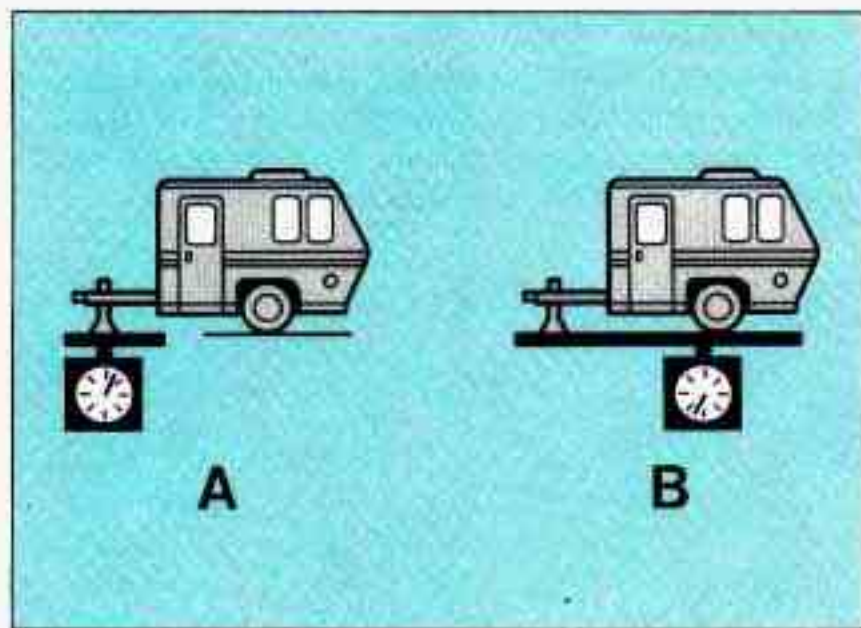

The trailer tongue (A) should weigh 10% of the total loaded trailer weight (B). After you've loaded your trailer, weigh the trailer and then the tongue, separately, to see if the weights are proper. If they aren't, you may be able to get them right simply by moving some items around in the trailer.

## Total Weight on Your Vehicle's Tires

Be sure your vehicle's tires are inflated to the limit for cold tires. You'll find these numbers on the Tire-Pressure Certification label at the rear edge of the driver's door (or see "Tire Loading" in the Index). Then be sure you don't go over the GVW limit for your vehicle.

## Hitches

It's important to have the correct hitch equipment. Crosswinds, large trucks going by, and rough roads are a few reasons why you'll need the right hitch. Here are some rules to follow:

- Will you have to make any holes in the body of your vehicle when you install a trailer hitch? If you do, then be sure to seal the holes later when you remove the



hitch. If you don't seal them, deadly carbon monoxide (CO) from your exhaust can get into your vehicle (see "Carbon Monoxide" in the Index). Dirt and water can, too.

- The bumpers on your vehicle are not intended for hitches. Do not attach rental hitches or other bumper-type hitches to them. Use only a frame-mounted hitch that does not attach to the bumper.

## Safety Chains

You should always attach chains between your vehicle and your trailer. Cross the safety chains under the tongue of the trailer so that the tongue will not drop to the road if it becomes separated from the hitch. Instructions about safety chains may be provided by the hitch manufacturer or by the trailer manufacturer. Follow the manufacturer's recommendation for attaching safety chains. Always leave just enough slack so you can turn with your rig. And, never allow safety chains to drag on the ground.

## Trailer Brakes

Does your trailer have its own brakes? Be sure to read and follow the instructions for the trailer brakes so you'll be able to install, adjust and maintain them properly.

- Don't tap into your vehicle's brake system if the trailer's brake system will use more than 0.02 cubic inch (0.3 cc) of fluid from your vehicle's master cylinder. If it does, both braking systems won't work well. You could even lose your brakes.
- Will the trailer brake parts take 3,000 psi (20 650 kPa) of pressure? If not, the trailer brake system must not be used with your vehicle.
- If everything checks out this far, then make the brake fluid tap at the upper rear master cylinder port. But don't use copper tubing for this. If you do, it will bend and finally break off. Use steel brake tubing.



## **Driving with a Trailer**

Towing a trailer requires a certain amount of experience. Before setting out for the open road, you'll want to get to know your rig. Acquaint yourself with the feel of handling and braking with the added weight of the trailer. And always keep in mind that the vehicle you are driving is now a good deal longer and not nearly so responsive as your vehicle is by itself.

Before you start, check the trailer hitch and platform, safety chains, electrical connector, lights, tires and mirror adjustment. If the trailer has electric brakes, start your vehicle and trailer moving and then apply the trailer brake controller by hand to be sure the brakes are working. This lets you check your electrical connection at the same time. During your trip, check occasionally to be sure that the load is secure, and that the lights and any trailer brakes are still working.

### **Following Distance**

Stay at least twice as far behind the vehicle ahead as you would when driving your vehicle without a trailer. This can help you avoid situations that require heavy braking and sudden turns.

### **Passing**

You'll need more passing distance up ahead when you're towing a trailer. And, because you're a good deal longer, you'll need to go much farther beyond the passed vehicle before you can return to your lane.

## **Backing Up**

Hold the bottom of the steering wheel with one hand. Then, to move the trailer to the left, just move that hand to the left. To move the trailer to the right, move your hand to the right. Always back up slowly and, if possible, have someone guide you.

## **Making Turns**

When you're turning with a trailer, make wider turns than normal. Do this so your trailer won't strike soft shoulders, curbs, road signs, trees, or other objects. Avoid jerky or sudden maneuvers. Signal well in advance.

## **Turn Signals When Towing a Trailer**

When you tow a trailer, your vehicle has to have a different turn signal flasher and extra wiring. The green arrows on your instrument panel will flash whenever you signal a turn or lane change. Properly hooked up, the trailer lights will also flash, telling other drivers you're about to turn, change lanes or stop.

When towing a trailer, the green arrows on your instrument panel will flash for turns even if the bulbs on the trailer are burned out. Thus, you may think drivers behind you are seeing your signal when they are not. It's important to check occasionally to be sure the trailer bulbs are still working.

## Driving on Grades

Reduce speed and shift to a lower gear **before** you start down a long or steep downgrade. If you don't shift down, you might have to use your brakes so much that they would get hot and no longer work well.

On a long uphill grade, shift down and reduce your speed to around 45 mph (70 km/h) to reduce the possibility of engine and transaxle overheating.

If you are towing a trailer that weighs more than 1,000 pounds (450 kg) and you have an automatic transaxle with Overdrive, you may prefer to drive in "D" instead of Overdrive.

## Parking on Hills

You really should not park your vehicle, with a trailer attached, on a hill. If something goes wrong, your rig could start to move. People can be injured, and both your vehicle and the trailer can be damaged.

But if you ever have to park your rig on a hill, here's how to do it:

1. Apply your regular brakes, but don't shift into "P" (Park) yet.
2. Have someone place chocks under the trailer wheels.
3. When the wheel chocks are in place, release the regular brakes until the chocks absorb the load.

4. Reapply the regular brakes. Then, apply your parking brake, and then shift to "P" (Park).

5. Release the regular brakes.

## When You are Ready to Leave After Parking on a Hill

1. Apply your regular brakes and hold the pedal down while you:
  - Start your engine;
  - Shift into a gear; and
  - Release the parking brake.
2. Let up on the brake pedal.
3. Drive slowly until the trailer is clear of the chocks.
4. Stop and have someone pick up and store the chocks.

## **Maintenance When Trailer Towing**

Your vehicle will need service more often when you're pulling a trailer. See the Maintenance Schedule for more on this. Things that are especially important in trailer operation are automatic transaxle fluid (don't overfill), engine oil, belt, cooling system, and brake adjustment. Each of these is covered in this manual, and the Index will help you find them quickly. If you're trailering, it's a good idea to review these sections before you start your trip.

Check periodically to see that all hitch nuts and bolts are tight.







## Part 5 Problems on the Road

Here you'll find what to do about some problems that can occur on the road.

**Part 5 includes:**

Hazard Warning Flashers .....	184
Other Warning Devices .....	185
Jump Starting .....	185
Towing Your Buick .....	189
Engine Overheating .....	195
If a Tire Goes Flat .....	205
Changing a Flat Tire .....	205
Compact Spare Tire .....	218
If You're Stuck: In Sand, Mud, Ice or Snow .....	219

## Hazard Warning Flashers



Your hazard warning flashers let you warn others. They also let police know you have a problem. Your front and rear turn signal lights will flash on and off.



Press the button in to make your front and rear turn signal lights flash on and off.

Your hazard warning flashers work no matter what position your key is in, and even if the key isn't in.



To turn off the flashers, pull out on the collar.

When the hazard warning flashers are on, your turn signals won't work.



## Other Warning Devices

If you carry reflective triangles, you can set one up at the side of the road about 300 feet (100 m) behind your vehicle.

## Jump Starting

If your battery has run down, you may want to use another vehicle and some jumper cables to start your Buick. But please follow the steps below to do it safely.



### CAUTION:

Batteries can hurt you. They can be dangerous because:

- They contain **acid** that can burn you.
- They contain **gas** that can explode or ignite.
- They contain enough **electricity** to burn you.

If you don't follow these steps exactly, some or all of these things can hurt you.

### NOTICE:

Ignoring these steps could result in costly damage to your vehicle that wouldn't be covered by your warranty.

Trying to start your Buick by pushing or pulling it won't work, and it could damage your vehicle.

### To Jump Start Your Buick:

1. Check the other vehicle. It must have a 12-volt battery with a negative ground system.

### NOTICE:

If the other system isn't a 12-volt system with a negative ground, both vehicles can be damaged.

2. Get the vehicles close enough so the jumper cables can reach, but be sure the vehicles aren't touching each other. If they are, it could cause a ground connection you don't want. You wouldn't be able to start your Buick, and the bad grounding could damage the electrical systems.

 **CAUTION:**

You could be injured if the vehicles roll. Set the parking brake firmly on each vehicle. Put an automatic transaxle in "P" (Park) or a manual transaxle in "N" (Neutral).

3. Turn off the ignition on both vehicles. Turn off all lights that aren't needed, and radios. This will avoid sparks and help save both batteries. And it could save your radio!

**NOTICE:**

If you leave your radio on, it could be badly damaged. The repairs wouldn't be covered by your warranty.

4. Open the hoods and locate the batteries.

 **CAUTION:**

An electric fan can start up even when the engine is not running and can injure you. Keep hands, clothing and tools away from any underhood electric fan.

Find the positive (+) and negative (-) terminals on each battery.

 **CAUTION:**

Using a match near a battery can cause battery gas to explode. People have been hurt doing this, and some have been blinded. Use a flashlight if you need more light.

Be sure the battery has enough water. You don't need to add water to the Delco Freedom® battery installed in every new GM vehicle. But if a battery has filler caps, be sure the right amount of fluid is there. If it is low, add water to take care of that first. If you don't, explosive gas could be present.

Battery fluid contains acid that can burn you. Don't get it on you. If you accidentally get it in your eyes or on your skin, flush the place with water and get medical help immediately.

5. Check that the jumper cables don't have loose or missing insulation. If they do, you could get a shock. The vehicles could be damaged, too.



Before you connect the cables, here are some basic things you should know. Positive (+) will go to positive (+) and negative (-) will go to negative (-) or a metal engine part. Don't connect (+) to (-) or you'll get a short that would damage the battery and maybe other parts, too.

**⚠ CAUTION:**

**Fans or other moving engine parts can injure you badly. Keep your hands away from moving parts once the engines are running.**



6. Connect the red positive (+) cable to the positive (+) terminal of the vehicle with the dead battery. Use a remote positive (+) terminal if the vehicle has one.





7. Don't let the other end touch metal. Connect it to the positive (+) terminal of the good battery. Use a remote positive (+) terminal if the vehicle has one.



8. Now connect the black negative (-) cable to the good battery's negative (-) terminal.

Don't let the other end touch anything until the next step. The other end of the negative cable **doesn't** go to the dead battery. It goes to a heavy unpainted metal part on the engine of the vehicle with the dead battery.

9. Attach the cable at least 18 inches (45 cm) away from the dead battery, but not near engine parts that move. The electrical connection is just as good there, but the chance of sparks getting back to the battery is much less.



10. Now start the vehicle with the good battery and run the engine for a while.
11. Try to start the vehicle with the dead battery.  
If it won't start after a few tries, it probably needs service.

12. Remove the cables in reverse order to prevent electrical shorting. Take care that they don't touch each other or any other metal.

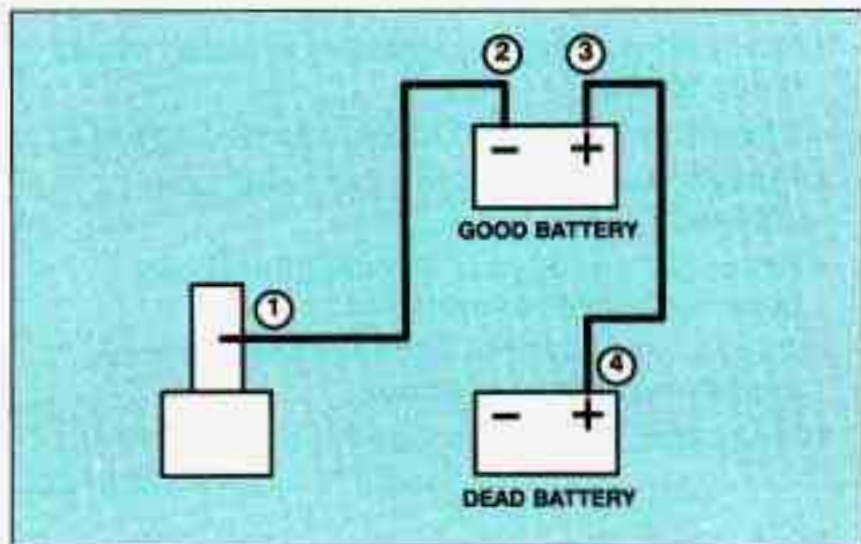

## Towing Your Buick

Try to have a GM dealer or a professional towing service tow your Buick. The usual towing equipment is a sling-type (A) or wheel-lift (B) or a car carrier (C) tow truck.

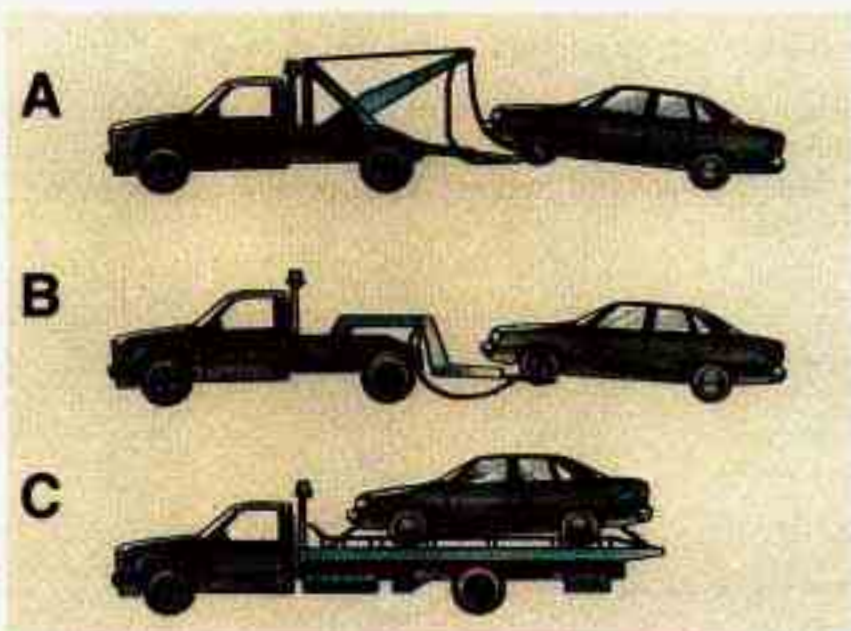

If your vehicle has been changed or modified since it was factory-new by adding aftermarket items like fog lamps, aero skirting, or special tires and wheels, these instructions and illustrations may not be correct.

Before you do anything, turn on the hazard warning flashers.

When you call, tell the towing service:

- That your vehicle has front-wheel drive.
- The make, model, and year of your vehicle.
- Whether you can still move the shift lever.
- If there was an accident, what was damaged.

When the towing service arrives, let the tow operator know that this manual contains detailed towing instructions and illustrations. The operator may want to see them.

 **CAUTION:**

To help avoid injury to you or others:

- Never let passengers ride in a vehicle that is being towed.
- Never tow faster than safe or posted speeds.
- Never tow with damaged parts not fully secured.
- Never get under your vehicle after it has been lifted by the tow truck.
- Always use separate safety chains on each side when towing a vehicle.
- Never use "J" hooks. Use T-hooks instead.





When your vehicle is being towed, have the ignition key off. The steering wheel should be clamped in a straight-ahead position, with a clamping device designed for towing service. Do not use the vehicle's steering column lock for this. The transaxle should be in Neutral and the parking brake released.

Don't have your vehicle towed on the front wheels, unless you must. If the vehicle must be towed on the front wheels, don't go more than 35 mph (56 km/h) or farther than 50 miles (80 km) or your transaxle will be damaged. If these limits must be exceeded, then the front wheels have to be supported on a dolly.

**⚠ CAUTION:**

**A vehicle can fall from a car carrier if it isn't properly secured. This can cause a collision, serious personal injury and vehicle damage. The vehicle should be tightly secured with chains or steel cables before it is transported.**

**Don't use substitutes (ropes, leather straps, canvas webbing, etc.) that can be cut by sharp edges underneath the towed vehicle.**

## Front Towing Hook-Ups

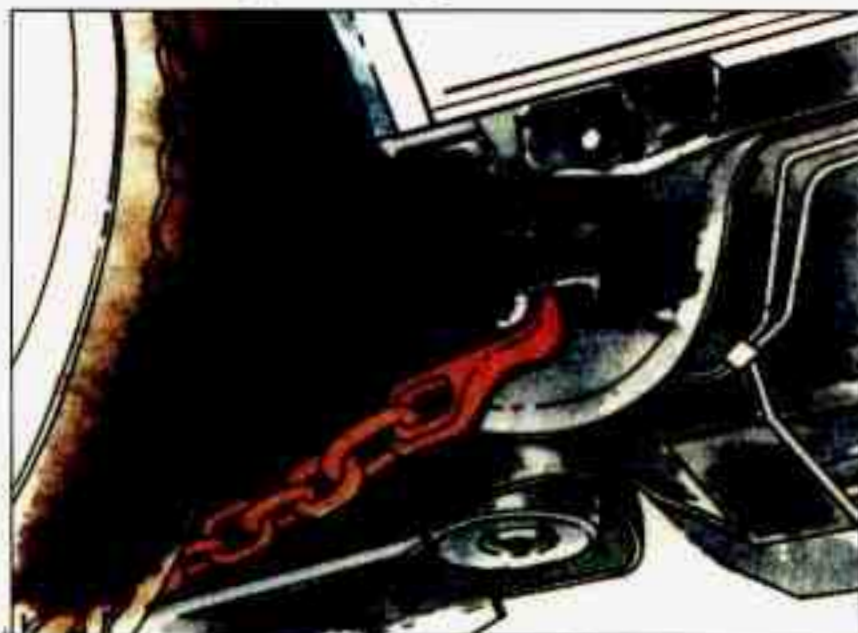

Before hooking up to a tow truck, be sure to read all the information in "Towing Your Buick" earlier in this part.

1. Attach T-hook chains behind the front wheels into the bottom of the floor pan on both sides.

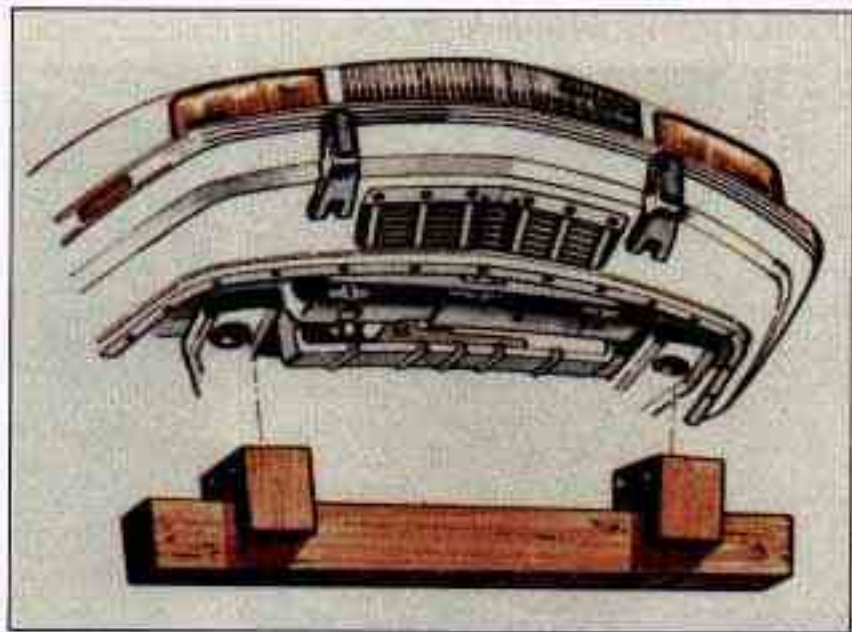

2. Position a 4" x 4" wood beam across sling chains with spacer blocks contacting the forward extensions of the engine cradle.

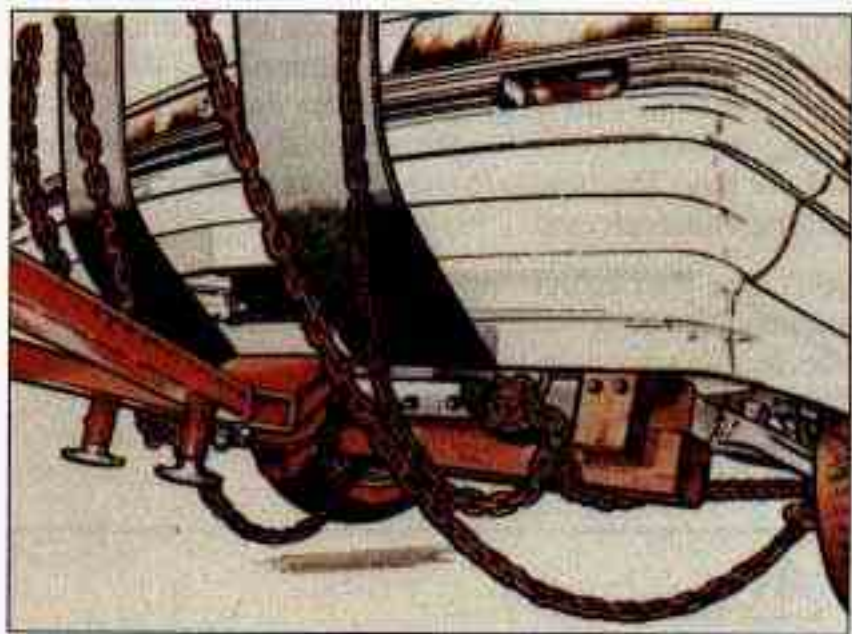

3. Position the lower sling crossbar halfway between the timber and the lower edge of the fascia.



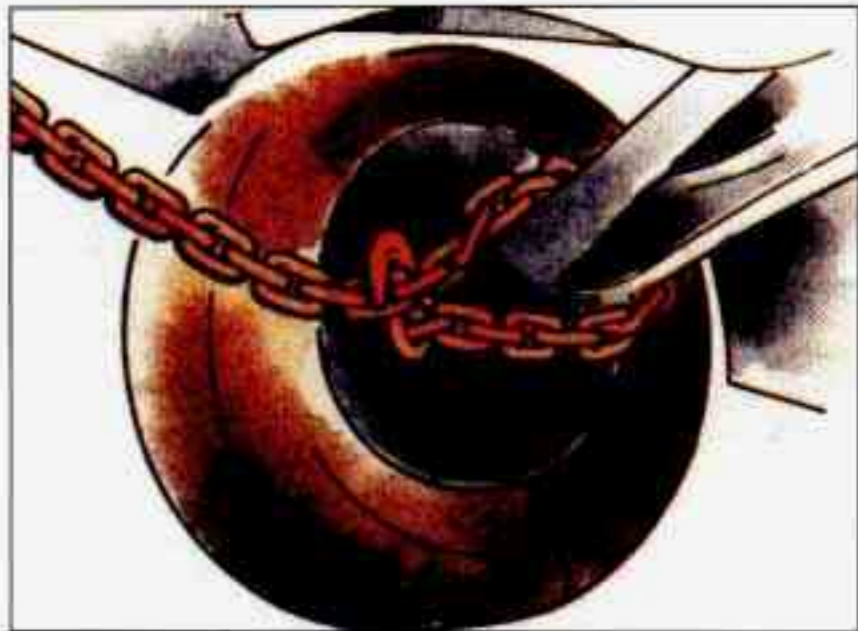

4. Attach a separate safety chain around the outboard end of each lower control arm.

## Rear Towing Hook-Ups

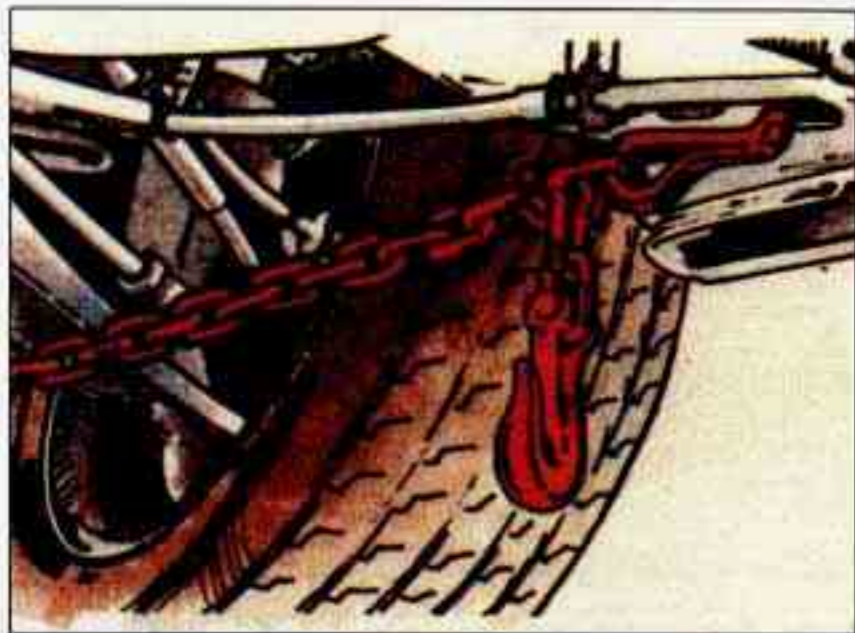

Before hooking up to a tow truck, be sure to read all the information in "Towing Your Buick" earlier in this part.

1. Attach T-hook chains on both sides in the slotted holes in the floor pan just ahead of the rear wheels.



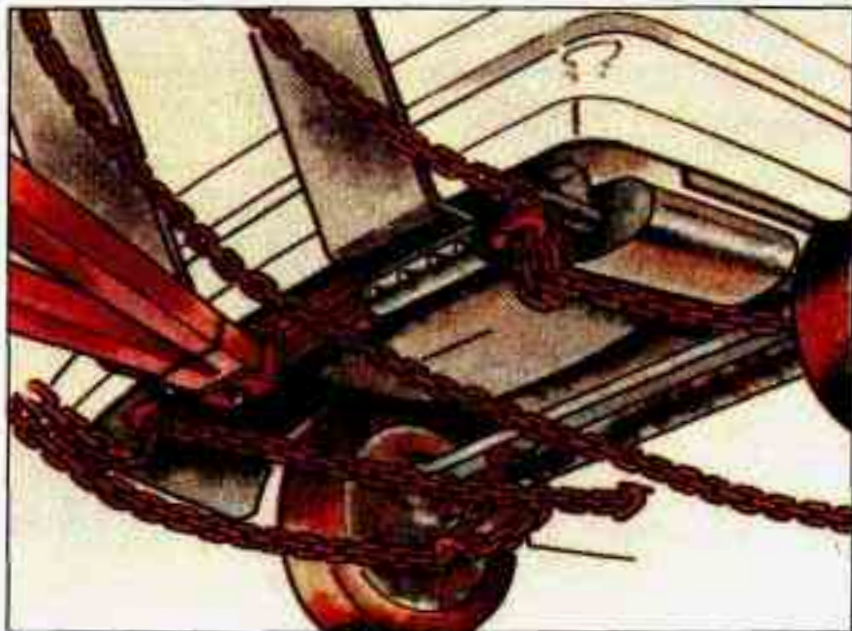

2. Position the lower sling crossbar directly under the rear bumper.

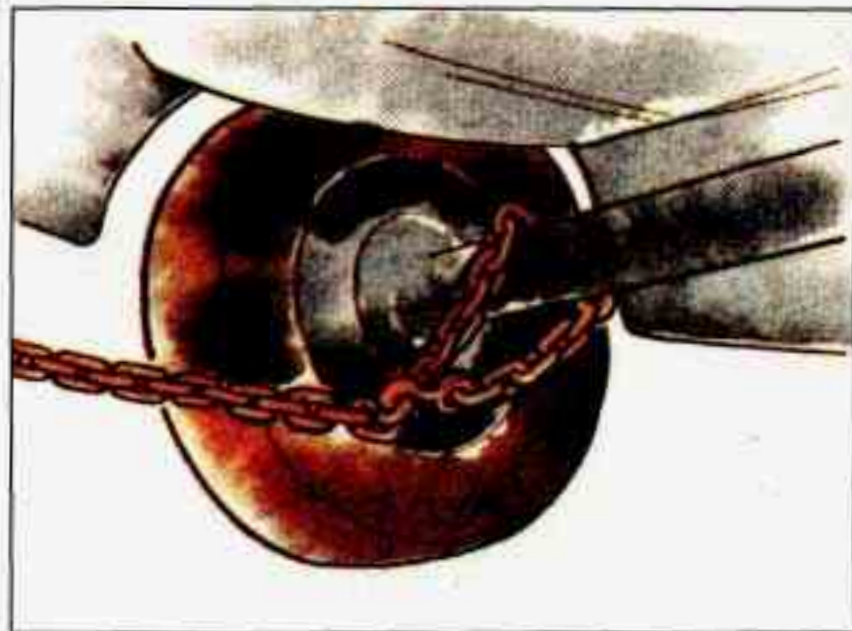

3. Attach a separate safety chain to each side of the axle inboard of the spring.
4. Be certain your vehicle is towed no faster than 35 mph (56 km/h) and no farther than 50 miles (80 km) to avoid damage to your transaxle.

## Engine Overheating

You will find a coolant temperature gage or the warning light about a hot engine on your Buick's instrument panel.

### If Steam Is Coming From Your Engine:



### CAUTION:

Steam from an overheated engine can burn you badly, even if you just open the hood. Stay away from the engine if you see or hear steam coming from it. Just turn it off and get everyone away from the vehicle until it cools down. Wait until there is no sign of steam or coolant before opening the hood.

If you keep driving when your engine is overheated, the liquids in it can catch fire. You or others could be badly burned. Stop your engine if it overheats, and get out of the vehicle until the engine is cool.

### NOTICE:

If your engine catches fire because you keep driving with no coolant, your vehicle can be badly damaged. The costly repairs would not be covered by your warranty.



## **If No Steam Is Coming From Your Engine:**

If you get the overheat warning but see or hear no steam, the problem may not be too serious. Sometimes the engine can get a little too hot when you:

- Climb a long hill on a hot day.
- Stop after high speed driving.
- Idle for long periods in traffic.
- Tow a trailer.

If you get the overheat warning with no sign of steam, try this for a minute or so:

1. Turn off your air conditioner.
2. Turn on your heater to full hot at the highest fan speed and open the window as necessary.
3. Try to keep your engine under load (in a drive gear where the engine runs slower).

If you no longer have the overheat warning, you can drive. Just to be safe, drive slower for about ten minutes. If the warning doesn't come back on, you can drive normally.

If the warning continues, pull over, stop, and park your vehicle right away.

If there's still no sign of steam, you can idle the engine for two or three minutes while you're parked, to see if the warning stops. But then, if you still have the warning, **TURN OFF THE ENGINE AND GET EVERYONE OUT OF THE VEHICLE** until it cools down.

You may decide not to lift the hood but to get service help right away.



## 2.2L L4 Cooling System

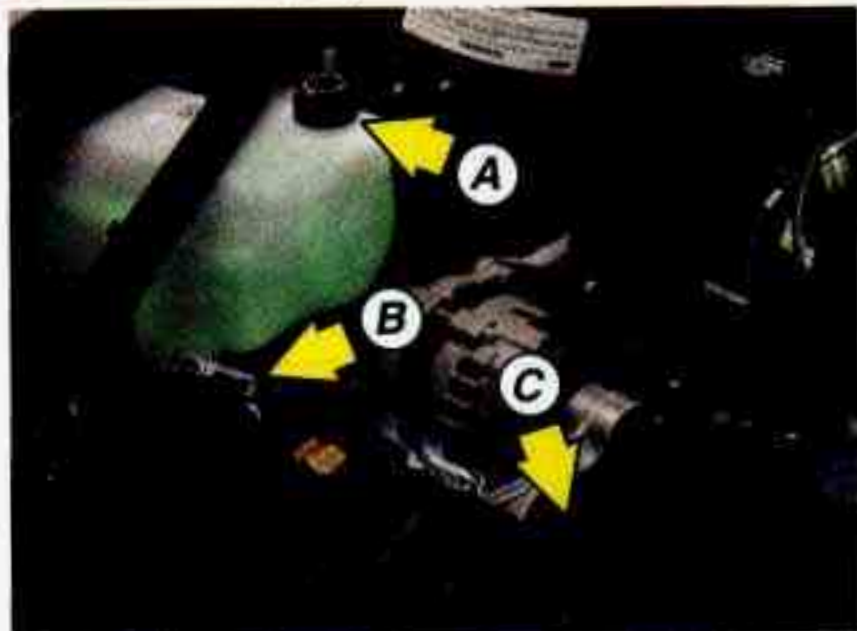

When you decide it's safe to lift the hood, here's what you'll see:

- (A) Coolant recovery tank
- (B) Radiator pressure cap
- (C) Electric engine fan



### CAUTION:

An electric fan under the hood can start up even when the engine is not running and can injure you. Keep hands, clothing and tools away from any underhood electric fan.

If the coolant inside the coolant recovery tank is boiling, don't do anything else until it cools down.



The coolant level should be at or above the “FULL HOT” mark.

If it isn't, you may have a leak in the radiator hoses, heater hoses, radiator, water pump or somewhere else in the cooling system.

## CAUTION:

Heater and radiator hoses, and other engine parts, can be very hot. Don't touch them. If you do, you can be burned.

Don't run the engine if there is a leak. If you run the engine, it could lose all coolant. That could cause an engine fire, and you could be burned. Get any leak fixed before you drive the vehicle.

## NOTICE:

Engine damage from running your engine without coolant isn't covered by your warranty.

If there seems to be no leak, check to see if the electric engine fan is running. If the engine is overheating, the fan should be running. If it isn't, your vehicle needs service.

**How to Add Coolant to the Coolant Recovery Tank**  
If you haven't found a problem yet, but the coolant level isn't at or above “ADD,” add a 50/50 mixture of **clean water** (preferably distilled) and a proper antifreeze at the coolant recovery tank. (See “Engine Coolant” in the Index for more information about the proper coolant mix.)

## 3300 V6 Cooling System

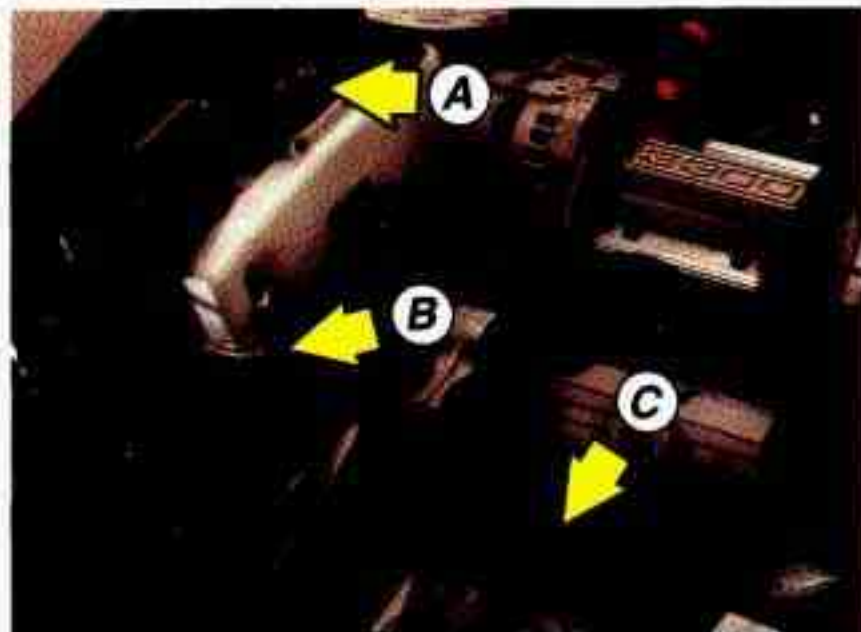

When you decide it's safe to lift the hood, here's what you'll see:

- (A) Coolant recovery tank
- (B) Radiator pressure cap
- (C) Electric engine fan



### CAUTION:

An electric fan under the hood can start up even when the engine is not running and can injure you. Keep hands, clothing and tools away from any underhood electric fan.

If the coolant inside the coolant recovery tank is boiling, don't do anything else until it cools down.





The coolant should be at or slightly above the “FULL HOT” mark. If it isn’t, you may have a leak in the radiator hoses, heater hoses, radiator, water pump or somewhere else in the cooling system.

**⚠ CAUTION:**

Heater and radiator hoses, and other engine parts, can be very hot. Don’t touch them. If you do, you can be burned.

Don’t run the engine if there is a leak. If you run the engine, it could lose all coolant. That could cause an engine fire, and you could be burned. Get any leak fixed before you drive the vehicle.

**NOTICE:**

Engine damage from running your engine without coolant isn’t covered by your warranty.

If there seems to be no leak, check to see if the electric engine fan is running. If the engine is overheating, the fan should be running. If it isn’t, your vehicle needs service.

**How to Add Coolant to the Coolant Recovery Tank**

If you haven’t found a problem yet, but the coolant level isn’t above “ADD,” add a 50/50 mixture of **clean water** (preferably distilled) and the proper antifreeze at the coolant recovery tank. (See “Engine Coolant” in the Index for more information about the proper coolant mix.)

## All Cooling Systems

### CAUTION:

Adding only plain water to your cooling system can be dangerous. Plain water, or some other liquid like alcohol, can boil before the proper coolant mix will. Your vehicle's coolant warning system is set for the proper coolant mix. With plain water or the wrong mix, your engine could get too hot but you wouldn't get the overheat warning. Your engine could catch fire and you or others could be burned. Use a 50/50 mix of clean water and a proper antifreeze.



### NOTICE:

In cold weather, water can freeze and crack the engine, radiator, heater core and other parts. Use the recommended coolant.

### CAUTION:

You can be burned if you spill coolant on hot engine parts. Coolant contains ethylene glycol and it will burn if the engine parts are hot enough. Don't spill coolant on a hot engine.



When the coolant in the coolant recovery tank is at or above the "FULL HOT" mark, start your vehicle. If the overheat warning continues, there's one more thing you can try. You can add the proper coolant mix directly to the radiator, but be sure the cooling system is cool before you do it.

 **CAUTION:**

Steam and scalding liquids from a hot cooling system can blow out and burn you badly. They are under pressure, and if you turn the radiator pressure cap—even a little—they can come out at high speed. Never turn the cap when the cooling system, including the radiator pressure cap, is hot. Wait for the cooling system and radiator pressure cap to cool if you ever have to turn the pressure cap.





## How to Add Coolant to the Radiator



1. You can remove the radiator pressure cap when the cooling system, including the radiator pressure cap and upper radiator hose, is no longer hot. Turn the pressure cap slowly to the left until it first stops. (Don't press down while turning the pressure cap.)

If you hear a hiss, wait for that to stop. A hiss

means there is still some pressure left.

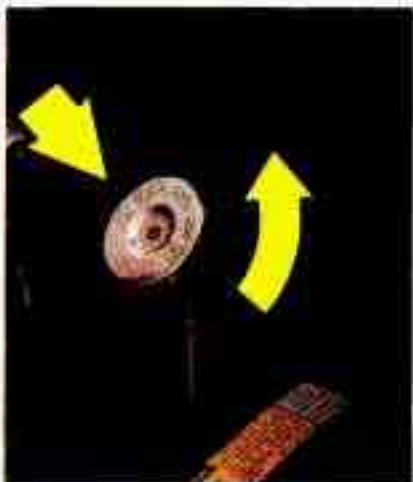

2. Then keep turning the pressure cap, but now push down as you turn it. Remove the pressure cap.



3. Fill the radiator with the proper mix, up to the base of the filler neck.



4. Then fill the coolant recovery tank to the "FULL HOT" mark.



5. Put the cap back on the coolant recovery tank, but leave the radiator pressure cap off.



6. Start the engine and let it run until you can feel the upper radiator hose getting hot. Watch out for the engine fan.
7. By this time, the coolant level inside the radiator filler neck may be lower. If the level is lower, add more of the proper mix through the filler neck until the level reaches the base of the filler neck.

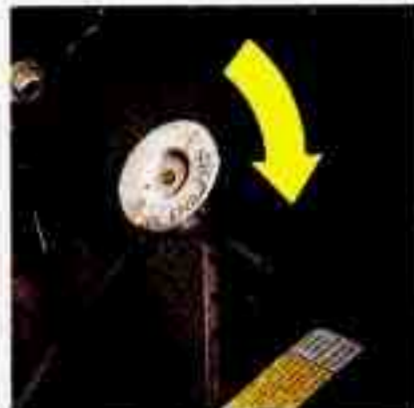

8. Then replace the pressure cap. Be sure the arrows on the pressure cap line up like this.

## If a Tire Goes Flat

It's unusual for a tire to "blow out" while you're driving, especially if you maintain your tires properly. If air goes out of a tire, it's much more likely to leak out slowly. But if you should ever have a "blowout," here are a few tips about what to expect and what to do:

If a front tire fails, the flat tire will create a drag that pulls the vehicle toward that side. Take your foot off the accelerator pedal and grip the steering wheel firmly. Steer to maintain lane position, then gently brake to a stop well out of the traffic lane.

A rear blowout, particularly on a curve, acts much like a skid and may require the same correction you'd use in a

skid. In any rear blowout, remove your foot from the accelerator pedal. Get the vehicle under control by steering the way you want the vehicle to go. It may be very bumpy and noisy, but you can still steer. Gently brake to a stop, well off the road if possible.

If your tire goes flat, the next section shows how to use your jacking equipment to change a flat tire safely.

## Changing a Flat Tire

If a tire goes flat, avoid further tire and wheel damage by driving slowly to a level place. Turn on your hazard warning flashers.



### CAUTION:

**Changing a tire can cause an injury. The vehicle can slip off the jack and roll over you or other people. You and they could be badly injured. Find a level place to change your tire. To help prevent the vehicle from moving:**

1. Set the parking brake firmly.
2. Put the shift lever in "P" (Park).
3. Turn off the engine.

**CAUTION (Continued)**



### CAUTION (Continued)

To be even more certain the vehicle won't move, you can put chocks at the front and rear of the tire farthest away from the one being changed. That would be the tire on the other side of the vehicle, at the opposite end.



The following steps will tell you how to use the jack and change a tire.

Some steps apply to all models, others to just the Century coupe or sedan or to the Century wagon. Follow the steps listed for your vehicle.

### Century Coupe or Sedan

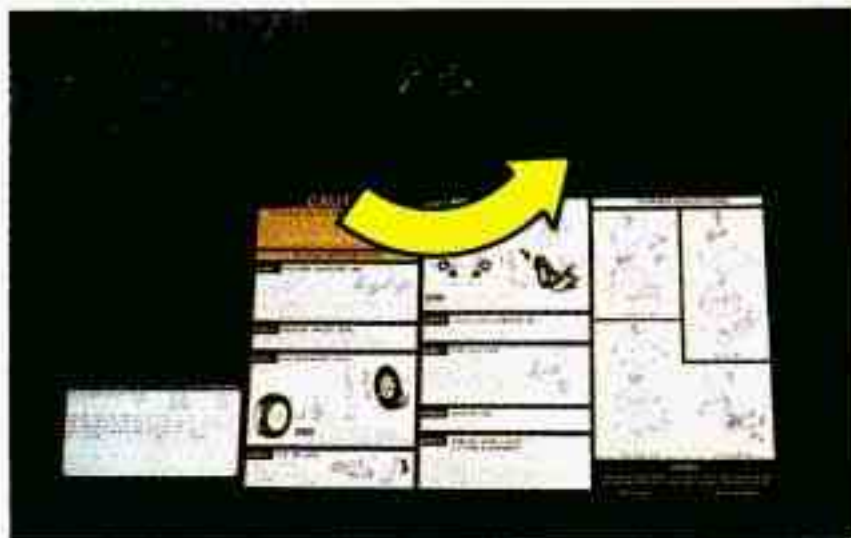

The equipment you'll need is stored in the trunk.

1. Pull the carpeting from the floor of the trunk.
2. Turn the center retainer bolt on the compact spare tire housing counterclockwise to remove it, then lift the tire cover.



3. Lift off the jack and remove the spare tire.
4. Remove the wheel wrench from the bag.

## Century Wagon

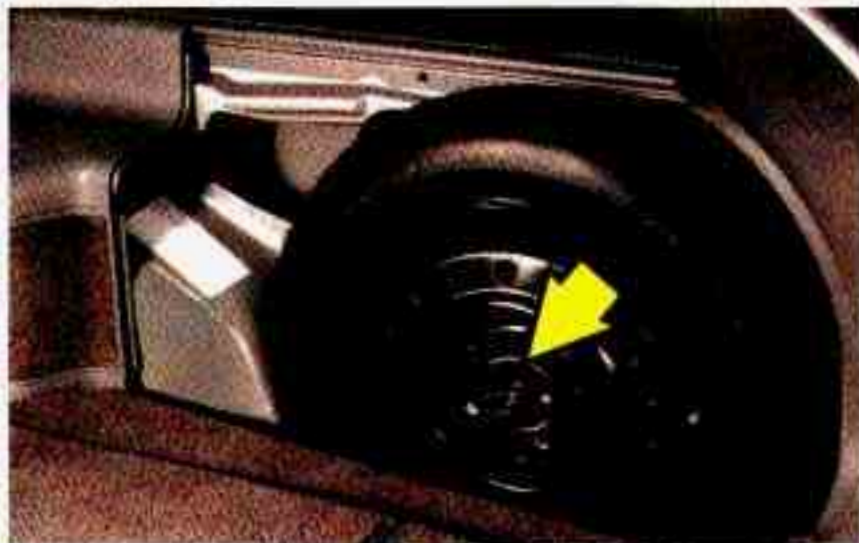

The equipment you'll need is stored in the rear of your vehicle, behind the spare tire cover.



To remove the spare tire cover:

1. Fold down the third seat, if so equipped. Then release the housing that covers the spare tire by carefully pushing in on the top edge of the cover.



2. Slide the spare tire cover back while lifting it up and out of the lower track.



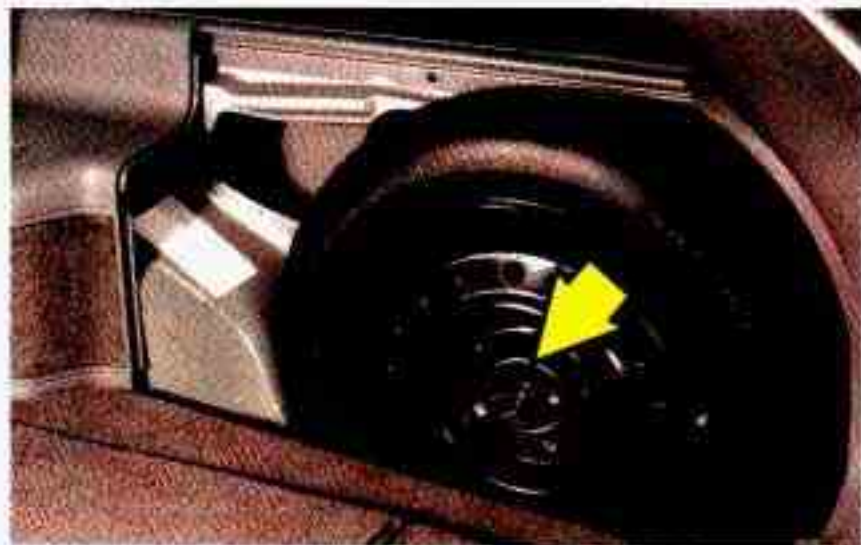

To remove the tire-changing equipment:

1. Remove the wing nut from the center of the spare tire and remove the adapter.
2. Remove the spare tire.

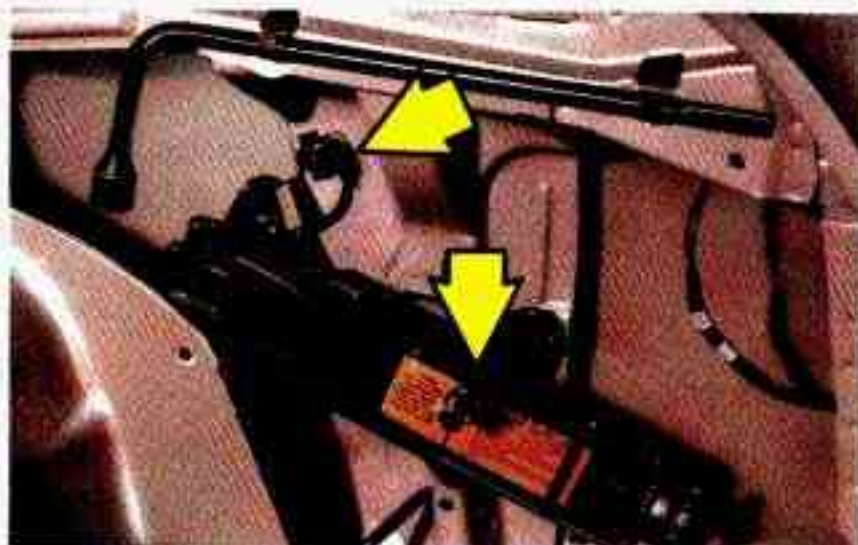

3. Turn the two wing nuts counterclockwise and remove the jack retainer plate. Then pull out the jack and wheel wrench.

## Standard Wheel Cover



You will be using the flat end of the wheel wrench to remove the wheel cover. Pry along the edge of the wheel cover until it comes off.

## Wire Wheel Cover



Removing the wire wheel cover requires this wire wheel key wrench.

Put the flat end into the notch and carefully pry the small center cover off.



Take off the special anti-theft wheel nut. Put the wrench over it like this.

Lift the wheel cover off. You may have to pry carefully at the edge of the wheel cover to get it off. If it doesn't come off with the minimum effort, it may be that the anti-theft wheel nut is not completely off.

## All Vehicles

1. Using the wheel wrench, loosen all the wheel nuts. Don't remove them yet.



2. Position the jack under the vehicle nearest the tire to be changed. The jack location should be approximately five inches (12.7 cm) from the wheel well.



### CAUTION:

Getting under a vehicle when it is jacked up is dangerous. If the vehicle slips off the jack, you could be badly injured or killed. Never get under a vehicle when it is supported only by a jack.

### NOTICE:

Raising your vehicle with the jack improperly positioned will damage the vehicle or may allow the vehicle to fall off the jack. Be sure to fit the jack lift head into the proper location before raising your vehicle.





3. Raise the vehicle by rotating the wheel wrench clockwise.



Raise the vehicle far enough off the ground so there is enough room for the spare tire to fit.

4. Remove all the wheel nuts and take off the flat tire.



5. Remove any rust or dirt from the wheel bolts, mounting surfaces or spare wheel.



6. Place the spare on the wheel mounting surface.

**⚠ CAUTION:**

Rust or dirt on the wheel, or on the parts to which it is fastened, can make the wheel nuts become loose after a time. The wheel could come off and cause an accident. When you change a wheel, remove any rust or dirt from the places where the wheel attaches to the vehicle. In an emergency, you can use a cloth or a paper towel to do this; but be sure to use a scraper or wire brush later, if you need to, to get all the rust or dirt off.

**⚠ CAUTION:**

Never use oil or grease on studs or nuts. If you do, the nuts might come loose. Your wheel could fall off, causing a serious accident.



7. Replace the wheel nuts with the rounded end of the nuts toward the wheel. Tighten each nut by hand until the wheel is held against the hub.



8. Lower the vehicle by rotating the wheel wrench counterclockwise. Lower the jack completely.



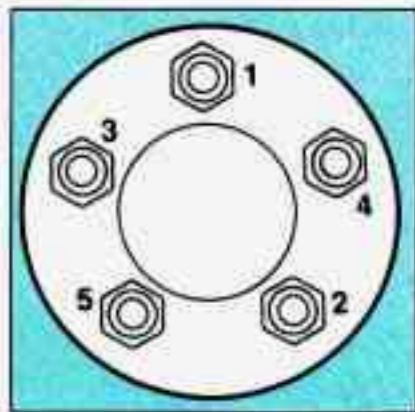

9. Tighten the wheel nuts firmly in a criss-cross sequence as shown.

 **CAUTION:**

**Incorrect wheel nuts or improperly tightened wheel nuts can cause the wheel to become loose and even come off. This could lead to an accident. Be sure to use the correct wheel nuts. If you have to replace them, be sure to get the right kind.**

**Stop somewhere as soon as you can and have the nuts tightened with a torque wrench to 100 pound-feet (140 N·m).**

Don't try to put a wheel cover on your compact spare tire. It won't fit. Store the wheel cover in the trunk or, if you have the wagon, in the rear cargo area, until you have the flat tire repaired or replaced.

### **NOTICE:**

Wheel covers won't fit on your compact spare. If you try to put a wheel cover on your compact spare, you could damage the cover or the spare.

Now put all the equipment back in the vehicle. Just follow these drawings:

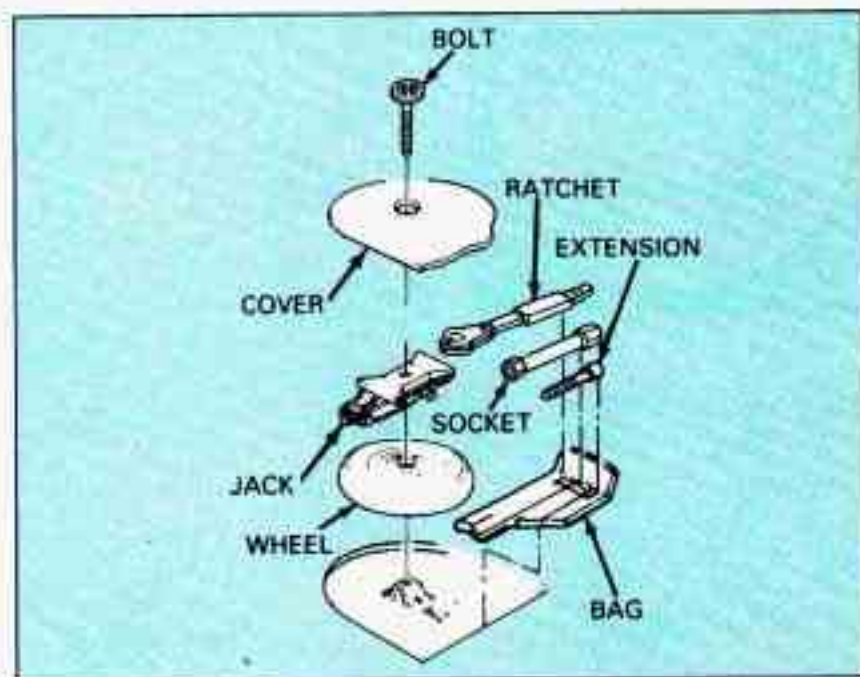

Century Sedan or Coupe

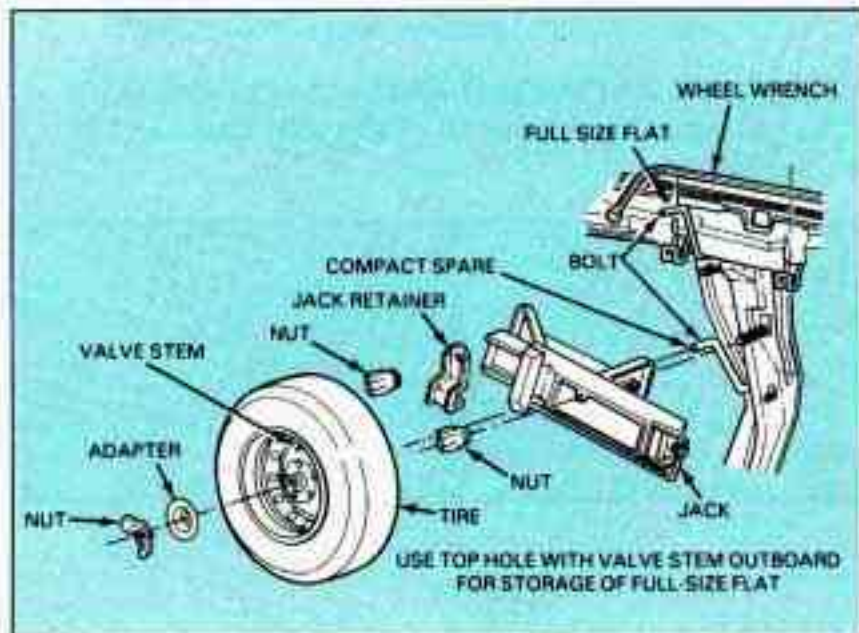

### Century Wagon

## **⚠ CAUTION:**

Storing a jack, a tire or other equipment in the passenger compartment of the vehicle could cause injury. In a sudden stop or collision, loose equipment could strike someone. Store all these in the proper place.

### Century Wagon

To install the spare tire cover in your station wagon when you are finished changing the tire:

1. Put the front lower corner of the cover into the floor track. Overlap the lower rear edge of the front panel one to two inches.
2. Slide the cover to the front; the tabs must go **under** the rear edge.
3. Insert the front upper corner into the track, at the bottom of the glass.
4. Adjust the position of the cover to fit over the weatherstrip. Push the panel down into the track in the floor.
5. Push the panel to lock it into the track of the molding at the bottom of the glass.



## Compact Spare Tire

Although the compact spare was fully inflated when your vehicle was new, it can lose air after a time. Check the inflation pressure regularly. It should be 60 psi (420 kPa). The compact spare is made to go up to 3,000 miles (5 000 km), so you can finish your trip and have your full-size tire repaired or replaced where you want. Of course, it's best to replace your spare with a full-size tire as soon as you can. Your spare will last longer and be in good shape in case you need it again.

### **NOTICE:**

**Don't take your compact spare through an automatic car wash with guide rails. The compact spare can get caught on the rails. That can damage the tire and wheel, and maybe other parts of your vehicle.**

Don't use your compact spare on some other vehicle.

And don't mix your compact spare or wheel with other wheels or tires. They won't fit. Keep your spare and its wheel together.

### **NOTICE:**

**Tire chains won't fit your compact spare. Using them will damage your vehicle and destroy the chains too. Don't use tire chains on your compact spare.**

## If You're Stuck: In Sand, Mud, Ice or Snow

What you **don't** want to do when your vehicle is stuck is to spin your wheels. The method known as "rocking" can help you get out when you're stuck, but you must use caution.



### CAUTION:

If you let your tires spin at high speed, they can explode and you or others could be injured. And, the transaxle or other parts of the vehicle can overheat. That could cause an engine compartment fire or other damage. When you're stuck, spin the wheels as little as possible. Don't spin the wheels above 35 mph (55 km/h) as shown on the speedometer.

### NOTICE:

Spinning your wheels can destroy parts of your vehicle as well as the tires. If you spin the wheels too fast while shifting your transaxle back and forth, you can destroy your transaxle.

#### Rocking your vehicle to get it out:

First, turn your steering wheel left and right. That will clear the area around your front wheels. Then shift back and forth between "R" (Reverse) and a forward gear, spinning the wheels as little as possible. Release the accelerator pedal while you shift, and press lightly on the accelerator pedal when the transaxle is in gear. If that doesn't get you out after a few tries, you may need to be towed out. If you do need to be towed out, see "Towing Your Buick" in the Index.







## Part 6 Service and Appearance Care

Here you will find information about the care of your Buick. This part begins with service and fuel information, and then it shows how to check important fluid and lubricant levels. There is also technical information about your vehicle, and a section devoted to its appearance care.

### Part 6 includes:

Service . . . . .	222
Fuel . . . . .	223
Hood Release . . . . .	226
Engine Oil . . . . .	227
Air Cleaner . . . . .	233
Transaxle Fluid . . . . .	236
Engine Coolant . . . . .	239
Power Steering Fluid . . . . .	241
Windshield Washer Fluid . . . . .	242
Brakes . . . . .	243
Battery . . . . .	244
Bulb Replacement . . . . .	245
Loading Your Vehicle . . . . .	249
Tires . . . . .	251
Appearance Care . . . . .	258
Vehicle Identification Number (VIN), Add-On Electrical Equipment . . . . .	265
Fuses & Circuit Breakers . . . . .	266
Replacement Bulbs . . . . .	269
Capacities and Specifications . . . . .	270

## Service

Your Buick dealer knows your vehicle best and wants you to be happy with it. We hope you'll go to your dealer for all your service needs. You'll get genuine GM parts and GM-trained and supported service people.

We hope you'll want to keep your GM vehicle all GM. Genuine GM parts have one of these marks.



### Doing Your Own Service Work

If you want to do some of your own service work, you'll want to get the proper Buick Service Manual. It tells you much more about how to service your Buick than this manual can. To order the proper service manual, see "Service Publications" in the Index.

You should keep a record with all parts receipts and list the mileage and the date of any service work you perform. See "Maintenance Record" in the Index.

### CAUTION:

**You can be injured if you try to do service work on a vehicle without knowing enough about it.**

- **Be sure you have sufficient knowledge, experience, and the proper replacement parts and tools before you attempt any vehicle maintenance task.**
- **Be sure to use the proper nuts, bolts, and other fasteners. "English" and "metric" fasteners can be easily confused. If you use the wrong fasteners, parts can later break or fall off. You could be hurt.**

### NOTICE:

**If you try to do your own service work without knowing enough about it, your vehicle could be damaged.**



## Fuel

Use regular unleaded gasoline rated at 87 octane or higher. It should meet specifications ASTM D4814 in the U.S. and CGSB 3.5-92 in Canada. These fuels should have the proper additives, so you should not have to add anything to the fuel.

In the U.S. and Canada, it's easy to be sure you get the right kind of gasoline (unleaded). You'll see "UNLEADED" right on the pump. And only unleaded nozzles will fit into your vehicle's filler neck.

Be sure the posted octane is at least 87. If the octane is less than 87, you may get a heavy knocking noise when you drive. If it's bad enough, it can damage your engine.

If you're using fuel rated at 87 octane or higher and you still hear heavy knocking, your engine needs service. But don't worry if you hear a little pinging noise when you're accelerating or driving up a hill. That's normal, and you don't have to buy a higher octane fuel to get rid of pinging. It's the heavy, constant knock that means you have a problem.

What about gasoline with blending materials that contain oxygen, such as MTBE or alcohol?

**MTBE** is "methyl tertiary-butyl ether." Fuel that is no more than 15% MTBE is fine for your vehicle.

**Ethanol** is ethyl or grain alcohol. Properly-blended fuel that is no more than 10% **ethanol** is fine for your vehicle.

**Methanol** is methyl or wood alcohol.

### NOTICE:

**Fuel that is more than 5% methanol is bad for your vehicle. Don't use it. It can corrode metal parts in your fuel system and also damage plastic and rubber parts. That damage wouldn't be covered under your warranty. And even at 5% or less, there must be "cosolvents" and corrosion preventers in this fuel to help avoid these problems.**



## **Gasolines for Cleaner Air**

Your use of gasoline with detergent additives will help prevent deposits from forming in your engine and fuel system. That helps keep your engine in tune and your emission control system working properly. It's good for your vehicle, and you'll be doing your part for cleaner air.

Many gasolines are now blended with materials called oxygenates. General Motors recommends that you use gasolines with these blending materials, such as MTBE and ethanol. By doing so, you can help clean the air, especially in those parts of the country that have high carbon monoxide levels.

In addition, some gasoline suppliers are now producing reformulated gasolines. These gasolines are specially designed to reduce vehicle emissions. General Motors recommends that you use reformulated gasoline. By doing so, you can help clean the air, especially in those parts of the country that have high ozone levels.

You should ask your service station operators if their gasolines contain detergents and oxygenates, and if they have been reformulated to reduce vehicle emissions.

## **Fuels in Foreign Countries**

If you plan on driving in another country outside the U.S. or Canada, unleaded fuel may be hard to find.

Do not use leaded gasoline. If you use even one tankful, your emission controls won't work well or at all. With continuous use, spark plugs can get fouled, the exhaust system can corrode, and your engine oil can deteriorate quickly. Your vehicle's oxygen sensor will be damaged. All of that means costly repairs that wouldn't be covered by your warranty.

To check on fuel availability, ask an auto club, or contact a major oil company that does business in the country where you'll be driving.

You can also write us at the following address for advice. Just tell us where you're going and give your Vehicle Identification Number (VIN).

General Motors of Canada Ltd.  
International Export Sales  
P. O. Box 828  
Oshawa, Ontario L1H 7N1, Canada

## Filling Your Tank



The cap is behind a hinged door on the left side of your vehicle.

To take off the cap, turn it slowly to the left (counterclockwise).

### CAUTION:

If you get gasoline on you and then something ignites it, you could be badly burned. Gasoline can spray out on you if you open the fuel filler cap too quickly. This spray can happen if your tank is nearly full, and is more likely in hot weather. Open the fuel filler cap slowly and wait for any "hiss" noise to stop. Then unscrew the cap all the way.

When you put the cap back on, turn it to the right until you hear a clicking noise.

### NOTICE:

If you need a new cap, be sure to get the right type. Your dealer can get one for you. If you get the wrong type, it may not fit or have proper venting, and your fuel tank and emissions system might be damaged.

### CAUTION:

Gasoline vapor is highly flammable. It burns violently, and that can cause very bad injuries. Don't smoke if you're near gasoline or refueling your vehicle. Keep sparks, flames, and smoking materials away from gasoline.



## Checking Things Under the Hood Hood Release



To open the hood, first pull the handle inside the vehicle. It is located on the lower left side of the instrument panel.



Then go to the front of the vehicle and release the secondary hood release. Lift the hood.



### **CAUTION:**

An electric fan under the hood can start up and injure you even when the engine is not running. Keep hands, clothing and tools away from any underhood electric fan.



**⚠ CAUTION:**

Things that burn can get on hot engine parts and start a fire. These include liquids like gasoline, oil, coolant, brake fluid, windshield washer and other fluids, and plastic or rubber. You or others could be burned. Be careful not to drop or spill things that will burn onto a hot engine.

Before closing the hood, be sure all the filler caps are on properly. Then just pull the hood down and close it firmly.

## Engine Oil

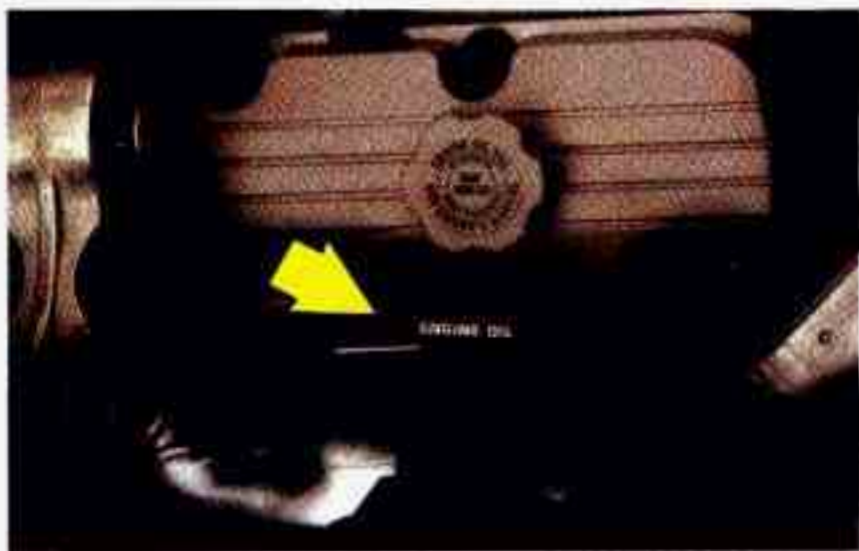

It's a good idea to check your engine oil every time you get fuel. In order to get an accurate reading, the oil must be warm and the vehicle must be on level ground. The 3300 V6 engine oil dipstick is located near the front and center of the engine compartment.

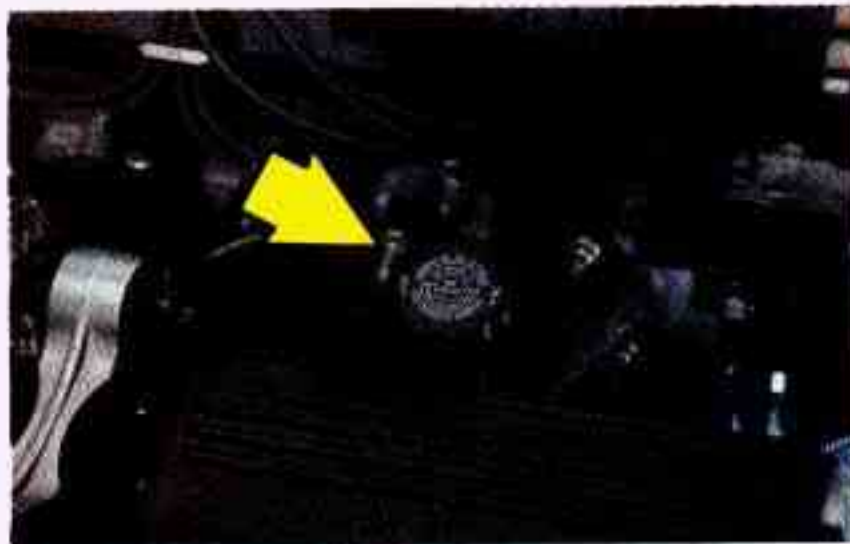

The 2.2L L4 engine oil dipstick is located in the fill cap near the front and center of the engine compartment.

Turn off the engine and give the oil a few minutes to drain back into the oil pan. If you don't, the oil dipstick might not show the actual level.



**To Check Engine Oil:** Pull out the dipstick and clean it with a paper towel or cloth, then push it back in all the way. Remove it again, keeping the tip lower.

**When to Add Oil:** If the oil is at or below the "ADD" line, then you'll need to add some oil. But you must use the right kind. This section explains what kind of oil to use. For crankcase capacity, see "Capacities and Specifications" in the Index.

## NOTICE:

**Don't add too much oil. If your engine has so much oil that the oil level gets above the cross-hatched area that shows the proper operating range, your engine could be damaged.**

Just fill it enough to put the level somewhere in the proper operating range. Push the dipstick all the way back in when you're through.

## What Kind of Oil to Use

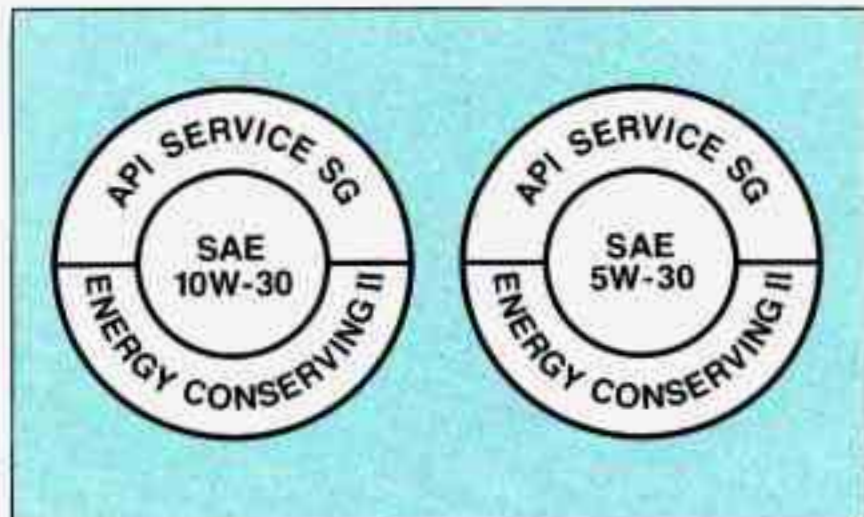

Look for three things:

- SG

“SG” must be on the oil container, either by itself or combined with other quality designations, such as “SG/CC,” “SG/CD,” “SF, SG, CC,” etc. These letters show American Petroleum Institute (API) levels of quality.

## NOTICE:

**If you use oils that don't have the “SG” designation, you can cause engine damage not covered by your warranty.**



## RECOMMENDED SAE VISCOSITY GRADE ENGINE OILS

FOR BEST FUEL ECONOMY AND COLD STARTING, SELECT THE LOWEST SAE VISCOSITY GRADE OIL FOR THE EXPECTED TEMPERATURE RANGE.

**HOT  
WEATHER**

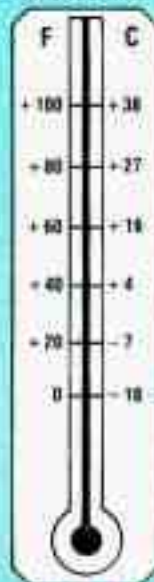

**COLD  
WEATHER**

**LOOK  
FOR THIS  
LABEL**



**SAE 5W-30**

**SAE 10W-30  
PREFERRED**  
above 0°F  
(-18°C)

IF NEITHER SAE 5W-30 NOR SAE 10W-30  
GRADE OILS ARE AVAILABLE, SAE 30  
GRADE MAY BE USED AT TEMPERATURES  
ABOVE 40 DEGREES F (4 DEGREES C).

DO NOT USE SAE 10W-40, SAE 20W-50 OR  
ANY OTHER GRADE OIL NOT RECOMMENDED

If you have the 3300 V6 engine use:

- **SAE 10W-30**

As shown in this chart, SAE 10W-30 is best for your vehicle. However, you can use SAE 5W-30 if it's going to be colder than 60°F (16°C) before your next oil change. When it's very cold, below 0°F (-18°C), you should use SAE 5W-30.

These numbers on an oil container show its viscosity, or thickness. Do not use other viscosity oils such as SAE 10W-40 or SAE 20W-50.

3300 V6 Engine

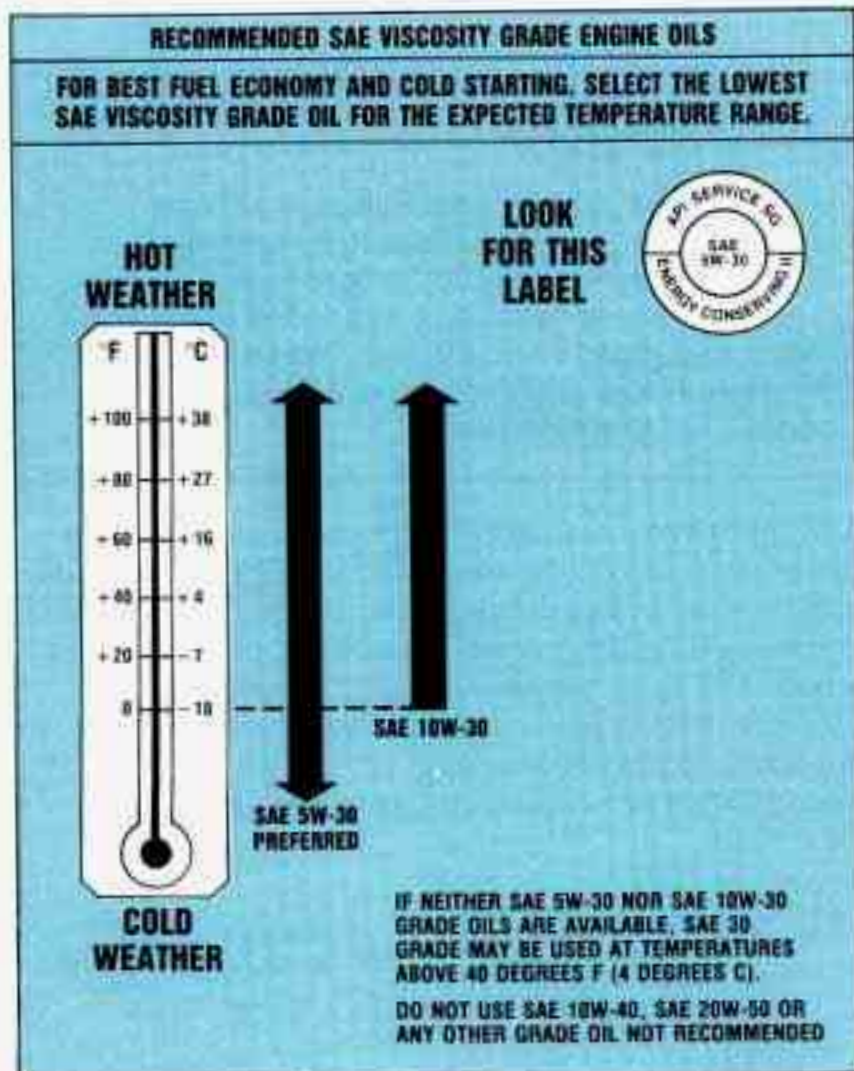

**2.2L L4 Engine**

If you have the 2.2L L4 engine use:

- **SAE 5W-30**  
As shown in this chart, SAE 5W-30 is best for your vehicle. However, you can use SAE 10W-30 if it's going to be 0° F (-18° C) or above.

These numbers on an oil container show its viscosity, or thickness. Do not use other viscosity oils such as SAE 10W-40 or SAE 20W-50.

- **Energy Conserving II**  
Oils with these words on the container will help you save fuel.

This doughnut-shaped logo (symbol) is used on most oil containers to help you select the correct oil.

You should look for this on the oil container, and use **only** those oils that display the logo.

GM Goodwrench® Oil (in Canada, GM Engine Oil) meets all the requirements for your vehicle.

**Engine Oil Additives:** Don't add anything to your oil. Your Buick dealer is ready to advise if you think something should be added.



**When to Change Engine Oil:** See if any one of these is true for you:

- Most trips are less than 4 miles (6 km).
- It's below freezing outside and most trips are less than 10 miles (16 km).
- The engine is at low speed most of the time (as in door-to-door delivery, or in stop-and-go traffic).
- You tow a trailer often.
- Most trips are through dusty places.

If any one of these is true for your vehicle, then you need to change your **oil and filter** every 3,000 miles (5 000 km) or 3 months—whichever comes first.

If none of them is true, change the oil every 7,500 miles (12 500 km) or 12 months—whichever comes first. Change the filter at the first oil change and at every other oil change after that.

**Engine Block Heater:** An engine block heater can be a big help if you have to park outside in very cold weather, 0°F (-18°C) or colder. If your vehicle has this option, see “Engine Block Heater” in the Index.

**What to Do with Used Oil:**



**CAUTION:**

Used engine oil contains things that have caused skin cancer in laboratory animals. Don't let used oil stay on your skin for very long. Clean your skin and nails with soap and water or a good hand cleaner. Wash or properly throw away clothing or rags containing used engine oil.

Used oil can be a real threat to the environment. If you change your own oil, be sure to drain all free-flowing oil from the filter before disposal. Don't ever dispose of oil by pouring it on the ground, into sewers, or into streams or bodies of water. Instead, recycle it by taking it to a place that collects used oil. If you have a problem properly disposing of your used oil, ask your dealer, a service station or a local recycling center for help.



## Air Cleaner



If you have the 3300 V6 engine, your air cleaner is on the driver's side of the engine compartment. To check or replace the filter, release the latches and pull the air cleaner open. Refer to the Maintenance Schedule to determine when to replace the air filter. See "Scheduled Maintenance Services" in the Index.

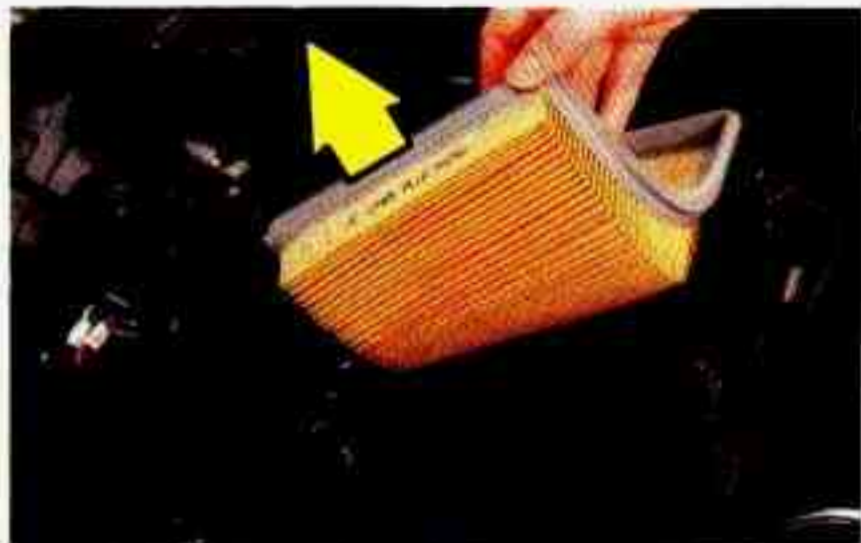

Remove and replace the filter, then close the cover and latches.



If you have the 2.2L L4 engine, your air cleaner is on the driver's side of the engine compartment. To check or replace the filter, use a screwdriver to loosen the hose clamp, then lift the rubber duct. Refer to the Maintenance Schedule to determine when to replace the air filter.



Remove the wing nut and pull off the cover.



Remove and replace the filter. Replace the cover, wing nut and rubber duct. Tighten the hose clamp.



### **CAUTION:**

Operating the engine with the air cleaner off can cause you or others to be burned. The air cleaner not only cleans the air, it stops flame if the engine backfires. If it isn't there, and the engine backfires, you could be burned. Don't drive with it off, and be careful working on the engine with the air cleaner off.

### **NOTICE:**

If the air cleaner is off, a backfire can cause a damaging engine fire. And, dirt can easily get into your engine, which will damage it. Always have the air cleaner in place when you're driving.



## Automatic Transaxle Fluid

### When to Check and Change:

A good time to check your automatic transaxle fluid level is when the engine oil is changed. Refer to the Maintenance Schedule to determine when to change your fluid. See "Scheduled Maintenance Services" in the Index.

### How to Check:

Because this operation can be a little difficult, you may choose to have this done at a Buick dealership Service Department.

If you do it yourself, be sure to follow all the instructions here, or you could get a false reading on the dipstick.

### **NOTICE:**

**Too much or too little fluid can damage your transaxle. Too much can mean that some of the fluid could come out and fall on hot engine parts, starting a fire. Be sure to get an accurate reading if you check your transaxle fluid.**

Wait at least 30 minutes before checking the transaxle fluid level if you have been driving:

- When outside temperatures are above 90°F (32°C).
- At high speed for quite a while.
- In heavy traffic—especially in hot weather.
- While pulling a trailer.

To get the right reading, the fluid should be at normal operating temperature, which is 180°F to 200°F (82°C to 93°C).

Get the vehicle warmed up by driving about 15 miles (24 km) when outside temperatures are above 50°F (10°C). If it's colder than 50°F (10°C), you may have to drive longer.

### To check the fluid level:

- Park your vehicle on a level place.
- Place the shift lever in "P" (Park) with the parking brake applied.
- With your foot on the brake pedal, move the shift lever through each gear range, pausing for about three seconds in each range. Then, position the shift lever in "P" (Park).
- Let the engine run at idle for three to five minutes.

Then, without shutting off the engine, follow these steps:



The dipstick on the 3300 V6 engine looks like this.



The dipstick on the 2.2L L4 engine looks like this.

1. Pull out the dipstick and wipe it with a clean rag or paper towel.
2. Push it back in all the way, wait three seconds and then pull it back out again.



3. Check both sides of the dipstick, and read the lower level. The fluid level must be in the cross-hatched area.
4. If the fluid level is where it should be, push the dipstick back in all the way.

#### **How To Add Fluid:**

Refer to the Maintenance Schedule to determine what kind of transaxle fluid to use. See "Recommended Fluids and Lubricants" in the Index.

If the fluid level is low, add only enough of the proper fluid to bring the level into the cross-hatched area on the dipstick. It doesn't take much fluid, generally less than a pint. Don't overfill.

We recommend you use only fluid labeled DEXRON®-III, because fluids with that label are made especially for your automatic transaxle. Damage caused by fluid other than DEXRON®-III is not covered by your new vehicle warranty.

After adding fluid, recheck the fluid level as described under "How to Check."

When the correct fluid level is obtained, push the dipstick back in all the way.



## Engine Coolant

The following explains your cooling system and how to add coolant when it is low. If you have a problem with engine overheating, see "Engine Overheating" in the Index.

The proper coolant for your Buick will:

- Give freezing protection down to  $-34^{\circ}\text{F}$  ( $-37^{\circ}\text{C}$ ).
- Give boiling protection up to  $262^{\circ}\text{F}$  ( $128^{\circ}\text{C}$ ).
- Protect against rust and corrosion.
- Help keep the proper engine temperature.
- Let the warning lights work as they should.

**What to Use:** Use a mixture of one-half **clean water** (preferably distilled) and one-half antifreeze that meets "GM Specification 1825-M," which won't damage aluminum parts. You can also use a recycled coolant conforming to GM Specification 1825-M with a complete coolant flush and refill. Use GM Engine Coolant Supplement (sealer) with any complete coolant change. If you use these, you don't need to add anything else.



### CAUTION:

**Adding only plain water to your cooling system can be dangerous. Plain water, or some other liquid like alcohol, can boil before the proper coolant mix will. Your vehicle's coolant warning system is set for the proper coolant mix. With plain water or the wrong mix, your engine could get too hot but you wouldn't get the overheat warning. Your engine could catch fire and you or others could be burned. Use a 50/50 mix of clean water and a proper antifreeze.**

### NOTICE:

**If you use an improper coolant mix, your engine could overheat and be badly damaged. The repair cost wouldn't be covered by your warranty. Too much water in the mix can freeze and crack the engine, radiator, heater core and other parts.**

## Adding Coolant



The coolant recovery tank is located on the passenger's side of the engine compartment.

**To Check Coolant:** When your engine is cold, the coolant level should be at "ADD," or a little higher. When your engine is warm, the level should be up to "FULL HOT," or a little higher.

**To Add Coolant:** If you need more coolant, add the proper mix at the coolant recovery tank.

### CAUTION:

Turning the radiator pressure cap when the engine and radiator are hot can allow steam and scalding liquids to blow out and burn you badly. With the coolant recovery tank, you will almost never have to add coolant at the radiator. Never turn the radiator pressure cap—even a little—when the engine and radiator are hot.

Add coolant mix at the recovery tank, but be careful not to spill it.

### CAUTION:

You can be burned if you spill coolant on hot engine parts. Coolant contains ethylene glycol, and it will burn if the engine parts are hot enough. Don't spill coolant on a hot engine.



## Radiator Pressure Cap

### **NOTICE:**

Your radiator cap is a 15 psi (105 kPa) pressure-type cap and must be tightly installed to prevent coolant loss and possible engine damage from overheating. Be sure the arrows on the cap line up with the overflow tube on the radiator filler neck.

When you replace your radiator pressure cap, an AC® cap is recommended.

## Thermostat

Engine coolant temperature is controlled by a thermostat in the engine coolant system. The thermostat stops the flow of coolant through the radiator until the coolant reaches a preset temperature.

When you replace your thermostat, an AC® thermostat is recommended.

## Power Steering Fluid



### **How to Check Power Steering Fluid:**

Unscrew the cap and wipe the dipstick with a clean rag. Replace the cap and completely tighten it. Then remove the cap again and look at the fluid level on the dipstick.

- When the engine compartment is hot, the level should be at the “H” (Hot) mark.
- When the engine compartment is cool, the level should be at the “C” (Cold) mark.

### **What to Add:**

Refer to the Maintenance Schedule to determine what kind of fluid to use. See “Recommended Fluids and Lubricants” in the Index.



## NOTICE:

When adding power steering fluid or making a complete fluid change, always use the proper fluid. Failure to use the proper fluid can cause leaks and damage hoses and seals.

## Windshield Washer Fluid



### To Add:

The windshield washer reservoir is located at the driver's side of the engine compartment. The rear window

washer fluid reservoir (for the wagon) is the smaller reservoir next to the coolant recovery tank.

Open the cap labeled "WASHER FLUID ONLY." Add washer fluid until the bottle is full.

## NOTICE:

- When using concentrated washer fluid, follow the manufacturer's instructions for adding water.
- Don't mix water with ready-to-use washer fluid. Water can cause the solution to freeze and damage your washer fluid tank and other parts of the washer system. Also, water doesn't clean as well as washer fluid.
- Fill your washer fluid tank only  $\frac{3}{4}$  full when it's very cold. This allows for expansion, which could damage the tank if it is completely full.
- Don't use radiator antifreeze in your windshield washer. It can damage your washer system and paint.

## Brake Master Cylinder



Your brake master cylinder is here. It is filled with DOT-3 brake fluid.

There are only two reasons why the brake fluid level in your master cylinder might go down. The first is that the brake fluid goes down to an acceptable level during normal brake lining wear. When new linings are put in, the fluid level goes back up.

The other reason is that fluid is leaking out of the brake system. If it is, you should have your brake system fixed, since a leak means that sooner or later your brakes won't work well, or won't work at all.

So, it isn't a good idea to "top off" your brake fluid. Adding brake fluid won't correct a leak. If you add fluid when your linings are worn, then you'll have too much fluid when you get new brake linings. You should add (or remove) brake fluid, as necessary, only when work is done on the brake hydraulic system.

### CAUTION:

If you have too much brake fluid, it can spill on the engine. The fluid will burn if the engine is hot enough. You or others could be burned, and your vehicle could be damaged. Add brake fluid only when work is done on the brake hydraulic system.

When your brake fluid falls to a low level, your brake warning light will come on. See "Brake System Warning Light" in the Index.

#### What to Add:

When you do need brake fluid, use only DOT-3 brake fluid—such as Delco Supreme II® (GM Part No. 1052535). Use new brake fluid from a sealed container only.



## NOTICE:

- **DOT-5 silicone brake fluid can damage your vehicle. Don't use it.**
- **Don't let someone put in the wrong kind of fluid. For example, just a few drops of mineral-based oil, such as engine oil, in your brake system can damage brake system parts so badly that they'll have to be replaced.**
- **Brake fluid can damage paint, so be careful not to spill brake fluid on your vehicle.**

## Replacing Brake System Parts

The braking system on a modern vehicle is complex. Its many parts have to be of top quality and work well together if the vehicle is to have really good braking. Vehicles we design and test have top-quality GM brake parts in them, as your Buick does when it is new. When you replace parts of your braking system—for example, when your brake linings wear down and you have to have new ones put in—be sure you get new genuine GM replacement parts. If you don't, your brakes may no longer work properly. For example, if someone puts in brake linings that are wrong for your vehicle, the balance between your front and rear brakes can change, for the worse. The braking performance you've come to expect

can change in many other ways if someone puts in the wrong replacement brake parts.

## Battery

Every new Buick has a Delco Freedom<sup>®</sup> battery. You never have to add water to one of these. When it's time for a new battery, we recommend a Delco Freedom<sup>®</sup> battery. Get one that has the catalog number shown on the original battery's label.

## Vehicle Storage

If you're not going to drive your vehicle for 25 days or more, take off the black, negative (–) cable from the battery. This will help keep your battery from running down.



## CAUTION:

**Batteries have acid that can burn you and gas that can explode. You can be badly hurt if you aren't careful. See "Jump Starting" in the Index for tips on working around a battery without getting hurt.**

Contact your dealer to learn how to prepare your vehicle for longer storage periods.



## Halogen Bulbs

### CAUTION:

Halogen bulbs have pressurized gas inside and can burst if you drop or scratch the bulb. You or others could be injured. Take special care when handling and disposing of halogen bulbs.

## Headlamp Bulb Replacement



For the type of bulb, see the Index under "Replacement Bulbs."

1. Turn the bulb assembly counterclockwise  $\frac{1}{6}$  turn, pressing in firmly, until the flanges align with the slots in the retainer ring.
2. Pull out the bulb assembly. You may have to rock it up and down slightly to loosen it.
3. Disconnect the bulb base from the wiring harness by lifting the plastic locking tab.

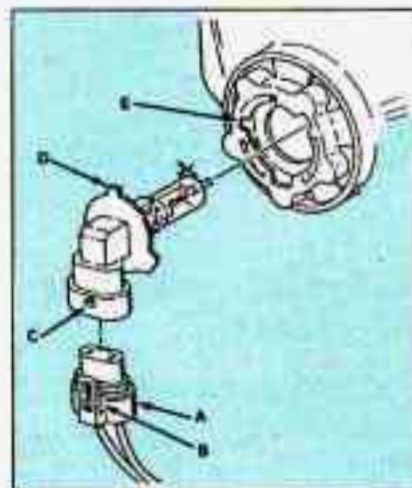

To replace the bulb assembly:

1. Snap a new bulb into the wiring harness (A). Make sure the locking tab (B) is over the lock (C).
2. Install the bulb assembly by putting the small tab (D) in the small notch in the retainer ring (E).
3. Turn the bulb assembly  $\frac{1}{6}$  turn clockwise to lock it in place.

## Front Turn and Parking Bulb and/or Side Marker Bulb Replacement

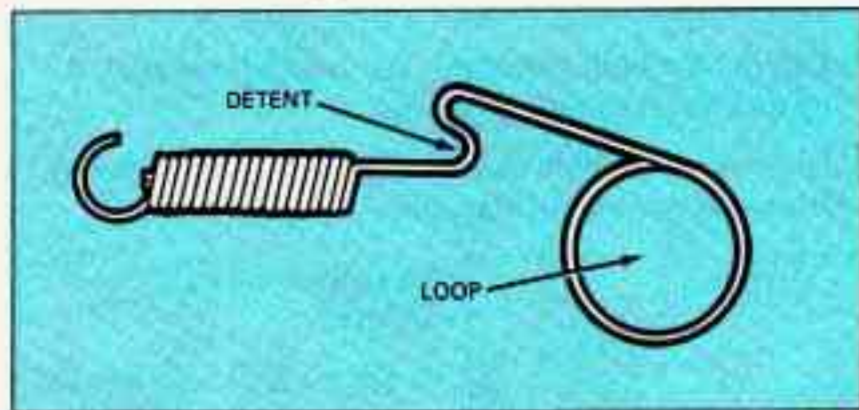

1. Raise the hood.
2. Insert a screwdriver into the loop of the spring, which can be seen just behind the bulb assembly.
3. Pull the spring to the rear and slightly toward the outside of the car until the detent releases from the notch in the headlight mounting frame.

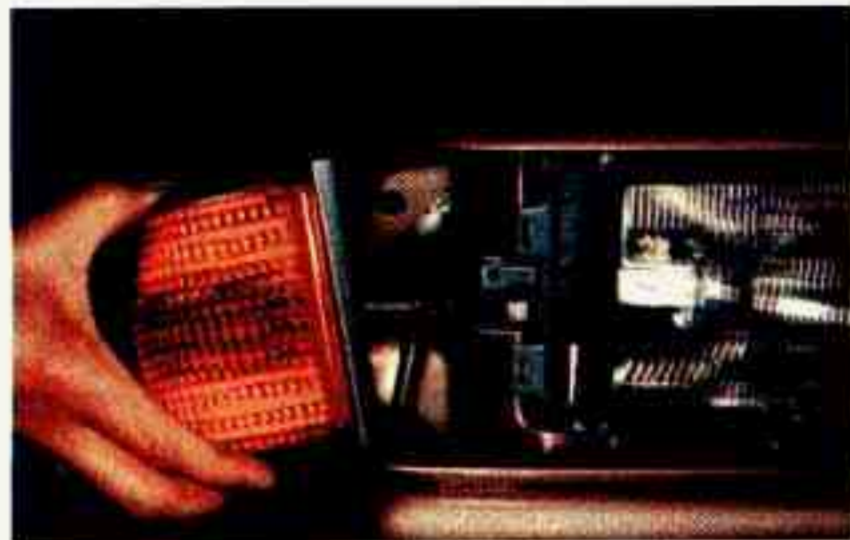

4. The bulb assembly is now loose. Pull it forward until the bulb assembly can be reached.

To replace the turn/park bulb:

1. Unsnap the wire connector from the bulb assembly.
2. Turn the bulb counterclockwise to remove it.
3. Put in the new bulb and turn it clockwise.
4. Snap the wire connector onto the bulb assembly.



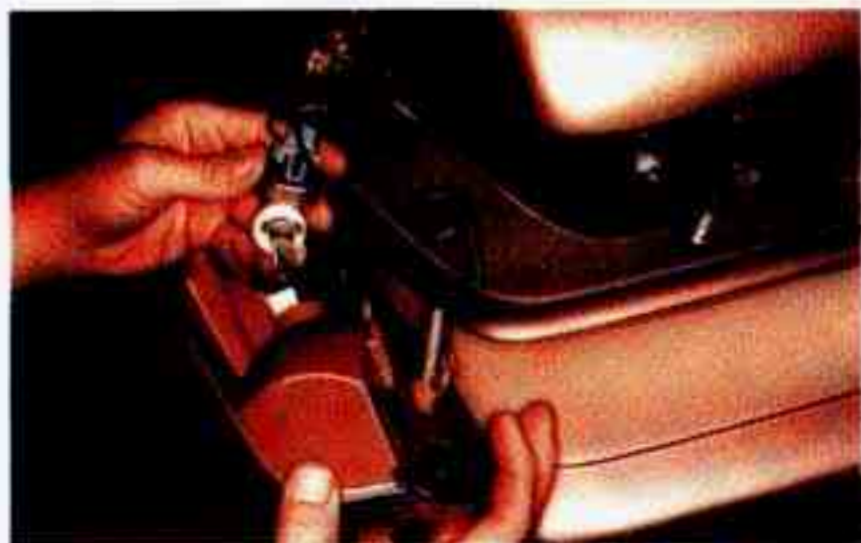

To replace the side marker bulb:

1. Remove the socket by turning it counterclockwise and pulling it straight out.
2. Remove the bulb by pulling it straight out of the socket.
3. Insert the new bulb by pressing it straight into the socket.
4. Insert the socket by pressing it straight into the bulb hole and turning it clockwise.



To reinstall the lamp:

1. Guide the latch spring through the opening in the metal inner panel.
2. Engage the two blades on the lamp into the slots on the headlamp while engaging the two pins at the rear of the lamp opening into the sockets on the rear of the lamp. The lamp is now in place.
3. Insert a screwdriver into the loop on the latch spring. Pull the spring to the rear and slightly center of the vehicle until the detent engages into the notch.

### **Taillight Bulb Replacement (Coupe & Sedan)**

For the type of bulb, see the Index under "Replacement Bulbs."

Replacing bulbs in the taillight housing is very difficult, and we recommend that you see your dealer when you need a bulb replaced.



## Taillight Bulb Replacement (Wagon)

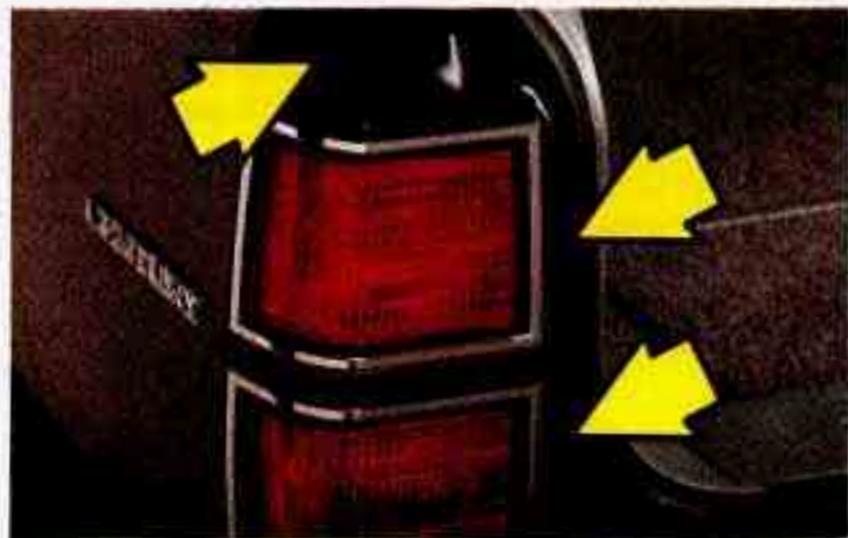

For the type of bulb, see the Index under "Replacement Bulbs."

1. Open the liftgate.
2. Remove the three Phillips head screws.
3. Pull the taillight housing away from the body of the vehicle.



4. Press the bulb housing release lever and turn the housing  $\frac{1}{8}$  turn counterclockwise to remove it.
5. To remove the bulb, push in and rotate it counterclockwise.
6. Reverse all steps to reassemble the taillight.

## Windshield Wiper Blade Replacement



Replacement blades come in different types and are removed in different ways. Here's how to remove the type with a spring release:

1. Pull the windshield wiper arm away from the windshield.
2. Press down on the spring with a screwdriver and pull the blade assembly off the wiper arm.
3. Push the new wiper blade securely onto the wiper arm.

## Loading Your Vehicle

TIRE-LOADING INFORMATION					
OCCUPANTS			VEHICLE CAP. WT.		
FRT.	CTR.	RR.	TOTAL	LBS.	KG
MAX. LOADING & GVWR SAME AS VEHICLE					
CAPACITY WEIGHT		XXX	COLD TIRE		
TIRE SIZE		SPEED	PRESSURE		
		RTG	PSI/KPa		
FRT.					
RR.					
SPA.					
IF TIRES ARE HOT, ADD 4PSI/28KPa					
SEE OWNER'S MANUAL FOR ADDITIONAL INFORMATION					

Two labels on your vehicle show how much weight it may properly carry. The Tire-Loading Information label found on the rear edge of the driver's door tells you the proper size, speed rating and recommended inflation pressures for the tires on your vehicle. It also gives you important information about the number of people that can be in your vehicle and the total weight that you can carry. This weight is called the Vehicle Capacity Weight and includes the weight of all occupants, cargo, and all nonfactory-installed options.





MFD BY GENERAL MOTORS CORP  
DATE GVWR GAWR FRT GAWR RR

THIS VEHICLE CONFORMS TO ALL APPLICABLE U.S. FEDERAL MOTOR VEHICLE SAFETY, BUMPER, AND THEFT PREVENTION STANDARDS IN EFFECT ON THE DATE OF MANUFACTURE SHOWN ABOVE.

GM

The other label is the Certification label, found on the rear edge of the driver's door. It tells you the gross weight capacity of your vehicle, called the GVWR (Gross Vehicle Weight Rating).

The GVWR includes the weight of the vehicle, all occupants, fuel and cargo. Never exceed the GVWR for your vehicle, or the Gross Axle Weight Rating (GAWR) for either the front or rear axle.

And, if you do have a heavy load, you should spread it out. In the trunk or rear area don't carry more than 160 pounds (72 kg) for the coupes/sedans; 300 pounds (136 kg)

for the six-passenger wagon. If you have the eight-passenger wagon, no additional cargo can be carried if you already have eight people in the vehicle.



### CAUTION:

**Do not load your vehicle any heavier than the GVWR or the maximum front and rear GAWRs. If you do, parts on your vehicle can break, or it can change the way your vehicle handles. These could cause you to lose control. Also, overloading can shorten the life of your vehicle.**

### NOTICE:

**Your warranty does not cover parts or components that fall because of overloading.**

If you put things inside your vehicle—like suitcases, tools, packages, or anything else—they will go as fast as the vehicle goes. If you have to stop or turn quickly, or if there is a crash, they'll keep going.



## CAUTION:

Things you put inside your vehicle can strike and injure people in a sudden stop or turn, or in a crash.

- Put things in the trunk or rear area of your vehicle. In a trunk, put them as far forward as you can. Try to spread the weight evenly.
- Never stack heavier things, like suitcases, inside the vehicle so that some of them are above the tops of the seats.
- When you carry something inside the vehicle, secure it whenever you can.
- Don't leave a seat folded down unless you need to.

## Tires

We don't make tires. Your new vehicle comes with high quality tires made by a leading tire manufacturer. These tires are warranted by the tire manufacturers and their warranties are delivered with every new Buick. If your spare tire is a different brand than your road tires, you will have a tire warranty folder from each of these manufacturers.

## CAUTION:

Poorly maintained and improperly used tires are dangerous.

- Overloading your tires can cause overheating as a result of too much friction. You could have an air-out and a serious accident. See "Loading Your Vehicle" in the Index.
- Underinflated tires pose the same danger as overloaded tires. The resulting accident could cause serious injury. Check all tires frequently to maintain the recommended pressure. Tire pressure should be checked when your tires are cold.
- Overinflated tires are more likely to be cut, punctured, or broken by a sudden impact, such as when you hit a pothole. Keep tires at the recommended pressure.
- Worn, old tires can cause accidents. If your tread is badly worn, or if your tires have been damaged, replace them.

## **Inflation—Tire Pressure**

The Tire-Loading Information label which is on the rear edge of the driver's door shows the correct inflation pressures for your tires, when they're cold. "Cold" means your vehicle has been sitting for at least three hours or driven no more than a mile.

### **NOTICE:**

**Don't let anyone tell you that underinflation or overinflation is all right. It's not. If your tires don't have enough air (underinflation), you can get:**

- **Too much flexing**
- **Too much heat**
- **Tire overloading**
- **Bad wear**
- **Bad handling**
- **Bad fuel economy.**

**If your tires have too much air (overinflation), you can get:**

- **Unusual wear**
- **Bad handling**
- **Rough ride**
- **Needless damage from road hazards.**

**When to Check:** Check your tires once a month or more. Don't forget your compact spare tire. It should be at 60 psi (420 kPa).

**How to Check:** Use a good quality pocket-type gage to check tire pressure. Simply looking at the tires will not tell you the pressure, especially if you have radial tires—which may look properly inflated even if they're underinflated.

If your tires have valve caps, be sure to put them back on. They help prevent leaks by keeping out dirt and moisture.



## Tire Inspection and Rotation

To make your tires last longer, have them inspected and rotated at the mileages recommended in the Maintenance Schedule. See "Scheduled Maintenance Services" in the Index.

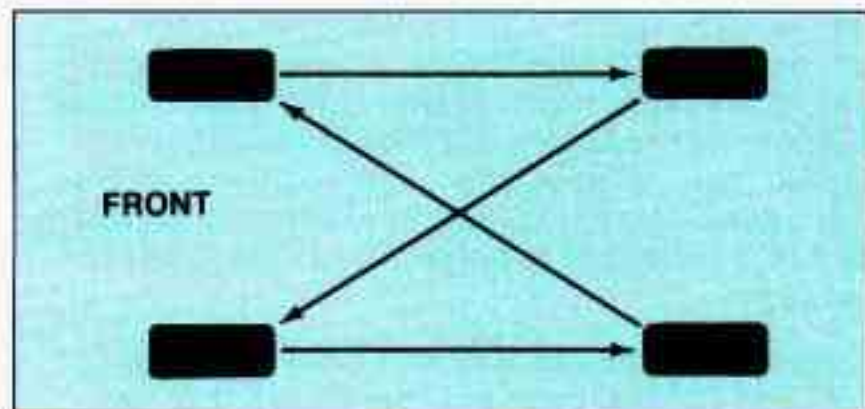

Use this rotation pattern.

After the tires have been rotated, adjust the front and rear inflation pressure as shown on the Tire-Loading Information label. Make certain that all wheel nuts are properly tightened. See "Wheel Nut Torque" in the Index.

### CAUTION:

Rust or dirt on a wheel, or on the parts to which it is fastened, can make the wheel nuts become loose after a time. The wheel could come off and cause an accident. When you change a wheel, remove any rust or dirt from places where the wheel attaches to the vehicle. In an emergency, you can use a cloth or a paper towel to do this; but be sure to use a scraper or wire brush later, if you need to, to get all the rust or dirt off. (See "Changing a Flat Tire" in the Index.)



## When It's Time for New Tires



One way to tell when it's time for new tires is to check the treadwear indicators, which will appear when your tires have only  $2/32$  inch (1.6 mm) or less of tread remaining.

You need a new tire if:

- You can see the indicators at three places around the tire.
- You can see cord or fabric showing through the tire's rubber.

- The tread or sidewall is cracked, cut or snagged deep enough to show cord or fabric.
- The tire has a bump, bulge or split.
- The tire has a puncture, cut, or other damage that can't be repaired well because of the size or location of the damage.

## Buying New Tires

To find out what kind and size of tires you need, look at the Tire-Loading Information label.

The tires installed on your vehicle when it was new had a Tire Performance Criteria Specification (TPC Spec) number on each tire's sidewall. When you get new tires, get ones with that same TPC Spec number. That way, your vehicle will continue to have tires that are designed to give proper endurance, handling, speed rating, traction, ride and other things during normal service on your vehicle. If your tires have an all-season tread design, the TPC number will be followed by a "MS" (for mud and snow).

If you ever replace your tires with those not having a TPC Spec number, make sure they are the same size, load range, speed rating and construction type (bias, bias-belted or radial) as your original tires.

 **CAUTION:**

Mixing tires could cause you to lose control while driving. If you mix tires of different sizes or types (radial and bias-belted tires) the vehicle may not handle properly, and you could have a crash. Be sure to use the same size and type tires on all four wheels. It's all right to drive with your compact spare, though. It was developed for use on your vehicle.

## Uniform Tire Quality Grading

The following information relates to the system developed by the United States National Highway Traffic Safety Administration which grades tires by treadwear, traction and temperature performance. (This applies only to vehicles sold in the United States.)

## Treadwear

The treadwear grade is a comparative rating based on the wear rate of the tire when tested under controlled conditions on a specified government test course. For example, a tire graded 150 would wear one and a half (1½) times as well on the government course as a tire graded 100. The relative performance of tires depends upon the actual conditions of their use, however, and may depart significantly from the norm due to variations in driving habits, service practices and differences in road characteristics and climate.

## Traction—A, B, C

The traction grades, from highest to lowest are: A, B, and C. They represent the tire's ability to stop on wet pavement as measured under controlled conditions on specified government test surfaces of asphalt and concrete. A tire marked C may have poor traction performance.

Warning: The traction grade assigned to this tire is based on braking (straight-ahead) traction tests and does not include cornering (turning) traction.



## Temperature—A, B, C

The temperature grades are A (the highest), B, and C, representing the tire's resistance to the generation of heat and its ability to dissipate heat when tested under controlled conditions on a specified indoor laboratory test wheel. Sustained high temperature can cause the material of the tire to degenerate and reduce tire life, and excessive temperature can lead to sudden tire failure. The grade C corresponds to a level of performance which all passenger car tires must meet under the Federal Motor Vehicle Safety Standard No. 109. Grades B and A represent higher levels of performance on the laboratory test wheel than the minimum required by law.

**Warning:** The temperature grade for this tire is established for a tire that is properly inflated and not overloaded. Excessive speed, underinflation, or excessive loading, either separately or in combination, can cause heat buildup and possible tire failure.

Those grades are molded on the sidewalls of passenger car tires.

While the tires available as standard or optional equipment on General Motors vehicles may vary with respect to these grades, all such tires meet General Motors performance standards and have been approved for use on General Motors vehicles. All passenger type (P Metric) tires must conform to Federal safety requirements in addition to these grades.

## Wheel Alignment and Tire Balance

The wheels on your vehicle were aligned and balanced carefully at the factory to give you the longest tire life and best overall performance.

In most cases, you will not need to have your wheels aligned again. However, if you notice unusual tire wear or your vehicle pulling one way or the other, the alignment may need to be reset. If you notice your vehicle vibrating when driving on a smooth road, your wheels may need to be rebalanced.

## Wheel Replacement

Replace any wheel that is bent, cracked or badly rusted. If wheel nuts keep coming loose, the wheel, wheel bolts, and wheel nuts should be replaced. If the wheel leaks air out, replace it (except some aluminum wheels, which can sometimes be repaired). See your Buick dealer if any of these conditions exist.

Your dealer will know the kind of wheel you need.

Each new wheel should have the same load carrying capacity, diameter, width, offset, and be mounted the same way as the one it replaces.



If you need to replace any of your wheels, wheel bolts, or wheel nuts, replace them only with new GM original equipment parts. This way, you will be sure you have the right wheel, wheel bolts, and wheel nuts for your Buick model.

 **CAUTION:**

Using the wrong replacement wheels, wheel bolts, or wheel nuts on your vehicle can be dangerous. It could affect the braking and handling of your vehicle, make your tires lose air and make you lose control. You could have a collision in which you or others could be injured. Always use the correct wheel, wheel bolts, and wheel nuts for replacement.

**NOTICE:**

The wrong wheel can also cause problems with bearing life, brake cooling, speedometer/odometer calibration, headlight aim, bumper height, vehicle ground clearance, and tire or tire chain clearance to the body and chassis.

## Used Replacement Wheels

 **CAUTION:**

Putting a used wheel on your vehicle is dangerous. You can't know how it's been used or how many miles it's been driven. It could fail suddenly and cause an accident. If you have to replace a wheel, use a **new GM original equipment wheel**.

## Tire Chains

**NOTICE:**

Use tire chains only when you must. Use only SAE Class "S" type chains that are the proper size for your tires. Install them on the front tires and tighten them as tightly as possible with the ends securely fastened. Drive slowly and follow the chain manufacturer's instructions. If you can hear the chains contacting your vehicle, stop and retighten them. If the contact continues, slow down until it stops. Driving too fast with chains on will damage your vehicle.



## Appearance Care

### CAUTION:

Cleaning products can be hazardous. Some are toxic. Others can burst into flame if you strike a match or get them on a hot part of the vehicle. Some are dangerous if you breathe their fumes in a closed space. When you use anything in a container to clean your Buick, be sure to follow the instructions. And always open your doors or windows when you're cleaning the inside.

**Never use these to clean your vehicle:**

- Gasoline
- Benzene
- Naphtha
- Carbon Tetrachloride
- Acetone
- Paint Thinner
- Turpentine
- Lacquer Thinner
- Nail Polish Remover

They can all be hazardous—some more than others—and they can all damage your vehicle, too.

### NOTICE:

Don't use any of these unless this manual says you can. In many uses, they will damage your vehicle:

- Laundry Soap
- Bleach
- Reducing Agents

### Cleaning the Inside of Your Buick

Use a vacuum cleaner often to get rid of dust and loose dirt. Wipe vinyl with a clean, damp cloth.

Your Buick dealer has two GM cleaners—a solvent-type spot lifter and a foam-type powdered cleaner. They will clean normal spots and stains very well.

Here are some cleaning tips:

- Always read the instructions on the cleaner label.
- Clean up stains as soon as you can—before they set.
- Use a clean cloth or sponge, and change to a clean area often. A soft brush may be used if stains are stubborn.
- Use solvent-type cleaners in a well-ventilated area only. If you use them, don't saturate the stained area.
- If a ring forms after spot cleaning, clean the entire area immediately or it will set.

## Using Foam-Type Cleaner on Fabric

- Vacuum and brush the area to remove any loose dirt.
- Always clean a whole trim panel or section. Mask surrounding trim along stitch or welt lines.
- Mix Multi-Purpose Powdered Cleaner following the directions on the container label.
- Use suds only and apply with a clean sponge.
- Don't saturate the material.
- Don't rub it roughly.
- As soon as you've cleaned the section, use a sponge to remove the suds.
- Rinse the section with a clean, wet sponge.
- Wipe off what's left with a slightly damp paper towel or cloth.
- Then dry it immediately with an air hose, a hair dryer or a heat lamp.

### **NOTICE:**

**Be careful with a hair dryer or heat lamp. You could scorch the fabric.**

- Wipe with a clean cloth.

## Using Solvent-Type Cleaner on Fabric

First, see if you have to use solvent-type cleaner at all. Some spots and stains will clean off better with just water and mild soap.

If you need to use it, then:

- Gently scrape excess soil from the trim material with a clean, dull knife or scraper. Use very little cleaner, light pressure and clean cloths (preferably cheesecloth). Cleaning should start at the outside of the stain, "feathering" toward the center. Keep changing to a clean section of the cloth.
- When you clean a stain from fabric, immediately dry the area with an air hose, hair dryer, or heat lamp to help prevent a cleaning ring. (See the previous NOTICE.)



## Special Cleaning Problems

**Greasy or Oily Stains:** Like grease, oil, butter, margarine, shoe polish, coffee with cream, chewing gum, cosmetic creams, vegetable oils, wax crayon, tar and asphalt.

- Carefully scrape off excess stain.
- Then follow the solvent-type instructions above.
- Shoe polish, wax crayon, tar and asphalt will stain if left on a vehicle seat fabric. They should be removed as soon as possible. Be careful, because the cleaner will dissolve them and may cause them to bleed.

**Non-Greasy Stains:** Like catsup, coffee (black), egg, fruit, fruit juice, milk, soft drinks, wine, vomit, urine and blood.

- Carefully scrape off excess stain, then sponge the soiled area with cool water.
- If a stain remains, follow the foam-type instructions above.
- If an odor lingers after cleaning vomit or urine, treat the area with a water/baking soda solution: 1 teaspoon (5 ml) of baking soda to 1 cup (250 ml) of lukewarm water.
- Finally, if needed, clean lightly with solvent-type cleaner.

**Combination Stains:** Like candy, ice cream, mayonnaise, chili sauce and unknown stains.

- Carefully scrape off excess stain, then clean with cool water and allow to dry.
- If a stain remains, clean it with solvent-type cleaner.

## Cleaning Vinyl

Just use warm water and a clean cloth.

- Rub with a clean, damp cloth to remove dirt. You may have to do it more than once.
- Things like tar, asphalt and shoe polish will stain if you don't get them off quickly. Use a clean cloth and solvent-type vinyl/leather cleaner.

## Cleaning the Top of the Instrument Panel

Use only mild soap and water to clean the top surfaces of the instrument panel. Sprays containing silicones or waxes may cause annoying reflections in the windshield and even make it difficult to see through the windshield under certain conditions.

## Care of Safety Belts

Keep belts clean and dry.



### **CAUTION:**

**Do not bleach or dye safety belts. If you do, it may severely weaken them. In a crash they might not be able to provide adequate protection. Clean safety belts only with mild soap and lukewarm water.**

## Glass

Glass should be cleaned often. GM Glass Cleaner (GM Part No. 1050427) or a liquid household glass cleaner will remove normal tobacco smoke and dust films.

Don't use abrasive cleaners on glass, because they may cause scratches. Avoid placing decals on the inside rear window, since they may have to be scraped off later.

If abrasive cleaners are used on the inside of the rear window, an electric defogger element may be damaged. Any temporary license should not be attached across the defogger grid.

## Cleaning the Outside of the Windshield and Wiper Blades

If the windshield is not clear after using the windshield washer, or if the wiper blade chatters when running, wax or other material may be on the blade or windshield.

Clean the outside of the windshield with GM Windshield Cleaner, Bon-Ami Powder® (GM Part No. 1050011). The windshield is clean if beads do not form when you rinse it with water.

Clean the blade by wiping vigorously with a cloth soaked in full strength windshield washer solvent. Then rinse the blade with water.

Wiper blades should be checked on a regular basis and replaced when worn.

## Cleaning the Outside of Your Buick

The paint finish on your vehicle provides beauty, depth of color, gloss retention and durability.

### Washing Your Vehicle

The best way to preserve your vehicle's finish is to keep it clean by washing it often with lukewarm or cold water.



Don't wash your vehicle in the direct rays of the sun. Don't use strong soaps or chemical detergents. Use liquid hand, dish or car washing (non-detergent) soaps. Don't use cleaning agents that contain acid or abrasives. All cleaning agents should be flushed promptly and not allowed to dry on the surface, or they could stain. Dry the finish with a soft, clean chamois or a 100% cotton towel to avoid surface scratches and water spotting.

High pressure car washes may cause water to enter your vehicle.

## Finish Care

Occasional waxing or mild polishing of your Buick may be necessary to remove residue from the paint finish. You can get GM approved cleaning products from your dealer. (See "Appearance Care and Maintenance Materials" in the Index.)

Your Buick has a "basecoat/clearcoat" paint finish. The clearcoat gives more depth and gloss to the colored basecoat.

### **NOTICE:**

**Machine compounding or aggressive polishing on a basecoat/clearcoat paint finish may dull the finish or leave swirl marks.**

## Aluminum Wheels (If So Equipped)

Your aluminum wheels have a protective coating similar to the painted surface of your car. Don't use strong soaps, chemicals, chrome polish, or other abrasive cleaners on them because you could damage this coating. After rinsing thoroughly, a wax may be applied.

### **NOTICE:**

**If you have aluminum wheels, don't use an automatic vehicle wash that has hard silicon carbide cleaning brushes. These brushes can take off the protective coating.**

## White Sidewall Tires

Your Buick dealer has a GM White Sidewall Tire Cleaner. You can use a stiff brush with it.

## Weatherstrips

These are places where glass or metal meets rubber. Silicone grease there will make them last longer, seal better, and not squeak. Apply silicone grease with a clean cloth at least every six months.



## **Sheet Metal Damage**

If your vehicle is damaged and requires sheet metal repair or replacement, make sure the body repair shop applies anti-corrosion material to the parts repaired or replaced to restore corrosion protection.

## **Foreign Material**

Calcium chloride and other salts, ice melting agents, road oil and tar, tree sap, bird droppings, chemicals from industrial chimneys, and other foreign matter can damage your vehicle's finish if they remain on painted surfaces. Use cleaners that are marked safe for painted surfaces for these stains.

## **Finish Damage**

Any stone chips, fractures or deep scratches in the finish should be repaired right away. Bare metal will corrode quickly and may develop into a major repair expense.

Minor chips and scratches can be repaired with touch-up materials available from your dealer or other service outlets. Larger areas of finish damage can be corrected in your dealer's body and paint shop.

## **Underbody Maintenance**

Chemicals used for ice and snow removal and dust control can collect on the underbody. If these are not removed, accelerated corrosion (rust) can occur on the underbody parts such as fuel lines, frame, floor pan, and exhaust system even though they have corrosion protection.

At least every spring, flush these materials from the underbody with plain water. Clean any areas where mud and other debris can collect. Dirt packed in closed areas of the frame should be loosened before being flushed. Your dealer or an underbody vehicle washing system can do this for you.

## **Chemical Paint Spotting**

Some weather and atmospheric conditions can create a chemical fallout. Airborne pollutants can fall upon and attack painted surfaces on your vehicle. This damage can take two forms: blotchy, ringlet-shaped discolorations, and small irregular dark spots etched into the paint surface.

Although no defect in the paint job causes this, Buick will repair, at no charge to the owner, the surfaces of new vehicles damaged by this fallout condition within 12 months or 12,000 miles (20 000 km) of purchase, whichever comes first.

## Appearance Care and Maintenance Materials

You can get these from your Buick dealer.

DESCRIPTION	USAGE	PART NUMBER	SIZE
Magic Mirror Creme Wax	Exterior cleaner and polish	12345343	16 oz. (0.473L)
Spray-A-Squeak	Weatherstrips	1052277	12 oz. (0.354L)
Silicone Grease	Stops squeaks	1052863	1 oz. (0.028kg)
Tar and Road Oil Remover	Also removes old waxes, polishes	1050172	16 oz. (0.473L)
Chrome Cleaner and Polish	Removes rust and corrosion	1050173	16 oz. (0.473L)
White Sidewall Tire Cleaner	Cleans white and black tires	1050174	16 oz. (0.473L)
Vinyl/Leather Cleaner	Spot and stain removal	1050214	32 oz. (0.946L)
Fabric Cleaner	Spot and stain removal	1050244	16 oz. (0.473L)
Glass Cleaner	Also spot cleans vinyls	1050427	23 oz. (0.680L)
Multi-Purpose Powdered Cleaner	Cleans vinyl and cloth, also, tires and mats	1050429	6 lb. (2.72kg)
Lubriplate (White Grease)	For hood, trunk, door hinges and latches	1052349	12 oz. (0.340kg)
Preservatone	Vinyl Top Dressing	1051055	16 oz. (0.473L)
Spot Lifter	For cloth	1051398*	8 oz. (0.237L)
Washer Solvent	Windshield-washing system	1051515	32 oz. (0.946L)
Wash-Wax (concentrate)	Exterior Wash	1052870	16 oz. (0.473L)

\*Not recommended for pigskin suede leather.

See your General Motors dealers for these products.

See your Maintenance Schedule for other products.



## Vehicle Identification Number (VIN)

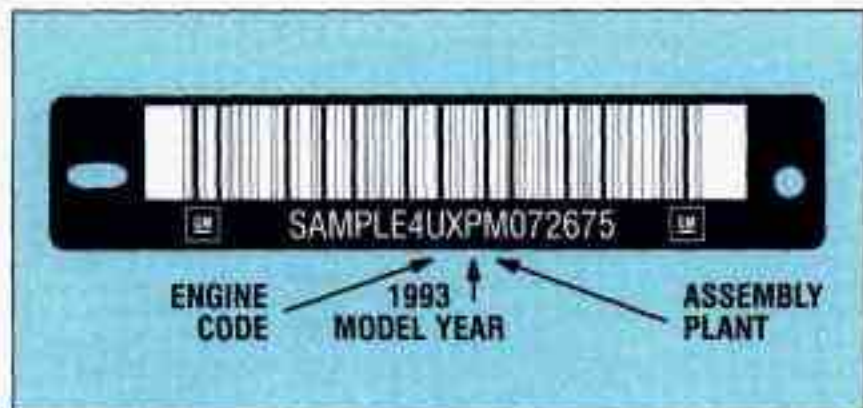

This is the legal identifier for your Buick. It appears on a plate in the front corner of the instrument panel, on the driver's side. You can see it if you look through the windshield from outside your vehicle. The VIN also appears on the Vehicle Certification and Service Parts labels and the certificates of title and registration.

### Engine Identification

The eighth character in your VIN is the engine code for your GM engine. This code will help you identify your engine, specifications, and replacement parts in this section.

## Service Parts Identification Label

You'll find this label on your spare tire cover in the coupe or sedan. In the wagon, you'll find the label on the wheel well (remove the spare tire cover to expose the wheel well). It's very helpful if you ever need to order parts. On this label is:

- Your VIN.
- Its model designation.
- Paint information.
- A list of all production options and special equipment.

Be sure that this label is not removed from the vehicle.

## Add-On Electrical Equipment

### NOTICE:

**Don't add anything electrical to your Buick unless you check with your dealer first. Some electrical equipment can damage your vehicle and the damage wouldn't be covered by your warranty. Some of it can just keep other things from working as they should.**



## Fuses & Circuit Breakers



The wiring circuits in your vehicle are protected from short circuits by a combination of fuses, circuit breakers, and fusible thermal links in the wiring itself. This greatly reduces the chance of fires caused by electrical problems.

The fuse panel is located inside the glove box, on the left side.

To change a fuse, open the glove box. Pull down on the fuse panel latch and open the door. Pull the fuse straight out.

To identify and check fuses, refer to the Fuse Usage chart.

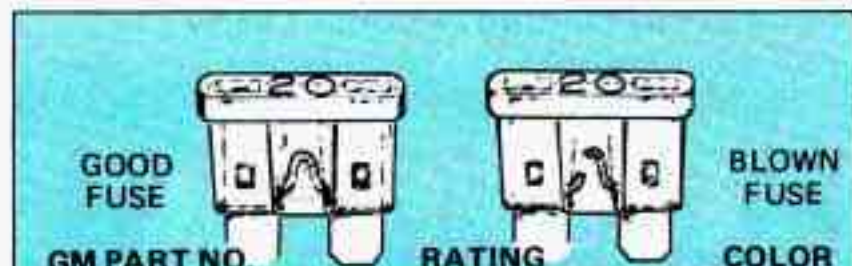

GM PART NO.	RATING	COLOR
12004003	3 AMP	VIOLET
12004005	5 AMP	TAN
12004006	7.5 AMP	BROWN
12004007	10 AMP	RED
12004008	15 AMP	LIGHT BLUE
12004009	20 AMP	YELLOW
12004010	25 AMP	WHITE
12004011	30 AMP	LIGHT GREEN

Look at the silver-colored band inside the fuse. If the band is broken or melted, replace the fuse. Be sure you replace a bad fuse with a new one of the identical size and rating.

## Fuse Usage

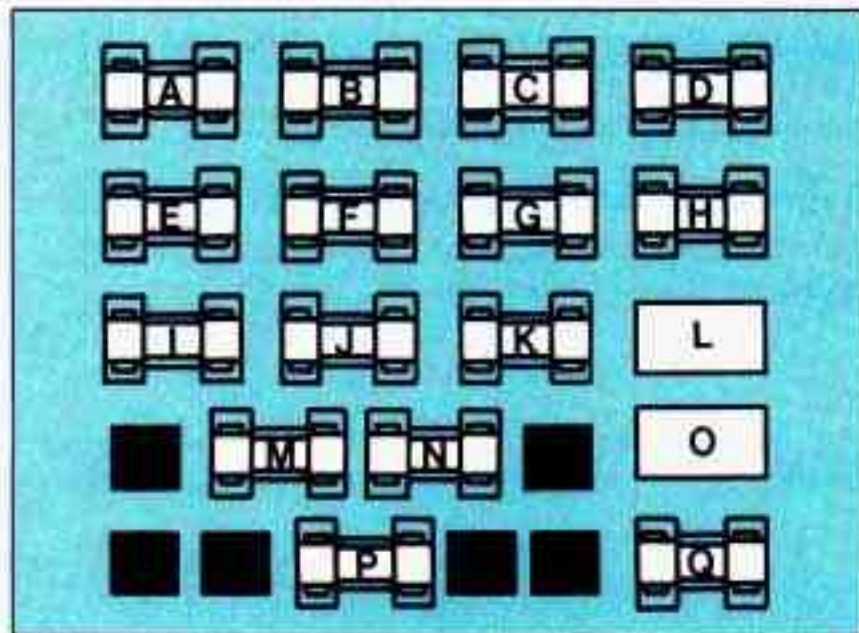

Fuse	Rating (AMPS)	Circuitry
A	15	ECM; MAF Sensor (3300 Engine only)
B	20	ECM Injectors/Coil
C	10	Eng. A/C Relay; EGR Solenoid; Canister Purge Solenoid
D	10	Fan/Elect; Generator; DRL Module
E	15	Turn Signal Flasher; Back-Up Lights; Trunk/Liftgate Release

Fuse	Rating (AMPS)	Circuitry
F	10	Supplemental Inflatable Restraint (Air Bag)
G	20	Tail; Park; Side Marker; License Plate; Stop/Turn Signal
H	20	Heater/Air Conditioner
I	10	Gages; Warning Indicators; Torque Convert Clutch; Audible Warning System; Computer Command Control; Trunk Release; Brake Warning Indicator; Rear Defog Switch; Speedometer
J	20	Stop Lights; Hazard Flashers
K	20	Interior, Underhood, Courtesy, I/P, Trunk Lights; Door Locks; Horn Relay, Passive Restraint System, Deck Lid Release, Power Antenna
L	30*	Liftgate Release; Power Windows
M	5	Illumination for: I/P, Radio, Pod Lights, Ashtray, Console Light, Heater-A/C Control, Defog Switch, Headlight Switch
N	10	Radio, Cruise Control
O	30*	Seats, Door Locks, Rear Defog
P	25	Windshield Wipe/Wash
Q	20	Cigarette Lighter
	15	Safety Belt/Chime (ICAM) Module (Located behind the fuse block, above the hush panel.)
	15	Remote Lock Control (Located behind the fuse block, above the hush panel.)
	15	Fuel Pump, ECM (Located under the hood.)

\*Circuit Breaker

## **Headlights**

The headlight wiring is protected by a circuit breaker in the light switch. An electrical overload will cause the lights to go on and off or, in some cases, to remain off. If this happens, have your headlight system checked right away.

## **Windshield Wipers**

The windshield wiper motor is protected by a circuit breaker and a fuse. If the motor overheats due to heavy snow, etc., the wiper will stop until the motor cools. If the overload is caused by some electrical problem, have it fixed.

## **Power Windows and Other Power Options**

Circuit breakers in the fuse panel protect the power windows and other power accessories. When the current load is too heavy, the circuit breaker opens and closes, protecting the circuit until the problem is fixed.

## **Cigarette Lighter Fuse and Safety Belt Fuse**

These fuses are located behind the glove box. The fuse holders are taped together with gray tape.



## Century Dimensions

Inches unless otherwise noted.

Overall:	COUPE	SEDAN	WAGON
Length .....	189.1	189.1	190.9
Width .....	69.4	69.4	69.4
Height .....	53.7	54.2	54.2
Wheelbase .....	104.9	104.9	104.9
Front Tread .....	58.7	58.7	58.7
Rear Tread .....	56.7	56.7	56.7
<b>Interior Front:</b>			
Leg Room .....	42.1	42.1	42.1
Head Room .....	38.6	38.6	38.6
Shoulder Room .....	55.8	55.9	55.9
Hip Room .....	50.2	50.0	50.0
<b>Interior Rear:</b>			
Leg Room .....	35.9	35.9	34.8
Head Room .....	38.3	38.3	38.9
Shoulder Room .....	57.0	56.0	56.0
Hip Room .....	53.6	54.3	54.3
<b>Trunk Capacity—Cubic Feet</b> .....	16.2	16.2	41.6
<b>Number of Passengers:</b>			
Front .....	3	3	3
Rear .....	3	3	3
Rear-Facing Third Seat .....	—	—	2
<b>Base Curb Weight—Pounds</b> .....	2862	2914	3054

## Replacement Bulbs

APPLICATION	NUMBER
<b>Exterior</b>	
Headlight	
High Beam .....	9005
Low Beam .....	9006
Park/Turn .....	2057
Side Marker .....	194
Backup .....	1156
High Level Stop (w/o luggage carrier) .....	1141
High Level Stop (w/luggage carrier) .....	577
License .....	194
Side Marker .....	194
Tail/Stop .....	194
Tail/Stop/Turn .....	2057
Underhood .....	561
<b>Interior</b>	
Ashtray .....	194
Door Courtesy .....	214-2
Dome .....	211-2
Front Reading .....	906
Glove Box .....	194
Map .....	168
Rear Dome (Wagon) .....	211-2
Trunk .....	1003
Vanity Mirror .....	124

## Capacities and Specifications

Engine Code N<sup>1</sup> (LG7)<sup>2</sup> 3300 (3.3L) V6 MFI

**Belt Tensions**—Automatically controlled by a self-tensioning idler pulley. Tension adjustment should never be necessary.

### Cooling System Capacity

Complete System . . . . .	10.5 Quarts	9.9 Liters
Radiator and Recovery Tank Only . . . . .	3.4 Quarts	3.2 Liters

**Crankcase Capacity (Less Filter)** . . . . . 4 Quarts 3.8 Liters

**Air Conditioning Refrigerant Capacity (R12)** . . . . . 2.38 Pounds 1.07 Kilograms

Not all air conditioning refrigerants are the same. If the air conditioning system in your vehicle needs refrigerant, be sure the proper refrigerant is used. If you're not sure, ask your Buick dealer.

**Fuel Tank Capacity** . . . . . 16.5 Gallons 62.6 Liters

<sup>1</sup> 8th Character of the Vehicle Identification Number.

<sup>2</sup> Made in a GM plant in the United States.

### Automatic Transaxle Capacity

#### 3T40 (3-Speed):

Pan Removal and Replacement .....	4 Quarts	3.8 Liters
After Complete Overhaul .....	7 Quarts	6.6 Liters

#### 4T60 (4-Speed):

Pan Removal and Replacement .....	6 Quarts	5.7 Liters
After Complete Overhaul .....	8 Quarts	7.6 Liters

### Power Steering

Pump Only .....	1 Pint	0.5 Liters
Complete System .....	1.6 Pints	0.75 Liters

### Maintenance Item Part Numbers<sup>3</sup>

Air Cleaner .....	A974C
Oil Filter .....	PF47
PCV Valve .....	CV899C
Spark Plug .....	*41-600, Gap 0.060" (1.52 mm)

<sup>3</sup> Part numbers are AC type.



## Capacities and Specifications

### Engine Code 4<sup>1</sup> (LN2)<sup>2</sup> 2.2L I4 PFI

**Belt Tensions**—Automatically controlled by an idler pulley. Tension adjustment should never be necessary.

#### Cooling System Capacity

Complete System .....	8.3 Quarts	7.9 Liters
Radiator and Recovery Tank Only .....	3.4 Quarts	3.2 Liters

**Crankcase Capacity (Less Filter)** ..... 4 Quarts      3.8 Liters

**Air Conditioning Refrigerant Capacity (R12)** ..... 2.38 Pounds      1.07 Kilograms

Not all air conditioning refrigerants are the same. If the air conditioning system in your vehicle needs refrigerant, be sure the proper refrigerant is used. If you're not sure, ask your Buick dealer.

**Fuel Tank Capacity** ..... 16.5 Gallons      62.6 Liters

<sup>1</sup> 8th Character of the Vehicle Identification Number.

<sup>2</sup> Made in a GM plant in the United States.

### Automatic Transaxle Capacity

3T40 (3-Speed):

Pan Removal and Replacement .....	4 Quarts	3.8 Liters
After Complete Overhaul .....	7 Quarts	6.6 Liters

### Power Steering

Pump Only .....	1 Pint	0.47 Liters
Complete System .....	1.7 Pints	0.82 Liters

### Maintenance Item Part Numbers<sup>3</sup>

Air Cleaner .....	A905C
Oil Filter .....	PF47
PCV Valve .....	CV900C
Spark Plug .....	•R44LTSMA, Gap 0.045" (1.14 mm)

<sup>3</sup> Part numbers are AC type.







## Part 7 Maintenance Schedule

**IMPORTANT**  
**KEEP ENGINE OIL**  
**AT THE PROPER**  
**LEVEL AND CHANGE AS**  
**RECOMMENDED**

This part covers the maintenance required for your Buick. Your vehicle needs these services to retain its safety, dependability and emission control performance.



***Protection  
 Plan***

Have you purchased the  
**GM Protection Plan?**  
 The Plan supplements your  
 new vehicle warranties.  
 See your Buick dealer for details.

**Part 7 includes:**

**Introduction**

A Word About Maintenance .....	276
Your Vehicle and the Environment .....	276
How This Part is Organized .....	276

**A. Scheduled Maintenance Services**

Using Your Maintenance Schedules .....	278
Selecting the Right Schedule .....	279
Schedule I .....	280
Schedule II .....	282
Explanation of Scheduled Maintenance Services .....	284

**B. Owner Checks and Services**

At Each Fuel Fill .....	287
At Least Once a Month .....	287
At Least Once a Year .....	288

**C. Periodic Maintenance Inspections** ..... 290

**D. Recommended Fluids and Lubricants** ..... 292

**E. Maintenance Record** ..... 295

# Introduction

## A Word About Maintenance

We at General Motors want to help you keep your vehicle in good working condition. But we don't know exactly how you'll drive it. You may drive very short distances only a few times a week. Or you may drive long distances all the time in very hot, dusty weather. You may use your vehicle in making deliveries. Or you may drive it to work, to do errands or in many other ways.

Because of all the different ways people use their GM vehicles, maintenance needs vary. You may even need more frequent checks and replacements than you will find in the schedules in this part. So please read this part and note how you drive. If you have any questions on how to keep your vehicle in good condition, see your Buick dealer, the place many GM owners choose to have their maintenance work done. Your dealer can be relied upon to use proper parts and practices.

## Your Vehicle and the Environment

Proper vehicle maintenance not only helps to keep your vehicle in good working condition, but also helps the environment. All recommended maintenance procedures are important. Improper vehicle maintenance or the removal of important components can significantly affect the quality of the air we breathe. Improper fluid levels or even the wrong tire inflation can increase the level of emissions from your vehicle. To help protect our environment, and to help keep your vehicle in good condition, please maintain your vehicle properly.

## How This Part is Organized

The remainder of this part is divided into five sections:

"Section A: Scheduled Maintenance Services" shows what to have done and how often. Some of these services can be complex, so unless you are technically qualified and have the necessary equipment, you should let your dealer's service department or another qualified service center do these jobs.

 **CAUTION:**

**Performing maintenance work on a vehicle can be dangerous. In trying to do some jobs, you can be seriously injured. Do your own maintenance work only if you have the required know-how and the proper tools and equipment for the job. If you have any doubt, have a qualified technician do the work.**

If you are skilled enough to do some work on your vehicle, you will probably want to get the service information GM publishes. You will find a list of publications and how to get them in this manual. See “Service Publications” in the Index.

“Section B: Owner Checks and Services” tells you what should be checked whenever you stop for fuel. It also explains what you can easily do to help keep your vehicle in good condition.

“Section C: Periodic Maintenance Inspections” explains important inspections that your Buick dealer’s service department or another qualified service center should perform.

“Section D: Recommended Fluids and Lubricants” lists some products GM recommends to help keep your vehicle properly maintained. These products, or their equivalents, should be used whether you do the work yourself or have it done.

“Section E: Maintenance Record” provides a place for you to record the maintenance performed on your vehicle. Whenever any maintenance is performed, be sure to write it down in this section. This will help you determine when your next maintenance should be done. In addition, it is a good idea to keep your maintenance receipts. They may be needed to qualify your vehicle for warranty repairs.



## Section A: Scheduled Maintenance Services

### Using Your Maintenance Schedules

This section tells you the maintenance services you should have done and when you should schedule them. Your Buick dealer knows your vehicle best and wants you to be happy with it. If you go to your dealer for your service needs, you'll know that GM-trained and supported service people will perform the work using genuine GM parts.

These schedules are for vehicles that:

- carry passengers and cargo within recommended limits. You will find these limits on your vehicle's Tire-Loading Information label. See "Loading Your Vehicle" in the Index.
- are driven on reasonable road surfaces within legal driving limits.
- use the recommended unleaded fuel. See "Fuel" in the Index.

## Selecting the Right Schedule

First you'll need to decide which of the two schedules is right for your vehicle. Here is how to decide which schedule to follow:

### Schedule I

Is any one of these true for your vehicle?

- Most trips are less than 4 miles (6 km).
- Most trips are less than 10 miles (16 km) when outside temperatures are below freezing.
- The engine is at low speed most of the time (as in door-to-door delivery, or in stop-and-go traffic).
- You operate your vehicle in dusty areas.
- You tow a trailer.

If any one (or more) of these is true for your driving, follow Schedule I.

### Schedule II

Follow Schedule II **only** if none of the above conditions is true.

## Schedule I

Follow Schedule I if your vehicle is **MAINLY** driven under one or more of the following conditions:

- When most trips are less than 4 miles (6 km).
- When most trips are less than 10 miles (16 km) and outside temperatures remain below freezing.
- When most trips include extended idling and/or frequent low-speed operation, as in stop-and-go traffic.
- When towing a trailer.
- When operating in dusty areas.

**Schedule I should also be followed if the vehicle is used for delivery service, police, taxi or other commercial applications.**

\* An Emission Control Service.

☆ The U.S. Environmental Protection Agency has determined that the failure to perform this maintenance item will not nullify the emission warranty or limit recall liability prior to the completion of vehicle useful life. General Motors, however, urges that all recommended maintenance services be performed at the indicated intervals and the maintenance be recorded in "Section E: Maintenance Record."

ITEM NO.	TO BE SERVICED See "Explanation of Scheduled Maintenance Services" following Schedules I and II.	WHEN TO PERFORM Miles (kilometers) or Months (whichever occurs first).
1	Engine Oil Change and Oil Filter Change*	Every 3,000 Miles (5 000 km) or 3 Months.
2	Chassis Lubrication	Every other oil change.
3	Throttle Body Mounting Bolt Torque* (3300 V6 Code N engine only)	At 6,000 Miles (10 000 km) only.
4	Tire and Wheel Rotation and Inspection	At 6,000 Miles (10 000 km) and every 15,000 Miles (25 000 km) or as necessary.
5	Engine Accessory Drive Belt Inspection	Every 30,000 Miles (50 000 km) or 24 Months.
6	Cooling System Service*	Every 30,000 Miles (50 000 km) or 24 Months.
7	Transmission Service	See "Explanation of Scheduled Maintenance Services" following Schedules I and II.
8	Spark Plug Replacement*	Every 30,000 Miles (50 000 km).
9	Spark Plug Wire Inspection* ☆	Every 30,000 Miles (50 000 km).
10	EGR System Inspection* ☆ (2.2L L4 Code 4 engine only)	Every 30,000 miles (50 000 km)
11	Air Cleaner Filter Replacement*	Every 30,000 Miles (50 000 km)
12	Fuel Tank, Cap and Lines Inspection* ☆	Every 30,000 Miles (50 000 km).



The services shown in this schedule up to 48,000 miles (80 000 km) are to be performed after 48,000 miles at the same intervals.

**MILES (000)**

3	6	9	12	15	18	21	24	27	30	33	36	39	42	45	48
---	---	---	----	----	----	----	----	----	----	----	----	----	----	----	----

**KILOMETERS (000)**

5	10	15	20	25	30	35	40	45	50	55	60	65	70	75	80
---	----	----	----	----	----	----	----	----	----	----	----	----	----	----	----

•	•	•	•	•	•	•	•	•	•	•	•	•	•	•	•
	•		•		•		•		•		•		•		•
	•														
	•					•					•				
									•						
									•						
									•						
									•						
									•						
									•						
									•						

## Schedule II

Follow Schedule II **ONLY** if none of the driving conditions specified in Schedule I apply.

ITEM NO.	TO BE SERVICED See "Explanation of Scheduled Maintenance Services" following Schedules I and II.	WHEN TO PERFORM Miles (kilometers) or Months (whichever occurs first).
1	Engine Oil Change *	Every 7,500 Miles (12,500 km) or 12 Months.
	Oil Filter Change *	At first and every other oil change.
2	Chassis Lubrication	Every 7,500 Miles (12,500 km) or 12 Months.
3	Throttle Body Mounting Bolt Torque* (3300 V6 Code N engine only)	At 7,500 Miles (12,500 km) only.
4	Tire and Wheel Rotation and Inspection	At 7,500 Miles (12,500 km) and then every 15,000 Miles (25,000 km) or as necessary.
5	Engine Accessory Drive Belt Inspection	Every 30,000 Miles (50,000 km) or 24 Months.
6	Cooling System Service*	Every 30,000 Miles (50,000 km) or 24 Months.
7	Transmission Service	See "Explanation of Scheduled Maintenance Services" following Schedules I and II.
8	Spark Plug Replacement *	Every 30,000 Miles (50,000 km).
9	Spark Plug Wire Inspection* ☆	Every 30,000 Miles (50,000 km).
10	EGR System Inspection * ☆ (2.2L L4 Code 4 engine only)	Every 30,000 Miles (50,000 km)
11	Air Cleaner Filter Replacement*	Every 30,000 Miles (50,000 km).
12	Fuel Tank, Cap and Lines Inspection* ☆	Every 30,000 Miles (50,000 km).

\*An Emission Control Service.

☆ The U.S. Environmental Protection Agency has determined that the failure to perform this maintenance item will not nullify the emission warranty or limit recall liability prior to the completion of vehicle useful life. General Motors, however, urges that all recommended maintenance services be performed at the indicated intervals and the maintenance be recorded in "Section E: Maintenance Record."

The services shown in this schedule up to 45,000 miles (75 000 km) are to be performed after 45,000 miles at the same intervals.

**MILES (000)**

7.5	15	22.5	30	37.5	45
<b>KILOMETERS (000)</b>					
12.5	25	37.5	50	62.5	75
•	•	•	•	•	•
•		•		•	
•	•	•	•	•	•
•					
•		•		•	
			•		
			•		
			•		
			•		
			•		
			•		
			•		



## Explanation of Scheduled Maintenance Services

Below are explanations of the services listed in Schedule I and Schedule II.

The proper fluids and lubricants to use are listed in Section D. Make sure whoever services your vehicle uses

these. All parts should be replaced and all necessary repairs done before you or anyone else drives the vehicle.

NOTE: To determine your engine's displacement and code, see "Engine Identification" in the Index.

### ITEM NO. SERVICE

- 1 Engine Oil and Filter Change\***—Always use SG Energy Conserving II oils of proper viscosity. The "SG" designation may be shown alone or in combination with others, such as "SG/CC," "SG/CD" or "SE, SG, CC," etc.  
To determine the preferred viscosity for your vehicle's engine (e.g., SAE 5W-30 or SAE 10W-30), see "Engine Oil" in the Index.
- 2 Chassis Lubrication**—Lubricate the transaxle shift linkage, parking brake cable guides, underbody contact points and linkage. If your vehicle is equipped with grease fittings, lubricate the suspension and steering linkage.

### ITEM NO. SERVICE

- 3 Throttle Body Mounting Bolt Torque (3300 V6 Code N Engine Only)\***—Check the torque of the mounting bolts and/or nuts.
- 4 Tire and Wheel Rotation and Inspection**—For proper wear and maximum tire life, rotate your tires following the instructions in this manual. See "Tires, Inspection & Rotation" in the Index. Check the tires for uneven wear or damage. If you see irregular or premature wear, check the wheel alignment. Check for damaged wheels also.

\*An Emission Control Service.

☆The U.S. Environmental Protection Agency has determined that the failure to perform this maintenance item will not nullify the emission warranty or limit recall liability prior to the completion of vehicle useful life. General Motors, however, urges that all recommended maintenance services be performed at the indicated intervals and the maintenance be recorded in "Section E: Maintenance Record."

**ITEM  
NO.****SERVICE**

- 5 Engine Accessory Drive Belt Inspection**—Inspect the belt for cracks, fraying, wear and proper tension. Replace as needed.
- 6 Cooling System Service\***—Drain, flush and refill the system with new or approved recycled coolant conforming to GM Specification 1825M. Keep coolant at the proper mixture as specified. See “Engine Coolant” in the Index. This provides proper freeze protection, corrosion inhibitor level and engine operating temperature. Inspect hoses and replace if they are cracked, swollen or deteriorated. Tighten screw-type hose clamps. Clean the outside of the radiator and air conditioning condenser. Wash the pressure cap and neck.
- To help ensure proper operation, we recommend a pressure test of both the cooling system and the pressure cap.

**ITEM  
NO.****SERVICE**

- 7 Transaxle Service**—Change both the fluid and filter every 15,000 miles (25 000 km) if the vehicle is mainly driven under one or more of these conditions:
- In heavy city traffic where the outside temperature regularly reaches 90°F (32°C) or higher.
  - In hilly or mountainous terrain.
  - When doing frequent trailer towing.
  - Uses such as found in taxi, police car or delivery service.
- If you do not use your vehicle under any of these conditions, change both the fluid and filter every 100,000 miles (160 000 km).
- 8 Spark Plug Replacement\***—Replace spark plugs with the proper type. See “Specifications and Capacities” in the Index.

**ITEM  
NO. SERVICE**

- 9 Spark Plug Wire Inspection\***☆—Inspect for burns, cracks or other damage. Check the boot fit at the distributor and at the spark plugs. Replace wires as needed.
- 10 Exhaust Gas Recirculation (EGR) System Inspection (2.2L Code 4 engine only)\***☆—Conduct the EGR system service as described in the service manual. To purchase a service manual, see "Service Publications" in the Index.

**ITEM  
NO. SERVICE**

- 11 Air Cleaner Filter Replacement\***—Replace every 30,000 miles (50 000 km) or more often under dusty conditions. Ask your dealer for the proper replacement intervals for your driving conditions.
- 12 Fuel Tank, Cap and Lines Inspection\***☆—Inspect fuel tank, cap and lines (including fuel rails and injection assembly, if equipped) for damage or leaks. Inspect fuel cap gasket for an even filler neck imprint or any damage. Replace parts as needed. Periodic replacement of the fuel filter is not required.

\*An Emission Control Service.

☆The U.S. Environmental Protection Agency has determined that the failure to perform this maintenance item will not nullify the emission warranty or limit recall liability prior to the completion of vehicle useful life. General Motors, however, urges that all recommended maintenance services be performed at the indicated intervals and the maintenance be recorded in "Section E: Maintenance Record."



## Section B: Owner Checks and Services

Listed below are owner checks and services which should be performed at the intervals specified to help ensure the safety, dependability and emission control performance of your vehicle.

Be sure any necessary repairs are completed at once. Whenever any fluids or lubricants are added to your vehicle, make sure they are the proper ones, as shown in Section D.

### At Each Fuel Fill (It is important for you or a service station attendant to perform these underhood checks at each fuel fill.)

CHECK OR SERVICE	WHAT TO DO
Engine Oil Level	Check the engine oil level and add the proper oil if necessary. See "Engine Oil" in the Index for further details.
Engine Coolant Level	Check the engine coolant level in the coolant recovery tank and add the proper coolant mix if necessary. See "Engine Coolant" in the Index for further details.
Windshield Washer Fluid Level	Check the windshield washer fluid level in the windshield washer tank and add the proper fluid if necessary. See "Windshield Washer Fluid" in the Index for further details.

### At Least Once a Month

CHECK OR SERVICE	WHAT TO DO
Tire Inflation	Check tire inflation. Make sure they are inflated to the pressures specified on the Tire-Loading Information label located on the rear edge of the driver's door. See "Tires" in the Index for further details.

## At Least Once a Year

CHECK OR SERVICE	WHAT TO DO
Key Lock Cylinders	Lubricate the key lock cylinders with the lubricant specified in Section D.
Body Lubrication	Lubricate all body door hinges. Also lubricate all hinges and latches, including those for the hood, glove box door and console door. Section D tells you what to use.
Starter Switch	<p data-bbox="446 362 1821 530"> <b>CAUTION:</b> When you are doing this check, the vehicle could move suddenly. If it does, you or others could be injured. Follow the steps below.</p> <ol data-bbox="446 551 1821 677" style="list-style-type: none"><li>1. Before you start, be sure you have enough room around the vehicle.</li><li>2. Firmly apply both the parking brake (see "Parking Brake" in the Index if necessary) and the regular brake.</li></ol> <p data-bbox="446 690 1821 766">NOTE: Do not use the accelerator pedal, and be ready to turn off the engine immediately if it starts.</p> <ol data-bbox="446 778 1821 854" style="list-style-type: none"><li>3. Try to start the engine in each gear. The starter should work only in "P" (Park) or "N" (Neutral). If the starter works in any other position, your vehicle needs service.</li></ol>

CHECK OR SERVICE	WHAT TO DO
Steering Column Lock	<p>While parked, and with the parking brake set, try to turn the key to "LOCK" in each shift lever position.</p> <ul style="list-style-type: none"> <li>• The key should turn to "LOCK" only when the shift lever is in "P" (Park).</li> <li>• The key should come out only in "LOCK."</li> </ul>
Parking Brake and Automatic Transaxle "P" (Park) Mechanism Check	<div style="background-color: yellow; padding: 5px;"> <p> <b>CAUTION:</b>  <b>When you are doing this check, your vehicle could begin to move. You or others could be injured and property could be damaged. Make sure there is room in front of your vehicle in case it begins to roll. Be ready to apply the regular brake at once should the vehicle begin to move.</b></p> </div> <p>Park on a fairly steep hill, with the vehicle facing downhill. Keeping your foot on the regular brake, set the parking brake.</p> <ul style="list-style-type: none"> <li>• To check the parking brake: With the engine running and transaxle in "N" (Neutral), slowly remove foot pressure from the regular brake pedal. Do this until the vehicle is held by the parking brake only.</li> <li>• To check the "P" (Park) mechanism's holding ability: Shift to "P" (Park). Then release all brakes.</li> </ul>
Underbody Flushing	<p>At least every spring, use plain water to flush any corrosive materials from the underbody. Take care to clean thoroughly any areas where mud and other debris can collect.</p>



## Section C: Periodic Maintenance Inspections

Listed below are inspections and services which should be performed at least twice a year (for instance, each spring and fall). You should let your GM dealer's service department or other qualified service center do these jobs. Make sure any necessary repairs are completed at once.

INSPECTION OR SERVICE	WHAT SHOULD BE DONE
Steering, Suspension and Front-Wheel-Drive Axle Boot and Seal Inspection	Inspect the front and rear suspension and steering system for damaged, loose or missing parts, signs of wear, or lack of lubrication. Inspect the power steering lines and hoses for proper hookup, binding, leaks, cracks, chafing, etc. Clean and then inspect the drive axle boot seals for damage, tears or leakage. Replace seals if necessary.
Exhaust System Inspection	Inspect the complete exhaust system. Inspect the body near the exhaust system. Look for broken, damaged, missing or out-of-position parts as well as open seams, holes, loose connections, or other conditions which could cause a heat build-up in the floor pan or could let exhaust fumes into the vehicle. See "Engine Exhaust" in the Index.
Throttle Linkage Inspection	Inspect the throttle linkage for interference or binding, and for damaged or missing parts. Replace parts as needed.

INSPECTION OR SERVICE	WHAT SHOULD BE DONE
Brake System Inspection	<p>Inspect the complete system. Inspect brake lines and hoses for proper hookup, binding, leaks, cracks, chafing, etc. Inspect disc brake pads for wear and rotors for surface condition. Also inspect drum brake linings for wear and cracks. Inspect other brake parts, including drums, wheel cylinders, calipers, parking brake, etc. Check parking brake adjustment. You may need to have your brakes inspected more often if your driving habits or conditions result in frequent braking.</p> <p>NOTE: A low brake fluid level can indicate worn disc brake pads which may need to be serviced. Also, if the brake system warning light stays on or comes on, something may be wrong with the brake system. See "Brake System Warning Light" in the Index.</p>

## Section D: Recommended Fluids and Lubricants

NOTE: Fluids and lubricants identified below by name, part number or specification may be obtained from your GM dealer.

USAGE	FLUID/LUBRICANT
Engine Oil	GM Goodwrench Motor Oil or equivalent for API service SG Energy Conserving II oils of the proper viscosity. The "SG" designation may be shown alone or in combination with others, such as "SG/CC," "SG/CD" or "SF, SG, CC," etc. To determine the preferred viscosity for your vehicle's engine, see "Engine Oil" in the Index.
Engine Coolant	50/50 mixture of water (preferably distilled) and good quality ethylene glycol base antifreeze (GM Part No. 1052753 or equivalent) conforming to GM Specification 1825M or approved recycled coolant conforming to GM Specification 1825M.
Hydraulic Brake System	Delco Supreme II <sup>®</sup> Brake Fluid (GM Part No. 1052535) or equivalent DOT-3 brake fluid.
Parking Brake Guides	Chassis lubricant meeting requirements of NLGI Grade 2, Category LB or GC-LB (GM Part No. 1052497 or equivalent).
Power Steering System	GM Hydraulic Power Steering Fluid (GM Part No. 1052884) or equivalent.
Automatic Transaxle	DEXRON <sup>®</sup> -III Automatic Transmission Fluid (GM Part No. 12345881)



USAGE	FLUID/LUBRICANT
Key Lock Cylinders	Lubricate with Multi-Purpose Lubricant (GM Part No. 12345120), synthetic SAE 5W-30 engine oil or silicone lubricant (GM Part No. 1052276 or 1052277).
Automatic Transaxle Shift Linkage	Engine oil.
Chassis Lubrication	Chassis lubricant meeting requirements of NLGI Grade 2, Category LB or GC-LB (GM Part No. 1052497 or equivalent).
Windshield Washer Solvent	GM Optikleen® Washer Solvent (GM Part No. 1051515) or equivalent.

USAGE	FLUID/LUBRICANT
Hood Latch Assembly a. Pivots and Spring Anchor b. Release Pawl	a. Engine oil. b. Chassis lubricant meeting requirements of NLGI Grade 2, Category LB or GC-LB (GM Part No. 1052497 or equivalent).
Hood and Door Hinges, Station Wagon Liftgate, Fuel Door Hinge, Folding Seat Hardware, Rear Compartment Lid Hinges	Engine oil or Lubriplate Lubricant (GM Part No. 1050109).
Weatherstrips	Dielectric Silicone Grease (GM Part No. 12345579 or equivalent).

See "Capacities and Specifications" in the Index for recommended replacement filters, valves and spark plugs.

## Section E: Maintenance Record

After the scheduled services are performed, record the date, odometer reading and who performed the service in the columns indicated. When completing the Maintenance Performed column, insert the numbers from

the Schedule I or Schedule II maintenance charts which correspond to the maintenance performed. Also, you should retain all maintenance receipts. Your owner information portfolio is a convenient place to store them.

DATE	ODOMETER READING	SERVICED BY	MAINTENANCE PERFORMED





<b>DATE</b>	<b>ODOMETER READING</b>	<b>SERVICED BY</b>	<b>MAINTENANCE PERFORMED</b>

<b>DATE</b>	<b>ODOMETER READING</b>	<b>SERVICED BY</b>	<b>MAINTENANCE PERFORMED</b>





## Part 8 Customer Assistance Information

Here you will find out how to contact Buick if you need assistance. This part also tells you how to obtain service publications and how to report any safety defects.

**Part 8 includes:**

Customer Satisfaction Procedure .....	300
Customer Assistance for the Hearing or Speech Impaired .....	301
Reporting Safety Defects .....	302
Service Publications .....	303
Publications Order Form .....	305

## Customer Satisfaction Procedure

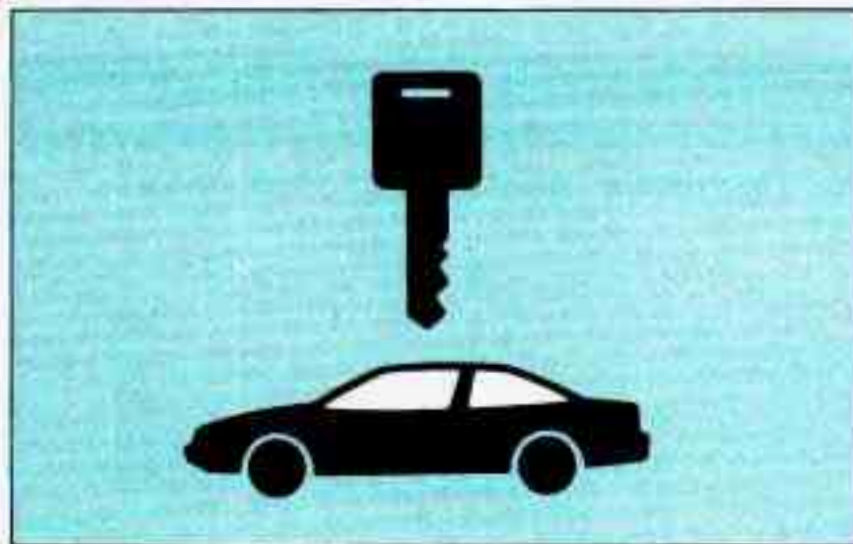

Your satisfaction and goodwill are important to your dealer and Buick. Normally, any problems with the sales transaction or the operation of your vehicle will be resolved by your dealer's Sales or Service Departments. Sometimes, however, despite the best intentions of all concerned, misunderstandings can occur. If your concern has not been resolved to your satisfaction, the following steps should be taken:

**STEP ONE:** Discuss your problem with a member of dealership management. Complaints can often be quickly resolved at that level. If the matter has already been reviewed with the Sales, Service, or Parts Manager, contact the owner of the dealership or the General Manager.

**STEP TWO:** If after contacting a member of Dealership Management, it appears your problem cannot be resolved by the dealership without further help, contact the Customer Assistance Center by calling 1-800-521-7300. In Canada, contact GM of Canada Customer Assistance Center in Oshawa by calling 1-800-263-3777 (English) or 1-800-263-7854 (French).

In Mexico, call 254-17-86. In Puerto Rico or U.S. Virgin Islands, call 1-809-763-1315. In all other overseas locations, contact GM International Export Sales in Canada by calling 1-416-644-4112.

For prompt assistance, please have the following information available to give the Customer Assistance Representative:

- Your name, address, telephone number
- Vehicle Identification Number (This is available from the vehicle registration or title, or the plate attached to the left top of the instrument panel and visible through the windshield.)
- Dealership name and location
- Vehicle delivery date and present mileage
- Nature of problem

In order to give your inquiry prompt attention, please call the toll-free number listed above. However, if you wish to write Buick, write to:

Buick Motor Division  
Customer Assistance Center  
902 E. Hamilton Avenue  
Flint, Michigan 48550

A listing of all Buick Zone Offices and offices outside the U.S. which can assist you can also be found in the warranty booklet.

When contacting Buick, please remember that your problem will likely be resolved in the dealership, using the dealership's facilities, equipment and personnel. That is why we suggest you follow Step One first if you have a problem.

## **Customer Assistance for the Hearing or Speech Impaired**

To assist owners who have hearing difficulties, Buick has installed special TDD (Telecommunication Devices for the Deaf) equipment in its Customer Assistance Center. Any hearing or speech impaired customer who has access to a TDD or a conventional teletypewriter (TTY) can communicate with Buick by dialing: 1-800-TD-BUICK. (TDD users in Canada can dial 1-800-263-3830.)



## **REPORTING SAFETY DEFECTS TO THE UNITED STATES GOVERNMENT**

If you believe that your vehicle has a defect which could cause a crash or could cause injury or death, you should immediately inform the National Highway Traffic Safety Administration (NHTSA), in addition to notifying General Motors.

If NHTSA receives similar complaints, it may open an investigation, and if it finds that a safety defect exists in a group of vehicles, it may order a recall and remedy campaign. However, NHTSA cannot become involved in individual problems between you, your dealer, or General Motors.

To contact NHTSA, you may either call the Auto Safety Hotline toll-free at 1-800-424-9393 (or 366-0123 in the Washington, D.C. area) or write to:

NHTSA  
U.S. Department of Transportation  
Washington, D.C. 20590

You can also obtain other information about motor vehicle safety from the Hotline.

## **REPORTING SAFETY DEFECTS TO THE CANADIAN GOVERNMENT**

If you live in Canada, and you believe that your vehicle has a safety defect, you should immediately notify Transport Canada in addition to notifying General Motors of Canada Limited. You may write to:

Transport Canada at Box 8880  
Ottawa, Ontario K1G 3J2.

## **REPORTING SAFETY DEFECTS TO GENERAL MOTORS**

In addition to notifying NHTSA (or Transport Canada) in a situation like this, we certainly hope you'll notify us. Please call us at **1-800-521-7300**, or write:

Buick Motor Division  
Customer Assistance Center  
902 E. Hamilton Avenue  
Flint, Michigan 48550

In Canada, please call us at 1-800-263-3777 (English) or 1-800-263-7854 (French). Or, write:

General Motors of Canada Limited  
Customer Assistance Center  
1908 Colonel Sam Drive  
Oshawa, Ontario L1H 8P7

## Service Publications

Information on how to obtain Product Service Publications, Subscriptions and Indexes as described below is applicable only in the fifty U.S. states (and the District of Columbia) and only for cars and light trucks with GVWR less than 10,000 pounds (4 536 kg).

In Canada, information pertaining to Product Service Bulletins and Indexes can be obtained by writing to:

General Motors of Canada Limited  
Service Publications Department  
1908 Colonel Sam Dr.  
Oshawa, Ontario L1H 8P7

Buick regularly sends its dealers useful service bulletins about Buick products. Buick monitors product performance in the field. We then prepare bulletins for servicing our products better. Now, you can get these bulletins too.

Bulletins cover various subjects. Some pertain to the proper use and care of your vehicle. Some describe costly repairs. Others describe inexpensive repairs which, if done on time with the latest parts, may avoid future costly repairs. Some bulletins tell a technician how to repair a new or unexpected condition. Others describe a quicker way to fix your vehicle. They can help a technician service your vehicle better.

Most bulletins apply to conditions affecting a small number of cars or trucks. Your Buick dealer or a qualified technician may have to determine if a specific bulletin applies to your vehicle.

You can subscribe to all Buick bulletins. This way you'll get them as they come out. You can wait a while and get an index to the bulletins. You can also get individual bulletins. However, you'll need the index to identify them.

## Subscriptions

You can subscribe to all Buick Product Service Publications (PSP's). This will include bulletins for all cars sold by Buick and will not be limited to PSP's applicable to any particular model. When you buy a subscription, you will receive the PSP's in periodic mailings, shortly after they come out. A subscription costs \$86.50 in U.S. funds (\$106.50 includes a special binder) and it entitles you to all PSP's published by Buick during the model year. You can purchase a subscription by sending a check or money order to Service Publications, P.O. Box 1901, Flint, Michigan 48501, along with the order form located in the following text.

You may get additional subscription ordering forms by calling the toll-free number shown in the following text.



## Individual PSP's

If you don't want to buy all the PSP's issued by Buick for all models in the model year, you can buy individual PSP's, such as those which may pertain to a particular model. To do this, you will first need to see our index of PSP's. It provides a variety of information. Here's what you'll find in the index and how you can get one:

### What You'll Find in the Index

- A list of all PSP's published by Buick in a model year (1989 or later). PSP's covering all models of Buick cars are listed in the same index.
- Ordering information so you can buy the specific PSP's you may want.
- Price information for the PSP's you may want to buy.

### How You Can Get an Index

Indexes are published periodically. Most of the PSP's which could potentially apply to the most recent Buick models will be listed in the most recent publication for that model year. This means you may want to wait until the end of the model year before ordering an index, if you are interested in buying PSP's pertaining to a current model year car or truck.

Some PSP's pertaining to a particular model year vehicle may be published in later years, and these would be listed in the later year's index. When you order an index for a

model year that is not over yet, we'll send you the most recently published issue. Check the ordering form for indexes for earlier model years.

Cut out the ordering form, fill it out, and mail it in. We will then see to it that an index is mailed to you. There is no charge for indexes for the 1989-1993 model years.

### Toll-Free Telephone Number

If you want an additional ordering form for an index or a subscription, just call toll-free and we'll be happy to send you one. Automated recording equipment will take your name and mailing address. The number to call is 1-800-551-4123.

### Copies at Participating Dealers

Copies of indexes and individual PSP's are at your participating Buick dealer. You can ask to see them.

### A VERY IMPORTANT REMINDER

These PSP's are meant for technicians. They are not meant for the "do-it-yourselfer." Technicians have the equipment, tools, safety instructions, and know-how to do a job quickly and safely.

### Buick Service Publications

You can get these by using the order form:



# BUICK PUBLICATIONS ORDER FORM



NAME \_\_\_\_\_ DATE \_\_\_\_\_

ADDRESS \_\_\_\_\_

CITY \_\_\_\_\_ STATE \_\_\_\_\_ ZIP \_\_\_\_\_

VISA \_\_\_\_\_ MASTERCARD \_\_\_\_\_

CARD NUMBER \_\_\_\_\_

EXP. DATE \_\_\_\_\_ PHONE # ( \_\_\_\_\_ ) \_\_\_\_\_

## WHAT'S A PRODUCT SERVICE PUBLICATION?

Product Service Publications (PSPs), are bulletins, letters and articles published for trained dealer service personnel. They describe or recommend diagnostic, maintenance, or repair procedures, parts recommendations or use and care information. The indexes list all PSPs published by Buick in each model year. To review all Product Service Publications (PSPs) for a specific model year vehicle, it is necessary to order the index for that model year and all subsequent model year indexes.

Buick bulletins are intended for use by professional technicians, NOT a "do-it-yourselfer". They are written to inform these technicians of conditions that may occur on some vehicles, or to provide information that could assist in the proper service of a vehicle. Properly trained technicians have the equipment, tools, safety instructions, and know-how to do a job properly and safely. If a condition is described, DO NOT assume that the bulletin applies to your vehicle, or that your vehicle will have that condition. See your Buick dealer for information on whether your vehicle may benefit from the information.

## WHAT'S A CHASSIS SERVICE MANUAL?

Chassis Service Manuals have diagnosis, repair and overhaul information on engines, transmission, axle, suspension, brakes, electrical, steering, etc. 1983 through 1987 model manuals were published in looseleaf format and included all series in a single publication. The 1982 and prior Chassis Service Manuals are published in a bound format and may contain more than one series. The 1968 and later Chassis Service Manuals are published in a bound format for each series. Chassis Service Manuals for certain models prior to 1990 and all 1990 and later models are combined with the respective Body Service Manuals.

## WHAT'S A BODY SERVICE MANUAL?

Body Service Manuals have repair information on trim, seats, windows, doors, etc. These manuals are published in a bound format. Body Service Manuals for certain models prior to 1990 and all 1990 and later models are combined with the respective Chassis Service Manuals.

## WHAT ARE OWNER PUBLICATIONS?

Owner Publications are publications written directly for owners and intended to provide information about their car, such as Owner's Manuals, Maintenance Schedules and Warranty and Owner Assistance Information Booklets. Beginning in 1991, the Maintenance Schedule is included in the Owner's Manual.

## HOW TO ORDER

Fill in order completely including year and model. Enclose check or money order (Sorry no C.O.D. or Purchase Orders). Make check or money order payable only in U.S. Funds to Service Publications. VISA and MASTERCARD also accepted. Indicate card number and expiration date above. Michigan Residents must add 4% sales tax. Canadian and Overseas residents please add 20% for shipping and handling. For additional information and/or phone orders call 1-313-239-5553 from 9 A.M. to 5 P.M. Eastern Time Monday thru Friday. For phone orders have VISA or MASTERCARD ready. All orders will be sent via UPS or First Class U.S. mail postage paid. Sorry. No P.O. Box addresses.

## RUSH DELIVERIES

Two day and overnight service is available for VISA and MASTERCARD orders only. Sorry. NO P.O. Box or APC/PO addresses. Receipt telephone number is needed with order. Please call for details.

## FOREIGN SHIPMENTS

VISA, MASTERCARD only. Shipping and applicable duty charges to be paid by customer. All pricing in U.S. Funds. If no delivery preference is specified, package will be shipped and charged surface delivery rates.

## SEND ORDER TO:

Service Publications  
P.O. Box 1901  
Flint, MI 48501

Amount of Order
Mich Sales Tax
Michigan Residents Must add 4 % Sales Tax
Canadian/Overseas add 20% s/h
Total Amount

\* Service Publications is an Authorized Publication Distributor to Buick Motor Division

**VERY IMPORTANT - PLEASE INCLUDE YEAR AND MODEL.**

CHASSIS SERVICE MANUAL	QTY	NET AS PRICE	YEAR OF CAR	MODEL OF CAR	NOTATIONS AVAILABLE
1989 LEASAB/ELECTRA/PARK AVE. SERVICE MANUAL		\$45.00			
1989 CHASSIS SERVICE MANUAL (EXCEPT REGAL)		\$25.00			
1990 TRU 1987 CHASSIS SERVICE MANUAL (WITHOUT GAZES)		\$60.00			SA
1991 TRU 1990 CHASSIS SERVICE MANUAL (EXCEPT 1991 ON 1991 SKYLARK, 1992 SKYLARK OR SKYLARK (CENTURY))		\$29.00			1991, 7/79 *
<b>CHASSIS AND BODY SERVICE MANUAL</b>					
1987 TRU 1990 LE SABRE OR PARK AVE./ALTRA/CHASSIS & BODY CHASSIS		\$45.00			
1991 ULTRA SERVICE MANUAL (SUPPLEMENT FOR SUPER CHASSIS)		\$15.50			
1992 LEASAB/ELECTRA/PARK AVE. CHASSIS & BODY SERVICE MANUAL		\$45.00			
1989 TRU 1990 CHASSIS & BODY SERVICE MANUAL (ALL SERIES EXCEPT LE SABRE/ELECTRA/PARK AVE.)		\$35.00			
1988 REGAL CHASSIS & BODY SERVICE MANUAL		\$35.00			
1992 SKYLARK OR 1992 SKYLARK (CENTURY) CHASSIS & BODY SERVICE MANUAL		\$35.00			
1990 OR 1991 SKYLARK CHASSIS & BODY SERVICE MANUAL		\$35.00			
1996, 1989, 1991, 1991, 1992 OR 1990 COMPLETE SET CHASSIS AND ELECTRICAL SYSTEMS MANUAL AND BODY SERVICE MANUAL FOR ALL SERIES/REAR		\$295.00			
<b>BODY SERVICE MANUAL</b>					
1989 LEASAB/ELECTRA/PARK AVE. BODY SERVICE MANUAL		\$20.00			
1989 BODY SERVICE MANUAL (EXCEPT REGAL)		\$20.00			
1979 TRU 1987 BODY SERVICE MANUAL		\$20.00			1979, 7/79 *
<b>GLOVE BOX MATERIAL (Please include year and model)</b>					
1975 TRU 1990 OWNERS MANUAL (EXCEPT 1990 LE SABRE/ELECTRA/PARK AVE.)		\$ 5.00			
1990 LEASAB/ELECTRA/PARK AVE. OWNERS MANUAL		\$10.00			
1990 TRU 1990 BLACK OWNERS MANUAL		\$10.00			
1981 TRU 1992 BLACK MAINTENANCE PERFORMANCE GAS <input type="checkbox"/> DIESEL <input type="checkbox"/> CALIFORNIA <input type="checkbox"/>		\$ 3.50			1992 CAL GAS
1979 TRU 1990 BLACK MAINTENANCE SCHEDULE GAS <input type="checkbox"/> DIESEL <input type="checkbox"/> CALIFORNIA <input type="checkbox"/> 1990 TRU90 <input type="checkbox"/>		\$ 3.50			
REGAL/A COMMERCIAL TOP INSTRUCTION FOLDER		\$ 3.50			
<b>OPEL MANUALS</b>					
1977 TRU 1979 OPEL SERVICE MANUAL		\$20.00			
1977 TRU 1979 OPEL OWNERS MANUAL		\$ 5.00			1974, 75
1977 TRU 1979 OPEL MAINTENANCE SCHEDULE		\$ 3.50			1977, 87, 74 ALL
<b>PRODUCT SERVICE PUBLICATIONS</b>					
1980, 1981, 1992 OR 1990 PGP BOOK (1981 NOT AVAILABLE UNTIL JANUARY, 1992)		N/A			
1992 MODEL YEAR PGP SUBSCRIPTION (NOT AVAILABLE UNTIL SEPTEMBER, 1992)		\$99.50			
1990 MODEL YEAR PGP SUBSCRIPTION (NOT AVAILABLE UNTIL OCTOBER, 1992)		\$99.50			
PGP SUBSCRIPTION BINDER		\$20.00			
<b>NON-CAR</b>					
REGAL/AL		\$ 4.00			
PGP	(EACH ADDITIONAL)	\$1.00			
	(EACH ADDITIONAL)	\$1.00			
	(EACH ADDITIONAL)	\$1.00			

\* FOR OUT OF PRINT SERVICE MANUALS  
CONTACT NATIONAL SERVICE CENTER  
3501 LIBERTY  
ANN ARBOR, MI 48104 1-800-46-2788

PRICES GOOD THROUGH 12-31-92



### **A**dding

Brake Fluid	243, 292
Electrical Equipment	75, 117, 265
Engine Coolant	195, 239, 270, 272, 292
Engine Oil	227, 270, 272, 292
Power Steering Fluid	241, 271, 273, 292
Sound Equipment	117
Transaxle Fluid	236, 271, 273, 292
Windshield Washer Fluid	242, 293
Air Bag (SIR)	35
Air Cleaner	233, 271, 273
Air Conditioner	114, 270, 272
Alcohol, Driving Under the Influence of	143
Alcohol in Gasoline	223
Aluminum Wheels, Cleaning	262
Antenna Care	131
Antifreeze	239, 270, 272, 292
Appearance Care and Maintenance Materials	258, 264
Ashtrays and Lighter	104
Audio Systems	116
AM/FM Stereo Radio	118
AM/FM Stereo Radio with Cassette Player	120
AM/FM Stereo with Compact Disc Player	123
Care of Audio Systems	129

Radio Reception, Understanding	117
Setting the Clock	118, 121, 124
Automatic Door Locks	66
Automatic Lap-Shoulder Belt (see "Safety Belts")	
Automatic Transaxle	
Adding Fluid	236, 271, 273, 292
Checking Fluid	236
Shifting	77
Starting Your Engine	74

### **B**atteries, Remote Lock Control

Battery	244
Jump Starting	185
Warnings	185, 186, 244
Battery Warning Light	108
Blizzard	173
Block Heater, Engine	76, 232
Blowout, Tire	205
Brake	
Adjustment	149
Fluid	243, 292
Master Cylinder	243
Parking	80



Pedal Travel	149	Power Steering Fluid	241
Rear Drum	149	Safety Belt Systems	60
Replacement	244	Transaxle Fluid	236
Warning Light	109	Underhood	226
Wear Indicators—Disc Brakes	148	Chemical Paint Spotting	263
Brake System Warning Light	109	Child Restraints	47
Braking	146	Children	45
Braking in Emergencies	149	Cigarette Lighter	105
“Break-In,” New Vehicle		Circuit Breakers & Fuses	266
Normal Driving	72	City Driving	162
When Towing a Trailer	176	Cleaner, Air	233, 271, 273
Buckling Up (see “Safety Belts”)		Cleaning	
Bulb Replacement		Aluminum Wheels	262
Headlight	245, 269	Antenna	131
Taillight	247, 269	Cassette Player	129
Turn Signal	246, 269	Fabric	258
		Glass	261
<b>C</b> apacities and Specifications	270, 272	Inside of Your Buick	258
Carbon Monoxide	83, 173	Materials	264
Cargo Security Cover	101	Outside of Your Buick	261
Cassette Tape Holder	103	Safety Belts	261
Cassette Tape Player (see “Audio Systems”)		Special Problems	260
Center Passenger Position	41	Top of Instrument Panel	260
Chains, Tire	217, 257	Underbody Maintenance	263
Changing a Flat Tire	205	Vinyl	260
Checking		Warnings	258
Brake Fluid	243	Weatherstrips	262
Engine Coolant	239	White Sidewall Tires	262
Engine Oil	227	Windshield and Wiper Blades	261
		Climate Control	115

Clock, Setting the	118, 121, 124
Comfort Controls	
Air Conditioning	114
Heating	115
Ventilation	115, 116
Your Buick Comfort Control System	114
Compact Disc Care	130
Compact Spare Tire	205, 215, 218
Compartment, Rear Locking Storage	103
Control of a Vehicle	146
Convenience Net	101
Convex Outside Mirror	99
Coolant (See "Engine Coolant")	
Courtesy Lights	98
Cruise Control	91
Cup Holder	103
Curves, Driving on	150
Customer Assistance Information	299

<b>D</b> aytime Running Lights	96
Dead Battery: What to Do	185
Defensive Driving	142
Defogger, Rear Window	115
Defogging Your Windows	115
Defrosting	115
Dimensions	269
Doing Your Own Service Work	222
Door Locks	65
Downshifting	79, 167

Driver Position	30
At Night	155
City	162
Controlling a Skid	154
Defensively	142
Drunken	143
Freeway	163
Hill and Mountain	166
Hydroplaning	159
In a Foreign Country	224
In Fog, Mist and Haze	160
In the Rain	158
Long Distance	164
Loss of Control	154
On Curves	150
On Snow or Ice	172
Passing	152
Through Deep Standing Water	76
Winter Driving	171
Drunken Driving	143

<b>E</b> lectrical Equipment,	
Adding	75, 117, 265
Emergencies, Braking in	149
Emergencies on the Road	183
Emergencies, Steering in	151
Emergency Starting	185
Emergency Towing	189
Engine Block Heater	76, 232



Engine Coolant .....	238, 270, 272
Checking & Adding .....	195, 239
Proper Mixture to Use .....	239
Safety Warnings About .....	110, 195, 201
Temperature Gage .....	110
Temperature Warning Light .....	110
Engine Coolant Temperature Warning Light (see "Engine Coolant")	
Engine Exhaust .....	83, 173
Engine Identification .....	265
Engine Oil .....	227
Additives .....	231
Checking & Adding .....	227, 270, 272, 292
Crankcase Capacity .....	270, 272
Disposing of Used Oil .....	232
Energy Conserving .....	231
Filter .....	232, 271, 273
Warning Light .....	107
When to Change .....	232
Engine Overheating .....	110, 195
Engine Specifications .....	270, 272
Engine, Starting .....	74
Ethanol in Gasoline .....	223
Exhaust	
Dangerous Gas in .....	83, 173
Running Engine While Parked .....	84
Expectant Mothers, Use of Safety Belts .....	40
Expressway Driving .....	163
Extender, Safety Belt .....	60
Exterior Appearance (see "Appearance Care")	

<b>F</b> abric Cleaning (see "Appearance Care")	
Fan Warnings .....	186, 187, 197, 199, 226
Filling the Fuel Tank .....	225, 270, 272
Filter, Oil .....	232, 271, 273
Finish Damage .....	263
Flashers, Hazard Warning .....	184
Flat Tire .....	205
Flip-Open Rear Vent Windows .....	85
Flooded Engine .....	75
Fluid	
Brake .....	243, 292
Capacities .....	292
Power Steering .....	241, 271, 273, 292
Transaxle .....	236, 271, 273, 292
Windshield Washer .....	89, 242, 293
Fluids and Lubricants .....	292
Fog, Driving in .....	160
Folding Rear Seats .....	18
Foreign Countries .....	224
Freeway Driving .....	163
French Language Manual .....	2
Fuel .....	223
Alcohol in Fuel .....	223
Capacity .....	270, 272
Exhaust Warnings .....	83, 173
Filling Your Tank .....	225, 270, 272
Gage .....	107
In Foreign Countries .....	224
Mileage Chart .....	320
Requirements .....	223



Warnings .....	225
Fuses & Circuit Breakers .....	266

## G

Battery .....	109
Coolant Temperature .....	110
Fuel .....	107
Gasoline .....	223
Gasoline Tank, Filling Your .....	225, 270, 272
Gear Positions (see "Shifting the Transaxle")	
Gearshift Lever (see "Shifting the Transaxle")	
Glove Box .....	71

## H

Halogen Bulbs .....	245, 269
Hazard Warning Flashers .....	184
Headlight & Taillight, Removing and Replacing ..	245, 247, 269
Headlights .....	95
High-Low Beam Changer .....	88
Instrument Panel Light Intensity Control .....	95
"On" Warning .....	96
Replacement Bulb .....	269
Wiring .....	268
Head Restraints .....	17
Hearing or Speech Impaired .....	301
Heater (see "Comfort Controls")	
Heater, Engine Block .....	76, 232
High Beams .....	88, 157
Highway Hypnosis .....	165

Hill and Mountain Roads .....	166
Hills, Parking on .....	168, 180
Hood Release .....	226
Safety Warning .....	226, 227
Warning, Overheated Engine .....	195, 200, 202
Horn .....	86
Hot Engine, Safety Warnings .....	195, 200, 202
Hydroplaning .....	159

## I

Identification Number, Vehicle .....	265
Idling Your Engine .....	82
If You're Stuck: In Sand, Mud, Ice or Snow .....	219
Ignition	
Key .....	64
Positions .....	73
Indicator Lights (see "Warning Lights")	
Infant Restraint (see "Child Restraints")	
Inflation, Tires .....	252
Inside Rearview Mirror .....	98
Instrument Panel .....	105
Instrument Panel Warning Lights .....	106

## J

Jack, Tire .....	205
Jump Starting .....	185

## K

Keyless Entry System .....	66
Keys .....	64

<b>L</b> ane Change Indicator .....	87
Lap-Shoulder Safety Belt	
Front Automatic .....	30
Rear .....	43
Use by Children .....	45, 51
Liftgate .....	69, 111
Remote Release Button .....	66, 69
Lighter .....	105
Lights	
Courtesy .....	98
Daytime Running Lights .....	96
Halogen Bulbs .....	245
Headlights .....	95
Interior Lights Delay .....	97
Map .....	96
Operation .....	95
Parking Lights .....	95
Reading .....	97
Removing & Replacing Bulbs .....	245
Replacement Bulbs .....	269
Supplemental Inflatable Restraint .....	36
Taillights .....	95
Turn Signal and Lane Change Indicator .....	87
Warning Lights .....	106
Loading Your Vehicle .....	249
Lock, Remote Control .....	66
Locks .....	65, 69
Long Distance Driving .....	164
Low Battery .....	108, 185
Low Oil Pressure Warning .....	107

Lubricants and Fluids .....	292
Luggage Carrier	
Deck .....	100
Roof .....	100

<b>M</b> aintenance Materials .....	264
Maintenance Record .....	295
Maintenance Schedule .....	275
Malfunction Indicator Lamp (Service Engine Soon Light) .....	111
Manual Front Seat .....	14
Map Light .....	96
Master Cylinder, Brake .....	243
Methanol in Gasoline .....	223
Mileage Chart .....	320
Mileage Indicator (see "Odometer")	
Mirrors	
Convex Outside Mirror .....	99
Inside Manual Day/Night .....	98
Inside Rearview Mirror with Reading Lights .....	98
Manual Adjust .....	99
Power Remote Control .....	99
Visor Vanity .....	100
Mountain Driving .....	166

<b>N</b> ew Vehicle Break-In .....	72
Night Driving .....	155



<b>O</b> ctane Requirements (see "Fuel Requirements")	
Odometer	106
Oil, Engine	227, 270, 272, 292
Quality	229
Thickness	230
Used Oil	232
When to Change	232
Oil Warning Light	107
Operation of Lights	95
Outside Rearview Mirrors	99
Overheated Engine	195
Overheated Engine Coolant Warning Light	110

<b>P</b> (Park), Shifting Into	81
Parking	
On Hills	168
Over Things That Burn	83
With a Trailer	180
With the Engine Running	82
Parking Brake	80
Passenger Belts (see "Safety Belts")	
Passing	152
Polishing and Waxing (see "Appearance Care")	
Power Antenna	131
Power Door Locks	66
Power Seat Controls	15
Power Steering Fluid	241, 271, 273, 292
Power Windows	85, 268
Pregnancy, Use of Safety Belts During	40

Problems on the Road	183
Publications (see "Service Publications")	

<b>R</b> adiator Overheating (see "Overheated Engine")	
Radiator Pressure Cap	199, 241
Radio (see "Audio Systems")	
Reading Lights	97
Rear Seats, Folding	18
Rear Storage Security Cover	101
Rear Window Defogger	115
Rearview Mirrors	98
Reclining Seatbacks	15
Recommended Fluids and Lubricants	292
Remote Lock Control	66
Replacement Bulbs	269
Replacement Fuses	266
Replacement Parts	271, 273
Replacing Safety Belts	61
Replacing Tires	254
Replacing Wheels	256, 257
Reporting Safety Defects	302
Restraints, Child	47
Restraints, Head	17
Reverse	77
Road Signs	134
Color	134
Pavement Markings	141
Shape	137
Symbols	139



Traffic Lights .....	140
Your Own Signals .....	141
Roads, Hill and Mountain .....	166
Rocking Your Vehicle .....	218
Rotation, Tire .....	253
Running Your Engine While Parked .....	84

<b>S</b> afety Belt Extender .....	60
Safety Belts .....	23
Adults .....	29
Automatic Lap-Shoulder Belt .....	30
Center Passenger Position .....	41
Checking .....	60
Children .....	45
Child Restraints .....	47
Cleaning .....	261
Driver Position .....	30
Extender .....	60
How to Wear .....	29
Larger Children .....	58
Pregnancy, Use During .....	40
Questions & Answers .....	28, 29, 33, 34, 35, 61
Rear Safety Belts .....	43
Replacement .....	61
Right Front, Adult Passenger .....	40
Smaller Children and Babies .....	46
Third Seat Passenger Position .....	41
Top Strap .....	48

Torn .....	61
Twisted .....	35
Vehicles First Sold in Canada .....	30
Warning Light .....	29
Why You Should Wear Safety Belts .....	23
Safety Defects, Reporting .....	302
Scheduled Maintenance Services .....	278
Seat Belts (see "Safety Belts")	
Seats .....	14
Front Seatback Latches .....	17
Head Restraints .....	17
Manual Front Seat .....	14
Power Seat .....	15
Rear Seats, Folding .....	18
Reclining Seatback .....	15
Second Seat, Folding .....	18
Third Seat, Folding .....	20
Service Engine Soon Light .....	111
Service Information .....	221
Service Parts Identification Label .....	265
Service Publications .....	303
Service Publications Order Form .....	305
Setting the Clock .....	118, 121, 124
Setting the Trip Odometer .....	106
Shifting Into "P" (Park) .....	81
Shifting the Transaxle .....	77
Signaling Turns .....	87, 141
Signs, Road .....	134
SIR (Supplemental Inflatable Restraint) .....	35
Skidding .....	154

Snowstorm (see "Winter Driving")	
Sound Equipment, Adding	117
Sound Systems (see "Audio Systems")	
Spare Tire, Compact	205, 215, 218
Specifications and Capacities	270, 272
Specifications, Engine	270, 272
Speed Control (see "Cruise Control")	
Speedometer	106
Stains, Removing	258
Starting Your Engine	74
Starting Your Vehicle if the Battery is Dead (see "Jump Starting")	
Steering	
In Emergencies	151
Off-Road Recovery	152
Tips	150
Steering Wheel, Tilt	86
Stereo Sound Systems (see "Audio Systems")	
Storage	
Armrest	103
Convenience Net	101
Rear Locking Compartment	103
Rear Storage Security Cover	101
Storing Your Vehicle	244
Stuck, If You Are	219
Sun Visors	100
Supplemental Inflatable Restraint (Air Bag)	35

<b>T</b> ailgate Ajar Warning Light	111
-------------------------------------	-----

Tape Player (see "Audio Systems")	
Technical Facts & Specifications	
Bulbs	269
Electrical Equipment, Add-On	75, 117, 265
Fluid Capacities & Types	270, 272, 292
Fuse Usage	267
Service Parts Identification Label	265
Vehicle Identification Number (VIN)	265
Temperature Warning Light	110
Theft	71
Thermostat	241
Tilt Steering Wheel	86
Time, Setting the	118, 121, 124
Tire Loading	249, 251
Tires	251
Buying New	254
Chains	218, 257
Flat, Changing	205
Inflation	252
Inspection & Rotation	253
Loading	249, 251
Pressure	252
Quality Grading	255
Spare, Compact	205, 215, 218
Wear Indicators	254
Wheel Alignment and Tire Balance	256
Wheel Replacement	256, 257
When to Replace Wheels	256
Winter Driving, and Tires	171
Torque Lock	170



Towing a Trailer	175
Towing Your Buick	189
Traffic Lights	140
Trailer Towing	175
Driving with a Trailer	179
Maintenance	181
Parking on Hills	180
Trailer Brakes	178
Turn Signals	179
Transaxle, Automatic (see "Automatic Transaxle")	
Transmission, Automatic (see "Automatic Transaxle")	
Trip Odometer	106
Trunk Lock	69
Remote Release Button	69
Turn Signal Indicator	87
Turn Signal/Headlight Beam Lever	86
Cruise Control	91
Headlight High/Low Beam	88
Turn & Lane Change Signals	87
Turn Signal Indicator	87
Windshield Wipers	88
Windshield Washer	89
Turn Signal Reminder	87
<b>U</b> nderbody Maintenance	263
Unleaded Gasoline	223
Upholstery Care	258
Urban Driving	162

<b>V</b> ehicle Identification Number (VIN)	265
Vehicle Loading	249
Vehicle Storage	244
Vent Windows, Flip-Open	85
Ventilation	115, 116
VIN	265
Visor Vanity Mirror	100
Volts Gage	109

<b>W</b> arning Flashers, Hazard	184
Warning Lights	106
Air Bag	36
Battery	108
Brake	109
Coolant Temperature	110
Oil	107
Safety Belt Reminder Light	29
Service Engine Soon	111
Tailgate Ajar	111
Washer, Windshield	89
Washer/Wiper, Rear Window	90
Weight	
Gross Axle Weight Rating (GAWR)	250
Gross Vehicle Weight Rating (GVWR)	250
Wheel Alignment and Tire Balance	256
Wheel Covers, How to Remove	210
Wheel Nuts	209
Wheel Nut Torque	215



Wheel Replacement .....	256, 257
Windows	
Power .....	85, 268
Standard .....	84
Vent, Flip-Open .....	85
Windshield Washer .....	89
Fluid .....	242
Windshield Wipers .....	88
Cleaning .....	261
Replacement .....	249, 261
Winter Driving .....	171
If Your Vehicle is Stuck in Deep Snow .....	174, 218
If You're Caught in a Blizzard .....	173
Wrecker Towing .....	189







## Fuel Mileage Chart

You can use this chart to quickly calculate your fuel mileage.

		MILES PER GALLON																										
		10	11	12	13	14	15	16	17	18	19	20	21	22	23	24	25	26	27	28	29	30	31	32	33	34	35	36
GALLONS PURCHASED	5	50	55	60	65	70	75	80	85	90	95	100	105	110	115	120	125	130	135	140	145	150	155	160	165	170	175	180
	6	60	66	72	78	84	90	96	102	108	114	120	126	132	138	144	150	156	162	168	174	180	186	192	198	204	210	216
	7	70	77	84	91	98	105	112	119	126	133	140	147	154	161	168	175	182	189	196	203	210	217	224	231	238	245	252
	8	80	88	96	104	112	120	128	136	144	152	160	168	176	184	192	200	208	216	224	232	240	248	256	264	272	280	288
	9	90	99	108	117	126	135	144	153	162	171	180	189	198	207	216	225	234	243	252	261	270	279	288	297	306	315	324
	10	100	110	120	130	140	150	160	170	180	190	200	210	220	230	240	250	260	270	280	290	300	310	320	330	340	350	360
	11	110	121	132	143	154	165	176	187	198	209	220	231	242	253	264	275	286	297	308	319	330	341	352	363	374	385	396
	12	120	132	144	156	168	180	192	204	216	228	240	252	264	276	288	300	312	324	336	348	360	372	384	396	408	420	432
	13	130	143	156	169	182	195	208	221	234	247	260	273	286	299	312	325	338	351	364	377	390	403	416	429	442	455	468
	14	140	154	168	182	196	210	224	238	252	266	280	294	308	322	336	350	364	378	392	406	420	434	448	462	476	490	504
	15	150	165	180	195	210	225	240	255	270	285	300	315	330	345	360	375	390	405	420	435	450	465	480	495	510	525	540
	16	160	176	192	208	224	240	256	272	288	304	320	336	352	368	384	400	416	432	448	464	480	496	512	528	544	560	576
	17	170	187	204	221	238	255	272	289	306	323	340	357	374	391	408	425	442	459	476	493	510	527	544	561	578	595	612
18	180	198	216	234	252	270	288	306	324	342	360	378	396	414	432	450	468	486	504	522	540	558	576	594	612	630	648	
19	190	209	228	247	266	285	304	323	342	361	380	399	418	437	456	475	494	513	532	551	570	589	608	627	646	665	684	
20	200	220	240	260	280	300	320	340	360	380	400	420	440	460	480	500	520	540	560	580	600	620	640	660	680	700	720	
21	210	231	252	273	294	315	336	357	378	399	420	441	462	483	504	525	546	567	588	609	630	651	672	693	714	735	756	
22	220	242	264	286	308	330	352	374	396	418	440	462	484	506	528	550	572	594	616	638	660	682	704	726	748	770	792	





**THIS MANUAL IS PRINTED ON RECYCLED PAPER USING  
MINIMUM 50% WASTEPAPER, 10% POST CONSUMER WASTE**