

Owner's Manual
for Vehicle



The Ultimate
Driving Machine



325i **Owner's Manual for Vehicle**

330i

Congratulations, and thank you for choosing a BMW.

Thorough familiarity with your vehicle will provide you with enhanced control and security when you drive it. We therefore have this request:

Please take the time to read this Owner's Manual and familiarize yourself with the information that we have compiled for you before starting off in your new vehicle. It contains important data and instructions intended to assist you in gaining maximum use and satisfaction from your BMW's unique range of technical features. The manual also contains information on maintenance designed to enhance operating safety and contribute to maintaining the value of your BMW throughout an extended service life.

This manual is supplemented by a Service and Warranty Information Booklet for US models or a Warranty and Service Guide Booklet for Canadian models.

We wish you an enjoyable driving experience.

BMW AG

© 2005 Bayerische Motoren Werke
Aktiengesellschaft
Munich, Germany
Reprinting, including excerpts, only with the
written consent of BMW AG, Munich.
Order No. 01 41 0 159 259
US English II/05, 05 03 500
Printed in Germany
Printed on environmentally friendly paper,
bleached without chlorine, suitable for recycling.

Contents

The fastest way to find information on a particular topic or item is by using the index, refer to page 206.

Using this Owner's Manual

4 Notes

At a glance

10 Cockpit

16 iDrive

22 Voice command system

Controls

28 Opening and closing

38 Adjustments

46 Transporting children safely

49 Driving

64 Everything under control

77 Technology for driving comfort and safety

85 Lamps

89 Controlling the climate for pleasant driving

93 Practical interior accessories

Driving tips

106 Things to remember when driving

Navigation

114 Starting the navigation system

115 Destination entry

125 Destination guidance

130 What to do if ...

Entertainment

134 On/off and settings

138 Radio

145 CD player and CD changer

149 External audio device

Communications

152 Telephoning

160 TeleService, BMW Assist

Mobility

168 Refueling

170 Wheels and tires

180 Under the hood

185 Maintenance

187 Replacing components

193 Giving and receiving assistance

Reference

200 Technical data

202 Short commands for the voice command system

206 Everything from A-Z

Notes

Using this Owner's Manual

We have tried to make all the information in this Owner's Manual easy to find. The fastest way to find specific topics is to refer to the detailed index at the back of the manual. If you wish to gain an initial overview of your vehicle, you will find this in the first chapter.

Should you sell your BMW some day, please remember to hand over the Owner's Manual as well; it is an important component of your vehicle.

Additional sources of information

Should you have any other questions, your BMW center will be glad to advise you at any time.

Information on BMW, e.g. on technical aspects, can also be found on the Internet at www.bmwusa.com.

Symbols used



Indicates precautions that must be followed precisely in order to avoid the possibility of personal injury and serious damage to the vehicle.



Indicates information that will assist you in gaining the optimum benefit from your vehicle and enable you to care more effectively for your vehicle.



Refers to measures that can be taken to help protect the environment.

◀ Marks the end of a specific item of information.

* Indicates special equipment, country-specific equipment and optional extras, as well as equipment and functions not yet available at the time of printing.

"..." Identifies Control Display texts used to select individual functions.

›...‹ Verbal instructions to use with the voice command system.

››...‹‹ Identifies the answers generated by the voice command system.

Symbols on vehicle components



Indicates that you should consult the relevant section of this Owner's Manual for information on a particular part or assembly.

The individual vehicle

When you ordered your BMW, you chose various items of equipment. This Owner's Manual describes the entire array of options and equipment available with a specific BMW model.

Please bear in mind that the manual may contain information on accessories and equipment that you have not specified for your own vehicle. Sections describing options and special equipment are marked by asterisks * to assist you in identifying possible differences between the descriptions in this manual and your own vehicle's equipment.

If equipment in your BMW is not described in this Owner's Manual, please refer to the accompanying Supplementary Owner's Manuals.

Editorial notice

BMW pursues a policy of continuous, ongoing development that is conceived to ensure that our vehicles continue to embody the highest quality and safety standards combined with advanced, state-of-the-art technology. For this reason, it is possible in exceptional cases that features described in this Owner's Manual could differ from those on your vehicle.

For your own safety

Maintenance and repair



Advanced technology, e.g. the use of modern materials and high-performance electronics, requires specially adapted maintenance and repair methods. Therefore, have corresponding work on your BMW carried out only by a BMW center or a workshop that works according to BMW repair procedures with correspondingly trained personnel. If work is carried out improperly there is a danger of consequential damage and the related safety risks. ◀

California Proposition 65 warning

California law requires us to issue the following warning:



Engine exhaust and a wide variety of automobile components and parts, including components found in the interior furnishings in a vehicle, contain or emit chemicals known to the State of California to cause cancer and birth defects and reproductive harm. In addition, certain fluids contained in vehicles and certain products of component wear contain or emit chemicals known to the State of California to cause cancer and birth defects or other reproductive harm.

Battery posts, terminals and related accessories contain lead and lead compounds. Wash your hands after handling.

Used engine oil contains chemicals that have caused cancer in laboratory animals. Always protect your skin by washing thoroughly with soap and water. ◀

Parts and accessories



For your own safety, use genuine parts and accessories approved by BMW.

When you purchase accessories tested and approved by BMW and Original BMW Parts, you simultaneously acquire the assurance that they have been thoroughly tested by BMW to ensure optimum performance when installed on your vehicle.

BMW warrants these parts to be free from defects in material and workmanship.

BMW will not accept any liability for damage resulting from installation of parts and accessories not approved by BMW.

BMW cannot test every product made by other manufacturers to verify if it can be used on a BMW safely and without risk to either the vehicle, its operation, or its occupants.

Original BMW Parts, BMW Accessories and other products approved by BMW, together with professional advice on using these items, are available from all BMW centers.

Installation and operation of non-BMW approved accessories such as alarms, radios, amplifiers, radar detectors, wheels, suspension components, brake dust shields, telephones, including operation of any portable phone from within the vehicle without using an externally mounted antenna, or transceiver equipment, for instance, CBs, walkie-talkies, ham radio or similar accessories, may cause extensive damage to the vehicle, compromise its safety, interfere with the vehicle's electrical system or affect the validity of the BMW Limited Warranty. See your BMW center for additional information. ◀

 Maintenance, replacement, or repair of the emission control devices and systems may be performed by any automotive repair establishment or individual using any certified automotive part. ◀

Service and warranty

We recommend that you read this publication thoroughly.

Your BMW is covered by the following warranties:

- ▷ New Vehicle Limited Warranty
- ▷ Rust Perforation Limited Warranty
- ▷ Federal Emissions System Defect Warranty
- ▷ Federal Emissions Performance Warranty
- ▷ California Emission Control System Limited Warranty

Detailed information about these warranties is listed in the Service and Warranty Information Booklet for US models or in the Warranty and Service Guide Booklet for Canadian models.

Reporting safety defects

For U.S. customers

The following applies only to vehicles owned and operated in the US.

If you believe that your vehicle has a defect which could cause a crash or could cause injury or death, you should immediately inform the National Highway Traffic Safety Administration (NHTSA) in addition to notifying BMW of North America, LLC, P.O. Box 1227, Westwood, New Jersey 07675-1227, Telephone (800) 831-1117.

If NHTSA receives similar complaints, it may open an investigation, and if it finds that a safety defect exists in a group of vehicles, it may order a recall and remedy campaign. However, NHTSA cannot become involved in individual problems between you, your dealer, or BMW of North America, LLC.

To contact NHTSA, you may either call the Auto Safety Hotline toll-free at 1-800-424-9393 (or 366-0123 in Washington, D.C. area) or write to: NHTSA, U.S. Department of Transportation, Washington, D.C. 20590. You can also obtain other information about motor vehicle safety from the Hotline.

For Canadian customers

Canadian customers who wish to report a safety-related defect to Transport Canada, Defect Investigations and Recalls, may telephone the toll free hotline 1-800-333-0510, or contact Transport Canada by mail at: Transport Canada, ASFAD, Place de Ville Tower C, 330 Sparks Street, Ottawa ON K1A 0N5.







At a glance

This overview of buttons, switches and displays is intended to familiarize you with your vehicle's operating environment. The section will also assist you in becoming acquainted with the control concepts and options available for operating the various systems.

Cockpit

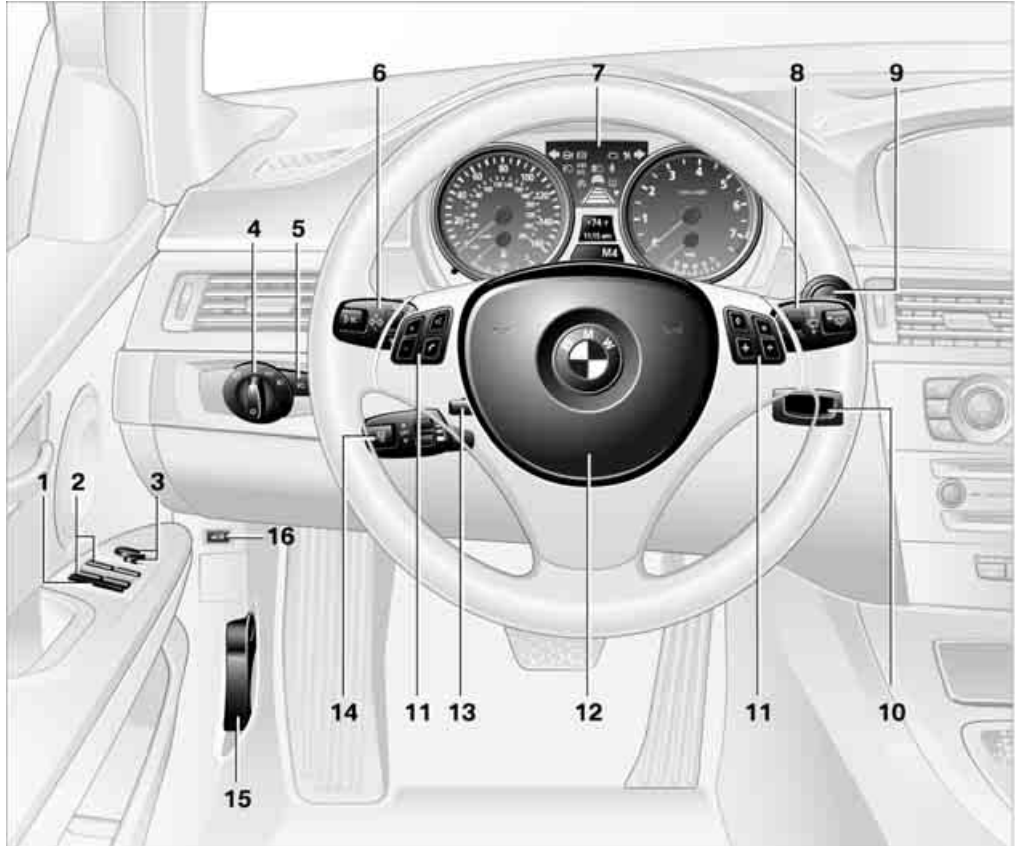
Around the steering wheel: controls and displays





1  Safety switch for electric rear windows [36](#)

2  Opening and closing windows [35](#)



















3 Adjusting exterior mirrors, automatic curb monitor* [43](#)

4  Parking lamps [85](#)

 Low beams [85](#)

 Automatic headlamp control* [85](#)

5  Fog lamps* [87](#)

- 6**  Turn signals 53
-  High beams, headlamp flasher 86
-  Roadside parking lamps* 86
- BC** Computer 65
-  Settings and information about the vehicle 68
-  Instrument lighting 87
- 7** Instrument cluster 12
- 8**  Windshield wipers 54
-  Rain sensor* 54
- 9**  Switching the ignition on/off and starting/stopping the engine 49
- 10** Ignition lock 49
- 11** Buttons* on the steering wheel
-  Telephone*:
- ▷ Press briefly: receiving and ending a call, starting dialing* for a selected number
 - ▷ Press longer: redialing
-  Volume
-  Activating/deactivating voice command system*
-  Switching radio stations
-  Selecting music tracks
-  Scrolling through phone book
-  Individually programmable 45
-  Individually programmable 45
- 12** Horn: the entire surface
- 13** Steering wheel adjustment 44
- 14**  Cruise control* 55
-  Active cruise control* 57
- 15** Releasing the hood 180
- 16** Opening the luggage compartment lid*

Instrument cluster

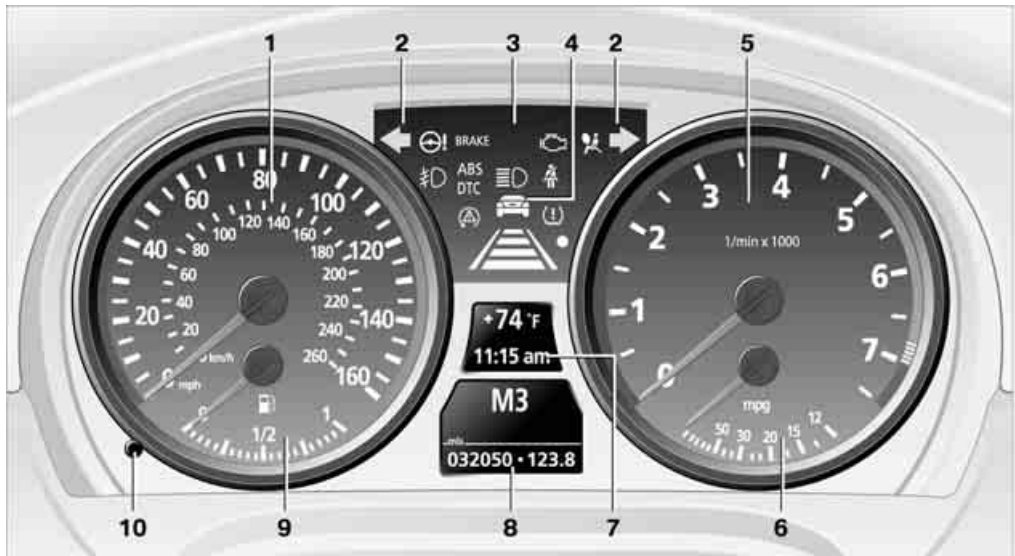

- 1 Speedometer
- 2 Indicator lamps for turn signals
- 3 Indicator and warning lamps [13](#)
- 4 Displays for active cruise control* [57](#)
- 5 Tachometer [64](#)
- 6 Energy Control [64](#)
- 7 Display for
 - ▷ Clock [64](#)
 - ▷ Outside temperature [64](#)
 - ▷ Indicator and warning lamps [73](#)
- 8 Display for
 - ▷ Position of automatic transmission* [51](#)
 - ▷ Computer [65](#)
 - ▷ Date of next scheduled service, and remaining distance to be driven [69](#)
 - ▷ Odometer and trip odometer [64](#)
 - ▷ Settings and information [68](#)
- 9 Fuel gauge [65](#)
- 10 Resetting trip odometer [64](#)

Indicator and warning lamps

The concept

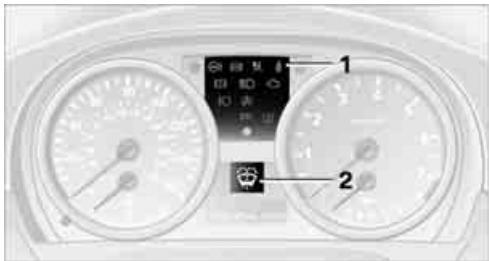

Indicator and warning lamps can light up in various combinations and colors in both the indicator area **1** and the display **2**.

Some lamps are checked for proper functioning and thus come on briefly when the engine is started or the ignition is switched on.

Explanatory text messages



Text messages at the lower edge of the Control Display explain the meaning of the displayed indicator and warning lamps.

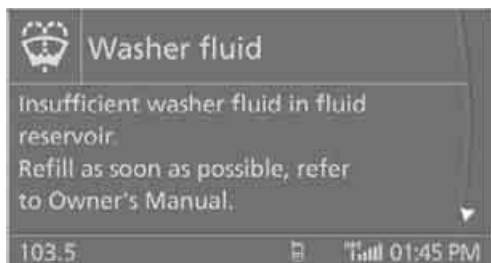

You can call up more information, e.g. on the cause of a malfunction and on how to respond, via Check Control, refer to page [73](#).

In urgent cases, this information will be shown immediately as soon as the corresponding lamp comes on.

Indicator lamps without text messages

The following indicator lamps in the indicator area **1** signal that the associated functions are activated:

 High beams/headlamp flasher [86](#)

 Fog lamps* [87](#)

 Lamp flashes:
DSC or DTC is regulating the propulsive forces in order to maintain driving stability [79](#)

 Handbrake engaged [51](#)

Around the center console: controls and displays

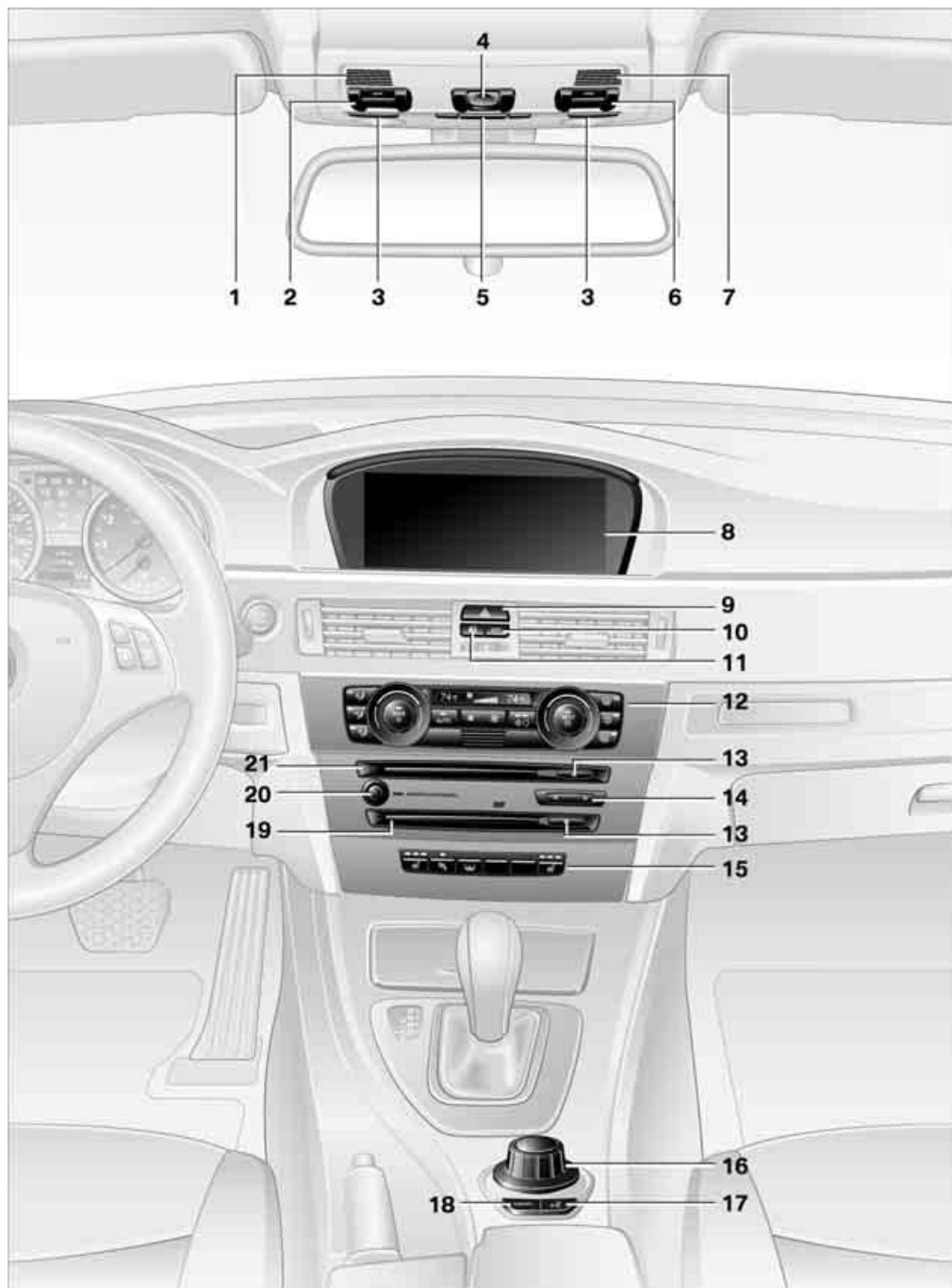

- 1 Microphone for hands-free telephone*
- 2 Initiating an emergency call*
- 3 Reading lamps 88
- 4 Glass sunroof*, electric 36
- 5 Interior lamps 87
- 6 Passenger airbag status lamp* 84
- 7 Microphone for voice command system* 22
- 8 Control Display 16
- 9 Hazard warning flashers
- 10 DTC Dynamic Traction Control 79
- 11 Central locking system 32
- 12 Automatic climate control



Air distribution to the windshield 90



Air distribution to the upper body area 90



Air distribution to the footwell 90

AUTO

Automatic air distribution and flow rate 90



Cooling function 92



AUC Automatic recirculated-air control 91



Recirculated-air mode 91



Maximum cooling 90



Residual heat mode 91



Air flow rate 91



Defrosting windows 91



Rear window defroster 92

13 Ejecting

- ▷ Audio CD 134
- ▷ Navigation DVD 114

14 Changing

- ▷ Radio stations 138
- ▷ Track 146

15



Heated seats* 41



PDC Park Distance Control* 77



Roller sun blind* 95

16 Controller 16

Can be turned, pressed, or moved horizontally in four directions

17 Activating voice command system* 22

18 Opening start menu on Control Display 17

19 Drive for navigation DVD 114

20 Switching audio sources on/off and adjusting volume 134

21 Drive for audio CDs 134

iDrive integrates the functions of a large number of switches. This allows these functions to be operated from a single central position. The following section provides an introduction to

basic menu navigation. The control of the individual functions is described in connection with the relevant equipment.

Controls

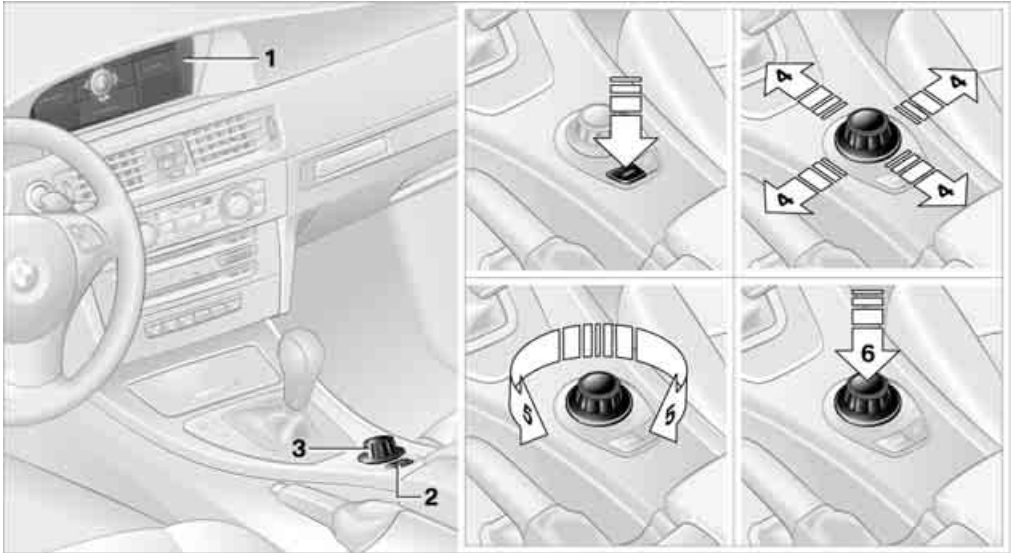

- 1 Control Display
- 2 **MENU** button
Opening start menu
- 3 Controller
The controller can be used to select menu items and to adjust settings:
 - ▷ Move in four directions, arrow 4
 - ▷ Turn, arrow 5
 - ▷ Push, arrow 6

! Operate the controller only when traffic and road conditions allow this, to avoid endangering the car's occupants and other road users by being distracted. ◀

Menu overview

Communication

- ▷ Telephone*
- ▷ BMW Assist* or TeleService*

Navigation

- ▷ Navigation system
- ▷ Onboard information, e.g. for displaying the average fuel consumption.

Entertainment

- ▷ Radio
- ▷ CD player and CD changer*
- ▷ External audio device

Climate

- ▷ Air distribution
- ▷ Automatic program

i menu

- ▷ Switching off Control Display
- ▷ Tone and display settings
- ▷ Settings for traffic information
- ▷ Settings for your vehicle, e.g. for the central locking system
- ▷ Display of service requirements and dates for statutory emissions and vehicle inspections
- ▷ Settings for telephone

Operating principle

As of radio readiness, the following message appears on the Control Display:

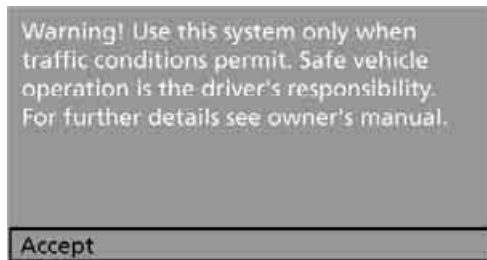

Confirm the message by pressing the controller.

This opens the start menu.

Start menu



All iDrive functions can be called up via five menu items.

Opening start menu

Press the **MENU** button.

To open the start menu from the **i** menu:

Press the **MENU** button twice.

Calling up menu items in the start menu

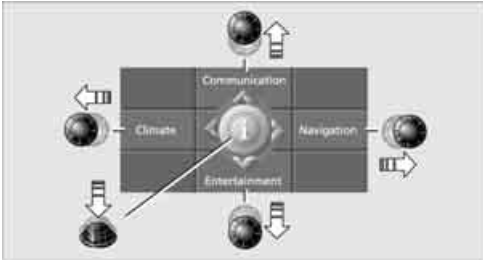

As of radio readiness, refer to page 49:

Via the start menu you can call up the four menu items of Communication, Navigation, Entertainment and Climate by moving the controller forwards, backwards, to the left or to the right. Depending on your selection, the menu last called up will be shown.

You can call up the **i** menu by pressing the controller.

Convenient call-up of menu items

The convenient call-up function enables you to:

- ▶ Call up a menu item from the start menu in the view last displayed
- ▶ Switch directly between Communication, Navigation, Entertainment and Climate without having to press the **MENU** button

To do so, move the controller in the corresponding direction and hold it for longer than approx. 2 seconds.

Displays in menu

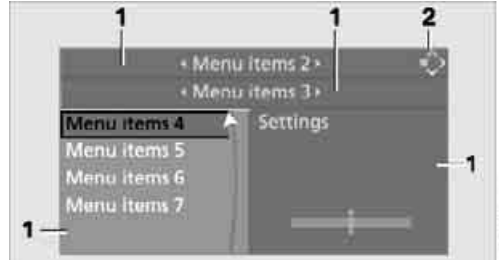

- 1 Each menu is subdivided into fields. The active field is highlighted.
- 2 A symbol indicates the start menu item last selected.

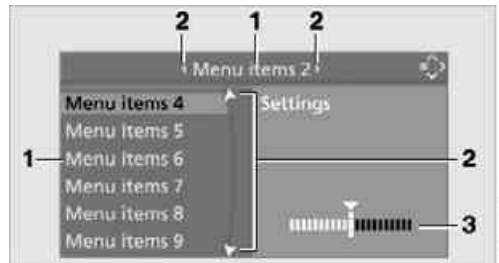
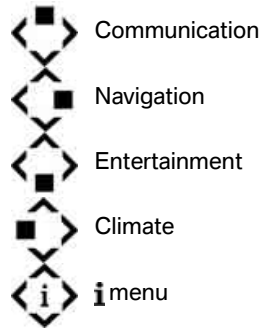

- 1 Menu items are usually grouped in horizontal or vertical lists.
- 2 In these lists, arrows indicate the possibility of accessing other menu items that are not currently visible.
- 3 Settings are represented graphically or as numerical values.

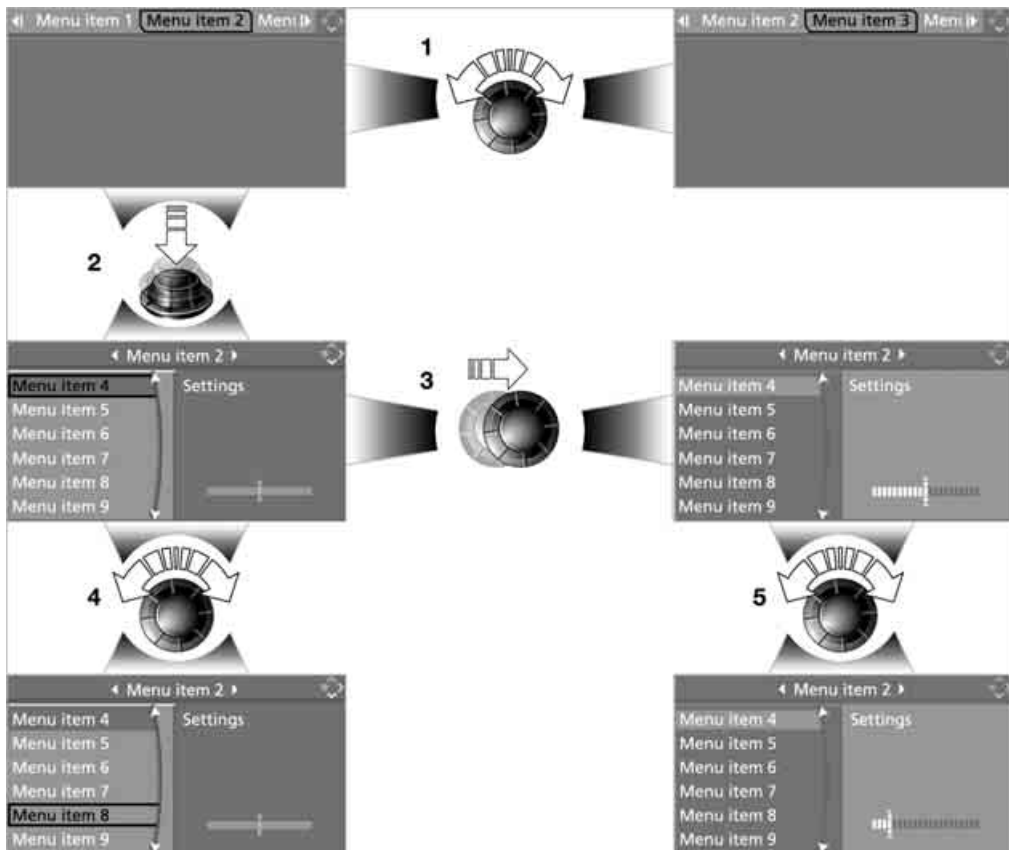

- 1 Selecting a menu item
- 2 Activating a menu item
- 3 Switching between fields
- 4 Selecting a menu item
- 5 Adjusting settings

Selecting a menu item

Turn the controller. The highlight moves. In some cases, other menu items will be visible. Menu items shown in white can be selected by highlighting them.

Activating a menu item

Press the controller. The highlighted menu item is activated. New menu items are displayed or a function is executed.

Switching between fields

Move the controller slightly left, right, forward, or backward and release. The active field is highlighted and you can select any of the menu items it features or adjust settings.

Adjusting settings

Turn the controller. This causes the graphical display, numerical values or text displays to change. When you change to another field or menu, the new setting is applied.

Status information



- 1 Display for:
 - ▷ Entertainment:
 - Radio, CD or entertainment audio output off
 - ▷ Telephone* in "Communication":
 - Name of the connected portable phone, active BMW Assist call, network search or no network
- 2 Display for:
 - ▷ New entries present in "Missed calls"*
 - ▷ Roaming active
- 3 It is possible to use the telephone* when the portable phone is paired with the vehicle
 - Reception strength of mobile phone network, depending on the portable phone
- 4 Time

Other displays:

Status information is temporarily hidden during Check Control message displays or entries via the voice command system*.

Assistance window



Additional information can be displayed in the assistance window:

- ▷ The computer or the trip computer*
- ▷ The arrow or map view in vehicles with navigation system*
- ▷ The current position

Selecting display

1. Move the controller to the right to change to the assistance window and press the controller.

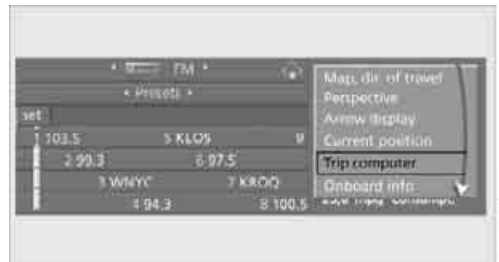

2. Select a menu item.
3. Press the controller.

Switching assistance window on/off

1. Move the controller to the right to change to the assistance window and press the controller.
2. Select "Assist. window off" and press the controller.



To turn back on, switch to the assistance window and press the controller.

Switching Control Display on/off

1. Press the **MENU** button.
This opens the start menu.
2. Press the controller to open the **i** menu.
3. Select "Display off" and press the controller.



Press the controller to switch on.

Voice command system*

The concept

The voice command system allows you to control operation of various vehicle systems without removing your hands from the steering wheel.

Individual menu items on the Control Display can be spoken as commands. It is not necessary to use the controller.

The voice command system transforms your oral commands into control signals for the selected systems and provides support in the form of instructions or questions.

The voice command system uses a special microphone located in the area of the interior rearview mirror, refer to page 14.

Precondition

Via iDrive, select the language in which the voice command system is operating, so that the spoken commands can be identified. Selecting the language for iDrive, refer to page 76.

Symbol in the Owner's Manual

- ›...‹ Say the specified commands word for word.
- ››...‹‹ Indicates responses of the voice command system.

Saying commands

Activating voice command system

1. Press the  button on the steering wheel or in the center console.



 This symbol on the Control Display and an acoustic signal indicate that the voice command system is ready to receive spoken commands.



2. Say the command.
The text or numbers that the voice command system has registered will appear on the Control Display.



 This symbol appears on the Control Display when you can input additional voice commands.

If no further spoken commands are possible, continue by operating the item of equipment via iDrive.

Terminating or canceling voice command system

Press the  button on the steering wheel or in the center console

or

 ›Cancel⟨.

Voice commands

Having the possible voice commands read aloud

You can have the system read aloud the possible voice commands related to the selected menu item on the Control Display.

To have the possible voice commands read out to you:

 ›Options⟨

For instance, if you have selected "CD", the spoken commands available for operating the CD player and CD changer are read out.

Opening help

 ›Help⟨

Using alternative voice commands

There are often a number of commands to run a function, e.g.:

 ›Information menu⟨ or ›i menu⟨

Calling up functions immediately via short commands

Short commands enable you to perform certain functions immediately, irrespective of which menu item is selected, refer to page 202.

Opening the start menu

 ›Main menu⟨

Example: selecting a track

1. If necessary, switch on entertainment audio output.
2. Press the  button on the steering wheel or in the center console.

 3. ›Entertainment⟨.
The system says:
››Entertainment⟨⟨.



 4. ›CD⟨.
The system says:
››CD on⟨⟨.



5. Press the  button on the steering wheel or in the center console.
6. Select a track, e.g.:
 ›Track 1◀.
 The system says:
 ››Track 1◀◀.



Notes

 For information on voice control of the telephone, refer also to the separate Owner's Manual. ◀

For voice commands, bear in mind the following:

- ▷ Issue the commands smoothly and at normal volume, avoiding excessive emphasis and pauses.
- ▷ Always speak the commands in the language of the voice command system.
- ▷ When selecting a radio station, use the standard pronunciation of the station name.
- ▷ For entries in the voice-activated phone book, only use names in the language of the voice command system and no abbreviations
- ▷ Keep the doors, windows and glass sunroof closed to prevent interference from ambient noise.
- ▷ Avoid making other noise in the vehicle while speaking.



The background of the page is a blurred, monochromatic image of a car's interior, showing the steering wheel on the left and the dashboard and center console in the center. The image is out of focus, creating a sense of depth and context for the text.

Controls

This chapter is intended to provide you with information for complete control of your vehicle. All features and accessories that are useful for driving and your safety, comfort and convenience, are described here.

Opening and closing

Keys/remote controls



- 1 Each remote control has an integrated key. Power is supplied by a long-life rechargeable battery that is automatically recharged when it is in the ignition lock while the car is being driven. Consequently, you should use each remote control at least twice a year in order to keep the batteries charged. The settings called up and implemented when the car is unlocked depend on which remote control is used to unlock the car, refer to Personal Profile, next page. In addition, information about service requirements is stored in the remote control, refer to Service data in the remote control on page 185.
- 2 Spare key for storage in a safe place, such as in your wallet. This key is not intended for regular use.
- 3 The adapter is designed to hold your spare key. It can be connected on the inner left-hand side of the glove compartment lid. You will find more information about the adapter under Using the adapter for a spare key.

Integrated key of remote control and spare key

The integrated key and spare key enable you to:

- ▷ Lock all the doors, the fuel filler door and the luggage compartment lid together, refer to page 31
- ▷ Unlock and lock the glove compartment, refer to page 96

- ▷ Unlock and lock the driver's door, for example in the event of an electrical malfunction, refer to page 31
- ▷ Unlock and lock the luggage compartment lid, refer to page 33

Removing the integrated key

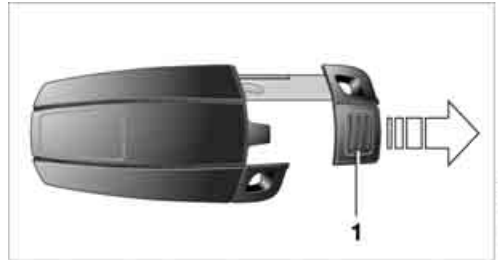

Press button 1 to release the key.

Using the adapter for a spare key



The adapter is necessary for starting the car with the spare key or switching on radio readiness.

Before using, insert the spare key into the adapter.

New remote controls

Your BMW center can supply new remote controls as additional units or as replacements in the event of loss.

Personal Profile

You can set many of your BMW's functions to suit your personal needs and preferences. Without any action on your part, Personal Profile ensures that most of these settings are stored for the remote control currently in use. When you unlock the car, the remote control used for the purpose is recognized and the settings stored for it are called up and implemented.

This means that your personal settings are active when you return to your BMW, even if the car was used in the meantime by someone else with a remote control of their own and the settings were changed accordingly.

You can configure a maximum of three remote controls for three different people. The prerequisite for this is that each person has his or her own remote control.

Personal Profile settings

For more information on specific settings, refer to the specified pages.

- ▷ Response of the central locking system when the car is unlocked, refer to page [30](#)
- ▷ Automatic locking of the vehicle, refer to page [32](#)
- ▷ Automatic adjustment of the driver's seat and the exterior mirrors after unlocking*, refer to page [43](#)
- ▷ Functions assigned to the programmable buttons* on the steering wheel, refer to page [45](#)
- ▷ 12h/24h mode of the clock, refer to page [72](#)
- ▷ Date format, refer to page [73](#)
- ▷ Brightness of the Control Display, refer to page [76](#)
- ▷ Language on the Control Display, refer to page [76](#)
- ▷ Units of measure for fuel consumption, distance covered/remaining distances, and temperature, refer to page [68](#)
- ▷ Show visual warning for Park Distance Control PDC*, refer to page [77](#)

- ▷ Automatic climate control: AUTO program, activating/deactivating cooling function and automatic recirculated-air control, setting temperature, air flow rate and distribution, refer to page [90 ff](#)
- ▷ Audio volume, refer to page [135](#)
- ▷ Tone control, refer to page [135](#)
- ▷ Speed-dependent volume control, refer to page [135](#)

Central locking system

The concept

The central locking system is ready for operation whenever the driver's door is closed.

The system simultaneously engages and releases the locks on the following:

- ▷ Doors
- ▷ Luggage compartment lid
- ▷ Fuel filler door

Operation of the central locking system from outside

- ▷ Via the remote control
- ▷ Via the door lock

The anti-theft system is automatically activated whenever you operate the central locking system from outside the vehicle. It prevents the doors from being unlocked using the lock buttons or door handles. The interior lamp and the courtesy lamps* are also switched on or off with the remote control. The alarm system* is also armed or disarmed.

For further details of the alarm system, refer to page [34](#).

Operation of the central locking system from inside

By means of the button for central locking, refer to page [32](#).

In the event of a sufficiently severe accident, the central locking system unlocks automatically. In addition, the hazard warning flashers and interior lamps come on.

Opening and closing: from outside

Using the remote control

▶ Protect the remote control against unauthorized use by handing over only the spare key, for example when using hotel valet parking. ◀

⚠ Because any persons or animals left unattended in a parked vehicle could lock the doors from the inside, Always take the remote control with you, so that the car can be opened from the outside. ◀

Unlocking



Press the  button.

You unlock the car in accordance with the setting stored in memory. The setting is stored for the remote control currently in use.

The interior lamp and the doors' courtesy lamps* come on.

You can set the way in which the car unlocks:

iDrive concept, refer to page 16.

1. Press the **MENU** button.
This opens the start menu.
2. Press the controller to open the **i** menu.
3. Select "Vehicle settings" and press the controller.
4. Select "Door locks" and press the controller.
5. Select "Central locking" and press the controller.
6. Select "Unlock button" and press the controller.
7. Select a menu item:
 - ▶ "All doors"
Press the  button once to unlock the entire vehicle.
 - ▶ "Driver's door only"
Press the  button once to unlock only the driver's door and the fuel filler door.

Press the button twice to unlock the entire vehicle.



8. Press the controller.

Convenience opening

Hold the  button down. The electric windows and the glass sunroof* are opened.

Locking

Press the  LOCK button.

Switching on interior lamps

While the car is locked:

Press the  LOCK button.

You can also use this function to locate your vehicle in parking garages etc.

Panic mode*

By pressing and holding the  button for more than approx. two seconds, you can trigger the alarm system in response to any impending danger.

To switch off the alarm: press any of the buttons.

Unlocking the luggage compartment lid

Press the  button for about one second.

The luggage compartment lid opens a short way, regardless of whether it was locked or unlocked.

▶ In order to avoid damage, make sure there is sufficient clearance in all directions before opening the luggage compartment lid. A previously locked luggage compartment lid is also locked again after closing.

Before and after each trip, check that the luggage compartment lid has not been inadvertently unlocked. ◀

Setting confirmation signals

You can program the vehicle to confirm when it has been locked or unlocked.

1. Open the start menu.
2. Press the controller to open the **i** menu.
3. Select "Vehicle settings" and press the controller.
4. Select "Door locks" and press the controller.
5. Select "Confirmation" and press the controller.



6. Select the desired signal.
7. Press the controller.
 The signal is activated.

Malfunctions

The remote control may malfunction due to local radio waves. If this occurs, unlock and lock the car at the door lock with the integrated key. If the car can no longer be locked with a remote control, the battery in the remote control is discharged. Use this remote control during an extended drive; this will recharge the battery, refer to page 28.

For US owners only

The transmitter and receiver units comply with part 15 of the FCC/Federal Communications Commission regulations. Operation is governed by the following:

FCC ID:
LX8766S

LX8766E
LX8CAS

Compliance statement:

This device complies with part 15 of the FCC Rules. Operation is subject to the following two conditions:

- ▶ This device must not cause harmful interference, and
- ▶ This device must accept any interference received, including interference that may cause undesired operation.

 Any unauthorized modifications or changes to these devices could void the user's authority to operate this equipment. ◀

Using the door lock

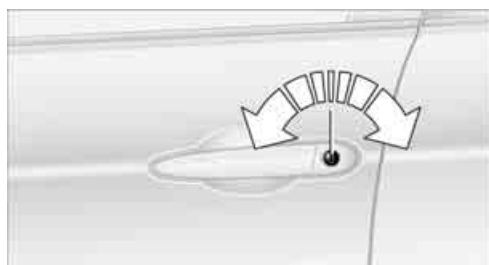

One turn of the key in the driver's door lock unlocks the driver's door only. Turning the key a second time unlocks all of the remaining doors, the luggage compartment lid and the fuel filler door.

Convenient operation*

You can also operate the power windows and glass sunroof via the door lock.

Hold the integrated key in the position for unlocking or locking.

 Watch during the closing process to be sure that no one is injured. Releasing the key stops the operation. ◀

Manual operation

In the event of an electrical malfunction, you can lock and unlock the driver's door by turning the integrated key or the spare key to the corresponding limit positions in the door lock.

Opening and closing: from inside

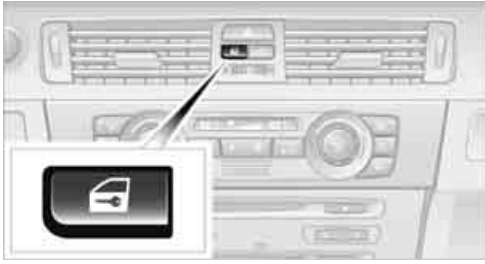

This button serves to unlock or lock doors and the luggage compartment lid, but does not activate the anti-theft system. The fuel filler door remains unlocked.

You can also set the situations in which the car locks:

iDrive concept, refer to page 16.

1. Press the **MENU** button.
This opens the start menu.
2. Press the controller to open the **i** menu.
3. Select "Vehicle settings" and press the controller.
4. Select "Door locks" and press the controller.
5. Select "Central locking" and press the controller.



6. Select a menu item:
 - ▷ "Relock door if not opened"
The central locking system automatically locks the vehicle after a short time when no door has been opened.
 - ▷ "Lock after driving"
The central locking system automati-

cally locks the vehicle as soon as you start to drive.

7. Press the controller.
 The setting is selected.

The setting is stored for the remote control currently in use.

Unlocking and opening doors

- ▷ Either unlock the doors together using the button for the central locking system and then pull the door handle above the armrest or
- ▷ pull on the door handle of each door twice: the first time unlocks the door, the second time opens it.

Locking

- ▷ Use the central locking button to lock all of the doors simultaneously, or
- ▷ press down the safety lock button of a door. To prevent you from being locked out, the open driver's door cannot be locked using the lock button.

 Because any persons or animals left unattended in a parked vehicle could lock the doors from the inside, Always take the remote control with you, so that the car can be opened from the outside. ◀

Luggage compartment lid

 In order to avoid damage, make sure there is sufficient clearance in all directions before opening the luggage compartment lid. ◀

Opening from inside



Press the button: the luggage compartment lid opens unless it has been locked.

Opening from outside



Press the button, see arrow, or press the  button on the remote control for approx. 1 second. The luggage compartment lid will open slightly. It can now be swung upwards.

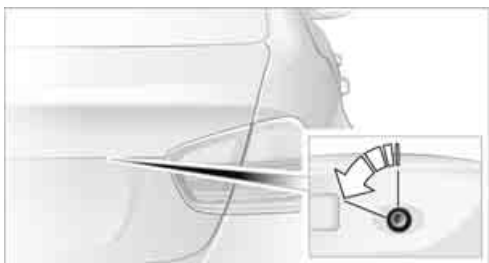

The integrated key of the remote control and the reserve key, refer to page 28, fit the luggage compartment lid lock.

Opening manually

Turn the integrated key of the remote control or the spare key all the way to the left: the luggage compartment lid opens.

 If you unlock and open the luggage compartment lid with the key while the alarm system is armed, the alarm will be triggered. Switching off an alarm, refer to page 34. ◀

Locking or unlocking separately

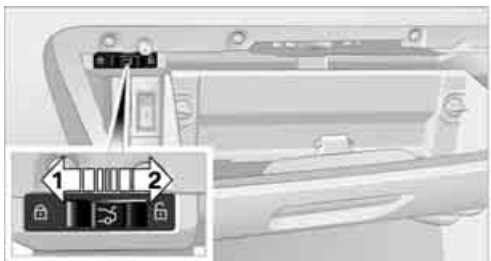

The switch is located in the glove compartment.

- 1 Locking the luggage compartment lid
- 2 Unlocking the luggage compartment lid

Locking separately

Push the switch in the direction of arrow 1. The luggage compartment lid is locked and cannot be unlocked using the central locking system.

If you give the remote control without the integrated key to someone else while the glove compartment is locked, the luggage compartment lid cannot be opened. This is an advantage when valet parking, for example.

Unlocking separately

Push the switch in the direction of arrow 2.

Emergency release



This lever releases the luggage compartment lid from inside the luggage compartment.

Closing



The handle recesses on the interior trim of the luggage compartment lid make it easier to pull down.

⚠ Make sure that the closing path of the luggage compartment lid is clear, as otherwise injuries may result. ◀

Alarm system*

The concept

The vehicle alarm system responds:

- ▷ When a door, the hood or the luggage compartment lid is opened
- ▷ To movements inside the vehicle: Interior motion sensor, refer to the information further below
- ▷ When the car's inclination changes, for instance if an attempt is made to jack it up and steal the wheels or to raise it prior to towing away
- ▷ When there is an interruption in the power supply from the battery.

The system responds to unauthorized vehicle entry and attempted theft by simultaneously activating:

- ▷ An acoustic alarm, which lasts for a period of approx. 30 seconds
- ▷ The hazard warning flashers, which operate for approx. 5 minutes*
- ▷ The high beams, which flash on and off in the same rhythm.

Arming and disarming

When you lock or unlock the vehicle, either with the remote control or at the door lock, the alarm system is armed or disarmed at the same time.

The system indicates that it has been correctly armed by switching on the hazard warning flashers for a single cycle and by emitting an acoustic signal.

Even when the alarm system is armed, you can open the luggage compartment lid by means of the  button on the remote control, refer to page 30. When you subsequently close the luggage compartment lid it is again locked and monitored.

Switching off an alarm

- ▷ Unlock the car with the remote control, refer to page 30, or
- ▷ insert the remote control all the way into the ignition lock.

Indicator lamp displays



- ▷ The indicator lamp under the inside rearview mirror flashes continuously: the system is armed.
- ▷ The indicator lamp flashes after locking: doors, hood or luggage compartment lid are not properly closed. Even if you do not close the alerted area, the system begins to monitor the remaining areas, and the indicator lamp flashes continuously after approx. 10 seconds. However, the interior motion sensor is not activated.
- ▷ The indicator lamp goes out after unlocking: your vehicle has not been disturbed while you were away.

- ▷ If the indicator lamp flashes after unlocking until the remote control is inserted in the ignition, but for no longer than approx. 5 minutes: your vehicle has been disturbed while you were away.

Tilt alarm sensor and interior motion sensor

Tilt alarm sensor

The tilt of the vehicle is monitored. The alarm system reacts, e.g. to attempts to steal a wheel or tow the vehicle.

Interior motion sensor

In order for the interior motion sensor to function properly, the windows and glass sunroof must be completely closed.

Avoiding unintentional alarms

The tilt alarm sensor and interior motion sensor may be switched off at the same time. This prevents unintentional alarms, e.g. in the following situations:

- ▷ In duplex garages
- ▷ When transporting on car-carrying trains
- ▷ When animals are to remain in the vehicle

Switching off tilt alarm sensor and interior motion sensor

Press the  LOCK button on the remote control twice in a row.

The indicator lamp comes on for approx. two seconds, then begins to flash steadily. The tilt alarm sensor and the interior motion sensor are switched off until the next time the vehicle is unlocked and subsequently locked again.

Windows

 To prevent injuries, exercise care when closing the windows and keep them in your field of vision until they are shut. When leaving the car, take the remote control out of the ignition lock and close the doors, oth-

erwise children could operate the power windows and possibly injure themselves. ◀

Opening, closing

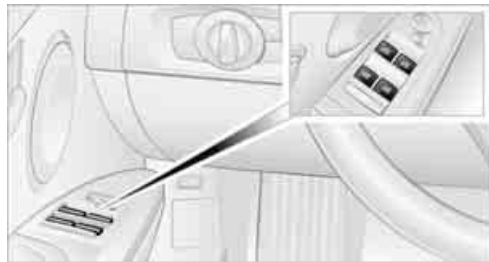

- ▷ Press the switch to the resistance point. The window continues to open as long as you keep the switch pressed.
- ▷ Briefly press the switch beyond the resistance point. The window opens automatically. Briefly press the switch again to stop the opening movement.

You can close the windows in the same manner by pulling the switch.

There are separate switches in the rear seat armrests.

After switching off the ignition

You can still operate the windows:

- ▷ In radio readiness, for approx. 15 minutes
- ▷ For about one minute when the remote control is removed or the ignition and radio readiness are switched off, as long as neither front door has been opened

For information on convenient operation via the remote control or door lock, refer to page 30 or 31.

 Take the remote control with you when you leave the car, otherwise children could operate the electric windows and possibly injure themselves. ◀

Anti-trapping mechanism

If the closing force of an electric window exceeds a specific value as it closes, the closing

action is interrupted immediately and the window reopens slightly.

⚠ Despite the anti-trapping mechanism inspect the window's travel path prior to closing it, as the safety system might fail to detect certain kinds of obstructions, such as thin objects, and the window would continue closing.

Pulling the switch beyond the resistance point and holding it limits the response of the anti-trapping mechanism. In this case, if the closing force exceeds a defined threshold, the window will only open a few fractions of an inch/a few millimeters.

If the switch is pulled past the resistance point again within approx. 4 seconds, the anti-trapping mechanism will be deactivated. ◀

Safety switch



With the safety switch, you can prevent the rear windows from being opened or closed via the switches in the rear passenger area, by children, for example. When the safety function is switched on, the indicator lamp comes on.

⚠ Always press the safety switch when children ride in the rear, as otherwise unchecked closing of the windows could lead to injuries. ◀

Accessories in a window area

If you install accessories within the power window movement range, e.g. a clip-on antenna for your portable phone, the system must be initialized to teach it the new conditions. BMW recommends having this work done by your BMW center.

Glass sunroof*, electric

The glass sunroof is operational when the ignition is switched on, refer to page 49.

⚠ To prevent injuries, exercise care when closing the glass sunroof and keep it in your field of vision until it is shut. Take the remote control with you and close the doors when you leave the car, otherwise children could operate the sunroof and possibly injure themselves. ◀



Raising

Press the switch.

- ▷ When the glass sunroof is closed, it is raised slightly and the sliding visor opens slightly.
- ▷ When the glass sunroof is open, it automatically travels into the raised position. The sliding visor remains completely open.

⚠ Do not close the sliding visor forcibly with the roof in the raised position, as this could damage the mechanism. ◀

Opening, closing

- ▷ Press the switch back to the resistance point. The glass sunroof and the sliding visor open together for as long as you hold the switch in position.
- ▷ Press the switch back past the resistance point. The glass sunroof and the sliding visor open automatically. Briefly press the switch again to stop the opening movement.

You can close the glass sunroof in a similar manner by sliding the switch forward. The slid-

ing visor remains open and must be closed by hand.

For information on convenient operation via the remote control or door lock, refer to page 30 or 31.

Anti-trapping mechanism

If the glass sunroof encounters an obstruction during closing from approximately the middle of the opening in the roof, or during closing from the raised position, the closing movement is interrupted and the glass sunroof is opened again slightly.

 Despite the anti-trapping mechanism check and clear the sunroof's travel path prior to closing it, as the safety system might fail to detect certain kinds of obstructions, such as very thin objects, and the sunroof would continue closing.

Pressing the switch beyond the resistance point and holding it there deactivates the anti-trapping mechanism. ◀

Following interruptions in electrical power supply

After a power failure, there is a possibility that the glass sunroof can only be raised. The system must be initialized. BMW recommends having this work done by your BMW center.

Manually opening and closing

In the event of an electrical malfunction, you can move the glass sunroof manually:

1. Unclip the front of the cover for the interior lamps using the screwdriver from the onboard tool kit, refer to page 187.



2. Insert the screwdriver into the openings on each side to press the clips.



3. Remove the cover panel.
4. Insert the Allen wrench supplied with the onboard tool kit, refer to page 187, into the opening provided. Turn the glass sunroof in the desired direction.



5. Reattach the cover for the interior lamps and install the cover panel.

Adjustments

Sitting safely

The ideal sitting position can make a vital contribution to relaxed, fatigue-free driving. In conjunction with the safety belts, the head restraints and the airbags, the seated position has a major influence on your safety in the event of an accident. To ensure that the safety systems operate with optimal efficiency, we strongly urge you to observe the instructions contained in the following section.

For additional information on transporting children safely, refer to page 46.

Airbags



Always maintain an adequate distance between yourself and the airbags. Always grip the steering wheel on the rim, with your hands in the 3 o'clock and 9 o'clock positions, to minimize the risk of injury to the hands or arms in the event of the airbag being triggered off.

No one and nothing is to come between the airbags and the seat occupant.

Do not use the cover of the front airbag on the front passenger side as a storage area. Make sure that the front passenger is sitting correctly and does not rest feet or legs on the instrument panel, otherwise leg injuries can occur if the front airbag is triggered. Never let an occupant's head rest near or on a side airbag because the inflating airbag could cause a serious or fatal injury. ◀

Even if you adhere to all the instructions, injuries resulting from contact with airbags cannot be fully excluded, depending on the circumstances. The ignition and inflation noise may provoke a mild hearing loss in extremely sensitive individuals. This effect is usually only temporary.

For airbag locations and additional information on airbags, refer to page 82.

Head restraint

A correctly adjusted head restraint reduces the risk of neck injury in the event of an accident.



Adjust the head restraint in such a way that its center is at approx. ear level. Otherwise, there is a risk of injury should an accident occur. ◀

Safety belt

Before every drive, make sure that all occupants wear their safety belts. Airbags complement the safety belt as an additional safety device, but they do not represent a substitute.



At all times, occupants should sit upright and be properly restrained: infants and small children in appropriate child-restraint systems; larger children and adults using the safety belts. Never allow more than one person to wear a single safety belt. Never allow infants or small children to ride in a passenger's lap. Expectant mothers should also wear the safety belt, making sure that the strap in the pelvic area is well down on the hips and does not press against the abdominal region of the body.

Do not route the belt across your neck, or run it across sharp edges. Be sure that the belt does not become caught or jammed. The safety belt should not be twisted and must be positioned firmly over the pelvis and shoulder, as close to the body as possible. It should not pass over hard or fragile objects, otherwise the belt in the pelvic area could slide over the hips in the event of a head-on collision and injure the lower abdomen. Avoid wearing bulky clothing and regularly pull the belt in the upper-body area taut, otherwise its restraining effect could be impaired. ◀

Safety belts, refer to page 43.

Seats

Note before adjusting

! Never attempt to adjust your seat while the vehicle is moving. The seat could respond with unexpected movement, and the ensuing loss of vehicle control could lead to an accident.

On the front passenger seat as well, do not incline the backrest too far to the rear while the vehicle is being driven, as otherwise there is a danger in the event of an accident of sliding under the safety belt, eliminating the protection normally provided by the belt. ◀

Comply with the instructions on head restraint height on page 40, and on damaged safety belts on page 43.

Seat adjustment

! Observe the adjustment instructions on page 39 to ensure the best possible personal protection. ◀

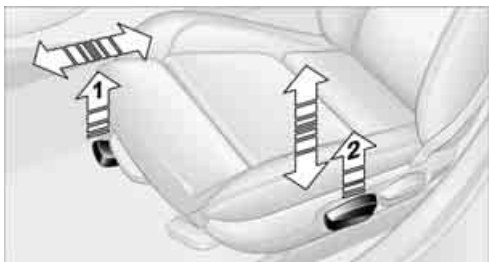

Longitudinal direction

Pull lever **1** and slide the seat to the desired position.

After releasing the lever, move the seat gently forward or back to make sure it engages properly.

Height

Pull lever **2** and apply your weight to the seat or lift it off, as necessary.

Backrest

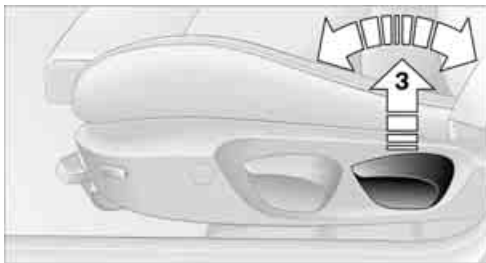

Pull lever **3** and apply your weight to the backrest or lift it off, as necessary.

Lumbar support*



You can also adjust the contour of the backrest to obtain additional support in the lumbar region.

The upper hips and spinal column receive supplementary support to help you maintain a relaxed, upright sitting position.

- ▷ Increase or decrease curvature: push switch forward or back.
- ▷ Shift curvature up or down: push switch up or down.

Electric seat adjustment

! Comply with the adjusting instructions mentioned above to ensure the best possible personal protection. ◀

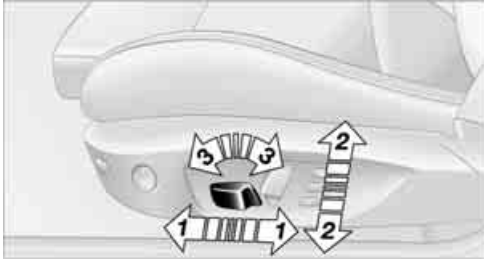

- 1 Longitudinal direction
- 2 Height
- 3 Angle

Angle

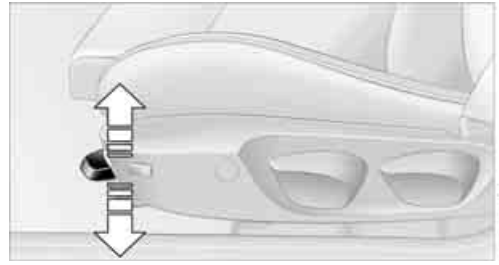

Pull the lever and apply your weight to the seat or lift it off, as necessary.



4 Backrest

The head restraints are adjusted manually, refer to Head restraints below.

Backrest width



You can change the width of the backrest to suit your individual preferences by adjusting the lateral-support pads.

Sports seat*

On this seat, you can manually adjust the thigh support, the tilt angle and the width of the backrest.

Push switch forward or back.

Backrest width decreases or increases accordingly.

Thigh support

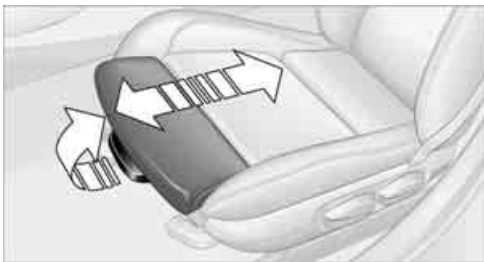

Pull the lever and move the thigh support forward or back.

Head restraints

A correctly adjusted head restraint reduces the risk of neck injury in the event of an accident.

 Adjust the head restraint in such a way that its center is at approx. ear level. Otherwise, there is a risk of injury should an accident occur. ◀

Front seats

Height adjustment

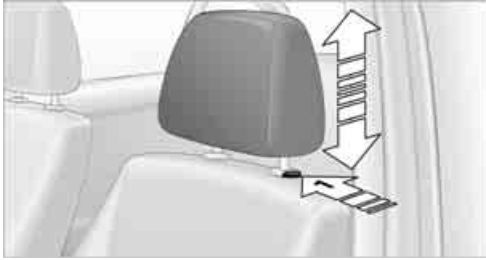

- ▷ To raise: pull up.
- ▷ To lower: press the button, arrow 1, and slide the head restraint down.

Removing

1. Pull up all the way.
2. Press the button, arrow 1, and pull the head restraint all the way out.

Rear seats

Height adjustment

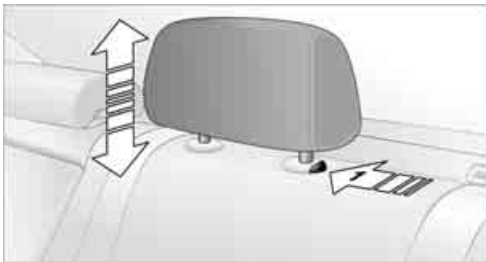

- ▷ To raise: pull up.
- ▷ To lower: press the button, arrow 1, and slide the head restraint down.

The center head restraint is not height-adjustable.

Removing

1. Pull up all the way.
2. Press the button, arrow 1, and pull the head restraint all the way out.
Vehicles equipped with through-loading

system: fold the rear-seat backrest slightly forward before pulling out a head restraint.

Folding the center head restraint down and up

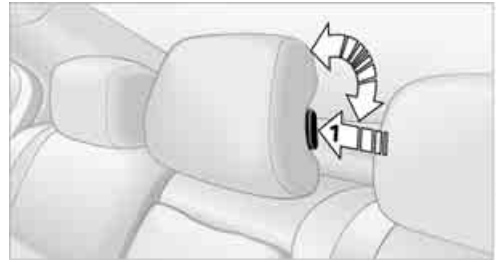

Folding up:
Pull the head restraint.

Folding down:
Press the button, arrow 1.

 Note that it is an offense to drive with the rear seats occupied and the rear head restraints folded down. Fold up the head restraints before allowing passengers to occupy the rear seats. ◀

Heated seats*



Press once for each temperature level.
Three lamps indicate the highest temperature.

To switch off:
Press button longer.

If you continue driving within the next 15 minutes, the seat heating is automatically activated at the previously set temperature.

Seat and mirror memory*

You can store and call up two different combinations of driver's-seat and exterior-mirror positions.

Settings for the seat back width and lumbar support are not stored in memory.

Storing

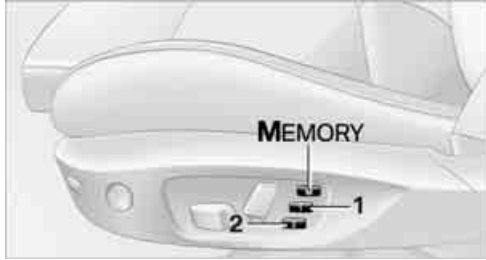

1. Switch on radio readiness or the ignition, refer to page 49.
2. Adjust the seat and exterior mirrors to the desired positions.
3. Press the **M** button.
The LED in the button lights up.
4. Press the desired memory key **1** or **2**.
The LED goes out.

Automatic call-up

You can select when the memorized positions of the driver's seat and exterior mirrors are to be called up.

- ▷ Call-up when the vehicle is unlocked
- ▷ Call-up when the driver's door is opened.

 When this Personal Profile function is used, first ensure that the footwell behind the driver's seat is free of obstacles. Failure to do so could cause injury to persons or damage to objects as a result of a rearward movement of the seat. ◀

The adjusting procedure is immediately halted when you press a seat adjustment switch or one of the MEMORY buttons.

You can program this via iDrive:

iDrive concept, refer to page 16.

1. Open the start menu.
2. Press the controller to open the **i** menu.
3. Select "Vehicle settings" and press the controller.
4. Select "Door locks" and press the controller.
5. Select "Central locking" and press the controller.
6. Select "Last seat pos." and press the controller.
7. Select "After unlocking" or "After door opened".



8. Press the controller.

Manual call-up

 Do not call up memory while you are driving, as unexpected seat movement could result in an accident. ◀

Convenience mode

1. Unlock and open the driver's door or switch on radio readiness, refer to page 49.
2. Briefly press the desired memory button **1** or **2**.

The adjusting procedure is immediately halted when you press a seat adjustment switch or one of the MEMORY buttons.

Safety feature

1. Close the driver's door and switch the ignition on or off, refer to page 49.
2. Press the desired memory button **1** or **2** and maintain pressure until the adjustment process has been completed.

If the **M** button was pressed accidentally: press the button again; the LED goes out.

Safety belts

 Observe the adjustment instructions on page 39 to ensure the best possible personal protection. ◀

Before every drive, make sure that all occupants wear their safety belts. Airbags complement the safety belt as an additional safety device, but they do not represent a substitute.

On the rear seats, the center belt lock marked with the letters CENTER is solely intended for the center passenger.



Fastening

Make sure you hear the latch plate engage in the belt buckle.

The upper belt anchorage is suitable for adults of any stature as long as they are sitting correctly, refer to page 39.

Opening

1. Grasp the belt firmly.
2. Press the red button in the buckle.
3. Guide the belt into its reel.

'Fasten safety belts' reminder for front seats



The indicator lamp comes on and an acoustic signal sounds. In addition, a message will appear on the Control Display. Check whether the safety

belt has been fastened correctly.

The 'Fasten safety belts' reminder is issued as long as the driver's safety belt has not been fastened. The 'Fasten safety belts' reminder is also activated at road speeds above approx. 5 mph or 8 km/h if the front passenger's safety belt is not fastened, if heavy objects are placed on the front passenger seat, or if driver or front passenger unfasten their safety belts.

Damage to safety belts

 If the safety belts are damaged or stretched in an accident: have the entire belt system, including the tensioning mechanisms, replaced at your BMW center or at a workshop that works according to BMW repair procedures with correspondingly trained personnel. Have the belt anchorage points inspected for damage at the same time. Failure to observe this precaution may prevent the safety belts from effectively providing optimal protection when needed. ◀

Mirrors

Exterior mirrors

 The mirror on the front passenger's side features a lens with a more convex surface than the mirror installed on the driver's side. When estimating the distance between yourself and other traffic, bear in mind that the objects reflected in the mirror are closer than they appear. This means that estimations of the distance to following traffic should not be regarded as precise. ◀



- 1 Adjustments
- 2 Switching to the other mirror or automatic curb monitor*

The positions of the exterior mirrors are stored for the remote control currently used*, refer to Personal Profile, page 29.

Manual adjustment

The mirrors can also be adjusted manually, if necessary: press the edge of the glass.

⚠ To prevent the exterior mirrors on this vehicle from being damaged, always fold them in by hand before entering an automatic car wash. ◀

Automatic heating*

At outside temperatures below a certain limit, both exterior mirrors are automatically heated while the engine is running or the ignition switched on.

Passenger-side mirror tilt function* – automatic curb monitor

Activating

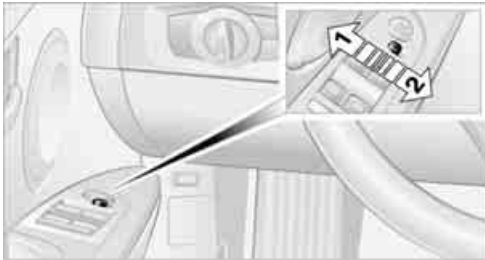

1. Push the mirror selector switch to the position for the driver's-side mirror 1.
2. Engage reverse gear or move the selector lever to position R.
The glass of the mirror on the passenger side tilts slightly down. This allows the driver to see the area immediately adjacent to the vehicle – such as a curb – when parking, etc.

Deactivating

Push the mirror selector switch to the position for the passenger-side mirror 2.

Interior rearview mirror



Turn the knob underneath the mirror to reduce glare from the headlamps of cars behind you when driving at night.

Automatically dimming mirrors, refer to page 107.

Steering wheel

Adjustments

⚠ Do not adjust the steering wheel position while the car is in motion, or an accident may result from any unexpected movement. ◀



1. Fold the lever down.
2. Move the steering wheel to the preferred height and angle to suit your seated position.
3. Swing the lever back up.

Electric steering wheel lock

The steering wheel locks or unlocks automatically when the remote control is removed or inserted, refer to page 49.

Programmable buttons on the steering wheel

You can program the buttons to suit your personal preferences:



These settings are stored for the remote control currently in use.

iDrive concept, refer to page 16.

1. Press the **MENU** button.
This opens the start menu.
2. Press the controller to open the **i** menu.
3. Select "Vehicle settings" and press the controller.
4. Select "Steering wheel buttons" and press the controller.

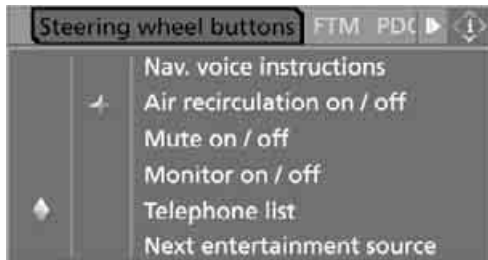

A list showing various functions is displayed:

- ▷ "Navigation voice instructions"
Voice messages from the navigation system
- ▷ "Air recirculation on / off"
Permanent shut-off of outside air, refer

to Automatic recirculated-air control AUC on page 91

- ▷ "Mute on / off"
To mute the audio sources
 - ▷ "Monitor on / off"
Switching Control Display on/off
 - ▷ "Telephone list"
Switch between any menu and telephone
 - ▷ "Next entertainment source"
To change the audio source
5. Select the desired function and press the controller.
 6. Select a button, if appropriate, and press the controller.



You can operate the selected function using the corresponding button.

Operating function

Briefly press the appropriate button in the steering wheel.

Voice instructions of navigation system:

- ▷ Switch voice instructions on/off:
Press button for longer
- ▷ To repeat the last voice instruction:
Press the button briefly
- ▷ To cancel a voice instruction during an announcement:
Press the button briefly

Transporting children safely

The right place for children

 Do not leave children unattended in the vehicle, as they could otherwise endanger themselves and/or other persons by opening the doors, for example. ◀

As a general rule, the front passenger's seat and outer rear seats are suitable for installing universal child-restraint systems for all age groups, provided that they have been approved for the age group in question.

Children always in the rear

Accident research shows that the safest place for children in a vehicle is in the rear seat.

Older children should be tightly secured with a safety belt, after they have outgrown a booster seat that is appropriate for their age, height and weight.

 If your BMW is equipped with rear side airbags, do not allow children to lean towards the door trim, as serious injuries could occur if the side airbags are deployed and children are too close to the airbags. ◀

Deactivating rear seat side airbags

Labels in the rear door opening should indicate the status of your rear seat side airbags. If you are uncertain of their status, or wish to have the airbags activated or deactivated, please contact your BMW center.

Child-restraint system in the rear

 Children under the age of 13 or smaller than 5 ft/150 cm may only be transported in suitable child-restraint systems on one of the outer rear seats; otherwise, there is an increased risk of injury in the event of an accident. ◀

Younger children should be secured in an appropriate child-restraint system that has been first properly secured to the vehicle.

All rear seating positions in your vehicle meet the recommendations of SAE J1819, an industry-recommended practice for securing child-restraint systems in motor vehicles.

Exception for front passenger seat

 Should it be necessary to use a child-restraint system on the front passenger seat, the front passenger airbags must be deactivated. Otherwise, a child traveling on that seat will be at considerable risk of injury if the airbags are triggered off, even with a child-restraint system. Your vehicle is equipped with an airbag supplemental restraint system for the front passenger. Because the backrest on any rearward-facing child-restraint system – of the kind designed for infants under 1 year and 20 lbs./ 9 kg – would be within the airbag's deployment range, you should never mount such a system in the front passenger seat, since the impact of the airbag against the child restraint's backrest could lead to serious or fatal injuries. ◀

For more information on automatic deactivation of the front passenger airbags refer to page 83.

Seat height

Before installing a universal child-restraint system, move the front passenger's seat up as far as it will go to ensure that the safety belt will be ideally positioned. Do not change the seat height afterward.

Backrest width

 The backrest width of the front passenger's seat must be adjusted to its widest setting. ◀

1. After unlocking the vehicle, sit down on the front passenger seat and close the door.
2. Adjust the backrest width to its widest setting, refer to page 40.
3. Install the child seat.

Installing child-restraint systems

Before installing any child-restraint system or child seat, read the following:

⚠ Observe the child-restraint system manufacturer's instructions for installation and use. Otherwise the degree of protection may be reduced. After an accident, have all parts of the child-restraint system and of the relevant vehicle safety belt system checked and replaced if necessary. Have this work done only at your BMW center or at a workshop that works according to BMW repair procedures with correspondingly trained personnel. ◀

Commercially-available child-restraint systems are designed to be secured with a lap belt or with the lap belt portion of a combination lap/shoulder belt. Improperly or inadequately installed restraint systems can increase the risk of injury to children. Always read and follow the instructions that come with the system.

Child seat security



All of the rear belt retractors and the front passenger safety belt can be locked for mounting and securing child-restraint systems.

Information regarding this is located near the buckle latch of each safety belt.

To lock the safety belt

Pull the entire length of the belt from the belt retractor. Allow the reel to retract the belt somewhat and engage the buckle, then tighten the belt against the child-restraint system. The retraction mechanism is now locked.

To unlock the safety belt

Release the buckle, remove the child-restraint system and allow the belt retractor to reel the belt completely in.

Child-restraint system with tether strap

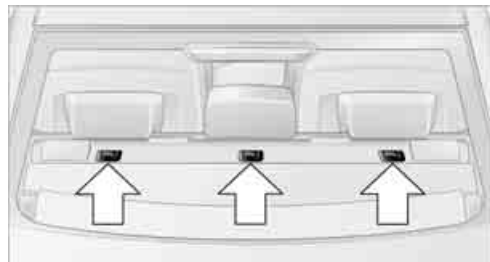

If you use a child-restraint system with a tether strap, three additional tether anchorage points have been provided, refer to the arrows in the illustration. Depending on the location selected for seating in the rear passenger area, attach the tether strap to the corresponding anchorage point to secure the child-restraint system, as shown in the illustration below.

Placement of the tether strap

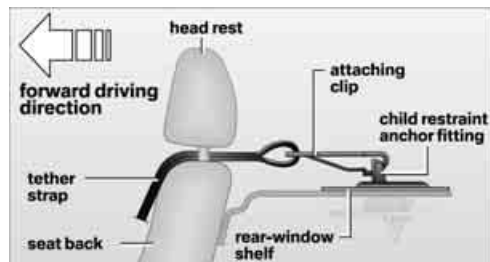

Outer sitting positions:

Lift the head restraint and pass the tether strap between the head restraint and the seat back. It is recommended to readjust the head restraint into the lowest possible position.

Center sitting position:

Push the center head restraint upward. Guide the tether strap between the head restraint and the rear seat back. The tether strap must be between the anchorages of the head restraint.

Then push the center head restraint into the lowest position again.

 Adjust the tether strap according to the child-restraint manufacturer's instructions. ◀

LATCH child-restraint fixing system

LATCH: Lower Anchor and Tethers for Children.

The rear outer sitting positions are provided with anchors for a LATCH child-restraint fixing system.

 To attach a child-restraint system with the LATCH system, follow the operating and safety instructions of the child-restraint system manufacturer. ◀

Rear seat anchorages, with through-loading system



The anchorage points for the LATCH child-restraint fixing system are located behind the indicated protective caps. Flip up the corresponding caps.

Before attaching the LATCH child-restraint fixing system, pull the belt out of the area of the child-restraint fixing system.

Rear seat anchorages, without through-loading system

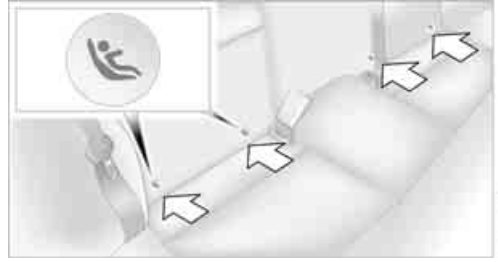

The anchorage points for the LATCH child-restraint fixing system are located underneath the identifying symbols.

Before attaching the LATCH child-restraint fixing system, pull the belt out of the area of the child-restraint fixing system.

On journeys

Child-safety locks for rear doors



Slide down the safety lever on the rear doors: The door can now be opened from the outside only.

Safety switch for power windows

Press the safety switch for the power windows, refer to page 36, if children are traveling on the rear seat.

Driving

Ignition lock



Insert the remote control all the way into the ignition lock.

- ▷ Radio readiness switches on. Individual electrical consumers can operate.
- ▷ The electric steering wheel lock disengages audibly.

⚠ Insert the remote control into the ignition lock before you move the vehicle, as otherwise the electric steering wheel lock will not disengage and you will not be able to steer the car. ◀

Removing the remote control from the ignition lock

Press the remote control in briefly; it is ejected a short way.

At the same time:

- ▷ The ignition switches off if it was on beforehand.
- ▷ The electric steering wheel lock engages audibly.

Automatic transmission

You cannot take out the remote control unless the selector lever is in the P position: interlock.

Start/stop button



Each time the start/stop button is pressed, radio readiness or the ignition is switched on or off.

▶ Do not depress the brake pedal or the clutch pedal, otherwise the engine will start. ◀

Radio readiness

Individual electrical consumers can operate. The time and the outside temperature are displayed in the instrument cluster.

Radio readiness is switched off automatically:

- ▷ Immediately when the remote control is removed from the ignition lock

Ignition on

Most of the indicator and warning lamps in the indicator area 1 of the instrument cluster, refer to page 13, light up and remain on for different lengths of time.

Radio readiness and ignition switched off

All indicator and warning lamps in the instrument cluster go out.

Starting the engine

⚠ Do not run the engine in closed rooms, as otherwise the inhaling of toxic exhaust gases can cause unconsciousness and death.

The exhaust gases contain carbon monoxide, an odorless and colorless, but highly toxic gas. Never leave an unattended vehicle with the engine running, as such a vehicle represents a potential safety hazard.

Before leaving the car with the engine running, place the transmission in idle or move the selector lever to position P and apply the handbrake to prevent the car from moving. ◀

When starting the engine, do not press the accelerator pedal.

Do not allow the engine to warm up by leaving it running while the vehicle remains stationary. Instead, begin to drive immediately at a moderate engine speed.

 Do not press either the brake pedal or the clutch pedal until you are ready to start the engine. The engine is started immediately when you briefly touch the start/stop button and depress the brake pedal if the car has automatic transmission, or the clutch pedal if the car has manual transmission. ◀



Manual transmission

1. Apply the handbrake.
2. Press the clutch pedal.

 If the clutch pedal is not depressed, the engine will not start. ◀

3. Briefly press the start/stop button.

The starter is operated automatically for a certain time, and operation ceases automatically as soon as the engine has started.

Automatic transmission

1. Press the brake pedal.
2. Move the selector lever to position P or, if the ignition is switched on, to position N.

3. Briefly press the start/stop button.

The starter is operated automatically for a certain time, and operation ceases automatically as soon as the engine has started.

Special starting conditions

In the following situations, press the accelerator pedal halfway down when starting the engine:

- ▷ If the engine does not start on the first attempt, for instance when it is extremely hot or cold.
- ▷ The engine is started at very low temperatures, below approx. + 5 °F / -15 °C, at high altitudes, above approx. 3,300 ft / 1,000 m.

 Avoid frequent starting in quick succession or repeated start attempts in which the engine does not start. Otherwise, the fuel is not burned or inadequately burned and there is a danger of overheating and damaging the catalytic converter. ◀

Switching off the engine

 Do not take the remote control out of the ignition lock while the vehicle is rolling, as otherwise the steering wheel lock will engage when you turn the steering wheel. Always take the remote control with you when you leave the vehicle.

When parking on a downhill incline, apply the handbrake, as otherwise the vehicle could roll away. ◀

Manual transmission

1. Apply the handbrake.
2. With the car at a standstill, briefly press the start/stop button.
3. Shift into first gear or reverse.

Automatic transmission

1. With the car at a standstill, move the selector lever to position P.
2. Briefly press the start/stop button.
3. Apply the handbrake.

Handbrake

The handbrake is primarily intended to prevent the vehicle from rolling while parked; it brakes the rear wheels.

Indicator lamp



The indicator lamp is lit, and when you drive off an acoustic signal sounds in addition. The handbrake is still applied.



Indicator lamp for Canadian models.

Applying

The lever locks in position automatically.

Releasing



Pull slightly upwards, press the button and lower the lever.

 In exceptional cases, if the handbrake has to be used to slow or stop the car, do not pull the lever up too hard. In doing so, continuously press the button of the handbrake lever. Too violent an application of the handbrake could lock the rear wheels and cause the rear of the car to swerve.

The brake lamps do not light up when the handbrake is applied. ◀

 To prevent corrosion and one-sided braking action, occasionally apply the handbrake lightly when the vehicle is slowly coming to a stop if the traffic conditions are suitable. ◀

Manual transmission

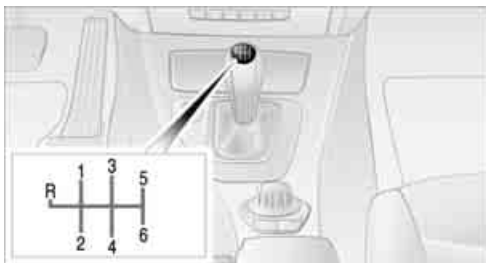

 When shifting into 5th or 6th gear, press the gearshift lever to the right. Otherwise the engine could be damaged if you inadvertently shift into 3rd or 4th gear. ◀

Reverse gear

Select only when the vehicle is stationary. When the gearshift lever is pressed to the left, a slight resistance has to be overcome.

Automatic transmission with Steptronic*

In addition to fully automatic operation, you can also manually shift with the Steptronic, refer to page 52.

Vehicle parking

 To prevent the vehicle from rolling, always select position P and apply the handbrake before leaving the vehicle with the engine running. ◀

Disengaging the remote control

In order to remove the remote control from the ignition lock, you must first move the selector lever to position P and switch off the engine: interlock.

Selector lever positions

P R N D M/S + -

Displays in the instrument cluster



P R N D S M1 to M6

The selector lever position is displayed, or the current gear in the manual mode.

Changing selector lever positions

- ▷ With the ignition switched on or the engine running, the selector lever can be moved out of position P: interlock.
- ▷ Before moving the lever away from P or N with the vehicle stationary, first depress the brake pedal, otherwise the selector lever will refuse to move: shiftlock.



To prevent the vehicle from creeping after you select a driving position, maintain pressure on the brake pedal until you are ready to start. ◀



A lock prevents you from inadvertently engaging selector lever positions R and P. To cancel the lock, press the button on the front of the selector lever knob, refer to arrow.

P Park

Select only when the vehicle is stationary. The rear wheels are locked.

R Reverse

Select only when the vehicle is stationary.

N Neutral

You can select this in a car wash, for example. The vehicle can roll.

D Drive, automatic position

Position for normal vehicle operation. All forward gears are selected automatically.

Kick-down

Kick-down enables you to achieve maximum performance.

Press the accelerator pedal beyond the full-throttle resistance point.

Manual operation and Sport program M/S



Move selector lever from position D toward the left into the M/S shifting slot:

The sport program is activated and DS appears in the instrument cluster. This position is recommended for a performance-oriented driving style.

When you briefly press the selector lever in the + or – direction, the manual mode is activated and Steptronic changes gear. The instrument cluster shows M1 through M6.

Upshifts and downshifts are executed only when they will result in a plausible combination of engine and vehicle speed; thus, for example, a downshift that would cause the engine to overrev will not be executed by the system. The gear selected appears briefly in the instrument cluster, followed by the gear actually in use.

To use the automatic function again, move the selector lever to the right into position D.

Overriding selector lever lock

You can manually override the selector lever lock in case a defect occurs in which the selector lever remains in position P although the button on the selector lever is pressed:

1. Unclip the sleeve of the selector lever.
2. Pull the sleeve up over the selector lever until the sleeve is inside out.



3. Using the screwdriver from the onboard tool kit, refer to page 187, hold down the red lever and move the selector lever to the desired position in the usual way.

Turn signals/ headlamp flasher

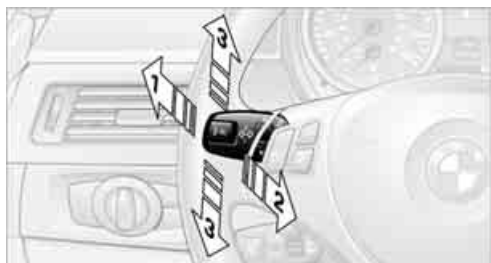

- 1 High beams
- 2 Headlamp flasher
- 3 Turn signals

Using turn signals

Press the lever beyond the resistance point.

To turn off manually, press the lever to the resistance point.

 Unusually rapid flashing of the indicator lamp indicates that a turn signal bulb needs to be replaced.

After switching off the ignition, make sure that the roadside parking lamps are not switched on. ◀

Signaling for a short time

Press and hold the lever as far as the resistance point for as long as you wish to indicate a turn.

Triple turn signal activation

Press the lever as far as the resistance point. The turn signals flash three times.

You can activate or deactivate this function. iDrive concept, refer to page 16.

1. Open the start menu.
2. Press the controller to open the **i** menu.
3. Select "Vehicle settings" and press the controller.
4. Select "Lighting" and press the controller.



5. Select "Triple turn signal activation" and press the controller.

Triple turn signaling is activated.

Wiper system

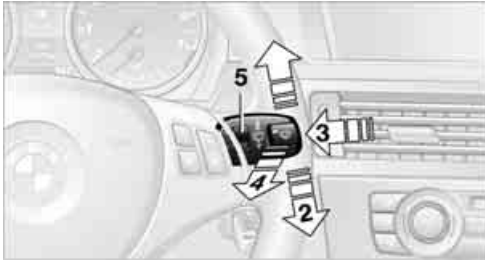

- 1 Switching on wipers
- 2 Switching off wipers or brief wipe
- 3 Activating/deactivating intermittent wipe or rain sensor*
- 4 Cleaning windshield and headlamps*
- 5 Setting speed for intermittent wipe, or sensitivity of the rain sensor

Switching on wipers

The lever automatically returns to its initial position when released.

Normal wiper speed

Press once.

The system switches to operation in the intermittent mode when the vehicle is stationary.

Fast wiper speed

Press twice or press beyond the resistance point.

The system switches to normal speed when the vehicle is stationary.

Intermittent wipe or rain sensor*

If the car is not equipped with a rain sensor, the intermittent-wipe time is a preset.

If the car is equipped with a rain sensor, the time between wipes is controlled automatically and depends on the intensity of the rainfall. The sensor is mounted on the windshield, directly in front of the interior rearview mirror.

Activating intermittent wipe or rain sensor

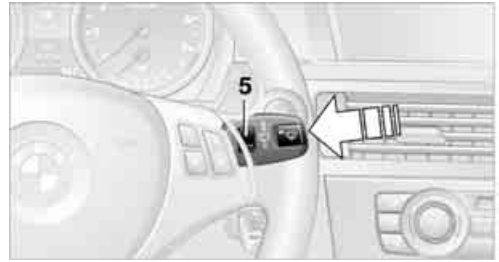

Press button **3**. The LED in the button lights up.

Setting speed for intermittent wipe or sensitivity of the rain sensor

Slide switch **5** up or down.

Deactivating intermittent wipe or rain sensor

Press button **3** again. The LED goes out.

 Deactivate the rain sensor before entering an automatic car wash. Failure to do so could result in damage caused by undesired wiper activation. ◀

Cleaning windshield and headlamps*

Pull lever **4**.

Washer fluid is sprayed onto the windshield and the wipers are operated for a short time.

When the vehicle lighting system is switched on, the headlamps are cleaned at regular and appropriate intervals.

 Do not use the washers if there is any danger that the fluid will freeze on the windshield. If you do, your vision could be obscured. Antifreeze should therefore be added to the fluid, refer to Washer fluid. Do not use the washers when the washer fluid reservoir is empty, otherwise you will damage the washer pump. ◀

Windshield washer nozzles

The windshield washer nozzles are heated automatically while the engine is running or the ignition switched on.

Washer fluid

! Washer fluid antifreeze is flammable. Always keep it well away from sparks and open flames, and store it in tightly closed containers well out of the reach of children. Comply with the instructions on the container. ◀

Washer fluid reservoir

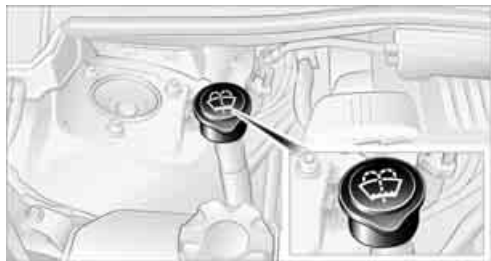

Fill with water and, if required, with a washer antifreeze, according to manufacturer's recommendations.

▷ Mix the water and antifreeze before filling the washer fluid reservoir to make sure the correct concentration is maintained. ◀

Capacity

Approx. 6.3 US quarts/6 liters.

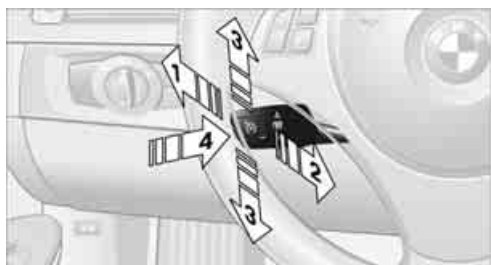

Cruise control*

The concept

Cruise control is available for use at speeds of approx. 20 mph or 30 km/h. The car then memorizes and maintains the speed that you specify using the lever on the steering column. In order to maintain the specified speed, the system

brakes the vehicle when the engine braking effect is insufficient on downhill gradients.

! Do not use cruise control when driving conditions are unfavorable for driving at a constant speed. Otherwise you could lose control of the vehicle and cause an accident as a result. Unfavorable driving conditions include, for example, winding roads, heavy traffic or a poor road surface, e.g. snow, rain, ice or loose material. ◀

Manual transmission

You can shift gears while cruise control is activated. An indicator lamp notifies you that you should shift gears when you drive for an extended period at very high or very low engine speeds, or the system is deactivated.

One lever for all functions

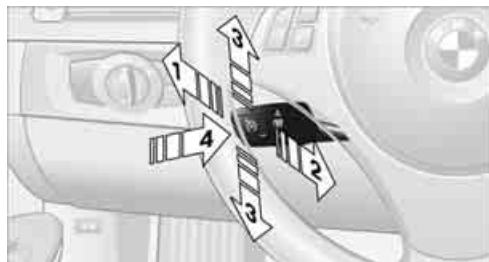

- 1 Storing and maintaining speed or accelerating
- 2 Storing and maintaining speed or decelerating
- 3 Deactivating cruise control
- 4 Resuming a speed stored beforehand

Maintaining current speed

Tap the lever, arrow 1, or pull it briefly, arrow 2. The car's current speed is stored and maintained. It is displayed in the speedometer and briefly in the instrument cluster.

On uphill gradients, it may prove impossible to maintain the set speed if current engine power output is insufficient. If the engine braking effect is insufficient on downhill slopes, the system will brake the vehicle slightly.

Increasing desired speed

Tap the lever repeatedly to the resistance point or beyond, arrow **1**, until the desired speed is reached.

- ▷ Each time the lever is tapped to the resistance point, the desired speed is increased by approx. 1 mph or 1 km/h.
- ▷ Each time the lever is tapped beyond the resistance point, the desired speed is increased to the next multiple of 5 mph or 10 km/h until a maximum of 110 mph or 180 km/h is reached.

The system stores and maintains the speed.

Accelerating using the lever

Accelerating slightly:

Press the lever to the resistance point, arrow **1**, until the desired speed is reached.

Accelerating significantly:

Press the lever beyond the resistance point, arrow **1**, until the desired speed is reached.

The vehicle accelerates without pressure on the accelerator pedal. The system stores and maintains the speed.

Decreasing desired speed

Pull the lever repeatedly to the resistance point or beyond, arrow **2**, until the desired speed is reached.

- ▷ Each time the lever is pulled to the resistance point, the desired speed is decreased by approx. 1 mph or 1 km/h.
- ▷ Each time the lever is pulled back beyond the resistance point, the desired speed is decreased to the next multiple of 5 mph or 10 km/h until the minimum speed of 20 mph/30 km/h is reached.

The system stores and maintains the speed.

 If the speed is to be reduced significantly, press the brake pedal; otherwise, deceleration may be insufficient and dangerous situations could result. ◀

Deactivating cruise control

Tap the lever upwards or downwards, arrow **3**. The displays in the speedometer disappear.

In addition, the system is automatically deactivated:

- ▷ When you brake the vehicle
- ▷ When you switch gears very slowly or engage neutral gear in cars with manual transmission
- ▷ When you select the automatic transmission's neutral position N
- ▷ When you activate the Dynamic Traction Control DTC
- ▷ When you deactivate the Dynamic Stability Control DSC
- ▷ When DSC or ABS is intervening

Cruise control is not deactivated by depressing the accelerator pedal. Once the accelerator pedal is released, the stored speed is achieved again and maintained.

Warning lamp



The warning lamp comes on when cruise control has been automatically deactivated by pressing the brake pedal, engaging the handbrake or as a result of DSC intervening. A message appears on the Control Display.

Resuming a speed stored beforehand

Press button **4** briefly: the stored speed is resumed and maintained.

In the following instances, the stored speed is deleted and can no longer be resumed:

- ▷ When driving control systems are intervening
- ▷ In cars with manual transmission: when you shift gears very slowly or engage neutral gear
- ▷ In cars with automatic transmission: when you engage selector lever position N
- ▷ When the ignition is switched off

Displays in the instrument cluster



- 1 Stored speed
- 2 Selected speed is displayed briefly

 If --- mph or --- km/h temporarily appears in the instrument cluster display, it is possible that the system prerequisites for operation are currently not met.

Calling up Check Control messages, refer to page 74. ◀

Malfunction



The warning lamp comes on when the system has failed. A message appears on the Control Display. You can find more information starting on page 73.

Active cruise control*

The concept

With active cruise control, you can select a desired speed which is not only automatically maintained when driving on open roadways, but also varied to maintain a selected distance setting as slower traffic is encountered.

Active cruise control is a technological advance over the familiar cruise control and is a welcome relief from the constant adjustment of speed that can accompany driving in traffic on freeways or other high-speed thoroughfares. Especially on longer trips, the system can reduce fatigue and tension, while increasing your enjoyment of driving. Please use it safely and responsibly.

Within the limits of its capability, the system automatically adapts the car's speed to that of a slower vehicle in front of you. You can specify

the distance to be maintained from the vehicle in front in four stages. For safety reasons, the distance is speed-dependent. Based on your selected distance setting, the system automatically decreases the throttle setting and lightly applies the brakes if necessary. The vehicle brake lamps will automatically illuminate to signal a following driver to take action. In addition, it may be necessary for the vehicle or the driver to downshift, depending on the kind of transmission your vehicle is equipped with, to maintain the distance setting selected. If the vehicle ahead speeds up or when the lane ahead becomes clear, your vehicle will accelerate to the speed you have selected by increasing the throttle setting and shifting gears automatically or by the driver as needed. Your selected speed will be held when driving downhill, too.

Since this active cruise control system is a new technology and operates differently from conventional cruise control systems which you may be accustomed to, you are strongly urged to read all of the pages relating to this system before use. Pay special attention to the System limitations section beginning on page 61. ◀

Braking sensation

The system's automatic brake operation results in a braking sensation that is slightly different from what you feel when you brake the vehicle yourself in a similar situation. Possible noises during automatic deceleration are normal.

Manual transmission

You can shift gears while cruise control is activated. An indicator lamp notifies you that you should shift gears when you drive for an extended period at very high or very low engine speeds, or the system is deactivated.

Range of applications

The minimum desired speed is 20 mph or 30 km/h, and the maximum speed is 110 mph or 180 km/h.



As with conventional cruise control systems, active cruise control in no way diminishes or substitutes for the driver's own

personal responsibility, alertness and awareness in adjusting speed, braking or otherwise controlling the vehicle. The driver should decide when to use the system on the basis of road, traffic, visibility, and weather conditions. Active cruise control is intended for use on highway-type roadways where traffic is moving relatively smoothly. Do not use this system in city driving; heavy traffic such as during rush hour; on curvy, winding roads, slippery roads or roads with sharp curves such as highway off-ramps; during inclement weather such as snow, strong rain or fog; or when entering interchanges, service/parking areas or toll booths. It is also important to regulate your vehicle's speed and distance setting within applicable legal limits. Always be ready to take action or apply the brakes if necessary, especially when the system is actively following a vehicle in front of you. Otherwise, driving conditions could result which violate the law or pose a risk of accident. ◀

One lever for all functions

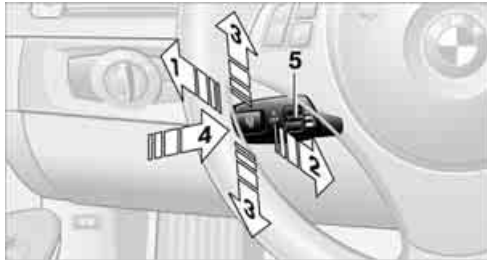

- 1 Store and increase desired speed
- 2 Store and decrease desired speed
- 3 Deactivate system, refer to page 56
- 4 Resume stored desired speed and distance, refer to page 56
- 5 Select distance to vehicle driving ahead, refer to page 59

Maintaining current speed



Briefly press the lever, arrow 1, or pull it, arrow 2, at a driving speed of more than approx. 20 mph or 30 km/h.

The speed at which you are currently driving will be stored and maintained. It is displayed in the speedometer and briefly in the instrument cluster.

On uphill gradients, it may prove impossible to maintain the set speed if current engine power output is insufficient. If the engine braking effect is insufficient on downhill slopes, the system will brake the vehicle slightly.

Adjusting desired speed

 Adjust your desired speed to the traffic conditions and remain ready to brake at all times, as there is otherwise a risk of accident. Great differences in speed to the vehicle ahead, e.g. when quickly approaching a truck or when another vehicle swerves into your lane, cannot be compensated for by the system. ◀

Increasing in increments

Tap the lever repeatedly to the resistance point or beyond, arrow 1, until the desired speed is reached.

- ▷ Each time the lever is tapped to the resistance point, the desired speed is increased by approx. 1 mph or 1 km/h.
- ▷ Each time the lever is tapped beyond the resistance point, the desired speed is increased to the next multiple of 5 mph or 10 km/h until a maximum of 110 mph or 180 km/h is reached.

The speed then displayed is stored and achieved, provided that the road is clear.

Increasing continuously

Press the lever repeatedly to the resistance point or beyond, arrow **1**, until the desired speed is reached.

The speed then displayed is stored and reached as soon as the road ahead of you is clear.

Decreasing in increments

Pull the lever repeatedly to the resistance point or beyond, arrow **2**, until the desired speed is reached.

- ▷ Each time the lever is pulled to the resistance point, the desired speed is decreased by approx. 1 mph or 1 km/h.
- ▷ Each time the lever is pulled back beyond the resistance point, the desired speed is rounded off to the next multiple of 5 mph or 10 km/h until the minimum speed of 20 mph/30 km/h is reached.

The speed then displayed is stored and achieved, provided that the road is clear.

Selecting distance

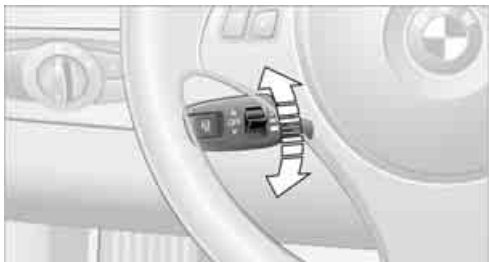

- ▷ Press downward:
Increase distance
- ▷ Press upward:
Decrease distance.

The selected distance is displayed in the instrument cluster.



Distance 1



Distance 2



Distance 3

This distance is always set when the system is used for the first time after starting the engine.



Distance 4



Use good judgement to select the appropriate following distance given road conditions, traffic, applicable laws and driving recommendations for safe following distance. Otherwise, you may be in violation of the law or an accident could result. ◀

Deactivating cruise control

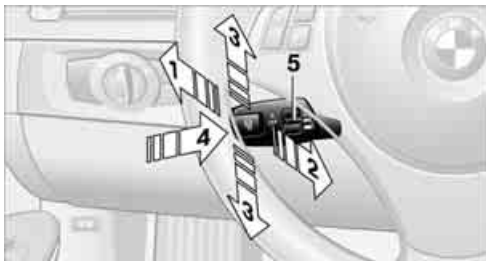

Press the lever upward or downward, arrow **3**. The displays in the speedometer disappear.

In addition, the system is automatically deactivated:

- ▷ When you brake the vehicle
- ▷ When the speed is reduced to below 20 mph or 30 km/h due to a traffic situation
- ▷ When you switch gears very slowly or engage neutral gear in cars with manual transmission
- ▷ When you select the automatic transmission's neutral position N
- ▷ When you activate the Dynamic Traction Control DTC

- ▷ When you deactivate the Dynamic Stability Control DSC
- ▷ When DSC or ABS is intervening
- ▷ When the system does not recognize any objects for a longer period of time, e.g. on infrequently traveled roads without a shoulder or guard rails, or if the radar sensor is covered with dirt, refer to page 61
- ▷ When you actuate the handbrake while driving

 When the system is deactivated, you must brake the vehicle yourself and/or maneuver as necessary, otherwise there is a risk of accident. ◀

Warning lamp

 The warning lamp comes on when active cruise control has been automatically deactivated due to one of the following factors: you are driving under a speed of 20 mph or 30 km/h, the handbrake is applied, or DSC is intervening. A message appears on the Control Display.

Resuming stored desired speed and distance

Press button 4.

The stored speed and distance are regained and maintained.

In the following instances, the stored speed is deleted and can no longer be resumed:

- ▷ When driving control systems are intervening
- ▷ In cars with manual transmission: when you shift gears very slowly or engage neutral gear
- ▷ In cars with automatic transmission: when you engage selector lever position N
- ▷ When the ignition is switched off

Displays in the instrument cluster



- 1 Stored desired speed
- 2 Shows yellow: vehicle detected ahead
Flashes in red: system cannot maintain distance; driver must brake the vehicle
Flashes in yellow: driving control systems are intervening; cruise control is deactivated
- 3 Selected distance to vehicle ahead
The indicator lights up as soon as the system is activated.
- 4 Selected desired speed is temporarily displayed

 If --- mph or --- km/h temporarily appears in the instrument cluster display, it is possible that the system prerequisites for operation are currently not met. Calling up Check Control messages, refer to page 74. ◀

Warning lamps



The indicator 2 flashes in red; a signal sounds.

The system indicates that you must brake and/or maneuver the vehicle yourself. Active cruise control cannot automatically restore the distance to the vehicle ahead.

This indicator does not release you, however, from your responsibility to adapt your desired speed and driving style to prevailing driving conditions.

This indicator does not release you, however, from your responsibility to adapt your desired speed and driving style to prevailing driving conditions.



The indicator 2 flashes in yellow. The prerequisites for operating active cruise control are not met, e.g. as a result of ABS or DSC

interventions. Active cruise control is deactivated. You can reactivate the system, if desired, by tapping or pulling the lever when road and traffic conditions permit this. It is not possible to resume a stored speed.

RadAR sensor

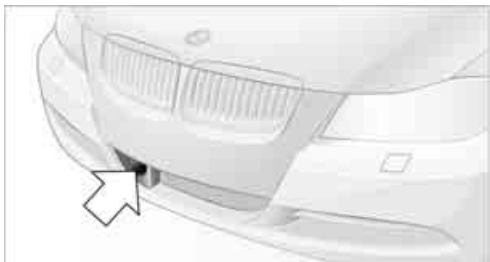

The sensor's ability to detect vehicles ahead may be restricted as a result of heavy rain, dirt,

snow or ice. If necessary, clean the radar sensor located in the front bumper, see arrow. Be sure to use particular care when removing any layers of snow or ice from the sensor.

When the radar sensor is not properly positioned, active cruise control cannot be activated at all.

Malfunction



The warning lamp comes on when the system has failed. A message appears on the Control Display. You can find more information starting on page 73.

System limitations

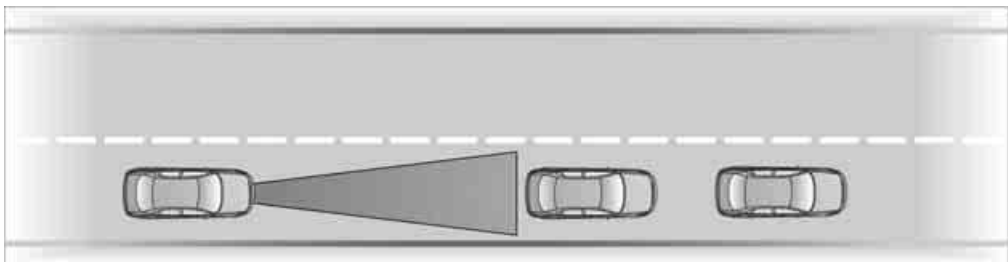

⚠ Always remember that the range and ability of the system does have physical limitations. It will not apply the brakes or decelerate your vehicle when there is a slow-moving vehicle, stopped vehicle or stationary object ahead of you, as for example, at a traffic light or a parked vehicle. Also, the system does not react to oncoming traffic, pedestrians or other types of potential traffic such as a rider on horseback. It is also possible that the system may not detect smaller moving objects such as motorcycles or bicycles. Be especially alert when encountering any of these situations as the system will neither automatically brake, nor provide a warning to you. Also, be aware that every decrease in the distance setting allows your vehicle to come closer to a vehicle in front of

you and requires a heightened amount of alertness. ◀

⚠ Active cruise control is not and must not be used as a collision avoidance/warning system. ◀

If while your vehicle is actively following a vehicle in front of you and the vehicle ahead speeds up or the lane ahead becomes clear, then your vehicle will accelerate to the speed you have selected. Be aware that changing to a clear, unobstructed lane will also result in your vehicle accelerating.

⚠ Be certain to deactivate the system when you pull into an exit lane for a highway off-ramp. ◀

Also, vehicles traveling in a staggered manner on a highway may cause a delay in the system's

reaction to a vehicle in front of you or may cause the system to react to a vehicle actually in the lane next to you. Always be ready to take action or apply the brakes if necessary.

⚠ While active cruise control is capable of braking your vehicle automatically when you approach a slower vehicle ahead, it is important to be aware that the ability of the system to apply the brakes is also limited, e.g. when you reduce your desired speed sharply. The system cannot stop your vehicle. It uses only a portion of braking system capacity and does not utilize the full capacity of the vehicle braking system. Therefore, the system cannot decrease your speed for large differences in speed between your vehicle and the vehicle ahead. Examples: when you approach a vehicle traveling at a much lower speed than your own speed such as approaching a toll booth or when a much slower vehicle cuts in front of you at close range. ◀

Active cruise control can only decelerate the vehicle to approx. 20 mph or 30 km/h.

Swerving vehicles

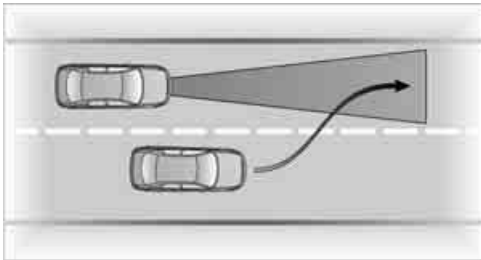

When a vehicle moves from an adjacent lane into your lane, active cruise control will not recognize this vehicle until it is fully in your lane ahead of your vehicle.

⚠ When a vehicle ahead suddenly swerves into your lane, the system may not be able to maintain the selected distance automatically. This also applies to great differences in speed between you and vehicles ahead, e.g. when quickly approaching a truck. There is a risk of collision. Once the system has established that a vehicle is indeed in front of you, it will indicate that you must brake and/or maneuver the vehi-

cle yourself. Take action yourself, as there is otherwise a risk of accident. ◀

Behavior in curves

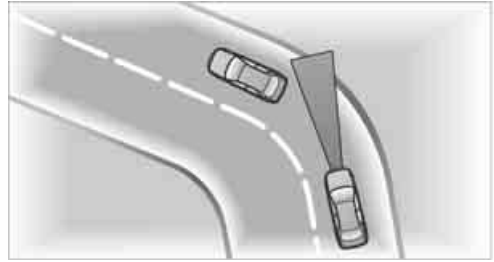

Because of the limited range of the system, it is possible that in curves or on the peaks and valleys of hilly roads, a vehicle ahead may be recognized late, or not at all. Therefore, it is up to the driver to select a speed that is prudent in view of the curves and terrain of the roadway.



In approaching a curve, it is possible that active cruise control would react briefly to a vehicle in the adjacent lane. In addition, the system can sense if your vehicle is in a curve and may not accelerate. If your vehicle decelerates in either case, you can choose to overcome the deceleration by briefly pressing the accelerator pedal.

Your responsibility

Your actions have priority at all times. When you press the accelerator pedal while driving with active cruise control, the automatic braking function will be temporarily interrupted. Once you release the accelerator pedal, the desired speed or the selected distance to the vehicle ahead is achieved again.

⚠ Do not leave your foot on the accelerator pedal and make sure that no objects such

as floor mats are lying on the accelerator pedal. Otherwise the system may not be able to brake the vehicle. ◀

Everything under control

Odometer, outside temperature display, clock



- 1 Resetting trip odometer
- 2 Outside temperature display and clock
- 3 Odometer and trip odometer

Units of measure

To select the respective units of measure, miles or km for the odometer as well as °F or °C for the outside temperature, refer to page 68.

Outside temperature display, clock

Setting the time, refer to page 71.

Ice warning

A signal sounds when the outside temperature falls to approx. +37.5 °F /+3 °C; this will be accompanied by a message. Risk of icy roads.

 Please bear in mind that black ice may be present on roads at temperatures higher than +37.5 °F /+3 °C, e.g. on bridges and shaded roads. ◀

Odometer and trip odometer

Resetting trip odometer:
With the ignition switched on, press button 1 in the instrument cluster.

When the vehicle is parked

If you still want to view the time, outside temperature and odometer reading briefly after the remote control has been removed from the igni-

tion lock:
Press button 1 in the instrument cluster.

Tachometer



Never force the engine speed up into the red warning field, see arrow. In this range, the fuel supply is interrupted to protect the engine.

Energy Control



Displays the current fuel consumption. This allows you to see whether your current driving

style is conducive to fuel economy with minimum exhaust emissions.

Fuel gauge



Fuel tank capacity: approx. 15.9 gallons/ 60 liters. You can find information on refueling on page 168.

If the tilt of the vehicle varies for a longer period, when you are driving in mountainous areas, for example, the indicator may fluctuate slightly.

Reserve

Once the fuel level has fallen to the reserve zone, a message will appear on the Control Display for a short time and the cruising range for the remaining amount of fuel is displayed on the computer. Under a cruising range of approx. 30 miles/50 km, the message remains in the Control Display.

 Refuel as soon as possible once your cruising range falls below 30 miles/ 50 km, as otherwise engine functions are not ensured and damage can occur. ◀

Computer

Displays in the instrument cluster



To call up the information, press the button in the turn indicator stalk.

The following items of information are displayed in the order listed:

- ▷ Cruising range
- ▷ Average speed
- ▷ Average fuel consumption

To set the corresponding units of measure, refer to Changing units of measure on page 68.

Cruising range

Displays the estimated cruising range available with the remaining fuel. The range is calculated on the basis of the way the car has been driven over the last 18 miles/30 km and the amount of fuel currently in the tank.

 Be sure to refuel as soon as possible once your cruising range falls below 30 miles/ 50 km, as otherwise engine functions are not ensured and damage can occur. ◀

Average speed

Periods with the vehicle parked and the engine switched off are not included in the calculations of average speed.

With the trip computer, refer to page 66, you can have the average speed for another trip displayed.

To reset average speed: press the button in the turn indicator stalk for approx. 2 seconds.

Average fuel consumption

The average fuel consumption is calculated for the time during which the engine is running.

With the trip computer, refer to page 66, you can have the average consumption for another trip displayed.

To reset average fuel consumption: press the button in the turn indicator stalk for approx. 2 seconds.

Displays on the Control Display

You can also call up the computer via iDrive; concept, refer to page 16.

1. Press the **MENU** button.
This opens the start menu.
2. Move the controller to the right to call up "Navigation".
3. Select "Car Data" and press the controller.
4. Select "Onboard info" and press the controller.



- ▷ Estimated time of arrival at destination:
 - ▷ Manually enter a distance in the computer, refer to information further below
 - ▷ Enter a destination in the navigation system, refer to page 115
- ▷ Cruising range
- ▷ Distance to destination:
 - ▷ Manually enter a distance in the computer, refer to information further below
 - ▷ Enter a destination in the navigation system, refer to page 115
- ▷ Average speed
- ▷ Average fuel consumption

Resetting values

You can reset the values for average speed and average consumption:

1. Select the respective menu item and press the controller.
2. Press the controller again to confirm your selection.

Entering a distance manually

1. Select "Distance to dest." and press the controller.

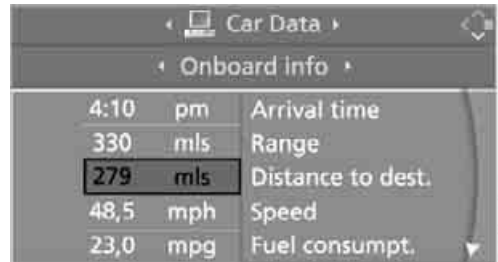

2. Turn the controller to select the distance to your destination.
3. Press the controller to apply the setting.

The distance is automatically entered during destination guidance.

Trip computer

The trip computer is suitable e.g. for a holiday trip.

1. Open the start menu.
2. Call up "Navigation".
3. Select "Car Data" and press the controller.
4. Select "Trip computer" and press the controller.



- ▷ Departure time

- ▷ Driving time
- ▷ Distance traveled
- ▷ Average speed
- ▷ Average fuel consumption

Switching trip computer on/off and resetting all values to zero:

1. Select "Set" and press the controller.
2. Select the desired menu item and press the controller.

Display options

You can display the computer or the trip computer in the assistance window.

1. Move the controller to the right to change to the assistance window and press the controller.

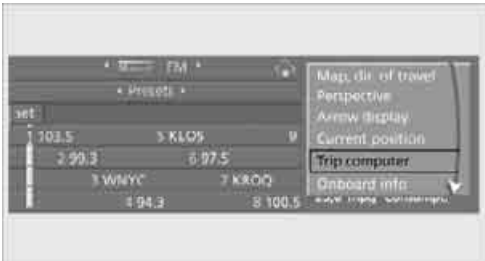

2. Select a menu item:
 - ▷ "Onboard info"
 - ▷ "Trip computer"
3. Press the controller.



Settings and information

Operating principle

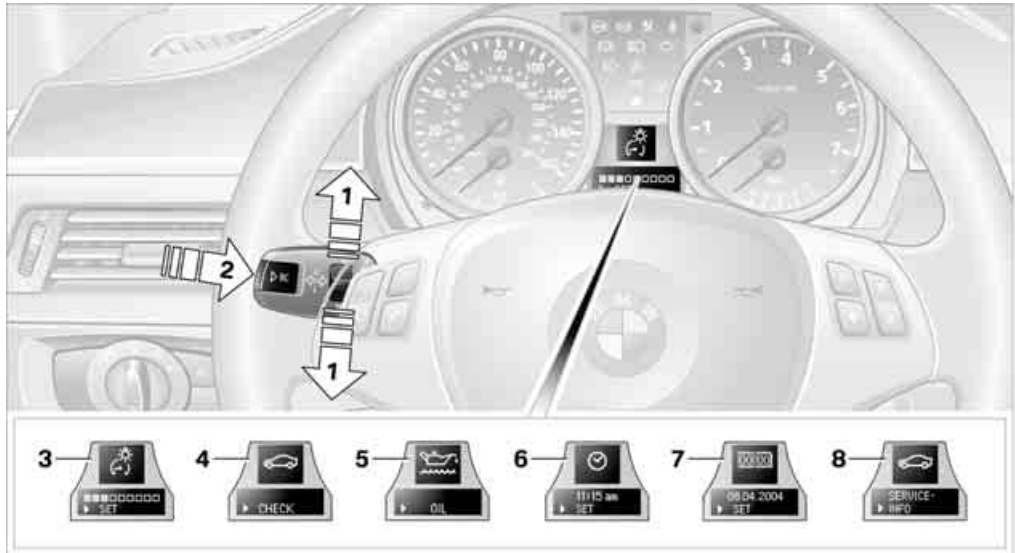

- 1 Button for:
 - ▷ Selecting display
 - ▷ Setting values
- 2 Button for:
 - ▷ Confirming selected display or set values
 - ▷ Calling up computer information [65](#)
- 3 When the lights are switched on: instrument lighting brightness [87](#)
- 4 Calling up Check Control [73](#)
- 5 Checking oil level [181](#)
- 6 Setting the time [71](#)
- 7 Date setting [72](#)
- 8 Viewing service requirement display [69](#)

Exiting displays

The outside-temperature reading and the time reappear when you press button **2** or if you make no entries within approx. 15 seconds. If required, complete the current setting first.

Units of measure

You can set units of measure. The settings are stored for the remote control currently in use, refer also to Personal Profile on page [29](#).

- ▷ Fuel consumption: mpg US, mpg UK, l/100 km, km/l
- ▷ Distance covered: mls, km
- ▷ Units of pressure*: psi, kPa, bar

- ▷ Temperature: °F, °C

Changing units of measure

iDrive concept, refer to page [16](#).

1. Open the start menu.
2. Press the controller to open the **i** menu.
3. Select "Display settings" and press the controller.
4. Select "Units" and press the controller.

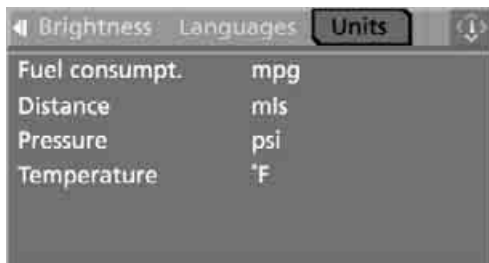

5. Select the desired menu item and press the controller.
6. Select the desired measurement unit and press the controller.

Service requirements



The remaining driving distance and the date of the next scheduled service are displayed briefly immediately after you start the engine or switch on the ignition.

 The extent of service work required can be read out from the remote control by your BMW Service Advisor. ◀

For certain maintenance operations, you can view the respective distance remaining or due date individually in the instrument cluster.

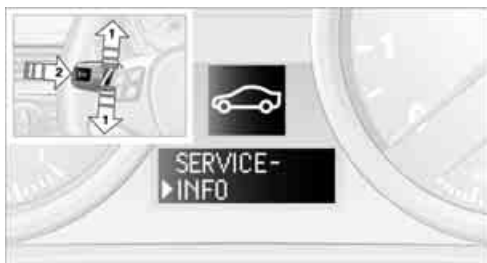

1. Lightly push button **1** in the turn indicator stalk repeatedly up or down until the appropriate symbol appears in the display, accompanied by the words "SERVICE-INFO".
2. Press button **2**.
3. Use button **1** to scroll through the individual service items.

Possible displays

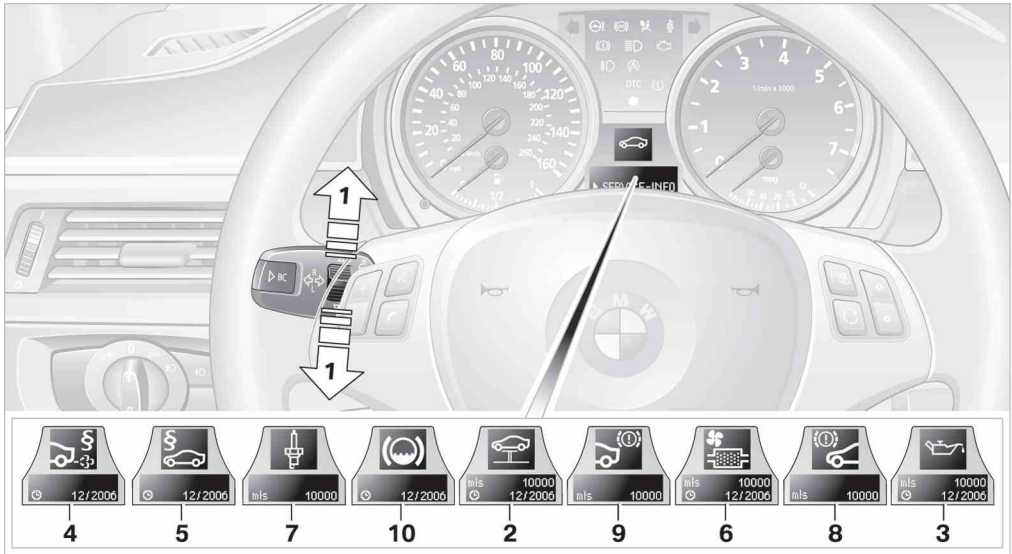

- | | |
|----------------------------------|-----------------|
| 1 Button for selecting functions | 6 Microfilter |
| 2 Viewing service requirements | 7 Spark plugs |
| 3 Checking engine oil level* | 8 Brakes, front |
| 4 Exhaust emissions test* | 9 Brakes, rear |
| 5 Roadworthiness test* | 10 Brake fluid |

Additional information

You can have further information on the scope of maintenance displayed on the Control Display, refer to page 16.

1. Open the start menu.
2. Press the controller to open the **i** menu.
3. Select "Service" and press the controller.
4. Select "Service requirements" and press the controller.

5. Select "Status" and press the controller.

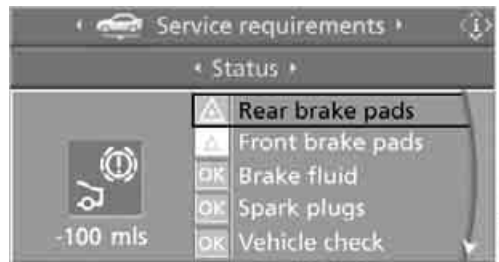

A list of selected maintenance operations and, if applicable, inspections required by law is displayed.

You can request more detailed information on every entry.

Select the entry and press the controller.

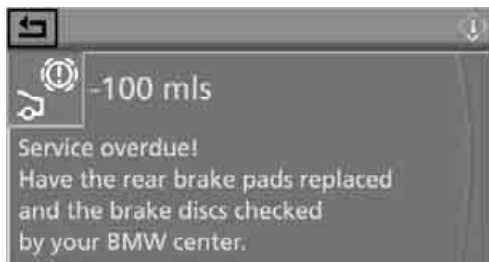

To exit from the menu:

Select the arrow and press the controller.

Symbols

- No service is currently required.
- The deadline for service or a legally mandated inspection is approaching. Please arrange an appointment with your BMW center.
- The service deadline has already passed.

Entering dates of statutory emissions tests and vehicle inspections*

Make sure the date on the Control Display is always set correctly, refer to page 72, as otherwise the effectiveness of CBS Condition Based Service is not ensured.

1. Open the start menu.
2. Press the controller to open the menu.
3. Select "Service" and press the controller.
4. Select "Service requirements" and press the controller.
5. Select "Status" and press the controller.
6. Select "Emission inspect." or "State inspection" and press the controller.

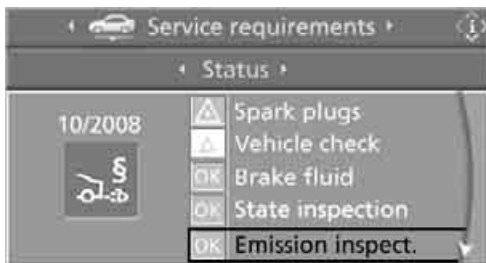

7. Select "Set service date" and press the controller. The month is highlighted.
8. Turn the controller to make the adjustment.



9. Press the controller to apply the setting. The year is highlighted.
10. Turn the controller to make the adjustment.
11. Press the controller to apply the setting. The date entry is stored.

To exit from the menu:

Select and press the controller.

More information on the BMW Maintenance System can be found on page 185.

Clock

Setting the time

In the instrument cluster

To set the 12h/24h mode, refer to Setting the time format below.



1. Lightly push button **1** in the turn indicator stalk repeatedly up or down until the appropriate symbol appears in the display, accompanied by the time and the word "SET".
2. Press button **2**.
3. Use button **1** to set the hours.
4. Press button **2**.
5. Use button **1** to set the minutes.
6. Press button **2**.
The system accepts the new time.

Via iDrive

iDrive concept, refer to page 16.

1. Open the start menu.
2. Press the controller to open the **i** menu.
3. Select "Display settings" and press the controller.
4. Select "Time" and press the controller.

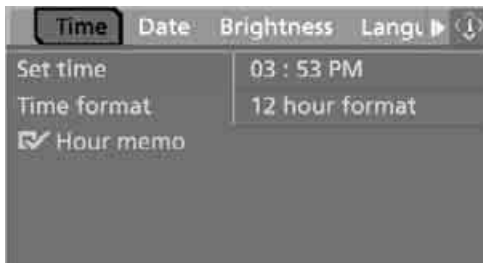

5. Select "Set time" and press the controller. The hours are highlighted.
6. Turn the controller to set the hours.
7. Press the controller to select the minutes.
8. Turn the controller to adjust the minutes.

9. Press the controller.
The system accepts the new time.

Switching on the hour signal*

You will hear three tones just before each full hour.

- Select "Hour memo" and press the controller.
 The hour signal is activated.

Setting the time format

1. Open the start menu.
2. Press the controller to open the **i** menu.
3. Select "Display settings" and press the controller.
4. Select "Time" and press the controller.
5. Select "Time format" and press the controller.
6. Select the desired format and press the controller.

Date

Date setting

In the instrument cluster

To set the dd/mm or mm/dd date format, refer to Setting the date format below.



1. Lightly push button **1** in the turn indicator stalk repeatedly up or down until the appropriate symbol appears in the display, accompanied by the date and the word "SET".
2. Press button **2**.
3. Use button **1** to set the day of the month.

4. Press button **2**.
5. Set the month and the year in the same way.
6. Press button **2**.
The system accepts the new date.

Via iDrive

iDrive concept, refer to page 16.

1. Open the start menu.
2. Press the controller to open the **i** menu.
3. Select "Display settings" and press the controller.
4. Select "Date" and press the controller.

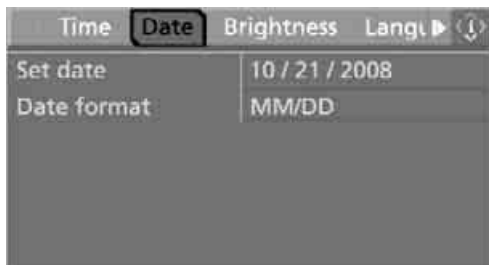

5. Select "Set date" and press the controller. The first section of the date display is highlighted, in this case the month.
6. Turn the controller to make the adjustment.
7. Press the controller to apply the setting. The next setting is highlighted.
8. Make the remaining adjustments. After the last adjustment, the date is stored.

Setting the date format

1. Open the start menu.
2. Press the controller to open the **i** menu.
3. Select "Display settings" and press the controller.
4. Select "Date" and press the controller.
5. Select "Date format" and press the controller.
6. Select the desired format and press the controller.

Check Control

The concept

The Check Control monitors vehicle functions and alerts you to any malfunctions in the systems monitored. Such a Check Control message includes indicator and warning lamps in the instrument cluster and, in some circumstances, an acoustic signal as well as text messages at the bottom of the Control Display.

Indicator and warning lamps

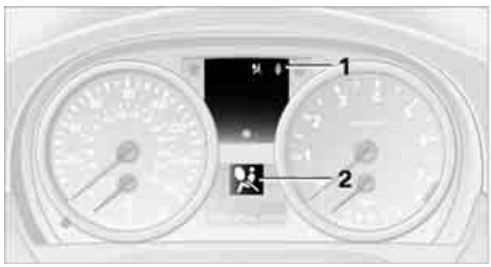

Indicator and warning lamps can light up in both the indicator area **1** and the display **2** in various combinations and colors.

Explanatory text messages



Text messages at the lower edge of the Control Display explain the meaning of the displayed indicator and warning lamps.

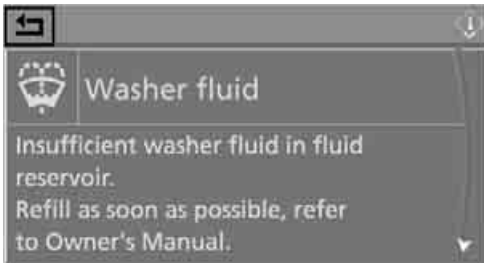

For most Check Control messages, you can view more information later, e.g. regarding the cause of a malfunction and how to respond, refer to page 75.

In urgent cases, this information will be shown immediately as soon as the corresponding lamp comes on.

To exit the displayed information: Select the arrow and press the controller.

Hiding Check Control messages

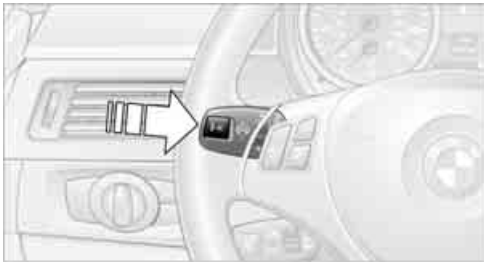

Press the button in the turn indicator stalk.

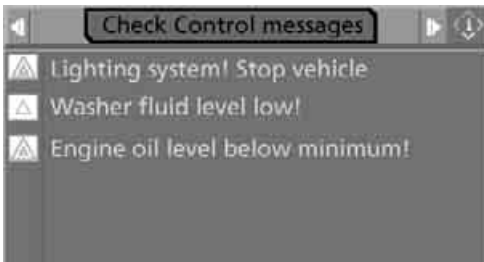

Some Check Control messages remain visible until the malfunction in question has been rectified. They cannot be hidden. If several malfunctions occur at the same time, the Check Control messages are displayed in succession.

Depending on your vehicle's equipment version, they will be displayed together with the symbol shown here.

Other Check Control messages are automatically hidden after approx. 20 seconds, but remain stored.

Depending on your vehicle's equipment version, they will be displayed together with the symbol shown here.



indicates that Check Control messages have been stored. You can view the Check Control messages whenever it is convenient for you.

Viewing stored Check Control messages



1. Lightly push button 1 in the turn indicator stalk repeatedly up or down until the appropriate symbol appears in the display, accompanied by the words "CHECK CONTROL".
2. Press button 2. "CHECK OK" appears if there are no Check Control messages. If a Check Control message has been stored, the corresponding lamp comes on. It is accompanied by a text message on the Control Display.

- Lightly push button **1** to check for other messages.
- Press button **2**.
The display again shows the outside temperature and the time.

Viewing more information later

iDrive concept, refer to page 16.

- Press the **MENU** button.
This opens the start menu.
- Press the controller to open the **i** menu.
- Select "Service" and press the controller.
- Select "Check Control messages" and press the controller.

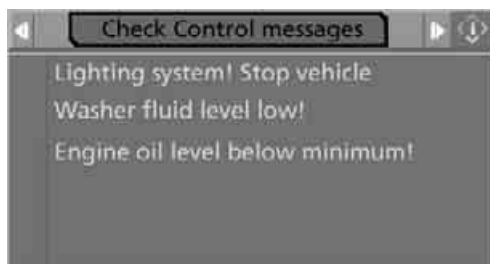

- Select a text message and press the controller.

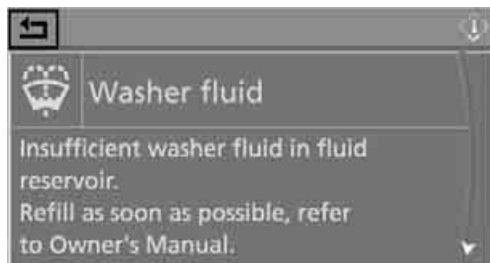

To exit the display:

Select the  arrow and press the controller.

Speed limit

You can enter a speed, and a Check Control message will indicate when you reach this speed. This enables you, for example, to receive warnings if you exceed a speed limit in an urban area.

You are only warned of reaching this speed a second time if your vehicle speed falls below it again by at least 3 mph or 5 km/h.

Displaying, setting or changing the limit

iDrive concept, refer to page 16.

- Open the start menu.
- Call up "Navigation".
- Select "Car Data" and press the controller.
- Select "Limit" and press the controller.



- Depending on your vehicle's equipment version, select "Change limit:" or the speed value and press the controller.
- Turn the controller to set the limit.
- Press the controller to apply the setting.
The limit is automatically switched on.

Applying your current speed as limit

Select "Select current speed" and press the controller. The system adopts your current speed as the limit.

Activating the limit

Select "On" and press the controller.

Limit is activated.

Stopwatch

iDrive concept, refer to page 16.

- Open the start menu.
- Call up "Navigation".
- Select "Car Data" and press the controller.

4. Select "Stopwatch" and press the controller.



Starting, stopping or resetting

- ▶ Select "Start" and press the controller. The stopwatch starts at the displayed time.
- ▶ Select "Reset" and press the controller. The stopwatch is reset and restarts if it was running beforehand.
- ▶ Select "Stop" and press the controller. This stops the timer.

Taking an interim time reading

Select "Interim time" and press the controller. The interim time appears below the ongoing primary stopwatch count.

- ▶ All of the remaining functions remain available at all times while the stopwatch is running. The stopwatch continues operation in the background. ◀

Altering settings

Language on the Control Display

The language on the Control Display can be set, refer to the concept on page 16. The setting is stored for the remote control currently in use.

1. Open the start menu.
2. Press the controller to open the **i** menu.
3. Select "Display settings" and press the controller.

4. Select "Languages" and press the controller.

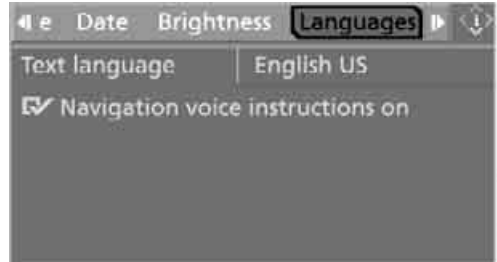

5. Select "Text language" and press the controller. You can switch to another language for the display texts and navigation messages.
6. Select and activate the desired language by pressing the controller.

Brightness of the Control Display

The brightness is automatically adapted to the ambient lighting conditions. Note, however, that you can change the basic setting while the low beams are switched on. The setting is stored for the remote control currently in use.

1. Open the start menu.
2. Press the controller to open the **i** menu.
3. Select "Display settings" and press the controller.
4. Select "Brightness" and press the controller.



5. Turn the controller until the desired setting is selected.

Technology for driving comfort and safety

PDC Park Distance Control*

The concept

The PDC assists you with maneuvering in tight parking spaces. Acoustic signals and a visual indicator warn you of the presence of an object in front of* or behind your car. To measure the distance, there are four ultrasonic sensors in each bumper. The sensors at the front* and at the two rear corners have a range of approx. 24 in/60 cm; the rear middle sensors have approx. 5 ft/1.50 m.

 PDC is a parking aid that can indicate objects when they are approached slowly, as is usually the case when parking. Avoid approaching an object at high speed, as otherwise physical circumstances may lead to the system warning being issued too late. ◀

Automatic mode

With the engine running or the ignition switched on, the system is activated automatically after approx. 1 second when you engage reverse gear or move the automatic transmission selector lever to position R. Wait this short period before driving.

Manual operation*



Press the button, the LED lights up.

Deactivating manual mode

Press the button again; the LED goes out.

The system is automatically deactivated once the vehicle travels approx. 165 ft/50 m or

exceeds a speed of roughly 20 mph or 30 km/h; the LED goes out. You can reactivate the system manually as needed.

Signal tones

When nearing an object, its position is indicated correspondingly by an interval tone. For example, the tone sounds at the rear if the system detects an object behind the car. As the distance between vehicle and object decreases, the intervals between the tones become shorter. If the distance to the nearest object falls to below roughly 1 ft/30 cm, then a continuous tone sounds.

The warning signal is canceled after approx. 3 seconds, if you are moving parallel to a wall.

Malfunction



The indicator lamp in the instrument cluster comes on. PDC is malfunctioning. A message appears on the Control Display. Have the system checked.

To avoid this problem, keep the sensors clean and free of ice or snow in order to ensure that they will continue to operate effectively.

Manual mode

The LED above the button flashes in addition.

PDC with optical warning

You can also have the system show distances to objects on the Control Display. The contours of distant objects are shown on the Control Display even before the acoustic signal sounds. The setting is stored for the remote control currently in use.

iDrive concept, refer to page 16.

1. Open the start menu.
2. Press the controller to open the  menu.
3. Select "Vehicle settings" and press the controller.

- Select "PDC" and press the controller.

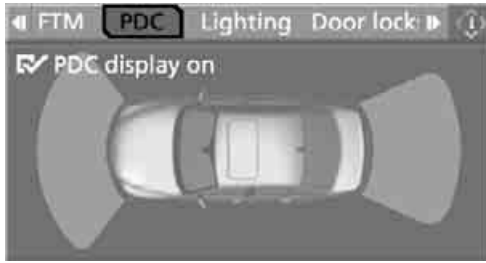

- Select "PDC display on" and press the controller.
- The PDC screen is activated.

The display is shown on the Control Display as soon as PDC is activated.

System limitations

⚠ Even with PDC, final responsibility for estimating the distance between the vehicle and any obstructions always remains with the driver. Even when sensors are provided, there is a blind spot in which objects can no longer be detected. The system is also subject to the physical limits that apply to all forms of ultrasonic measurement, such as those encountered with trailer towbars and couplings, thin and wedge-shaped objects, etc. Low objects already indicated, such as a curb, may enter the sensors' dead areas before a continuous audible signal is given. Higher, protruding objects, such as ledges, may not be detectable. Loud sound sources outside or inside the car can drown out the PDC signal. ◀

▶ Keep the sensors clean and free of ice or snow in order to ensure that they will continue to operate effectively.

Do not spray the sensors for a long period of time using high-pressure cleaners and maintain a distance of at least 4 in/10 cm when spraying the sensors. ◀

Driving stability control systems

Your BMW has a number of systems that help to maintain the vehicle's stability even in adverse driving conditions.

ABS Antilock Brake System

ABS prevents locking of the wheels during braking. Safe steering response is maintained even during full braking. Active safety is thus increased.

The ABS is operational every time you start the engine. Braking safely, refer to page 107.

Electronic brake-force distribution

The system controls the brake pressure in the rear wheels to ensure stable braking behavior.

DBC Dynamic Brake Control

When you apply the brakes rapidly, this system automatically produces the maximum braking force boost and thus helps to achieve the shortest possible braking distance during full braking. This system exploits all of the benefits provided by ABS.

Do not reduce the pressure on the brake pedal for the duration of the brake application. If the brake pedal is released, DBC will be switched off.

DSC Dynamic Stability Control

DSC prevents the driving wheels from losing traction when you pull away from rest or accelerate. DSC also recognizes unstable driving conditions, for example if the rear of the car is about to swerve or if momentum is acting at an angle past the front wheels. In these cases, DSC helps the vehicle maintain a safe course within physical limits by reducing engine output and through braking actions at the individual wheels.

⚠ The laws of physics cannot be repealed, even with DSC. An appropriate driving style always remains the responsibility of the driver. Therefore, do not reduce the additional safety margin again by taking risks. ◀

DTC Dynamic Traction Control

DTC is a version of DSC in which the drive output is optimized for particular road conditions, e.g. unplowed snow-covered roads. The system assures the maximal drive output, but with reduced driving stability. It is therefore necessary to drive with appropriate caution.

You may find it useful to briefly activate DTC under the following special circumstances:

- ▶ When driving uphill on snow-covered roads, in slush or on unplowed, snow-covered roads
- ▶ When rocking a stuck vehicle free or starting off in deep snow or on loose ground
- ▶ When driving with snow chains

Activating DTC



Briefly press the button; the DTC indicator lamps in the instrument cluster come on.

Deactivating DTC again

Press the button again; the DTC indicator lamps in the instrument cluster go out.

Deactivating DTC and DSC together



Press the button and hold it down for at least 3 seconds; the DSC indicator lamps in the

instrument cluster light up. Stabilizing and drive-output promoting actions are no longer executed.

To increase vehicle stability, activate DSC again as soon as possible.

Reactivating DSC

Briefly press the button; the indicator lamps in the instrument cluster go out.

To control



If the indicator lamp flashes: DSC or DTC controls the drive forces and brake forces.



If the indicator lamps are on: Both DTC and DSC have been deactivated with the DTC button.

DTC



If the indicator lamps are on: DTC has been activated with the DTC button.

Malfunction in driving stability control systems

These warning lamps come on: The driving stability control systems and the Flat Tire Monitor have failed. Proceed cautiously and drive defensively, avoiding full brake applications. Have the system checked as soon as possible.



ABS



Display* of this malfunction on Canadian models.



Display* of this malfunction on Canadian models.



If the warning lamps for DSC come on, DSC including DTC and DBC is malfunctioning.

The stabilizing action and brake-servo boost are no longer available. The vehicle remains operational. Have the system checked as soon as possible.

Drive-off assistant

The drive-off assistant enables you to drive off smoothly on uphill gradients. It is not necessary to use the handbrake for this.

1. Hold the car in place by pressing the brake pedal.
2. Release the brake pedal and drive off without delay.



The drive-off assistant holds the car in place for approx. 2 seconds after the brake pedal is released. Depending on vehicle load, the car may roll backwards a little during this time span. Drive off without delay after releasing the brake pedal. Otherwise, the drive-off assistant will no longer hold the car in place after approx. 2 seconds and the car will start to roll backwards. ◀

Malfunction

BRAKE



The warning lamps for the brake system light up in yellow. The drive-off assistant has failed. The car will not be held in place after the brake pedal is released. Have the system checked as soon as possible.



Display of this malfunction on Canadian models.



Flat Tire Monitor FTM

The concept

The Flat Tire Monitor monitors tire pressures while the car is being driven. The system reports any significant loss of pressure in one tire in relation to another.

If a tire loses pressure, its rolling radius changes, and this in turn alters the speed of rotation. This change is detected and is reported as a flat tire.

Functional requirement

In order to assure the reliable reporting of a flat tire, the system must be initialized for the correct tire inflation pressure.



The system must be reinitialized each time a tire inflation pressure has been corrected or a wheel or tire has been changed. ◀

System limitations



The Flat Tire Monitor is unable to warn the driver of sudden, severe tire damage caused by external factors, nor can it identify the gradual loss of pressure that will inevitably occur in all four tires over a lengthy period of time. ◀

In the following situations, the system could be delayed or malfunction:

- ▷ System has not been initialized
- ▷ Driving on snowy or slippery road surface
- ▷ Performance-oriented style of driving: slip in the drive wheels, high lateral acceleration
- ▷ If snow chains are attached

Initializing the system



The initialization is completed during driving, which can be interrupted at any time. When driving resumes, the initialization is continued automatically.

Do not initialize the system while snow chains are attached. ◀

iDrive concept, refer to page 16.

1. Press the **MENU** button.
This opens the start menu.
2. Press the controller to open the **i** menu.
3. Select "Vehicle settings" and press the controller.

4. Select "FTM" and press the controller.

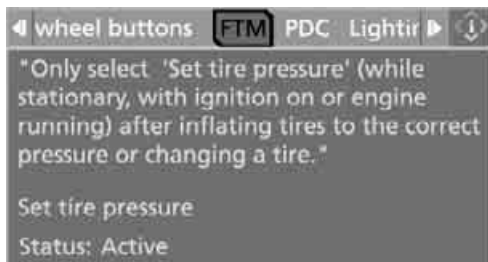

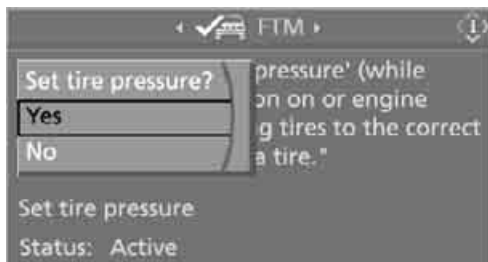

5. Start the engine, but do not start driving.
6. Select "Set tire pressure" and press the controller.
7. Select "Yes" and press the controller.



8. Start to drive. "Status: Active" reappears in the Control Display. Initialization is then completed while the car is in motion.

Indication of a flat tire

 The warning lamps come on in yellow and red. A message appears on the Control Display. In addition, an  acoustic signal sounds. There is a flat tire or substantial loss of tire pressure.

1. Cautiously reduce speed to below 50 mph or 80 km/h. Avoid sudden braking and steering maneuvers. Do not exceed a speed of 50 mph or 80 km/h.

 If the car is not equipped with Run-Flat Tires, refer to page 178, the standard equipment by design, do not continue driving. Any attempt to drive on after a puncture can result in a severe accident. ◀

2. At the next opportunity, check the air pressure in all four tires.

 If all four tires are inflated to the correct pressures, the Flat Tire Monitor might not have been initialized. The system must then be initialized. ◀

3. In the event of complete tire pressure loss, 0 psi/0 kPa, you can estimate the possible distance for continued driving on the basis of the following guidelines:
 - ▶ With a light load: 1 to 2 persons without luggage: approx. 155 miles/250 km
 - ▶ With a medium load: 2 persons, luggage compartment full, or 4 persons without luggage: approx. 90 miles/150 km
 - ▶ With a full load: 4 or more persons, luggage compartment full: approx. 30 miles/50 km

 Drive reservedly and do not exceed a speed of 50 mph or 80 km/h. In the event of pressure loss, vehicle handling changes. This includes reduced tracking stability in braking, extended braking distance and altered natural steering characteristics.

If unusual vibration or loud noises occur during the journey, this may be an indication that the damaged tire has finally failed. Reduce your speed and pull over to the side of the road at the earliest opportunity. Otherwise, parts of the tire could come loose and cause an accident. Do not continue driving. Contact your BMW center. ◀

Malfunction

 The warning lamps come on in yellow. A message appears on the Control Display. The Flat Tire Monitor has a malfunction or has failed. Have the system checked as soon as possible.

Active steering*

The concept

Active steering varies the turning angle of the front wheels in relation to steering wheel move-

ments. It also varies the steering force required to turn the wheels depending on the speed at which you are driving.

When you are driving in the low road-speed range, e.g. in a town or when parking, the steering angle increases, i.e. the steering becomes very direct, and less effort is required to turn the wheels. In the higher speed range, on the other hand, the steering angle is reduced more and more. This improves the handling capability of your BMW over the entire speed range.

In critical situations, the system can make targeted corrections to the steering angle provided by the driver and thus stabilize the vehicle before the driver intervenes. This stabilizing intervention is simultaneously deactivated when DSC is switched off, refer to page 79.

Malfunction



The warning lamps come on. Active steering is no longer operational. At low speeds, greater steering wheel movements are required, whereas at

higher speeds the vehicle reacts more sensitively to steering wheel movements. Drive cautiously and think well ahead. Have the system checked.

If the warning lamp lights up during the first engine starting following a power supply interruption, the system must be activated by being initialized.

Initializing the system

1. Start the engine.
2. With the vehicle stationary, turn the steering wheel from the straight-ahead position to the left as far as it will go and then back to the straight-ahead position.
3. Switch off the engine.

When you start the engine again, all the functions of Active steering are available once again.

Brake Force Display*

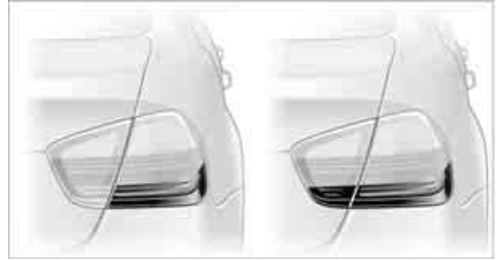

The brake lamps light up in two stages, depending on how sharply you apply the brakes.

- ▷ Normal braking:
The brake lamps and the center brake lamp light up.
- ▷ Sharp braking:
A larger part of the brake lamps' illuminating surface lights up.

Airbags

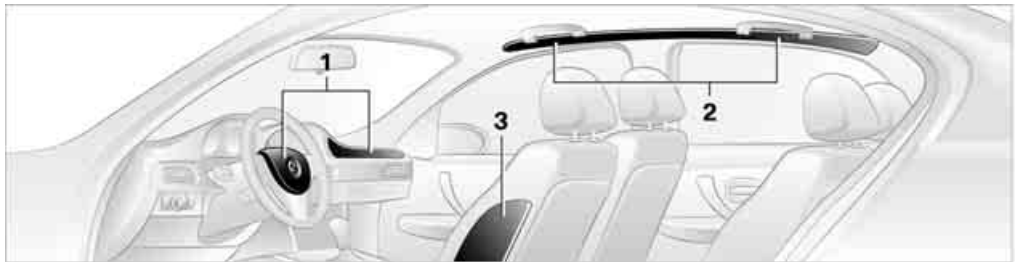

The following airbags are located under the marked covers:

- 1 Front airbags for driver and front passenger
- 2 Head airbags in front and rear

3 Side airbags in the seat backrests

Protective action

 Observe the adjustment instructions on page 38 to ensure the best possible personal protection. ◀

The front airbags help protect the driver and front passenger by responding to frontal impacts in which safety belts alone cannot provide adequate restraint. When needed, the head and side airbags help provide protection in the event of side impact. The relevant side airbag supports the side upper body area. The head air bag supports the head.

The airbags will purposely not be activated by every collision, e.g. not by more minor accidents, certain roll-over situations and rear-end collisions.

 Labels in the rear door opening should indicate the status of your rear seat side airbags. If you are uncertain of their status, or wish to have the airbags activated or deactivated, please contact your BMW center. ◀

For information on the correct sitting position, refer to page 38.

 Do not apply adhesive materials to the cover panels of the airbags, cover them or modify them in any other way. Do not attach seat covers, cushions or other objects not specifically approved for seats with integral side airbags to the front seats. Do not hang items of clothing such as coats or jackets over the backrests. Do not attempt to remove the airbag retention system from the vehicle. Do not modify the individual components of the system or its wiring in any way. This includes the upholstered covers on the steering wheel, instrument panel, seats and roof posts, as well as the sides of the roof lining. Do not attempt to remove or dismantle the steering wheel.

Do not touch the individual components immediately after the system has been triggered, because there is a danger of burns.

In the event of malfunctions, deactivation, or triggering of the airbag restraint system, have the testing, repair, removal, and disposal of airbag generators executed only by a BMW center

or a workshop that works according to BMW repair procedures with correspondingly trained personnel and has the required explosives licenses. Unprofessional attempts to service the system could lead to failure in an emergency or undesired airbag activation, either of which could result in personal injury. ◀

Airbag warning information is also provided on the sun visors.

Automatic deactivation of front passenger airbags

Your BMW has a seat occupation detection system. By evaluating the weight on the front passenger seat, the system detects whether or not the seat is occupied by a child in the child-restraint system or an adult.

- ▷ When a child is seated in the child-restraint system, or with an empty seat, the front and side airbags are automatically deactivated on the passenger side.
- ▷ When an adult is traveling in the front seat, the front and side airbags remain active on the passenger side.

 Although not desired, it can occur in the case of heavier children that the front passenger airbags remain active, or in the case of very light adults or young persons that the front passenger airbags are deactivated. In these cases, have the person ride in the rear seat, refer to Passenger airbag status lamp below. Do not load the passenger seat with any items in addition to the person to be transported. Do not attach seat covers, seat cushion padding, ball mats or other items to the front passenger seat unless they are specifically recommended by BMW. Do not place any items under the seat. Otherwise, the function of the seat occupation detection could be impaired. ◀

Operational readiness of airbag system



When the remote control is inserted into the ignition lock or the car is radio-ready, refer to page 49, the warning lamp comes on briefly to indicate that the entire airbag system and the belt tensioners are operational.

Airbag system malfunction

- ▷ The warning lamp does not come on after the remote control has been inserted into the ignition switch
- ▷ Warning lamp remains permanently on

! In the event of a fault in the airbag system, have it checked without delay, as otherwise there is the risk that the system will not function as intended even if a sufficiently severe accident occurs. ◀

Passenger airbag status lamp



The indicator lamp located above the rearview mirror indicates whether the front passenger airbag system is active or not active/OFF.

! The indicator lamp is used only for the front passenger airbag system. The indicator lamp illuminates to show that the front passenger airbag system is OFF/not active. ◀

- ▷ The lamp illuminates briefly during startup, but then goes out if the seat is empty, or an adult or child of sufficient size is detected.
- ▷ The lamp remains illuminated when a child in a rear-facing child-restraint system is detected and indicates that the passenger airbag system is off.

! If the lamp is illuminated when the seat is occupied by a very light adult or teenager, it is recommended that the person sit in the rear. ◀

Find more information about the front passenger airbag system and seat occupancy detection in the section Automatic deactivation of front passenger airbags on page 83.

Lamps

Parking lamps/low beams

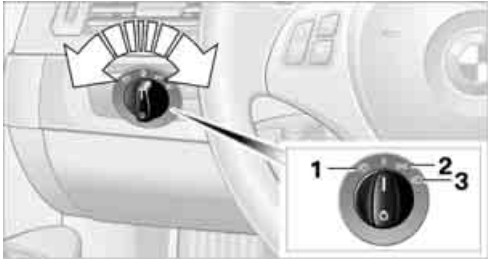



- 1 Automatic headlamp control*/Adaptive Head Light*
- 2 Parking lamps
- 3 Low beams

Automatic headlamp control*

When the switch is in position **1**, the low beams are switched on and off automatically depending on ambient light conditions, e.g. in a tunnel, in twilight, rain or snow. The LED next to the symbol is illuminated when the low beams are on.

You can leave the switch in position **1** when you switch off the engine. Once you open the driver's door while the ignition is switched off, the outside lamps automatically go out.

 The low beams remain switched on independent of the ambient lighting conditions when you switch on the fog lamps*.

 The automatic headlamp control cannot serve as a substitute for your personal judgment in determining when the lamps should be switched on in response to ambient lighting conditions. For example, the system cannot detect fog. To avoid safety risks, you should always switch on the lamps manually under these conditions.

Adjusting sensitivity

iDrive concept, refer to page [16](#).

1. Press the **MENU** button.
This opens the start menu.
2. Press the controller to open the **i** menu.
3. Select "Vehicle settings" and press the controller.
4. Select "Lighting" and press the controller.
5. Select "Auto. headlamps" and press the controller.
6. Select a menu item:
 - ▷ "Sensitive"
 - ▷ "Normal"
 - ▷ "Slower"



7. Press the controller.

Parking lamps

In switch position **2**, the front, rear and side vehicle lighting is switched on. You can use the parking lamps for parking. For lighting on one side for parking as an additional feature, refer to page [86](#).

 The parking lamps will discharge the battery. Do not use them for unduly long periods of time, as otherwise the battery might not have enough power to start the engine.

Low beams

When the switch is in position **3**, the low beams are on only when the ignition is on; with the ignition off the parking lamps are on.

Pathway lighting

If you activate the headlamp flasher after parking the car, with the lights switched off, the low beams come on and remain on for a certain time. You can adjust the operating period or deactivate the function using iDrive.

1. Open the start menu.
2. Press the controller to open the **i** menu.
3. Select "Vehicle settings" and press the controller.
4. Select "Lighting" and press the controller.



5. Select "Pathway lighting" and press the controller.
6. Turn the controller to select the corresponding duration.
7. Press the controller to apply the setting.

Daytime driving lamps*

If desired, the light switch can remain in the low-beam headlamp position or the automatic headlamp control position.

After you have switched off the ignition, refer to page 49, and opened the driver's door, the outside lights switch off automatically.

Always observe all applicable laws governing the use of daytime driving lamps.

You can switch on the parking lamps when needed using the standard procedure described under Parking lamps.

Adaptive Head Light*

The concept

Adaptive Head Light is a variable headlamp control system that enables better illumination of the road surface. Depending on the steering angle and other conditions, the light from the headlamp follows the course of the road.

Activating Adaptive Head Light

With the ignition on, turn the light switch to the automatic headlamp control position, refer to page 85.

To avoid dazzling the drivers of oncoming vehicles, Adaptive Head Light is not active when the car is driven in reverse, and directs the light to the front passenger's side when the vehicle is at a standstill.

Malfunction

The LED next to the symbol for automatic headlamp control flashes. Adaptive Head Light is malfunctioning or has failed. Have the system checked as soon as possible.

High beams/roadside parking lamps

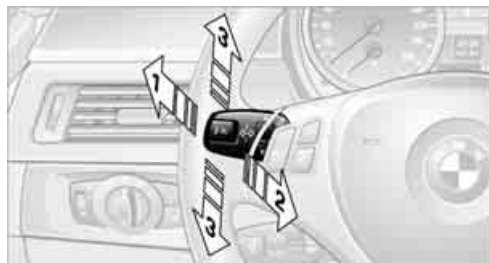

- 1 High beams
- 2 Headlamp flasher
- 3 Roadside parking lamps*

Roadside parking lamps, left or right*

There is an additional option of switching on the lamps on the side of the car facing the road when parked, if permitted in the country of use.

With the remote control removed or with radio readiness and ignition switched off, refer to page 49, press the stalk beyond its resistance point in the appropriate direction 3. The flashing turn signals must remain off.

 The roadside parking lamps drain the battery. Do not use them for unduly long periods of time, as otherwise the battery might not have enough power to start the engine. ◀

Fog lamps*



 The parking lamps or low beams must be switched on for the fog lamps to operate. The green indicator lamp in the instrument cluster lights up whenever the fog lamps are on.

The fog lamps are switched off whenever the high beams are switched on.

 If the automatic headlamp control is activated, the low beams will come on automatically when you switch on the fog lamps. ◀

Instrument lighting

You can adjust the brightness of the instrument lighting only when the parking lamps or the low beams are switched on.



1. Lightly push button 1 repeatedly up or down until the appropriate symbol appears in the display, accompanied by the brightness and the word "SET".
2. Press button 2.



3. Lightly push button 1 up or down to select the brightness; the setting is stored immediately.
4. Press button 2 in the turn indicator stalk. The display again shows the outside temperature and the time.

Interior lamps

The interior lamps, the footwell lamps*, the luggage compartment lamp and the courtesy lamps* are controlled automatically.

The LEDs for the courtesy lamps are set in the door handles and illuminate the ground in front of the doors.

 To avoid draining the battery, all lamps inside the car are switched off about 15 minutes after radio readiness is switched off, refer to Start/stop button on page 49. ◀

Switching interior lamps on and off manually



Interior lamps, front and rear*:

To switch on and off, press the button briefly.

To switch off the lamp permanently, hold the button for the front interior lamp pressed for about 3 seconds.

Reading lamps

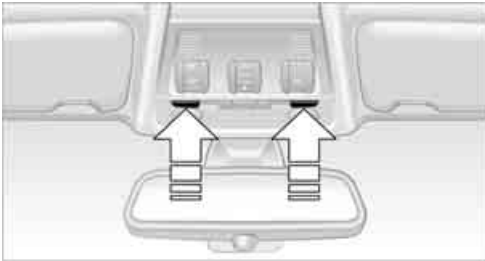

There are reading lamps at the front and rear*, next to the interior lamps. To switch on and off, press the button briefly.

Controlling the climate for pleasant driving

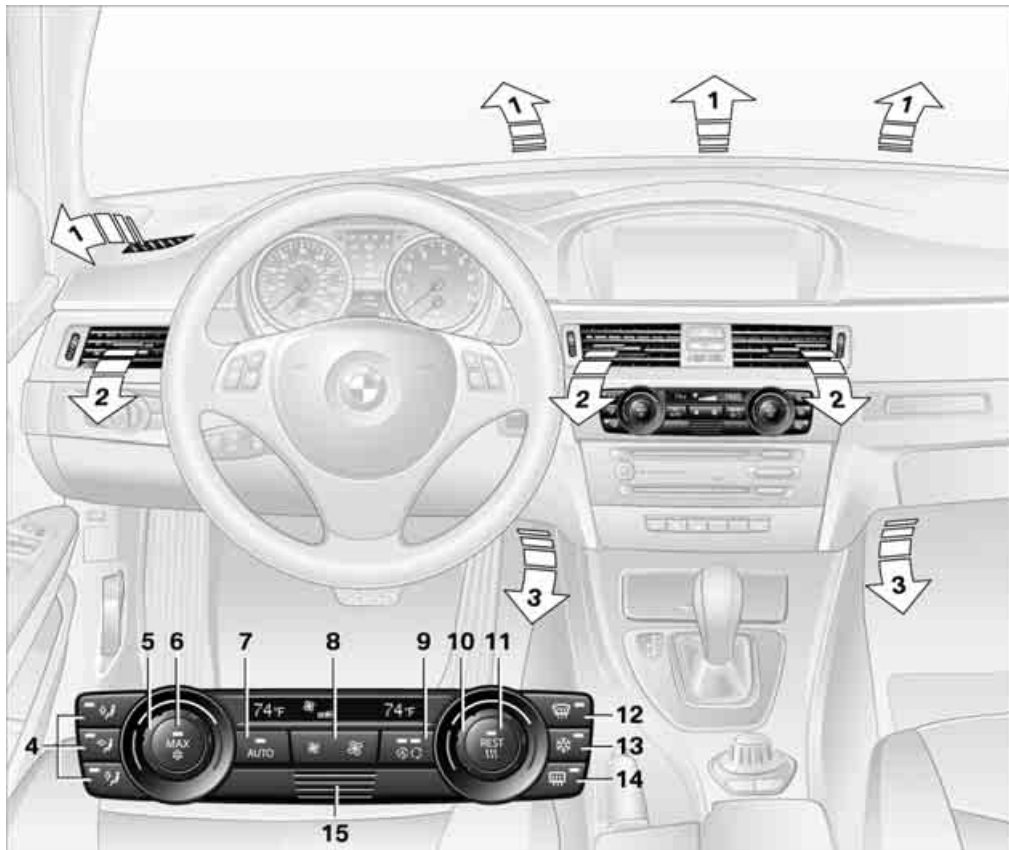

- | | |
|--|---|
| <ul style="list-style-type: none"> 1 Airflow directed toward the windshield and side windows 2 Air to the upper body area
Draft-free ventilation 92 3 Air to the footwell 4 Air distribution, manual 5 Temperature adjustment, left-hand side of passenger compartment 6 Maximum cooling 7 AUTO program 8 Air flow rate, manual 9 AUC Automatic recirculated-air control/ Recirculated-air mode | <ul style="list-style-type: none"> 10 Temperature adjustment, right-hand side of passenger compartment 11 Residual heat 12 Defrosting windows and removing condensation 13 Switching cooling function on/off manually 14 Rear window defroster 15 Air grill for interior temperature sensor – please keep clear and unobstructed <p>The current setting for the air distribution is displayed on the Control Display, refer to page 90.</p> |
|--|---|

Automatic climate control

Comfortable interior climate

AUTO program 7 offers the ideal air distribution and air flow rate for practically all conditions, refer to AUTO program below. All you need to do is select an interior temperature which is comfortable for you.

The following sections inform you in detail about how to adjust the settings.

Most settings are stored for the remote control currently in use, refer also to Personal Profile settings on page 29.

Adjusting air distribution manually



Direct the flow of air to the windows, to the upper body area or to the footwell.

You can switch the automatic air distribution back on by pressing the AUTO button.

Manual fine adjustments in air distribution

You can set the rate of incoming airflow for manual air distribution.

iDrive concept, refer to page 16.

1. Press the **MENU** button.
This opens the start menu.
2. Move the controller to the left to call up "Climate".
3. Select "Vent settings" and press the controller.
4. Select the desired area.

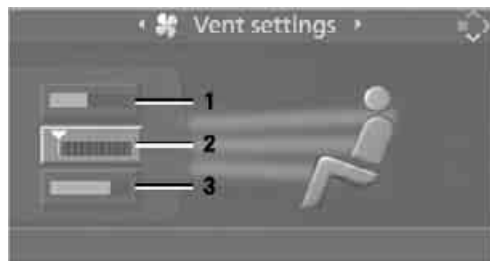

5. Turn the controller to set the air distribution individually.

- 1 Airflow directed toward the windshield and side windows
- 2 Air to the upper body area
- 3 Air to the footwell

Temperature



Set the desired temperatures individually for the driver's and front passenger's sides.

The automatic climate control achieves this temperature as quickly as possible regardless of the season, using maximum cooling or heating power if necessary, and then maintains it.



Avoid switching the automatic climate control system frequently from very low to very high temperatures and vice versa. When changes are made quickly in succession, the automatic climate control does not have enough time to achieve the set temperature. ◀

Maximum cooling



At outside temperatures above 32 °F / 0 °C and when the engine is running, you obtain a maximum cooling effect as soon as possible.

The automatic climate control switches to the lowest temperature and operates in recirculated-air mode. Air flows at maximum rate only from the vents for the upper body area. For this reason you should ensure that these vent outlets are open before selecting this program.

AUTO program



The AUTO program adjusts the air distribution to the windshield and side windows, towards the upper body area and into the footwell for you. The air flow rate and your temperature specifications will be adapted to outside influences as a result of seasonal changes, e.g. sunlight or window condensation.

The cooling is switched on automatically with the AUTO program.

Intensity of the AUTO program

You can set the intensity of the air supply in the AUTO program. This changes the duration of time during which the vehicle interior is heated or cooled.

1. Open the start menu.
2. Call up "Climate".
3. Select "Automatic programs" and press the controller.
4. Select the desired area.
5. Press the controller to set the desired intensity.



 The selected intensity level of the automatic program is switched on.

Adjusting air flow rate manually



Press the left side of the button to reduce airflow. Press the right side of the button to increase it. You can reactivate the automatic mode for the air flow rate with the AUTO button.

Switching the system on/off

With the blower at its lowest setting, press the left side of the button to switch off the automatic climate control. All indicators go out.

Press any button except REST to reactivate the automatic climate control.

AUC Automatic recirculated-air control/Recirculated-air mode



Set the desired operating mode by pressing this button repeatedly:

▷ LEDs off: outside air flows in continuously.

- ▷ Left-hand LED on, AUC mode: a sensor detects pollutants in the outside air. If necessary, the system blocks the supply of outside air and recirculates the inside air. As soon as the concentration of pollutants in the outside air has decreased sufficiently, the system automatically switches back to outside air supply.
- ▷ Right-hand LED on, recirculated-air mode: the supply of outside air is permanently shut off. The system then recirculates the air currently within the vehicle.

You can activate/deactivate the recirculated-air mode by means of a freely programmable button* in the steering wheel, refer to page 11.



If condensation starts to form on the inside window surfaces during operation in the recirculated-air mode, you should switch it off while also increasing the air flow rate as required.

The recirculated-air mode should not be used over an extended period of time, as otherwise the air quality inside the car will deteriorate continuously. ◀

Using residual heat



The heat stored in the engine is used to heat the passenger compartment, e.g. while stopped at a school to pick up a child.

You can use this function for up to 15 minutes after switching off the engine if it is warm and the battery is sufficiently well charged. The outside temperature must be below 77 °F/25 °C. The LED in the button comes on if these conditions are met and the function is activated.

Defrosting windows and removing condensation



This program quickly removes ice and condensation from the windshield and front side windows.

When the program is switched on, the LED comes on.

Switching the cooling function on and off



The cooling function cools and dehumidifies the incoming air before also reheating it as required, according to the temperature setting. Depending on the weather, the windshield may fog over briefly when the engine is started.

The cooling function is only available when the engine is running and is switched on automatically with the AUTO program.

Rear window defroster



When the rear window defroster is switched on, the LED comes on. The defroster switches off automatically after a certain time.

Ventilation

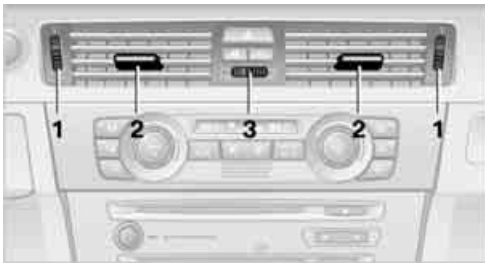

- 1 Use the knurled wheels to smoothly open and close the air vents
- 2 Use the lever to change the direction of the airflow
- 3 Knurled wheel for more or less cool air from the vents for the upper body area

Ventilation for cooling

Adjust the vent outlets to direct the flow of cool air in your direction, for instance if it has become too hot in the car.

Draft-free ventilation

Set the vent outlets so that the air flows past you and not straight at you.

Ventilation in the rear

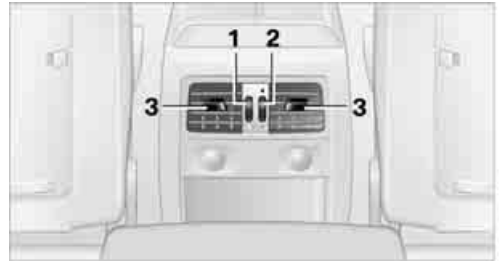

- 1 Use the knurled wheel to smoothly open and close the air vents
- 2 Use the knurled wheel to adjust the temperature:
 - ▷ Turn toward blue: colder
 - ▷ Turn toward red: warmer
- 3 Use the lever to change the direction of the airflow

Microfilter/activated-charcoal filter

The microfilter traps dust and pollen in the incoming air. The activated-charcoal filter provides additional protection by filtering gaseous pollutants from the outside air. Your BMW center replaces this combined filter during routine maintenance.

You can call up further information in the service requirements display, refer to page 69.

Practical interior accessories

Integrated universal remote control*

The concept

The integrated universal remote control can replace as many as three hand-held transmitters for various remote-controlled devices, such as door openers and house alarm systems. The integrated universal remote control registers and stores signals from the original hand-held transmitters.

The signal of an original hand-held transmitter can be programmed on one of the three memory buttons **1**. After this, the programmed memory button **1** will operate the system in question. The LED **2** flashes to confirm transmission of the signal.

Should you sell your vehicle one day, be sure to delete the stored programs beforehand for your safety, refer to page [94](#).

 To prevent possible damage or injury, before programming or using the integrated universal remote control, always inspect the immediate area to make certain that no people, animals or objects are within the pivoting or travel range of the device being operated. Comply also with the safety instructions supplied with the original hand-held transmitter. ◀

Checking compatibility

 If this symbol appears on the package or in the instructions supplied with the original hand-held transmitter, you can assume that the radio remote control device will be compatible with the integrated universal remote control.

 If you have additional questions, please consult your BMW center or call 1-800-355-3515.

You can also visit these websites:
www.bmwusa.com or
www.homelink.com.

HomeLink is a registered trademark owned by Johnson Controls, Inc. ◀

Programming



- 1 Memory buttons
- 2 LED

Fixed-code hand-held transmitters

1. Switch on the ignition, refer to page [49](#).
2. When starting operation for the first time: Press both outer memory buttons **1** for approx. 20 seconds until the LED **2** flashes. All stored programs are cleared.
3. Hold the original hand-held transmitter at a distance of approx. 2 to 8 in/5 to 20 cm from the memory buttons **1**.
 The required distance between the hand-held transmitter and the memory buttons **1** depends on the system of the respective original hand-held transmitter used. ◀
4. Simultaneously press the transmit key on the original hand-held transmitter and the desired memory button **1** on the integrated universal remote control. The LED **2** flashes slowly at first. As soon as the LED **2** flashes rapidly, release both buttons. If the LED **2** does not flash rapidly after approx. 15 seconds, alter the distance.
5. To program other original hand-held transmitters, repeat steps 3 and 4.

The corresponding memory button **1** is now programmed with the signal of the original hand-held transmitter.

You can operate the system when the engine is running or when the ignition is switched on.

 If the system fails to function even after repeated programming, check whether the original hand-held transmitter uses an alternating-code system. To do so, either read the instructions for the original hand-held transmitter or hold down the programmed memory button **1** of the integrated universal remote control. If the LED **2** on the integrated universal remote control flashes rapidly for a short while and then remains lit for about two seconds, the original hand-held transmitter uses an alternating-code system. If it uses an alternating-code system, program the memory buttons **1** as described under Alternating-code hand-held transmitters. ◀

Alternating-code hand-held transmitters

To program the integrated universal remote control, consult the operating instructions for the device to be set. You will find information there on the possibilities for synchronization. When programming hand-held transmitters

that employ an alternating code, please observe the following supplementary instructions:

 Programming will be easier with the aid of a second person. ◀

1. Park your vehicle within the range of the remote-controlled device.
2. Program the integrated universal remote control as described above in the section Fixed-code hand-held transmitters.
3. Locate the button on the receiver of the device to be set, e.g. on the drive unit.
4. Press the button on the receiver of the device to be set. After step 4, you have approx. 30 seconds for step 5.
5. Press the programmed memory button **1** of the integrated universal remote control three times.

The corresponding memory button **1** is now programmed with the signal of the original hand-held transmitter.

 If you have any questions, please contact your BMW center. ◀

Deleting stored programs

Press both outer memory buttons **1** for approx. 20 seconds until the LED **2** flashes: all stored programs are cleared.

It is not possible to clear individual programs.

Interior rearview mirror with digital compass*

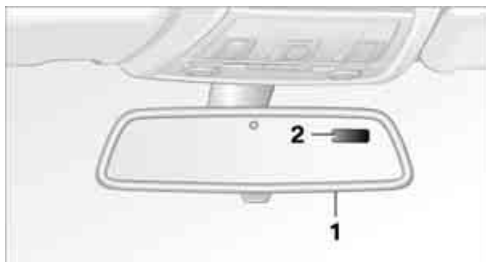

1 Adjustment button

2 Display

The display shows you the main or subcardinal direction in which you are driving.

Setting compass zones

Depending on the vehicle's geographic location, the relevant compass zone must be set. Refer to the world map with compass zones below.

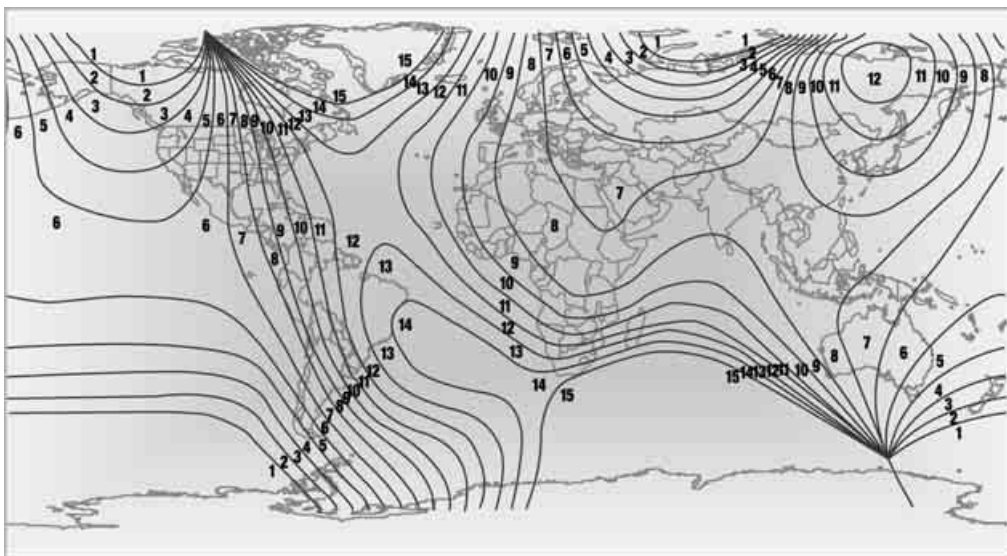

To set a compass zone, press the adjustment button on the bottom of the interior rearview mirror with a pointed object, such as a pen, for approx. 3–4 seconds. The number of the compass zone set is shown in the display.

To change the zone setting, press the adjustment button repeatedly until the display shows the number of the compass zone in which you are currently driving:

The compass is operational again after approx. 10 seconds.

For information on the automatic dimming feature, refer to Interior and exterior mirrors, automatic dimming feature, page 107.

Calibrating the digital compass

The digital compass must be calibrated in the following situations:

- ▷ C or CAL is displayed.
- ▷ The compass shows the wrong cardinal direction.
- ▷ The cardinal direction shown does not change although the direction of travel does.
- ▷ Not all cardinal directions are shown.

Procedure

1. Make sure that no large metal objects or overhead power lines are in the vicinity of your vehicle and that you have enough space to drive in a circle.
2. Set the currently valid compass zone.
3. Press the adjustment button to call up C or CAL. Then drive in one full circle at a speed of no more than 4 mph or 7 km/h. If calibration is successful, the C or CAL display is replaced by the cardinal directions.

Roller sun blinds*

Rear window blind



Tap the button in the center console to raise or lower the roller sun blind.

Roller sun blind for rear side window

Pull loop of roller sun blind and hook onto bracket.

Glove compartment

Opening

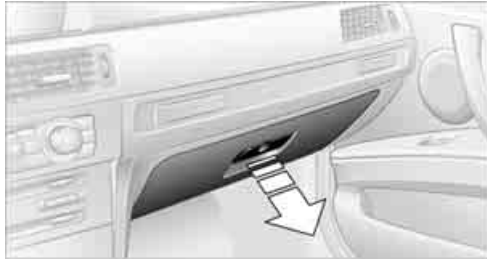

Pull the handle.
The light in the glove compartment switches on.

Closing

Fold the cover up.

 To prevent injury in the event of an accident while the vehicle is being driven, close the glove compartment immediately after use. ◀

Locking

To lock the glove compartment, use the integrated key of the remote control or the spare key, refer to page 28.

Rechargeable flashlight*

It is on the left-hand side of the glove compartment. The flashlight can remain plugged in. Whenever required, pull the flashlight out of its socket.

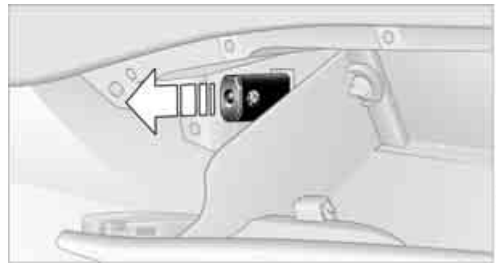

 Only insert the flashlight back into the socket when it is switched off, as otherwise there is a risk of damage. ◀

Center armrest

Storage compartment

The center armrest between the front seats contains either a compartment or a portable-phone holder*, depending on the equipment version.

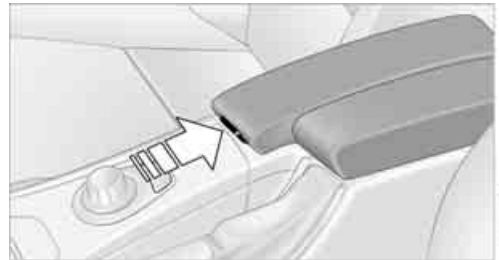

Opening

Press the button, see arrow.
The lid opens.

Ventilated storage compartment



The storage compartment in the center armrest can be ventilated: push the switch to position 1.

The temperature is controlled via the knurled wheel **2** for rear ventilation, refer to page [92](#).

Connection for external audio device

You can connect an external audio device such as a CD or MP3 player and play audio tracks over the car's loudspeaker system, refer to page [149](#).

Storage compartments inside the vehicle

There are also compartments beside the steering column*, in the front doors and in the center console*.

There are nets* on the front-seat backrests.

Clothes hooks

There are clothes hooks on the grab handles in the rear passenger compartment.

 Items of clothing hung from the hooks must not obstruct the driver's view. Do not hang heavy objects from the hooks, as they could endanger the car's occupants, e.g. in case of heavy braking or sudden swerving. ◀

Storage spaces in the luggage compartment

Left storage compartment, suitable e.g. for storing a box of cleaning tissues or up to 12 CD cases, depending on vehicle equipment version.

The lashing eyes in the luggage compartment provide you with a way to attach luggage compartment nets* or flexible straps* for securing suitcases and luggage, refer to page [109](#).

Raising the floor panel

Press the floor panel against the top of the luggage compartment; a locking device holds the floor panel in place. To detach the floor panel, pull it out of the locking device.

Equipment version with drawer:

Take the retaining strap on the right-hand side of the drawer out of the bracket and use it to fix the floor panel in place.

 Do not exceed the maximum permissible load of 55 lbs/25 kg for the storage compartment under the floor panel, as otherwise damage could result. ◀

Storage package*

The luggage compartment also offers these additional storage options:

- ▷ Hooks for hanging up, e.g., shopping bags or tote bags
- ▷ Rubber strap on the left trim panel for securing small objects such as a folding umbrella
- ▷ Net for small objects on the right trim panel
- ▷ Retaining straps next to the rear lashing eyes, e.g. for securing an umbrella
- ▷ Folding, removable box under the floor panel, e.g. for wet or dirty items
- ▷ Insertable dividing elements for the storage compartment under the floor panel
- ▷ Luggage net, attachable to the mountings on the floor panel
- ▷ Drawer for storing small items. Pull the handle firmly to release the drawer. If neces-

sary, you can pull out the drawer entirely, refer to the information below

! Do not drive or close the luggage compartment lid while the drawer is pulled out.

On uphill gradients, release the drawer with caution, as otherwise it could slide out on its own and cause injury.

Do not exceed a maximum load of 11 lbs/5 kg for the drawer, as otherwise damage could result. ◀

Removing the drawer

1. Push the drawer all the way in.
2. Turn the catches on the left and right all the way out.



3. Remove the drawer by pulling it down and backwards.

Reinserting the drawer

1. Hook the guides of the drawer into the front of the yellow guide aids on the underside of the luggage compartment.
2. Insert the catches into the mounts on the underside of the luggage compartment.
3. Turn the catches on the left and right all the way in.

Cup holders

! Do not place glassware in a cup holder; otherwise there is an increased risk of injury in the event of an accident. ◀

Front

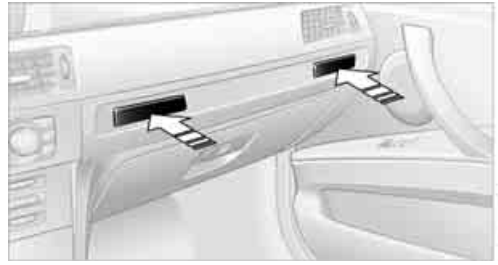

Opening

Briefly press the center of the cover.

Closing

Briefly press the cover in the center and push in the cup holder.

Rear

There are two additional cup holders in the rear center armrest.

Ashtray, front

Opening



Push the projection on the cover.

Emptying



Lift out the insert.

Lighter



With the engine running or the ignition switched on, press in the cigarette lighter.

The lighter can be removed as soon as it pops back out.

 Hold or touch the hot cigarette lighter by the knob only. Holding or touching it in other areas could result in burns.

When leaving the car, always remove the remote control so that children cannot operate the cigarette lighter and possibly burn themselves. ◀

Ashtray, rear

Opening

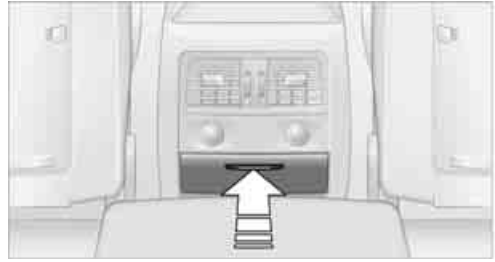

Push the projection on the cover.

Emptying

Lift out the insert.

Connecting electrical appliances

Cigarette lighter socket*

With the ignition switched on, the cigarette lighter socket can be used as a power outlet for a flashlight, car vacuum cleaner, etc., rated up to about 200 watts at 12 V. Remove the cigarette lighter prior to using the socket. Avoid damaging the socket by attempting to insert plugs of unsuitable shape or size.

Rear center console*

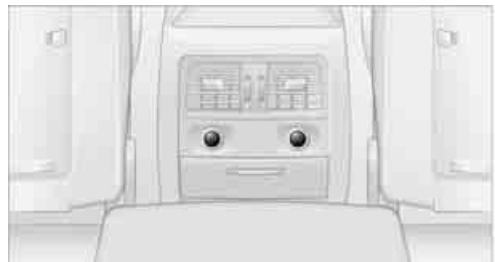

To gain access to the power socket:
Remove the corresponding cover.

In the luggage compartment*



To gain access to the power socket:
Open the cap.

Through-loading system*

Opening

1. Open the belt lock of the rear center safety belt. To do so, press the button, see arrow, and release the latch plate.

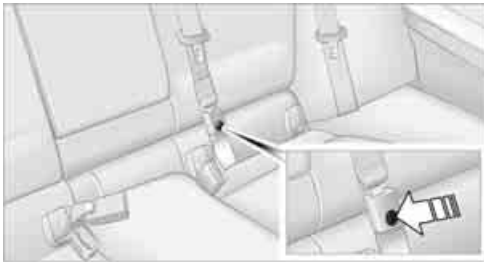

2. Insert the latch plate at the end of the belt into the specially designated fixture on the rear window shelf.

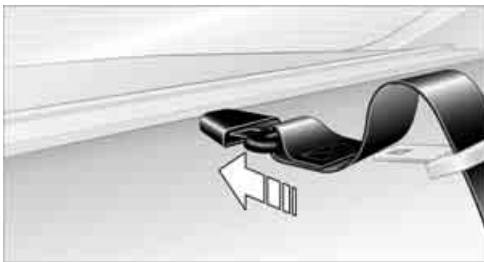

3. Push the corresponding head restraint down as far as it will go, refer to page 41.

4. To release the rear seat back, pull the corresponding lever in the luggage compartment.

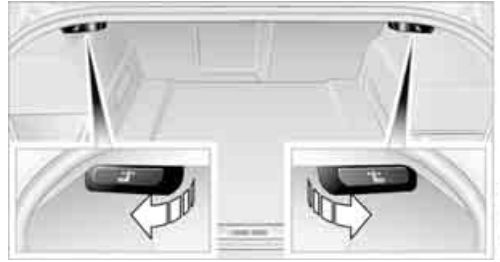

5. The unlocked rear seat back moves forward slightly. Fold the seat back forward by the head restraint.



Closing

1. Return the rear seat back to its upright position and engage it.



When returning the backrest into its seating position, make sure that the seat's locking mechanism engages properly. Otherwise, cargo could be thrown around in the event of sharp braking or swerving and endanger the occupants. ◀

2. Release the latch plate from the fixture on the rear window shelf and insert it into the belt lock of the center safety belt. Make sure you hear the latch plate engage in the belt buckle.

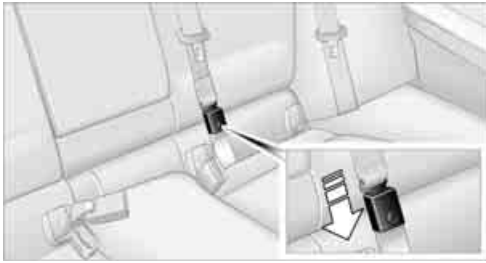

The lashing eyes in the luggage compartment provide you with a way to attach luggage compartment nets* or draw straps for securing suitcases and luggage, refer to page 109.

Ski bag*

Designed for safe, clean transport of up to 4 pairs of standard skis or up to 2 snowboards.

With the ski bag you can stow skis with a length of up to 6 ft 10 in/2.10 m. When skis of 6 ft 10 in/2.10 m length are loaded, the overall capacity of the ski bag is reduced due to its tapered design.

Loading

1. Fold down the center armrest.
2. Press the button, reach into the recess and fold down the cover.

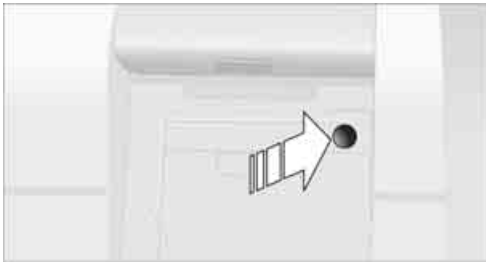

3. Open the Velcro fastener, spread the ski bag between the front seats and insert the skis or snowboards.
The zip fastener makes objects in the ski bag easier to reach.

4. Insert the latch plate of the ski bag's retaining strap in the center belt buckle.



Make sure to load only clean skis into the ski bag. Wrap sharp edges to prevent damage.

Securing cargo

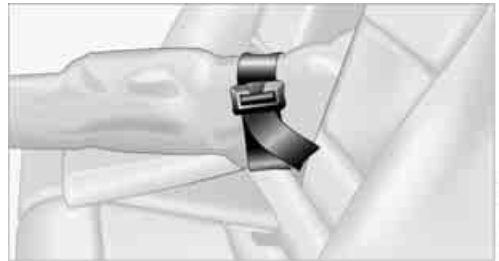

After loading, secure the ski bag and its contents. Tighten the retaining strap on the tensioning buckle for this purpose.

! Secure the ski bag in the manner described, as otherwise it could endanger the car's occupants, e.g. in case of heavy braking or sudden swerving. ◀

To store the ski bag, perform the steps described for loading in reverse order.

Removing the ski bag

The ski bag can be completely removed, e.g. for faster drying or to allow you to use other inserts.

1. Fold down the center panel in the rear seat backrest.
2. Pull the handle, arrow 1.



3. Pull out the insert, arrow 2.

 For more information on the various inserts available, contact your BMW center. ◀





Driving tips

This section provides you with information useful in dealing with specific driving and operating conditions.

Things to remember when driving

Break-in period

Moving parts need breaking-in time to adjust to each other. Please follow the instructions below in order to achieve the optimal service life and economy of operation for your vehicle.

Engine and differential

Up to 1,250 miles/2,000 km:
Attempt to vary both engine and vehicle speeds, but refrain from exceeding an engine speed of 4,500 rpm or a driving speed of 100 mph or 160 km/h.

Always obey all official speed limits.

Avoid full-throttle operation and use of the transmission's kick-down mode.

Once you have driven 1,250 miles/2,000 km, the engine and vehicle speeds can be gradually increased.

Tires

Due to technical factors associated with their manufacture, tires do not achieve their full traction potential until after an initial break-in period. Therefore, drive reservedly during the first 200 miles/300 km.

Brake system

Brakes require an initial break-in period of approx. 300 miles/500 km to achieve optimized contact and wear patterns between brake pads and rotors. Drive with caution during this break-in period.

Clutch

The function of the clutch reaches its optimal level only after a distance driven of approx. 300 miles/500 km. During this break-in period, engage the clutch gently.

Following part replacement

The same break-in procedures should be observed if any of the components mentioned

above have to be renewed in the course of the vehicle's operating life.

General driving notes

Closing the luggage compartment lid

 Operate the vehicle only when the luggage compartment lid is completely closed. Otherwise, exhaust fumes could enter the interior of the vehicle. ◀

If special circumstances make it absolutely necessary to drive with the luggage compartment lid open:

1. Close all windows and the glass sunroof.
2. Increase the air flow rate of the automatic climate control considerably, refer to page 91.

Hot exhaust system

 As in all vehicles equipped with a catalytic converter, extremely high temperatures are generated in this vehicle. Do not remove the heat shields installed adjacent to various sections of the exhaust system, and never apply undercoating to them. When driving, standing at idle and while parking, take care to avoid possible contact between the hot exhaust system and any highly flammable materials such as hay, leaves, grass, etc. Such contact could lead to a fire, with the risk of serious personal injuries and property damage. ◀

Portable phone in the vehicle

 BMW discourages the use of mobile communications devices, e.g. portable phones, inside the vehicle without a direct connection to an outside antenna. Otherwise, the vehicle electronics and mobile communication device can influence one another. In addition, there is no assurance that the radiation which results from transmission will be dissipated from the vehicle interior. ◀

Interior and exterior mirrors, automatic dimming feature*

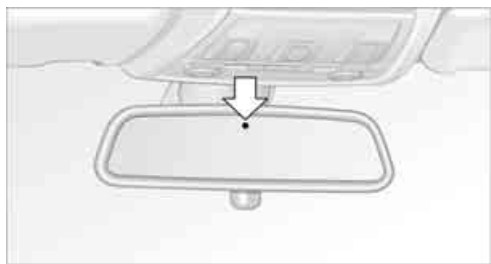

The automatic dimming feature of the interior and exterior mirrors* is controlled by two photo cells in the interior rearview mirror. One photo cell is in the mirror frame, see arrow; the other is on the back of the mirror.

In order to ensure that the system functions correctly, keep the photo cells clean, do not cover the area between the interior rearview mirror and windshield, and do not affix adhesive labels or stickers of any kind to the windshield directly in front of the mirror.

Hydroplaning

 When driving on wet or slushy roads, reduce road speed. If you do not, a wedge of water can form between tires and road surface. This situation, known as hydroplaning, means that the tire can actually lose contact completely with the road surface, so that neither the car can be steered nor the brake be properly applied. ◀

The risk of hydroplaning increases with declining tread depth on the tires, refer also to Minimum tread depth on page 177.

Driving through water

 Drive through water on the road only if it is not deeper than 1 ft/30 cm, and then only at walking speed at the most. Otherwise, the vehicle's engine, the electrical systems and the transmission may be damaged. ◀

Using handbrake on inclines

 On inclines, do not hold the vehicle with the clutch; use the handbrake. Otherwise greater clutch wear will result. ◀

Also use the drive-off assistant, refer to page 80.

Braking safely

Your BMW is equipped with ABS as a standard feature. Applying the brakes fully is the most effective way of braking in situations in which this is necessary. Since the vehicle maintains steering responsiveness, you can still avoid possible obstacles with a minimum of steering effort.

Pulsation of the brake pedal, combined with sounds from the hydraulic circuits, indicate that ABS is in its active mode.

Driving in wet conditions

When roads are wet or there is heavy rain, briefly exert gentle pressure on the brake pedal every few miles. Monitor traffic conditions to ensure that this maneuver does not endanger other road users. The heat generated in this process helps dry the pads and rotors to ensure that full braking efficiency will then be available when you need it.

Hills

 To prevent overheating and the resulting reduced efficiency of the brake system, drive long or steep downhill gradients in the gear in which the least braking is required. Even light but consistent pedal pressure can lead to high temperatures, brake wear and possibly even brake failure. ◀

You can increase the engine's braking effect by shifting down, all the way to first gear if necessary. This strategy helps you avoid placing excessive loads on the brake system. Downshifting in manual mode of the automatic transmission, refer to page 52.

 Never drive with the clutch pedal held down, with the gearshift lever or selector lever in neutral or with the engine switched off; engine braking action will not be present with

the transmission in neutral and there will be no power assistance to the brakes or steering while the engine is switched off. Never allow floor mats, carpets or any other objects to protrude into the area around the accelerator and brake pedals and obstruct their movement. ◀

Corrosion on brake rotors

When the vehicle is driven only occasionally, during extended periods when the vehicle is not used at all, and in operating conditions where brake applications are less frequent, there is an increased tendency for corrosion to form on rotors, while contaminants accumulate on the brake pads. This occurs because the minimum pressure which must be exerted by the pads during brake applications to clean the rotors is not reached.

Should corrosion form on the brake rotors, the brakes will tend to respond with a pulsating effect that even extended application will fail to cure.

When the vehicle is parked

Condensation forms while the automatic climate control is in operation, and then exits under the vehicle. Traces of condensed water under the vehicle are therefore normal.

Before driving into a car wash

For general information about taking care of your BMW, refer to the Caring for your vehicle brochure.

Cargo loading

 To avoid loading the tires beyond their approved carrying capacity, never overload the vehicle. Overloading can lead to overheating and increases the rate at which damage develops inside the tires. The ultimate result can assume the form of a sudden blow-out. ◀

Determining loading limit



1. Locate the following statement on your vehicle's placard*:
 The combined weight of occupants and cargo should never exceed XXX kg or YYY lbs. Otherwise, overloading can result in damage to the vehicle and unstable driving conditions. ◀
2. Determine the combined weight of the driver and passengers that will be riding in your vehicle.
3. Subtract the combined weight of the driver and passengers from XXX kilograms or YYY pounds.
4. The resulting figure equals the available amount of cargo and luggage load capacity. For example, if the YYY amount equals 1,400 lbs. and there will be five 150 lbs. passengers in your vehicle, the amount of available cargo and luggage load capacity is 650 lbs.:

$$1,400 \text{ lbs.} - 750 \text{ lbs.} = 650 \text{ lbs.}$$
5. Determine the combined weight of luggage and cargo being loaded on the vehicle. That weight may not safely exceed the available cargo and luggage load capacity calculated in step 4.
6. If your vehicle will be towing a trailer, part of the load from your trailer will be transferred to your vehicle. Consult the manual for transporting a trailer to determine how this may reduce the available cargo and luggage load capacity of your vehicle.

Load

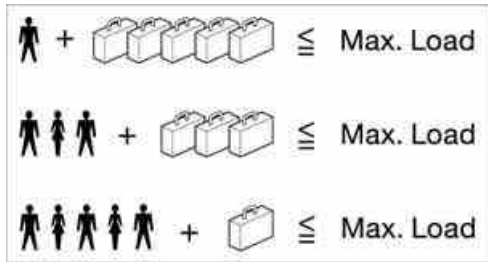

The permissible load is the total of the weight of occupants and cargo/luggage. The greater the weight of the occupants, the less cargo/luggage can be transported.

Stowing cargo

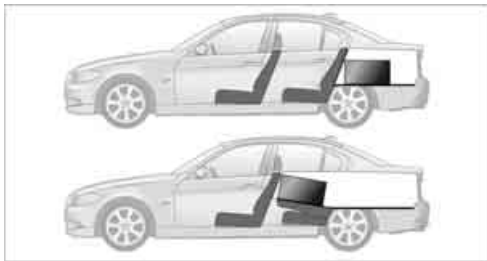

- ▶ Position heavy objects as low and as far forward as possible, ideally directly behind the respective seat backs.
- ▶ Cover sharp edges and corners.
- ▶ For very heavy cargo when the rear seat is not occupied, secure each safety belt in the opposite buckle.

Securing cargo

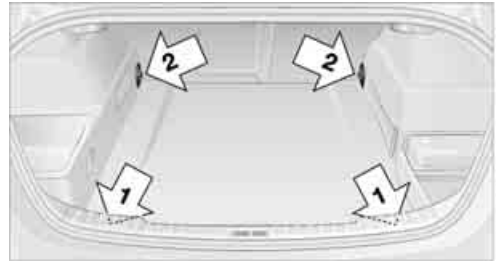

- ▶ Smaller and relatively light items can be retained with tensioning straps or draw straps*.
- ▶ Heavy-duty cargo straps* for securing larger and heavier objects are available at your BMW center. Four lashing eyes are provided for attaching the cargo straps. Two lashing eyes are located on the rear panel of the luggage compartment **1**, two others are on the side panels of the luggage compartment **2**. Comply with the information supplied with the cargo straps.

 Always position and secure the cargo as described above, so that it cannot endanger the car's occupants, for example if sudden braking or swerves are necessary. Never exceed either the approved gross vehicle weight or either of the approved axle loads, refer to page 201, as excessive loads can pose a safety hazard, and may also place you in violation of traffic safety laws. Heavy or hard objects should not be carried loose inside the car, since they could be thrown around, for example as a result of heavy braking, sudden swerves, etc., and endanger the occupants. ◀

Roof-mounted luggage rack*

A special rack system is available as an option for your BMW. Please comply with the precautions included with the installation instructions.

Mounting points

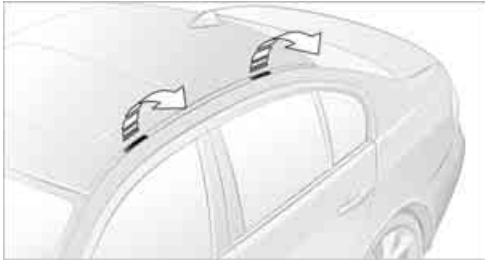

Open the covers.

Loading roof-mounted luggage rack

Because roof racks raise the vehicle's center of gravity when loaded, they have a major effect on vehicle handling and steering response.

You should therefore always remember not to exceed the approved roof load capacity, the approved gross vehicle weight or the axle loads when loading the rack.

You can find the specified weights on page [201](#).

The roof load must be uniformly distributed and should not be too large in area. Heavy items should always be placed at the bottom. Be sure that adequate clearance is maintained for raising the glass sunroof, and that objects do not project into the opening path of the luggage compartment lid.

Secure roof-mounted cargo correctly and securely to prevent it from shifting or falling off during the trip.

Drive smoothly. Avoid sudden acceleration and braking maneuvers. Take corners gently.





Navigation

This chapter describes how you can enter destinations and specify your route so that your navigation system guides you reliably to your destination.

Starting the navigation system*

Your navigation system can use satellites to ascertain the precise position of your vehicle and guide you reliably to any destination you enter.

Navigation DVD

The navigation system requires a special navigation DVD. You can obtain the latest version at your BMW center.

Inserting navigation DVD



1. Insert the navigation DVD with the labeled side up.
2. Wait for several seconds to allow the contents of the DVD to be read in.

Removing navigation DVD

1.  Press button 1.
The DVD emerges slightly from the drive.
2. Remove the DVD.

If the DVD is not ejected from the drive, it is possible that it is blocked.

Display in the assistance window

You can display the route or the current position in the assistance window. This display remains visible even if you change to another application.

1. Move the controller to the right to enter the assistance window.



2. Press the controller.
Other menu items are displayed.
3. Select the desired route view or "Current position".



4. Press the controller.

The contents of the assistance window are continually updated as you drive.

Destination entry

In entering your destination you can select from among the following options:

- ▷ Entering a destination manually, see below
- ▷ Selecting destination using information, refer to page 119
- ▷ Selecting destination from a list, refer to Destination list, page 120
- ▷ Selecting destination from address book, refer to page 121
- ▷ Selecting home address, refer to page 122

After selecting your destination you can proceed to start the destination guidance, refer to page 125.

Operating navigation system

 Enter data only when the vehicle is stationary, and always give priority to the applicable traffic regulations in the event of any contradiction between traffic and road conditions and the instructions issued by the navigation system. If you do not observe this precaution, you may be in violation of the law, and can endanger vehicle occupants and other road users. ◀

iDrive concept, refer to page 16.

1. Press the **MENU** button.
This opens the start menu.
2. Move the controller to the right to call up "Navigation".



3. Select "Navigation" and press the controller.

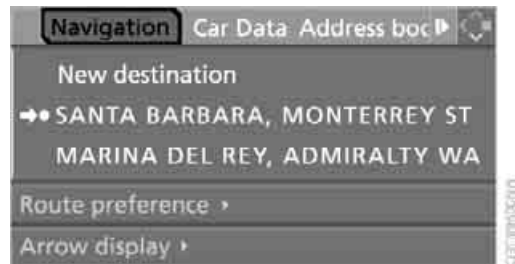

Entering a destination manually

The system's word-matching principle makes it easier for you to enter the names of streets or towns, refer to page 124. This allows you to enter different spellings and completes your entry automatically so that stored names can be called up quickly.

1. Select "Navigation" and press the controller.
"New destination" is selected.
2. Press the controller.



3. Select "Enter address" and press the controller.



The system also supports you with the following features:

- ▷ If you do not enter a street, the system will guide you to the downtown area of a town or city.
- ▷ You can skip the entry of country and locality if the current entries should be retained for your new destination.

Selecting country

1. Select "State / Province" or the country displayed and press the controller. The list of available countries appears on the display.



2. Select the country of destination and press the controller.

In order to be able to start the destination guidance, at least the town/city of the destination or its zip code must be entered.

Entering destination

1. Select "Town / City" or the town/city displayed and press the controller.
2. Select the starting letter and press the controller.

A list of all towns/cities starting with this letter appears on the Control Display.

3. If necessary, input more letters. The list gradually grows smaller each time you enter a new letter.



- ▷ To enter spaces: Select the _ symbol and press the controller.
 - ▷ To delete individual numbers or letters: Move the controller toward the right to select ←, and press the controller.
 - ▷ To delete all numbers or letters: Move the controller toward the right to select ←, and hold the controller down.
4. If necessary, move the controller backwards until the third field from the top is highlighted. Turn the controller until the city or town name is selected from the list and press the controller.

Inputting destination by zip code

1. Select "Town / City" and press the controller.
2. Input the zip code:
Select the desired digits and press the controller.



- ▶ To enter spaces:
Select the _ symbol and press the controller.
 - ▶ To delete individual numbers or letters:
Move the controller toward the right to select ←, and press the controller.
 - ▶ To delete all numbers or letters:
Move the controller toward the right to select ←, and hold the controller down.
3. Select the zip code and press the controller. The corresponding destination is displayed.
 4. If necessary, move the controller backwards until the third field from the top is highlighted. Turn the controller until the destination is selected and press the controller.

Entering street, house number and intersection

1. Select "Street" or the street displayed and press the controller.
2. Enter the street.
The street is entered in the same manner as the town or city.



After the street you can also enter the intersection or the house number.

The intersection is entered in the same way as the street.

To enter the house number:

1. Select "House number" and press the controller.
2. To enter the house number:
Select the desired digits and press the controller.
 - ▶ To enter spaces:
Select the _ symbol and press the controller.
 - ▶ To delete individual numbers or letters:
Move the controller toward the right to select ←, and press the controller.
 - ▶ To delete all numbers or letters:
Move the controller toward the right to select ←, and hold the controller down.
3. If necessary, move the controller backwards until the third field from the top is highlighted. Turn the controller until the house number is selected and press the controller.
Only house numbers stored for the street on the navigation DVD can be entered.

Starting destination guidance with manual destination entry

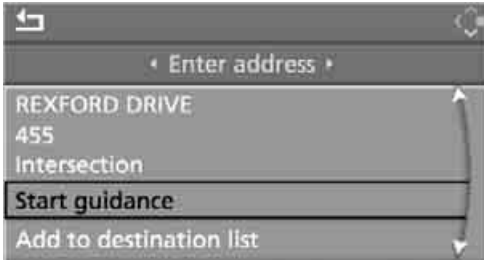

Select "Start guidance" and press the controller.

Destination guidance starts immediately.

If you do not want to start destination guidance right away:

Select "Add to destination list" and press the controller.

The destination is stored in the destination list, refer to page 120.

Map-guided destination selection

If you only know the location of the town or street of the destination, then you can input the destination by using a map. You can use the cursor to localize the destination on the map and then adopt it for destination guidance.

1. Select "Navigation" and press the controller.
"New destination" is selected.
2. Press the controller.



3. Select "Input map" and press the controller.

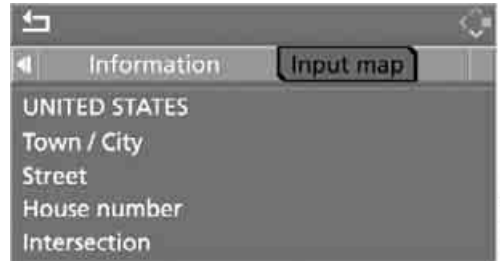

A section of a map is displayed on the Control Display:

- ▷ During destination guidance, around the current destination
- ▷ With the destination guidance deactivated, around the last destination entered



4. Turn the controller to adjust the scale.
To move the map, move the controller in the desired direction.
The controller can be moved to the left, right, forwards, backwards and also diagonally.
5. Press the controller to adopt it for destination guidance or to store it.
The selected destination and other menu items are displayed.

6. Select the desired menu item:
 - ▷ "Start route guidance" starts destination guidance.
 - ▷ "Show current position" places your current position at the center of the map.
 - ▷ "Show destination position" places the current destination at the center of the map.
 - ▷ "Return to map" changes back to the "Input map".
 - ▷  Exit the menu.

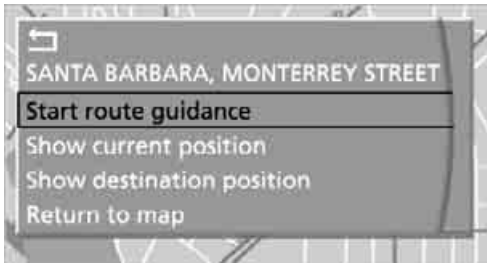

7. Press the controller.

The map for destination entry can also be called up in the map display:
 Select the  symbol and press the controller.

Selecting destination using information

You can obtain a display of selected destinations, e.g. hotels, sights or hospitals, and adopt them for destination guidance.

1. Select "Navigation" and press the controller.
 "New destination" is selected.
2. Press the controller.

3. Select "Information" and press the controller.

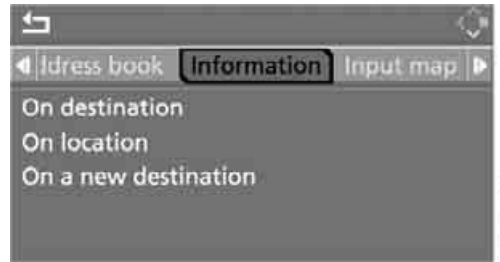

4. Selecting location:
 - ▷ "On destination"
 - ▷ "On location"
 - ▷ "On a new destination"

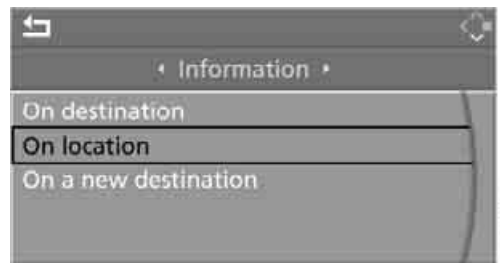

5. Press the controller.
6. Make your selection, e.g. "Hotels and restaurants", and press the controller.
 Destinations appear on the Control Display, which are sorted alphabetically or according to distance.



7. Select a destination and press the controller.
8. Select a menu item:
 - ▷ To transfer the address to the destination list and start destination guidance:

Select "Select as destination" and press the controller.

- ▷ To establish a telephone connection: Select "Call" and press the controller.

To exit from the menu:

Select the  arrow and press the controller.

Destination list

The last 20 destinations entered into the system are shown in the destination list. You can call up these destinations and adopt them for destination guidance.

If you are planning a longer journey, for example, you can store all the destinations you wish to drive to in the destination list in advance, refer to Entering a destination manually on page 115.

Select "Navigation" and press the controller.



The destination last entered is listed first in the destination list.

➡ This symbol indicates the current destination.

To show other destinations in the destination list:

Turn the controller.

Adopting destination for destination guidance

1. Select the desired destination from the destination list and press the controller.
2. Select "Start guidance" and press the controller.

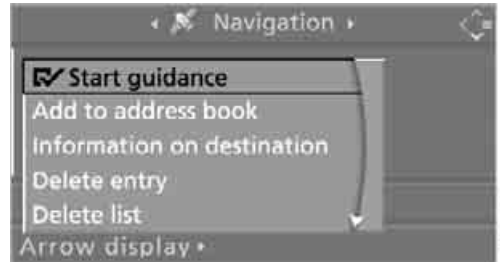

Editing the destination list

1. Select the desired destination from the destination list and press the controller.
2. The selected destination can be edited:
 - ▷ To store the entry: Select "Add to address book".
 - ▷ To display information on the destination: Select "Information on destination".
 - ▷ To delete the entry: Select "Delete entry".
 - ▷ To delete all entries: Select "Delete list". The destination guidance is switched off.
 - ▷ To change the entry: Select "Edit". For operation, refer to Entering destination, page 116.
3. Press the controller.

Address book

Opening address book

iDrive concept, refer to page 16.

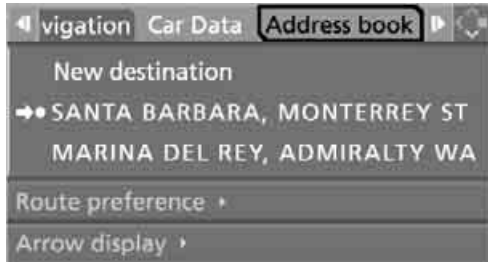

Select "Address book" and press the controller.

Storing destinations in address book

You can store approx. 100 destinations in the address book.

1. Select "Address book" and press the controller.
2. Select "New address" and press the controller.

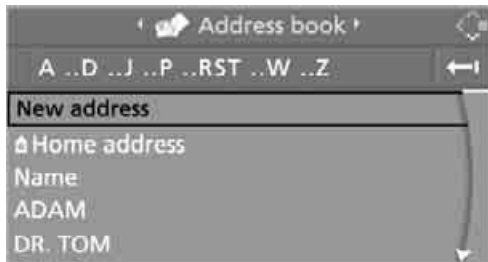

3. Select "Enter address" and press the controller.
4. Input name and address.
5. Select "Store in address book" and press the controller.
The entry is stored in the address book.

You can also store a destination from the destination list in the address book, refer to page 120.

Storing current position

The current position can be adopted into the address book.

1. Select "Address book" and press the controller.
2. Move the controller backwards so that the second field from the top is highlighted. Turn the controller until "New address" is selected and press the controller.

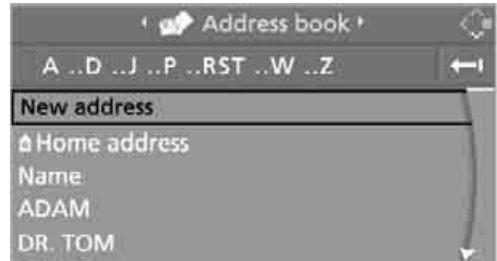

3. Select "Use current location as address" and press the controller.
The name given can be changed. For operation, refer to Entering a destination manually, page 115.
4. Select "Store in address book" and press the controller.

You can also enter your current position into the address book if you have left the area covered by the navigation DVD. In this case, you must enter a name.

Selecting destinations from address book

1. Select "Address book" and press the controller.
The stored entries appear on the Control Display.



2. Select the entry and press the controller.

To start destination guidance:
Select "Start guidance" and press the controller.



3. Select "Delete address" and press the controller.

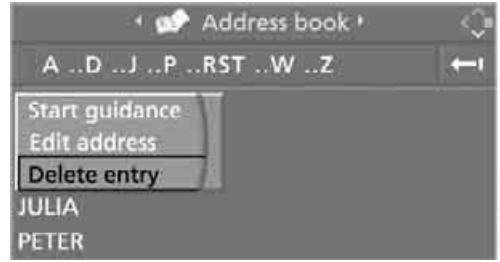

Changing destinations from address book

1. Select "Address book" and press the controller.
2. Select the entry and press the controller.
3. Select "Edit address" and press the controller.

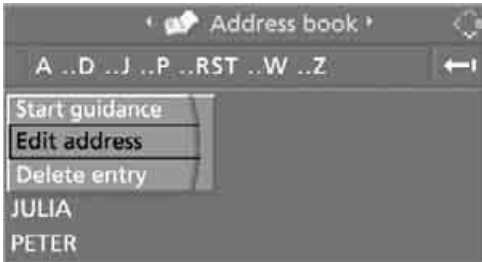

Deleting all destinations from address book

1. Open the start menu.
2. Press the controller to open the **i** menu.
3. Select "Vehicle settings" and press the controller.
4. Select "Delete data" and press the controller.



4. Change entry.
For operation, refer to Entering a destination manually, page 115.

Deleting individual destinations from address book

1. Select "Address book" and press the controller.
2. Select the entry and press the controller.

5. Select "Delete address book" and press the controller.
6. Select "Yes" and press the controller.

Storing home address

You can store your current position or the current destination as the home address in the address book. This entry occupies the second position in the address book.

1. Select "Address book" and press the controller.
2. Move the controller backwards so that the second field from the top is highlighted.

Turn the controller until "Home address" is selected and press the controller.

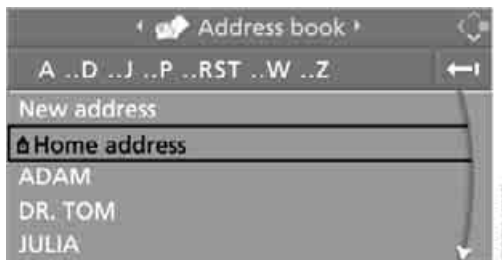

3. Select "Use current location as address", or "Save current destination" during the destination guidance, and press the controller.

In order to accept the home address as the destination:

1. Select "Home address" and press the controller.
2. Select "Start guidance" and press the controller.

To change the entry:

1. Select "Home address" and press the controller.
2. Select "Edit address" and press the controller. For operation, refer to Entering a destination manually, page 115.

Route selecting

You can influence the calculated route by choosing certain route criteria. You can change the route criteria as often as you like during destination entry or during destination guidance.

The route is planned according to fixed rules. The type of road is taken into account, e.g. whether it is a highway or a winding road. The road types are stored on the navigation DVD. As a result, the routes recommended by the navigation system may not always be the same ones that you would choose based on personal experience.

Changing route criteria

1. Select "Navigation" and press the controller.
2. Move the controller backwards so that the third field from the top is highlighted. Turn the controller until "Route preference" is selected and press the controller.

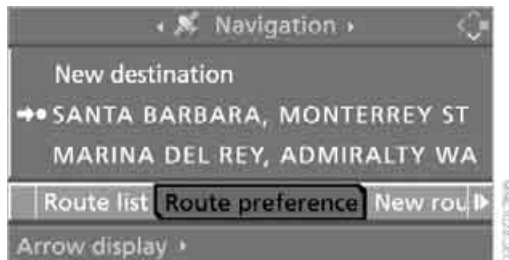

The various criteria are listed on the Control Display.

3. Select a route criterion for the route:
 - ▷ "With highways"
Freeways and major traffic arteries are given priority.
 - ▷ "Avoid highways"
Freeways are avoided as far as possible
 - ▷ "Fast route"
The fast route, being a combination of the shortest possible route and the fastest roads
 - ▷ "Short route"
Short route, irrespective of how fast or slow progress will be
4. Press the controller.



 The route criterion is highlighted.

5. If necessary, select an additional route criterion and then press the controller:
 - ▷ "Avoid tollroads"
Toll roads are avoided as far as possible.
 - ▷ "Avoid ferries"
Ferries are avoided as far as possible.

To exit from the menu:

Select the  arrow and press the controller.

The route criteria can also be changed in the arrow or map display:

Select the corresponding  symbol and press the controller.

Word-matching principle

The system's word-matching principle makes it easier for you to enter the names of streets or towns. The system runs ongoing checks, comparing your destination entries with the data stored on the navigation DVD as the basis for instant response. The benefits for you include:

- ▷ Names of specific locations can also vary from the official versions if you are using a spelling that is customary in another country.

Example:

Instead of the German spelling "München" you can also enter the English spelling "Munich" or the Italian spelling "Monaco".

- ▷ When you are entering the names of towns and streets the system will complete them automatically as soon as enough letters are available to ensure unambiguous identification.
- ▷ The system only accepts name entries beginning with letters that are stored on the navigation DVD. The system will not accept non-existent names and addresses.

Destination guidance

Starting destination guidance

iDrive concept, refer to page 16.

1. Select "Navigation" and press the controller.
2. Select the destination from the destination list and press the controller or enter a new destination, refer to page 115.



3. Select "Start guidance" and press the controller.

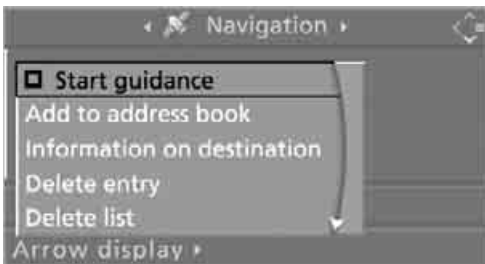

After the route has been calculated, destination guidance is indicated by arrows or a map on the Control Display.

The destination guidance can also be started in the arrow or map display:

Select the  symbol and press the controller.

During destination guidance, you can operate other equipment items at any time via iDrive. You will be notified in time of any necessary change of direction by means of spoken instructions and the display of the direction arrow.

Terminating/continuing destination guidance

In the arrow or map display

Select the  symbol and press the controller.

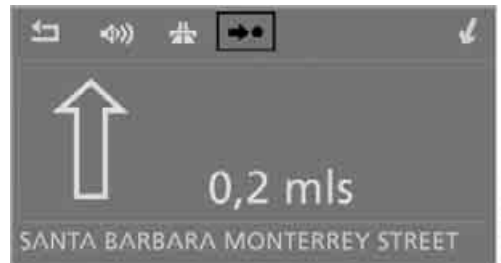

In the destination list

 This symbol indicates the current destination.

1. Select the current destination and press the controller.



2. Select "Start guidance" and press the controller.

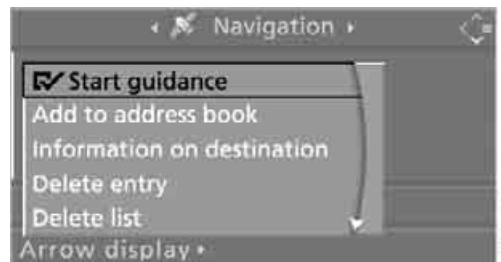

If you did not reach your destination before the end of your last journey, the following question will appear in the display at the start of the next journey:

"Continue guidance to destination?".

The destination guidance starts automatically after a short time.

To start destination guidance immediately: Select "Yes" and press the controller.

Route display

You have the option of displaying various views of the route during destination guidance.

▶ From another menu, you can switch directly to the screen last displayed, refer to Convenient call-up of menu items on page 18. ◀

Displaying arrow view

1. Select "Navigation" and press the controller.
2. Move the controller backwards twice so that the fourth field from the top is highlighted. Turn the controller until "Arrow display" is selected and press the controller.

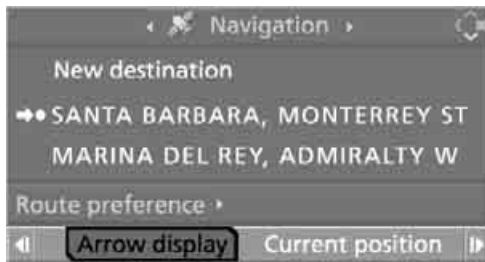

The arrow display is shown.



- 1 Switching voice instructions on/off
 - 2 Selecting route criteria
 - 3 Starting/stopping destination guidance
 - 4 Arrow to destination as the crow flies
 - 5 Distance to the next change of direction
 - 6 Current location
 - 7 Direction of travel
- ▶ Outline of an arrow:
Destination guidance on the calculated route
- ▶ Solid arrow:
Arrow points as the crow flies to the calculated route whenever the vehicle is not in an area recorded on the navigation DVD, e.g. in a parking garage

The arrows change appearance before a change of direction.



- 1 Street name for change of direction
- 2 Distance to change of direction
- 3 Change of direction

To exit from the menu:

Select the back arrow and press the controller.

Displaying map view

You can have your current position displayed on a map. After starting the destination guidance, the planned route is shown on the map.

1. Select "Navigation" and press the controller.
2. Move the controller backwards twice so that the fourth field from the top is high-

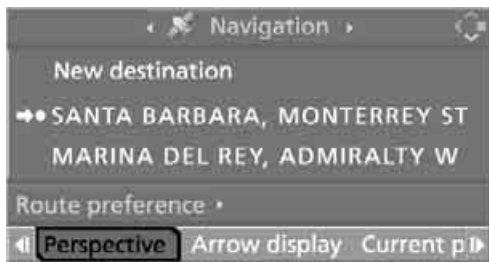

lighted. Turn the controller until the desired map view is selected:

- ▷ "Map facing north"
- ▷ "Map direction of travel"
- ▷ "Perspective"



3. Press the controller.



- 1 Switching voice instructions on/off
- 2 Starting/stopping destination guidance
- 3 Map-guided destination selection
- 4 Showing/hiding information last selected, refer to [Selecting destination using information on page 119](#)
- 5 Changing map view
 - ▷  "Map facing north"
 - ▷  "Map direction of travel"
 - ▷  "Perspective"
- 6 Changing route criteria
- 7 Arrow to destination as the crow flies

To exit from the menu:

Select the  arrow and press the controller.

At scales of less than 300 miles/500 km, you have the option of deciding whether to orient the map to north, toward your current direction of travel, or show the map in perspective. At

scales of 300 miles/500 km or greater, the map always points toward north.

Changing map view



Select the corresponding symbol and press the controller.

The next map view is displayed.

Changing scale

Turn the controller to adjust the scale.

Displaying towns/cities and streets along the route

You can have the roads and towns along the route displayed during destination guidance.

The distances remaining to be traveled within each section of the route are also displayed, as well as directional arrows.

1. Select "Navigation" and press the controller.
2. Move the controller backwards so that the third field from the top is highlighted. Turn the controller until "Route list" is selected and press the controller.



To exit from the menu:

Select the  arrow and press the controller.

Destination guidance through voice instructions

Switching voice instructions on/off

Voice instructions can be switched on or off during the destination guidance in the arrow or

map view:

Select the  symbol and press the controller.

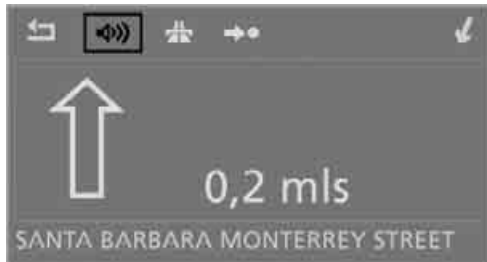

To switch the voice instructions on/off at any time:

1. Open the start menu.
2. Press the controller to open the **i** menu.
3. Select "Display settings" and press the controller.
4. Select "Languages" and press the controller.

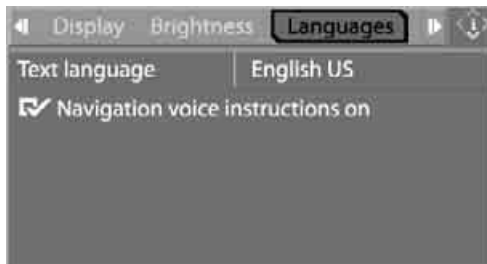

5. Select "Navigation voice instructions on" and press the controller.

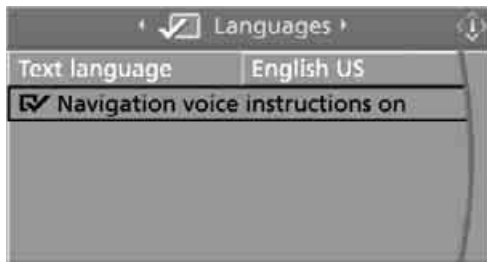

The voice instructions are switched on.

Repeat voice instructions and cancel

With the programmable buttons on the steering wheel, you can also execute the following functions, refer to page 45:

- ▷ Repeat the voice instruction:
Press the button.
- ▷ Switch voice instructions on/off:
Hold the button down.

Adjusting volume of voice instructions

The volume can be adjusted only while a voice instruction is being issued.

1. Repeat the last voice instruction, if necessary.
2. Turn the button during the voice instruction to select the desired volume.

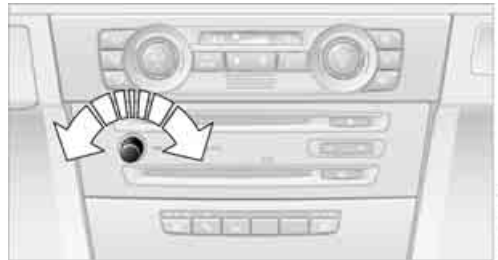

This volume is independent of the volume of the audio sources.

The setting is stored for the remote control currently in use.

Bypassing route sections

During destination guidance, you can revise the navigation system's route recommendations to avoid particular stretches of road. Enter the number of miles/kilometers that you want to travel before returning to the original route.

1. Select "Navigation" and press the controller.
2. Move the controller backwards so that the third field from the top is highlighted. Turn

the controller until "New route" is selected and press the controller.

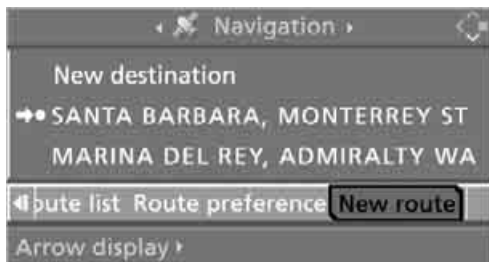

3. Turn the controller to enter the desired number and press the controller.

The route is recalculated.

To exit from the menu without changing the route:

Select the  arrow and press the controller.

Displaying current position

You can have your current position displayed even when the destination guidance is switched off.

1. Select "Navigation" and press the controller.
2. Move the controller backwards twice so that the fourth field from the top is highlighted. Turn the controller until "Current position" is selected and press the controller.

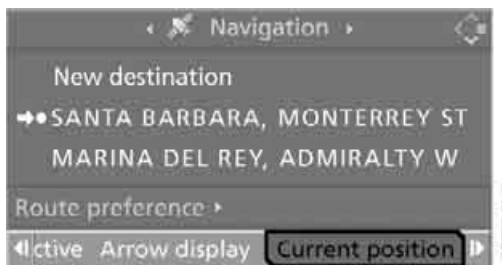

The current position of your BMW is displayed.

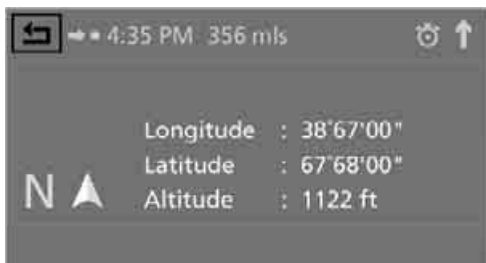

If the navigation system is unable to identify a town or city, your current map coordinates will appear.

To exit from the menu:

Select the  arrow and press the controller.

You can also have the current position displayed on a map, refer to page [126](#).

What to do if ...

What to do if ...

- ▷ a navigation DVD is inserted, but an instruction to insert the DVD appears on the Control Display?

The navigation DVD may not be the correct DVD for the navigation system. This information is indicated on the DVD label.

- ▷ you request the current position of your vehicle, but do not receive a precise display?

The system is unable to receive enough GPS signals at your current position owing to obstructions, your current position is not yet available on your navigation DVD, or the system is in the process of calculating your current position. As a rule, reception is guaranteed when you are in the open.

- ▷ the destination guidance does not accept a destination?

The data of the destination is not stored on the navigation DVD that is loaded. Choose a destination as close as possible to the original one.

- ▷ the destination guidance does not accept an address without the street name?

On the navigation DVD, no downtown area can be determined for the city or town entered. Enter any street, or a destination such as the railway station in the selected town, and then start the destination guidance.

- ▷ you want to enter a destination for the destination guidance, but it is not possible to select the letters for your desired entry?

The data of the destination is not stored on the navigation DVD that is loaded. In this case, the system will not offer you any letters to choose from. Choose a destination as close as possible to the original one.

- ▷ the system stops furnishing directions on which way to turn as you approach intersections?

You are driving in an area that has not yet been completely recorded on the naviga-

tion DVD. Instead of an arrow indicating a turn, you will see an arrow which indicates the general direction of your planned route. Or you have left the recommended route and the system requires a few seconds to calculate a new recommended route.

- ▷ the navigation system does not react to entries?

If the battery was disconnected, it takes about 10 minutes before the system is once again operational.





Entertainment

Operation of the radio and CD equipment as well as their tone settings are described in this chapter.

On/off and settings

The following audio sources have shared controls and setting options:

- ▷ Radio Professional
- ▷ CD player
- ▷ CD changer*

Controls

The audio sources can be operated using:

- ▷ Buttons near the CD player
- ▷ iDrive
- ▷ Buttons on the steering wheel, refer to page 10

Buttons near the CD player

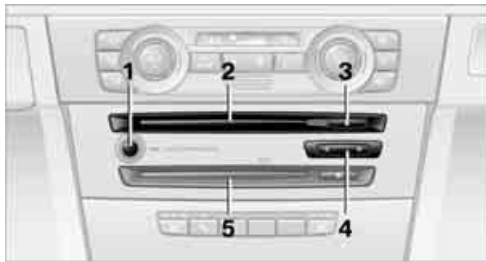

- 1 Sound output for entertainment on/off, volume
 - ▷ Press: switch on/off. When you switch on, the last set radio station or CD track is played.
 - ▷ Turn: adjust volume.
- 2 Drive for audio CDs
- 3 Eject CD
- 4 Station scan/track search
 - ▷ Change radio station.
 - ▷ Select track for CD player and CD changer.
- 5 Drive for navigation DVD

Operation via iDrive

iDrive concept, refer to page 16.

1. Press the **MENU** button. This opens the start menu.
2. Move the controller backwards to call up "Entertainment".



You have the following choices:

- ▷ "FM" and "AM": radio reception
- ▷ "WB": Weather Band station
- ▷ "SAT": satellite radio
- ▷ "CD": CD player or CD changer
- ▷ "Audio Aux": external audio device
- ▷ "Set": depending on the audio source, other adjustments can be made, e.g. with the radio: update station with strongest reception, store station, tone control, sample stations.

From another menu, you can switch directly to the screen last displayed, refer to Convenient call-up of menu items on page 18. ◀

Switching on/off

In order to switch the entertainment sound output on and off:

Press button 1 on the CD player.

This symbol on the Control Display indicates that sound output is switched off.

Adjusting volume

Turn knob **1** on the CD player until the desired volume is obtained.

You can also adjust the volume with buttons on the steering wheel, refer to page **10**.

The setting is stored for the remote control currently in use.

Tone control

You can alter various tone settings, e.g. treble and bass or the speed-dependent volume increase.

The tone settings are applied to all audio sources.

The settings are stored for the remote control currently in use.

Changing tone settings

1. Press the **MENU** button.
This opens the start menu.
2. Press the controller to open the **i** menu.
3. Select "Entertainment settings" and press the controller.



4. Select "Audio" and press the controller.



The tone settings can also be selected if you have called up "Entertainment" in the start menu:

Select "Set" and then "Tone", and press the controller.

Treble and bass

1. Select "Treble / Bass" and press the controller.



2. Move the controller to the left or right to select "Treble" or "Bass".



3. Turn the controller until the desired setting is selected.

Balance and fader

You can adjust the volume distribution in the same manner as "Treble / Bass".

- ▷ "Balance": left/right volume distribution
- ▷ "Fader": front/rear volume distribution

Speed-dependent volume control

The speed-dependent volume control automatically increases the volume with increasing driving speed. You can set various stages for the increase in volume.

1. Select "Speed volume" and press the controller.



2. Turn the controller.
The adjustment is applied; the field can be changed.



Professional LOGIC7 HiFi System*

You can select a spatial sound effect that improves the spatial acoustics in all frequency ranges.

1. Select "LOGIC7" and press the controller.



2. Select "Concert hall" or "Theater".



3. Press the controller.
LOGIC7 spatial sound is switched on.

To switch off the spatial sound effect:
Select "Off" and press the controller.

LOGIC7 and the LOGIC7 logo are registered trade marks of Lexicon, Inc., a company of the Harman International Group.

Equalizer*

You can set individual sound frequency ranges.

1. Select "Equalizer" and press the controller.



2. Move the controller to the left or right to select the desired frequency range.



3. Turn the controller until the desired setting is selected.

Resetting tone settings

You can reset all tone settings to the default setting.

1. Open the start menu.
2. Press the controller to open the **i** menu.
3. Select "Entertainment settings" and press the controller.
4. Select "Audio" and press the controller.
5. Select "Reset" and press the controller.



Radio

Your radio provides reception of the FM and AM wavebands.

Listening to the radio

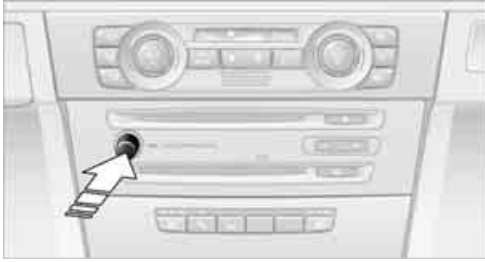

Press the button if the sound output is switched off.

iDrive concept, refer to page 16.

1. Press the **MENU** button.
This opens the start menu.
2. Move the controller backwards to call up "Entertainment".
3. Select "FM" or "AM".



4. Press the controller.

Stations are shown on the Control Display on the basis of various selection criteria, e.g. "Presets".

If "Autostore" does not show a station in the AM waveband or if the displayed stations are no longer receivable, update the stations with the strongest received signal, refer to page 139.

Changing stations



Turn the controller.

In addition to the stations currently displayed, you can have stations with another selection criterion displayed.

You can choose from the following selection criteria:

- ▷ "All stations":
Stations that can currently be received on the "FM" waveband.
- ▷ "Autostore":
The stations with the strongest received signals in the "AM" waveband.
- ▷ "Presets":
Stations you have previously stored, refer to page 140.

Changing selection criteria

1. Move the controller forward to change the field.
2. Choose a selection criterion and press the controller.



Buttons on the CD player

 Press the button for the corresponding direction. The system switches to the next displayed station. You can also change stations with buttons on the steering wheel, refer to page 10.

Sampling stations, scan

The stations on the current waveband are automatically sampled in succession.

1. Select "FM" or "AM" and press the controller. "Set" is selected.
2. Press the controller. Other menu items are displayed.
3. Select "Scan" and press the controller.



Scan starts.

To stop the scan:

1. Press the controller.
2. Select "Scan" and press the controller.

This cancels the scan search, and the radio remains on the current station.

Buttons on the CD player

 To start scan, hold down the corresponding direction button.

To stop scanning, press the button again.

Selecting frequency manually

With "Manual" you can select stations that are received in addition to those displayed.

1. Select "FM" or "AM" and press the controller.
2. Move the controller forward to change the field.
3. Select "Manual" and press the controller.



4. Turn the controller to set a certain frequency.

Updating stations with best reception

If on a longer journey you move out of the reception range of the stations originally received, you can update the list of stations received with the strongest signals in the AM waveband.

1. Select "AM" and press the controller.
2. Move the controller forward to change the field.
3. Select "Autostore" and press the controller. "Set" is selected.



4. Press the controller. Other menu items are displayed.

5. Select "Autostore" and press the controller.



The display of the stations with the strongest reception is updated. The frequencies of the stations are displayed.

Storing stations

1. Select "FM" or "AM" and press the controller.
2. If necessary, move the controller forwards so that the second field from the top is highlighted. Turn the controller until the desired selection criterion is chosen and press the controller.
3. Select the desired frequency or station. "Set" is selected.



4. Press the controller. Other menu items are displayed.

5. Select "Store" and press the controller.



"Presets" is displayed.

6. Turn the controller until the desired memory position is selected. The number of the memory position appears beside the name or frequency of the station.
7. Press the controller. The station is stored.



The channels of the last selection criterion are displayed once again after a short time.

The stations are stored for the remote control currently in use.

Changing a memory position

1. Select "Presets" and press the controller.
2. Select the desired station. "Set" is selected.
3. Press the controller. Other menu items are displayed.

4. Select "Store" and press the controller.



5. Turn the controller until the desired memory position is selected. The number of the memory position appears beside the name or frequency of the station.
6. Press the controller. The station is stored.

RDS Radio Data System

RDS transmits additional information in the FM frequency range. RDS stations have the following properties:

- ▶ In the case of broadcasting networks that transmit over a number of frequencies, there is an automatic switch to the frequency with the best reception quality.
- ▶ If the reception conditions are good, the station names are shown on the Control Display. Where reception is poor or in the event of interference, it may take some time before the station names will appear in the display.

Weather Band*

Weather Radio is a service of the National Oceanic and Atmospheric Administration, NOAA, of the U.S. Department of Commerce. Weather messages are repeated every four to six minutes and are routinely revised every one to three hours, or more frequently if needed. Most of the stations operate 24 hours daily. During severe weather, National Weather Service forecasters can interrupt the routine weather broadcasts and substitute special warning messages. If you have a question concerning NOAA Weather

Radio, please contact your nearest National Weather Service Office, or write to National Weather Service, Attn: W/OM11, National Oceanic and Atmospheric Administration, 1325 East-West Highway Silver Spring, MD 20910.

Selecting Weather Band

1. Select "WB" and press the controller.



2. Select Weather Band station.

The Weather Band station may be unavailable in some regions.

Satellite radio*

You can receive over 100 different channels with high sound quality.

The channels are offered to you in predefined packages. To receive the channels of your choice, you must have this package enabled.

- ▶ You may experience signal drops and muting events related to this new technology. ◀

Enabling or disabling channels

iDrive concept, refer to page 16.

1. Press the **MENU** button. This opens the start menu.
2. Move the controller backwards to call up "Entertainment".

3. Select "SAT".



4. Press the controller.



The channels are displayed.

- ✓ These channels are enabled.

Enabling

1. Select a channel that has not yet been enabled and press the controller. A telephone number and the electronic serial number, ESN, are displayed.

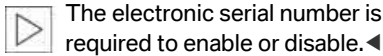

2. To enable the channel: Dial the phone number.

Disabling

1. Select an enabled channel and press the controller.

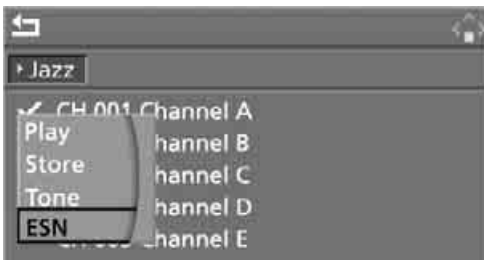

2. Select "ESN" and press the controller. The electronic serial number, ESN, is displayed.

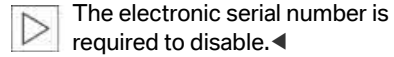

3. To disable the channel: Dial the phone number.

Selecting and storing a channel

1. Select "SAT" and press the controller.



Channels are shown on the Control Display sorted on the basis of selection criteria.

2. Select a menu item:

- ▷ "Presets": Up to twelve channels you have stored previously.
- ▷ "All channels": All channels are displayed.
- ▷ "Categories": All channels, sorted by categories, e.g. news, jazz.

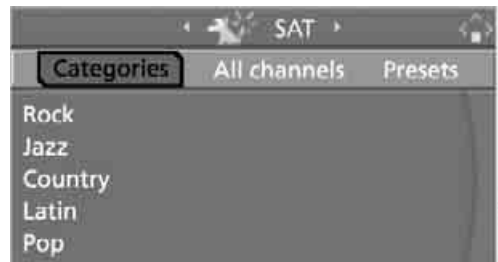

3. Press the controller.

- If "Categories" has been selected:
Select the desired category and press the controller.



The channels of this category are displayed.

- ✓ Select a channel marked with this symbol.

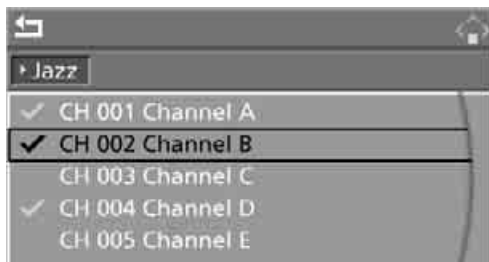

- Press the controller.
Other menu items are displayed.
- Select "Play" and press the controller.

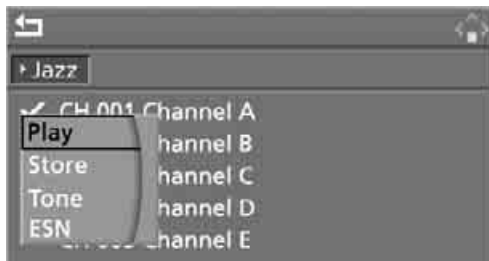

Additional information

The name of the channel and additional information on the current track are displayed, e.g. the name of the artist.



- Artist
- Track

Storing a channel

- Select the desired channel.
- Press the controller.
Other menu items are displayed.
- Select "Store" and press the controller.

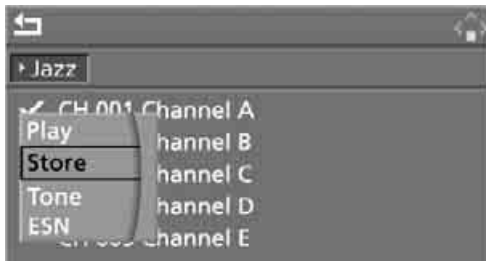

"Presets" is displayed.

- Turn the controller to select a memory location and press the controller.

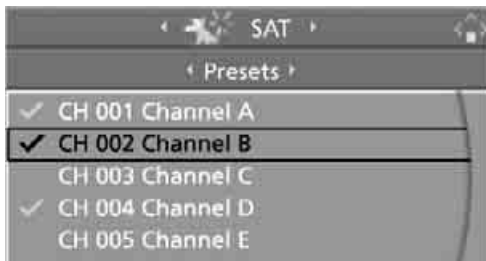

The channel is stored. The channels of the last selection criterion are displayed once again after a short time.

Changing channels with buttons on CD player

 Press the button for the corresponding direction.

The system switches to the next enabled channel.

Notes

When there is a signal blockage or the transmission is suspended momentarily for more than 4 seconds, a message appears on the Control Display.

 Service may be interrupted or unavailable for specific reasons such as environmental or topographic conditions and others that satellite radio cannot directly control. Signal may not be available under tunnels, in parking garages, next to tall buildings, nearby trees with dense foliage, nearby mountains or other possible strong sources of radio interference.

Service should resume normally after the source of signal unavailability has been cleared. ◀

CD player and CD changer*

Listening to CDs

Starting the CD player



When equipped with two drives:
The upper drive is for audio CDs.

Insert the CD into the drive with the labeled side up.

Playback starts automatically if the sound output is on.

To start playback when there is already a CD in the drive:

iDrive concept, refer to page 16.

1. Press the **MENU** button.
This opens the start menu.
2. Move the controller backwards to call up "Entertainment".
3. Select "CD" and press the controller.



4. On cars with a CD changer, select "CD" and press the controller to start the CD player.

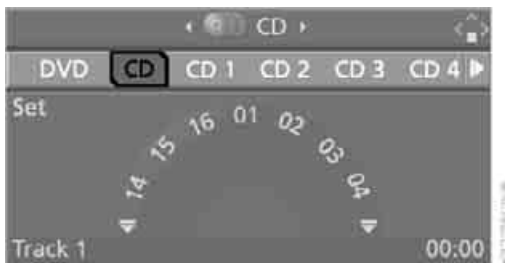

Playback starts automatically if the sound output is switched on.

Starting the CD changer

1. Fill the CD magazine and insert, refer to page 147.
2. Press the **MENU** button.
This opens the start menu.
3. Move the controller backwards to call up "Entertainment".
4. Select "CD" and press the controller.
5. Select the desired CD and press the controller.

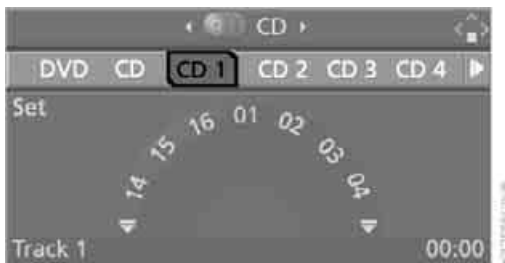

At the end of the last track, the next CD is selected and played.

If new CDs have been placed in the CD magazine, playback starts with the lowest CD, e.g. CD 1, track 1.

The CD magazine's load status is indicated on the Control Display.

Selecting a track

Buttons on the CD player

Press the ◀ ▶ button for the appropriate direction as often as necessary until the desired track on the current CD is reached.

The CD starts to play at the start of the track. The track is displayed on the Control Display.

You can also change the track with buttons on the steering wheel, refer to page 10.

Via iDrive

Turn the controller to select a track.



Sampling tracks, Scan

All tracks on the current CD are automatically sampled once in succession.

1. Select "Set" and press the controller. Other menu items are displayed.



2. Select "Scan" and press the controller.

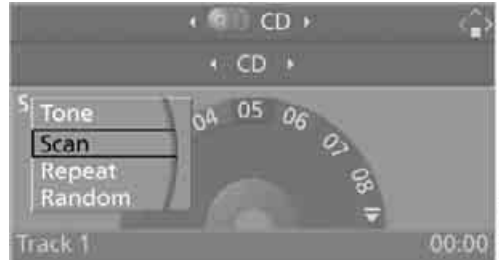

To stop the scan:

1. Press the controller.
2. Select "Scan" and press the controller.

Scan is interrupted and the selected track is retained.

Repeating tracks

1. Select "Set" and press the controller. Other menu items are displayed.



2. Select "Repeat" and press the controller.

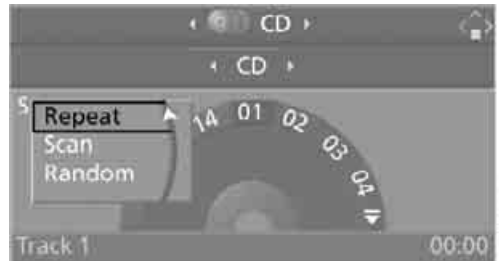

The current track on the CD is repeated.

Stop repeating:

1. Press the controller again.
2. Select "Repeat" and press the controller.

Random play sequence

The tracks on the current CD are played once each in random order.

1. Select "Set" and press the controller. Other menu items are displayed.
2. Select "Random" and press the controller.

Stop random function:

1. Press the controller.
2. Select "Random" and press the controller.

Fast forward/reverse

Buttons on the CD player:

 Press and hold the button for the corresponding direction.

The tracks can be heard, but reproduction is distorted.

CD magazine



The BMW CD changer for six CDs is behind the left side panel in the luggage compartment.

Removing the CD magazine

To insert or remove CDs from the CD magazine, you must first remove it from the CD changer:

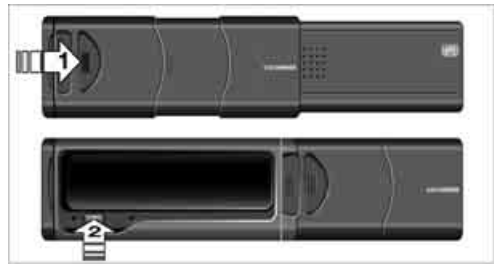

1. Push the cover to one side, arrow 1.
2. Press the button, arrow 2. The CD magazine is ejected.

Inserting/removing CDs from the CD magazine



When loading CDs into or removing them from the CD magazine, hold them at the edge and do not touch the reflective signal-sensing area.

Inserting CDs:

Insert the CD in its slot with the label side on top.

Removing CDs:

Pull out the desired drawer, refer to arrow, and remove the corresponding CD.

Inserting the CD magazine

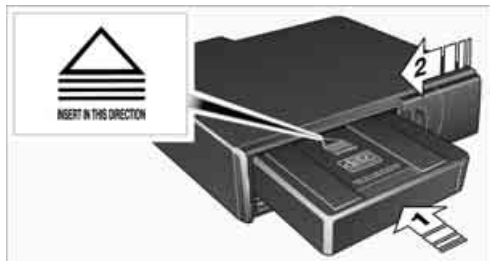

Insert the CD magazine all the way in the direction of arrow **1** and close the cover, arrow **2**.

The CD changer automatically reads in the loaded CDs and is then ready for operation.

Notes

⚠ BMW CD/DVD players and changers are officially designated Class 1 laser products. Do not operate if the cover is damaged, otherwise severe eye damage can result.

Do not use self-recorded CDs/DVDs with labels applied as these can become detached during playback due to heat build-up and can cause irreparable damage to the device.

Only use round CDs/DVDs with a standard diameter of 12 cm and do not play CDs/DVDs with an adapter, e.g. Single-CDs, otherwise the CDs or the adapter can jam and will no longer eject.

Do not use a combined CD/DVD, e.g. DVD^{Plus}, as otherwise the CD/DVD can jam and will no longer eject. ◀

General malfunctions

BMW CD/DVD changers and players have been optimized for performance in vehicles. In some instances they may be more sensitive to faulty CDs/DVDs than stationary devices would be.

If a CD/DVD cannot be played, first check if it has been inserted correctly.

Humidity

High levels of humidity can lead to condensation on the CD/DVD or the laser's scan lens and temporarily prevent playback.

Malfunctions with individual CDs/DVDs

If malfunctions only occur with individual CDs/DVDs, one of the following factors may be the cause.

Self-recorded CDs/DVDs

Possible reasons for malfunctions with self-recorded CDs/DVDs are, e.g., inconsistent data-creation or recording processes, or poor quality or high age of the CD/DVD blank.

Only label CDs/DVDs on the top, with a pen designed for this purpose.

Damaged CDs/DVDs

Avoid leaving fingerprints, as well as dust, scratches or moisture on the CDs/DVDs. Keep CDs/DVDs in protective sleeves or cases. Do not subject CDs/DVDs to temperatures over 50 °C, high levels of humidity or direct sunlight.

CDs/DVDs with copy protection

CDs/DVDs are often copy-protected by the manufacturer. This can mean that some CDs/DVDs cannot be played or can only be played to a limited extent.

External audio device

You can connect an external audio device, for instance an MP3 player, and play audio tracks over the car's loudspeaker system. You can adjust the tone using iDrive.

Connecting

Lift up the center armrest.



- 1 Power supply for your external audio device:
Socket with removable cap
- 2 Connection for audio playback:
3.5 mm phono connector

To play audio tracks through the car's loudspeaker system, connect the headset or line-out port of the external device to connection **2**.

Starting audio playback

The audio device must be switched on.
iDrive concept, refer to page [16](#).

1. Press the **MENU** button.
This opens the start menu.
2. Move the controller backwards to call up "Entertainment".

3. Select "Audio Aux" and press the controller.



4. Adjust volume and tone, if necessary.



Communications

This chapter describes how to use BMW Assist and TeleService.

Telephoning

Safety notes

For your own safety

A car phone makes life more convenient in many ways, and can even save lives in an emergency. While you should consult your portable phone's separate Owner's Manual for a detailed description of safety precautions and information, we request that you direct your particular attention to the following:

Adjustments

 Only make entries when the traffic situation allows you to do so. Do not hold the portable phone in your hand while you are driving; use the hands-free system instead. If you do not observe this precaution, your being distracted can endanger vehicle occupants and other road users.

BMW discourages the use of portable phones or other mobile communications devices inside the vehicle without a direct connection to an outside antenna. Otherwise, interferences between vehicle electronics systems and the mobile communication device cannot be ruled out. Moreover, there is no guarantee that the radiation generated when such devices are transmitting will be dissipated out of the vehicle's interior. ◀

Care instructions

You can find what you need to know about caring for your portable phone in the separate Caring for your vehicle brochure and in the portable phone Owner's Manual.

Operating options

You can operate the portable phone* using:

- ▷ The steering wheel, refer to page 10
- ▷ iDrive, refer to page 153

- ▷ Voice commands, refer to page 156

You can get information about activating the portable phone in the separate Owner's Manual for the Full Preparation Package Cellphone.

Making calls with the car phone: BMW Assist calls

You can use the car phone via the hands-free system for BMW Assist calls.

When the status information "BMW Assist" or "BMW Service" is displayed in "Communication", only BMW Assist calls are possible.

It may not be possible to establish a telephone connection using the portable phone while a connection is being established to BMW Assist or while a call to BMW Assist is already in progress. If this happens, you must unpair the portable phone and the vehicle if you wish to place a call with the portable phone.

Hands-free system

The hands-free microphone is located on the headliner.

The hands-free system is activated whenever you establish or receive a call using:

- ▷ The buttons on the steering wheel
- ▷ iDrive
- ▷ Voice commands

Adjusting volume

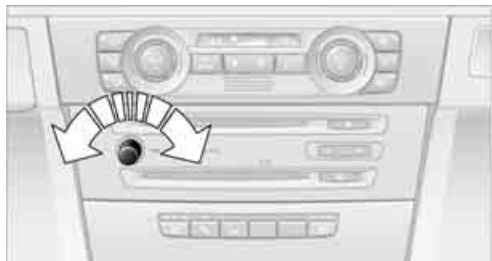

Turn the knob during a call to select the desired volume.

This volume for the hands-free system is maintained, even if the other audio sources are set to minimum volume.

The setting is stored for the remote control currently in use.

Operation via iDrive

Once the portable phone is connected to the vehicle via Bluetooth, the following functions can be used via iDrive:

- ▷ Dialing phone numbers
- ▷ Phone book
- ▷ Top 8
- ▷ Redialing
- ▷ Displaying accepted calls
- ▷ Displaying missed calls

iDrive concept, refer to page 16.

1. Press the **MENU** button.
This opens the start menu.
2. Move the controller forwards to call up "Communication".

Receiving calls

If you have the phone number of the caller stored in the phone book and the phone number is transmitted, the name of the entry is displayed.

Accepting a call



Select "Accept" and press the controller.

Rejecting a call

Select "Reject" and press the controller. The caller is diverted to your mailbox if it has been activated.

Calling

Dialing phone numbers

1. Select "Phone" and press the controller.

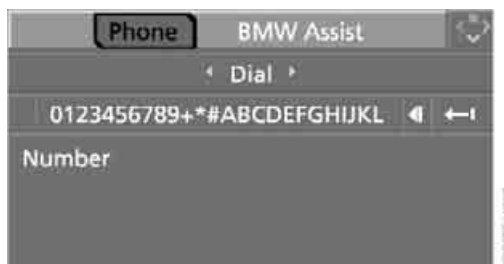

2. Select "Dial" and press the controller.
3. To enter the phone number: select digits or letters individually and press the controller. Always enter the complete phone number consisting of national dialing code, area code, and phone number.

The letters correspond to the numbers on the keypad of the portable phone.

To delete an incorrect number or letter: Move the controller towards the right to select , and press the controller.

4. Select "Dial number" and press the controller.



Ending a call

1. If necessary, select the telephone number.



2. Press the controller.
Additional menu items are displayed when the hands-free system is switched on.
3. Select "End call" and press the controller.



Phone book

Once the portable phone is connected to the vehicle via Bluetooth, the phone book is transmitted from the portable phone to the vehicle. Loading the phone book can take several minutes.

Dialing from phone book

1. Select "Phone" and press the controller.



2. Select "A - Z" and press the controller:
The entries in the phone book of the portable phone are displayed on the Control Display; they are sorted alphabetically.
To run a targeted search for an entry, select the first letter of the entry and press the controller.
The first entry that starts with this letter is displayed.
3. Select the desired entry.



4. Press the controller.
Other menu items are displayed.
5. Select "Call" and press the controller.
The system dials the number.

If different phone numbers are stored in the portable phone under one name, e.g. office and home, the name is shown once for each phone number.

Adding digits to phone numbers

You can add other digits to a phone number stored in the phone book, e.g. to call a specific extension:

1. Select "Phone" and press the controller.
2. Select "A - Z" and press the controller.
3. Select the desired entry.
4. Press the controller.
Other menu items are displayed.
5. Select "Add digits" and press the controller.
6. To add to the phone number: select digits individually and press the controller.
7. Select "Dial number" and press the controller.

Lists

Your phone can store phone numbers you have dialed and incoming calls in lists. If the caller is entered in the phone book, the name of the entry is displayed instead of the phone number. You can select the desired subscriber from the list and establish the connection.

Four lists are available:

- ▷ "Top 8"
The eight numbers called most frequently via the "A - Z" list are automatically stored in the Top 8 list. The number called most often appears at the top of the list.
- ▷ "Redial"
The last eight phone numbers you have dialed are automatically stored. The last number dialed is at the top of the list.
- ▷ "Received calls"
The phone numbers of the last eight calls accepted while the portable phone was connected to the vehicle via Bluetooth are stored. This requires the telephone number of the caller to have been sent.
- ▷ "Missed calls"
The phone numbers of the last eight calls missed while the portable phone was connected to the vehicle via Bluetooth are stored. This requires the telephone number of the caller to have been sent.

Dialing from a list

To select an entry and establish a connection:

1. Select "Phone" and press the controller.
2. Select the list:
 - ▷ "Top 8"
 - ▷ "Redial"
 - ▷ "Received calls"
 - ▷ "Missed calls"



3. Press the controller.
4. Select the desired entry.



5. Press the controller.
Other menu items are displayed.
6. Select "Call" and press the controller.
The system dials the number.

Deleting an individual entry

1. Select the desired entry from the list.
2. Press the controller.
Other menu items are displayed.

3. Select "Delete" and press the controller. The entry is deleted.



Deleting the entire list

1. Select an entry from the list.
2. Press the controller. Other menu items are displayed.
3. Select "Delete all numbers" and press the controller. The list is deleted.



Touch tone dialing

Touch tone numbers are required for access to network services or for controlling devices, e.g. for remote querying on an answering machine.

This function can only be used during an existing connection.

1. Establish connection.



2. Press the controller. Other menu items are displayed.
3. Select "Keypad" and press the controller.
4. Select the desired digits or letters* and press the controller. The letters correspond to the numbers on the keypad of your portable phone. Each digit is sent immediately.



Operation by voice*

The concept

You can operate your portable phone without having to remove your hands from the steering wheel. The system operates on the basis of voice commands that you will learn easily after using them a few times. In addition, you are also supported by instructions or questions.

Symbols used

- >...< Indicates voice commands.
- >>...<< Indicates system announcements.

Saying commands

With the ignition switched on:

1. Press the button on the steering wheel. A sound signal indicates operating readiness.

2. Say voice commands.

To have the system list the voice commands possible in each case:

- >Options<.

Canceling operation by voice

Press  button on steering wheel
or

 ›Cancel‹.

In dialogs where text is spoken, e.g. a name rather than a command, canceling is only possible using the  button. The dialog is automatically interrupted when an incoming call is received.

Voice commands

In addition to the commands described in this Owner's Manual, alternative commands are often possible for the same functions, e.g.:

 ›Dial name‹ or ›Name‹.

The system recognizes digits from zero to nine. You can say each digit individually or group them into a sequence of three to five digits to accelerate the input.

Example: Dialing phone numbers

Start the dialog:

Press the  button on the steering wheel.

Voice command	Response
›Dial number‹	››Please say the number‹‹
e.g. ›123 456 7890‹	››123 456 7890. Continue?‹‹
›Dial‹	››Dialing number‹‹

Adjusting volume

You can adjust the volume for the instructions from the system:

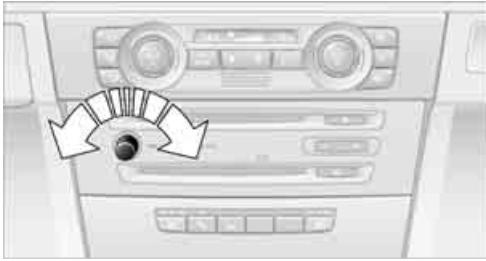

Turn the button during an instruction to select the desired volume.

This volume for the instructions is maintained, even if the other audio sources are set to minimum volume.

The setting is stored for the remote control currently in use.

Calling

Dialing phone numbers

- ›Dial number‹ .
The dialog for establishing a telephone connection is opened.
- Say the phone number.
For telephone calls abroad, say ›Plus‹ and then the country code.
- ›Dial‹ .
The connection to the desired subscriber is established.

Correcting phone numbers

After the last spoken sequence of digits has been repeated by the system, you can delete this sequence of digits.

-  ›Correct number‹ .
The digits are deleted.

The command ›Correct number‹ can be repeated as often as you like.

Deleting input

›Delete‹ is used to delete all the digits entered so far.

Voice phone book

Operating by voice command requires a personal voice phone book.

The entries must be made by speaking them out loud and they are independent from your portable phone's memory. This means that it is not possible to use voice commands to call phone numbers stored in the portable phone or to store new numbers there.

Storing an entry

An entry always consists of a name and phone number.

1. ›Save name‹.
The dialog for storing a name is opened.
2. Say the name and repeat it upon request.
The spoken length of the names in the phone book must not exceed approx. 2 seconds.
3. Say the phone number when prompted.
4. To store the phone number:
›Save‹.

Selecting an entry

The connection to the phone number of the selected entry is established.

1. ›Dial name‹.
The dialog for selecting an entry is opened.
2. Say the name when prompted.
3. Confirm the prompt with ›Yes‹.

Having entries read aloud and selecting

You can have all the entries of your voice phone book read aloud in the order of input and select a certain entry to establish a connection:

1. ›Read phone book‹.
The dialog for having the phone book read is opened.
2. ›Dial number‹ when the desired entry is read aloud.

Redialing

The ›Redial‹ command calls up "Redial".

Deleting an entry

You can delete any entry from the voice phone book.

1. ›Delete name‹.
The dialog for deleting an entry is opened.
2. Say the name when prompted.
3. Confirm the prompt with ›Yes‹.

Deleting all entries

›Delete phone book‹ deletes all entries in the phone book.

1. ›Delete phone book‹.
The dialog for deleting phone book is opened.
2. Confirm the prompt with ›Yes‹.
3. Confirm the repeated prompt with ›Yes‹.

Notes

 The voice commands in English were available as of this printing. Other languages are currently in preparation. To operate the portable phone via the voice command system, refer to page 22. ◀

Important for voice commands

For voice commands, bear in mind the following:

- ▶ Issue the commands smoothly and at normal volume, avoiding excessive emphasis and pauses.
- ▶ Keep the doors, windows and glass sunroof closed to prevent interference from ambient noise.
- ▶ Avoid other sources of noise in the vehicle while speaking, and ask other vehicle occupants to refrain from talking while you are using the system.

TeleService* , BMW Assist*

TeleService

TeleService supports you when communicating with a BMW center. The built-in car phone can be used to transmit data regarding the service status of your vehicle or regarding legally mandated inspections directly to your BMW center. This is the same data that is also stored for CBS Condition Based Service in the master key. Your BMW center can then contact you, and you can make an appointment that suits you while you are still on the road. Your advantage here is that your BMW center can prepare in advance for the required maintenance work. The TeleService functions are country-specific: depending on the country in which you are driving, data about your vehicle's service status or regarding legally required inspections are transmitted to your BMW center either automatically before a service due date or when you place a call to the BMW center. Your BMW center will be glad to provide more detailed information.

BMW Assist

BMW Assist provides you with other services in addition to TeleService. For example, the position data of your vehicle can be transferred to the BMW Assist response center if an emergency call* has been initiated.

Many functions of BMW Assist depend on the individually agreed contract. Data transmission, e.g. of the CBS Condition Based Service, differs from country to country.

The subscriber agreement must be completed successfully before using the BMW Assist services.

You can also utilize BMW Assist services via the Internet. The service package is continually expanded.

Requirements

You can use TeleService or BMW Assist when the following requirements are met:

- ▷ The installed car phone is logged on to a portable telephone network. This network must be capable of transmitting the services.
- ▷ To transmit position data, the vehicle must be able to determine the current position. This can be displayed on the Control Display.
- ▷ In order to enable and update TeleService or BMW Assist, a GPS signal must be present.
- ▷ For BMW Assist: you must have applied for BMW Assist at your BMW center or BMW customer service.

Enabling TeleService or BMW Assist

For you to be able to use the services of TeleService or BMW Assist, these must be enabled.

Requirements

- ▷ Make sure that the vehicle can determine its current location. As a rule, this is possible when you are in the open.
- ▷ Leave radio readiness switched on while connecting to the system.

Enabling

iDrive concept, refer to page 16.

1. Press the **MENU** button.
This opens the start menu.
2. Press the controller to open the **i** menu.
3. Select "Communication settings" and press the controller.

4. Select "BMW Service settings" and press the controller.



5. Select "Service Status" and press the controller.



6. Select "Enable services" and press the controller. TeleService and, if applicable, BMW Assist are enabled; data exchange with the service center starts.

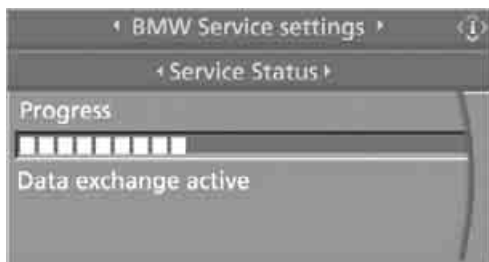

Enabling takes a few minutes. The status is displayed on the Control Display. If you open another menu, the enabling process continues to run in the background.

Services offered

The following special features apply for the services of TeleService and BMW Assist:

- ▷ The services offered are country-specific.
- ▷ Voice contact is established or data are transferred, depending on the equipment and the country. In some countries, it is possible to do both.
- ▷ The data transferred can be the vehicle data, your current position or the data of the CBS Condition Based Service.

Automatic service notification*

The data on the service status of your vehicle or on legally mandated inspections is transmitted automatically directly to your BMW center prior to the due date. You can check when the BMW center was notified.

iDrive concept, refer to page 16.

1. Open the start menu.
2. Press the controller to open the **i** menu.
3. Select "Service" and press the controller.
4. Select "Service requirements" and press the controller.

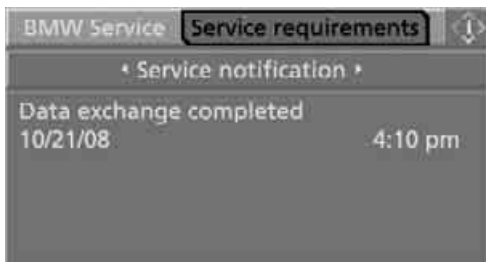

5. Select "Service notification" and press the controller.

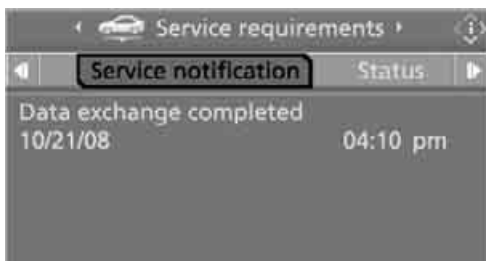

Roadside Assistance

You can call the Roadside Assistance* of the BMW Group should you require help in the event of a breakdown.

iDrive concept, refer to page 16.

1. Press the **MENU** button.
This opens the start menu.
2. Move the controller forwards to select "Communication".
3. Select "BMW Assist" and press the controller.
4. Select "BMW Service" and press the controller.



5. Select "Roadside Assistance" and press the controller.



If the current position can be determined, the current vehicle location is displayed.

6. Select "Start service" and press the controller.

Contact to Roadside Assistance will be established.

To adjust the license plate, please contact your BMW center.

Setting up contact to your BMW center or BMW Customer Relations

You can contact your BMW center, e.g. to arrange a service appointment.

For information related to your vehicle, call the BMW Customer Relations.

A prerequisite for this is that your portable phone is connected to the vehicle.

iDrive concept, refer to page 16.

1. Open the start menu.
2. Press the controller to open the **i** menu.
3. Select "Service" and press the controller.
4. Select "BMW Service" and press the controller.
5. Select the desired BMW center:
 - ▷ "Service Request"
 - ▷ "Customer Relations"



6. Press the controller.
7. Select "Start service" and press the controller.

Contact to the desired BMW center will be established.

Adapting TeleService or BMW Assist

Displaying and updating services

If the services offered by TeleService or BMW Assist change, you will be notified. In this case you should update the service functions.

1. Open the start menu.
2. Press the controller to open the **i** menu.

3. Select "Communication settings" and press the controller.
4. Select "BMW Service settings" and press the controller.
5. Select "Service Status" and press the controller.

The current services available from TeleService or BMW Assist are displayed.

6. If applicable, select "Options" and press the controller.

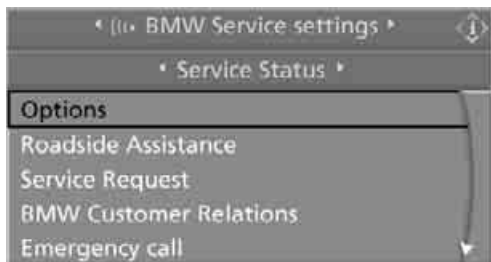

7. Select "Update services" and press the controller.

Terminating services

If you terminate the services, your vehicle will not be equipped to contact the BMW Assist call center.

1. Open the start menu.
2. Press the controller to open the **i** menu.
3. Select "Communication settings" and press the controller.
4. Select "BMW Service settings" and press the controller.
5. Select "Service Status" and press the controller.
6. Select "Options" and press the controller.
7. Select "Terminate services" and press the controller.

The use of TeleService or BMW Assist is blocked. To cancel the service block, the system must be reactivated, refer to page 160. Your contractual agreement is not affected by this.

The automatic service notification can be disabled separately. Please contact your BMW center for this purpose.

Enable TeleService and, if applicable, BMW Assist once again to log on again.

Displaying vehicle data

When TeleService or BMW Assist is activated, the license plate and the vehicle identification number of your vehicle can be displayed.

1. Open the start menu.
2. Press the controller to open the **i** menu.
3. Select "Communication settings" and press the controller.
4. Select "BMW Service settings" and press the controller.
5. Select "Profile" and press the controller.



To adjust the license plate, please contact your BMW center.

BMW Contact*

You can establish a voice connection to the following services without enabling BMW Assist as long as your portable phone is connected to the vehicle:

- ▷ Roadside Assistance* of the BMW Group if you need help in the event of a breakdown
- ▷ BMW Service if you wish to schedule a service appointment, for example
- ▷ BMW Customer Relations for information related to your vehicle

iDrive concept, refer to page 16.

1. Press the **MENU** button.
This opens the start menu.
2. Move the controller forwards to select "Communication".
3. Select "BMW Contact" and press the controller.



4. Select "BMW Contact Numbers" and press the controller.



5. Select one of the following menu items and press the controller:
 - ▷ "Roadside Assistance"
 - ▷ "Customer Relations"
 - ▷ "Service Request"
6. Select "Call" and press the controller.
Contact will be established.

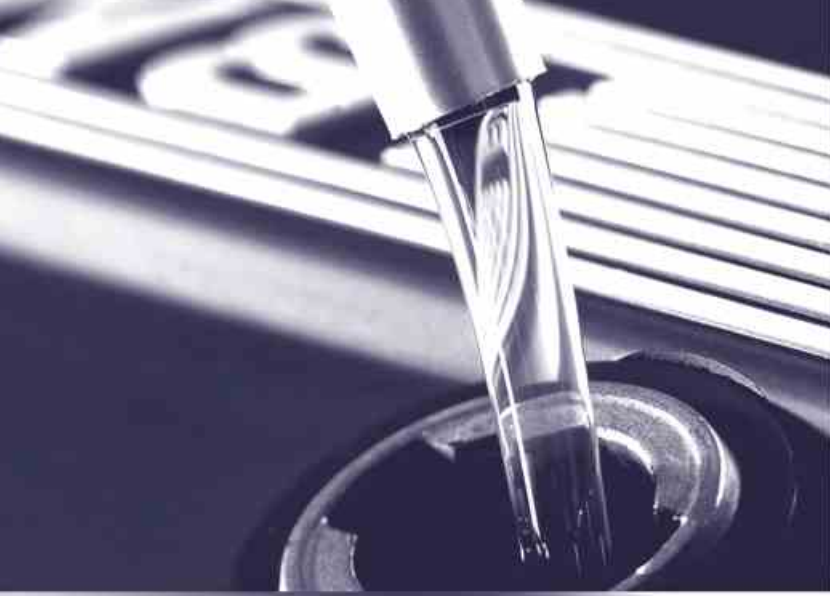



Mobility

This section helps you maintain your car's mobility by supplying important information on vital topics including fuels and lubricants, wheels and tires, service, maintenance and breakdown assistance.

Refueling

⚠ Always switch off the engine before refueling. If you do not, fuel cannot be filled into the tank and a message will appear on the Control Display. ◀

⚠ Always observe all applicable precautions and regulations when handling fuels. Never carry spare fuel containers in your vehicle. Whether empty or full, these containers can leak, cause an explosion, or lead to fire in the event of a collision. ◀

Gas cap

Opening

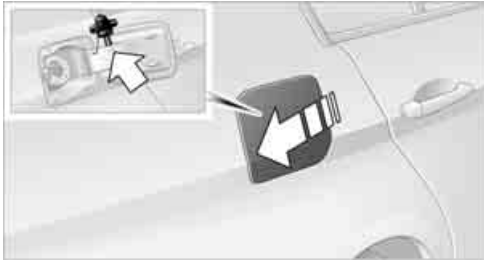

1. Open fuel filler door. To do so, lightly press the rear edge.
2. Turn the gas cap counterclockwise.
3. Place the gas cap in the bracket attached to the fuel filler door.

Closing

Fit the cap and turn it clockwise until you clearly hear a click.

⚠ Close the gas cap carefully after refueling until a click is heard. While closing, be sure not to squeeze the strap which is fastened to the cap. A loose or missing cap will activate an indicator lamp and the message Check Gas Cap* on the Control Display. ◀

Manually releasing the fuel filler door

In the event of an electrical malfunction, you can release the fuel filler door manually:



1. Remove the cover from the side panel of the luggage compartment.
2. Pull the knob with the fuel pump symbol. The fuel filler door is released.

Observe the following when refueling

⚠ When handling fuels always observe any safety guidelines posted at the service station. ◀

When refueling, insert the filler nozzle completely into the filler pipe. Lifting the filler nozzle during refueling leads to

- ▷ premature pump shutoff
- ▷ a reduced efficiency of the fuel-vapor recovery system.

The fuel tank is full when the filler nozzle clicks off the first time.

Fuel tank capacity

Approx. 15.9 gallons/60 liters, including the reserve capacity of 2.1 gallons/8 liters.

⚠ Refuel as soon as possible once your cruising range falls below 30 miles/ 50 km, as otherwise engine functions are not ensured and damage can occur. ◀

Fuel specifications

The engine uses lead-free gasoline only.

Required fuel

Premium Unleaded Gasoline

The minimum octane rating is 91.

If you use gasoline with this minimum octane rating, the engine may produce knocking sounds when starting at high outside temperatures. This has no effect on the engine life.

Minimum octane rating corresponds to the Anti Knock Index AKI and is determined according to the so-called (R+M)/2 method.

 Do not fill the tank with leaded fuel, as this would cause permanent damage to the catalytic converter. ◀

Use high-quality brands

Field experience has indicated significant differences in fuel quality: volatility, composition, additives, etc., among gasolines offered for sale in the United States and Canada. Fuels containing up to and including 10% ethanol or other oxygenates with up to 2.8% oxygen by weight, that is, 15% MTBE or 3% methanol plus an equivalent amount of co-solvent, will not void the applicable warranties with respect to defects in materials or workmanship.

 The use of poor-quality fuels may result in drivability, starting and stalling problems especially under certain environmental conditions such as high ambient temperature and high altitude.

Should you encounter drivability problems which you suspect could be related to the fuel you are using, we recommend that you respond by switching to a recognized high-quality brand.

Failure to comply with these recommendations may also result in unscheduled maintenance. ◀

Wheels and tires

Tire inflation pressure

Information for your safety

It is not merely the tires' service life, but also driving comfort and, to a great extent, driving safety that depend on the condition of the tires and the maintenance of the specified tire pressure.

 Check the tire inflation pressure regularly and correct it, if necessary: at least twice a month and before starting long trips. If you fail to observe this precaution you may be driving on tires with incorrect tire pressures, a condition that can not only compromise your vehicle's driving stability, but also lead to tire damage and the risk of an accident. Do not drive with deflated, i.e. flat tires, except when using Run-Flat Tires. A flat tire will seriously impair your vehicle's handling and braking response. Attempts to drive on a flat tire can lead to loss of control over the vehicle. ◀

Checking pressure

Only check tire inflation pressure when the tires are cold. This means after a maximum of 1.25 miles/2 km driving or when the vehicle has been parked for at least 2 hours. When tires are warm, the tire inflation pressure is higher.

 After correcting tire inflation pressures, always reinitialize the Flat Tire Monitor, refer to page 80. ◀

Inflation pressure specifications for factory-installed tires



The inflation pressures for your factory-installed tires at ambient temperature can be found on the door post when you open the driver's door.

Inflation pressure specifications for other tire sizes

The tables below provide all the correct inflation pressures for the specified tire sizes at ambient temperature.

 The inflation pressures apply to the tire sizes approved and tire brands recommended by BMW; a list of these is available from your BMW center. ◀

For correct identification of the right tire inflation pressures, observe the following:

- ▷ Tire sizes for your vehicle
- ▷ Load conditions
- ▷ Maximum allowable driving speed

Tire inflation pressures for driving up to 100 mph or 160 km/h

For normal driving up to 100 mph or 160 km/h adjust pressures to the respective tire inflation pressures listed on the following pages in the traveling speeds column for normal driving at speeds up to a maximum of 100 mph or 160 km/h to achieve optimum driving comfort.

 The maximum permissible speed for these tire pressures is 100 mph or

160 km/h. Do not exceed this speed, otherwise tire damage and accidents could occur. ◀



Tire inflation pressures for driving above 100 mph or 160 km/h





In order to drive at maximum speeds in excess of 100 mph or 160 km/h, please observe, and, if necessary, adjust tire pressures for speeds exceeding 100 mph or 160 km/h from the relevant table on the following pages. Otherwise tire damage and accidents could occur. ◀

Observe all national and local maximum speed limits, otherwise violations of the laws could occur.



Tire inflation pressures for 325i without Sports package

Tire size	Pressure specifications in psi/kPa					
	Traveling speeds up to a max. of 100 mph / 160 km/h			Traveling speeds including those exceeding 100 mph / 160 km/h		
<p>All pressure specifications in the table are indicated in psi/kilopascal with cold tires. Cold = ambient temperature</p>   						
225/50 R 16 92 V						
205/55 R 16 91 H M+S	29/200	35/240	29/200	35/240	32/220	39/270
225/45 R 17 91 H M+S						
225/45 R 17 94 V M+S XL						
Front: 225/45 R 17 91 V	29/200	-	29/200	-	32/220	-
Rear: 255/40 R 17 94 V	-	32/220	-	32/220	-	35/240
Front: 225/40 R 18 88 W	32/220	-	29/200	-	32/220	-
Rear: 255/35 R 18 90 W	-	35/240		35/240	-	39/270
Front: 225/35 R 19 88 Y XL	35/240	-	32/220	-	35/240	
Rear: 255/30 R 19 91 Y XL	-	39/270	-	35/240		39/270
More details on the permissible load and weights can be found on page 201 .						

Tire inflation pressures for 325i with Sports package*







Tire size	Pressure specifications in psi/kPa					
	Traveling speeds up to a max. of 100 mph / 160 km/h		Traveling speeds including those exceeding 100 mph / 160 km/h			
<p>All pressure specifications in the table are indicated in psi/kilopascal with cold tires. Cold = ambient temperature</p>   						
225/50 R 16 92 V	29/200	35/240	29/200	36/250	35/240	42/290
225/45 R 17 94 V M+S XL						
205/55 R 16 91 H M+S	29/200	35/240	29/200	35/240	32/220	39/270
225/45 R 17 91 H M+S						
Front: 225/45 R 17 91 V	29/200	-	29/200	-	35/240	-
Rear: 255/40 R 17 94 V	-	32/220	-	33/230	-	38/260
Front: 225/40 R 18 88 W	32/220	-	33/230	-	38/260	-
Rear: 255/35 R 18 90 W	-	35/240		36/250	-	42/290
Front: 225/35 R 19 88 Y XL	35/240	-	33/230	-	38/260	
Rear: 255/30 R 19 91 Y XL	-	39/270	-	36/250		42/290
More details on the permissible load and weights can be found on page 201 .						

Tire inflation pressures for 330i without Sports package

Tire size	Pressure specifications in psi/kPa					
	Traveling speeds up to a max. of 100 mph / 160 km/h		Traveling speeds including those exceeding 100 mph / 160 km/h			
All pressure specifications in the table are indicated in psi/kilopascal with cold tires. Cold = ambient temperature						
	225/45 R 17 91 H M+S	29/200	36/250	29/200	36/250	33/230
225/45 R 17 94 V M+S XL						
Front: 225/45 R 17 91 V	29/200	-	29/200	-	33/230	-
Rear: 255/40 R 17 94 V	-	32/220	-	32/220	-	36/250
Front: 225/40 R 18 88 W	32/220	-	32/220	-	36/250	-
Rear: 255/35 R 18 90 W	-	36/250		36/250	-	41/280
Front: 225/35 R 19 88 Y XL	36/250	-	32/220	-	36/250	
Rear: 255/30 R 19 91 Y XL	-	41/280	-	36/250		41/280

More details on the permissible load and weights can be found on page 201.

Tire inflation pressures for 330i with Sports package*

Tire size	Pressure specifications in psi/kPa					
	Traveling speeds up to a max. of 100 mph / 160 km/h		Traveling speeds including those exceeding 100 mph / 160 km/h			
All pressure specifications in the table are indicated in psi/kilopascal with cold tires. Cold = ambient temperature						
						
225/45 R 17 94 V M+S XL	29/200	36/250	32/220	38/260	38/260	45/310
225/45 R 17 91 H M+S	29/200	36/250	29/200	36/250	33/230	41/280
Front: 225/45 R 17 91 V	29/200	-	32/220	-	38/260	-
Rear: 255/40 R 17 94 V	-	32/220	-	35/240	-	41/280
Front: 225/40 R 18 88 W	32/220	-	35/240	-	38/260	-
Rear: 255/35 R 18 90 W	-	36/250		38/260	-	45/310
Front: 225/35 R 19 88 Y XL	36/250	-	35/240	-	38/260	
Rear: 255/30 R 19 91 Y XL	-	41/280	-	38/260		45/310
More details on the permissible load and weights can be found on page 201 .						

Tire identification marks

Knowledge of the labeling on the side of the tire makes it easier to identify and choose the right tires.

Tire size

e.g. 225/45 R 17 91 V

Nominal width in mm

Aspect ratio in %

Radial belt construction

Rim diameter in inches

Load rating, not on ZR tires

Speed code letter, in front of the R on ZR tires

Speed code letter

Q = up to 100 mph or 160 km/h

T = up to 118 mph or 190 km/h

H = up to 131 mph or 210 km/h

V = up to 150 mph or 240 km/h

W = up to 167 mph or 270 km/h

Y = up to 186 mph or 300 km/h

Tire Identification Number

Tires with DOT codes meet the guidelines of the U.S. Department of Transport.

DOT code:

e.g. DOT xxxx xxx 0705

Manufacturer's code for tire make

Tire size and tire design

Tire age

Tire age

The manufacturing date of tires is contained in the tire coding: DOT ... 0705 means that the tire was manufactured in week 7 of 2005.

BMW recommends that you replace all tires after 6 years at most, even if some tires may last for 10 years.

Uniform Tire Quality Grading

Quality grades can be found where applicable on the tire sidewall between tread shoulder and maximum section width. For example:

Tread wear 200 Traction AA
Temperature A

DOT Quality Grades

Tread wear
Traction AA A B C
Temperature A B C



All passenger car tires must conform to Federal Safety Requirements in addition to these grades. ◀

Tread wear

The tread wear grade is a comparative rating based on the wear rate of the tire when tested under controlled conditions on a specified government test course. For example, a tire graded 150 would wear one and one-half (1 ½) times as well on the government course as a tire graded 100. The relative performance of tires depends upon the actual conditions of their use, however, and may depart significantly from the norm due to variations in driving habits, service practices and differences in road characteristics and climate.

Traction

The traction grades, from highest to lowest, are AA, A, B, and C.

Those grades represent the tire's ability to stop on wet pavement as measured under controlled conditions on specified government test surfaces of asphalt and concrete. A tire marked C may have poor traction performance.



The traction grade assigned to this tire is based on straight-ahead braking traction tests, and does not include acceleration, cornering, hydroplaning, or peak traction characteristics. ◀

Temperature

The temperature grades are A, the highest, B, and C, representing the tire's resistance to the generation of heat and its ability to dissipate heat when tested under controlled conditions on a specified indoor laboratory test wheel. Sustained high temperature can cause the material of the tire to degenerate and reduce tire life, and excessive temperature can lead to sudden tire failure. The grade C corresponds to a level of performance which all passenger car tires must meet under the Federal Motor Vehicle Safety Standard No. 109. Grades B and A represent higher levels of performance on the laboratory test wheel than the minimum required by law.

 The temperature grade for this tire is established for a tire that is properly inflated and not overloaded. Excessive speed, underinflation, or excessive loading, either separately or in combination, can cause heat buildup and possible tire failure. ◀

RSC – Run-Flat Tires

You will recognize Run-Flat Tires by a circular symbol containing the letters RSC on the side of the tire, refer to page 178.

M+S

Winter and all-season tires. These have better winter properties than summer tires.

XL

Designation for specially reinforced tires.

Tire condition

Inspect your tires frequently for tread wear, signs of damage and for foreign objects lodged in the tread. Check the tread depth.

Minimum tread depth

The tread depth should not drop below 1/8 in/ 3 mm, although, for example, European legislation only specifies a minimum tread depth of

1/16 in/1.6 mm. At tread depths below 1/8 in/ 3 mm there is an increased risk of high-speed hydroplaning, even when only small amounts of water are present on the road surface.

When winter tires wear down past a tread depth of 1/6 in/4 mm, they become perceptibly less suitable for winter conditions. For the sake of safety, new tires should be installed.

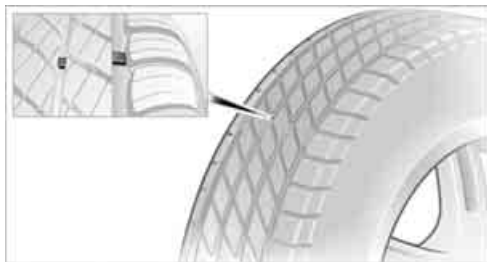

Wear indicators in the base of the tread groove are distributed around the tire's circumference; the letters TWI, Tread Wear Indicator, on the tire's sidewalls identify tires that incorporate these wear indicators. Once the tire tread has worn down to the wear indicators, the tire has worn to a depth of 1/16 in/1.6 mm.

Wheel/tire damage

Please note that low-profile tires cause wheels, tires and suspension parts to be more susceptible to road hazard and consequential damages.

Unusual vibrations encountered during normal vehicle operation can indicate tire failure or some other vehicle defect. This can, for example, be caused by driving over curbs. The same applies to any other abnormal road behavior, such as pulling severely to the right or left.

 In these cases, reduce speed immediately and have wheels and tires thoroughly checked. To do so, drive carefully to the nearest BMW center or tire shop that works according to BMW repair procedures with correspondingly trained personnel. If necessary, have the vehicle towed there.

Tire damage can be extremely dangerous for vehicle occupants and other road users. ◀

Servicing tires

 Unprofessional attempts by laymen to service tires can lead to damage and accidents. Have this work performed by skilled professionals only. The technicians at your BMW center will be glad to assist you with the required professional knowledge and specialized equipment. ◀

Tire age

For various reasons, such as the development of brittleness, BMW recommends tire replacement after no more than 6 years, regardless of the actual wear of the tires.

The manufacturing date of tires is contained in the tire coding:

DOT ... 0705 means that the tire was manufactured in week 07 of 2005.

Run-Flat Tires



The symbol identifying Run-Flat Tires is a circle with the letters RSC on the sidewall.

Run-Flat Tires comprise a conditionally self-supporting tire and a special rim. The reinforcement in the sidewalls ensures that the tire can continue to be used subject to certain restrictions, even if depressurized.

For information on continuing to drive with a flat tire, refer to Indication of a flat tire, page 81.

New wheels and tires

 Have new wheels and tires installed only by your BMW center or tire shop that works according to BMW repair procedures

with correspondingly trained personnel. If this work is not carried out properly, there is a danger of subsequent damage and related safety hazards. Make sure that the new wheels are balanced. ◀

Retreaded tires

 BMW recommends that you do not use retreaded tires, since driving safety may be impaired. The causes for this include potentially different tire casing structures and often wide variations in tire age, which can result in a limited service life. ◀

The right wheels and tires

 BMW recommends that you use only wheel and tire combinations that BMW has tested and approved for your particular vehicle. Variations in factors such as manufacturing tolerances mean that even wheels and tires with identical official size ratings could actually have different dimensions, which could lead to body contact and thus to severe accidents. If non-approved wheels and tires are used, BMW cannot evaluate their suitability, and therefore cannot guarantee their driving safety. ◀

You can inquire about the right wheel/tire combination at your BMW center.

The correct combination of wheels and tires is also necessary to ensure reliable operation of various vehicle systems such as ABS and DSC.

To maintain good handling and vehicle response, use only tires of a single brand and tread configuration. After a tire has been damaged, mount the previous wheel and tire combination again as soon as possible.

Recommended tire brands

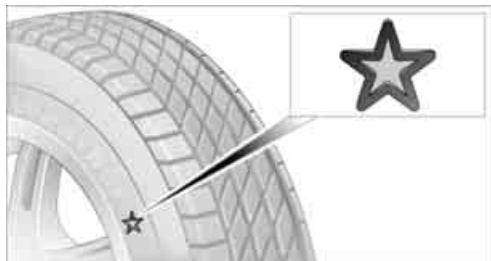

Certain makes of tire are recommended by BMW for each tire size. They are marked with a clearly visible BMW designation on the sidewall of the tire.

When properly used, these tires meet the highest standards in terms of safety and handling characteristics.

Run-Flat Tires

When mounting new tires or changing over from summer to winter tires and vice versa, mount Run-Flat Tires for your own safety. In the event of a flat, moreover, no spare wheel is available. Your BMW center will be glad to advise you.

 For safety reasons, BMW recommends that damaged Run-Flat Tires be replaced rather than repaired. ◀

Special characteristics of winter tires

BMW recommends winter tires for use in cold winter driving conditions. Although all-season M+S tires provide better winter traction than summer tires, they generally fail to provide the same levels of cold-weather performance as winter tires.

Pay attention to speed

 Always comply with the speed limit for the winter tires mounted on your car; failure to do so could result in tire damage and accidents. ◀

If the car is capable of speeds higher than that permitted for the winter tires, a label stating the maximum permitted speed for the mounted tires must be displayed in your field of view.

Specialist tire dealers and your BMW center can supply these labels.

Storage

Always store wheels and tires in a cool, dry place with as little exposure to light as possible. Always protect tires against all contact with oil, grease and fuels. Do not exceed the maximum tire inflation pressure indicated on the sidewall of the tire.

Snow chains*

Only certain fine-link snow chains have been tested by BMW, classified as safe for use and recommended. Consult your BMW center for more information. Attach snow chains in pairs and only to the rear wheels. Observe the manufacturer's instructions when mounting snow chains. Do not exceed a speed of 30 mph or 50 km/h.

You are not permitted to mount snow chains to tires of the following sizes:

- ▷ 255/40 R 17
- ▷ 255/35 R 18
- ▷ 255/30 R 19

 Do not initialize the Flat Tire Monitor if snow chains are mounted, as the instrument might issue an incorrect reading. When driving with snow chains, you may find it helpful to switch on DTC temporarily, refer to page 79. ◀

Under the hood

! Do not work on the car unless you possess the necessary technical knowledge. If you are unfamiliar with the statutory guidelines, have any work on the vehicle performed only by a BMW center or by a workshop that work according to BMW repair procedures with correspondingly trained personnel. If this work is not carried out properly, there is a danger of subsequent damage and related safety hazards. ◀

Hood

Releasing

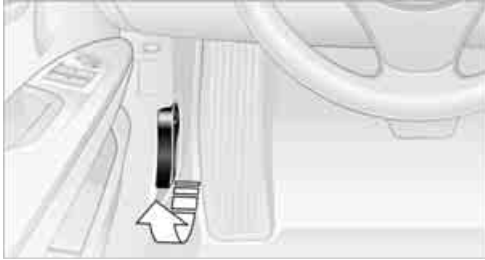

Pull the lever.

Opening



! In order to avoid damage, make sure that the wiper arms are against the windshield before you open the hood. ◀

Press the release handle and open the hood.

Closing

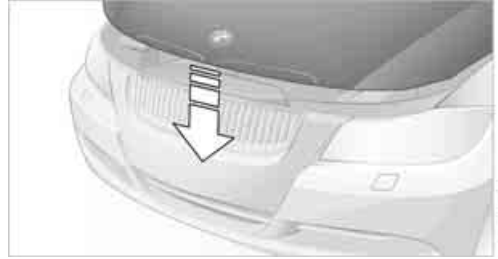

Close the hood from a height of approx. 16 in/ 40 cm with momentum. It must be clearly heard to engage.

! Make sure that the closing path of the hood is clear, as otherwise injuries may result.

If you see any signs while driving your vehicle that the hood is not completely closed, stop at once and close it securely. ◀

Engine compartment

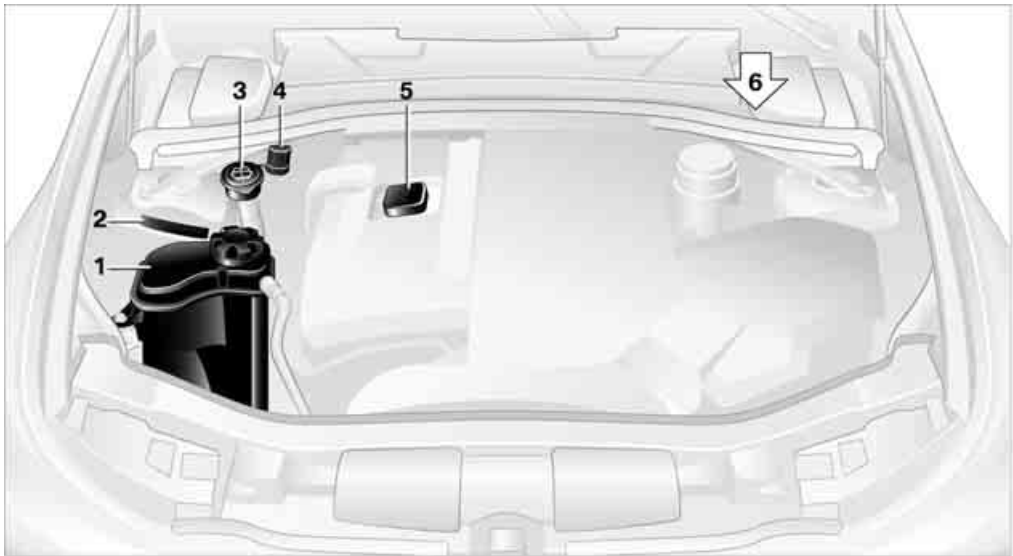

- 1 Expansion tank for coolant, refer to page 183
- 2 Vehicle Identification Number
- 3 Washer fluid reservoir for headlamp cleaning system and windshield washer system, refer to page 55
- 4 Jump-starting connection, refer to page 194
- 5 Filler neck for engine oil, refer to Adding engine oil
- 6 Reservoir for brake fluid, under the cover of the microfilter

Engine oil

The engine oil consumption is dependent on driving style and driving conditions.

Checking oil level

Your car is equipped with an electronic oil-level monitor.

For a precise measurement and display of the oil level, it is necessary that the engine be at operating temperature, e.g. after uninterrupted driving for at least approx. 6.5 miles/10 km. You can have the oil level displayed while you are driving, or while the vehicle is at a standstill on a level surface and the engine is running.

Display in the instrument cluster



1. Lightly push button 1 in the turn indicator stalk repeatedly up or down until the appropriate symbol is shown in the display, accompanied by the word "OIL".
2. Press button 2 in the turn indicator stalk. The oil level is checked and the reading displayed.

Possible displays



- 1 Oil level OK
- 2 Oil level is being checked.
This can take about 3 minutes if the car is at a standstill on a level surface, or about 5 minutes while the car is on the move.
- 3 Oil level down to minimum:
Add 1.1 US quarts/1 liter of engine oil as soon as possible, refer also to Adding engine oil.
- 4 Oil level is too high.
 Too much oil will harm the engine. Have the vehicle checked without delay. ◀
- 5 The oil level sensor is defective.
Do not add engine oil. You can continue your journey. Note the newly calculated distance remaining to the next oil service, refer to page 185. Have the system checked as soon as possible.

Display via iDrive

iDrive concept, refer to page 16.

1. Press the **MENU** button.
This opens the start menu.
2. Press the controller to open the **i** menu.

3. Select "Service" and press the controller.



4. Select "Service requirements" and press the controller.



5. Select "Engine oil level" and press the controller. The oil level is displayed.

In order to exit from the display immediately:
Select  and press the controller.

Possible messages

- ▷ "Engine oil level O.K."
- ▷ "No measured value available: Updating engine oil level measurement..."
The engine oil level is measured. This can take about 3 minutes if the car is at a standstill on a level surface and the engine is running, and about 5 minutes while the car is on the move.
- ▷ "Oil level at the minimum! Refill with 1 quart engine oil"
Add engine oil as soon as possible, but no more than 1.1 US quarts/1 liter, refer also to Adding engine oil below.
- ▷ "Engine oil level too high"

 Too much oil will harm the engine. Have the vehicle checked without delay. ◀

- ▷ "Please observe recalculated service interval for engine oil"
Do not add engine oil. You can continue your journey. Note the newly calculated distance remaining to the next oil service, refer to page 185. Have the system checked as soon as possible.

Adding engine oil

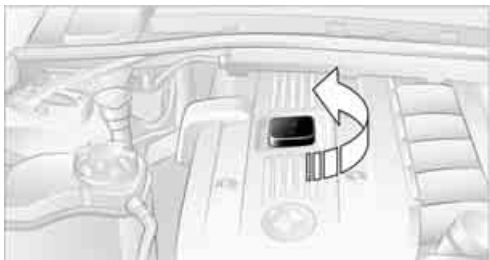

Do not add the maximum amount of 1.1 US quarts/1 liter of engine oil until a corresponding message is shown on the Control Display.

 Add oil within the next 125 miles/200 km, otherwise the engine could be damaged. ◀

 Keep oils, greases, etc. out of the reach of children and comply with the warnings on the containers. Otherwise, health hazards may result. ◀

Oil change

Have oil changed only at your BMW center or at a workshop that works according to BMW repair procedures with correspondingly trained personnel.

Specified engine oils

The quality of the engine oil selected has critical significance for the operation and service life of an engine. BMW continuously approves specific oils after confirming their suitability for use in its vehicles with extensive testing.

Use only approved BMW High Performance Synthetic Oil.

If you are unable to obtain BMW High Performance Synthetic Oil, you can add small

amounts of another synthetic oil between oil changes. Use only oils with the API SH specification or higher.

 Ask your BMW center for details concerning the specific BMW High Performance Synthetic Oil or synthetic oils which have been approved. ◀

You can also call BMW of North America at 1-800-831-1117 or visit this website: www.bmwusa.com to obtain this information.

Viscosity ratings

Viscosity is the oil flow rating as defined in SAE classes.

The selection of the correct SAE class depends on the climatic conditions in the area where you typically drive your BMW.

 Approved oils are in SAE classes 5W-40 and 5W-30. ◀

These oils may be used for driving in all ambient temperatures.

Coolant

 Do not add coolant to the cooling system when the engine is hot. Escaping coolant can cause burns. ◀

Coolant is a mixture of water and an additive. Not all commercially available additives are suitable for your BMW. Ask your BMW center for suitable additives.

 Only use suitable additives, as otherwise engine damage may result. The additives are hazardous to your health. ◀

 Comply with the appropriate environmental protection regulations when disposing of coolant additives. ◀

Checking coolant level

1. The engine must be at ambient temperature.
2. Turn the cap of the expansion tank counterclockwise to allow any accumulated pressure to escape, then continue turning to open.

- The coolant level is correct if it is between the maximum and minimum marks in the filler neck, refer also to the diagram next to the filler neck.



- If the coolant is low, slowly add coolant up to the specified level; do not overfill.
- Turn the cap until there is an audible click.
- Have the reason for the coolant loss eliminated as soon as possible.

Brake pads

BRAKE



The warning lamps light up in red even though the handbrake has been released. A message appears on the Control Display. The brake pads have reached the safe limit for pad wear. Have brake pads replaced immediately.



Display of this malfunction on Canadian models.



 For your own safety: use only brake pads that BMW has approved for the corresponding vehicle model. BMW is unable to assess the suitability of brake pads it has not approved and therefore cannot guarantee their safety. ◀

Brake system

Malfunctions

Brake fluid

BRAKE



The warning lamps light up in red even though the handbrake has been released. A message appears on the Control Display. Stop immediately.

The brake fluid in the reservoir has fallen to below the minimum level. At the same time, a considerably longer brake pedal travel may be noticeable. Have the system checked without delay.



Display of this malfunction on Canadian models.



 If you continue to drive the car, you may have to apply more pressure to the brake pedal and braking distances may be significantly longer. Please adapt your driving style accordingly. ◀

The BMW Maintenance System

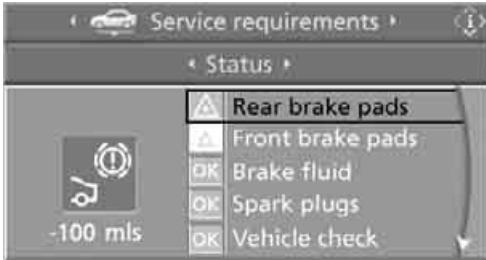

The BMW Maintenance System supports the preservation of the traffic and operating safety of your BMW. The service schedule also includes operations related to the vehicle's comfort and convenience features, such as replacement of the filters for the inside air. The objective is to optimize efforts with respect to minimal vehicle maintenance costs.

If and when you come to sell your BMW, a comprehensive record of servicing will prove a significant benefit.

CBS Condition Based Service

Sensors and special algorithms take the different driving conditions of your BMW into account. Condition Based Service uses this to determine the current and future service requirements. By letting you define a service and maintenance regimen that reflects your own individual requirements, the system builds the basis for trouble-free driving.

On the Control Display, you can have the remaining times or distances for selected maintenance tasks and any legally prescribed dates displayed, refer to page 69:

- ▷ Engine oil
- ▷ Brakes: separately for front and rear
- ▷ Microfilter/activated-charcoal filter
- ▷ Brake fluid
- ▷ Spark plugs

- ▷ Vehicle check
- ▷ Legally mandated inspections depending on local regulations

Service data in the remote control

Your vehicle continuously stores service-requirement information in the remote control while you are driving. Your BMW Service Advisor can read out this data from the remote control unit, and propose an optimized maintenance approach. Whenever you take your car in for servicing you should therefore hand your BMW Service Advisor the remote control unit that you last used.

 Make sure that the date is always set correctly, refer to page 72; otherwise the effectiveness of Condition Based Service CBS is not assured. ◀

Service and Warranty Information Booklet for US models and Warranty and Service Guide Booklet for Canadian models

Please consult your Service and Warranty Information Booklet for US models and Warranty and Service Guide Booklet for Canadian models for additional information on service requirements.

 BMW recommends that you have service and repair operations performed at your BMW center.

Take the time to ensure that these service procedures are confirmed by entries in your vehicle's Service and Warranty Information Booklet for US models and Warranty and Service Guide Booklet for Canadian models. These entries verify that your vehicle has received the specified regular maintenance. ◀

OBID Socket

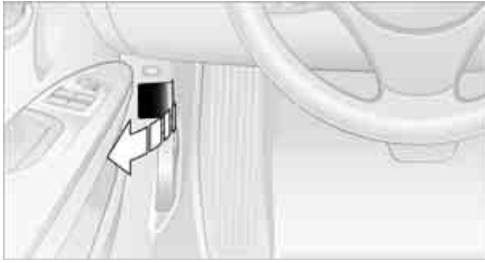

The Onboard Diagnostics OBD interface socket is located on the left of the driver's side under the instrument panel and under a cover.

The cover has the letters OBD on it.

The purpose of the OBD system is to ensure proper operation of the emissions control system for the vehicle's lifetime. The system monitors emissions-related components and systems for deterioration and malfunction.

SERVICE
ENGINE
SOON



An illuminated lamp informs you of the need for service, not of the need to stop the vehicle. However, the systems should be checked by your BMW center at the earliest possible opportunity.



Display of this malfunction on Canadian models.



Under certain conditions, the indicator will blink or flash. This indicates a rather severe level of engine misfire. When this occurs, you should reduce speed and consult the nearest BMW center as soon as possible. Severe engine misfire over only a short period of time can seriously damage emissions control components, especially the catalytic converter.



When the gas cap is not properly tightened, the OBD system can detect the vapor leak and the indicator will light up. If the gas cap is subsequently tightened, the indicator should go out within a few days. ◀

Event data recorders

Your vehicle may be equipped with one or more sensing and diagnostic modules or a recording device capable of recording or transmitting cer-

tain vehicle data or information. In addition, if you have a Subscription Service Agreement for the BMW Assist system, certain vehicle information may be transmitted or recorded in order to provide such services.

Care

Important information on the care and maintenance of your BMW is contained in the Caring for your vehicle brochure.

Replacing components

Onboard tool kit



The onboard tool kit is stored in a compartment on the right-hand side of the luggage compartment. Remove the cover.

Wiper blade replacement

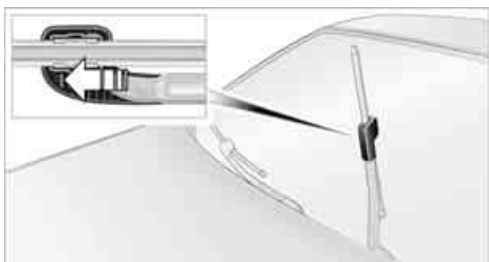

1. Fold up the wiper arm.
2. Remove the cover. To do so, press the hook on the bottom, see arrow.

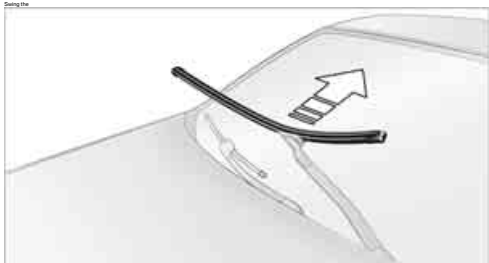

3. Fold the wiper blade upwards.
4. Remove the wiper blade in the direction of the windshield, see arrow.

 In order to avoid damage, make sure that the wiper arms are against the windshield before you open the engine compartment. ◀

Lamps and bulbs

Lamps and bulbs make an essential contribution to vehicle safety. They should, therefore, be handled carefully. BMW recommends having your BMW center perform any work that you do not feel competent to perform yourself or that is not described here.

 Never touch the glass of new bulbs with your bare fingers, as even minute amounts of contamination will burn into the bulb's surface and reduce its service life. Use a clean tissue, cloth or similar, or hold the bulb by its base. ◀

You can obtain a selection of replacement bulbs at your BMW center.

 When working on electrical systems, always begin by switching off the consumer in question, as otherwise short-circuits could result. To avoid possible injury or equipment damage when replacing bulbs, observe any instructions provided by the bulb manufacturer. ◀

For care and maintenance of the headlamps, please follow the instructions in the separate Caring for your vehicle brochure.

 If the routine for changing a particular bulb is not described here, please contact your BMW center or a workshop that works according to BMW repair procedures with correspondingly trained personnel. ◀

Xenon lamps*

The service life of these bulbs is very long and the probability of a failure is very low, provided that they are not switched on and off an unusual number of times. If a xenon lamp fails nevertheless, switch on the fog lamps and continue the

journey with great care, provided that local legislation does not prohibit this.

! Have work on the xenon lighting system performed only by your BMW center or a workshop that works according to BMW repair procedures with correspondingly trained personnel. Due to the high electrical voltages present, there is a risk of potentially fatal accidents if work is performed inappropriately. ◀

Parking lamps, roadside parking lamps

In the event of a malfunction, please contact your BMW center or a workshop that works according to BMW repair procedures with correspondingly trained personnel.

Halogen lamps

H7 bulb, 55 watts

! Always wear gloves and eye protection; the atmosphere within the H7 bulb is pressurized. Otherwise there is a risk of injury if the bulb is damaged. ◀

There are separate headlamp covers for low-beam headlamps and high-beam headlamps.

! Be careful when installing the covers, as otherwise leaks could occur and cause damage to the headlamp system. ◀

▷ For checking and adjusting headlamp aim, please contact your BMW center. ◀

Access to the lamps

The high-beam headlamp can be accessed from the engine compartment, whereas the low-beam headlamp is accessed through a flap in the wheel well.

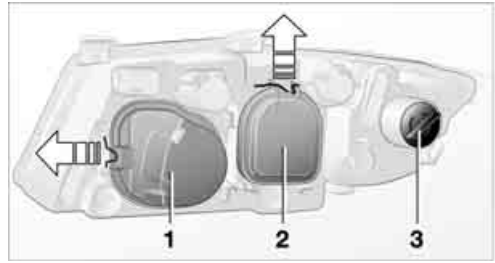

- 1 Cover for high-beam headlamp
- 2 Cover for low-beam headlamp
- 3 Turn signal

To remove the covers:

1. Fold the respective wire bracket to the side, see arrows.
2. Flip open the cover and take it out of the guide.

Follow the same steps in reverse order to reattach the covers.

Access through the wheel well

Only for low-beam headlamps and turn signals:

1. Turn the wheel inwards.
2. Open the flap in the wheel well.



Changing low-beam and high-beam bulbs

1. Remove the relevant cover for the headlamp.
2. Disconnect the plug from the lamp.

3. Push the wire bracket to the side out of the mounting, arrow 1, and fold it down, arrow 2.

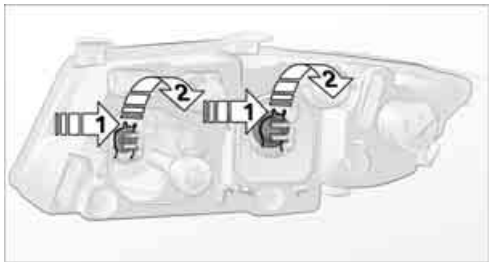

4. Remove the bulb.
5. Insert the new bulb.
6. Fold up the wire bracket and clamp it.
7. Connect the plug.
8. Reattach the cover.

Parking lamps, roadside parking lamps

5 watt bulb, W 5 W

1. Remove the cover for the high-beam head-lamp.
2. Pull out the bulb holder, see arrow.

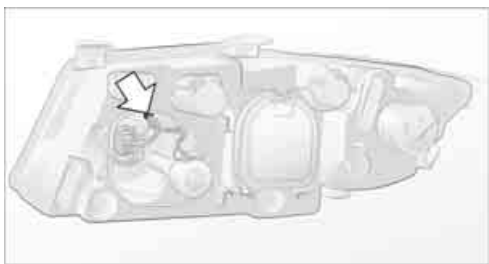

3. Remove and replace the bulb.
4. Insert the bulb holder.
5. Reattach the cover.

Turn signals, front

21 watt bulb, PY 21 W
or PY 21 W Silver Vision

1. Turn bulb holder 1 to the left and remove.



2. Apply gentle pressure to the bulb while turning it to the left for removal and replacement.
3. Insert bulb holder 1.
4. Attach the flap to the wheel well.

Side-mounted turn signals

5 watt bulb, WY 5 W
or WY 5 W-ST (Silver Top)

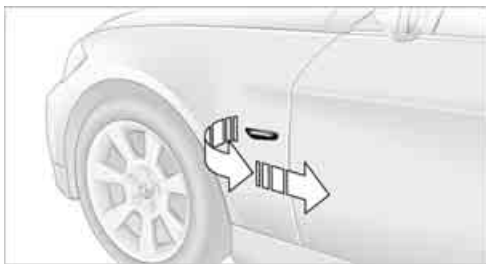

1. Press back against the front edge of the light with the tip of your finger, then pivot it out.
2. Extract the bulb for replacement.
3. Insert the lamp.

Tail lamps

21 watt bulbs, P 21 W

The tail lamps are divided into two parts. One part is in the luggage compartment lid, the other is in the fender.

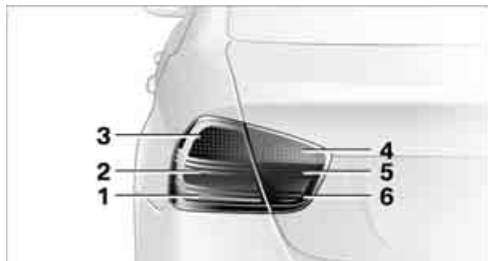

- 1 Brake lamp
- 2 Roadside parking lamp/tail lamp
- 3 Turn signal
- 4 Backup lamp
- 5 Tail lamp
- 6 Brake lamp

Lamps in the luggage compartment lid

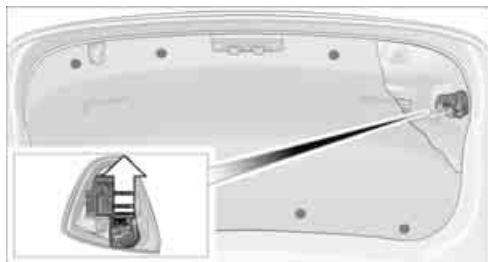

1. Pry out the plastic plugs in the trim of the luggage compartment lid using a screwdriver and remove the trim.
2. Unfasten the bulb holder at the clip, see arrow, and remove.
3. Apply gentle pressure to the bulb while turning it to the left for removal and replacement.
4. Re-engage the bulb holder so that it audibly clicks into place.
5. Reattach the trim of the luggage compartment lid.

Fender-mounted lamps

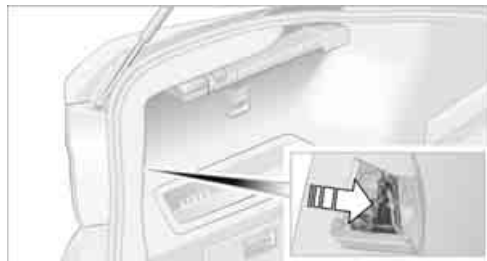

1. Using a screwdriver, pry off the cover in the luggage compartment or release the turnlock fastener by turning it counterclockwise and remove the cover.
2. Unfasten the bulb holder at the clip, see arrow, and pull out.
3. Apply gentle pressure to the bulb while turning it to the left for removal and replacement.
4. Re-engage the bulb holder so that it audibly clicks into place.
5. Reattach the cover in the luggage compartment.

License plate lamp

5 watt bulb, C 5 W



1. Using a screwdriver, push the lamp to the left in the flap of the lamp housing.
2. Take out the lamp towards the right and change the bulb.
3. Insert the lamp.

Center brake lamp

This lamp uses LED technology for operation. In the event of a malfunction, please contact your BMW center or a workshop that works

according to BMW repair procedures with correspondingly trained personnel.

Light-emitting diodes LEDs

Light-emitting diodes installed behind translucent lenses serve as the light source for many of the controls and displays in your vehicle. These light-emitting diodes, which operate using a concept similar to that applied in conventional lasers, are officially designated as Class 1 light-emitting diodes.

 Do not remove the covers or expose the eyes directly to the unfiltered light source for several hours at a time, as this could cause irritation to the retina. ◀

Changing wheels

Your BMW is equipped with Run-Flat Tires as standard. This removes the need to change a wheel immediately in the event of a puncture.

The symbol identifying Run-Flat Tires is a circle with the letters RSC on the sidewall, refer to Run-Flat Tires, page 178.

When mounting new tires or changing over from summer to winter tires and vice versa, mount Run-Flat Tires for your own safety. In the event of a flat, moreover, no spare wheel is available. Your BMW center will be glad to advise you. Refer also to New wheels and tires, page 178.

 The tools for changing wheels are available as optional accessories from your BMW center. ◀

Jack mounting points

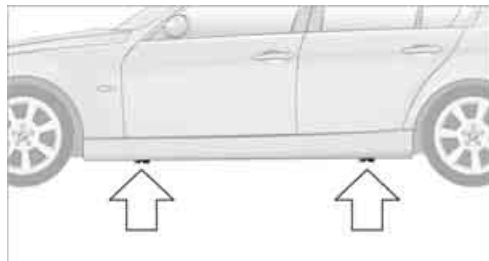

The jacking points are at the positions shown in the illustration.

Vehicle battery

Battery care

The battery is 100% maintenance-free, the electrolyte will last for the life of the battery when the vehicle is operated in a temperate climate. Your BMW center will be glad to advise in all matters concerning the battery.

Charging battery

Only charge the battery in the vehicle via the terminals in the engine compartment with the engine off. Connections, refer to Jump starting on page 194.

Disposal

 Have old batteries disposed of by your BMW center or hand them in to a recycling center. Maintain the battery in an upright position for transport and storage. Always secure the battery against tipping over during transport. ◀

Power failure

After a temporary power loss, the functioning of some equipment may be limited and require reinitialization. Individual settings may likewise have been lost and will have to be reprogrammed:

- ▷ Time and date
These values must be updated, refer to page 71.

- ▷ Radio
In some cases, stations may have to be memorized again, refer to page 140.
- ▷ Navigation system
Wait until the system starts, refer to page 130.

Fuses

 Never attempt to repair a blown fuse and do not replace a defective fuse with a substitute of another color or amperage rating, as this could lead to a circuit overload, ultimately resulting in a fire in the vehicle. ◀

In the glove compartment

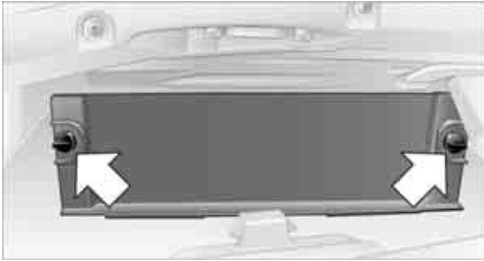

Open the cover in the glove compartment and remove it.

Spare fuses and a pair of plastic forceps are set in holders on the distributor box.

See the rear of the cover for information on fuse assignment.

Giving and receiving assistance

Emergency calling*

Conditions for an emergency call:

- ▶ Radio readiness is switched on.
- ▶ The car phone is logged on to a portable telephone network.
- ▶ The emergency call system is operable.

Initiating an emergency call

1. To open the protective cover of the keypad: touch the protective cover.



2. Press the button for at least 2 seconds. The indicator lamp in the button lights up. As soon as the voice connection to the BMW Assist response center has been established, the indicator lamp flashes.

If conditions allow, remain in the vehicle until the connection has been established. You will then be able to provide a detailed description of the situation.

In vehicles with BMW Assist enabled, if the current location of your vehicle can be determined, it will be transmitted to the BMW Assist response center.

To enable BMW Assist, refer to page 160.

If the indicator lamp is flashing but the emergency call center cannot be heard over the hands-free system, it is possible that the hands-free system is malfunctioning. The emergency call center may still be able to hear you, however.

Under certain conditions, an emergency call is automatically initiated immediately after a

severe accident. The automatic emergency call is not affected by the button being pressed.



For technical reasons, the emergency call cannot be guaranteed under unfavorable conditions. ◀

Roadside Assistance

The BMW Group's Roadside Assistance service is there to assist you around the clock in the event of a breakdown, including on weekends and public holidays.

The phone numbers of the Roadside Assistance in your home country can be found in the Contact brochure.

In vehicles equipped with BMW Assist or TeleService, you can establish contact with the BMW Group's Roadside Assistance for breakdown assistance directly via iDrive, refer to page 162.

First-aid kit*



The first-aid pouch is on the right-hand side of the luggage compartment in a storage area.



Some of the articles contained in the first-aid kit have a limited service life. Therefore, check the expiration dates of the contents regularly and replace any items in good time, if necessary. You can find replacements in any pharmacy.

Comply with the applicable legislation requiring

you to have a first-aid kit and a warning triangle in the car. ◀

Warning triangle*

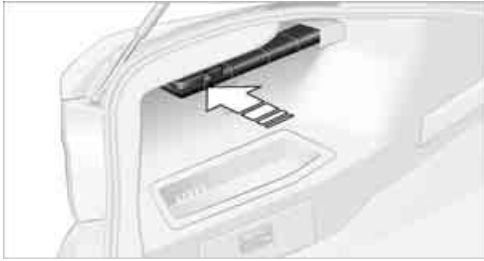

The warning triangle is on the left-hand side of the luggage compartment. Press the tab to take it out.

Jump starting

If the car's own battery is flat, your BMW's engine can be started by connecting two jumper cables to another vehicle's battery. You can also use the same method to help start another vehicle. Use only jumper cables with fully-insulated clamp handles.

! Do not touch any electrically live parts when the engine is running, or a fatal accident may occur. Carefully adhere to the following sequence, both to prevent damage to one or both vehicles, and to guard against possible personal injuries. ◀

Preparation

1. Check whether the battery of the other vehicle has a voltage of 12 volts and approximately the same capacitance in Ah. This information can be found on the battery.
2. Switch off the engine of the assisting vehicle.
3. Switch off any consumers in both vehicles.

! There must not be any contact between the bodies of the two vehicles, as otherwise there is a danger of shorting. ◀

Connecting jumper cables

! Always connect the jumper cables in the correct order, so that no sparks which could cause injury occur at the battery. ◀

Your BMW has a jump-starting connection in the engine compartment which acts as the battery's positive terminal, refer also to the Engine compartment overview on page 181. The cap is marked with +.

1. Pull the cap of the BMW jump-starting connection up to remove.



2. Attach one terminal clamp of the plus+ jumper cable to the positive terminal of the battery or a starting-aid terminal of the vehicle providing assistance.
3. Attach the second terminal clamp of the plus+ jumper cable to the positive terminal of the battery or a starting-aid terminal of the vehicle to be started.
4. Attach one terminal clamp of the minus- jumper cable to the negative terminal of the battery or to an engine or body ground of the assisting vehicle. Your BMW has a special nut as body ground or negative pole.

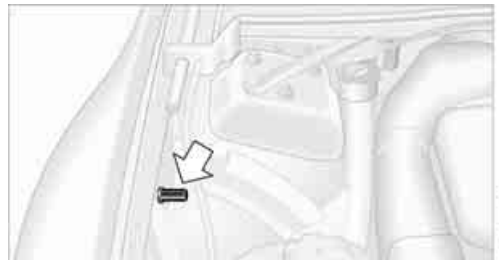

5. Attach the second terminal clamp of the minus- jumper cable to the negative terminal of the battery or to an engine or body ground of the assisting vehicle.

nal of the battery or to the engine or body ground of the vehicle to be started.

Starting the engine

1. Start the engine of the donor vehicle and allow it to run for a few minutes at an increased idle speed.
2. Start the engine on the other vehicle in the usual way.
If the first start attempt is not successful, wait a few minutes before another attempt in order to allow the discharged battery to recharge.
3. Let the engines run for a few minutes.
4. Disconnect the jumper cables by reversing the above connecting sequence.

If necessary, have your BMW center check and recharge the battery.

 Never use spray fluids to start the engine. ◀

Tow-starting, towing away

 Always observe all applicable towing laws and regulations. ◀

 Never allow passengers to ride in a towed vehicle for any reason. ◀

Using a tow fitting

The screw-in tow fitting must always be carried on the car. It can be screwed in at the front or rear of the BMW.

It is stored in the onboard tool kit underneath the cover on the right-hand side of the luggage compartment, refer to page 187.

In order to avoid damaging the tow fitting and the vehicle, please follow these instructions: use only the tow fitting provided with the vehicle and screw it all the way in. Use the tow fitting for towing only on roads. Avoid lateral loading of the tow fitting, e.g. do not lift the vehicle by the tow fitting.

Access to screw thread

Rectangular cover panel in bumper:
Press on the upper edges of the cover panel.

Front



Rear

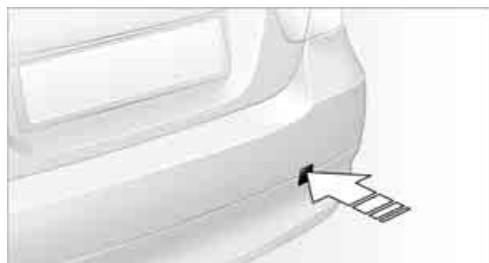

Being towed

 Make sure that the ignition is switched on, refer to page 49, as the low beams, tail lamps, turn signals and windshield wipers would no longer be available. If the electrical system fails, do not attempt to tow away or tow-start the vehicle. The electric steering wheel lock cannot be disengaged and the car is not steerable. Jump starting, refer to page 194. Power steering assistance is not available when the engine is not running. Thus, braking and steering will require increased effort. ◀

Switch on the hazard warning flashers, depending on local regulations.

Vehicles with manual transmission

Gearshift lever in neutral position.

Vehicles with automatic transmission

Selector lever in position N.

Changing selector lever positions, refer to page 52.

⚠ Do not exceed a towing speed of 45 mph or 70 km/h and a towing distance of 90 miles/150 km, as otherwise the automatic transmission may be damaged. ◀

Towing methods

In some countries, towing with tow bars or ropes is not permitted in public traffic.

Familiarize yourself with the regulations on towing in the respective country.

With tow bar

⚠ The towing vehicle must not be lighter than the towed vehicle, otherwise it may be impossible to maintain control. ◀

The tow fittings used should be on the same side on both vehicles. Should it prove impossible to avoid mounting the tow bar at an angle, please observe the following:

- ▷ Clearance and maneuvering capability will be sharply limited during cornering.
- ▷ The tow bar will generate lateral forces if it is attached offset.

⚠ Secure the tow bar to the tow fitting only. Otherwise damage to other vehicle parts could result. ◀

With tow rope

When starting off in the towing vehicle, make sure that the tow rope is taut.

⚠ To avoid jerking and the associated stresses on vehicle components when towing, always use nylon ropes or nylon straps. Secure the tow rope to the tow fitting only. Otherwise damage to other vehicle parts could result. ◀

With tow truck

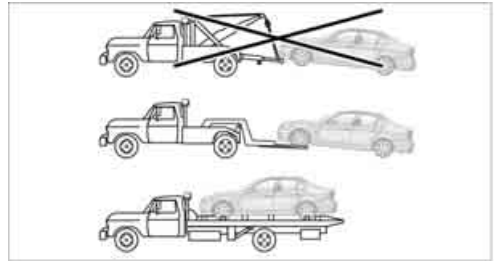

Have the BMW transported with a tow truck with a so-called lift bar or on a flat bed.

⚠ Do not lift the vehicle by a tow fitting or body and chassis parts, as otherwise damage may result. ◀

Tow-starting

⚠ If the electrical system fails, do not attempt to tow-start or tow away the car. The electric steering wheel lock cannot be disengaged and the car is not steerable. Jump starting, refer to page 194. ◀

▶ Do not tow-start vehicles with an automatic transmission. Only tow-start vehicles with a catalytic converter with the engine cold. It is better to jump start the engine, refer to page 194. ◀

1. Switch on the hazard warning flashers, comply with local regulations.
2. Switch on the ignition, refer to page 49.
3. Shift into 3rd gear.
4. Have the vehicle tow-started with the clutch pedal completely depressed and slowly release the clutch. After the engine starts, immediately depress the clutch pedal completely again.
5. Stop at a suitable location, remove the tow bar or rope and switch off the hazard warning flashers.
6. Have the vehicle checked.



Reference

This chapter contains technical data, short commands for the voice command system and an index which will help you find information the most quickly.

Technical data

Engine data

		325i	330i
Displacement	cu in/cm ³	182.8/2,996	182.8/2,996
Number of cylinders		6	6
Maximum output at engine speed	hp rpm	215 6,250	255 6,600
Maximum torque at engine speed	lb ft/Nm rpm	185/251 2,750	220/298 2,750

Dimensions

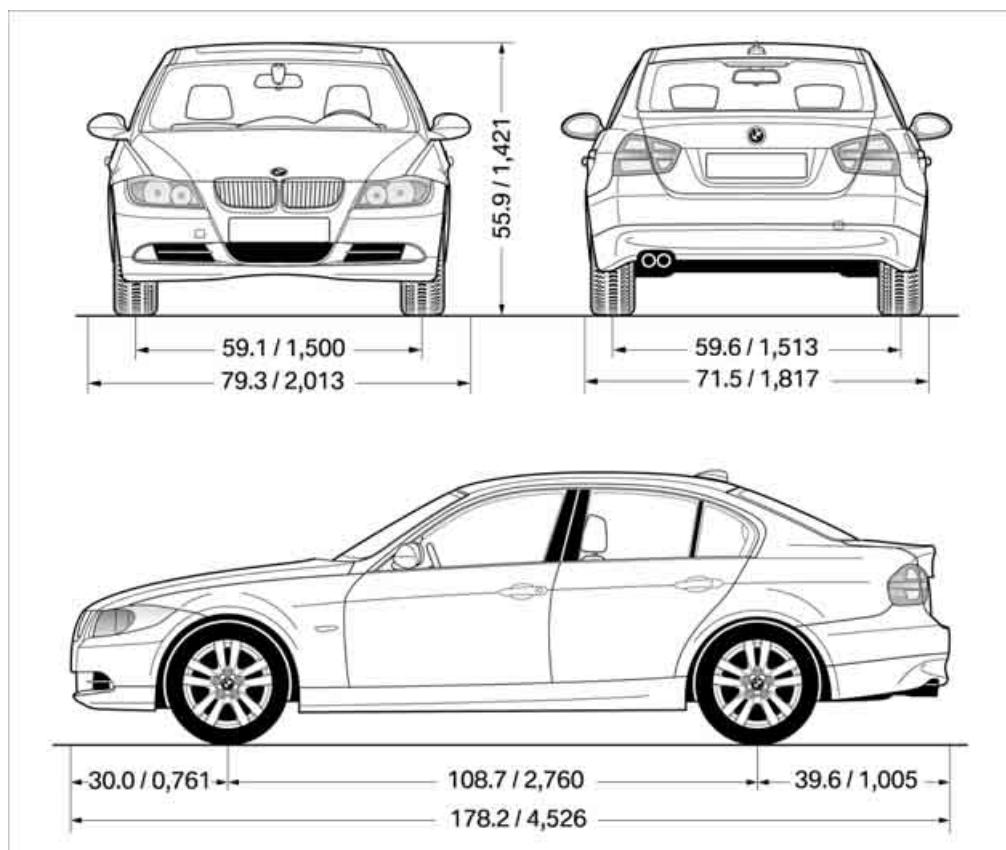

BMW GROUP

All dimensions given in inches/mm. Smallest turning circle diam.: 36 ft 1 in/11.0 m

Weights

		325i	330i
Curb weight			
with manual transmission	lbs./kg	3,285/1,490	3,417/1,550
with automatic transmission	lbs./kg	3,351/1,520	3,450/1,565
Approved gross weight			
with manual transmission	lbs./kg	4,343/1,970	4,475/2,030
with automatic transmission	lbs./kg	4,409/2,000	4,508/2,045
Load	lbs./kg	1,058/480	1,058/480
Approved front axle load	lbs./kg	2,072/940	2,138/970
Approved rear axle load	lbs./kg	2,425/1,100	2,469/1,120
Approved roof load capacity	lbs./kg	165/75	165/75
Luggage compartment volume	cu ft/l	16.2/460	16.2/460

Never exceed either the approved axle loads or the gross vehicle weight.

Capacities

			Notes
Fuel tank	gal/liters	approx. 15.9/60	Fuel grade: page 169
including reserve of	gal/liters	approx. 2.1/8.0	
Windshield washer system			For more details: page 55
including headlamp washers	quarts/liters	approx. 1.6/6.0	
Engine with oil filter renewal			BMW High Performance
	quarts/liters	approx. 6.9/6.5	Synthetic Oil
			Oil grades: page 183

Short commands for the voice command system*

With short commands you can carry out certain functions directly, regardless of which menu

item is selected. Here are the important short commands for the voice command system.

Assistance window

Function	Command
To call up assistance window 21	›Assistance window‹
To select display in the assistance window 21	›Assistance window map facing north‹, ›Assistance window map direction of travel‹, ›Assistance window arrow display‹, ›Assistance window perspective‹, ›Assistance window current position‹, ›Assistance window trip computer‹ or ›Assistance window onboard info‹

Communication

Function	Command
To open phone 153	›Phone‹
Dial phone number 153	›Dial number‹
To display phone book 154	›A to Z‹
To select from phone book 154	›Call ...‹ or ›Dial name‹
To display "Top 8" 155	›Top 8‹
Redialing 155	›Redial‹
To display "Received calls" 155	›Received calls‹
To display "Missed calls" 155	›Missed calls‹

Navigation

Function	Command
To call up navigation 119	›Navigation‹
To display current position 129	›Current position‹
To open "Enter address" 115	›Enter address‹
To open "New destination" 115	›New destination‹
To display "Input map" 118	›Input map‹
To open "Information" 119	›Info menu‹
To display address book 121	›Address book‹ or ›From address book‹

Function	Command
To display destination list 120	›Destination list‹
To switch on destination guidance 125	›Start guidance‹
To switch off destination guidance 125	›Stop guidance‹
To display route preferences 123	›Route preference‹
To switch on voice instructions 127	›Navigation info on‹
To switch off voice instructions 127	›Navigation info off‹
To repeat voice instructions 128	›Repeat navigation info‹
To show arrow display 126	›Arrow display‹
Displaying map 126	›Map‹, ›Map facing north‹, ›Map direction of travel‹ or ›Perspective‹
To call up a route 117, 126	›Route‹
To open "New route" 123	›New route‹
To change scale 127	›Scale ... miles‹ or ›Scale ... feet‹
Displaying towns/cities and streets along the route 127	›Route list‹

Onboard info

Function	Command
To open "Car Data" 66	›Car Data‹
To display onboard info 66	›Onboard info‹
To display trip computer 66	›Trip computer‹
To open speed limit 75	›Limit‹
To open stopwatch 75	›Stopwatch‹

Entertainment

Function	Command
Tone control 135	›Audio‹
To switch on radio 138	›Radio on‹
To open "FM" 138	›FM menu‹
To open "AM" 138	›AM menu‹
To open "All stations" 138	›FM All stations‹
To select radio station 138	›Station‹ name or ›Choose station‹
To open "Presets" 138	›FM presets‹ or ›AM presets‹

Function	Command
To select radio presets 138	›Preset ...‹ or ›Choose preset‹
To open "Manual" 139	›FM manual‹ or ›AM manual‹
To open strongest radio station 139	›AM Autostore‹
To call up CD player 145	›CD menu‹
To switch on CD player 145	›CD‹
To call up CD changer 145	›CD changer menu‹
To switch on CD changer 145	›CD changer‹
To select CD 145	›CD 1...6‹
To select CD and music track 146	›CD 1...6 track ...‹
To select track 146	›Track ...‹
To open "Audio Aux" 149	›Audio Aux menu‹
To call up DVD 145	›DVD player menu‹
To switch on DVD 145	›DVD player‹

Climate

Function	Command
To open "Vent settings" 90	›Vent settings‹
To open "Automatic programs" 91	›Automatic programs‹

i menu

Function	Command
To open "Door locks" 30, 32	›Door locks‹
To open "Steering wheel buttons" 45	›Steering wheel buttons‹
To open "Lighting" 53	›Lighting‹
To open "Communication settings" 160	›Communication settings‹
To open "BMW Service settings" 160	›BMW Service settings‹
To open "BMW Service" 162	›BMW Service‹
To open "Service requirements" 70, 161	›Service requirements‹
To open "Service" 70, 161	›Service‹
To display "Check Control messages" 73	›Check Control messages‹
To open "Display settings" 76	›Display settings‹
To set brightness of Control Display 76	›Brightness‹
To open "Units" 64	›Units‹
To open "Languages" 76, 127	›Languages‹
To open "Time" 71	›Time‹

Function	Command
To open "Date" 72	›Date‹
To open "PDC" 77	›PDC‹
To open "FTM" 80	›FTM‹
To open "Entertainment settings" 135	›Entertainment settings‹

Everything from A-Z

Index

"..." Identifies Control Display texts used to select individual functions and refers you to the page where these texts can be found.

A

- ABS Antilock Brake System [78](#)
- ACC, refer to Active cruise control [57](#)
- Accessories, refer to The individual vehicle [5](#)
- Activated-charcoal filter for automatic climate control [92](#)
- Active cruise control [57](#)
 - indicator lamps [60](#)
 - malfunction [61](#)
 - selecting distance [59](#)
 - sensor [61](#)
- Active steering [81](#)
 - initializing the system [82](#)
 - warning lamp [82](#)
- Adaptive Head Light [86](#)
- "Add digits" for portable phone [155](#)
- Additives
 - coolant [183](#)
- "Address book" in navigation [121](#)
- Address for navigation
 - deleting [122](#)
 - entering [115](#)
 - selecting [121](#)
 - storing current position [121](#)
- "Add to destination list" [118](#)
- Adjusting the temperature with automatic climate control [90](#)
- Adjusting the tone during audio operation, refer to Tone control [135](#)
- Adjustment in audio mode
 - front-to-rear [135](#)
 - right/left balance [135](#)
- Airbags [82](#)
 - sitting safely [38](#)
 - warning lamp [84](#)
- Air distribution
 - automatic [90](#)
 - individual [90](#)
- Air flow rate [91](#)
- Airing, refer to Ventilation [92](#)
- Air pressure, tires [170](#)
- Air recirculation, refer to Recirculated-air mode [91](#)
- "Air recirculation on / off" [45](#)
- Air vents [89](#)
- AKI, refer to Fuel specifications [168](#)
- Alarm system [34](#)
 - avoiding unintentional alarms [35](#)
 - interior motion sensor [35](#)
 - switching off an alarm [34](#)
 - tilt alarm sensor [35](#)
- "All channels" [142](#)
- All-season tires, refer to Winter tires [179](#)
- "All stations", calling up on radio [138](#)
- "AM", waveband [134](#), [138](#)
- AM, waveband [138](#)
- Ambient air, refer to Recirculated-air mode [91](#)
- Antenna for portable phone [152](#)
- Antifreeze
 - coolant [183](#)
 - washer fluid [55](#)
- Antilock Brake System ABS
 - indicator lamp [79](#)
- Anti-theft alarm system, refer to Alarm system [34](#)
- Anti-theft system [29](#)
- Anti-trapping mechanism
 - glass sunroof, electric [37](#)
 - windows [35](#)
- Approved axle loads, refer to Weights [201](#)
- Approved gross vehicle weight, refer to Weights [201](#)
- Armrest, refer to Center armrest [96](#)
- Arrival time
 - computer [66](#)
 - destination guidance [125](#)
- "Arrow display" in navigation [126](#)
- Ashtray [98](#)
- Assist, refer to BMW Assist [160](#)
- Assistance systems, refer to Dynamic Stability Control DSC [78](#)
- Assistance window [20](#)
- AUC Automatic recirculated-air control [91](#)
- Audio [134](#)
 - controls [134](#)
 - switching on/off [134](#)
 - tone control [135](#)
 - volume [135](#)
- "Audio Aux" [134](#)
- Audio device, external [97](#)
- "Audio" tone settings [135](#)
- "Auto. headlamps" [85](#)
- Automatic
 - air distribution [90](#)
 - air flow rate [90](#)
 - cruise control [55](#), [57](#)
 - headlamp control [85](#)
 - service notification [161](#)
 - storing of stations [139](#)
- Automatic climate control [89](#)
 - automatic air distribution [90](#)
 - settings via iDrive [90](#)
- Automatic curb monitor [44](#)

"Automatic programs" with automatic climate control **91**
Automatic recirculated-air control AUC **91**
Automatic station search **139**
Automatic transmission with Steptronic **51**
– interlock **51, 52**
– overriding selector lever lock **53**
– shiftlock **52**
– sport program **52**
– towing away **195**
– tow-starting **195**
AUTO program for automatic climate control **90**
"Autostore" on the radio **140**
AUX-IN **149**
– port **97**
Average fuel consumption **66**
– setting the units **68**
Average speed **65**
"Avoid ferries" in navigation **124**
Avoid freeways for navigation **123**
"Avoid highways" in navigation **123**
Avoiding unintentional alarms **35**
"Avoid tollroads" in navigation **124**
Axle loads, refer to Weights **201**
"A - Z" **154**

B

Backrests, refer to Seats **39**
Backrest width adjustment **40**
Back seats, refer to Rear seats
– adjusting head restraints **41**
Backup lamps
– replacing bulbs **190**
Backup lamps, refer to Tail lamps **189**
Balance, tone control **135**

Bar, refer to Tow-starting, towing away **196**
Bass, tone control **135**
Battery **191**
– charging **191**
– disposal **191**
– jump starting **194**
– temporary power failure **191**
Being towed **195**
Belts, refer to Safety belts **43**
Belt tensioner, refer to Safety belts **43**
Beverage holders, refer to Cup holders **98**
Black ice, refer to Ice warning **64**
Blower, refer to Air flow rate **91**
BMW Assist **160**
– enabling **160**
– services offered **161**
"BMW Contact" **164**
"BMW Contact Numbers" **164**
BMW Maintenance System **185**
"BMW Service" **162**
"BMW Service settings" **161**
Bottle holders, refer to Cup holders **98**
Brake assist, refer to Dynamic Brake Control **78**
Brake fluid **184**
– level too low **184**
– warning lamp **184**
Brake fluid, refer to Service requirements **69**
Brake Force Display **82**
Brake hydraulics, refer to Brakes **184**
Brake lamps
– Brake Force Display **82**
– replacing bulbs **190**
Brake pads, breaking in **106**
Brake rotors **108**
– brakes **106**
– breaking in **106**

Brakes
– ABS **78**
– BMW Maintenance System **185**
– brake fluid **184**
– brake pads **184**
– breaking in **106**
– handbrake **51**
– service requirements **69**
Brakes, refer to Braking safely **107**
Brake system **106**
– BMW Maintenance System **185**
– brake fluid **184**
– brake pads **184**
– breaking in **106**
– disc brakes **108**
Breakdown services, refer to Roadside Assistance **193**
Breaking in the clutch **106**
Breaking in the differential **106**
Break-in period **106**
"Brightness" **76**
Bulb changing, refer to Lamps and bulbs **187**
Button for starting engine **49**
Buttons on steering wheel **11**

C

California Proposition **65**
warning **5**
"Call" **154**
Call
– accepting **153**
– displaying accepted **155**
– ending **154**
– in absence **155**
– starting **153**
Calling
– from phone book **154**
– from Top 8 list **155**
– redialing **155**
Can holders, refer to Cup holders **98**
Capacities **201**

- Car battery, refer to Vehicle battery [191](#)
- Car care, refer to Caring for your vehicle brochure
- Car-care products, refer to Caring for your vehicle brochure
- "Car Data" [66](#)
- Care, refer to Caring for your vehicle brochure
- Cargo, securing [109](#)
- Cargo loading
 - stowing cargo [109](#)
 - vehicle [108](#)
- Caring for artificial leather, refer to Caring for your vehicle brochure
- Caring for leather, refer to Caring for your vehicle brochure
- Caring for light-alloy wheels, refer to Caring for your vehicle brochure
- Caring for plastic, refer to Caring for your vehicle brochure
- Caring for the carpet, refer to Caring for your vehicle brochure
- Caring for the vehicle finish, refer to Caring for your vehicle brochure
- Car jack
 - jacking points [191](#)
- Car key, refer to Integrated key/remote control [28](#)
- Car phone [152](#)
 - installation location, refer to Center armrest [96](#)
 - refer to Portable phone [152](#)
 - refer to separate Owner's Manual
- Car radio, refer to Radio [138](#)
- Car wash [108](#)
 - also refer to Caring for your vehicle brochure
- Catalytic converter, refer to Hot exhaust system [106](#)
- "Categories" [142](#)
- CBS Condition Based Service [185](#)
- "CD" [134](#), [145](#)
- CD changer [145](#)
 - controls [134](#)
 - fast forward/reverse [147](#)
 - installation location [147](#)
 - playing a track [146](#)
 - random order [147](#)
 - repeating a track [146](#)
 - selecting a CD [145](#)
 - selecting a track [146](#)
 - switching on/off [134](#)
 - tone control [135](#)
 - volume [135](#)
- CD player [145](#)
 - controls [134](#)
 - fast forward/reverse [147](#)
 - playing a track [146](#)
 - random order [147](#)
 - repeating a track [146](#)
 - selecting a track [146](#)
 - switching on/off [134](#)
 - tone control [135](#)
 - volume [135](#)
- Center armrest [96](#)
- Center brake lamp
 - replacing bulbs [190](#)
- Center console, refer to Around the center console [14](#)
- "Central locking" [30](#)
- Central locking
 - from inside [32](#)
 - from outside [29](#)
- Central locking system [29](#)
- Changing bulbs [187](#)
- Changing the language on the Control Display [76](#)
- Changing the measurement units on the Control Display [68](#)
- Changing wheels [191](#)
- Chassis number, refer to Engine compartment [181](#)
- Check Control [73](#)
- "Check Control messages" [75](#)
- Check Gas Cap [168](#)
- Checking the air pressure, refer to Tire inflation pressure [170](#)
- Child-restraint fixing system LATCH [48](#)
- Child-restraint systems [46](#)
- Child-safety lock [48](#)
- Child seats [46](#)
- Chrome parts, care, refer to Caring for your vehicle brochure
- Cigarette lighter [99](#)
 - socket [99](#)
- Cleaning, refer to Caring for your vehicle brochure
- Cleaning headlamps [54](#)
 - washer fluid [55](#)
- "Climate" [90](#)
- Clock [64](#)
 - 12h/24h mode [72](#)
 - setting time [71](#)
- Closing
 - from inside [32](#)
 - from outside [30](#)
- Clothes hooks [97](#)
- Cold start, refer to Starting the engine [49](#)
- Combined instrument, refer to Instrument cluster [12](#)
- Comfort area, refer to Around the center console [14](#)
- "Communication" [153](#)
- "Communication settings" [160](#)
- Compact disc, refer to
 - CD changer [145](#)
 - CD player [145](#)
- Compact wheel
 - inflation pressure [172](#), [173](#), [174](#), [175](#)
- Compartment for remote control, refer to Ignition lock [49](#)
- Compass [94](#)
- Computer [65](#)
 - displays on Control Display [66](#)
 - hour signal [72](#)
- Computer, refer to iDrive [16](#)

"Concert hall" tone settings [136](#)
Condensation, refer to When the vehicle is parked [108](#)
Configuring settings, refer to Personal Profile [29](#)
Confirmation signals for locking/unlocking of the vehicle [31](#)
Connecting vacuum cleaner, refer to Connecting electrical appliances [99](#)
Consumption display
– average consumption [66](#)
Consumption indicator
– Energy Control [64](#)
"Continue guidance to destination?" [126](#)
Control Center, refer to iDrive [16](#)
Control Display, refer to iDrive [16](#)
Controller, refer to iDrive [16](#)
Controls and displays [10](#)
Convenience operation
– windows [30](#)
Convenience start, refer to Starting the engine [49](#)
Coolant [183](#)
– adding [183](#)
– checking level [183](#)
Cooling, maximum [90](#)
Cooling fluid, refer to Coolant [183](#)
Country of destination for navigation [116](#)
Courtesy lamps [87](#)
Cruise control [55](#)
– active [57](#)
– malfunction [57](#)
Cruising range [65](#)
Cup holders [98](#)
Curb weight, refer to Weights [201](#)
Current fuel consumption [64](#)
"Current position" [129](#)

Current position
– displaying [129](#)
– entering [121](#)
– storing [121](#)
"Customer Relations" [162, 164](#)

D

Dashboard, refer to Cockpit [10](#)
Dashboard lighting, refer to Instrument lighting [87](#)
Data [200](#)
– capacities [201](#)
– dimensions [200](#)
– engine [200](#)
– weights [201](#)
"Date" [73](#)
Date
– setting [72](#)
– setting format [73](#)
"Date format" [73](#)
Daytime driving lamps [86](#)
DBC Dynamic Brake Control [78](#)
Deactivating front passenger airbags [83](#)
Deadlocking, refer to Locking [30](#)
Decommissioning the vehicle
– refer to Caring for your vehicle brochure
Defect
– fuel filler door [168](#)
– glass sunroof [37](#)
Defogging windows [91](#)
Defroster
– rear window [92](#)
Defrosting windows [91](#)
Defrosting windows and removing condensation [91](#)
Defrost position, refer to Defrosting windows [91](#)
"Delete address book" in navigation [122](#)
"Delete all numbers" on the portable phone [156](#)

"Delete data" in navigation [122](#)
"Delete" for portable phone [156](#)
Destination address
– deleting [122](#)
– entering [115](#)
Destination for navigation
– entry [115](#)
– navigation list [120](#)
– selecting from address book [121](#)
– selecting using information [119](#)
– storing [121](#)
Destination guidance [125](#)
– canceling voice instructions [45](#)
– changing specified route [123](#)
– displaying routes [126](#)
– distance and arrival [125](#)
– interrupting [125](#)
– starting [125](#)
– terminating/continuing [125](#)
– voice instructions [127](#)
– volume of voice instructions [128](#)
Destination list for navigation system [120](#)
Destinations recently driven to [120](#)
"Dial" for portable phone [153](#)
"Dial number" [154](#)
Digital clock [64](#)
Digital compass [94](#)
Dimensions [200](#)
Directional indicators, refer to Turn signals [53](#)
Direction instructions, refer to Voice instructions [127](#)
Directory, refer to Phone book [154](#)
Directory for navigation, refer to Address book [121](#)
Displacement, refer to Engine data [200](#)
Display, refer to iDrive controls [16](#)

- Display lighting, refer to Instrument lighting **87**
 - "Display off" **21**
 - Displays, refer to Instrument cluster **12**
 - Displays and controls **10**
 - "Display settings" **72**
 - Disposal
 - of coolant **183**
 - vehicle battery **191**
 - Distance control, refer to Active cruise control **57**
 - Distance remaining to service, refer to Service requirements **69**
 - "Distance to dest." **66**
 - Distance warning, refer to PDC Park Distance Control **77**
 - Door key, refer to Integrated key/remote control **28**
 - Door lock **31**
 - Door locking, confirmation signals **31**
 - "Door locks" **30**
 - Doors, emergency operation **31**
 - DOT Quality Grades **176**
 - Draft-free ventilation **92**
 - Drinks holders, refer to Cup holders **98**
 - Drive-off assistant **80**
 - Driving lamps, refer to Parking lamps/low beams **85**
 - Driving notes **106**
 - Driving route, refer to Displaying route **126**
 - Driving stability control systems **78**
 - Driving through water **107**
 - Driving tips, refer to Driving notes **106**
 - Dry air, refer to Cooling function **92**
 - DSC Dynamic Stability Control **78**
 - indicator lamps **79**
 - DTC Dynamic Traction Control **79**
 - indicator lamps **79**
 - DVD for navigation **114**
 - Dynamic Stability Control DSC
 - indicator lamps **79**
 - Dynamic Traction Control DTC
 - indicator lamps **79**
- ## E
- EBV Electronic brake-force distribution **78**
 - Eject button, refer to Buttons on the CD player **134**
 - Electrical malfunction
 - door lock **31**
 - fuel filler door **168**
 - glass sunroof **37**
 - Electric seat adjustment **39**
 - Electronic brake-force distribution **78**
 - Electronic oil level check **181**
 - Emergency call **193**
 - Emergency operation, refer to Manual operation
 - door lock **31**
 - fuel filler door **168**
 - glass sunroof **37**
 - transmission lock, automatic transmission **53**
 - Emergency release of luggage compartment lid from luggage compartment's interior **33**
 - Emergency services, refer to Roadside Assistance **193**
 - Emissions test, refer to Service requirements **69**
 - "Enable services" **161**
 - "End call" **154**
 - Energy-conscious driving, refer to Energy Control **64**
 - Energy Control **64**
 - Engine
 - breaking in **106**
 - data **200**
 - speed **200**
 - starting **49**
 - switching off **50**
 - Engine compartment **181**
 - Engine coolant, refer to Coolant **183**
 - Engine oil
 - adding **183**
 - BMW Maintenance System **185**
 - checking level **181**
 - intervals between changes, refer to Service requirements **69**
 - "Engine oil level" **182**
 - Engine output, refer to Engine data **200**
 - Engine speed **200**
 - Engine starting, refer to Starting the engine **49**
 - "Enter address" **116**
 - Entering destination **116**
 - Entering the address **115**
 - Entering the intersection **117**
 - "Entertainment" **134**
 - "Entertainment settings" **135**
 - Entry map for destination **118**
 - "Equalizer", refer to Tone control **136**
 - Error messages, refer to Check Control **73**
 - "ESN" **142**
 - ESP Electronic Stability Program, refer to DSC Dynamic Stability Control **78**
 - Event data recorders **186**
 - Exhaust system, refer to Hot exhaust system **106**
 - Exterior mirrors **43**
 - adjusting **43**
 - automatic dimming feature **107**
 - automatic heating **44**
 - External audio device **97, 149**

- Eyes
 - for tow-starting and towing away 195
 - for tying down loads 109

F

- Fader, tone control 135
- Failure messages, refer to
 - Check Control 73
- Failure of an electrical consumer 192
- False alarm, refer to Avoiding unintentional alarms 35
- Fastening safety belts, refer to Safety belts 43
- Fastest route for navigation 123
- Fast forward
 - CD changer 147
 - CD player 147
- "Fast route" in navigation 123
- Filter
 - refer to Microfilter/activated-charcoal filter for automatic climate control 92
- First-aid kit 193
- Fixture for remote control, refer to Ignition lock 49
- Flashlight, refer to Rechargeable flashlight 96
- Flash when locking/unlocking 31
- Flat
 - Run-Flat Tires 178
- Flat Tire Monitor
 - snow chains 179
- Flat Tire Monitor FTM 80
 - indicating a flat tire 81
 - initializing the system 80
 - malfunction 81
 - system limits 80
- Flat tires, refer to Tire condition 177
- "FM", waveband 134, 138
- FM, waveband 138
- Fog lamps 87
 - indicator lamp 13, 87

- Footbrake, refer to Braking safely 107
- Footwell lamps 87
- Front airbags 82
- Front seat adjustment 39
- "FTM" 81
- FTM, refer to Flat Tire Monitor 80
- Fuel 168
 - display 65
 - high-quality brands 168
 - quality 168
 - specifications 168
 - tank capacity 201
- Fuel clock, refer to Fuel gauge 65
- Fuel consumption, refer to Average fuel consumption 66
- Fuel display, refer to Fuel gauge 65
- Fuel filler door 168
 - releasing in the event of electrical malfunction 168
- Fuses 192

G

- Garage door opener, refer to Integrated universal remote control 93
- Gasoline, refer to Required fuel 168
- Gasoline display, refer to Fuel gauge 65
- Gasoline engine, checking oil level 181
- Gear indicator, for automatic transmission 51
- Gearshift lever
 - automatic transmission with Steptronic 52
 - manual transmission 51
- Gearshifts
 - with automatic transmission 52
 - with manual transmission 51
- General driving notes 106

- Glass sunroof, electric 36
 - anti-trapping mechanism 37
 - closing after electrical malfunction 37
 - convenient operation 30, 31
 - opening, closing 36
 - raising 36
 - remote control 30
- Glove compartment 96
 - rechargeable flashlight 96
- GPS navigation, refer to Navigation system 114
- Grills 89
- Gross vehicle weight, refer to Weights 201

H

- Halogen lamps
 - replacing bulbs 188
- Handbrake 51
 - indicator lamp 51
- Hand lamp, refer to Rechargeable flashlight 96
- Hands-free system 14, 152
- Hazard warning flashers 14
- Head airbags 82
- Headlamp control, automatic 85
- Headlamp cover 188
- Headlamp flasher 53
 - indicator lamp 11, 13
- Headlamps
 - care, refer to Caring for your vehicle brochure
 - replacing bulbs 188
- Head restraints 40
 - sitting safely 38
- Heated
 - mirrors 44
 - rear window 92
 - seats 41
- Heating
 - mirrors 44
 - seats 41
- Heating while at a standstill, refer to Using residual heat 91

Heavy loads, refer to Stowing cargo [109](#)
 Height, refer to
 Dimensions [200](#)
 Height adjustment
 – seats [39](#)
 – steering wheel [44](#)
 High beams [86](#)
 – indicator lamp [13](#)
 – replacing bulbs [188](#)
 High water, refer to Driving through water [107](#)
 Hills [107](#)
 Holders for cups [98](#)
 "Home address" in navigation [123](#)
 Hood [180](#)
 Horn [10](#)
 Hot exhaust system [106](#)
 "Hour memo" [72](#)
 "House number" in destination entry [117](#)
 Hydraulic brake assist, refer to Dynamic Brake Control [78](#)
 Hydroplaning [107](#)

I

Ice warning [64](#)
 iDrive [16](#)
 – adjusting brightness [76](#)
 – assistance window [20](#)
 – automatic climate control [90](#)
 – changing language [76](#)
 – confirming a selection or entry [19](#)
 – date and time, setting [72](#)
 – displays, menus [17](#)
 – lists [19](#)
 – menu guidance [17](#)
 – operating principle [16](#)
 – selecting a menu item [19](#)
 – status information [20](#)
 – switching menu pages [19](#)
 – symbols [18](#)
 Ignition [49](#)
 – switched off [49](#)
 – switched on [49](#)

Ignition key, refer to
 Integrated key/remote control [28](#)
 Ignition key position 1, refer to
 Radio readiness [49](#)
 Ignition key position 2, refer to
 Ignition on [49](#)
 Ignition lock [49](#)
 Indicator and warning lamps [13](#)
 Individual air distribution [90](#)
 Individually programmable buttons on steering wheel [45](#)
 Individual settings, refer to
 Personal Profile [29](#)
 Information
 – on another location [119](#)
 – on country [119](#)
 – on current position [119](#)
 – on destination location [119](#)
 "Information" in navigation [119](#)
 "Information on destination" [120](#)
 "Input map" [118](#)
 Installation location
 – CD changer [147](#)
 Instructions for navigation system, refer to Voice instructions [127](#)
 Instrument cluster [12](#)
 Instrument lighting [87](#)
 Integrated key [28](#)
 Integrated universal remote control [93](#)
 Interesting destination for navigation [119](#)
 "Interim time" [76](#)
 Interior lamps [87](#)
 – remote control [30](#)
 Interior motion sensor [35](#)
 Interior rearview mirror [44](#)
 – automatic dimming feature [107](#)
 Interior rearview mirror with digital compass [94](#)
 Interlock [52](#)

Intermittent mode of the wipers [54](#)

J

Jacking points [191](#)
 Joystick, refer to iDrive [16](#)
 Jumpering, refer to Jump starting [194](#)
 Jump starting [194](#)

K

Key, refer to Integrated key/remote control [28](#)
 Key Memory, refer to Personal Profile [29](#)
 "Keypad" [156](#)
 Kick-down [52](#)
 Knock control [168](#)

L

Lamps, refer to Parking lamps/low beams [85](#)
 Lamps and bulbs, replacing bulbs [187](#)
 "Languages" in navigation [128](#)
 "Languages" on the control display [76](#)
 Lap-and-shoulder safety belt [43](#)
 Lashing eyes, refer to
 Securing cargo [109](#)
 Last destinations, refer to
 Destination list [120](#)
 "Last seat pos." [42](#)
 LATCH child-restraint fixing system [48](#)
 LEDs light-emitting diodes [191](#)
 Length, refer to
 Dimensions [200](#)
 License plate lamp, replacing bulbs [190](#)
 Light-emitting diodes LEDs [191](#)
 Lighter [99](#)

"Lighting" 85, 86
Lighting
– instruments 87
– lamps and bulbs 187
– of the vehicle, refer to Lamps 85
Light switch 85
"Limit" 75
Limit, refer to Speed limit 75
Loading
– securing cargo 109
Load securing equipment, refer to Securing cargo 109
Location
– drive for navigation DVD and audio CD 114
Lock buttons in the doors, refer to Locking 32
Locking
– adjusting confirmation signal 31
– from inside 32
– from outside 30
Locking and unlocking doors
– from inside 32
– from outside 30
"LOGIC7", refer to Tone control 136
Low beams 85
– automatic 85
– replacing bulbs 188
Lower back support, refer to Lumbar support 39
Luggage compartment
– capacity 201
– lamp 87
– lid 32
– opening from inside 33
– opening from outside 33
– volume 201
Luggage compartment lid 32
– locking or unlocking separately 33
– opening and closing 33
– opening from inside 33
– opening from outside 33
– unlocking with remote control 30

Luggage compartment net, refer to Securing cargo 109
Luggage rack, refer to Roof-mounted luggage rack 109
Lumbar support 39
LW, waveband 138

M

M+S tires, refer to Winter tires 179
Maintenance, refer to Service Booklet
Maintenance system 185
Malfunction warnings, refer to Check Control 73
Manual mode of automatic transmission 52
"Manual"
– on the radio 139
Manual operation
– door lock 31
– glass sunroof 37
– transmission lock, automatic transmission 53
Manual release
– fuel filler door 168
Manual transmission 51
Map
– changing scale 127
– destination entry 118
"Map direction of travel" 127
"Map facing north" 127
Master key, refer to Integrated key/remote control 28
Maximum cooling 90
Maximum speed
– for winter tires 179
Menus, refer to iDrive 16
Microfilter
– BMW Maintenance System 185
– for automatic climate control 92
Microfilter/activated-charcoal filter
– BMW Maintenance System 185

Microphone
– for hands-free system 152
Microphone for telephone 14
Mirror dimming feature 107
Mirrors 43
– automatic curb monitor 44
– exterior mirrors 43
– heating 44
– interior rearview mirror 44
"Missed calls" 155
Missed calls 155
Modifications, technical, refer to For your own safety 5
Monitor, refer to iDrive controls 16
Monitoring system for tire pressures, refer to Flat Tire Monitor 80
"Monitor on / off" 45
Most recent portable phone numbers 155
Multifunction switch
– refer to Turn signals/headlamp flasher 53
– refer to Wiper system 54
Music track
– finding 146
"Mute on / off" 45

N

"Navigation" 115
Navigation address
– home address 122
Navigation destination
– manual entry 115
– selecting via map 118
Navigation drive, location 114
Navigation DVD 114

Navigation system **114**
 – address book **121**
 – destination entry **115**
 – destination guidance in assistance window **114**
 – destination list **120**
 – displaying current position **129**
 – entering a destination manually **115**
 – last destinations **120**
 – opening **115**
 – route display **126**
 – route list **127**
 – searching for a special destination **119**
 – selecting destination using information **119**
 – selecting destination via map **118**
 – selecting route criteria **123**
 – starting destination guidance **125**
 – switching off, refer to Terminating/continuing destination guidance **125**
 – terminating/continuing destination guidance **125**
 – voice instructions **127**
 – volume adjustment **128**
 "Navigation voice instructions" via buttons on the steering wheel **45**
 Neck support, refer to Head restraints **40**
 Nets, refer to Storage compartments **97**
 "New address" in navigation **121**
 "New destination" **115, 118**
 "New route" **129**
 New tires **178**
 "Next entertainment source" **45**
 North-facing map **126**
 Nose weight **201**
 Nozzles **89**
 Nozzles, refer to Windshield washer nozzles **54**

Number of cylinders, refer to Engine data **200**

O

Octane ratings, refer to Fuel specifications **168**
 Odometer **64**
 Oil
 – capacity **201**
 Oil, refer to Engine oil **181**
 Oil consumption **181**
 Oil level **181**
 Old batteries, refer to Disposal **191**
 "On a new destination" in navigation **119**
 "Onboard info" **66**
 Onboard tool kit **187**
 "On destination" **119**
 "On location" **119**
 Opening and closing
 – from inside **32**
 – from outside **30**
 – using the door lock **31**
 – via the remote control **30**
 Opening and unlocking
 – from the inside **32**
 Operation by voice for portable phone **156**
 – adjusting volume **158**
 – canceling **157**
 – correcting phone number **158**
 – dialing phone number **158**
 – placing a call **158**
 – redialing **159**
 – voice commands **157**
 – voice phone book **158**
 Orientation menu, refer to Start menu **17**
 Outlets
 – refer to Ventilation **92**
 Output, refer to Engine data **200**
 Outside-air mode
 – automatic climate control **91**

Outside-temperature display **64**
 – changing units of measure **68**
 – in computer **68**
 Overriding selector lever lock **53**

P

Panic mode **30**
 Parking
 – vehicle **50**
 Parking aid, refer to PDC Park Distance Control **77**
 Parking brake, refer to Handbrake **51**
 Parking lamps/low beams **85**
 – replacing bulbs **189**
 Parts and accessories, refer to The individual vehicle **5**
 Passenger-side mirror tilt function **44**
 "Pathway lighting" **86**
 Pathway lighting **86**
 "PDC" **78**
 "PDC display on" **78**
 PDC Park Distance Control **77**
 Personal Profile **29**
 Phone book **153**
 Phone numbers
 – deleting from phone book **155**
 – dialing **153**
 – most recent numbers **155**
 – selecting in phone book **155**
 – Top 8 **155**
 Placing a call, refer to telephone owner's manual
 "Play"
 on the radio **143**
 Pollen
 – refer to Microfilter/activated-charcoal filter for automatic climate control **92**

Portable phone

- accepted calls [155](#)
- adjusting volume [153](#)
- calling [153](#)
- ending call [154](#)
- hands-free system [152](#)
- missed calls [155](#)
- operation via iDrive [153](#)
- phone book [154](#)
- redialing [155](#)
- Top 8 [155](#)
- touch tone dialing [156](#)

Portable phone, installation location, refer to Center armrest [96](#)

Portable phone, refer to the separate Owner's Manual

Portable phone in the vehicle [106](#)

Portable phones, use inside the car, refer to Portable phone in the vehicle [106](#)

Position

- displaying [129](#)
- storing [121](#)

Power windows [35](#)

- safety switch [36](#)

Power windows, refer to Windows [35](#)

"Presets", calling up on radio [138](#)

"Presets" on the radio [142](#)

Pressure, tires [170](#)

Pressure monitoring, tires [80](#)

- Flat Tire Monitor [80](#)

Protection function, refer to Anti-trapping mechanism

- glass sunroof, electric [37](#)
- windows [35](#)

Puncture

- Flat Tire Monitor [80](#)

R

Radio

- autostore [139](#)
- controls [134](#)
- sampling stations [139](#)
- satellite radio [141](#)
- selecting the frequency manually [139](#)
- selecting the waveband [134](#), [138](#)
- station search [139](#)
- station selection [138](#)
- station with the best reception [139](#)
- storing stations [140](#)
- switching on/off [134](#)
- tone control [135](#)
- volume [135](#)
- Weather Band [141](#)

Radio key, refer to Integrated key/Remote control [28](#)

Radio position, refer to Radio readiness [49](#)

Radio readiness [49](#)

- switched off [49](#)
- switched on [49](#)

Rain sensor [54](#)

"Random", random play [147](#)

Reading lamps [88](#)

Rear lamps, refer to Tail lamps [189](#)

- replacing bulbs [190](#)

Rear seats

- adjusting head restraints [41](#)

Rear turn signals

- replacing bulbs [190](#)

Rear ventilation [92](#)

Rearview mirror, refer to Mirrors [43](#)

Rear window defroster [92](#)

Rear window roller blind, refer to Roller sun blinds [95](#)

Rear window safety switch [36](#)

"Received calls" [155](#)

Receiving level of portable phone, refer to Status information [20](#)

Reception

- radio stations [141](#)

Rechargeable flashlight [96](#)

Recirculated-air mode [91](#)

Recirculation of air, refer to Recirculated-air mode [91](#)

Reclining seat, refer to Backrest [39](#)

Recording times, refer to Stopwatch [75](#)

"Redial" for portable phone [155](#)

Refueling [168](#)

Releasing

- hood [180](#)

Remaining distance, refer to Cruising range [65](#)

Remote control [28](#)

- garage door opener [93](#)
- luggage compartment lid [30](#)
- malfunctions [31](#)
- service data [185](#)

"Repeat" for audio mode [146](#)

Replacement remote control [28](#)

Replacing bulbs, refer to Lamps and bulbs [187](#)

Replacing tires, refer to New wheels and tires [178](#)

Reporting an accident, refer to Initiating an emergency call [193](#)

Reporting safety defects [7](#)

Reserve warning, refer to Fuel gauge [65](#)

Reservoir for washer systems [55](#)

Reset, refer to Resetting tone settings [137](#)

"Reset" for stopwatch [76](#)

"Reset" for tone settings [137](#)

Residual heat mode [91](#)

Restraint system

- for children [46](#)

Restraint systems

- refer to Safety belts [43](#)

Reverse, fast

- CD changer [147](#)
- CD player [147](#)

Reverse gear
 – automatic transmission with Steptronic 52
 – manual transmission 51
 Road map 126
 "Roadside Assistance" 162
 Roadside Assistance 162, 193
 Roadside parking lamps 86
 – replacing bulbs 189
 Roadworthiness test, refer to Service requirements 69
 Roller blind
 – sun blinds 95
 Roof load capacity 201
 Roof-mounted luggage rack 109
 Rope, refer to Tow-starting, towing away 196
 Rotary/pushbutton, refer to iDrive 16
 Route 123
 – changing 123
 – display 126
 – displaying arrow view 126
 – displaying map view 126
 – displaying town 127
 – list 127
 – selecting 123
 – selecting criteria 123
 "Route list" in navigation 127
 Route map 126
 "Route preference", changing 123
 Route selection 123
 RSC Runflat System
 Component, refer to Run-Flat Tires 178
 Runflat System Component RSC, refer to Run-Flat Tires 178
 Run-Flat Tires 178
 – continuing driving with a damaged tire 81
 – flat tire 81
 – new tires 178
 – replacing tires 178
 – tire pressures 170
 – winter tires 179

Runflat Tyres, refer to Run-Flat Tires 178

S

Safety-belt height adjustment 43
 Safety belts 43
 – damage 43
 – indicator lamp 43
 – reminder 43
 – sitting safely 38
 Safety systems
 – airbags 82
 – Antilock Brake System ABS 78
 – Dynamic Stability Control DSC 78
 – safety belts 43
 Safety tires, refer to Run-Flat Tires 178
 Sampling tracks
 – scan 146
 Satellite radio 141
 – enabling 141
 – selecting channel 142
 – storing channel 142
 "SAT" for radio 134, 142
 Scan
 – CD changer 146
 – CD player 146
 – radio 139
 "Scan", sampling radio stations 139
 "Scan", sampling tracks on CD 146
 Screen, refer to iDrive controls 16
 Seat adjustment
 – electric 39
 – mechanical 39
 Seat belt reminder, refer to 'Fasten safety belts' reminder 43
 Seats 39
 – adjusting the seats 39
 – heating 41
 – sitting safely 38
 Securing cargo 101
 "Select as destination" 120
 "Select current speed" 75
 Selecting distance for active cruise control 59
 Selecting menu items 19
 Selecting new scale for navigation 127
 Selecting the frequency manually 139
 Selection options with navigation system 123
 Selector lever
 – automatic transmission with Steptronic 52
 "Service" 75, 161, 182
 Service, refer to Roadside Assistance 193
 Service car, refer to Roadside Assistance 193
 Service data in the remote control 185
 Service Interval Display, refer to Condition Based Service CBS 185
 "Service notification" 161
 "Service Request" 162, 164
 Service requirement display, refer to Condition Based Service CBS 185
 "Service requirements" 70, 161, 182
 Service requirements 69
 "Service Status" 161
 "Set date" 73
 "Set" for audio mode 134
 "Set time" 72
 Settings
 – clock, 12h/24h mode 72
 – date format 73
 "Set tire pressure" 81
 Shifting with automatic transmission with Steptronic 52
 Shiftlock, refer to Changing selector lever positions 52
 Short commands of voice command system 202
 Shortest route in navigation, refer to Selecting route 123

"Short route" in navigation [123](#)
"Show current position" [119](#)
"Show destination position" [119](#)
Shuffled, refer to Random
– CD changer [147](#)
– CD player [147](#)
Side airbags [82](#)
Side-mounted turn signals
– replacing bulbs [189](#)
Side window blind, refer to Roller sun blinds [95](#)
Side windows, refer to Windows [35](#)
Signal horn, refer to Horn [10](#)
Sitting safely [38](#)
– airbags [38](#)
– safety belt [38](#)
– with head restraint [38](#)
Ski bag [101](#)
Ski sack, refer to Ski bag [101](#)
Sliding/tilt sunroof, refer to Glass sunroof, electric [36](#)
Slot for remote control [49](#)
Smokers' package, refer to Ashtray [99](#)
Socket, refer to Connecting electrical appliances [99](#)
Sound output for entertainment on/off [134](#)
Spare fuses [192](#)
Spare fuses, refer to Fuses [192](#)
Spark plugs, refer to Service requirements [69](#)
Speed
– for winter tires [179](#)
Speed-dependent volume [135](#)
Speed limit [75](#)
– setting [75](#)
Speed limit warning, refer to Speed limit [75](#)
Speedometer [12](#)
"Speed volume" [136](#)
Sports seat [40](#)

Stability control, refer to Driving stability control systems [78](#)
Start/stop button [49](#)
– starting the engine [49](#)
– switching off the engine [50](#)
"Start guidance" [118](#), [125](#)
Starting
– difficulties, temperature [50](#)
Starting, refer to Starting the engine [49](#)
Starting assistance, refer to Jump starting [194](#)
Starting the engine
– start/stop button [49](#)
Start menu [17](#)
"State / Province" in destination entry [116](#)
Station, refer to Radio [138](#)
"Status" [70](#)
Status of this Owner's Manual at time of printing [5](#)
Steering wheel [44](#)
– adjustment [44](#)
– buttons on steering wheel [11](#)
– freely programmable buttons [45](#)
– lock [49](#)
"Steering wheel buttons" [45](#)
Steering with variable ratio, refer to Active steering [81](#)
Steptronic, refer to Automatic transmission with Steptronic [51](#)
"Stopwatch" [76](#)
Stopwatch [75](#)
Storage compartment
– permissible load [97](#)
Storage compartments [97](#)
Storage package [97](#)
"Store in address book" in navigation [121](#)
"Store" on the radio [140](#), [143](#)
Storing current position [121](#)
Storing radio stations [140](#)
Storing tires [179](#)
Stowage, refer to Storage compartments [97](#)

"Street" in destination entry [117](#)
Summer tires, refer to Wheels and tires [170](#)
Sun blinds [95](#)
SW, waveband [138](#)
Switches, refer to Cockpit [10](#)
Switching Control Display on/off [21](#)
Switching navigation voice instructions on/off [127](#)
Switching off
– engine [50](#)
Switching off the engine
– start/stop button [49](#)
Switching on
– audio [134](#)
– CD changer [134](#)
– CD player [134](#)
– radio [134](#)
Switching on the hour signal [72](#)
Switching the cooling function on and off [92](#)
Symbols [4](#)
– Control Display [20](#)

T

Tachometer [64](#)
Tail lamps [189](#)
– replacing bulbs [190](#)
Tank contents, refer to Capacities [201](#)
Technical data [200](#)
Telematik, refer to TeleService, BMW Assist [160](#)
Telephone, refer to Portable phone [152](#)
Telephone, refer to separate Owner's Manual "Telephone list" [45](#)
TeleService [160](#)
– enabling [160](#)
– services offered [161](#)

- Temperature display
 - ice warning [64](#)
 - outside temperature [64](#)
 - setting the units [68](#)
 - "Terminate services" [163](#)
 - "Text language" [76](#)
 - "Theater" tone settings [136](#)
 - Thigh support [40](#)
 - Third brake lamp, refer to
 - Center brake lamp [190](#)
 - Tilt alarm sensor [35](#)
 - Tilt function, passenger-side mirror [44](#)
 - "Time" [72](#)
 - "Time format" [72](#)
 - Tire inflation pressures [170](#)
 - Tire pressure
 - loss [81](#)
 - Tire pressure monitoring, refer to Flat Tire Monitor [80](#)
 - Tire puncture, refer to Flat Tire Monitor [81](#)
 - Tire Quality Grading [176](#)
 - Tires
 - age [176](#), [178](#)
 - breaking in [106](#)
 - changing, refer to Changing wheels [191](#)
 - condition [177](#)
 - damage [177](#)
 - inflation pressure [170](#)
 - minimum tread depth [177](#)
 - new tires [178](#)
 - pressure monitoring, refer to Flat Tire Monitor [80](#)
 - puncture [81](#)
 - Run-Flat Tires [178](#)
 - size [176](#)
 - wear indicators, refer to Minimum tread depth [177](#)
 - winter tires [179](#)
 - "Tone" [135](#)
 - Tone in audio mode
 - adjusting [135](#)
 - middle setting [137](#)
 - Tools, refer to Onboard tool kit [187](#)
 - "Top 8" for portable phone [155](#)
 - Torque [200](#)
 - Touch tone dialing [156](#)
 - Tow bar [196](#)
 - Tow fittings [195](#)
 - Tow fittings for tow-starting and towing away [195](#)
 - Towing [195](#)
 - methods [196](#)
 - Towing away
 - car with automatic transmission [195](#)
 - "Town / City" in destination entry [116](#)
 - Tow rope [196](#)
 - Tow-starting [195](#)
 - Tracks
 - random play sequence [147](#)
 - Track width, refer to
 - Dimensions [200](#)
 - Traction-assist feature, refer to DSC [78](#)
 - Traction control, refer to DSC Dynamic Stability Control [78](#)
 - Trailer towing
 - towing loads and gross weight [201](#)
 - Transmission
 - automatic transmission with Steptronic [51](#)
 - manual transmission [51](#)
 - Transporting children safely [46](#)
 - Transport securing device, refer to Securing cargo [109](#)
 - Tread depth, refer to Minimum tire tread [177](#)
 - Treble, tone control [135](#)
 - "Trip computer" [66](#)
 - Trip computer [66](#)
 - Trip-distance counter, refer to Trip odometer [64](#)
 - "Triple turn signal activation" [53](#), [85](#)
 - Trip odometer [64](#)
 - Trunk lid, refer to Luggage compartment lid [32](#)
 - Trunk lights, refer to Luggage compartment lamp [87](#)
 - Turning circle, refer to
 - Dimensions [200](#)
 - Turn signals [53](#)
 - indicator lamp [12](#)
 - replacing bulbs [189](#)
 - Tying down loads, refer to
 - Cargo loading [109](#)
- ## U
- Underbody protection, refer to
 - Caring for your vehicle brochure
 - Uniform Tire Quality Grading/UTQR [176](#)
 - "Units" [68](#)
 - Units
 - average consumption [68](#)
 - temperature [68](#)
 - Universal garage door opener, refer to Integrated universal remote control [93](#)
 - Universal remote control [93](#)
 - "Unlock button" [30](#)
 - Unlocking
 - from inside [32](#)
 - from outside [30](#)
 - "Update services" [163](#)
- ## V
- Vehicle
 - battery [191](#)
 - breaking in [106](#)
 - care, refer to Caring for your vehicle brochure
 - cargo loading [108](#)
 - dimensions [200](#)
 - Identification Number, refer to Engine compartment [181](#)
 - parking [50](#)
 - washing, refer to Caring for your vehicle brochure
 - weight [201](#)
 - Vehicle jack [191](#)
 - Vehicle position, refer to
 - Displaying current position [129](#)
 - "Vehicle settings" [80](#)

Ventilation [92](#)
– draft-free [92](#)
– in the rear [92](#)
Vents, refer to Ventilation [92](#)
"Vent settings" [90](#)
Voice command
– overview [22](#)
Voice input
– short commands [202](#)
Voice instructions for navigation system [127](#)
– muting [45](#)
– repeating [45](#), [128](#)
– switching on/off [127](#)
– volume [128](#)
Voice phone book [158](#)
Volume [134](#)
– audio sources [134](#)
– portable phone [153](#)
– voice instructions [128](#)
Volume control
– speed-dependent adjustment [135](#)
Volume of luggage compartment [201](#)

W

Warning and indicator lamps [13](#)
Warning messages, refer to Check Control [73](#)
Warning triangle [194](#)
Washer fluid [55](#)
– content of the reservoir [55](#)
Washer fluid reservoir [55](#)
Washing the car, refer to Caring for your vehicle brochure
Waste tray, refer to Ashtray [98](#)
Water on roads, refer to Driving through water [107](#)
Waveband [138](#)
"WB" [134](#), [141](#)
Wear indicators in tires, refer to Minimum tread depth [177](#)
Weights [201](#)
Wheelbase, refer to Dimensions [200](#)

Wheels, new [178](#)
Wheels and tires [170](#)
Width, refer to Dimensions [200](#)
Windows [35](#)
– anti-trapping mechanism [35](#)
– convenience operation [30](#)
– opening, closing [35](#)
– safety switch [36](#)
Windshield
– cleaning [54](#)
– defrosting and removing condensation [91](#)
Windshield defrosting, refer to Defrosting windows [91](#)
Windshield washer fluid reservoir, refer to Washer fluid [55](#)
Windshield washer system [54](#)
– washer fluid [55](#)
– washer nozzles [54](#)
Windshield wiper blades, changing [187](#)
Windshield wipers, refer to Wiper system [54](#)
Winter tires [179](#)
– setting speed limit [75](#)
– storage [179](#)
Wiper blade replacement [187](#)
Wiper system [54](#)
"With highways" for navigation [123](#)
Word-matching principle for navigation [124](#)
Wrench/screwdriver, refer to Onboard tool kit [187](#)

X

Xenon lamps
– replacing bulbs [187](#)

Refueling

So that you always have access to the data you need when refueling, you are recommended to enter the relevant figures for your car in the table provided below. Consult the index for individual specifications.

Fuel

Designation

Please enter your preferred fuel here.

Engine oil

Quality

Do not add engine oil until the corresponding warning lamp in the instrument cluster lights up, refer to page [183](#).

Tire inflation pressures

	Summer tires Front	Rear	Winter tires Front	Rear
Up to 4 persons				
5 persons or 4 plus luggage				

More about BMW



bmwusa.com

The Ultimate
Driving Machine

01 41 0 159 259 ue iDrive

